

SIEMENS

SIMATIC

Configuring Hardware and Communication Connections STEP 7

Manual

This manual is part of the documentation
package with the order number:
6ES7810-4CA08-8BW0

Edition 03/2006
A5E00706939-01

Preface	
Contents	
Basics of Configuring Hardware with STEP 7	1
Configuring Central Racks	2
Configuring the Distributed I/O (DP)	3
Configuring PROFINET IO Devices	4
Configuring IRT Communication	5
Configuring a SIMATIC PC Station (SIMATIC PC based)	6
Saving, Importing and Exporting Configurations	7
Synchronous Operation of Multiple CPUs (Multicomputing)	8
Modifying the System during Operation (CiR)	9
Configuring H-Systems	10
Networking Stations	11
Configuring Connections	12
Configuring Global Data Communication	13
Downloading	14
Multi-User Editing Projects	15
Working With Projects in the Multiproject	16
Commissioning and Service	17
Index	

Safety Guidelines

This manual contains notices you have to observe in order to ensure your personal safety, as well as to prevent damage to property. The notices referring to your personal safety are highlighted in the manual by a safety alert symbol, notices referring to property damage only have no safety alert symbol. The notices shown below are graded according to the degree of danger.



Danger

indicates that death or severe personal injury **will** result if proper precautions are not taken.



Warning

indicates that death or severe personal injury **may** result if proper precautions are not taken.



Caution

with a safety alert symbol indicates that minor personal injury can result if proper precautions are not taken.

Caution

without a safety alert symbol indicates that property damage can result if proper precautions are not taken.

Attention

indicates that an unintended result or situation can occur if the corresponding notice is not taken into account.

If more than one degree of danger is present, the warning notice representing the highest degree of danger will be used. A notice warning of injury to persons with a safety alert symbol may also include a warning relating to property damage.

Qualified Personnel

The device/system may only be set up and used in conjunction with this documentation. Commissioning and operation of a device/system may only be performed by **qualified personnel**. Within the context of the safety notices in this documentation qualified persons are defined as persons who are authorized to commission, ground and label devices, systems and circuits in accordance with established safety practices and standards.

Prescribed Usage

Note the following:



Warning

This device and its components may only be used for the applications described in the catalog or the technical description, and only in connection with devices or components from other manufacturers which have been approved or recommended by Siemens.

Correct, reliable operation of the product requires proper transport, storage, positioning and assembly as well as careful operation and maintenance.

Trademarks

All names identified by ® are registered trademarks of the Siemens AG.

The remaining trademarks in this publication may be trademarks whose use by third parties for their own purposes could violate the rights of the owner.

Disclaimer of Liability

We have reviewed the contents of this publication to ensure consistency with the hardware and software described. Since variance cannot be precluded entirely, we cannot guarantee full consistency. However, the information in this publication is reviewed regularly and any necessary corrections are included in subsequent editions

Preface

Purpose

This manual provides a complete overview of the procedures involved in configuring hardware and communication connections with the STEP 7 software. It is designed to support you when depicting the hardware configuration in the form of a STEP 7 project and describes how to establish data exchange between automation systems.

The manual is intended for people who are involved in carrying out control tasks using STEP 7 and SIMATIC S7 automation systems.

We recommend that you familiarize yourself with the examples in the manual "Working with STEP 7 V5.4, Getting Started." These examples provide an easy introduction to the topic "Programming with STEP 7."

Basic Knowledge Required

In order to understand this manual, general knowledge of automation technology is required.

In addition, you must be familiar with using computers or PC-similar tools (for example, programming devices) with the MS Windows 2000 Professional, MS Windows XP Professional or MS Windows Server 2003 operating system.

Scope of the Manual

This manual is valid for release 5.4 of the STEP 7 programming software package.

You can find the latest information on the service packs:

- in the "readme.wri" file
- in the updated STEP 7 online help.

The topic "What's new?" in the online help offers an excellent introduction and overview of the newest STEP 7 innovations.

STEP 7 Documentation Packages

This manual is part of the documentation package "STEP 7 Basic Information."

The following table displays an overview of the STEP 7 documentation:

Documentation	Purpose	Order Number
STEP 7 Basic Information with <ul style="list-style-type: none"> • Working with STEP 7, Getting Started Manual • Programming with STEP 7 • Configuring Hardware and Communication Connections, STEP 7 • From S5 to S7, Converter Manual 	Basic information for technical personnel describing the methods of implementing control tasks with STEP 7 and the S7-300/400 programmable controllers.	6ES7810-4CA08-8BW0
STEP 7 Reference with <ul style="list-style-type: none"> • Ladder Logic (LAD)/Function Block Diagram (FBD)/Statement List (STL) for S7-300/400 manuals • Standard and System Functions for S7-300/400 Volume 1 and Volume 2 	Provides reference information and describes the programming languages LAD, FBD, and STL, and standard and system functions extending the scope of the STEP 7 basic information.	6ES7810-4CA08-8BW1

Online Helps	Purpose	Order Number
Help on STEP 7	Basic information on programming and configuring hardware with STEP 7 in the form of an online help.	Part of the STEP 7 Standard software.
Reference helps on STL/LAD/FBD Reference help on SFBs/SFCs Reference help on Organization Blocks	Context-sensitive reference information.	Part of the STEP 7 Standard software.

Online Help

The manual is complemented by an online help which is integrated in the software. This online help is intended to provide you with detailed support when using the software.

The help system is integrated in the software via a number of interfaces:

- There are several menu commands which you can select in the **Help** menu: The **Contents** command opens the index for the Help on STEP 7.
- **Using Help** provides detailed instructions on using the online help.
- The context-sensitive help offers information on the current context, for example, an open dialog box or an active window. You can open the context-sensitive help by clicking the "Help" button or by pressing F1.
- The status bar offers another form of context-sensitive help. It displays a short explanation for each menu command when the mouse pointer is positioned on the menu command.
- A brief explanation is also displayed for each icon in the toolbar when the mouse pointer is positioned on the icon for a short time.

If you prefer to read the information from the online help in printed format, you can print out individual help topics, books, or the entire online help.

This manual, as well as the manuals "Programming with STEP 7", "Modifying the System During Operation via CiR" and "Automation System S7-400H - Fault-Tolerant Systems" is an extract from the HTML-based Help on STEP 7. For detailed procedures please refer to the STEP 7 help. As the manuals and the online help share an almost identical structure, it is easy to switch between the manuals and the online help.

You can find the electronic manuals after installing STEP 7 via the Windows Start menu: **Start > SIMATIC > Documentation.**

Further Support

If you have any technical questions, please get in touch with your Siemens representative or responsible agent.

You will find your contact person at:

<http://www.siemens.com/automation/partner>

You will find a guide to the technical documentation offered for the individual SIMATIC Products and Systems here at:

<http://www.siemens.com/simatic-tech-doku-portal>

The online catalog and order system is found under:

<http://mall.automation.siemens.com/>

Training Centers

Siemens offers a number of training courses to familiarize you with the SIMATIC S7 automation system. Please contact your regional training center or our central training center in D 90327 Nuremberg, Germany for details:

Telephone: +49 (911) 895-3200.

Internet: <http://www.sitrain.com>

Technical Support

You can reach the Technical Support for all A&D products

- Via the Web formula for the Support Request
<http://www.siemens.com/automation/support-request>
- Phone: + 49 180 5050 222
- Fax: + 49 180 5050 223

Additional information about our Technical Support can be found on the Internet pages <http://www.siemens.com/automation/service>

Service & Support on the Internet

In addition to our documentation, we offer our Know-how online on the internet at:

<http://www.siemens.com/automation/service&support>

where you will find the following:

- The newsletter, which constantly provides you with up-to-date information on your products.
- The right documents via our Search function in Service & Support.
- A forum, where users and experts from all over the world exchange their experiences.
- Your local representative for Automation & Drives.
- Information on field service, repairs, spare parts and more under "Services".

Contents

1	Basics of Configuring Hardware with STEP 7.....	1-1
1.1	Introduction to Configuring Hardware.....	1-1
1.2	Basic Procedure for Configuring Hardware.....	1-3
1.2.1	Basic Steps for Configuring a Station.....	1-3
1.2.2	Layout of the Station Window.....	1-4
1.2.3	Configuration Table as a Representation of a Rack.....	1-5
1.2.4	Setting the Properties of Components	1-6
1.2.5	Opening Objects in HW-Konfig.....	1-7
1.2.6	What You Should Know About Slot Rules and Other Rules	1-7
1.3	Overview: Procedure for Configuring and Assigning Parameters to a Local Configuration.....	1-8
1.4	Working with the Hardware Catalog.....	1-9
1.4.1	Customizing the Hardware Catalog.....	1-9
1.4.2	Searching in the Hardware Catalog	1-10
1.5	Tips for Editing Station Configurations	1-11
1.5.1	Exchanging and Moving Modules	1-13
1.5.2	Exchanging Racks, C7 Devices, and DP Slaves	1-14
1.5.3	Displaying Information on Components in the Hardware Catalog	1-17
1.5.4	Installing Hardware Updates	1-18
2	Configuring Central Racks.....	2-1
2.1	Rules for Arranging Modules (SIMATIC 300).....	2-1
2.1.1	Special Rules for the Dummy Module (DM 370 Dummy)	2-2
2.1.2	Special Rules for the Digital Simulation Module (SIM 374 IN/OUT 16)	2-2
2.1.3	Special Rules for M7-300	2-3
2.2	Rules for Arranging Modules (SIMATIC-400).....	2-4
2.2.1	Rules for Arranging Modules (SIMATIC-400).....	2-4
2.2.2	Special Rules for Power Supply Modules with Redundant Capability (S7-400)	2-5
2.2.3	Special Rules for M7-400	2-5
2.2.4	Special Rules for PROFIBUS-DP Interface Submodules (M7-400).....	2-6
2.3	How to Configure Central Racks	2-7
2.3.1	Creating a Station.....	2-7
2.3.2	Starting the Application to Configure the Hardware	2-7
2.3.3	Arranging the Central Rack.....	2-8
2.3.4	Arranging Modules in a Rack	2-8
2.3.5	Displaying the Version of the CPU Operating System in the 'Hardware Catalog' window	2-9
2.3.6	Arranging C7 Control Systems (Special Features)	2-10
2.3.7	Assigning Properties to Modules/Interfaces	2-11
2.3.8	Assigning Addresses	2-12
2.3.9	Assigning I/O Addresses	2-13
2.3.10	Assigning Symbols to I/O Addresses	2-14
2.3.11	Monitoring Inputs and Modifying Outputs When Configuring Hardware ...	2-14
2.3.12	Configuring Point-to-Point CPs.....	2-17
2.3.13	Configuring S5 Modules	2-18

2.4	Expanding the Central Rack with Expansion Racks	2-19
2.4.1	Rules for Connecting Expansion Racks (SIMATIC 400).....	2-20
2.4.2	Arranging the Expansion Rack (SIMATIC 400).....	2-20
2.4.3	Special Case: When the Central Rack Has More Than One CPU.....	2-20
3	Configuring the Distributed I/O (DP)	3-1
3.1	Basic Procedure for Configuring a DP Master System	3-1
3.2	Where Are the DP Slaves in the Hardware Catalog Window?.....	3-4
3.3	Distributed Reading and Writing of Consistent Data (> 4 Bytes)	3-5
3.4	Configurations for PROFIBUS-DP	3-6
3.4.1	Configuration with 'Simple' (Modular or Compact) DP Slaves (Data Exchange: Slave <> Master)	3-6
3.4.2	Configuration with Intelligent DP Slaves (Data Exchange: I Slave <> Master)	3-7
3.4.3	Configuration with Intelligent DP Slaves (Direct Data Exchange: Slave > I Slave)	3-8
3.4.4	Configuration with Two DP Master Systems (Direct Data Exchange: Slave > I Slave)	3-9
3.4.5	Configuration with Two DP Master Systems (Direct Data Exchange: Slave > Master)	3-10
3.5	How to Configure Distributed I/O Systems	3-11
3.5.1	Creating a DP Master System	3-11
3.5.2	Handling DP Master Systems and DP Interfaces.....	3-12
3.5.3	Selecting and Arranging DP Slaves	3-13
3.5.4	Copying Multiple DP Slaves	3-13
3.5.5	Configuring Compact DP Slaves	3-14
3.5.6	Configuring Modular DP Slaves	3-14
3.5.7	Assigning DP Slaves to SYNC or FREEZE Groups.....	3-15
3.6	Other DP Slave Configurations	3-17
3.6.1	ET 200L and DP/AS-i Link.....	3-17
3.6.2	ET 200S	3-17
3.6.3	ET 200S with Option Handling	3-20
3.6.4	ET 200S in DPV1 Mode	3-22
3.6.5	ET 200iS	3-23
3.6.6	PROFIBUS PA.....	3-25
3.6.7	HART Modules	3-26
3.6.8	Configuring Software Redundancy.....	3-26
3.7	Intelligent DP Slaves	3-30
3.7.1	Configuring Intelligent DP Slaves.....	3-30
3.7.2	Example of Configuring an S7-400 as I-Slave	3-35
3.7.3	Creating an Alarm in the I Slave with SFB75 'SALRM'	3-42
3.8	Direct Data Exchange (Lateral Communication).....	3-45
3.8.1	Configuring Direct Data Exchange between PROFIBUS-DP Nodes	3-45
3.8.2	Example of Configuring Direct Data Exchange	3-47
3.8.3	Configuring a DP-Slave (GSD Rev. 5) as a Receiver for Direct Data Exchange.....	3-50
3.9	Working with *.GSD Files	3-53
3.9.1	Installing a *.GSD File	3-53
3.9.2	What You Should Know About GSD Revisions.....	3-55
3.9.3	What You Should Know about GSD Files for PROFINET IO Devices.....	3-57
3.10	DPV1	3-58
3.10.1	What You Should Know About PROFIBUS DPV1	3-58
3.10.2	Configuring DPV1 Devices	3-59
3.10.3	Programming DPV1 Devices.....	3-61
3.10.4	The Slot Model of DPV1 Slaves with I-Slaves.....	3-65

3.11	Diagnostic Repeater	3-71
3.11.1	Configuring and Commissioning the Diagnostic Repeater.....	3-71
3.11.2	Displaying the Topology With the Help of Diagnostic Repeaters.....	3-74
3.11.3	Working With the Topology View	3-76
3.12	Setting Constant Bus Cycle Times for PROFIBUS Subnets.....	3-79
3.12.1	Configuring Short and Equal-Length Process Reaction Times on PROFIBUS DP	3-83
3.12.2	Assigning Parameters for Constant Bus Cycle Time and Isochrone Mode in HW Config	3-88
3.12.3	Connecting a PG/PC to a Constant-Cycle PROFIBUS network via Industrial Ethernet and an IE/PB Link.....	3-92
3.12.4	Shortening the Process Reaction Time by Overlapping Ti and To	3-93
4	Configuring PROFINET IO Devices	4-1
4.1	What You Should Know about PROFINET IO	4-1
4.1.1	What is PROFINET IO?.....	4-1
4.1.2	PROFIBUS DP and PROFINET IO: Similarities and Differences	4-2
4.1.3	Assigning Addresses and Names for PROFINET IO Devices	4-4
4.1.4	Integrating Existing PROFIBUS DP Configurations	4-6
4.1.5	Update Times For Cyclical Data Exchange.....	4-8
4.1.6	Setting a Specific Update Time for an IO-Device.....	4-10
4.2	Steps For Configuring a PROFINET IO System.....	4-11
4.2.1	Overview: From Configuration To Cyclical Data Exchange	4-11
4.2.2	Basic Procedure for Configuring a PROFINET IO System	4-13
4.2.3	Creating a PROFINET IO System.....	4-15
4.2.4	Selecting and Arranging IO Devices	4-16
4.2.5	Where Are The IO Devices Located In The Hardware Catalog?	4-17
4.2.6	Handling PROFINET IO Systems	4-18
4.3	Examples of Configurations with PROFINET IO	4-19
4.3.1	Configuration with an Integrated IO Controller	4-19
4.3.2	Configuration with an External IO Controller	4-20
4.3.3	Configuration with IE/PB Link.....	4-21
4.3.4	Configuration with SIMATIC PC Stations	4-22
4.4	Placing PROFINET IO Devices in Operation	4-24
4.4.1	Accessing PROFINET IO Devices Online via Ethernet	4-24
4.4.2	Displaying Ethernet Nodes in the "Accessible Nodes" Window.....	4-25
4.4.3	Downloading to PROFINET IO Devices.....	4-27
4.4.4	Assigning Device Names via a Memory Card (MMC).....	4-29
4.4.5	Changing the IP-Address or the Device Name During Operation.....	4-30
4.4.6	Diagnosing PROFINET IO Devices.....	4-31
4.4.7	Configuring the Watchdog Time	4-32
5	Configuring IRT Communication.....	5-1
5.1	Introduction: Isochronous Realtime Ethernet	5-1
5.2	Overview: Basic Procedure For Configuring IRT	5-3
5.3	Creating a PROFINET IO Configuration	5-3
5.4	Creating a Sync Domain.....	5-4
5.5	Setting Update Times	5-5
5.6	Configuring the Topology	5-6
5.7	Configuring Direct Data Exchange	5-7
5.8	Downloading an IRT Configuration	5-8
5.9	Media Redundancy.....	5-9
5.9.1	What You Should Know a About Media Redundancy.....	5-9
5.9.2	Configuring Media Redundancy	5-12

6	Configuring a SIMATIC PC Station (SIMATIC PC based)	6-1
6.1	Creating and Assigning Parameters to SIMATIC PC Stations.....	6-1
6.2	Slot Rules for a SIMATIC PC Station.....	6-4
6.3	Comparison: S7 Station - PC Station.....	6-4
6.4	Appending SIMATIC PC Configurations of Previous Versions.....	6-5
6.5	Highlighting the SIMATIC PC Station to be Configured in the Network View.....	6-7
7	Saving, Importing and Exporting Configurations	7-1
7.1	Saving a Configuration and Checking the Consistency.....	7-1
7.2	Importing and Exporting a Configuration.....	7-2
7.3	Exporting and Importing CAx Data.....	7-5
8	Synchronous Operation of Multiple CPUs (Multicomputing)	8-1
8.1	What You Should Know About Multicomputing.....	8-1
8.1.1	Special Features of Multicomputing.....	8-3
8.1.2	When to Use Multicomputing.....	8-4
8.2	Configuring Multicomputing Operation.....	8-5
8.2.1	Configuring Modules for Multicomputing Operation.....	8-6
8.2.2	Displaying the CPU Assignment.....	8-6
8.2.3	Changing the CPU Number.....	8-7
8.3	Programming CPUs.....	8-8
9	Modifying the System during Operation (CiR)	9-1
10	Configuring H-Systems	10-1
11	Networking Stations	11-1
11.1	Networking Stations within a Project.....	11-1
11.2	Properties of Subnets and Communication Nodes.....	11-2
11.3	Rules for Network Configuration.....	11-3
11.4	Ethernet Address Assignment.....	11-4
11.5	Importing and Exporting Stations in the Network View.....	11-7
11.6	How to Configure and Save a Subnet.....	11-10
11.6.1	Procedure for Configuring a Subnet.....	11-10
11.6.2	Creating and Assigning Parameters to a New Subnet.....	11-14
11.6.3	Creating and Assigning Parameters to a New Station.....	11-15
11.6.4	Creating and Assigning Parameters to a Network Connection.....	11-16
11.6.5	Creating and Assigning Parameters to a New DP Slave.....	11-18
11.6.6	Creating and Assigning Parameters to Programming Devices/PCs, 'Other' Stations, and S5 Stations.....	11-19
11.6.7	Taking Connections for Programming Devices/PCs into Account in the Network Configuration.....	11-21
11.6.8	Checking the Consistency of the Network.....	11-24
11.6.9	Saving the Network Configuration.....	11-26
11.6.10	Tips for Editing the Network Configuration.....	11-27
11.7	Networking Stations that Represent Network Gateways.....	11-30
11.7.1	Networking Stations that Represent Network Gateways.....	11-30
11.7.2	Programming Devices / PCs Connected to a Subnet via TeleService or WAN.....	11-33
11.8	Networking Stations from Different Projects.....	11-35

12	Configuring Connections	12-1
12.1	Introduction to Configuring Connections	12-1
12.2	Configuring Communication with an Ethernet CP	12-2
12.3	Configuring Communication with a PROFIBUS CP	12-3
12.4	What You Should Know About the Different Connection Types	12-4
12.5	What You Should Know About Assigning Connection Resources.....	12-8
12.6	Using Connection Resources with Fault-Tolerant S7 Connections	12-13
12.7	Blocks for Different Connection Types	12-18
12.8	Working with the Connection Table.....	12-20
12.9	Inconsistent Connections	12-22
12.10	Displaying the Connection Status	12-23
12.11	Access to Connection IDs during Programming.....	12-25
12.12	Configuring Connections to Partners in the Same Project.....	12-26
12.12.1	Connection Types for Connection Partners in the Same Project.....	12-26
12.12.2	Rules for Creating Connections.....	12-28
12.12.3	Configuring Connections for Modules in a SIMATIC Station	12-28
12.12.3.1	Inserting a New Connection	12-29
12.12.3.2	Changing the Connection Partner	12-30
12.12.3.3	Reserving a Connection	12-31
12.12.3.4	Deleting One or More Connections	12-32
12.12.3.5	Copying Connections	12-32
12.12.4	Configuring Connections for a SIMATIC PC Station	12-33
12.12.4.1	Configuring Routed S7 Connections for a SIMATIC PC Station.....	12-34
12.12.5	Programming Devices / PCs as Connection Partners	12-36
12.12.5.1	S7 Connection to a PG/PC.....	12-36
12.12.5.2	S7 Connection to a PG/PC with WinCC.....	12-37
12.13	Configuring Connections to Partners in Other Projects	12-38
12.13.1	Connection Types for Partners in Other Projects.....	12-38
12.13.2	Basic Procedure for Configuring Connections between Projects.....	12-40
12.13.3	Creating a New Connection to an Unspecified Partner.....	12-41
12.13.4	Creating a Connection to an 'Other Station', a 'PG/PC', or a 'SIMATIC S5 Station'	12-43
12.14	Saving Connections.....	12-43
13	Configuring Global Data Communication	13-1
13.1	Overview: Global Data Communication	13-1
13.2	Determining the Communication Capabilities from the GD Resources	13-3
13.2.1	Required Number of GD Packets	13-4
13.2.2	Required Number of GD Circles.....	13-5
13.2.3	Exceptions for Calculating the GD Circles Required.....	13-8
13.3	Conditions for Sending and Receiving	13-9
13.3.1	Relationship between the Scan Rate and Scan Cycle Time.....	13-10
13.4	Response Time	13-11
13.5	How to Configure and Save Global Data Communication	13-12
13.5.1	Procedure for Configuring Global Data Communication	13-12
13.5.2	Opening the GD Table.....	13-13
13.5.3	Tips for Working with GD Tables.....	13-14
13.5.4	Filling Out the GD Table	13-15
13.5.5	Saving and Compiling the GD Table for the First Time.....	13-17
13.5.6	Entering Scan Rates.....	13-18
13.5.7	Entering Status Rows	13-19
13.5.8	Compiling the GD Table for a Second Time.....	13-20
13.6	Global Data Transmission Using System Functions	13-21

14	Downloading.....	14-1
14.1	Downloading a Configuration to a Programmable Controller.....	14-1
14.2	Downloading the Network Configuration for the First Time.....	14-3
14.3	Downloading the Network Configuration to a Programmable Controller ..	14-5
14.4	Downloading to a PC Station.....	14-6
14.5	Downloading Changes to the Network Configuration	14-7
14.6	Downloading a Changed HW Configuration to an S7-400H Station	14-9
14.7	Downloading the Global Data Configuration	14-10
14.8	Uploading a Configuration from a Station	14-11
14.9	Uploading a Network Configuration.....	14-12
15	Multi-User Editing Projects	15-1
15.1	Multi-User Configuration in a Network.....	15-1
15.1.1	Setting the Workstation Configuration.....	15-3
15.2	Single Terminal Configuration on Non-Networked Workstations	15-4
15.2.1	Merging Several S7 Programs into One.....	15-4
15.2.2	Copying S7 Programs with Message Attributes	15-4
16	Working With Projects in the Multiproject.....	16-1
16.1	What You Should Know About Multiprojects.....	16-1
16.2	Multiproject - Requirements and Recommendations	16-4
16.3	Handling Multiprojects	16-7
16.4	Online Access to PLCs in a Multiproject	16-12
16.5	Creating Cross-Project Subnets	16-14
16.6	Display Of Merged Subnets In The Network View	16-17
16.7	Multiproject-Oriented Network View	16-18
16.8	Configuring Cross-Project Connections	16-20
16.9	Options for Merging Cross-Project Connections	16-24
16.10	S7 Connections to Unspecified Connection Partners	16-24
16.11	Adjusting Projects in the Multiproject	16-24
16.12	Archiving and Retrieving Multiprojects	16-25
17	Commissioning and Service	17-1
17.1	Commissioning PROFIBUS Nodes	17-1
17.2	Identification and Maintenance (I&M).....	17-4
17.3	Changing M-Data in the SIMATIC Manager.....	17-5
17.4	Entering or Changing M-Data in HW Config	17-6
Index	Index-1	

1 Basics of Configuring Hardware with STEP 7

1.1 Introduction to Configuring Hardware

Configuring

The term "configuring" refers to the arranging of racks, modules, distributed I/O (DP) racks, and interface submodules in a station window. Racks are represented by a configuration table that permits a specific number of modules to be inserted, just like a real rack.

In the configuration table, STEP 7 automatically assigns an address to each module. You can change the addresses of the modules in a station if the CPU in the station can be addressed freely (meaning an address can be assigned freely to every channel of the module, independent of its slot).

You can copy your configuration as often as you like to other STEP 7 projects, modify it as necessary, and download it to one or more existing plants. When the programmable controller starts up, the CPU compares the preset configuration created in STEP 7 with the actual configuration of the plant. Any errors are therefore recognized immediately and reported.

Assigning Parameters

The term "assigning parameters" refers to the following:

- Setting properties for programmable modules in a local configuration and in a network. For example: a CPU is a programmable module. Its watchdog time is a parameter you can set.
- Setting bus parameters, master and slave parameters for a master system (PROFIBUS) or making other settings for exchanging data between components.

The parameters are downloaded to the CPU and transferred during startup by the CPU to the respective modules. Modules can easily be replaced because the parameters set with STEP 7 are automatically downloaded to the new module during startup.

When Should You "Configure Hardware"?

The properties of the S7 programmable controllers and modules are preset with default values such that in many cases you do not need to configure them.

Configuration is necessary in the following cases:

- If you want to change the default parameters of a module (for example, enable a hardware interrupt for a module)
- If you want to configure communication connections
- For stations with a distributed I/O (PROFIBUS DP or PROFINET IO)
- For S7-400 stations with a number of CPUs (multicomputing) or expansion racks
- For fault-tolerant (H) programmable control systems

1.2 Basic Procedure for Configuring Hardware

Window for Configuring

Configuring a programmable controller involves the use of two windows:

- The station window in which you place the racks for the station structure
- The "Hardware Catalog" window from which you select the required hardware components, for example, racks, modules, and interface submodules

Displaying the Hardware Catalog

If the "Hardware Catalog" window is not displayed, select the menu command **View > Catalog**. This command toggles the display of the Hardware Catalog on and off.

1.2.1 Basic Steps for Configuring a Station

Independent of which structure a station has - you always configure using the following steps:

1. Select a hardware component in the "Hardware Catalog" window.
2. Copy the selected component to the station window using drag & drop.

The following figure shows the basic operation:

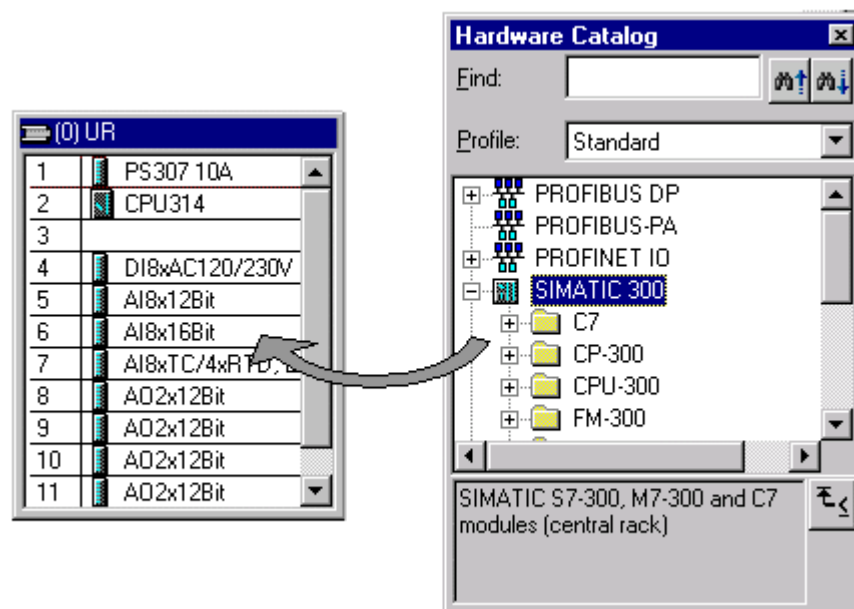

1.2.2 Layout of the Station Window

The lower part of the station window shows a detailed view of the inserted/selected rack. The order numbers and addresses of the modules are shown here in table form.

The table has the structure shown below for a central rack equipped with modules (detailed view):

Slot	Module	Order number	Firmware	MPI address	I addr...	Q addr...	Comment
1	PS 307 10A	6ES7 307-1KA00-0AA0					
2	CPU 314	6ES7 314-1AE01-0AB0		2			
3							
4	DI8xAC120/230V	6ES7 321-1FF10-0AA0			0		
5	AI8x12Bit	6ES7 331-7KF02-0AB0			272...287		
6	AI8x16Bit	6ES7 331-7NF10-0AB0			288...303		
7	AI8xTC/4xRTD, Ex	6ES7 331-7SF00-0AB0			304...319		
8	AO2x12Bit	6ES7 332-5HB00-0AB0				320...323	
9	AO2x12Bit	6ES7 332-5HB81-0AB0				336...339	
10							
11							

1.2.3 Configuration Table as a Representation of a Rack

For a local configuration you arrange the modules beside the CPU in a rack and continue into additional expansion racks. The number of racks which can be configured depends on the CPU you used.

Just as you do in a real plant, you arrange your modules in racks with STEP 7. The difference is that in STEP 7 racks are represented by "configuration tables" that have as many rows as the rack has slots for modules.

The following figure shows an example of how a real structure is converted into a configuration table. The configuration table corresponds to the rack used; STEP 7 automatically places the number of the rack in brackets in front of the name.

Example: (0) UR corresponds to the central rack (Universal Rack) number 0.

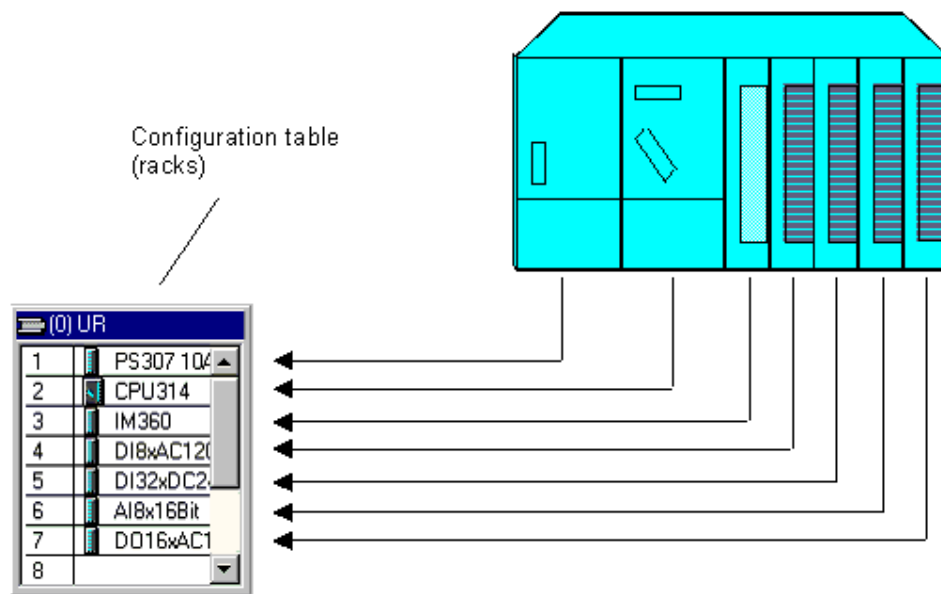

1.2.4 Setting the Properties of Components

Once you have arranged your components in the station window, you always arrive in the following manner in a dialog box for changing the default properties (parameters or addresses):

- Double-click the component or select the menu command **Edit > Object Properties**.
- Right mouse button: Move the cursor on the component, press the right mouse button and select the command **Object Properties** from the pop-up menu.

Properties of CPUs

The properties of the CPUs have a special significance for the behavior of the system. In the dialog boxes for a CPU, you can set the following, for example: startup characteristics, local data areas and priorities for interrupts, memory areas, retentive behavior, clock memory, protection level, and password - to name only a few. STEP 7 "knows" what can be set and within what range limits.

In the "General" tab of the CPU or via the properties of the CPU interface you can assign parameters to the interfaces (for example, MPI or integrated PROFIBUS-DP interfaces). Via these dialog boxes you can also access the properties dialog box for the corresponding subnet to which the CPU is to be connected.

Other Ways of Assigning Parameters

For S7-300 and S7-400 programmable controllers you can set the parameters for some modules in the user program (for example, for analog modules). You need to call the system functions (SFCs) WR_PARM, WR_DPARM, and PARM_MOD in the user program to do this. These settings are lost following a warm restart.

You will find more detailed information about system functions in the *System Software for S7-300 and S7-400, System and Standard Functions Reference Manual*

For M7-300 and M7-400 programmable control systems you can set the parameters for signal modules in the C program. You need to call the M7 API function "M7StoreRecord" in the C program to do this. This function transfers the parameters to a signal module.

You will find more information about the M7 API functions in the manuals on the system software for M7-300 and M7-400.

1.2.5 Opening Objects in HW Config

In STEP 7, you can open objects in order to edit them.

To do this, go to the SIMATIC Manager and select an object (such as "Hardware"). Now select the **Edit > Open Object** menu command to start HW Config, where you can edit the station configuration.

You can also start HW Config by simply double-clicking the object.

Special Feature of HW Config

If you want to edit an object in HW Config, the double-clicking it produces the same result as selecting the **Edit > Object Properties** menu command. In general, this is the place to assign addresses, set parameters or enter other information. If there is an application available to edit the object, then a button for starting this application is located in the property sheet for the object.

As of STEP 7 V5.4, you now have available the **Edit > Open Object With** menu command. You can use this menu command to open an application to edit the object as required. This menu command is only available if such an application is necessary and available for use.

1.2.6 What You Should Know About Slot Rules and Other Rules

STEP 7 offers you support with configuring a station so that a message is generally displayed immediately if, for example, a module cannot be inserted in the slot you want to insert it in.

As of STEP 7 V5.2 you can identify available module slots at a glance, provided you have your monitor display set for more than 256 colors. When you select a module in the Hardware Catalog and this module can be inserted in a configured module rack, all slots available for the insertion of this module are highlighted in color. This feature increases configuring efficiency.

Furthermore, because address ranges are checked automatically, double address assignments cannot occur.

In this connection, please pay attention to the status bar at the lower edge of the window and to any displayed messages that provide details on the causes and effects of an operation. You can also use the online help to obtain additional information for the messages.

Other additional, temporary rules (for a specific release), such as restrictions to the slots you can use owing to a functional restriction to individual modules, are not taken into account. Consequently, always consult the documentation or the current Product Information for the modules.

1.3 Overview: Procedure for Configuring and Assigning Parameters to a Local Configuration

Requirement

You must have opened a project or created a new project in the SIMATIC Manager.

Basic Procedure

To configure and assign parameters to a structure, proceed as shown below:

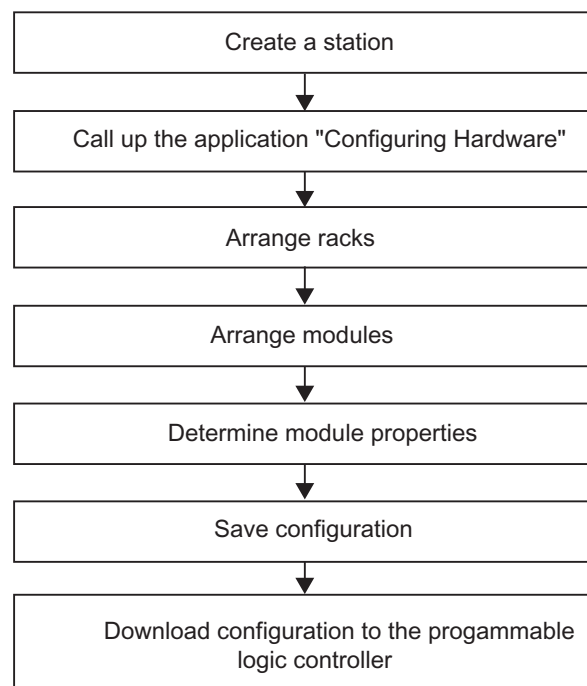

Summary

As usual in Windows applications, you can put together the whole configuration in STEP 7 using drag and drop. You will find detailed information on handling and setting up your real plant configuration, for example, how you configure the connection to expansion racks or how you configure special components in the STEP 7 online help.

1.4 Working with the Hardware Catalog

1.4.1 Customizing the Hardware Catalog

In addition to the standard Hardware Catalog supplied with STEP 7, you can tailor your "own" catalog. This can result in a number of different catalog profiles. The basis for each new catalog profile is the standard Hardware Catalog with all modules/components - the profile for this catalog is called "Standard"; you can assign your own names for the catalog profiles you create yourself.

Example: You can create a catalog profile that contains only the modules you are currently using.

From STEP 7 V5.0, Service Pack 3 onwards, the following catalog profiles are available in addition to the "Standard" profile:

- Current modules, (for example, November 1999 or July 2000 version)
In this profile, no "old" modules are available (only current order numbers)
- SIMATIC Outdoor (for example, November 1999 or July 2000 version)
This profile offers only current modules which can be used in extended environmental conditions (higher mechanical stress and extended climatic conditions are permitted)

Note

The additional profiles available for selection are for modules that are available in the hardware catalog of the STEP 7 standard package. Modules that are installed by means of optional packages, GSD files or hardware updates are only available in the 'Standard' catalog profile!

Procedure

1. Select the menu command **Options > Edit Catalog Profiles**.
In the application that opens, two catalog profiles are displayed: the "Standard" profile and an "empty" profile that does not contain any components as yet.
2. Drag the required folders and modules from the standard profile window and drop them in the empty profile window. You can also adapt the structure to your own requirements using the menu command **Insert > Folder**.
3. Save the new catalog profile using the menu command **File > Save As**; choose a suitable name for the new profile.
The name of the new profile then appears in the "Profile" list box in the Hardware Catalog and can be selected.

GSD Files only update "Standard" Profile

DP slaves that have been installed later via GSD files are only added to the "Standard" profile's Other Field Devices folder and are not included in the catalog profiles you created yourself.

1.4.2 Searching in the Hardware Catalog

If you know the order number for a component or the name of a function that is displayed in the info text in the Hardware Catalog, then you can search for this component.

The upper section of the Hardware Catalog contains a "Search" box.

Procedure

1. Select and entry in the Hardware Catalog
2. Enter a search term, such as the first part of the order number **6ES7 331**.
3. To start searching, click on "Search down" or "Search up", as appropriate.



Search down



Search up

STEP 7 locates the first occurrence of the search term. If the component you are looking for is in another folder that is not open or outside of the visible area, then the folder is automatically opened and moved in to the visible area.

STEP 7 saves the search term that you entered. You can then easily select it again from the drop-down list in the search tool.

What Can Be Entered in the Search Box

You can enter any test, infotext, catalog entry or order number in the search box.

The search is not case sensitive.

Wildcards (*, ?,...) are **not** supported.

You can also enter parts of a larger/complete search term (e.g. **331**).

Spaces, tabs or hyphens must be entered as they are shown in the Hardware Catalog; otherwise, the item being searched for will not be found (i.e. be sure to note the difference between the spaces and the hyphens in an order number!).

1.5 Tips for Editing Station Configurations

Docking the "Hardware Catalog" Window on the Side of the Station Window

To prevent the "Hardware Catalog" window obscuring the contents of the station window, you can "dock" it on one side edge of the station window; meaning it is then positioned and fixed there. Simply double-click the area above the "Profile" list box in the Hardware Catalog. To release the "docked" window, double-click in this area once again.

You can change the size (height and width) of the "Hardware Catalog" window when the window is undocked. When the window is docked, the width of the "Hardware Catalog" window can be changed.

Recognizing Available Slots

As of STEP 7 V5.2 you can easily recognize available slots for modules at first glance, provided your monitor display is set to more than 256 colors. If you select a module in the hardware catalog and the module can be inserted in a configured rack, then the possible slots for this module are highlighted in color. This feature makes configuration faster and easier for you.

If you click a module in the "Hardware Catalog" window, and no slot is selected, the module will then be placed in the first available slot.

Selecting a Number of Rows in the Configuration Table

If you want to select a number of rows in the configuration table to copy (for example, using the pop-up menu command Copy) or delete (for example, using the pop-up menu command Delete) a number of modules or insert a number of modules of the same type, proceed as follows:

To select all rows:	Select the menu command Edit > Select > All .
To select a group of consecutive rows:	Click on the first row of the group you want to select. Keep the SHIFT key pressed and click on the last row of the group you want to select.
To select a number of rows:	Press CTRL, keep it pressed, and click on each row you want to select.

You can also insert copied modules beyond the limitations of stations if you do not violate any slot rules when inserting.

Handling Complex Stations

If you have a complex station structure with a lot of racks, for example, you can set the configuration tables to their minimum size.

1. Select the configuration table.
2. Press the right mouse button and select the menu command **Minimize** in the popup menu.

You can also set this overview using the menu command **Options > Customize**.

Arranging the Racks in the View Automatically

Using the menu command **View > Arrange Automatically** you can let STEP 7 arrange your current view automatically.

Displaying Insertable ("Pluggable") Components in the Hardware Catalog

If you have selected a slot in a rack, then you can use the menu commands **Insert > Insert Object** or **Insert > Change Object** to display a selection of modules that can be inserted. This method saves you from having to search through the hardware catalog. You can select from all modules that are available in the current catalog profile.

1.5.1 Exchanging and Moving Modules

You can adapt an existing configuration not only by copying or deleting components, but also by moving and exchanging.

Moving Modules

You can move modules or other components in a simple manner by dragging and dropping them into another valid slot within the station.

Exchanging Modules

If you have already created a configuration and wish to exchange a module for which parameters have been specified previously (for example, CPU or analog module) with another module without "losing" the assigned parameters or connection configuration, then proceed as follows:

1. Drag the new module (for example, CPU) to the slot containing the module you want to replace.
2. Confirm you want to replace the module in the dialog box which appears.

If the message "The slot is already occupied" appears, you must activate the function first using the menu command **Options > Customize** and selecting the option "Enable module exchange."

Alternative:

After you have selected a slot of a module rack, you can open the context-sensitive menu (right-click) **Insert Object** or **Replace Object** to view a list of modules you can insert. This feature saves you the search through the Hardware Catalog. You select from all the modules that are listed in the currently available catalog profile.

You can only exchange "compatible" modules. If the modules are not compatible, you have to delete the old module, insert the new module, and assign parameters to it again. STEP 7 uses an appropriate message to acknowledge an attempt to exchange modules that are not compatible.

Example: You cannot exchange a CPU with parameters assigned for a CPU with a new order number - the entire parameter assignment (for example, the MPI address) will be adopted by the new module.

1.5.2 Exchanging Racks, C7 Devices, and DP Slaves

As of STEP 7 V5.1, Service Pack 1, if you have configured a station and assigned addresses and parameters to the modules in a SIMATIC 400 rack, a C7 control system, or a DP slave, you can exchange the rack if you maintain the module arrangement and settings. In this case, a C7 control system and a DP slave are considered racks.

Exchanging racks is not relevant for the SIMATIC 300 systems with only one rack type (standard rail).

When Does It Make Sense to Exchange A Rack?

It is always necessary to exchange the rack of a SIMATIC 400 station if functionality can only be expanded with the help of a different rack.

- Replacement of a power supply that does not have redundant capability with a power supply that does have redundant capability, but is not supported by the old rack.
- Replacement of a "short" rack (9 slots) with a "long" rack (18 slots) in order to insert additional modules.
For racks that are configured as expansion racks (UR or ER with Receive-IM), the Receive-IM is automatically placed in the last slot.
- A station that was configured originally with a long rack must be configured on a short rack for reasons of space.
However, this exchange will not be permitted for long racks that are configured as expansion racks (UR or ER with Receive-IM).

Exchange of a C7 control system is always necessary in the following cases:

- The old C7 control system is to be replaced by a new one (order number with higher function status, newer firmware version)
- The functionality of the old C7 control system is to be expanded (new C7 control system with more integrated modules).

Procedure

If you want to exchange a rack that has been fitted with modules, a C7 control system, or a DP slave in a station configuration, proceed as follows:

1. In the station configuration, select the components (for example, a rack), that you want to exchange.
2. In the Hardware Catalog window, select a component that is compatible with the selected component (see below), but that has a different order number. You cannot exchange identical components.
For DP slaves, the slave interface module (for example, the IM 153-2) is selected from the Hardware Catalog window for the exchange.
3. Double-click on the component you want in the Hardware Catalog.
If the component is compatible, the exchange is made and the modules of the originally configured component are adopted with their addresses and parameters (to the extent possible).

An exchange is also possible if you use a drag-and-drop operation to move the component from the Hardware Catalog window to the component to be exchanged.

When Is a Rack "Compatible"?

A rack of a SIMATIC 400 station can be exchanged for another rack only if the basic rules listed below are adhered to. If one or more of the basic rules are not adhered to, STEP 7 does not permit an exchange and terminates the procedure with an error message that provides information on the cause of the termination.

- A segmented rack (CR2) cannot be exchanged for a non-segmented rack (for example, UR1) and vice versa.
- You must be able to insert all modules of the rack to be exchanged into the new rack; that is, no slot rules must be violated when the modules are inserted into the new rack.

Example 1: An attempt to replace a UR1 rack that has a CPU with an ER1 expansion rack is not permitted. Inserting a CPU in the ER1 violates a slot rule - no CPUs can be inserted in an ER1.

Example 2: An attempt to replace a segmented central rack in an S7-400 station (CR2) with a Universal rack (for example, UR1) is not permitted. The slots of the modules from two segments cannot be assigned uniquely to the slots in a different, non-segmented rack, and vice versa. A CR2 rack therefore can be replaced only by a CR2 rack with a different order number, for example, to make it possible to insert redundant power supply modules without having to enter the rest of the configuration again.

When Is a C7 control System "Compatible"?

A C7 control system contains integrated modules (CPU and I/O) and can be exchanged for another one if the following rules are adhered to:

- For each slot (row in the configuration table) of the new C7 control system, the corresponding slot in the old C7 control system meets the following conditions:
 - Has no modules
 - Has an identical or exchangeable module (also applies to the CPU)
- The new C7 control system has just as many or more integrated modules as the old C7 control system.

When Is a DP Slave "Compatible"?

If DP slaves can be exchanged, then they can only be exchanged within the same family, for example, within the ET 200M family. DP slaves can also be displayed in NetPro; however, they can only be exchanged in the Configuring Hardware application.

The same basic rules for exchange apply to modular DP slaves as apply to racks: the number of inserted modules must have a place in the new DP slave and the functionality of the old DP slave must also be provided by the new DP slave.

If functions that are used by more than one station were configured, such as direct data exchange between DP slaves, you must provide this configuration to the new DP slave.

The following table provides information on each individual slave family:

DP Slave Type	Exchangeable	Conditions for Exchange
DP slaves whose properties are specified by GSD files (additional information...)	No	-
DP-As-i Link	No	-
DP/PA Link	Yes	Maximum configuration of the DP master cannot be exceeded (I/O address space, number of slots) A redundantly operated DP/PA link can only be exchanged for a DP/PA link that can be operated redundantly.
ET 200L SC and IM SC	Yes	You must be able to put all inserted modules into the new DP slave.
ET 200M (IM 153-x)	Yes	Cannot be exchanged if: <ul style="list-style-type: none"> • For the old ET 200M, the function "Change Modules during Operation" was activated and the new ET 200M does not support the function • CPs/FMs with their own MPI address (for example, FM 353) • Modules are inserted in the old ET 200M which cannot be inserted in the new ET 200M • The old ET 200M was operated redundantly and the new ET 200M cannot be operated redundantly
ET 200S (IM 151-1)	Yes	Cannot be exchanged with IM 151/CPU
ET 200S (IM 151/CPU)	Yes	Cannot be exchanged with IM 151-1
ET 200X (X-BM 141..., X-BM 142..)	Yes	You must be able to put all inserted modules into the new DP slave. An X-BM 143/DESINA cannot be exchanged for other ET 200X basic modules and vice versa Cannot be exchanged with X-BM 147/CPU
ET 200X BM 147/CPU	Yes	Cannot be exchanged with X-BM 141..., X-BM 142... and X-BM 143...

Which DP Slaves Are Specified by GSD files?

DP slaves whose properties are specified by GSD files (device database files) are located in the Hardware Catalog in the "Other Field Devices" folder or also in the "CP 342-5 as DP-Master" folder, for example. Those DP Slaves (also called "Standard Slaves") can be identified by specifying the GSD file or type file in the "Order no." row or in the "DP Slave properties" dialog, "General" tab.

1.5.3 Displaying Information on Components in the Hardware Catalog

In HW Config, you can access information on modules and components on the Internet.

Requirements

You programming device (PG) has an Internet connection and a browser installed to view Internet pages.

There is information on a module available on the Internet. (The exact extent of the information available will depend on the module and when you are searching for information.).

You have enabled the function in HW Config (menu command **Options > Customize**) and have selected and found a valid Internet page.

Procedure

1. In the hardware catalog or in the module rack, select the component for which you need information.
2. Right-click to display a context menu with the following options:
Product Support Information
FAQs or
Manuals

If an Internet page is available, it will contain links to FAQs or product information that have to do with the component selected. If you select "Manuals", a search is carried out for manuals or operating instructions that contain a description of the selected component.

Other Sources of Information

The Help page for a component property sheet or the module-related Help on a message also provides links to "More Information and FAQs". STEP 7 automatically searches for appropriate information on the Internet. The results of this search are displayed in the browser.

1.5.4 Installing Hardware Updates

As of STEP 7 V5.2, you can subsequently install components for the Hardware Catalog.

In this way you can use individual components such as new CPUs or new I/O devices in the current version of STEP 7 without having to install a new service pack.

Basic Information on Hardware-Updates

Install a HW update in the following two steps:

- Download the update from the Internet or copy it from the CD to the appropriate folder.
- Install the HW update that you downloaded or copied.

Once this is completed, these subsequently installed components are available in the Hardware Catalog **in the "Standard" catalog profile**. If necessary, you can follow this procedure so that you can also edit stations that were created with a later version of STEP 7.

Requirements

You must have an Internet address and a path set to the "HW Updates" storage folder. To make these settings, click the "Customize" button to open the dialog for configuring the HW update procedure.

You must have an Internet connection available to download updates.

If the Internet connection is established over a proxy server requiring authentication, you will need to know the user name and the password.

Procedure

1. Select the menu command Options > Install HW Updates.
2. In the dialog that appears, specify whether the HW update should be downloaded from the Internet or copied from a CD or whether you want to install updates that have already been downloaded (selection available)
3. Select the component to be installed and then click the "Install" button.

2 Configuring Central Racks

2.1 Rules for Arranging Modules (SIMATIC 300)

Basic Rule

Modules must be inserted in the rack without gaps.

Exception: For installations with one rack, one slot in the configuration table must remain free (reserved for the interface module). With the S7-300, this is slot 3 and with M7-300, the slot after the module group (slot 3, 4, 5, or 6). In the actual configuration there is no gap because the backplane bus would be interrupted.

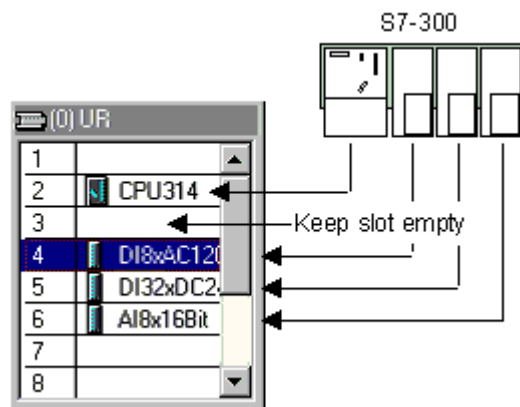

Slot Rules (S7-300)

Rack 0:

- Slot 1: Power supply only (for example, 6ES7 307-...) or empty
- Slot 2: CPU only (for example, 6ES7 314-...)
- Slot 3: Interface module (for example, 6ES7 360-.../361-...) or empty
- Slots 4 through 11: Signal or function modules, communications processors, or free.

Racks 1 to 3:

- Slot 1: Power supply module only (for example, 6ES7 307-...) or empty
- Slot 2: Free
- Slot 3: Interface module
- Slots 4 through 11: Signal or function modules, communications processors (dependent on the inserted interface module), or free.

2.1.1 Special Rules for the Dummy Module (DM 370 Dummy)

A dummy module (DM 370 Dummy) is a module that you can insert instead of a module that will be used later.

Depending on the switch setting, the module may or may not reserve address space for a module. For example, address space is reserved for a digital input/output module but not for an interface module.

Switch Setting on DM 370 Dummy	Meaning	Order Number
A	Address space can be reserved. Modules in a modular DP slave ET 200M: reserve 0 bytes of address space.	6ES7 370-0AA00-0AA0
NA	No address space reserved.	None (Module is "not visible"; it is not configured)

2.1.2 Special Rules for the Digital Simulation Module (SIM 374 IN/OUT 16)

The SIM 374 IN/OUT 16 digital simulation module can be used to simulate digital inputs and outputs.

You **cannot** find this module in the "Hardware Catalog" window. You must place the module you want to simulate in the configuration table instead of the SIM 374.

Switch Setting on SIM 374 IN/OUT 16	Module to Place
16xOutput	6ES7322-1BH00-0AA0
8xOutput 8xInput	6ES7323-1BH00-0AA0
16xInput	6ES7321-1BH00-0AA0

2.1.3 Special Rules for M7-300

When you configure an M7-300 module group, each module in the group occupies a slot.

If the first module of the module group is an M7-300 CPU, then the next slot after the module group can be occupied only by either an interface module or it remains empty.

Module Group (M7-300)

An M7-300 module group is formed when expansion modules (EXM) or a mass-storage module (MSM) are used to extend an M7 CPU or an M7 FM (function module). All modules in the module group are connected with each other via their AT-ISA bus and form, in effect, the automation computer.

First arrange the basic module (M7 CPU or M7 FM) and then the expansion modules in the configuration table. Otherwise you will not be able to insert the expansion modules.

Arranging Modules in a Module Group (M7-300)

A module group results in new slot rules:

- The M7 CPU or the expandable M7 FM is always the **first** module in the module group.
- The mass-storage module (only one can be inserted) is always the **last** module within the module group.
- The M7 CPU or M7 FM may not be expanded by more than three modules (MSM or EXM). The permitted number of expansion modules is documented for the appropriate M7 FMs.

2.2 Rules for Arranging Modules (SIMATIC-400)

2.2.1 Rules for Arranging Modules (SIMATIC-400)

The rules for the arrangement of modules on a rack of the S7-400 depend on the type of the installed rack.

Central Rack

The following rules apply:

- Insert power supply modules only in slot 1 (exception: power supply modules with redundant capability)
- Insert a maximum of six interface modules (send IMs), not more than two with power transmission
- Connect a maximum of 21 expansion racks using interface modules to the central rack
- Connect not more than one expansion rack **with power transmission** to an interface of the send IM (IM 460-1 coupled with IM 461-1);
- Connect a maximum of four expansion racks **without power transmission** (IM 460-0 with IM 461-0 or IM 460-3 with IM 461-3).

Expansion Rack

The following rules apply:

- Insert power supply modules only in slot 1
- Insert the interface module (receive IM) only in the extreme right slot (slot 9 or slot 18).
- Communication bus modules should only be inserted in expansion racks with a number not greater than 6 (otherwise, they cannot be addressed).

2.2.2 Special Rules for Power Supply Modules with Redundant Capability (S7-400)

Power supply modules with redundant (standby) capability can be inserted in a rack twice. These modules can be recognized by their info text in the "Hardware Catalog" window.

You should observe the following rules:

- It is only possible to insert power supply modules with redundant capability in the racks intended for this purpose (these can be recognized by the higher order number and info text in the "Hardware Catalog" window).
- Power supply modules with redundant capability can be operated only with the CPUs that are designed for this purpose; CPUs that are not suited for this purpose (for example, older models) are rejected during configuration.
- The power supply modules with redundant capability must be inserted in slot 1 and the slot immediately next to it (no gaps allowed).
- Power supply modules with and without redundant capability cannot be inserted in the same rack (no "mixed" configurations possible).

2.2.3 Special Rules for M7-400

An M7-400 module group is formed when expansion modules (EXM, ATM) or a mass-storage module (MSM) are used to extend an M7 CPU or an M7 FM.

First arrange the basic module (M7 CPU or M7 FM) and then the expansion modules in the configuration table. Otherwise you will not be able to insert the expansion modules.

Arranging Modules in a Module Group (M7-400)

The following rules apply:

- Not more than one mass-storage module (MSM) can be inserted.
- The M7 CPU may not be expanded by more than three modules (EXM, ATM, or MSM).
- The modules of the module group can be arranged only in the following order to the right of the M7 CPU:
 - EXM module(s)
 - MSM module
 - ATM module(s).

2.2.4 Special Rules for PROFIBUS-DP Interface Submodules (M7-400)

If you wish to use an interface submodule for PROFIBUS-DP in an M7-400 programmable controller (for example, IF 964-DP as DP master), then you should note the following:

- No other interface submodule can be inserted in the CPU, FM, or EXM under this interface submodule.
- An interface of the CPU, FM, or EXM that is below this interface submodule cannot be used.

Reason: The PROFIBUS bus connector covers the module slot or interface below.

Recommendation: Insert an interface submodule for PROFIBUS-DP only in the lowest or in the lower left module slot of a CPU, FM, or EXM.

2.3 How to Configure Central Racks

2.3.1 Creating a Station

Requirement

You must have opened the SIMATIC Manager and opened a project or created a new project.

Procedure

A station can only be created directly beneath a project.

1. Select the project in the left half of the project window.
2. Select the menu command **Insert > Station > SIMATIC 300-Station** or **... > SIMATIC 400-Station**.

The station is created with a preset name. You can replace the name of the station with a more relevant name of your own.

2.3.2 Starting the Application to Configure the Hardware

Requirement

You must have created a station (SIMATIC 300, SIMATIC 400).

Procedure

1. Select the "Station" object in the project window so that the "Hardware" object becomes visible in the right half of the station window.



"Station" object

2. Double-click on the "Hardware" object.



"Hardware" object

Alternatively you can select the "Station" object and then the menu command **Edit > Open Object**.

Result: A station window and the module catalog (if it was still open when you last exited the application) appear on the screen. You can position racks and other components in accordance with the station structure; select the components required for the station structure from the module catalog ("Hardware Catalog" window).

Opening More Stations

Using the menu command **Station > New** you can configure another station in the same project; using **Station > Open** you can open an existing (offline) station configuration for editing.

2.3.3 Arranging the Central Rack

Requirement

The station window must be open and you must have a plan of the hardware configuration of the station.

Procedure

1. Select a suitable central rack ("Rack") for your configuration from the "Hardware Catalog" window; in SIMATIC 300 the Rail, in SIMATIC 400 the Universal rack (UR1), for example.
2. Drag the rack to the station window.
The rack appears in the form of a small configuration table in the upper part of the station window. In the lower part of the window, the detailed view of the rack appears with additional information such as the order number, MPI address, and I/O addresses.
Alternatively to steps 1 and 2, you can also double-click the rack in the "Hardware Catalog" window.

2.3.4 Arranging Modules in a Rack

Requirements

You have arranged a rack in a station window and the rack is not shown minimized (the rack slots are visible).

If you want to have the visual advantage of having the available slots of a selected module highlighted in color in STEP 7, your monitor display must be set for more than 256 colors.

Procedure

1. Select a module (for example, a CPU) from the "Hardware Catalog" window. The slots available for this module are highlighted in color.
2. Drag & drop the module into the appropriate row of the rack (configuration table). STEP 7 checks whether any slot rules are violated (an S7-300 CPU must not, for example, be inserted in slot 2).



Symbol that appears when the slot rules are violated.

3. Repeat steps 1 and 2 until the rack has been fully equipped with the required modules.

Alternatively, you can also select the appropriate row in the configuration table and double-click on the required module in the "Hardware Catalog" window.

If no row in the rack is selected and you double-click a module in the "Hardware Catalog" window, the module will then be placed in the first available slot.

Tip

After you have selected a slot of a module rack, you can open the context-sensitive menu (right-click) **Insert Object** or **Replace Object** to view a list of modules you can insert. This feature saves you the search through the Hardware Catalog. You select from all the modules that are listed in the currently available catalog profile.

Display of Interfaces and Interface Submodules

The interfaces and interface submodules are shown in the configuration table in a separate row. The row has the same name as the interface (for example, X1) or - if the module has slots for interface submodules - bears the prefix "IF" (for example, IF1).

With **integrated interfaces** the name of the interface appears in the "Module" column; with modules with slots for **interface submodules** you can copy a suitable interface submodule (IF) from the "Hardware Catalog" window to the appropriate row using drag & drop.

2.3.5 Displaying the Version of the CPU Operating System in the 'Hardware Catalog' window

When a CPU has more than one operating system this CPU is shown as a folder with different order number icons in the "Hardware Catalog" window. The different versions of the CPU operating system are arranged under the order number icons.

Please check the version of your CPU's operating system and select the correct version in the "Hardware Catalog" window.

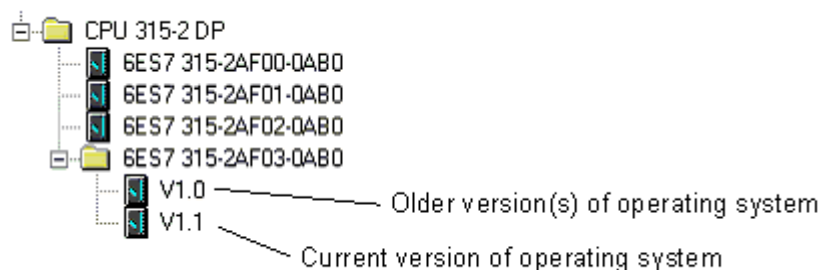

2.3.6 Arranging C7 Control Systems (Special Features)

In a C7 control system (C7-620), the following components are integrated in one housing:

- SIMATIC 300 CPU
- Inputs and outputs (digital and analog)
- Interface module IM 360 for connecting further SIMATIC 300 modules
- Line-oriented operator panel with a printer port

Simplified Procedure

The C7 control system is not mounted on a rail - this means you do not have to arrange a rack.

Requirement

The station window and "Hardware Catalog" window must be visible.

Procedure

1. Select a C7 control system from the "Hardware Catalog" window. These systems can be found under SIMATIC 300.
2. Drag the C7 control system to the station window.
3. If you want to expand the C7 control system:
 - Select rails as racks from the "Hardware Catalog" window.
 - Drag the racks to the station window one by one.
 - Assign modules to the racks. Important: The interface modules (IM) must be inserted in all racks so that connecting up is possible.

2.3.7 Assigning Properties to Modules/Interfaces

Introduction

Properties of components such as modules or interfaces are addresses and parameters. Only if you want to change the default values do you need to read the following sections.

Requirement

You have arranged in the configuration table the component for which you want to modify the properties.

Procedure

Every component (module, interface, or interface submodule) has default properties; for example, default measurement types and measuring ranges for analog input modules.

If you want to change these settings, proceed as follows:

1. Double-click in the configuration table on the component (for example, module or interface submodule) that is to have parameters assigned or select the row and select the **Edit > Object Properties** menu command.
Using the right-hand mouse button: Move the mouse pointer to the component, press the right-hand mouse button, and select the **Object Properties** command from the pop-up menu
2. Use the displayed tabbed dialog boxes to assign the component properties.

2.3.8 Assigning Addresses

There is a difference between assigning addresses to nodes and assigning input/output addresses (I/O addresses).

Node addresses are addresses of programmable modules (MPI, PROFIBUS, Industrial Ethernet addresses); they are required in order to be able to address the various nodes in a subnet, for example, in order to download a user program to a CPU. You will find information on assigning node addresses in the subnet in the chapter on networking stations.

Input/output (I/O) addresses are required in order to read inputs and set outputs in the user program.

Special Feature: MPI Addresses of FMs and CPs (S7-300)

Communications processors (CPs) and function modules (FMs) with their own MPI address have a special feature: their MPI address is determined automatically by the CPU and assigned according to the following pattern:

- First CP/FM after the CPU: MPI address of the CPU + 1
- Second CP/FM after the CPU: MPI address of the CPU + 2

The newer S7-300 CPUs (see CPU manual or Product Information) permit free MPI address allocation for such CPs and FMs (via the "General" tab for the module).

2.3.9 Assigning I/O Addresses

STEP 7 assigns input and output addresses when modules are placed in the configuration table. This means every module has a start address (address of the first channel); the addresses for the remaining channels are based on this start address.

Requirements

- The module is inserted in a central rack or expansion rack and the CPU must permit free address assignment.
- The module is inserted in a DP slave or the module is a DP slave (compact DP slave).

Procedure

1. Double-click on the row of the rack containing the module whose start address you wish to set, or select the module and select the **Edit > Object Properties** menu command.
2. Select the "Addresses" tab.
3. Change the default start address.

Note

For modules within a local bus segment, formed by a function module (S7-300) or for special function modules (S7-400), you have to assign a further start address. In addition to the start address for the CPU, the module then has a start address for the FM. In the overall view of the configuration table, the start address from the point of view of the FM is always displayed in this case.

Displaying the Address Overview

You can display the input and output addresses already used and any address gaps as follows:

1. Open the station whose addresses you want to display.
2. Select the menu command **View > Address Overview**.
3. In the "Address Overview" dialog box, select the module whose assigned inputs and outputs you want to display (for example, CPU).
4. If required, you can filter the display by address type (for example, input addresses only).

The address areas "Inputs" and "Outputs" are displayed with locations for the modules (e.g. master system no., PROFIBUS address for PROFIBUS DP, rack, slot, interface submodule slot). Input addresses with the length 0 (for example, addresses of interface modules) are marked with an asterisk (*).

2.3.10 Assigning Symbols to I/O Addresses

Introduction

You can assign symbols to input/output addresses when you configure modules without having to go via the symbol table.

You can only assign symbols to the inputs and outputs of digital or analog modules when configuring the hardware. With integrated inputs/outputs (for example, CPU 312 IFM), in CPs, FMs, and S5 modules (for example, configured via the adapter module) you must assign the symbols in the symbol table.

The assigned symbols are not downloaded to the station (menu command: **PLC > Download**). The consequence of this is: when you upload a station configuration back into the programming device (menu command: **PLC > Upload**), no symbols are displayed.

Procedure

1. Select the digital/analog module to whose addresses you want to assign symbols.
2. Select the menu command **Edit > Symbols** or press the right mouse button and select the **Symbols** command in the pop-up menu.
You can assign symbols in the dialog box that appears.
If you click the "Add Symbol" button in the dialog box, the name of the address is entered as the symbol.

2.3.11 Monitoring Inputs and Modifying Outputs When Configuring Hardware

Introduction

If the CPU can be reached online and you have loaded the hardware configuration onto the CPU, you can address the inputs and outputs of the configured input and output modules directly, that is, without having to change the application.

Proceed as follows:

1. Highlight the module you want to monitor or control.
2. Select the menu command **PLC > Monitor/Modify**.
The menu command can only be activated if the module can be monitored or modified (modules of the type DI, DO, AI, or AO, for example).
A dialog box will open displaying the inputs and outputs of the module in a table (Address column).
The inputs and outputs will be displayed in binary format for digital modules and in word format for analog modules.

Monitor

1. Activate the Monitor check box.
2. Click on the Trigger button to modify or change the trigger point and trigger frequencies. You will find information about the settings in the Help of the Trigger dialog box that appears when you click on the button.
3. If you want to monitor peripheral inputs directly, activate the I/O Display check box; if the check box is not activated, the process image of the inputs is monitored.
4. If you choose the trigger frequency Once, you must update the display in the Status Value column by means of the Status Values button. The value remains "frozen" until you click again on the Status Value button.

Modify

With a defined trigger:

1. Enter the modify values in the table.
2. Click on the "Trigger" button to check or change the trigger point or trigger condition.
You will find information about the settings in the Help of the "Trigger" dialog box that is displayed when you click the button.
3. Select the "Modify" check box. All visible addresses with a modify value will be modified.

Modifying variables once:

Regardless of the trigger point or trigger condition set, you can also assign values to variables once in a separate operation. When the function is activated, an action like "Trigger immediately" is carried out, without reference to a specific point in the user program.

1. Enter the modify values in the table.
 2. Click the "Modify values" button.
- If you want to modify peripheral outputs directly, activate the I/O Display check box; if the check box is not activated, the process image of the outputs is controlled.
 - If you also want to modify outputs directly in STOP mode of the CPU, you must activate the Enable PQ check box. Otherwise, the outputs remain set in STOP mode, and they have a configured substitute value.

Monitoring Modified Addresses

Note that the display in the "Status Value" column depends on the trigger points set and on the processes in the CPU (for example, the update times of the process images).

You should set the trigger point for monitoring to "Cycle Start" and the trigger point for modifying to "Cycle End", so that the modified value can be displayed in the "Status Value" column!

Monitoring and Modifying I/O Modules

When monitoring an I/O module (for example, 8DI/8DO), note that the trigger applies to the entire module.

If, for example, you set the trigger point for monitoring to "Cycle Start", the inputs as well as the outputs are modified at that time. In this case, the control values for the inputs are activated, because they overwrite the process image of the inputs **after** the process image of the inputs has been updated; this means, directly before the cyclic program processing of the input process images was started. In this case, the values for the outputs are overwritten by the user program.

Monitoring and Modifying Distributed I/Os

Distributed I/Os can be read consistently with the SFC 14 "DPRD_DAT" and can be written consistently with the SFC 15 "DPWR_DAT". In order to access the actual status or values when monitoring, you must note the following:

The "RECORD" input parameter of the SFCs has to be provided with "I" (input) or "O" (output). This must be exactly the configured address area which is displayed in the configuration table of the DP slave in the "I address" or "O address" column.

If different areas are selected for saving the consistent data, non-relevant areas of the process image are displayed in the table for monitoring.

2.3.12 Configuring Point-to-Point CPs

Introduction to Configuring Point-to-Point CPs (PtP CPs)

As with other modules, you drag communication processors from the Hardware Catalog window and arrange them and assign parameters to them in the configuration table (General Settings, Addresses and Basic Parameters).

You can start the optional software for setting the procedure parameters by means of the Parameters interface in the Basic Parameters tab.

For PtP CPs in a SIMATIC 400 station, you have to configure PtP connections. The following section describes the procedure briefly. You can find a more detailed description in the manuals for the PtP CPs.

Configuring Connections for S7-400 PtP CPs

For the connection between an S7 CPU and a partner that is connected by means of a point-to-point interface, the PtP CP represents the link.

You must configure connections between the S7-400 CPU and the PtP CP.

Proceed as follows:

1. In HW Config, configure the PtP CP and, if the connection partner is also a PtP CP in an S7-400 station, configure the partner station also.
2. Start NetPro (from HW Config: menu command **Options > Configure Network**).
3. If you have already created a PtP subnet while you were configuring the PtP CP and you have networked the CP, continue with step 4; otherwise, insert a PtP subnet and use it to network the CP.
4. Select the connection partner:
 - The connection partner is a CP 34x (PtP CP in an S7-300 station), an S5 CP PtP, a printer, or a device from another manufacturer: Configure an "Other Station" as connection partner. For the "Other Station," configure a PtP interface and network this interface with the PtP subnet that you created.
 - The connection partner is a PtP CP for a SIMATIC 400 station: You have already configured the connection partner in step 1 and so you can continue with step 5.
5. Configuring PtP Connections
6. Load the configuration data and the connection data into the appropriate stations.

2.3.13 Configuring S5 Modules

You can insert S5 modules in a SIMATIC 400 station. These modules are connected via:

- An S5 adapter module (IM 470) or
- An IM 463-2 for connecting S5 expansion devices with IM 314

You can find these modules in the "Hardware Catalog" window under "IM 400."

Note

You must configure the input or output address areas of the S5 modules for each connection. (Double-click the adapter module or IM 463-2 and then select the "Input Addresses" or "Output Addresses" tab.)

If the address areas are not configured, the modules mentioned above will not be saved in the system data blocks (SDB). **Result:** The configuration which was downloaded to the CPU will not contain information about these modules. If this configuration is uploaded to the programming device, these modules will not appear in the configuration table.

2.4 Expanding the Central Rack with Expansion Racks

Configuring Expansion Racks in SIMATIC 300

For SIMATIC 300 stations, only "Rails" are available as central racks and as expansion racks; this means you can position as many rails (max. 4) as there are in the actual configuration.

Expansion racks are linked in STEP 7 by inserting the appropriate interface module in slot 3 of every rack.

- To expand the configuration by one rack:
racks 0 and 1: IM 365
- To expand the configuration by up to three racks:
rack 0: IM 360; racks 1 to 3: IM 361

Configuring Expansion Racks in SIMATIC 400

In SIMATIC 400, the possibilities for expansion are more complex owing to the different racks and interface modules.

All expansion racks that are connected to an interface of the send IM on the central rack form a **cascade**.

In the following figure, three expansion racks are connected to each interface of the send IM.

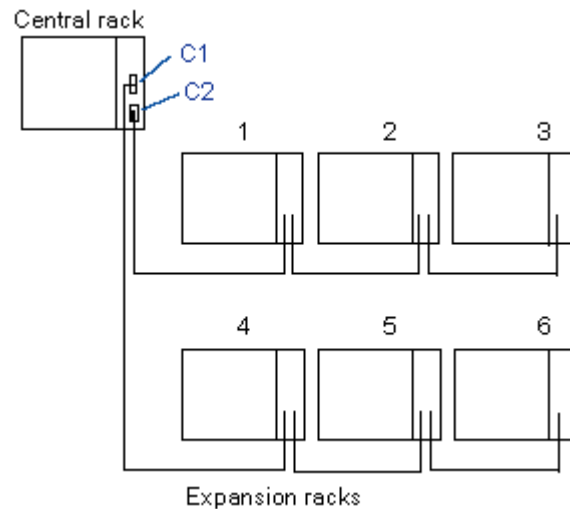

2.4.1 Rules for Connecting Expansion Racks (SIMATIC 400)

If you connect expansion racks (SIMATIC 400) to an interface module (send IM) of the central rack, then the following characteristics for the send IM and the receive IM must match:

- Power transfer (with/without)
- Type of link (centralized/distributed)
- Communication bus transmission (with/without interrupt transmission).

2.4.2 Arranging the Expansion Rack (SIMATIC 400)

Procedure

1. Select the appropriate (expansion) racks from the "Hardware Catalog" window.
2. Drag the racks to the station window one by one.
3. If you wish to change the number of the rack:
Double-click the second row of the rack in the upper half of the station window.
You can change the number in the "General" tab for the rack.
4. Assign modules to the racks.
Important: To permit the racks to be connected to each other, the interface modules must be inserted in all racks.
5. **For S7-400 only:** make the connections between the interface modules in the racks:
 - Double-click on the send IM.
 - Select the "Connect" tab
This tab shows all racks that are not connected (racks with inserted receive IMs).
 - Select the individual racks and use the "Connect" button to connect them to the required interface of the send IM (C1 or C2).
Connection lines then show how the racks are connected together.

2.4.3 Special Case: When the Central Rack Has More Than One CPU

If you wish to extend the configuration which consists of the segmented rack CR2 (S7-400) or a multicomputing configuration with racks you must adhere to the following order:

1. Configure the central rack (for example, CR2) with the send IM.
2. **Only** insert Receive IMs in the expansion racks.
3. Remove the connections between the interface modules (IMs) as described above.

Only then can you insert modules in the expansion racks. Reason: Because the address space exists more than once for multiple CPUs, the expansion rack must first be assigned to an address space (= a CPU).

3 Configuring the Distributed I/O (DP)

Introduction

The distributed I/O refers to master systems, comprising DP (distributed I/O) master and DP slaves that are connected via a bus cable and communicate with each other via the PROFIBUS-DP protocol.

As DP masters and DP slaves can be different devices, this section only explains the basic procedures involved in configuring. You will find details on functionality, access procedures etc. in the manuals for the specific devices and in the online help for the special FCs (for example, DP-SEND and DP-RECEIVE for CP 342-5).

3.1 Basic Procedure for Configuring a DP Master System

If you know the principles of how to configure a central structure, you also know how to configure the distributed I/O - the procedure is the same to a large extent.

Station Window as an Image of the Real DP Master System

When you place a DP master (for example, a CPU 315-2DP), STEP 7 automatically draws a line that represents the master system. At the end of the line, place the DP slaves that are assigned to this DP master using drag & drop from the "Hardware Catalog" window under "PROFIBUS-DP."

As a DP master system is always connected to a PROFIBUS subnet, STEP 7 automatically displays dialog boxes for setting the subnet properties (for example, transmission rate) and the PROFIBUS address when you place the DP components.

DP Slave Does Not Appear in the "Hardware Catalog" Window

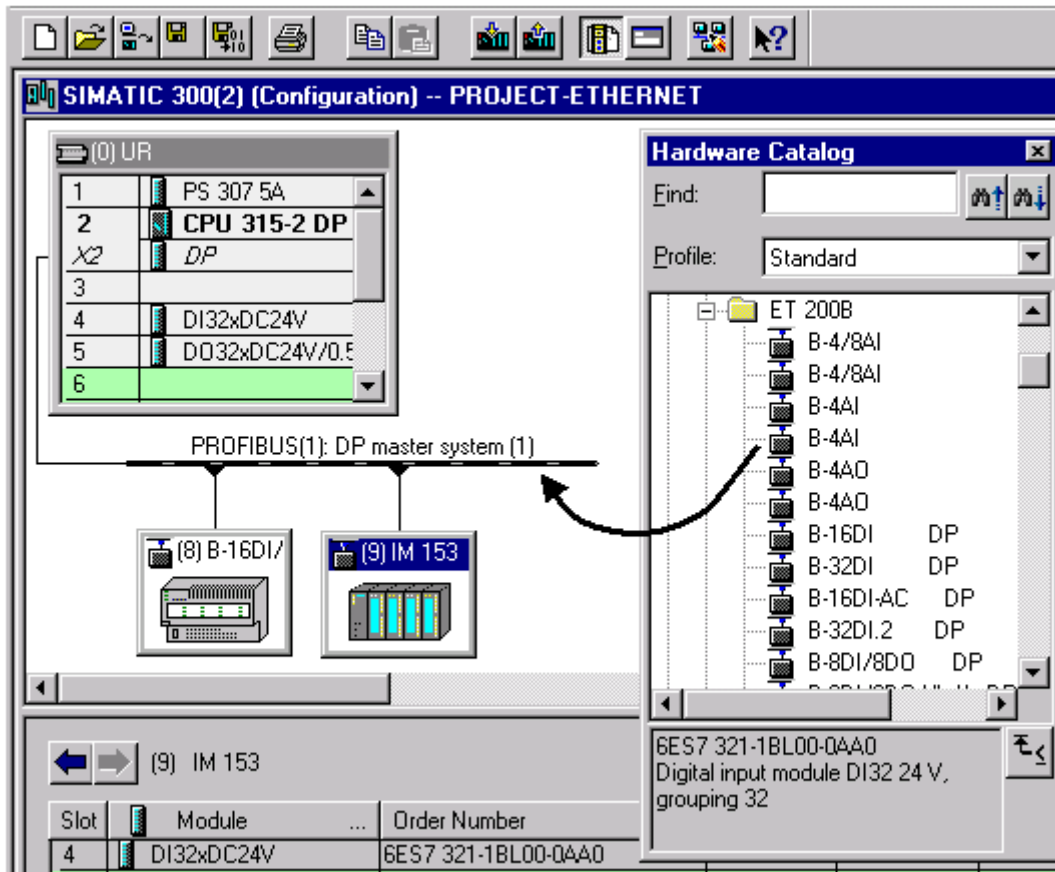

If a DP slave does not appear in the "Hardware Catalog" window, you must install the corresponding *.GSD file after the start of STEP 7 using the menu command **Options > Install GSD File**. The dialog boxes then guide you through the process of installing the *.GSD file. The installed DP slave then appears in the "Hardware Catalog" window under "PROFIBUS-DP - Other Field Devices."



Slave Configuration in the Detailed View

If you select the DP slave, the slave structure (DP identifiers and modules/submodules) and I/O addresses are displayed in the detailed view of the station window.

Switching Between the DP Master System and the DP Slave in the Detailed View of the Station Window

If you select the symbol for the DP master system (—) , all DP slaves belonging to the DP master system will be displayed in the lower half of the station window. If you select a DP slave symbol, the configuration of the DP slave is displayed in the lower half of the station window. You can easily change between displays by using the  and  buttons.

Slot Numbering in Distributed I/O Devices

Depending on which DP slave type you are configuring, the slots in the detailed view of the DP slave begin either with "0" or "4."

With DP slaves that are configured by *.GSD files, the *.GSD file specifies at which slot the I/O addresses start; the slots before that are "empty."

Slot numbering of DP slaves such as ET 200M that are completely integrated in STEP 7 is derived from the structure of an S7-300 station according to the following pattern:

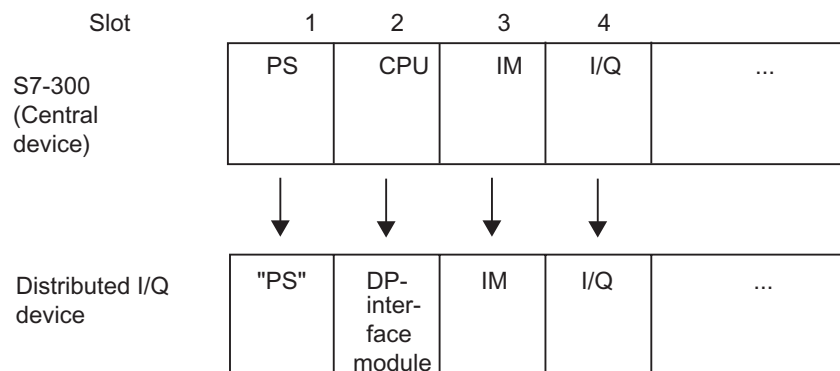

Remarks on the slots of a DP slave, which is structured like the S7-300 station:

- The "actual" I/O (inputs/outputs) always starts with slot 4.
- Independent of whether a power supply module (PS) is inserted in the real configuration or not: slot 1 is always reserved for a PS.
- Slot 2 is always reserved for the DP interface module.
- Slot 3 is always reserved for an expansion interface module (IM), independent of whether a "real" I/O device can be expanded or not.

This pattern is used for all DP slave types: modular and compact. The slot arrangement is important for evaluating diagnostic messages (the slot that triggers diagnostics).

3.2 Where Are the DP Slaves in the Hardware Catalog Window?

All DP slaves can be found in the "Hardware Catalog" window under the "PROFIBUS-DP" folder.

The following applies here:

The DP master is...

- ...a SIMATIC 300 or SIMATIC 400 CPU with integrated PROFIBUS-DP interface, a PROFIBUS CP (without CP 342-5DA00) in a SIMATIC 300/400 or a SIMATIC PC station with a PROFIBUS CP (without CP 5611/CP 5613)

The DP slaves appear under their "family name" (e.g. PROFIBUS-DP\ET 200B).

- ...a CP 342-5DA00 with PROFIBUS-DP interface or an SIMATIC PC station with CP 5611/CP 5613:
The DP slaves appear either in the "DP V0 Slaves" folder and then under their family name (e.g. PROFIBUS DP\DP V0 Slaves\ET 200B).

The "DP V0 Slaves" contains the DP slaves represented by their GSD file or type file (referred to as "Standard Slaves").

Folders designated with the family name and located directly under PROFIBUS DP (e.g. PROFIBUS DP\ET 200B) usually contain the DP slaves whose properties are represented by internal STEP 7 information (referred to as "S7 Slaves").

The DP slave was purchased separately (with a new *.GSD file)

The DP slave will appear under "Other Field Devices" after you have installed the *.GSD file.

The DP slave is an intelligent DP slave

Examples: You can configure stations as a DP slave with:

- CP 342-5 DP
- CPU 315-2 DP, CPU 316-2 DP, CPU 318-2 DP
- Basic submodule ET 200X (BM 147/CPU)
- IM 151/CPU (ET 200S)

The DP slave appears under the "Configured Stations" folder after configuring the station. The procedure (how does a station appear in the "Configured Stations" folder?) is described in detail in the section about configuring the intelligent DP slaves.

3.3 Distributed Reading and Writing of Consistent Data (> 4 Bytes)

Previously, you were able to access consistent data (> 4 Bytes) on a DP slave by means of SFC 14 and SFC 15.

As of Version 3.0 of CPU 318-2 and CPUs 41x, you can also access a consistent data area by accessing the process image (such as L IW).

Configuring Consistent Data Areas > 4 Bytes

1. In the hardware configuration, select the "Addresses" tab for the DP slave. Depending on the type of DP slave, the consistency area either has standard default settings and cannot be changed (such as specified by a GSD file), or you can define the consistency area in the fields "Length", "Unit" and "Consistency via".
2. If necessary, define the length of the consistent area and enter this area into a process image. To do this proceed as follows: In the "Process image partition" field, select OB1-PI or, in the case of S7-400, select yet another process-image partition (PIP) such as PIP 3. If you do not put the data in a process image partition, then you must use SFC 14 or SFC 15 for data exchanges.

The screenshot shows the 'Properties - DP slave' dialog box. The 'I/O Type' is set to 'Out-input'. The 'Output' section is expanded, showing the following fields:

Field	Value
Start	0
End	49
Length	50
Unit	Byte
Consistent over	Total length
Process image partition	TPA 3

Upon update of the process image, the operating system transfers these data consistently, and you can use download and transfer commands to access the data in the process image. This provides you with an easy and efficient (low run-time load) way to access consistent data.

3.4 Configurations for PROFIBUS-DP

The following topics provide examples of configurations for PROFIBUS-DP that you can create with STEP 7.

- Configuration with "Simple" (Modular or Compact) DP Slaves (Data Exchange: Slave <> Master)
- Configuration with Intelligent DP Slaves (Data Exchange: Slave <> Master)
- Configuration with Intelligent DP Slaves (Direct Data Exchange: Slave > I Slave)
- Configuration with Two DP Master Systems (Direct Data Exchange: Slave > Master)
- Configuration with Two DP Master Systems (Direct Data Exchange: Slave > I Slave)
- Example of Configuring Direct Data Exchange (Lateral Communication)

3.4.1 Configuration with 'Simple' (Modular or Compact) DP Slaves (Data Exchange: Slave <> Master)

In this configuration, data exchange takes place between the DP master and simple DP slaves, that is, I/O modules, by means of the DP master. The DP master polls each configured DP slave, one after the other, in the master's polling list within the DP master system and transmits the output data or receives the input data from the slaves. The I/O addresses are assigned automatically by the configuration system.

This configuration is also known as a mono-master system because a single master with its associated DP slaves are connected to one physical PROFIBUS DP subnet.

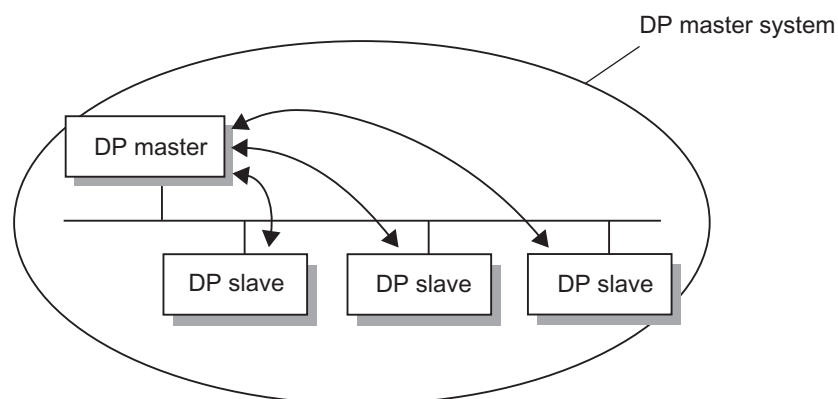

3.4.2 Configuration with Intelligent DP Slaves (Data Exchange: I Slave <> Master)

You can divide automation tasks into subtasks that can be controlled by a higher-level programmable logic controller. These control tasks, which can be accomplished independently and efficiently, run as preprocessing on a CPU. This CPU can be implemented in the form of an intelligent DP slave.

For configurations with intelligent DP slaves (I slaves), such as a CPU 315-2DP, the DP master does not access the I/O modules of the intelligent DP slave; instead, the master accesses only the address areas of the CPU of the I slave. This means that this address area cannot be assigned for real I/O modules in the I slave. This assignment must be made when the I slave is configured.

Examples of intelligent DP slaves (= DP slaves with preprocessing): station with CPU 315-2DP, CPU 316-2DP, CPU 318-2DP

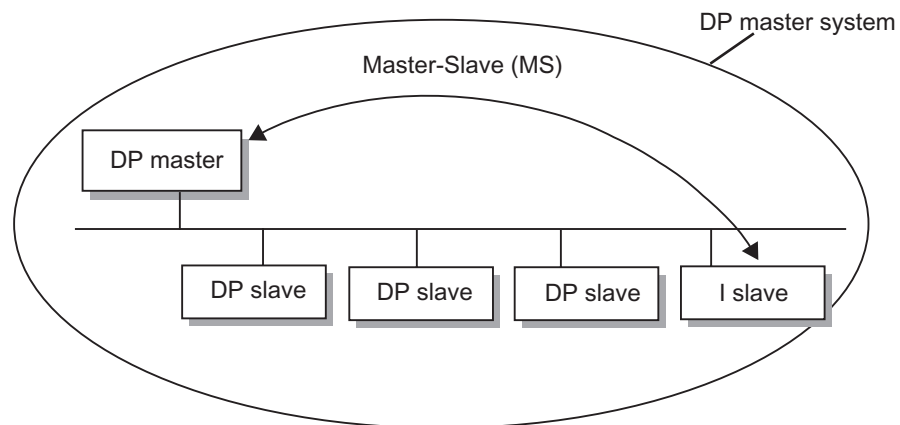

3.4.3 Configuration with Intelligent DP Slaves (Direct Data Exchange: Slave > I Slave)

With this configuration, input data from DP slaves can be transmitted very rapidly to intelligent DP slaves on the PROFIBUS-DP subnet.

In this manner, all simple DP slaves (as of a certain release) or other intelligent DP slaves can, in principle, provide selected input data for direct data exchange (DX) between DP slaves. Only intelligent DP slaves such as CPU 315-2DP can be used to receive these data.

Example of stations that can be configured as intelligent DP slaves: CPU 315-2DP, CPU 316-2DP, CPU 318-2DP

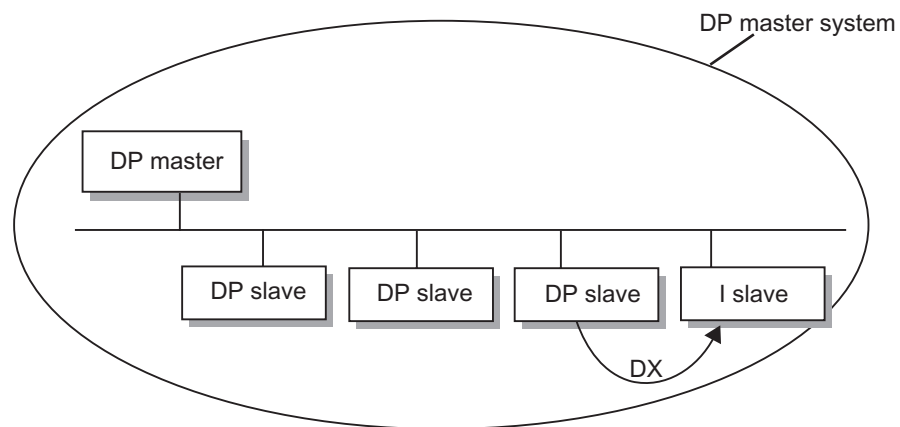

3.4.4 Configuration with Two DP Master Systems (Direct Data Exchange: Slave > I Slave)

Several DP master systems on one physical PROFIBUS-DP subnet are also called a multiple master system. In this configuration, input data from DP slaves can be read very rapidly by intelligent DP slaves on the same physical PROFIBUS-DP subnet. The intelligent DP slaves can be located on the same DP master system or on another system.

In this manner, an intelligent DP slave such as a CPU 315-2DP can allow input data from DP slaves to be transmitted directly to its input data area, even from different DP master systems (that is, multiple master systems).

In principle, all DP slaves (as of a certain release) can provide selected input data for direct data exchange (DX) between DP slaves. These input data can in turn be used further only by intelligent DP slaves such as CPU 315-2DP.

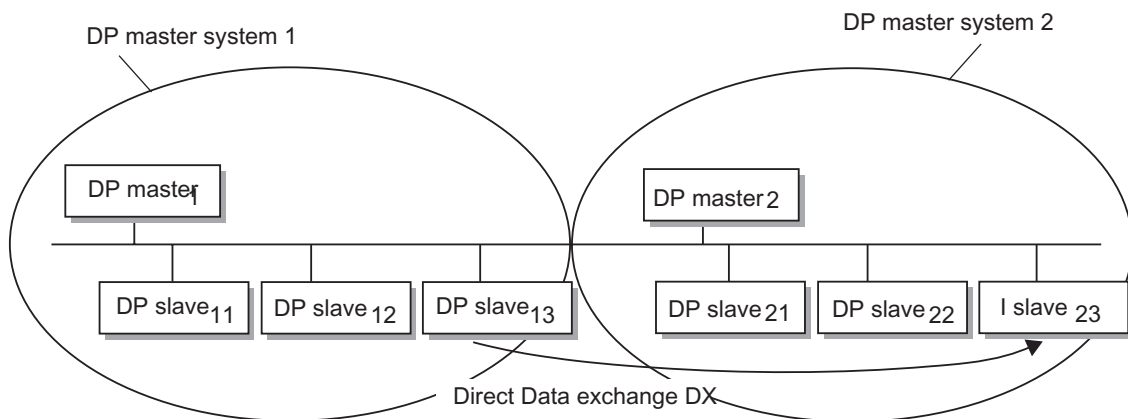

3.4.5 Configuration with Two DP Master Systems (Direct Data Exchange: Slave > Master)

Several DP master systems on one physical PROFIBUS-DP subnet are also called a multiple master system. In this configuration, input data from intelligent DP slaves or simple DP slaves can be read directly by the master of a different DP master system on the same physical PROFIBUS-DP subnet.

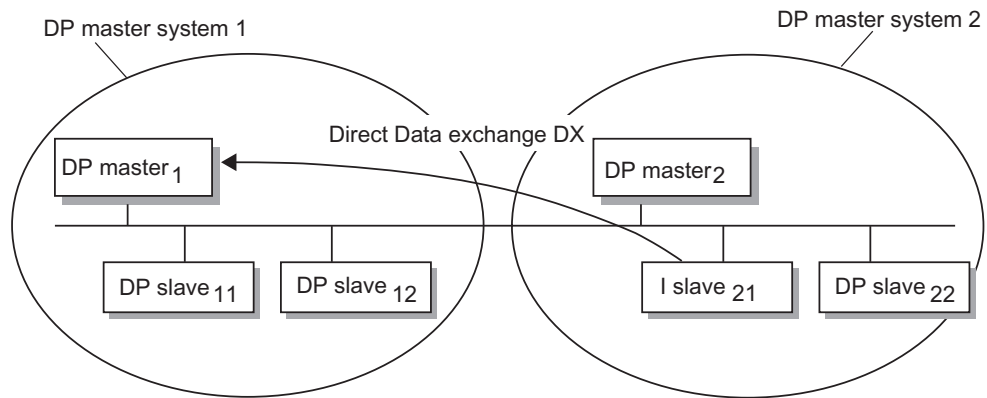

3.5 How to Configure Distributed I/O Systems

3.5.1 Creating a DP Master System

Requirement

You have arranged a rack in a station window and the rack is shown as being open (the rack slots are visible).

DP Master

You can use the following items as DP master:

- A CPU with a fixed integrated or installable DP master interface (fixed integrated, for example, CPU 315-2 DP).
- An interface submodule that is assigned to a CPU/FM (for example, IF 964-DP in CPU 488-4).
- A CP in conjunction with a CPU (for example, CP 3425, CP 4435).
- An interface module with DP master interface (for example, IM 467)

Procedure

1. Select a DP master from the "Hardware Catalog" window (for example, CPU 315-2 DP).
2. Drag the module to a suitable row in the rack. The "Properties - PROFIBUS Node" dialog box opens.
Here you can do the following:
 - Create a new PROFIBUS subnet or select an existing subnet
 - Set properties for the PROFIBUS subnet (transmission rate etc.)
 - Set the PROFIBUS address of the DP master
3. Confirm the settings with "OK."
The following symbol appears: 
This symbol is the "anchor" for the DP slave of the master system.

Tip: If you cannot find the symbol immediately, it may be hidden by the configuration table. Make the width of the configuration table containing the DP master smaller. If the symbol for the DP master system is still not visible, select the menu command **Insert > Master System**.

3.5.2 Handling DP Master Systems and DP Interfaces

Separating DP Master Systems

If you insert a CPU with an integrated PROFIBUS-DP interface or a PROFIBUS CP in a station (configurable as an intelligent DP slave) and you have configured the CPU or CP as a DP master with master system, you can separate the master system from the DP master:

1. Select the DP master interface
2. Select the menu command **Edit > Master System > Separate**.
Alternative: Use the right mouse button to get a pop-up menu and select the command **Master System > Separate**.

The master system is maintained as an "orphaned" master system and is visible in the station. The configured direct data exchange (lateral communication) is maintained.

If no slaves are connected to the master system, the master system is deleted.

Inserting a DP Master System

If you configured one or more DP master systems and separated them from the DP master interface, you can insert one of the orphaned DP master systems again at the selected DP master interface by means of the menu command **Edit > Master System > Insert**.

Giving the PROFIBUS-DP Interface Online Capability

If you want the integrated PROFIBUS-DP interface of a CPU to behave like an active node on the PROFIBUS-DP (thus enabling programming device functions by means of this interface), make sure that the following conditions are met:

1. The PROFIBUS-DP interface must be configured as "networked," that is, when the PROFIBUS-DP interface is selected, a PROFIBUS subnet must be selected or newly created by means of the menu command **Edit > Object Properties**.
2. This configuration must be loaded to the CPU.
Afterwards, such functions as monitoring with the programming device are possible by means of the PROFIBUS-DP interface.

Changing the Properties of a Master System

From STEP 7 V5.0, Service Pack 3 onwards you can change the properties of a master system (name and number):

1. Double-click the line representing the master system in an open station configuration.
2. Select the "General" tab and adapt the name and master system number to your requirements.
You can also edit the corresponding subnet using the "Properties" button.

3.5.3 Selecting and Arranging DP Slaves

Types of DP Slaves

When configuring DP slaves, we differentiate between:

- Compact DP slaves
(modules with integrated digital/analog inputs and outputs, for example, ET 200B)
- Modular DP slaves
(interface modules with S5 or S7 modules assigned, for example, ET 200M)
- Intelligent slaves (I slaves)
(S7-300 stations with, for example, CP 342-5, CPU 315-2DP, or ET 200X with BM 147/CPU)

Note

Note the technical specifications (max. number of nodes, max. number of slots, max. number of user data) of the DP master when configuring the master system. It is possible that you may not be able to configure the maximum number of nodes owing to the limits for the number of slots or user data.

Requirement

A DP master system must be present and visible in the station window.

Symbol for the DP master system: 

If the symbol is not visible (for example, it was deleted), you can create it by selecting the row for the DP interface of the DP master and selecting the menu command **Insert > Master System**.

3.5.4 Copying Multiple DP Slaves

1. Hold CTRL pressed and click on the DP slaves you want to copy one by one.
Result: The DP slaves are selected.
2. Select the menu command **Edit > Copy**.
3. Select the DP master system to which the copied DP slaves are to be added.
4. Select the menu command **Edit > Paste** ("normal" copying) or **Edit > Redundant Paste** (when copying for software redundancy).

3.5.5 Configuring Compact DP Slaves

Procedure

1. Select a compact DP slave (for example, ET 200B) from the "Hardware Catalog" window.
2. Drag the DP slave to the following symbol for a DP master system:

The "Properties - PROFIBUS Node" dialog box opens. Here you can set the following:
 - The properties for the PROFIBUS subnet (transmission rate etc.)
 - The PROFIBUS address of the DP slave.
3. Confirm the settings with "OK."
Result: A symbol is attached to the DP master system to represent the compact DP slave. The I/O configuration of the compact DP slave is displayed in the lower half of the station window (detailed view).

3.5.6 Configuring Modular DP Slaves

Procedure

1. Select an interface module for a modular DP slave (for example, IM 153 for ET 200M) from the "Hardware Catalog" window.
2. Drag the interface module to the following symbol for the DP master system:

Result: The "Properties - PROFIBUS Node" dialog box opens. Here you can set the following:
 - The properties of the PROFIBUS subnet (transmission rate, etc.).
 - The PROFIBUS address of the DP slave.
3. Confirm your settings with "OK."
A symbol for the DP slave is attached to the DP master system. The detailed view of the DP slave appears in the lower half of the station window showing all the possible slots or DP identifiers.
4. Assign the modules for the modular DP slave in the lower half of the station window.
For modular DP slaves, the possible modules are arranged in the "Hardware Catalog" window below the associated DP slave "family."
These are e.g.:
 - Terminal blocks (TB...SC) for Smart Connect (family ET 200L SC)
 - SC submodules (family ET 200L SC)
 - AS-i slaves (family DP/AS-i Link)
 - S7-300 modules (family ET 200M)

3.5.7 Assigning DP Slaves to SYNC or FREEZE Groups

A DP master with the appropriate function can send the SYNC and/or FREEZE control commands simultaneously to a group of slaves to synchronize the DP slaves. To do this, you must assign the SYNC and FREEZE groups for the DP slaves.

Requirement

You must have created a DP master system.

Procedure

1. Select the DP master system symbol containing the DP slave that you wish to assign to a group.
2. Select the menu command **Edit > Object Properties**.
Result: The "Group Assignment" tab appears with a table in which you can assign the SYNC/FREEZE groups for the DP slave.

Note

You can assign a maximum of one SYNC and one FREEZE group to each DP slave.

Exception: If a CP 3425 is used as DP master, a maximum of eight groups (SYNC and/or FREEZE groups) can be assigned to each DP slave of this master system (see CP 342-5 documentation).

What You Should Know About the SYNC and FREEZE Control Commands

The SYNC and FREEZE commands can be used to perform event-driven synchronization of the DP slaves. The DP master sends the control commands simultaneously to a group of DP slaves of its master system. Those slaves that have failed or are currently reporting diagnostics are ignored.

The requirement for synchronization using control commands is that you have assigned the DP slaves to SYNC and/or FREEZE groups.

Für eine S7-CPU verwenden Sie den SFC 11 (DPSYC_FR) zur Synchronisation der DP-Slaves.

SYNC Control Command

The DP master uses the SYNC control command for a group of DP slaves to freeze the states of their outputs at their current values.

In the following frames, the DP slaves store the output data of the DP master, but the states of the DP slaves' outputs remain unchanged.

After every new SYNC control command, the DP slave sets its outputs to the values that it stored as output data of the DP master.

The outputs are only then cyclically updated again when the DP master sends the UNSYNC control command.

FREEZE Control Command

After receiving the FREEZE control command from the DP master, the DP slaves of a group freeze the current state of their inputs and transfer these cyclically to the DP master.

After every new FREEZE control command, the DP slave freezes the states of their inputs again.

The input data are only then cyclically transferred from the DP slave to the DP master when the DP master sends the UNFREEZE control command.

3.6 Other DP Slave Configurations

3.6.1 ET 200L and DP/AS-i Link

When configuring the DP slaves ET 200L and DP/AS-i Link (distributed I/O/actuator-sensor interface), the following applies:

- ET 200L can be expanded using Smart Connect (SC) a channel at a time
- DP/AS-i Link is configured with actuator-sensor interface slaves; see below.

When placing a DP/AS-i Link, a configuration table is displayed automatically in which you can place the actuator-sensor interface slaves from the "Hardware Catalog" window.

3.6.2 ET 200S

Introduction

DP slaves and IO devices of the ET 200S family are configured like other modular DP slaves and IO devices.

Special feature: Digital electronic modules with an address space of 2 bits initially occupy 1 byte when they are inserted in the configuration table (Details view). However, the occupied address space can be compressed after configuration by means of the Pack Addresses button.

Example:

	Before Packing Addresses	After Packing Addresses
Module	I Address	I Address
DI_1_Module	10.0 to 10.1	10.0 to 10.1
DI_2_Module	11.0 to 11.1	10.2 to 10.3

Note

Addresses cannot be packed in the GSD-based variant of the ET 200S IO device. In the HW catalog, use the variant that does not have a reference to a GSD file (*.XML) in its info text.

Procedure: "Packing" Address Spaces Together

1. Select **one** contiguous range of modules whose addresses are to be packed.
2. In the Details view of the configuration table, click on the Pack Addresses button.

The address areas for inputs, outputs, and motor starters are packed separately.

- The beginning of the address area is defined by the address of each module that is selected first and has the form X.0.
- If the bit address is not 0, the next (available) byte address from which the selected area can be inserted is used automatically, for example, (X+1).0.
- If there is no other contiguous range, packing takes place automatically into available address spaces.

Undoing Address Packing

If you want to set the start address of a module with a "packed" address again as a byte address, proceed as follows:

1. Select the module with the packed address (e.g. 100.2).
2. Click the "Pack Addresses" button.

The start address of the module will be set to the next free byte address (e.g. 101.0, if this address is still free).

Special considerations for modules with packed addresses

When a module has a packed address, it can no longer be assigned a slot from the point of view of the CPU. For this reason SFC 5 (GADR_LGC) reports the error message W#16#8099 (slot not configured) for the actual slot of the module.

SFC 49 (LGC_GADR) and SZL-ID W#16#xy91 (module status information) are also incapable of evaluating a module with packed addresses.

From the point of view of the CPU, interrupts can also not be assigned for a module with packed addresses. Therefore, in DPV1 mode an additional diagnostic address is automatically assigned for the module.

The features "Pack addresses" and "Plug/remove interrupt" are mutually exclusively.

Rules for Configuring an ET 200S

- Slot 1: Only power module (PM-E or PM-D)
- To the left of an electronic module (EM): only an EM or a power module (PM-E or PM-D)
- To the left of a motor starter (MS): only an MS or PM-D or a power module (PM-D Fx (1..x..4) or PM-X)
- To the left of a PM-X: only a motor starter or a PM-D
- You must pay attention to the assignment of the PM-E voltage range and the EM voltage range.
- A maximum of 63 modules and one interface module are permitted.

Special Features of Assigning Parameters to Reference Junctions

Note the following sequence:

1. In the configuration table (Details view) of the ET 200S: place an analog electronic module and set a channel for the reference junction function to the measuring range "RTD-4L Pt 100 Cl."
2. Double-click the ET 200S (properties of the DP slave interface connection): specify reference junction(s), slot and channel of the RTD module
3. Place an analog electronic module for measuring temperature by means of thermocouple (TC module) and assign the reference junction number (of the RTD module) as parameter.

3.6.3 ET 200S with Option Handling

Requirements for Option Handling

- Power submodule: PM-E DC 24V/AC120/230V or PM-E DC 24..48V/AC 120..230V with option handling (as of STEP 7 V5.3)
- Interface submodule: IM 151-1 STANDARD (6ES7 151-1AA03-0AB0) or IM 151-1 FO STANDARD (6ES7 151-1AB02-0AB0)

Overview of the Procedure

Option handling allows you to prepare the ET 200S for future expansions (options).

The following section provides overview of the function and procedure (for a detailed description, see the *ET 200S Distributed I/O* manual):

1. Install, wire, configure and program the **planned** maximum configuration for ET 200S.
2. Instead of using the electronic submodules that will be required later, use economical RESERVE submodules (138-4AA00 or 138-4AA10) for the first installation. The ET 200S can be completely prewired ("master wiring") because a RESERVE submodule is not connected to the terminals of the terminal submodule and thus is not involved in the process.
3. For those slots that will first be fitted with RESERVE submodules instead of electronic submodules, enable option handling (in the property sheet for the IM 151-1 STANDARD, go to the "Option Handling" tab).
4. In the property sheet for the power submodule, reserve the required address space in the process image output table (PIQ) and the process image input table (PII) for the control and feedback interface by enabling option handling.
5. Later on, you can replace the RESERVE submodules with the configured submodules without having to repeat the configuration procedure.

Rules

Option handling may be enabled for exactly **one** PM E-DC24..48V or PM EDC24..48V/AC24.. power submodule.

Functionality: Option Handling During Start-up

If "Startup when defined and actual configuration differ" is disabled, then the ET 200S will also start up if a RESERVE module is inserted instead of the configured electronic submodule and option handling is enabled for the slot.

Functionality: Option Handling During Operation

- Option handling is enabled for a slot:
The slot may have the RESERVE submodule (option) or the configured electronic submodule inserted in it. If another submodule is detected in this slot, a diagnostic message is triggered (no submodule, incorrect submodule).
- Option handling is disabled for a slot:
The slot may only have the configured electronic submodule inserted in it. If another submodule is detected in this slot, a diagnostic message is triggered (no submodule, incorrect submodule).

Substitute Values for the RESERVE submodule

Substitute value for digital inputs: 0

Substitute value for analog inputs: 0x7FFF

Modifying and Evaluating in the User Program

The ET 200S has a control and feedback interface for the "option handling" function.

The modifying interface is in the process image output table (PIQ). Each bit in this address area modifies one of the slots 2 to 63:

- Bit value = 0: The option handling parameters apply. RESERVE submodules are permitted.
- Bit value = 1: The option handling parameters do not apply. RESERVE submodules are not accepted in this slot:

The feedback interface is in the process image input table (PII). Each bit in this address area provides information about what submodule is actually inserted in slots 2 to 63:

- Bit value = 0: The slot contains the RESERVE submodule, an incorrect submodule or no submodule (submodule removed).
- Bit value = 1: The slot contains the configured submodule.

The addresses of these interfaces are reserved as soon as option handling is enabled in the power submodule ("Addresses" tab).

Please note that the option handling function must also be enabled in the DP slave (interface module IM 151-1 STANDARD). If it is not enabled, the address reserved for the control and feedback interface will be released again! Repeated enabling and disabling of option handling may change the address of the control and feedback interface.

For more information on the assignment and meaning the bytes in the process image, see the *ET 200S Distributed I/O* manual.

3.6.4 ET 200S in DPV1 Mode

DPV1 functions provide you with extended functions such as interrupts. You can assign parameters to these functions with the respective DP interface module IM 151.

To be able to set the DPV1 mode, the DP master interface must also be set to the DPV1 mode.

Procedure

1. Configure a station with a DP master that supports DPV1 (such as a CPU S7-41x DP with firmware version 3.0) and the respective ET 200S (IM 151).
The DP interface for the DP master is set to DPV1 mode.
2. Double-click the DP slave icon (IM 151).
3. Click the "Operating Parameters" tab.
This register contains additional parameters such as DP Interrupt Mode and DPV1 Interrupts.
4. Set the parameters.

Special Features:

There are certain dependencies among the parameters, which are shown in the following table:

Parameter	DPV0 Mode	DPV1 Mode
Operation with expected <> actual configuration	No operational restrictions	No operational restrictions
Diagnostic interrupt	Not operational, not set	No operational restrictions
Hardware interrupt	Not operational, not set	No operational restrictions
Insert/remove interrupt	Not operational, not set	No operational restrictions If insert/remove interrupt is activated, 'Start-up with expected <> actual configuration' is activated automatically.
		Only operational if addresses are not packed

Interrupts for Modules with Packed Addresses

If the submodule can trigger interrupts and its addresses are packed (that is, it has a bit address not equal to 0), then you must use the ET 200S address dialog to assign a dialog address.

The diagnostic address is essential to assigning a DPV1 interrupt to the submodule as the interrupt trigger. Only when a submodule has this "unpacked address" can the CPU assign an interrupt and store information about the interrupt in the start information for the interrupt OB or in the diagnostic buffer. The CPU cannot use a "packed" address to do this.

This diagnostic address assigned to the submodule is only valid for interrupt processing (interrupt OB). For processing input and output data in the user program, the submodule still has the packed addresses.

Note

If the submodule addresses are packed, then the insert/remove interrupt for the ET 200S is also disabled!

3.6.5 ET 200iS

You can either configure ET 200iS and its electronic modules in the HW Config or conveniently do so with the SIMATIC PDM option package. The respective system requirements and procedure are described below:

Configuration

System Requirement

STEP 7 as of version 5.1, SP 2, Hotfix 1 or PCS7 as of version 5.2.

In this case, ET 200iS is in the STEP 7 hardware catalog. Diagnostic interrupts, process interrupts, inserting and removing interrupts and time stamps are supported.

Configuring the ET 200iS

1. Start the SIMATIC Manager.
2. Configure ET 200iS with HW Config.
 - Create new project.
 - Drag and drop the module from the hardware catalog to the configuration table.
3. Configure the time stamping (optional).
4. Save or download the configuration to the DP master.

Assigning Parameters

System Requirements

STEP 7 as of version 5.1, SP 2, Hotfix 1 and SIMATIC PDM optional package as of version 5.1, SP 2 or PCS7 as of version 5.2.

To be able to work with PDM online, you require a PROFIBUS DP interface e.g. CP5611 (6GK1 561-1AA00). The CP has to be set at the PROFIBUS DP interface (in the SIMATIC Manager via: **Extras > Setting the PG/PC Interface**).

Assigning Parameters to the Electronic Module

1. In HW Config, double-click the first electronic module in the configuration table.
2. Select "Specialist" in the subsequent dialog box as user and confirm with "OK"; you can assign parameters in this mode.
3. SIMATIC PDM is started with the current parameters and identification data of the module.
4. Set the parameters of the electronic module using the SIMATIC PDM, save the parameters (via **File > Save** menu command) and load them via the **Device > Load Into Device** menu command into the electronic module; exit SIMATIC PDM.
5. Double-click the next electronic module in the configuration table and repeat steps 2 and 3 until you have configured all electronic modules.

Assigning Parameters to the Interface Module.

1. In HW Config, double-click on DP slave "IM 151-2" (in the upper part of the station window). Select "Specialist" in the subsequent window; SIMATIC PDM is started.
2. Set the parameters of the IM 151-2 interface module, save the parameters (via **File > Save** menu command) and download the parameters into the interface module via the **Device > Load Into Device** menu command; exit SIMATIC PDM.

Assigning Parameters to all ET 200iS modules.

1. In HW Config, double-click on DP slave "IM 151-2" (in the upper part of the station window). Select "Specialist" in the subsequent window; SIMATIC PDM is started and all ET 200iS modules are loaded.
2. Download all module parameters (via the **File > Load into Programming Device/PC** menu command).
3. Assign parameters to all necessary modules. You can navigate to all ET 200iS modules from the left panel of SIMATIC PDM.
4. Save the changes (via **File > Save** menu command) for the file to be updated.
5. Load all parameters into the modules (via **Device > Load into Device** menu command); exit SIMATIC PDM.

You can also parameterize ET 200iS only with SIMATIC PDM (For more information, see the SIMATIC PDM online Help.)

3.6.6 PROFIBUS PA

In order to configure field devices for the PROFIBUS PA (PROFIBUS for Process Automation), you should note the following:

DP/PA Coupler

You **cannot** configure the DP/PA coupler in Hardware Configuration, because it is "invisible" in the station configuration. You only have to set the transmission rate for the PROFIBUS subnet to 45.45 Kbps in the properties dialog box of the PROFIBUS interface of the DP master or DP slave. The coupler reduces the transmission rate to 31.25 Kbps for the PA field devices.

DP/PA Link

The DP/PA link is a gateway between PROFIBUS DP and PROFIBUS PA. The DP/PA link is a DP slave, which for its part (acting as a kind of "master") "opens" a PROFIBUS PA for connecting PROFIBUS PA devices.

The device can be assigned to a DP master system as a DP slave from the "Hardware Catalog" window.

The representation of the DP/PA link also incorporates a symbol for the PA master system as well as the device symbol itself - this is similar to the DP master system. You can assign PA field devices (PA slaves) to this symbol.

The PROFIBUS PA must be running at a transmission rate of 45.45 Kbps when you connect PA devices.

Procedure for Configuring the DP/PA Link

1. Install the optional software SIMATIC PDM (PDM=Process Device Manager); this will enable you to configure the PA slaves from the "Hardware Catalog" window at a later stage.
2. Configure a DP master system.
3. Drag the DP/PA link (IM 157) from the "Hardware Catalog" window to the DP master system.
4. Select the DP/PA link; the DP slave structure will be displayed in the lower half of the station window.
5. Slot 2 represents the master for the PA devices (PA master); double-click slot 2 to configure the PROFIBUS PA.
6. Click the "Properties" button (under "Interface") and then select the subnet with the transmission rate of 45.45 Kbps.
7. Then configure the PA devices.
You will find the PA devices in the "Hardware Catalog" window under "PROFIBUS-PA". This entry can only be seen if the SIMATIC PDM optional software package is installed.

3.6.7 HART Modules

HART modules are analog modules to which HART transducers can be connected (HART=Highway Addressable Remote Transducer).

HART modules are required for distributed use with the IM 153-2 (ET 200M).

To **assign parameters to the HART transducers**, start the parameter assignment tool SIMATIC PDM

Requirement:

SIMATIC PDM is installed on the programming device/PC.

Representing HART Measuring Transducers

The transducers for HART modules are represented as interface submodules in the configuration table.

Example: The module is located in slot 4. The transducer for the first channel is then represented as slot 4.1.

To start SIMATIC PDM:

- Double-click one of the "slots" for HART transducers.

As you can also use the SIMATIC PDM tool for assigning parameters to PROFIBUS-PA field devices, you can start it as follows:

- Assign a PA field device to a PA master system by dragging & dropping it from the "Hardware Catalog" window, and then double-click this PA field device.

3.6.8 Configuring Software Redundancy

The configuration of a "warm standby" system consists of:

- Two S7 stations with one PROFIBUS-DP master interface each (each of these interfaces forms its **own subnet**)
- One or more slaves with the property "can be used redundantly with active backplane bus" (e.g. ET 200Ms with IM 153-3) which are connected to **both** subnets.

This configuration guarantees that the standby station is able to take over the processing of the user program if one station (this is, one of the two DP masters) fails. The slaves that are connected to both stations are then controlled by the reserve station.

Concept Behind Configuring Software Redundancy

With SW redundancy, each of individual stations does not provide any indication that it is being operated together with another station. The coordination of the redundant stations is up to the user and is not, in contrast to H stations, not supported by the system

The ET 200M, which physically is only present once, is configured as two identical S7 stations (same modules, identical addresses, identical settings). To perform this configuration, go to HW Config and select the **Edit > Insert Redundant** menu command.

Configuring SW Redundancy with DP/PA Links

Since, with SW redundancy, each of individual stations does not provide any indication that it is being operated redundantly, the DP/PA Link must be informed of this condition. To do this, select the "Software redundancy (SWR) activated for the slave" check box in the "Redundancy" tab of the DP/PA link. This setting ensures that the PA slaves will automatically start again when the controlling CPU initiates a switchover. The prerequisites required to ensure a smooth switchover of the slaves are checked and, if necessary, adapted to the DP mode (DPV1, DPV0).

Special Case for IM 153-2 as of V4

Depending on how the IM 153-2 interface module is structured, it will function as a "normal" ET 200M with modules from the S7-300 range of peripherals or as a DP/PA link.

IM 153-2 V4 as a DP/PA Link (as of STEP 7 V5.4)

If the IM 153-2 is structure with suitable bus submodules, it will automatically function as a "DP/PA link". To connect it to a PROFIBUS PA, you must first insert a DP/PA couplers into the bus submodules.

Since the bus submodules are not being configured, STEP 7 must be informed in other way about how the IM 153-2 functions. You make this functional decision when selecting the IM 153-2 in the Hardware Catalog. The IM, with its different variants (standard, outdoor, FO), is listed twice in the Hardware Catalog:

- As IM 153-2 under "ET 200M"
- As IM 153-2 under "DP/PA Link"

An ET 200M (IM 153-2 as of V4) can likewise be copied and redundantly inserted along with its subordinate PA slaves.

Procedure

1. Configure the first station completely with all ET 200Ms (IM 153-3) or with DP/PA links.
For a DP/PA link also specify that it is to be operated redundantly as follows:
 - Double-click the "DP/PA Link"
 - Select the "Redundancy" tab and then select the "Software redundancy (SWR) activated for the slave" check box
 - Confirm your setting with "OK".
2. Configure the second station without the ET 200Ms or without DP PA links.
3. Select the slaves in the first station, select the master system in the second station, and insert these slaves in the DP master system of the second station (menu command: **Edit > Insert Redundant**).

Note

The DP slaves must be configured in each of the two stations, which means they appear as two separate objects - although they are physically one and the same DP slave. If you change the settings for one of the ET 200M DP slaves, you must also **copy** this modified DP slave to the other station **again** to ensure consistency.

Sample Configuration

The illustration below shows the two stations. The DP/PA link is redundantly inserted along with its subordinate PA slaves. In NetPro, the DP/PA link is only shown once (which corresponds to the actual, real configuration); nevertheless, the subordinate PA slaves along with the associated PROFIBUS PA are shown twice (which does not correspond to the actual, real configuration).

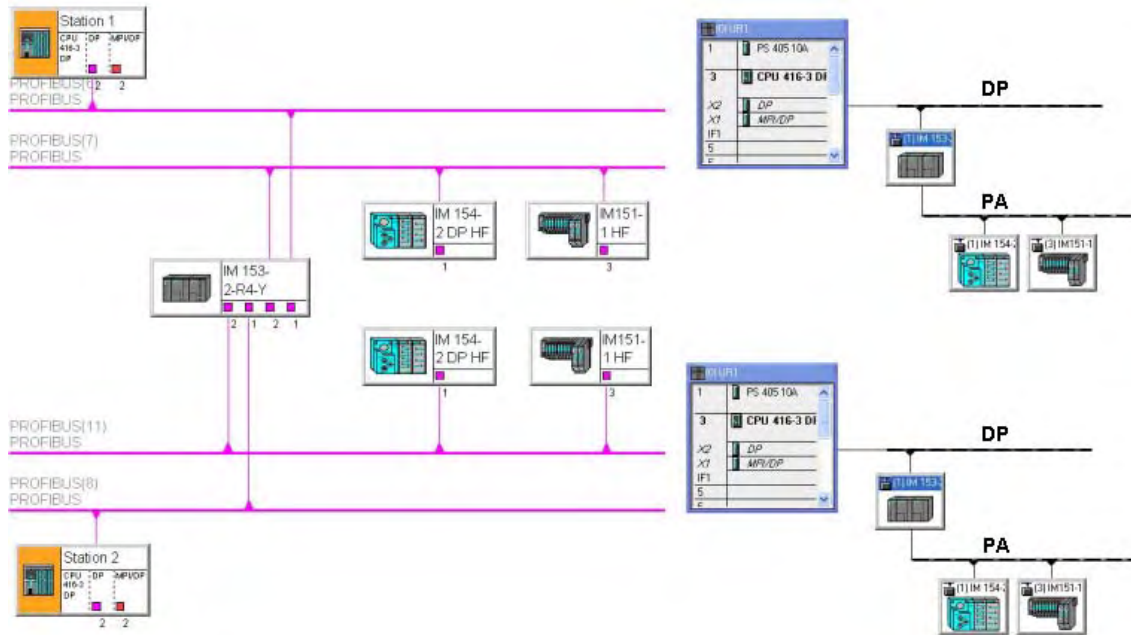

3.7 Intelligent DP Slaves

3.7.1 Configuring Intelligent DP Slaves

An intelligent DP slave does not directly provide the DP master with input and output data from a real input or output, but rather from the CPU which, together with the CP, makes up the DP slave.

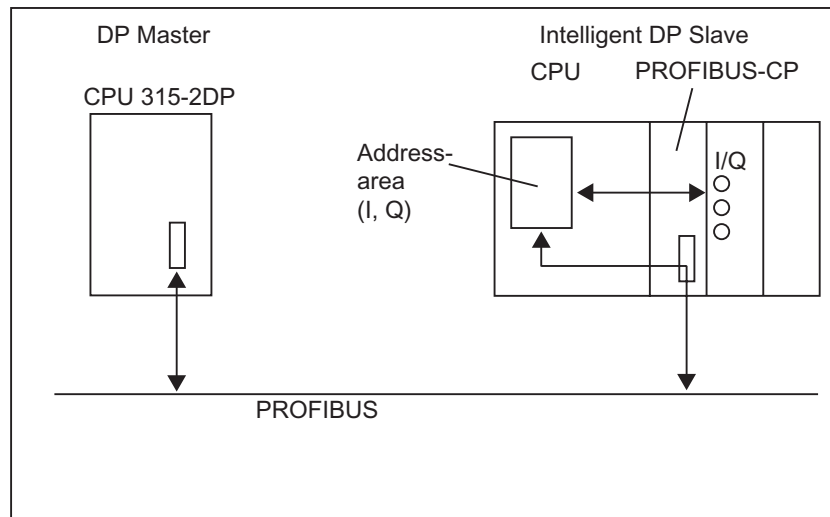

Difference: "Normal" DP Slave - Intelligent DP Slave

In a "normal" DP slave such as a compact (ET 200B) or modular (ET 200M) DP slave, the DP master accesses the distributed inputs/outputs.

In an intelligent DP slave, the DP master does not access the connected inputs/outputs of the intelligent DP slave, but accesses a transitional area in the input/output address space of the "preprocessing CPU." The user program for the preprocessing CPU must take care of data exchange between the address area and the inputs/outputs.

Note

The configured input/output areas for data exchange between master and slaves must not be "occupied" by I/O modules.

Applications

Configurations with intelligent DP slaves:

- Data Exchange Intelligent Slave <> Master
- Direct Data Exchange Slave > Intelligent Slave

Basic Procedure

Two steps are required to insert an intelligent DP slave into a DP master system:

1. Configure a station in which a module with a PROFIBUS-DP interface is being operated as a DP slave (such as a CPU 316-2 DP).

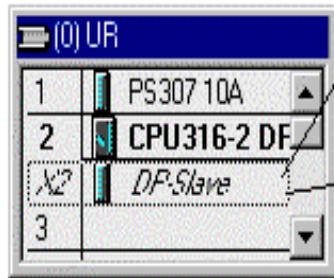

"Operating Mode" tab
Set the DP-Slave operating mode. Then you can use this station as an I slave

"Configuration" tab
All the following settings are possible if the station is being operated as a DP slave.

1. Addresses that the CPU of the DP uses to access the DP master are assigned in the column with the name the DP slave.
2. Addresses that the CPU of the DP master uses to access the DP slave are assigned in the PROFIBUS-DP Partner column.
3. You can diagnose the failure of the master by means of the local diagnose address.

2. Configure an additional station in which this DP slave (I slave) is assigned (that is, is connected) to a DP master.



"Connection" tab
Assignment of a station configured as a slave to this I slave.

"Configuration" tab
1. Addresses that the CPU of the DP uses to access the DP master are assigned in the column with the name of the DP slave.
2. Addresses that the CPU of the DP master uses to access the DP slave are assigned in the PROFIBUS-DP partner column.

Configuring the CP 342-5 as a DP Slave

The CP 342-5 can be configured for operation as a DP slave. The station in which the CP was configured is then an "intelligent slave."

Procedure

1. Configure a station with the CP 342-5 DP as DP slave.
(Select the option "DP slave" in the "Operating Mode" tab of the CP.)
2. Configure a DP master (CPU with integrated PROFIBUS-DP interface or CP with PROFIBUS-DP interface) in another station.
3. Drag the CP 342-5 from the "Hardware Catalog" window (**Configured Stations** folder) and drop it onto the symbol for the DP master system ().
A dialog box appears in which you can select configured intelligent DP slaves.
4. Confirm your selection with "OK."
5. Configure the DP IDs and addresses for the input and output areas in the displayed configuration table for the DP slave. To do this, drag and drop the "Universal Module" from the "Hardware Catalog" window (**Configured Stations** folder) into the configuration table (lower half of the station window) and then double-click the corresponding row.

Note

Data exchange between a "preprocessing CPU" and a CP 342-5 DP within the DP slave is described in the SIMATIC NCM documentation.

Configuring the CPU 31X-2 DP or CPU 41X-..DP as a DP Slave

CPUs with integrated DP interface (such as CPU 315-2 DP) can be configured for operation as a DP slave. The station in which the CPU was configured is then the "intelligent slave."

The procedure for a CPU 315-2 DP is described below. The procedure is always the same, save for the selection of the CPU type (also refer to Example for the Configuration of an S7-400 as I-Slave).

Procedure

1. Configure a station, for example, with the CPU 315-2 DP as DP slave.
(Double-click the row 2.1 (interface) in the configuration table and select the DP Slave option in the "Operating Mode" tab.)

You can set the local I/O addresses and the diagnostic address in the "Configuration" tab.
2. Configure a DP master (CPU with integrated PROFIBUS-DP interface or CP with PROFIBUS-DP interface) in another station.
3. Drag the CPU, for example the 315-2 DP, from the "Hardware Catalog" window (**Configured Stations** folder) and drop it onto the symbol for the DP master system (.
4. Double-click the symbol for the intelligent DP slave and select the "Connection" tab. In this tab you determine which station should represent the intelligent DP slave here.
5. Select the intelligent DP slave and click the "Connect" button.
6. Select the "Configuration" tab and assign the addresses to each other:
 - For data exchange with the DP master by means of the I/O areas, select the "MS" (master-slave) mode.
 - For direct data exchange with a DP slave or DP master, select the "DX" (direct data exchange) mode.
7. Confirm your entries with "OK."

Configuring the ET 200X (BM 147/CPU) as a DP Slave

The BM 147/CPU basic submodule is configured like an intelligent DP slave. In contrast to other intelligent DP slaves, the basic submodule can be found in the "Hardware Catalog" window under PROFIBUS-DP/ET 200X/BM147/CPU.

Procedure

1. Configure the DP slave ET 200X (with BM 147/CPU) as an S7-300 station.
 - Create a new station of the type **S7-300** (menu command **Station > New**).
 - Select the directory PROFIBUS-DP/ET 200X/BM147/CPU in the "Hardware Catalog" window.
 - Drag & drop the object "BM 147/CPU" to the empty station window.
 - Configure the DP slave with the required I/O expansion submodules.
 - Save the station (the intelligent DP slave).
2. Configure a DP master (CPU with integrated PROFIBUS-DP interface or CP with PROFIBUS-DP interface) in another station.

3. Drag the DP slave ET 200X (with BM 147/CPU) from the "Hardware Catalog" window (**Configured Stations** folder) and drop it onto the DP master system symbol (.
4. Double-click the symbol for the intelligent DP slave and select the "Connection" tab. In this tab, you can assign the station that is to represent the intelligent DP slave.
5. Select the intelligent DP slave and click the "Connect" button.
6. Select the "Configuration" tab and assign the addresses to each other.
7. Confirm your entries with "OK."

Configuring the ET 200S (IM 151/CPU) as a DP Slave

The IM 1151/CPU is configured like an intelligent DP slave. In contrast to other intelligent DP slaves, this DP slave can be found in the Hardware Catalog window under PROFIBUS DP/ET 200S/IM 151/CPU.

Procedure

1. Configure the DP slave ET 200S (with IM 151/CPU) as an S7-300 station.
 - Create a new station of the type **S7-300** (menu command **Station > New**).
 - Select the directory PROFIBUS-DP/ET 200S/IM151/CPU in the Hardware Catalog window.
 - Drag & drop the object IM 151/CPU to the empty station window.
 - Configure the DP slave with the required I/O electronic modules.
 - Save the station (the intelligent DP slave).
2. Configure a DP master (CPU with integrated PROFIBUS DP interface or CP with PROFIBUS DP interface) in another station.
3. Drag the DP slave ET 200S (with IM 151/CPU) from the "Hardware Catalog" window (**Configured Stations** folder) and drop it onto the DP master system symbol (.
4. Double-click the symbol for the intelligent DP slave and select the Connection tab. In this tab, you can assign the station that is to represent the intelligent DP slave.
5. Select the intelligent DP slave and click the Connect button.
6. Select the Configuration tab and assign the addresses to each other.
7. Confirm your entries with OK.

3.7.2 Example of Configuring an S7-400 as I-Slave

Below we shall create the following configuration:

- Master Station (Name "DP Master") with CPU 417-4 as DP Master (DPV1). S7-400-CPU's with integrated DP interface can only be customized as DPV1 Master as of Firmware Version 3.0.
- Slave Station (Name "DP Slave") with CPU 414-3 DP as DP I-Slave

As usual for the configuration of intelligent DP Slaves, proceed with the following steps:

Step	Procedure	Explanation
1	Creating the Master Station with the CPU 417-4. Name: DP Master	The PROFIBUS address should be 2.
2	Creating the Slave Station with the CPU 414-3 DP. Name: DP Slave.	The operating mode of the DP interface of the CPU 414-3 DP must be set to "DP Slave". The PROFIBUS address should be 3.
3	Filling out the first row in the "Configuration" tab of the slave station. To create new line, click on the "New" button	If this line is not filled out, the data will be inconsistent. In the properties dialog, select the "MS" (master-slave) mode and apply the default settings.
4	Inserting the DP I-Slaves into the Master Station from the folder "Configured Stations".	From the hardware catalog under PROFIBUS DP select a CPU 41x from the folder "Configured Stations" and drag-and-drop this "Representative" symbol for the DP Slave station created to the DP Master System.
5	Coupling the inserted DP I-Slaves to the configured Slave Station.	Coupling is prerequisite for assigning the "Representative" symbol to the configured station, or for assigning the DP Slave inputs to the DP-Master outputs and vice versa.

Arrange the Master Station and Slave Station configuration to view them side-by-side. The result is shown in the screenshot below:

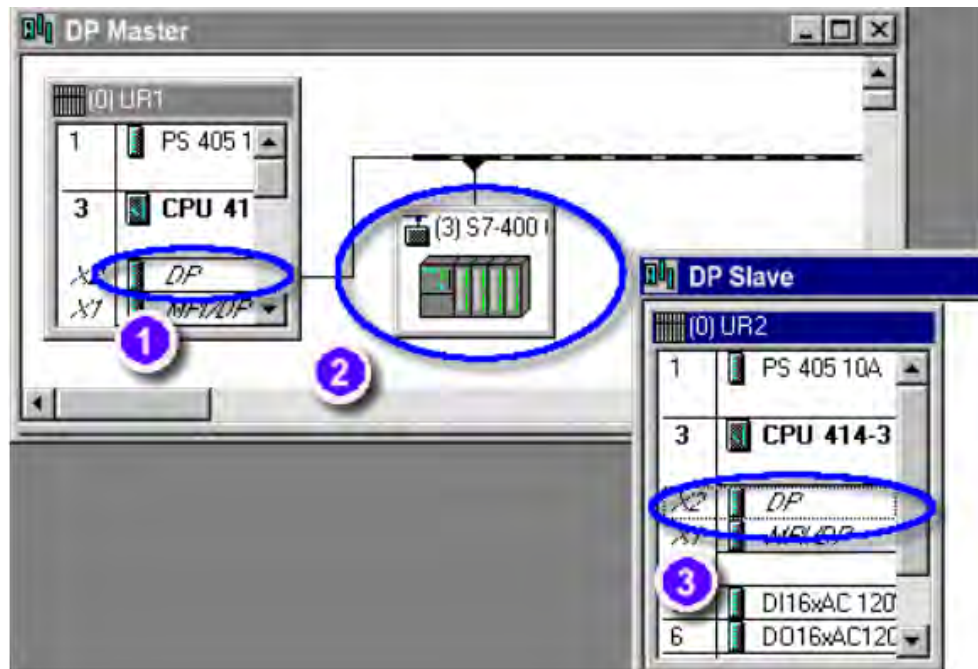

How to Assign Addresses

Step	Procedure	Explanation
1	A double-click on the DP interface of the DP Master in the Master Station opens a dialog and a number of tabs	<p>"General" tab: Name of the interface and PROFIBUS address with network assignment. The PROFIBUS address should be set to 2.</p> <p>"Address" tab: Logic address of the DP interface (system messages identify the interface via this address).</p> <p>"Operating mode" tab: The option "DP Master" must be selected. Also, DP mode "DPV1" must be set. The other tab contents are not relevant for this example.</p>
2	A double-click on the DP Slave symbol in the Master Station opens a dialog with several tabs	<p>"General" tab: Editable designation of the DP Slave symbols and diagnostic address(es). Here, two diagnostic addresses are assigned to a DPV1 Master: The first diagnostic address is assigned to the virtual slot 0 of the DP Slave. Via this address the DP Master receives diagnostic data and/or interrupts that are not assigned to a DP Slave slot. In our example, this is the address 16381. The second diagnostic address is assigned to the virtual slot 2 of the DP Slave. Via this address the DP Master receives diagnostics or interrupts that are assigned to the DP interface. In our example, this is the address 16380. (Also refer to the section "DP Slave from the view of the DP Master").</p> <p>"Coupling" tab: Assigning the DP Slave symbol in the Master station to the configured Slave station. Once the assignment is made, the designation of the configured Slave station appears in the lower section of the tab under "Active Coupling".</p> <p>"Configuration" tab: Assignment of I/O areas for the data exchange between the Master station and the Slave station. Double-click the first line, and in the dialog that is displayed, fill out the fields completely.</p>
3	A double-click on the DP Slave interface in the Slave station opens a dialog that contains a number of tabs	<p>"General" tab: Name of the interface and PROFIBUS address with network assignment. The PROFIBUS address should be set to 3.</p> <p>"Address" tab: Logical address of the DP interface (the system messages reference the interface via this address).</p> <p>"Operating mode" tab: The option "DP-Slave" must be selected. Actuate the checkbox "Programming and Status/Control..." if a PG/PC is connected to the same PROFIBUS and if, for example, you want to download programs using this path. A Diagnostic address is visible. This address can be used by the intelligent DP slave to diagnose conditions such as a failure of the DP-Master. An "Address for the virtual slot 2" is only visible if the DP Master supports the "DPV1" mode and if this mode is set. This address can be used in the DP Slave user program to generate a hardware interrupt in the DP Master</p>

Step	Procedure	Explanation
		<p>(also refer to the section "DP Master from the view of the DP Slave ").</p> <p>DP mode: Here, DPV1 should also be selected if "DPV1" mode is set for the DP Master. Otherwise, the "Address for the virtual slot 2" cannot be selected.</p> <p>"Configuration" tab:</p> <p>For the meaning of this tab refer to </p> <p>Difference: The "Local: ..." column can be edited, even if the intelligent DP Slave has not yet been assigned to a DP Master (refer to the "Coupling" tab).</p> <p>For our example all other tab contents are not relevant.</p>

DP Slave from the View of the DP Master

You can use the DP Master CPU user program to obtain DP Slave status information via the configured diagnostic address 16381 which is assigned to virtual slot 0 (Slot 0) of the DP Slave. Slot 0 is, subordinate to DPV1, representative for the entire Slave station. SFB 54 "RALRM", for example, uses the output parameter ID as a pointer to this address if an interrupt is triggered by this Slave and if this interrupt is not assigned to a slot. If the virtual slot 2 of this DP Slave triggers the interrupt (that is, the CPU section) it can be identified via diagnostic address 16380.

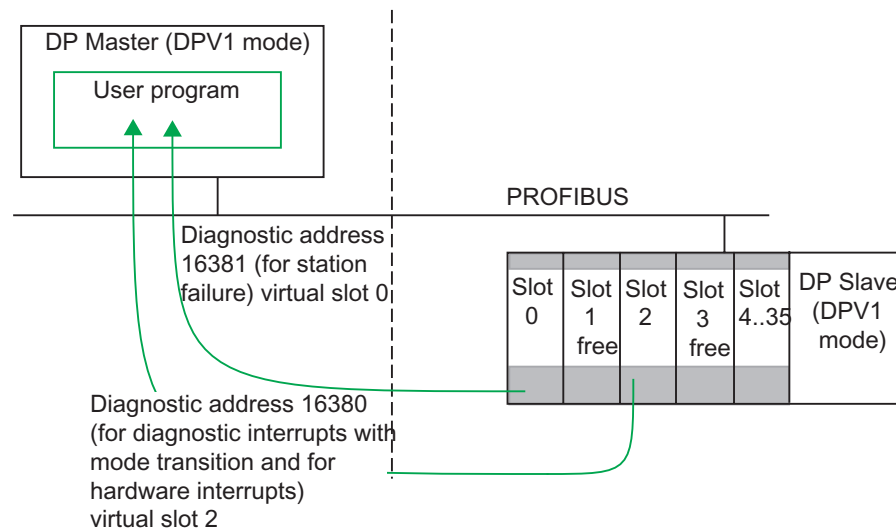

DP Master from the View of the DP-Slave

You can use the DP-Slave CPU user program, for example, to read DP Master failure information via the configured diagnostic address 8189.

If you have set the DP Slave to DPV1 mode you can, for example, trigger a Hardware Interrupt. Here, in the DP Slave user program you must utilize SFC 7 "DP_PRAL" to trigger the interrupt in the DP Master via the configurable address for the virtual slot 2 (Slot 2). This address is 8188 in our example. The sample below shows user program segments of the DP Slave that has triggered the hardware interrupt and user program segments of the DP Master that evaluate this interrupt.

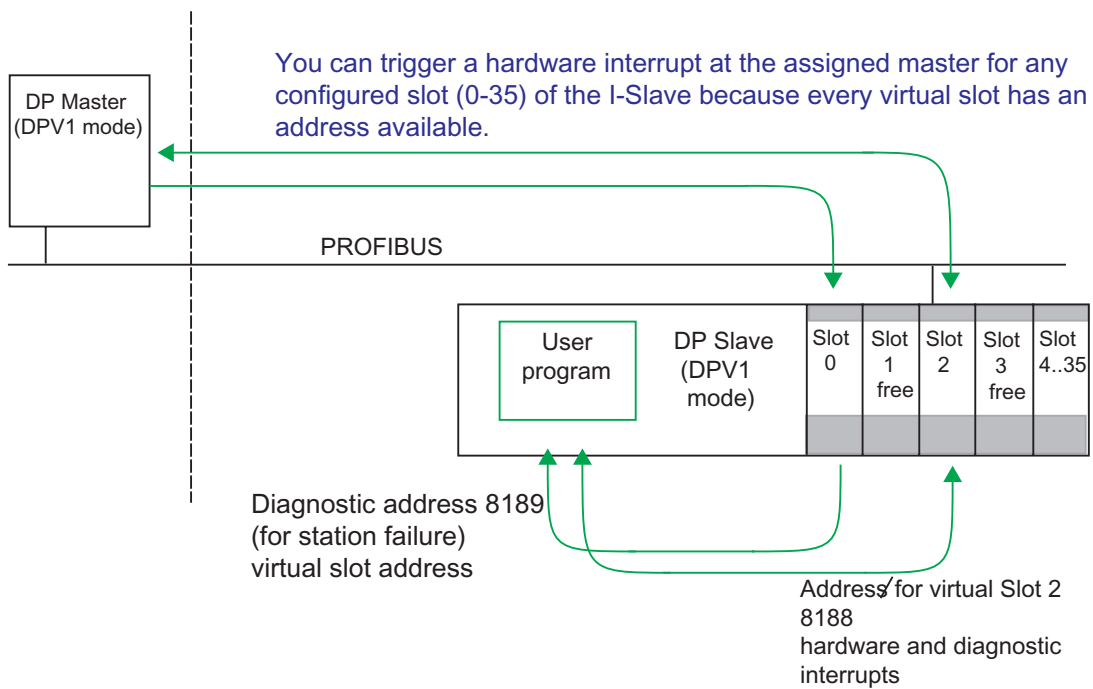

DP-Slave Program (in the I-Slave CPU) for Triggering a Hardware Interrupt

```
//
// ...
L   DW#16#F0F0      //Constant for the identification of the I-Slave event
                        //that triggered the Hardware Interrupt

T   MD 100

//...
CALL "DP_PRAL"
REQ  :=M1.0          //trigger Hardware Interrupt if REQ=1
IOID :=B#16#54       //Input area (configured address = E 8188)
LADDR :=W#16#8189   //Address (configured address = E 8188)
AL_INFO:=MD100      //MD 100 is an interrupt info directed towards the
                        //DP Master (can be read from the start info of
                        //OB 40 in the Master as OB40_POINT_ADDR)

RET_VAL:=MW10        //Return value (0000, if no error)
BUSY  :=M1.1         //If BUSY =1 the Hardware Interrupt is not yet
                        //acknowledged by the Master

// ...
```

DP Master Program (in the DP Master station CPU) for the Evaluation of a Hardware Interrupt

```
// ...
L   #OB40_POINT_ADDR //load interrupt info
L   DW#16#F0F0        //compare with the constant which the I-Slave has
                        //"passed on" when it generated the interrupt

==I                        //Interrupt info from I-Slave?

SPB m001              //if yes, jump to respective program segment
BEB

m001: CALL FC 100     //Program segment with interrupt processing
                        //for I-Slave

// ...
```

3.7.3 Creating an Alarm in the I Slave with SFB75 'SALRM'

Intelligent DP slaves with SFB 75 'SALRM' can trigger interrupts in their assigned DP master. The following table shows the possible types of interrupts depending on the DP mode setting:

Interrupt Type	DP Mode: S7-compatible?	DP Mode: DPV1
Diagnostic interrupt (OB 82)	Yes	Yes
Hardware interrupt (OB 40 to 47)	Yes	Yes
Insert/remove module interrupt (OB 83)	Yes (if the I slave supports this interrupt)	Yes
Status interrupt (OB 55)	No	Yes
Update interrupt (OB 56)	No	Yes
Vendor-specific interrupt (OB 57)	No	Yes

Addresses for triggering interrupts

You can use each address configured in the "Configuration" tab in the I slave configuration dialog to trigger interrupts using SFB 75. These addresses are not assigned to actual, "real" modules but to virtual "slots".

The addresses for "Slot" 0" (diagnostic address) and "Slot" 2 (Address for "Slot" 2) cannot be used to trigger interrupts.

Diagnostic address:	<input type="text" value="8189"/>
Address for "slot" 2:	<input type="text" value="8188"/>

Basic Method of Creating Interrupts

The basic procedure for creating an interrupt will be shown as it applies to a diagnostic interrupt.

- In the I slave, the output address 0 in the "Configuration" tab is assigned to a virtual slot.
- In the example, the output address 0 is used to trigger a diagnostic interrupt (OB 82) in the DP master.

For each diagnostic interrupt, data must also be input with the user program (AINFO). These data have to correspond to the basic structure for additional interrupt information.

For example, you can use the following simplified structure (a detailed description is available in the manual "System and Standard Functions for S7-300/400" in the chapter "Diagnostic Data"):

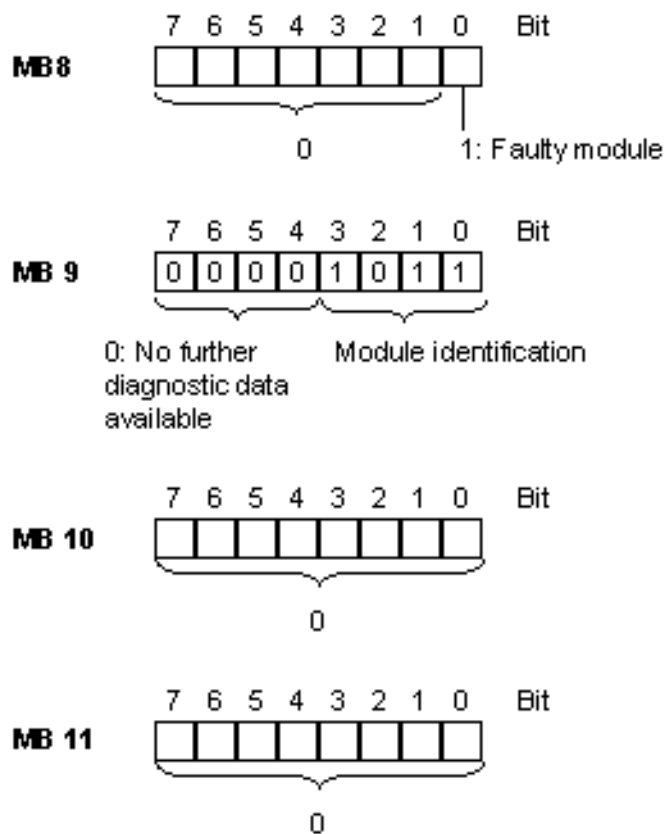

Note

The additional interrupt information has an influence on the module status data and the "SF" error LED at the I slave. Similarly, the interrupt also influences the module status data and the error LED at the DP master. For this reason, you must be sure to observe the meaning of the diagnostic data sets (data set 0 and data set 1) when providing data for additional information about the interrupt.

The procedure for creating the interrupt is shown in the following illustration:

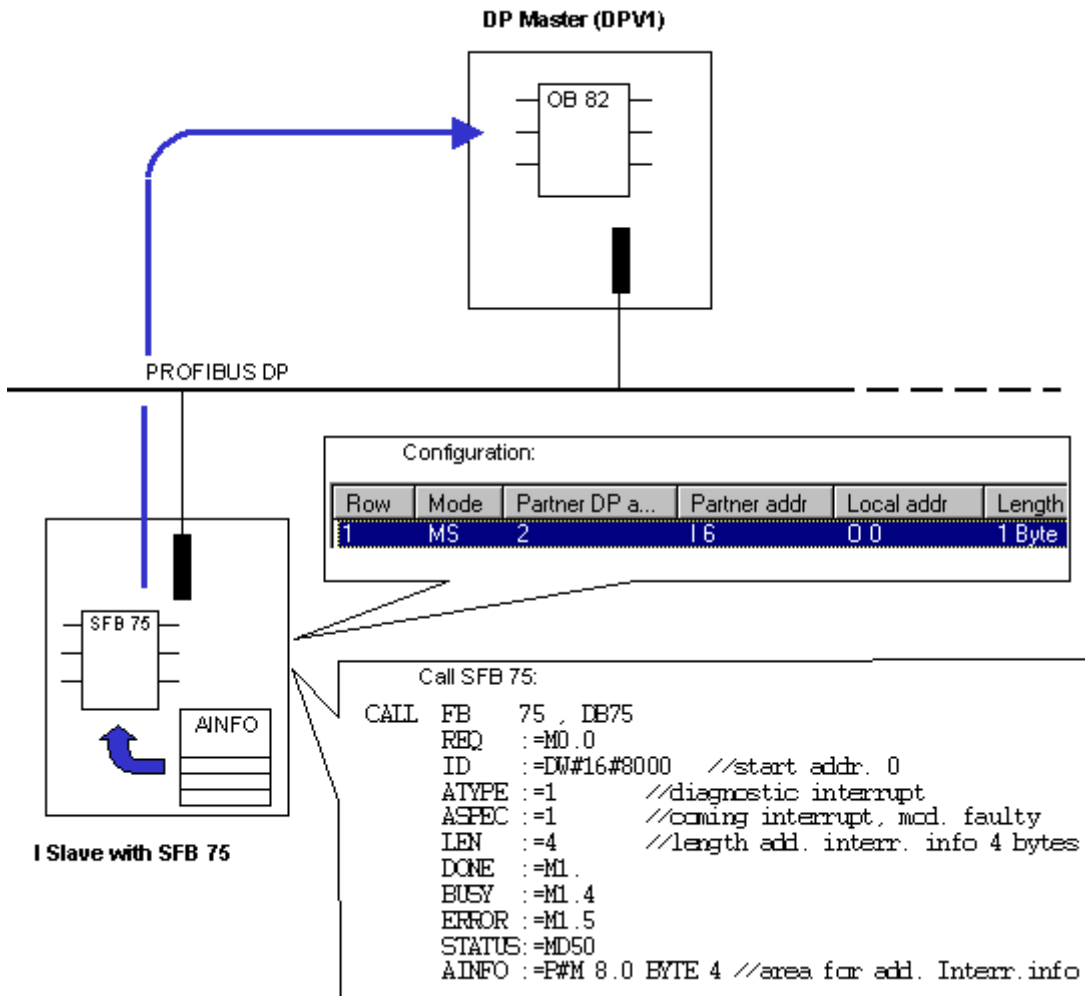

3.8 Direct Data Exchange (Lateral Communication)

3.8.1 Configuring Direct Data Exchange between PROFIBUS-DP Nodes

Introduction

In a configuration for direct data exchange (lateral communication), local input address areas of an intelligent DP slave or of a DP master are assigned to the input address areas of a PROFIBUS-DP partner.

The intelligent DP slave or the DP master uses these assigned input address areas to receive the input data that the PROFIBUS-DP partner sends to its DP master.

Number of PROFIBUS-DP Partner That Can Be Connected

The type of interface limits the total number of PROFIBUS-DP partners that are connected directly to a DP interface or are addressed over this interface by means of direct data exchange. A maximum of 32 PROFIBUS-DP partners can be addressed on the MPI/DP interface.

Applications

The following applications are possible for direct data exchange:

- Configuration with intelligent DP slaves (direct data exchange: slave -> intelligent slave)
- Configuration with two DP Master systems (data exchange: slave -> master)
- Configuration with two DP master systems (direct data exchange: slave -> intelligent slave)

Starting Configuration

1. Double-click the DP interface of the configured receiver (DP master or already configured I slave).
2. Select the "Configuration" tab.
3. To create new line in order to configure direct data exchange, click the "New" button.
4. In the dialog that appears, select "DX" mode and assign the input address areas to each other (you can find more information in the online help for this dialog).

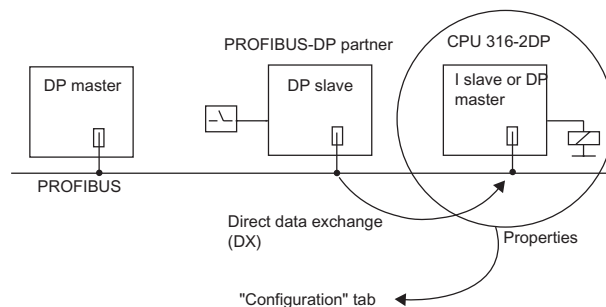

Contents of the "Configuration" tab

Row	Mode	Partner DP a...	Partner addr	Local addr	Length
1	MS	2	16	0 0	1 Byte

- **Mode:** "DX" for direct data exchange, ("MS" for master-slave)
- **Partner DP Addr.:** PROFIBUS address of the DP partner
- **Partner Addr.:** Address of the logically assigned address area (sender)
- **Local Addr.:** Address of the logically assigned address area (receiver)

For further information, see the online help for this tab.

3.8.2 Example of Configuring Direct Data Exchange

The configuration for the example is as follows:

- CPU 417-4 as DP master
- CPU 316-2 DP as receiver
- CPU 318-2 DP as publisher

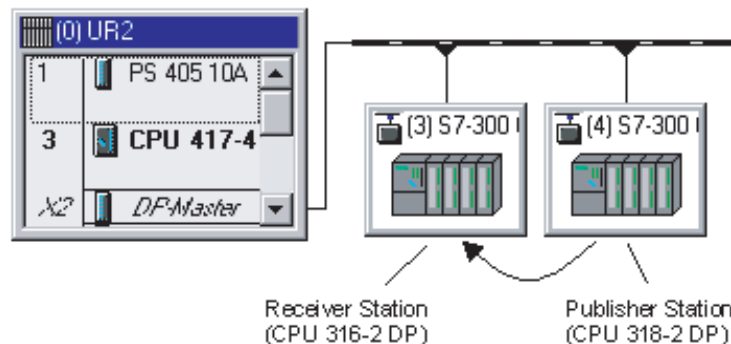

Task

CPU 318-2 DP sends 8 words of consistent data to the DP master.

CPU 316-2 DP receives the first two bytes of these data.

Procedure

1. Configure three stations, each with the CPUs listed. Then, assign meaningful names to them such as "DP master station", "receiver station", and "publisher station".
2. Configure the publisher and receiver station as intelligent slave:
 - Double-click the DP master row.
 - Select the Operating Mode tab.
 - Select the DP Slave option.
3. In the master station:
 - Drag the icon for CPU 31x 2-DP from the "Catalog" window (PROFIBUS-DP, "Already Configured Stations" folder) to the DP master system. The DP Slave Properties dialog box appears with the "Connection" tab.
 - Select a slave in the Configured Slave Controllers box and click the "Connect" button. Then confirm with "OK".
 - Repeat the procedure in order to connect the second station that was configured as an intelligent slave to the master system.

4. Configure the address area of the publisher station so that the DP master reads the data from the CPU 318-2 DP by means of the address I 200:
 - Double-click the DP slave row of the CPU 318-2 DP.
 - Select the "Configuration" tab and click the "New" button. Fill in the fields in the properties dialog as follows:

Publisher Station (local)	Mode = MS (master-slave) Address type = Output Address = 100
PROFIBUS-DP Partner	PROFIBUS address = 2 (fixed, PROFIBUS address of the DP master) Address type = Input Address = 200
Length, Unit, Consistency	Length = 8 Unit = Word Consistency = Entire length

5. Configure the address areas of the receiver:
 - Double-click the DP slave row of the CPU 316-2-DP.
 - Select the "Configuration" tab and click the "New" button. Fill in the fields in the properties dialog so that the CPU 316-2 uses the address I 120 to access the data of the CPU that the CPU 318-2 sends to its master:

Receiver Station (local)	Mode = DX (direct data exchange) Address type = Input (fixed) Address = 120
PROFIBUS-DP Partner	PROFIBUS address = 3 (offered as a selection) Address type = Input (fixed) Address = 200 (offered as a selection)
Length, unit, consistency	Taken automatically from the settings in the publisher station. Change the length to 1 (word) because only the first two bytes are to be read.

Special Feature:

In principle, you can set an address that is higher than I 200, such as I 202. STEP 7 adapts the length of the consistent data automatically. You can also set a length that is shorter than the one that the publisher prescribes (such as 1 byte).

Note

If the setting for consistent length at the publisher is 3 bytes or more than 4 bytes, and the data are being transmitted with SFC15 (DPWR_DAT), the receiver **must** always use SFC14 (DPRD_DAT), even if only 1 byte is being read.

In this case, if you are using Load operations (L IB...), a "0" is read in (incorrect value).

Calling SFC15 in the Publisher (CPU 318-2 DP)

```
CALL "DPWR_DAT"  
  LADDR :=W#16#64           //start address Q 100  
  RECORD :=P#M 10.0 BYTE 16 //source area for user data  
  RET_VAL:=MW100           //return value
```

Calling SFC14 in the Receiver (CPU 316-2 DP)

```
CALL "DPRD_DAT"  
  LADDR :=W#16#78           //start address I 120  
  RET_VAL:=MW100           //return value  
  RECORD :=P#M 10.0 BYTE 2 //target area for user data
```

3.8.3 Configuring a DP-Slave (GSD Rev. 5) as a Receiver for Direct Data Exchange

As of STEP 7 Version 5.3, you can install DP slaves that can be configured as receivers for direct data exchange by means of a GSD file ("standard slaves")

Configuration of direct data exchange (lateral communication) is possible for GSD files as of Revision 5.

Key Words in the GSD File

A DP slave with the GSD entry "Subscriber_supp =1" can be configured as a receiver (subscriber). In STEP 7 this entry means that the property sheet for the DP slave contains an "Address Configuration" tab in which you can assign input and output areas.

A DP slave with the entry "Publisher_supp =1" can be used as a transmitter (publisher) for direct data exchange. The input areas for such a DP slaves can be selected ("subscribed to") in the "Address Configuration" tab. DP slaves without this entry, that is without "publishing capability", are not even offered as transmitters for direct data exchange.

Other entries in the GSD file are automatically applied by STEP 7. For example, in the consistency test the maximum number of relations for direct data exchange are considered. If this number is exceeded, a message will be displayed prompting you to reduce their number.

Description

As in the case of direct data exchange, such as between data-transmitting (publishing) DP slaves and data-receiving (subscribing) I slaves, data are exchanged directly between DP slaves through a DP master.

In contrast to a data-subscribing I slave, which "monitors" the input data from a publishing DP slave in its own local address area, a data-subscribing "standard slave" creates an image of the input data of the publishing DP slave directly on the outputs of the subscribing DP slave.

This means that the parameters assigned to the subscriber determine whether an output byte comes from the DP master or from a publishing DP slave.

The following illustration shows an example of this situation.

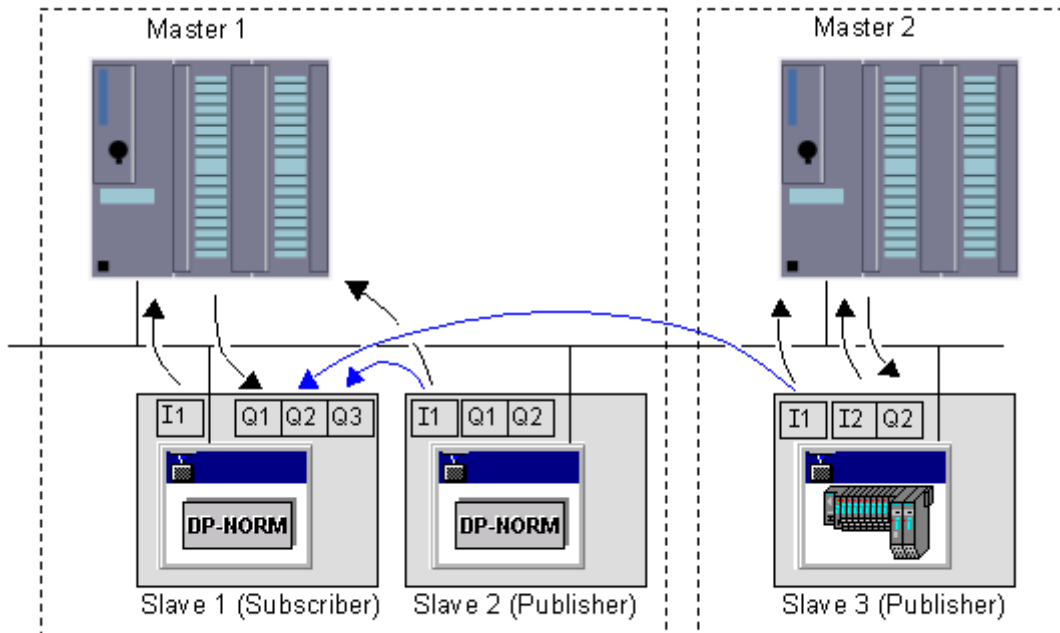

Here two master systems are shown in a configuration for direct data exchange.

Slave 1 was configured as the subscriber for direct data exchange. Data exchange is shown between masters and slaves.

Slave 1 outputs the input data from slave 2 to its output data area Q2. Both areas must have the same length (at least 1 byte).

Slave 1 also outputs the input data from slave 3 to its output data area Q3. Both areas also have the same length.

For master 1, slave 1 (subscriber) only has the output data area Q1. The output data areas Q2 and Q3 are not available to it.

Rules and Notes

The direct data exchange between subscriber and publisher is restricted to DP slaves (slave-to-slave communication).

Direct data exchange between DP slaves in different master systems is possible. In this case, both master must be connected to the same PROFIBUS subnet.

As a rule, output areas of the subscriber are assigned to the DP master and can be assigned to a publisher during configuration. It is also possible to assign an output area to neither the DP master nor to a publisher. In this case, the output areas are assigned a value of "0". The consistency test will provide warning for such areas.

Direct data exchange is not limited to standard slaves. Any slave in the Hardware Catalog ("PROFIBUS DP" folder) that is listed as a transmitter (publisher) or receiver (subscriber) for direct data exchange (see the info text in the Hardware Catalog) can be used.

Procedure

1. Import the required GSD files for slaves that are to be configured as publishers or subscribers.
2. Configure a master system with these slaves.
3. For a slave to be configured as a subscriber, carry out the following steps. Do this for each ID concerned (module).

- Double-click the DP-ID.
- Select the "Address Configuration" tab
- Assign the respective address areas: either to the master (default setting), to a publisher or to no node.

If you set an address area for the DP ID to "**DX**" mode, then this address area is invisible from the point of view of the DP master CPU. This means that there are no logical addresses for the DP master CPU for this address area. The user dialog shows the area of the publisher (DP partner) that modifies the outputs of the subscriber.

In the illustration above, this is the Q2 address area from slave 1.

From the point of view of Master 1, Q2 is invisible. During configuration, the name, PROFIBUS address and the logical address area for I1 from slave 3 (publisher) is shown (e.g. I 100).

If you set an address area for the DP ID to "**MS**" mode, then this address area is visible from the point of view of the DP master CPU. This means that during configuration this address area is mirrored to logical output addresses (e.g. Q 100).

If you set the DP ID to **Mode "--**" for the subscriber, then this address area is invisible from the point of view of the DP master CPU and this area is not modified by any other node. During configuration, this address area is not mirrored to logical output addresses.

The online help on the "Address Configuration" tab contains information on selecting the address area and an example of how this is done.

- Confirm you settings with "OK"
4. Configure the remaining slaves at the station and the master with all modules.
 5. Save and compile the configuration.
 6. Download the hardware configuration to the station.
If several master systems are affected by direct data exchange, the affected stations must also be downloaded.

3.9 Working with *.GSD Files

Device Database (GSD) File for DP Slaves

All the properties of a DP slave are saved in a device database (*.GSD) file. STEP 7 requires a *.GSD file for every DP slave in order that the DP slave can be selected in the module catalog. The manufacturer supplies a *.GSD file for non-Siemens devices that are DP slaves.

Device Database (GSD) File for IO Devices

Similar to the case for DP slaves, there are GSD (Generic Station Description) files for IO devices. The DSD file for an IO device contains all the properties of the device. These files have the file extension "*.xml".

3.9.1 Installing a *.GSD File

If a DP slave or an IO device does not appear in the "Hardware Catalog" window, you must install the corresponding *.GSD file supplied by the manufacturer. You can also use GSD files that were used in another project.

Requirements

The required GSD files must be in a folder on the hard disk or in an STEP 7 project that you have access to. GSD files are always saved with the project. In other words, all the information needed to display the device (including the symbols) are available in the project.

Procedure

1. Close all stations in HW Config.
2. Select the menu command Options > Install GSD File.
3. In the "Install *.GSD Files" dialog box that appears, select the source:
The folder containing the *.GSD files, or
The STEP 7 project containing the *.GSD files
4. Select one or more files from the list of *.GSD files, and then click the "Install" button.

If some of the files could not be installed or if errors occurred during the installation, STEP will log these events. To open this log file, click the "View Log" button.

Overwriting *.GSD Files

To represent DP slaves STEP 7 uses device database (*.GSD) files and symbols which are installed in STEP 7, meaning:

- They were installed automatically with STEP 7 or
- They were installed at a later date

When you install or import the files at a later date, the existing *.GSD files/symbols are not completely deleted but are stored in the following backup directory:

\\Step7\S7data\Gsd\Bkp[No.],

where [No.] is a serial number which STEP 7 assigns automatically.

Restoring Overwritten *.GSD Files

To restore *.GSD files/symbols you overwrote accidentally, proceed as follows:

1. Select the menu command **Options > Install GSD File**.
2. In the following dialog box, navigate to the directory **\\Step7\S7data\Gsd\Bkp[No.]**. Make sure that you select the required backup directory (use the Explorer to find the directory with the correct date/time).
3. Click the "Open" button.

3.9.2 What You Should Know About GSD Revisions

The properties of DP slaves are provided to configuration tools by means of GSD files.

Any extended functions for distributed I/O devices will have an effect on the GSD specification, such as resulting in the definition of new keywords.

This results in their being different versions of the specification. The version of the specification that a GSD file interacts with is called "GSD-Revision".

The GSD revision is contained as an obligatory keyword "GSD_Revision" in GSD files as of GSD Revision 1. GSD files lacking this keyword will be thus be interpreted by configuration tools as GSD Revision "0".

STEP 7 V5.1, Service Pack 3

This version of STEP 7 can interpret GSD files up to GSD Revision 4. This means that you can also use the following new functions for DP slaves that are installed by means of GSD (Revision 4):

- F-parameter assignment of submodules
- Diagnostic messages for interrupt blocks
- Constant mode (isochrone mode)

Special Features:

Please note that the optional package COM PROFISafe must be installed to edit F-parameters. If this package is not installed, the parameters will not be visible and thus cannot be changed. The F-parameters will, however, remain (default values are taken from the GSD file or are values changed with COM PROFISafe) and will be taken into account when generating a configuration (For further information, see the documentation on distributed F-systems).

The following functions, although possible in GSD Revision 4, are not supported:

- A second parameter frame (extended parameter assignment)
- Subscriber functions (receive capability for direct data exchange/lateral communication)
- Keywords for HART parameter assignment

STEP 7 V5.3

This version of STEP 7 can interpret GSD files up to GSD Revision 5. This means that you can use new functions also for DP slaves that are installed using GSD (Revision 5):

- Using a DP Slaver as a receiver (subscriber) for direct data exchange (lateral communication).
- Redundant configuration of a DP slave in an H station.
A DP slave can be redundantly configured if the GSD entry "Slave_Redundancy_supp = 8" is present.
- Clock Synchronization for DP slaves.
A DP slave with the GSD entry "Time_Sync_supp = 1" provides the "Clock Synchronization" tab for configuring this function.

STEP 7 V5.3 Service Pack 1

In addition to GSD files for DP slaves (up to Revision 5), this version of STEP 7 can also interpret GSD files for PROFINET IO devices in XML format (Generic Station Description). Both types of GSD files are handled identically.

There are special considerations with respect to naming these new GSD files and specifying their versions. STEP 7 V5.3, Service Pack 1, interprets GSD files with the GSDML schema V1.0.

3.9.3 What You Should Know about GSD Files for PROFINET IO Devices

Basic information

The properties of PROFINET IO devices are not stored in a key-word based text file (as for PROFIBUS DP slaves) but in an XML file whose structure and rules are determined by a GSDML schema.

The language used to describe GSD files is GSDML (Generic Station Description Markup Language). It is defined by the GSDML schema.

A GSDML schema contains validity rules that, among other things, allow the syntax of a GSD file to be checked. Manufacturers of IO devices get the GSDML schemas (in the form of schema files) from PROFIBUS International.

Expanded functionalities in the area of PROFINET IO also affect the GSDML specification and the associated schema. Expanded functionalities result in a new version of the GSDML specification and the schema.

Names of GSD files for IO devices

The structure of the names for a GSD file is explained based on the following example:

"GSDML-V1.0-Siemens-ET200S-20030616.xml"

Part of name	Explanation
GSDML	Every GSD file for IO devices starts with this character string
V1.0	Version of the GSDML schema
Siemens	Manufacturer
ET200S	Name of device
20030616	Version identifier (date)
.xml	File extension

If the Hardware Catalog happens to contain duplicate names, then the GSD file with latest version number or date is the one used.

Versions of GSD files for IO devices

The version information for GSD files consists of two parts:

One of these parts indicates the version of the GSDML schema. This determines what languages that a GSD file uses.

The other part indicates the file version (based on date). A GSD file receives a new, later version number whenever it is improved (e.g. errors corrected) or its functions are enhanced.

3.10 DPV1

3.10.1 What You Should Know About PROFIBUS DPV1

Below you can find information relating to the topics:

- New mechanisms introduced by the DPV1 Masters/Slaves
- The changes you meet when configuring and programming those components

Additional Information

Our Internet Customer Support Pages contain a FAQ publication relating to this topic under article ID 7027576. (Title: "Changing over to DPV1"; refer to **Automation Systems > SIMATIC Decentralized Peripherals > PROFIBUS > General**)

How do you recognize a DPV1 Master/Slave?

CPUs of the S7-400 family with integrated DP interface support DPV1 Master functions as of Firmware Version 3.0.

DPV1 Master functions are also available for the new CP 443-5 (DX03).

DP Slaves listed in the Step 7 hardware catalog under their family name can be recognized in the Info text as DPV1 Slaves.

DP Slaves implemented in STEP 7 via **GSD Files** support DPV1 functions as of GSD Revision 3.

Additional Functions DPV1 Devices (Master/Slaves)

DP Masters and DP Slaves that support DPV1 are, contrary to the "old" devices (often referred to as "Standard Masters" or "Standard Slaves"), equipped with the following additional functions:

- Acyclic data exchange between Masters and Slaves is supported (reading/writing a data record to reconfigure an operational slave). The module data records and their structure is explained in the documentation for the respective module.
- A DPV1 Slave can provide interrupts to insure that the Master CPU handles the event triggering the interrupt. Interrupt data is also evaluated in CPU STOP mode (updating the diagnostic buffer and module status); OBs are, however, not processed in STOP mode.

In addition to the interrupts known in SIMATIC (for example, diagnostic interrupt with ET 200M), the new Status/Update/Manufacturer specific interrupts are now also supported.

Comment: DP Slaves that were up to now fully integrated in STEP 7 (that is, Slaves not configured via GSD File, but rather via internal STEP 7 module information) also supported a part of those functions, however, with an S7 specific significance of, for example, data record contents. New is here that those functions are now available manufacturer independent (for example, for DP Slaves with GSD Files Revision 3).

3.10.2 Configuring DPV1 Devices

Changing the DP Master Interface and Configuring DP-Slaves

DPV1 operating mode is set by default in your hardware configuration with STEP 7 when you insert a DP Master with DPV1 functions in the master module rack. To change this operating mode, proceed as follows:

1. Double-click on the "DP Master" row of the CPU in the configuration table. This row represents the DP interface..
2. In the properties dialog, click on the dropdown menu "DP-Mode" and select the desired operating mode:
 - "S7 compatible", if you do not use DPV1 functions
 - "DPV1", if you use DPV1 functions.
3. Implement all DP Slaves in the DP Master system.
Valid is:
 - On a DP interface with DPV1 operating mode you can, generally seen, also operate DP Slaves that do not support those functions (for example, DP Slaves with GSD Revision < 3).
 - You can also, on principal, operate DPV1 Slaves on a DP interface in operating mode "S7 compatible". In this case, DPV1 functions are automatically switched off. However, manufacturer specific configuration rules for certain DP Slaves possibly force DPV1 mode, thus preventing you from connecting them to the DP Master system (this is automatically checked during the configuration process)!

Consequences of Switching Over a DP Master Interface

Case 1: The DP Master Interface is to be changed to "DPV1":

On this interface you can maintain operation of currently connected DP Slaves that do not support DPV1 functionality.

Case 2: The DP Master Interface is to be switched over from "DPV1" to "S7 compatible":

STEP 7 checks whether all DP Slaves can be switched over to this operating mode. If a DP Slave forces DPV1 functionality, for example, if an interrupt must be activated, you can not use this DP Slave on the DP Master in "S7 compatible" operating mode.

Changes in the Structure of a DPV1-Slave

DPV1 Slaves are equipped with a slot model design which is new compared to the ones known up to now. However, the consequences involved for you as STEP 7 user are minute.

As a rule, you address the distributed I/Os via logic addresses in the same way as you used to do. The slot address <-> logic address conversion is carried out automatically or controlled in a dialog when a DP Slave is being configured. Here, the slot and address assignment of the configuration corresponds with the assignment you can determine via address conversion in the user program (conversion of the physical address into a logic address and vice versa - via SFC 5 and SFC 49).

As of STEP 7 V5.1, Service Pack 2, the slots in the detail view of a DP1 Slave always start with slot number 1. This has the consequence that, when using DP Slaves not configured via GSD file, the DP connection (for example, an IM 153) is visible on slot number 2.

Diagnostic Address

The diagnostic address of a DP Slave is not altered by the switch-over. With DPV1 Slaves it is automatically assigned to the "virtual" slot number "0" as station representative.

Generally, the following assignment applies:

- Diagnostic data and interrupts which can only be assigned globally to the DP Slave are assigned to virtual slot 0 and its diagnostic address: for example, interrupts from modules inserted in slots which have not been configured, station failure/station return (OB 86)
- The remaining slots and their respective start addresses are configured with diagnostics and interrupts triggered by the module (for example, by a DP connection IM 153-2 in slot 2).

3.10.3 Programming DPV1 Devices

New Interrupt OBs for DPV1 Events

DPV1 Slaves can trigger interrupts. You can use the respective OBs the S7 CPU operating system provides up to now for Diagnostic/System/Extraction/Insertion Interrupts.

New are the OBs for the following interrupts:

DPV1 Interrupt	OB	Explanation
Status Interrupt	OB 55	A Status Interrupt can be triggered by the operating state transition of a module, for example, from RUN to STOP mode. Refer to the respective DPV1 Slave manufacturer's documentation for detailed information on events that can trigger a Status Interrupt.
Update Interrupt	OB 56	An Update Interrupt can be triggered after a slot was reconfigured. For example, this might occur as a result of local or remote access to the parameters. Refer to the respective DPV1 Slave manufacturer's documentation for detailed information on events that can trigger an Update Interrupt.
Manufacturer Specific Interrupt	OB 57	The event triggering a Manufacturer Specific Interrupt can be specified by the manufacturer of a DPV1 Slave

New SFBs and SFCs for Accessing DPV1 Slaves

In order to make the topic more comprehensive, the table below shows - wherever possible - the new interfaces and their functions compared with previous interfaces. You can find detailed information in the descriptions of the SFBs/SFCs and new OBs. A conversion of existing configurations to the new SFBs/SFCs is not necessarily required. However, you should use the new SFCs/SFBs when you create new projects with a DPV1 configuration to be able to use all DPV1 functions.

Function	Previous Interface	New Interface (DPV1)	Comments
Read Data Record	SFC 59 RD_REC	SFB 52 RDREC	-
Write Data Record	SFC 58 WR_REC	SFB 53 WRREC	-
Receive interrupt from a DP Slave	-	SFB 54 RALRM	The SFB must be called in the OB that is triggered by the interrupt.

Hinweis

Wenn ein DPV1-Slave über GSD-Datei projektiert ist (GSD ab Rev. 3) und die DP-Schnittstelle des DP-Masters ist auf "**S7-kompatibel**" eingestellt, dürfen im Anwenderprogramm keine Datensätze mit SFC 58/59 bzw. SFB 53/52 von den E/A-Baugruppen gelesen bzw. beschrieben werden. Der DP-Master adressiert in diesem Fall den falschen Steckplatz (projektiertes Steckplatz+3).
Abhilfe: Schnittstelle des DP-Masters auf "DPV1" umstellen.

Checklist for Testing Existing User Programs

The following sections of your existing user program must be checked if you have edited the configuration with STEP 7 V5.1, Service Pack 2 and if you have switched to "DPV1":

Function	What is to be checked?
Address conversion	For DP Slaves configured via GSD files you must check the assignments Slot <-> Logic Start Address, if you have used address conversion in the user program (SFC 5, SFC 49, SFC 50). Slot 0 has an additional address. <ul style="list-style-type: none"> DP Slave implemented via GSD File: Previously the first I/O module of the DP Slave was assigned to slot 4. However, the first I/O module is now assigned to slot (as you can see in the hardware configuration). DP Slave integrated in STEP 7 (for example, ET 200M): the interface module (slot 2) has its own address.
Reading Diagnostics with SFC 13	The originally assigned diagnostic address still functions. STEP 7 assigns this address internally to slot 0. However, the diagnostic data record of DPV1 Slaves has a different structure (refer to the description of DP Slaves. With ET 200M, for example, also refer to the keyword "Extended Diagnostics").
Reading/Writing Data Records	If you transfer data records to a DPV1 slave with SFC58 "WR_REC" or if you fetch data records from a DPV1 slave with SFC59 "RD_REC" and if this DPV1 slave operates in DPV1 mode, the DP Master evaluates the error information it received from the Slave as follows: If the error information lies within the range from W#16#8000 to W#16#80FF or W#16#F000 to W#16#FFFF the DP master passes the error information to the SFC. If it lies out of this range, the CPU passes the value W#16#80A2 to the SFC and suspends the slave. For a description of the error information received from DPV1-Slaves, see Receiving an Interrupt from a DP-Slave with SFB 54 "RALRM" STATUS[3]. See also: Jumps to Language Descriptions and Help on Blocks, System Attributes

Function	What is to be checked?
Reading the System Status List	If you use SFC 51 (RDSYSST), for example, to read out information on module status or module rack/station status, you must take into consideration the changed significance of the slots and of the additional slot 0 (see above).

Example 1: Evaluating Interrupt Info from OB 40 with SFB 54 "RALRM"

A distributed S7 digital input module (Start address 288) triggers a Hardware Interrupt. The supplementary interrupt information on this module is to be read from OB 40 via call of SFB 54 "DP_ALARM". It is checked whether the first channel has triggered a hardware interrupt.

You could also read out additional interrupt information with S7 modules directly from the start information of OB 40. However, the DPV1 standard generally permits up 59 bytes of additional interrupt information - too much for the OB 40 start information.

For information on the SFB 54 and the structure of additional interrupt information for the various interrupt types please refer to the manual "System Software for S7-300/400 System and Standard functions" or to the corresponding Online Help.

```
// ...
// ...
//Switch for address that triggered the interrupt (288)
L    DW#16#120
T    "MD10"

CALL "RALRM" , "DB54"
MODE :=1 //function mode: 1 = set all
//output parameters (that is,
//F_ID has no effect)

F_ID :="MD10" //start address of the slot from
//which an interrupt is
//permitted

MLEN :=8 //max. length of supplementary
//interrupt info in bytes
//(for example, for module
//channel status)

NEW :="Alarm_neu" //receive interrupt ? (yes = 1)
STATUS:="DP_RALRM_STATUS" //Return value with function
//result/error message

ID :="Slotadresse_Alarm" //start address of the slot from
//which an interrupt was
//received

LEN :="Laenge_Alarminfo" //length of supplementary
//interrupt info (4 bytes header
//info + ,for example, 4 bytes
//with S7 I/O modules)

TINFO :=P#M 100.0 BYTE 28 //pointer for OB start info +
//management info: 28 bytes as
//of MB 100

AINFO :=P#M 130.0 BYTE 8 //pointer for target area of the
//header info + supplementary
//interrupt info (max. 59 bytes)

U M 124.0 //has input 1 (bit 0) triggered
//the interrupt?

SPB Alrm
BEA

Alrm: S A 0.0 // interrupt handling
// ...
```

Example 2: Evaluation of Diagnostic Data in OB 82 with SFB 54 "RALRM"

The target area for diagnostic data must be large enough to hold standard diagnostics (6 bytes), identifier specific diagnostics (3 bytes for 12 slots) and the evaluation of device-specific diagnostics (module status only, which requires 7 more bytes).

Extended evaluation (channel-specific diagnostics) would require the reservation of additional bytes, provided the DP Slave supports this function.

```
// ...
// ...
L      120                                //determine the start address for the
//module/station,
T      "Slotadresse_Diag"                //from which the diagnosis is to be
//fetched

CALL   "RALRM" , "DB54"
MODE   :="Alle_Params"                   // 1 = all output parameters are set
F_ID   :="Slotadresse_Diag"              //start address of the slot from
//which the diagnosis is to be fetched
MLEN   :=20                              //max. length of diagnostic data in bytes
NEW    :="neu"                            //irrelevant
STATUS:= "RET_VAL"                       //function result, error message
ID     :="Slotadresse_Alarm"             //start address of the slot from which an
//interrupt was received
LEN    :="Laenge_Alarminfo"              //length of the supplementary interrupt
//info (4 bytes header info+16 bytes
//diagnostic data
TINFO  :=P#M 100.0 BYTE 28                //pointer for OB start info + management
//info: 28 bytes as of MB 100
AINFO  :=P#M 130.0 BYTE 20                //pointer to the target area in which the
//diagnostic data is to be stored

// ...
//Structure of the stored diagnostic data:
// MB 130 to MB 133: header info (length, identifier, slot)
// MB 134 to MB 139: Standard Diagnostics (6 bytes)
// MB 140 to MB 142: identifier specific diagnostics (3 bytes)
// MB 143 to MB 149: module status (7 bytes)
// ...
U      M      141.0                        //slot 1 error?
SPB    stp1
BE

stp1: L      MB      147                    //fetch module status slots 1 to 4
UW     W#16#3                              //filter slot 1
L      W#16#2                              //2-bit status 'wrong module',
//wrong module inserted

==I
S      A      0.1                          //reaction to wrong module

L      MB      147                    //fetch module status slots 1 to 4
UW     W#16#3                              //filter slot 1
L      W#16#1                              //2-bit status 'invalid data',
//invalid user data

==I
S      A      0.2                          //reaction to invalid user data
//...
```

3.10.4 The Slot Model of DPV1 Slaves with I-Slaves

Subject of article below is the visualization of the assignment of addresses (I/O addresses and diagnostic addresses) to the slots within the DPV1 model. We shall pay close attention to the addresses that do not carry user data and especially to the configuration of those addresses.

The Slot Model for DPV1

With DPV1 (IEC 61158) a slave is built of slots in the same way as DP (EN 50 170). The slot numbers are 0, 1, ...n. Slot 0 - a new slot - is of high significance because it is representative of the complete DP Slave.

Representative means, for example, that interrupts triggered via slot 0 are assigned quasi to the global DP slave rather than to a certain slot within the DP Slave. Diagnostics output from this slot are globally assigned to the DP Slave rather than to any individual slot or module.

Excursion: Addresses for DP Interface

Seen from the CPU, a separate logical address is available for every one of your interfaces.

You can locate this address in the "Addresses" tab of the Master interface and of the Slave interface (double-click on the "DP" row in the configuration table).

These addresses have nothing in common with the slot model of DP Slaves. Rather, they are used by the CPU internally for the identification of, for example, the failure of an interface. This address is of little significance to the user program.

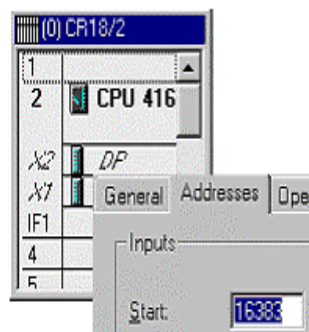

Slots and Addresses for User Data

Generally speaking, the manufacturer of a DP Slave can freely choose what kind of data he assigns to any slot.

The first I/O module of DP Slaves (often referred to as "S7 Slaves") configured in Step 7 via the internal STEP 7 module knowledge base are always located in slot 4. In contrast, the DP Slaves that are installed in Step 7 via the GSD file can contain user data as of slot 1.

Distributed peripheral data are usually addressed in the same way as centralized peripheral data via their addresses. Therefore, for S7 Slaves the user data are always addressed as of the start address of slot 4.

This is also valid for intelligent DP Slaves. For intelligent DP Slaves you can assign the I/O memory area of the Slave via a table ("Configuration" tab) to the I/O memory area of the Master. In operate state (cyclic data exchange) the data that you transfer in the user program of the intelligent DP Slave to these memory areas are transferred to the assigned Master memory areas.

However, the slot number remains hidden when you configure the addresses, because the slot limits are not formed by real modules (for example, with ET 200M). This is formed rather by a freely customizable length of the respective I/O area. In such cases we also speak of "virtual" slots.

Important for the assignment of addresses is:

- In addition to "real" slots, the memory area of an intelligent Slave also has "virtual" slots.
- Virtual slots are addressed in the same way as real slots, namely via their logical address. For "Standard" DP Slaves such as ET 200M this happens via module start address, and for an I-Slave via the address configured in the "Configuration" tab (I/O area).
- The addresses of the virtual slots are different from the DP Master point of view than from the DP Slave. The assignment is configurable. Therefore, the DP Master and the DP Slave as a rule use different addresses to address one and the same DP Slave slot.

Example of an Address Assignment for User Data

local: DP-Sla...				PROFIBUS-DP partner						
I/O	Addr.	D	P...	I/O	Address	H...	Length	Unit	Consistency	
I	2	8	2	Q	4	4	1	B	Unit	
Q	5	8	2	I	6	4	1	B	Unit	
I	8	8	2	Q	8	4	1	B	Unit	

Previously the assignment of "virtual" slots was as follows.

Example address from the view of the DP Slave	Significance (for DP Slave)	Slot (not visible when configuring)	Significance (for DP Master)	Example address from the view of the DP Master
		0		
		1		
		2		
		3		
E 2	Reading via input byte 2 that ...	4	... what the Master wrote into output byte 4.	A 4
A 5	What was written to output byte 5 in the Slave ...	5	... can be read in the Master as input byte 6.	E 6
E 8	...	6	...	A 8
		...		
		35		

Tip: the slot assignment is displayed in the address overview of the Master CPU or Slave CPU.

Slots and Addresses for System Information

Addresses for system information are used, for example, to handle diagnostic information or information on operating state transitions.

Addresses of the DP Slave

The system information of DP Slaves is also assigned to slots. Relevant for operating mode DPV1 in this context are the following slots:

- Slot 0 (Station representative):
Via the address of this virtual slot, seen from the view of the **DP Master**, the DP Master diagnoses the failure or return of the intelligent DP Slave.
Via the address of this virtual slot, seen from the view of the **DP-Slave**, the intelligent DP Slave diagnoses the failure or return of the DP Master.
- Slot 2 (for "Standard" DP Slaves the DP interface):
Via the address of this virtual slot, seen from the view of the **DP Master**, the DP Master can detect an operating state transition of the DP Slave.
Via the address of this virtual slot, seen from the view of the **DP-Slave**, the DP Slave can detect an operating state transition of the DP Master.
- Slots 1 and 3 are not relevant for intelligent DP Slaves.

In the table below you can find an assignment for slots 0 to 3 ("virtual" slots). The tab designations relevant for the configuration of the Master station and of the Slave station are listed below the table.

In STEP 7 addresses are automatically assigned "from top to bottom" in order to avoid conflicts with user data. You should apply the recommended addresses, even though you can edit them. Check whether or not the size of the addresses area matches the "smallest" CPU in case the user program is to run on different CPUs.

Example address from the view of the DP Slave	Significance (for DP Slave)	Slot (not visible when configuring)	Significance (for DP Master)	Example address from the view of the DP-Masters
8189	Station failure / station return of the DP Master (see 1)	0	Station failure / station return of the DP-Slaves (see 3)	16381
-	Not relevant	1	Not relevant	-
8188	Operating state transition of the DP Master (see 2)	2	Operating state transition of the DP Slave (see 4)	16380
-	Not relevant	3	Not relevant	-
	User data (see above)	4 ... 35	User data (see above)	

- (1) Double-click on the DP interface of the intelligent DP Slave (e.g., CPU 414-3 DP) in the Slave station, "Configuration" tab; input is possible in the table, "Diagnostics" field.
- (2) Double-click on the DP interface of the intelligent DP Slave (e.g., CPU 414-3 DP) in the Slave station, "Operating Mode" tab; input is possible under the option "DP Slave" in the field "Address for virtual slot 2".
- (3) Double-click on the DP Slave icon in the Master station, "General" tab; input is possible under "Addresses" in the "Diagnostic address" field.
- (4) Double-click on the DP Slave icon in the Master station, "General" tab; input is possible under "Addresses" in the field "Address for virtual slot 2".

Summary

With openly presented virtual slots, the configuration of the intelligent DP Slave looks as follows:

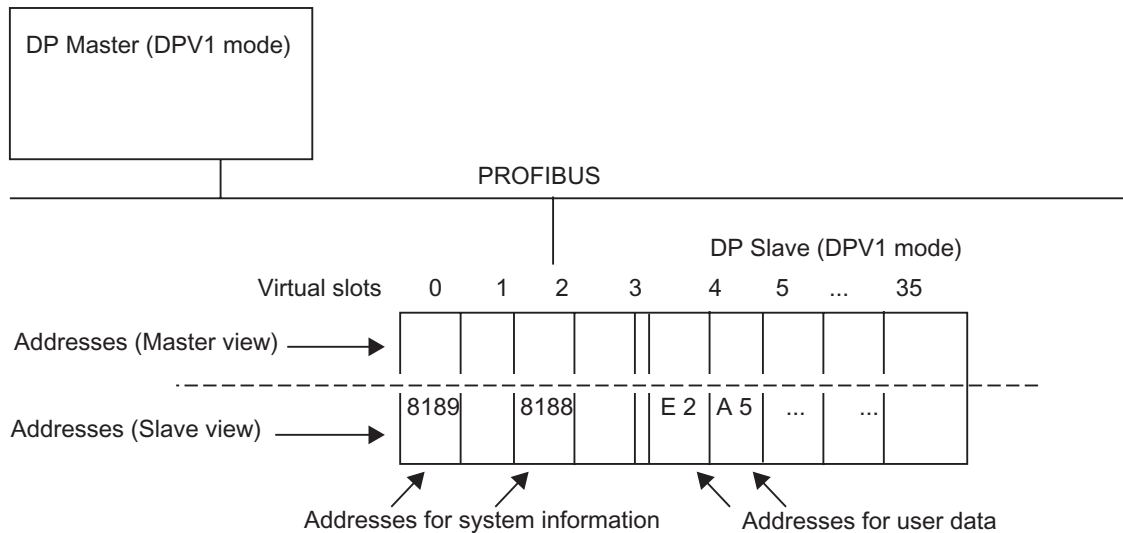

Triggering Hardware Interrupts with SFC 7

With SFC 7 you can trigger a hardware interrupt for any configured address via the user program of the I-Slave CPU. This also applies to user data addresses of the I/O range as well to the address of the virtual slot 2.

In the I-Slave user program, for example, use the I/O addresses configured in the "Local..." column for the SFC 7.

An hardware interrupt is then triggered in the user program of the Master. In the start information of the hardware interrupt OB (e.g., OB 40) the address you have configured in the column "PROFIBUS-DP-Partner" is passed on as the address that has triggered the interrupt.

3.11 Diagnostic Repeater

3.11.1 Configuring and Commissioning the Diagnostic Repeater

This Diagnostic Repeater can monitor the segment of an RS485 PROFIBUS subnet (copper wire) during operation and report cable errors per diagnostics telegram to the DP Master. Via an HMI you can display the error location and the cause in plain-text.

The Diagnostic Repeater with its line diagnostic feature offers the possibility to recognizing and localizing line errors at an early stage and while in operation, thus reducing system standstill.

Configuring the Diagnostics Repeater

You can locate the Diagnostic Repeater in the hardware catalog under "PROFIBUS DP\Network components\Diagnostic Repeater". The Diagnostic Repeater must be configured like any "Standard Slave" (it is connected to the master system of a DP Master).

Function of the Diagnostic Repeaters

To locate anomalies during operation, the Diagnostic Repeater must know the topology of the PROFIBUS subnet to which it is connected. The Diagnostic Repeater measures the distance to all partners via "Prepare line diagnostics" function.

The Diagnostic Repeater measures the partner distances and stores them internally in a table. The Diagnostic Repeater also memorizes in which segment it has detected the partner.

After it has measured the distance to a segment error during operation, the table entries can be used to determine between which of the partners the segment fault is pending.

The Diagnostic Repeater interconnects 3 segments. During operation the Diagnostic Repeater can determine the topology and localize segment errors only in **Segments DP2 and DP3**, because they are the only ones equipped with measuring lines. The figure below displays the Diagnostic Repeater (DR) and its connections.

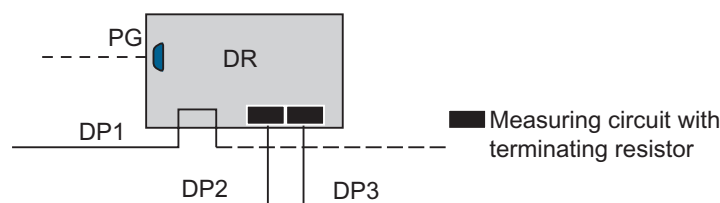

Prerequisites for Commissioning

The following prerequisites must apply:

- To be able to start capturing the topology, the PG must be connected to the PROFIBUS network.
- The structure of the PROFIBUS subnet with connected Diagnostic Repeater corresponds with the specifications and rules of the Diagnostic Repeater documentation.

Commissioning the Diagnostic Repeater with STEP 7

In order to be able to locate a disturbance during operation, the Diagnostic Repeater must know the topology of the PROFIBUS subnet to which it is connected. The Diagnostic Repeater measures the distance to all partners via "Prepare line diagnostics" function.

The Diagnostic Repeater measures the partner distances and stores them internally in a table. The Diagnostic Repeater also memorizes in which segment it has detected the partner.

After it has measured the distance to an error during operation, the table entries can be used to determine between which of the partners the disturbance is pending.

You must explicitly instruct the Diagnostic Repeater to determine the distance between PROFIBUS partners when you configure your hardware or network:

1. Highlight the Diagnostic Repeater or the DP Master System to which it is connected (configure the hardware), or highlight the PROFIBUS subnet to which the Diagnostic Repeater is connected (network configuration)
2. Select the menu command PLC > Prepare line diagnostics.
3. Start the measurement via the subsequently opened dialog.

Locating the Error During Operation

During operation the Diagnostic Repeater reports the event "Found Error" to the DP Master CPU.

You can view detailed information on pending diagnostic events in the dialog for the module status of the Diagnostic Repeater. The error is displayed visually in the dialog with additional information, for example, showing the error cause (provided it can be detected by the Diagnostic Repeater).

Example of Visual Presentation in the Dialog "Module Status"

If the functions of all segments to which the Diagnostic Repeater is connected are free of error, the corresponding tabs in the dialog "Module Status" are displayed as follows:

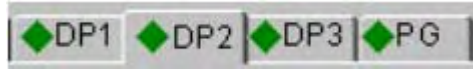

If a segment is switched off (that is, it is not possible to diagnose it), the following symbol will appear at the side of the register title:

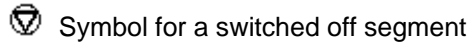

An error in segment "DP2" results in an error symbol at the side of the "DP2" tab identifier. The remaining segments are free of error:

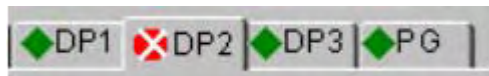

The "DP2" tab could show the disturbance in the following view: The Diagnostic Repeater is assigned to PROFIBUS address 4, the error is located between the partners assigned to the PROFIBUS addresses 16 and 21. In addition, the view shows the distance to the neighboring DP Slaves.

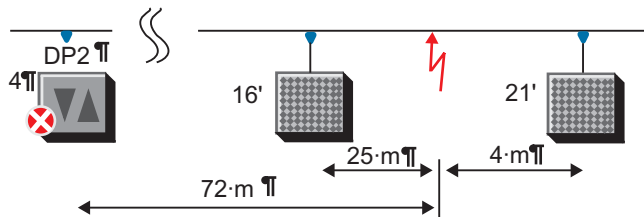

In the figure below you can find an example of a simplified detailed presentation of the arrangement illustrated above.

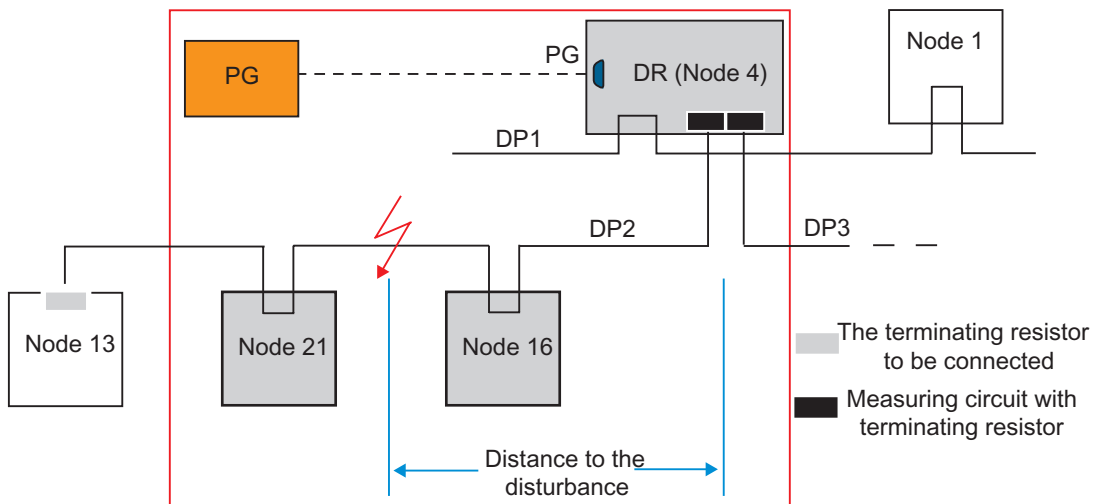





If STEP 7 does not localize the error in segment "DP2" or if, for example, this segment contains more than 32 partners and the Diagnostic Repeater cannot operate correctly anymore, you are shown the following image:



Summary of all Symbols

The symbols of the registers can be of the following forms:

	No segment error
	Segment error
	Segment is switched off
	Information cannot be retrieved from the segment

3.11.2 Displaying the Topology With the Help of Diagnostic Repeaters

As of STEP 7 V5.2, in combination with a PROFIBUS configuration with Class 2 diagnostic repeaters 972-0AB01 it is not only possible to perform line diagnostics, but also to display the PROFIBUS DP network topology.

In contrast to the network view under NetPro, this function does not display the "Logic" view of a PROFIBUS subnet, but rather the physical arrangement of the PROFIBUS nodes in their actual order as well as the distances to the nodes - provide the diagnostic repeater was able to determine these data. The actual nodes are displayed same as under NetPro.

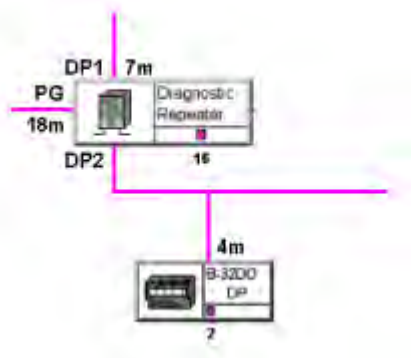

Function

Prior to displaying the topology, the "Prepare line diagnostics" function must be called initially after each modification of the hardware structure, in order to enable the diagnostic repeater to measure the PROFIBUS subnet and generate internal distance tables.

The "Display the PROFIBUS Network Topology" function is used to visualize these data.

If you select a subnet in a opened project and then display the topology, the nodes in the subnet are displayed along with their configured names.

In addition to the visualization, the entries in the diagnostics buffer of the diagnostic repeater as well as statistical data can be read and displayed.

You can write these data to a file and print it.

Requirements

The diagnostic repeaters must support the "Display the PROFIBUS Network Topology" function (i.e. as of order no. 6ES7 972-0AB01).

The structure of the PROFIBUS network must be in compliance with the guidelines in the diagnostic repeater manual, to be able to determine distances correctly. Cascaded diagnostic repeaters, for example, may only be connected to a master diagnostic repeater via a DP1 interface.

To call the "Prepare line diagnostics" function, the PG must be connected directly to the same PROFIBUS as the diagnose repeater. The "Prepare line diagnostics" function can also be called without open project.

To enable the "Display the PROFIBUS Network Topology" function, you can also connect the PROFIBUS network with its diagnostic repeaters via a "Data record router" (z. B. CP 443-5 Ext V3.2) to the PG. The PG must have been assigned in the STEP 7 project (Under NetPro, use menu command **PLC > Assign PG/PC** to configure the "PG/PC" object). To enable the display of a network topology via routed diagnostic repeater, you need to open the corresponding project and select the participating PROFIBUS subnet.

Procedure

Do one of the following:

1. In NetPro or in HW Config, select the menu command **PLC > Prepare Line Diagnostics**.
2. In the SIMATIC Manager, select the menu command **PLC > PROFIBUS > Display Network Topology**; or in NetPro, select the menu command **PLC > Display PROFIBUS Topology**.

Alternative: In the user program, use SFC 103 ("DP_TOPOL") to determine the topology.



3.11.3 Working With the Topology View

Display of the Nodes

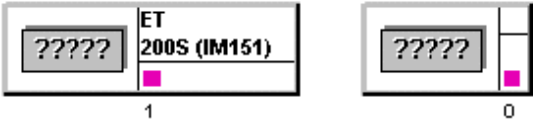
The upper section of the "Topology display PROFIBUS DP" window shows the nodes that cannot be assigned.

Representation	Meaning
	<p>Nodes cannot be assigned.</p> <p>The possible causes are indicated in a message in the window:</p> <p>Nodes have been added, node addresses have been changed and afterwards the function "Prepare Line Diagnostics" was not started. If diagnostic repeaters are connected that do not support the reading of topology data, this is also reported in the upper section of the window.</p> <p>An unknown node is indicated by a series of question marks.</p>

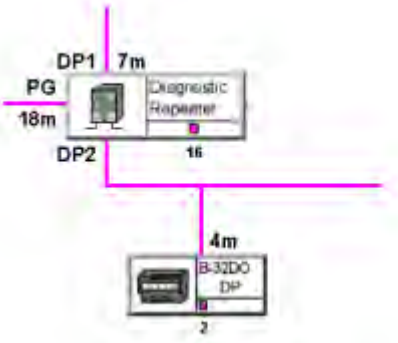
The lower section of the window shows the nodes that can be assigned as networked nodes along with the distance information determined not and, if necessary, other information.

Representation	Meaning
	<p>Nodes can be assigned and represented in the PROFIBUS topology.</p> <p>Other information such as a faulty configuration (such as when the measuring segments of two diagnostic repeaters are directly connected) will be reported in a message.</p> <p>Representation of the cable lengths (in the example):</p> <p>The cable length between the DP slave with the PROFIBUS address 2 and the diagnostic repeater (PROFIBUS address 16) is 4 meters. The DP slave is connected at segment DP2.</p>
	<p>Node can be assigned, but cannot be reached by the diagnostic repeater at this time.</p>
	<p>Node can be assigned, but has been detected as faulty by the diagnostic repeater</p>

How to find nodes in the topology view

In larger configurations you can locate a required node via the menu command **Options > Go To**. The next dialog box "Go To" displays all nodes of the PROFIBUS network:

1. Select the required node (e.g. a DP slave)
2. Click on the "Node" button to display the node in the center of the window. Click on the "Diagnostic repeater" button to display the assigned in the center of the window.

Display of the topology in tables

If you prefer to display the topology in a table rather than graphically, call menu command **View > Table > Topology**.

Preparing line diagnostics

Use the same procedure as in HW Config or under NetPro. In the topology display, call menu command **PLC > Prepare Line Diagnostics**.

Calling the module status

Use the same procedure as in HW Config or under NetPro. In the topology display, call menu command **PLC > Module Status**.

How to save and open topology data

Select the menu command **File > Save** or **File > Save As** to save the current display. This function allows to easily save the data you have acquired online for the purpose of later diagnostics and error evaluation.

How to export topology data

You can use the following view to export topology data:

- The "Table" view (after calling menu command **View > Table**)
- The "Statistics" dialog box (after calling menu command **PLC > Statistics**)
- The "Diagnostics buffer" dialog box (after calling menu command **PLC > Diagnostics Buffer**)

The CSV (ASCII) export format can be read and edited with other applications.

The topology display can no longer read exported data.

How to find data on reflection errors and message frame errors (statistical data)

Reflection errors occur in cases such as if a line is interrupted or faulty or if there is no terminating resistor or there is an accumulation of too much terminating resistance.

Frame errors occur in cases such as when at least one bit (i.e. the parity bit) is corrupted due to faulty hardware.

You can log reflection errors and message frame errors detected by the diagnostic repeater in a window. You can then print or export the logged data, for example.

1. In the topology display, select the diagnose repeater whose data you want to read.
2. Start this function with the menu command **PLC > Statistics**.

The values will be displayed for 60 seconds, starting at the time the dialog is being opened. Further values will be accumulated internally across this interval. You can click on the "Export" button to export these values in CSV format.

The color coding also helps you in determined the severity of the error. The color coding shown is determined by an evaluation of the statistical data.

Click on "Print" to print the visible graphic object.

Fetching data from the diagnostics buffer

Similar to the diagnostics buffer function of the CPU, you can use this function to record a history of error events on the PROFIBUS. Select menu command **PLC > Diagnostics Buffer** to start this function. The next dialog displays the last 10 events . Click on an event to display details in the lower section of the dialog box.

If a "DPx" tab (i.e. the "DP2" tab) in the "Diagnostic Buffer" dialog box indicates that the segment is faulty, then there is an incoming error. Under certain conditions this error is no longer contained in the diagnostic buffer.

To display the current status, select the men command **PLC > Module Status**.

Printing the topology display

Select **File > Print** to print the topology data. In the dialog box that is then displayed, you can set up the printer, select the area to printed and specify a notes field.

3.12 Setting Constant Bus Cycle Times for PROFIBUS Subnets

Introduction

For PROFIBUS subnets you can set constant (of equal length) bus cycle times in STEP 7.

Constant bus cycle time is the property of the PROFIBUS-DP that guarantees bus cycles that are exactly the same length. "Bus cycles of the same length" means that the DP master always begins the DP bus cycle after the same time interval. From the viewpoint of the connected slaves, this means that they also receive their data from the master in time intervals of exactly the same duration.

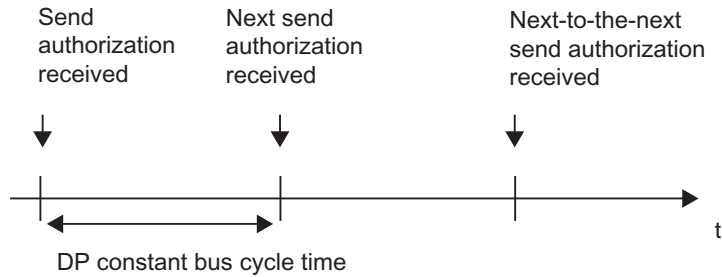

Bus Cycle Time

The following figure shows how the time for a bus cycle is made up.

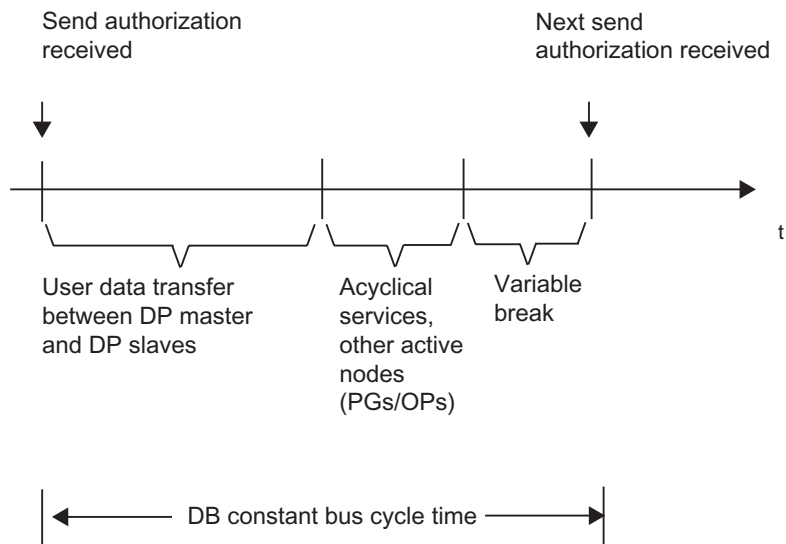

The "variable pause" shown in the figure is always minimal if communication jobs, for example, for other active nodes are still pending. The master (also known as the constant-bus-cycle-time master) controls the communication parts so that the same duration for a bus cycle is always achieved.

Requirements

- The constant-bus-cycle-time master must support the "Constant bus cycle time" function (see info text in the hardware catalog).
- The constant-bus-cycle-time master must be a class 1 DP master. This means a PG/PC can never be a constant-bus-cycle-time master.
- The constant-bus-cycle-time master is the only active station on the PROFIBUS-DP. Only one DP master system may be present on the PROFIBUS subnet. Programming devices or PCs can also be connected.
- Constant bus cycle time is possible only for the "DP" and "User-Defined" bus profiles.
- CiR must not be configured.
- No H-CPU may be connected to the PROFIBUS subnet.
- The PROFIBUS subnet must not be a cross-project one.

Time for DP Constant Bus Cycle Time

STEP 7 calculates a recommended time for the "DP constant bus cycle time(ms)" based on:

- The PROFIBUS configuration (number of configured nodes, number of programming devices etc.)
- Other information for the calculation which can be specified as an option (for example, any additional not configured programming devices to be taken into account)

You can correct this time but not below the calculated and displayed minimum value.

Influence of Connected Active Nodes (PGs/PCs and I Slaves)

A PG/PC must only be taken into account if it is connected directly to the PROFIBUS via its PROFIBUS interface. It does not need to be taken into account if it is connected via the multipoint interface of the CPU, as shown in the following figure.

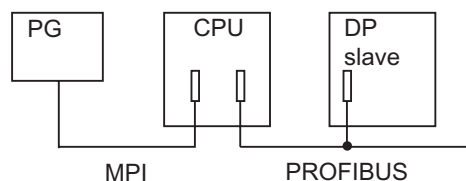

If intelligent DP slaves (for example, CPU 315-2DP) are connected, the time for the DP constant bus cycle should be calculated generously.

Constant Bus Cycle Time Behavior

When recalculating times, STEP 7 recommends a value for the constant bus cycle time. This value is based on the configuration in question. However, you can change this value.

When STEP 7 calculates this value for the constant bus cycle time, it includes in its calculation the user data traffic of the DP master as well as an allowance for a few errors that may possibly occur.

STEP 7 also calculates a minimum value for the constant DP bus cycle time. The cycle time cannot fall below this value. When STEP 7 calculates the minimum value, it considers only the normal message frames for each bus cycle. If errors occur, there may be violations of the constant bus cycle time.

Times that are longer than the recommended times are possible without any problems.



Caution

If you select times that are shorter than the time that the system recommends, under certain circumstances the communication of the additional active nodes that are connected to the PROFIBUS subnet is delayed, or, in the worst case, comes to a standstill. If you set values close to the minimum possible constant bus cycle time that is displayed, bus faults can cause the entire PROFIBUS subnet to be shut down in certain cases.

Relationship: Constant Bus Cycle Time and SYNC/FREEZE

For PROFIBUS-DP, if you configure both "constant bus cycle time" and SYNC/FREEZE groups, note the following:

- Group 8 must not be used (reserved for constant bus cycle time clock). If you configure the group assignment first and have assigned group 8, you can no longer set constant bus cycle time.
- If you configure group 7 when the constant bus cycle time is set, you cannot use the SYNC or FREEZE functions for the slaves in this group.

Procedure

1. Configure a PROFIBUS subnet with a DP master that supports the "constant bus cycle time" function (see the info text in the "Hardware Catalog" window of Hardware Configuration).
2. In the Network view, double-click on the PROFIBUS subnet.
3. In the Properties dialog box ("Network Settings" tab), select the "DP" profile and click the "Options" button.
4. In the "Constant Bus Cycle Time" tab, set the constant bus cycle time behavior that is appropriate for your application and, where necessary, adapt the times to be considered and the connected programming devices/operator panels. You can find detailed information on the possible settings by clicking the Help button in the dialog box. If the "Constant bus cycle time" tab is not displayed, this means that not all the requirements for operation with constant bus cycle time have been met (see above).

Additional Information

You can find more detailed information on setting the constant bus cycle time in the Help for the tab dialogs.

3.12.1 Configuring Short and Equal-Length Process Reaction Times on PROFIBUS DP

Process Reaction Times Without Constant Bus Cycle Time and Isochrone Mode

If a drive engineering or other application requires short and reproducible (that is, repeatable, of equal length) process reaction times, then the individual free cycles of sub-components can have a negative effect on the overall reaction time.

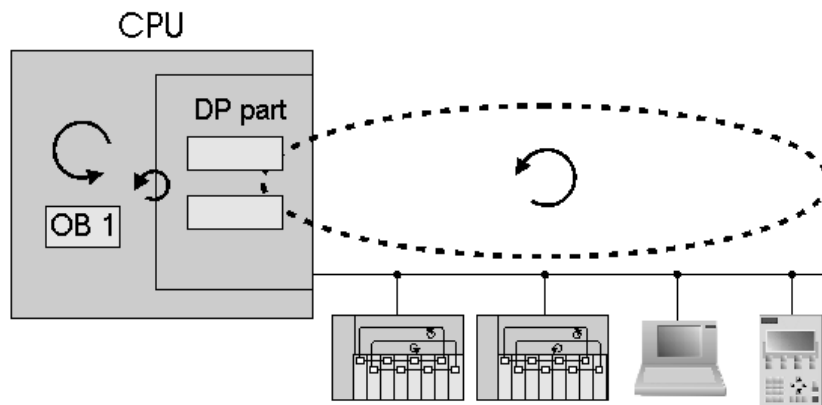

In the previous example, the behavior is depicted without constant bus cycle time and cycle synchronization by using a model structure with a DP master, two DP slaves, a programming device (PG) and an OP. This configuration yields the following subcycles, with their own cyclic and acyclic portions:

- Free OB 1 cycle of the user program. A cyclic program branching can cause variations in cycle time length.
- Free, variable DP cycle on the PROFIBUS subnet consisting of:
 - Cyclic master-slave data exchange, DP slave 1.
 - Cyclic master-slave data exchange, DP slave 2.
 - Acyclic portion for interrupts, bus acceptances or diagnostic services.
 - Forwarding the token to a programming device (PG), followed by its processing.
 - Forwarding the token to an OP, followed by its processing.
- Free cycle on the DP slave backplane bus.
- Free cycle for signal preparation and conversion within the electronic submodules on the DP slave.

If especially short and secure process reaction times are desired, then free cycles with different lengths have a definite effect on process reaction times.

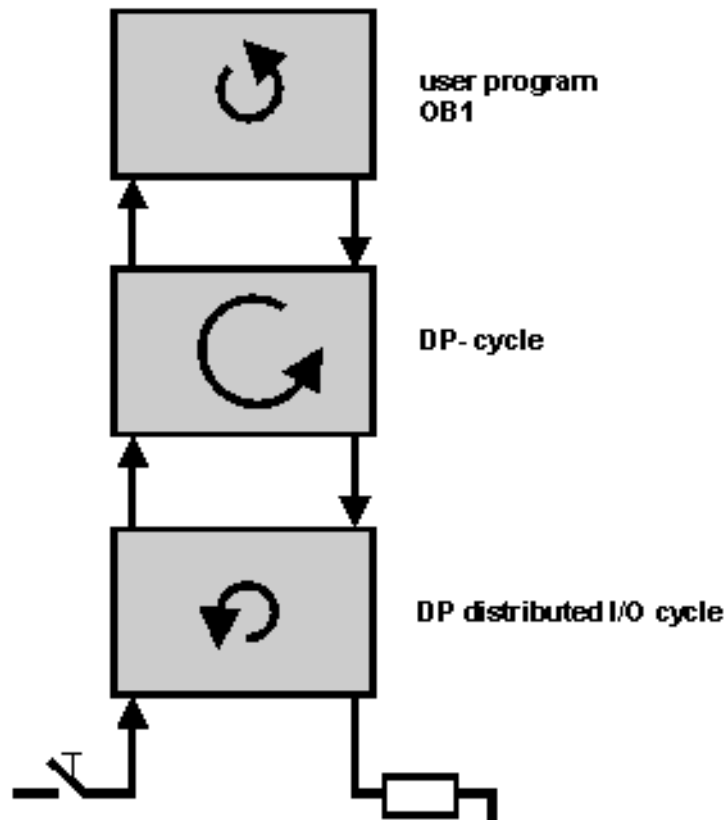

With regard of the individual cycling of the input electronic module, signal or data exchange occurs through the DP slave backplane bus, the master-slave data exchange on the PROFIBUS subnet on to the OB 1 user program on the CPU. The process reaction is determined in the OB 1 user program and is then sent back over the same route to the output electronic submodule. The different lengths and the "random" position of individual cycles have a pronounced effect on process reaction time. Depending on the position of the individual cycles, information transmission can either occur immediately or after two cycles.

Process Reaction Times with Constant Bus Cycle Time and Clock Synchronization

SIMATIC produces reproducible (that is, repeatable, of equal length) reaction times by means of a constant (isochrone) DP bus cycle and synchronization of the individual cycles previously listed.

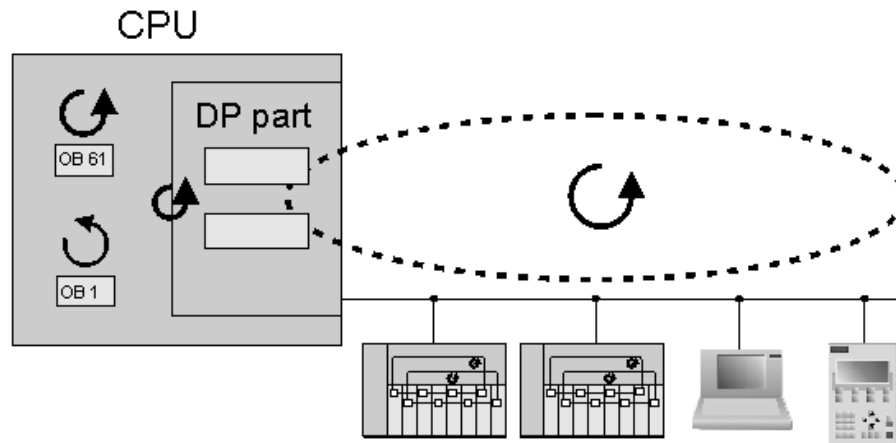

In this case, the situation corresponds to the example given above with the difference that all cycles (up to the OB 1 cycle) are of equal length and synchronously cycled. The clock pulse generator is comprised of the DP master constant bus cycle time clock that is sent as the global control frame to the DP slaves. A synchronous cycle interrupt OB 61 (or OB 61 to OB 64) ensures that it is synchronized with the user program.

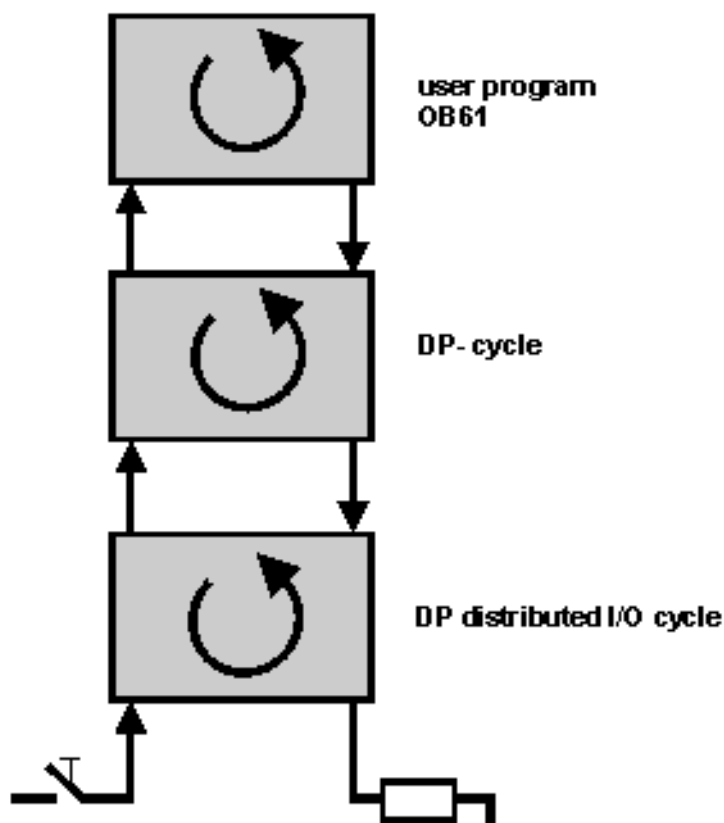

With constant bus cycle time and cycle synchronization, all cycles concerned have the same cycle time and length. This keeps the process reaction times of equal length and, because there are no cycle jumps, they are also shorter. This means that the previously described case in which information transmission can occur in the first or second cycle, depending on the position of individual cycles, now no longer applies.

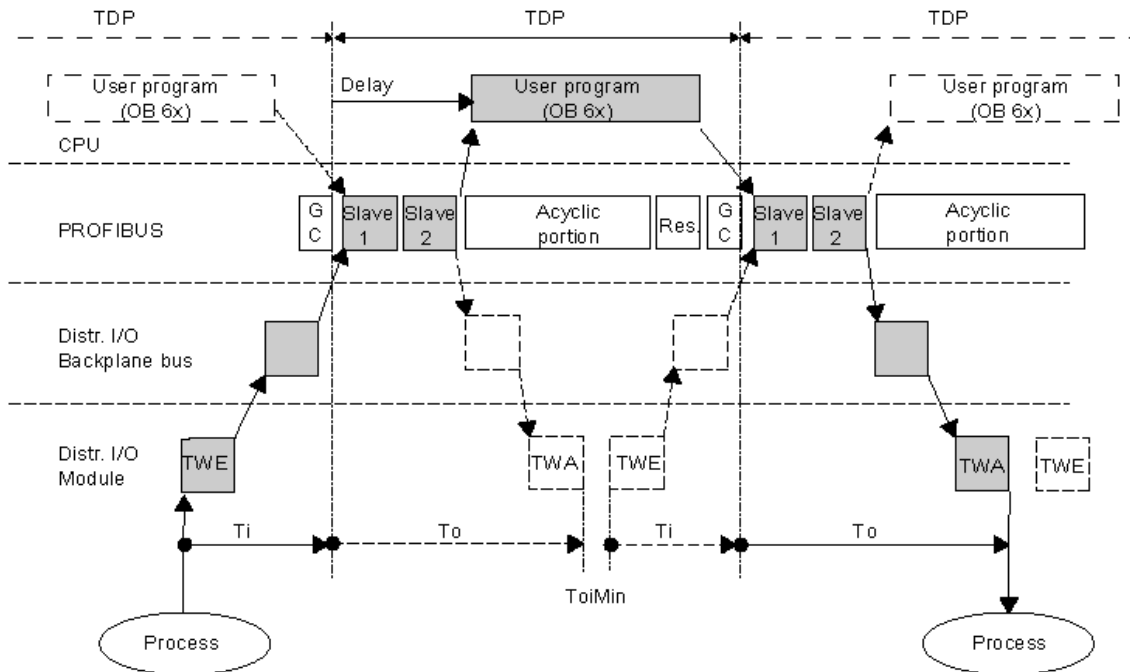

In the previous example, the DP master handles the cyclic master-slave data exchange with slaves 1 and 2. After this comes the processing of the acyclic portions for interrupts, bus acceptances or diagnostic services. The DP master then retains it for a reserve time until the configured constant DP bus cycle time has expired in order to compensate for possible network disturbances and retrieve possible message frame repeats. At this point, a new DP cycle starts with the global frame (GC).

To ensure that consistent status information for the DP inputs can be read at the start time of a new DP cycle, the read process must be moved up by the specified time T_i . This time T_i includes the time for signal preparation and conversion at the electronic submodules and the time for processing at the inputs on the DP slave backplane bus.

When using a SIMATIC WinAC RTX (as of V3.1) the following applies: After the input data for all DP slaves have been read by the DP master, the cycle-synchronized user program is started automatically (OB 6x).

When using a SIMATIC S7-300/400 the following applies: The start of the cycle-synchronized user program is influenced by a configured "time delay".

The time T_o ensures that the process reactions for the user program are sent consistently and in the equal amounts of time to the terminals of the DP I/O devices. This time T_o includes the time for the cyclic master-slave data exchange for all DP slaves, the time for signal preparation and conversion at the electronic submodules and the time for processing at the outputs on the DP slave backplane bus.

The period starting at the point when an input is detected at the electronic module to the reaction at an output results in a constant processing time of $T_i + TDP + T_o$. This condition ensures a constant process reaction time described by: $TDP + T_i + TDP + T_o$.

Prerequisites and General Conditions

- H-systems (redundant/fault-tolerant) do not support cycle synchronization.
- In F-systems, cycle synchronization cannot be used for non-failsafe I/O devices/peripherals.
- Cycle synchronization cannot be used on optical PROFIBUS networks.
- Constant bus cycle time and cycle synchronization are only possible with the "DP" and "User-defined" bus profiles. However, using the "User-defined" profile is not recommended.
- Cycle synchronization is only possible with DP interfaces integrated in the CPU.
- At a cycle-synchronized PROFIBUS-DP, only the constant-bus-cycle-time master can be the active station. OPs and programming devices(PG) (or PCs with PG functionality) influence the timing of the constant-bus-cycle-time DP-cycle. For this reason, they are not recommended.
- Cycle synchronization among chains is not possible at this time.
- Cycle-synchronized I/O devices can only be processed in process image partitions (part process images). Process image partitions are required to achieve consistent, cycle-synchronized data transmission. Without them, consistent, cycle-synchronized data transmission is not possible. To ensure that a process image partition remains consistent, STEP 7 monitors the quantity of data (the number of slaves and number of bytes per process image partition for the DP master system are limited). In addition, please observe the following points:
 - Within a station, input addresses must not be assigned to different process image partitions.
 - Within a station, output addresses must not be assigned to different process image partitions.
 - A common process image partition can be used for both input and output addresses.
- In HW Config, the address of the cycle-synchronized analog I/O devices must be located in the address area of the process image partition.
- Cycle synchronization is only possible with ET 200M and ET 200S devices; synchronization with centralized I/O devices is not possible.
- Full cycle synchronization "from terminal to terminal" is only possible if all components in the chain support the "Isochrone mode" system property. When selecting devices in a catalog or in the hardware catalog, make sure that the information field for the modules contains the entry "Isochrone mode". The latest updated list is available in the Internet at <http://www.ad.siemens.de/support>, Entry ID 14747353.

3.12.2 Assigning Parameters for Constant Bus Cycle Time and Isochrone Mode in HW Config

Introduction

A station consists of the following isochrone components that you have to set up in HW Config:

- CPUs with integrated DP interfaces (i.e. CPU 414-3 DP, V3.1)
- DP interface modules (i.e. ET 200S interface module IM 151-1 High Feature)
- Distributed I/O modules (i.e. DI 2xDC24V, High Feature [131-4BB00], DO 2xDC24V/2A, High Feature [132-4BB30])

The latest updated list is available in the Internet at <http://www.ad.siemens.de/support>, Entry ID 14747353.

The following sections contain information on the special aspects of configuring these components for isochrone mode.

Setting CPU Properties

1. Select the "Synchronous Cycle Interrupt" tab.
2. The following settings have to be made for each synchronous cycle interrupt OB:
 - Specify the DP master system in use.
 - Specify the desired process image partition(s)
 - For S7-400-CPUs: Set the time lag. This time lag is the time between the global control frame and the start of OB 6x. This is the time period in which the DP master completes the cyclical data exchange with the DP slaves.
Tip: After you have finished assigning parameters to the distributed I/O devices, be sure to let STEP 7 calculate the default value.

Settings at the DP Master System

To activate the constant bus cycle time at the DP master system:

1. Double-click the DP master system.
2. In the "General" tab, click on the "Properties" button.
3. In the "Properties - PROFIBUS" dialog box, select the "Network Settings" tab.
4. Select the profile allowed (i.e. "DP")
5. Click the "Options" button.
6. In the "Options" dialog box, select the "Constant Bus Cycle Time" tab and make the following settings:
 - Select the "Activate constant bus cycle" check box. This step activates the constant DP cycle as the basis for maintaining isochrone mode.
 - Select the "Times Ti and To same for all slaves" check box.
 - For the time being, leave the other parameters in their default settings.
7. Close this dialog box and any other open dialog boxes as well by clicking "OK" in each case.

Settings at the Modules in the DP Slave

The address space for each module that is involved in isochrone processing must be assigned to a process image partition. Isochrone read-in and output is can only be done by means of process image partitions.

1. Double-click the module.
2. Select the "Addresses" tab.
3. In the drop-down list, select the process image partition that you assigned to the synchronous cycle interrupt OB when you were assigning parameters to the CPU.

If the addresses for the modules are outside the address range (i.e. for analog modules), then you can either select lower address that lies within the prescribed range of process image partition or change the size of the process image partition so that the address space for the module now lies in the process image partition. If choose to do the latter, go to the "Cycle/Clock Memory" tab and change the "Size of the Process Image" parameter. The value that you set here applies to all process image partitions.
4. To the extent reasonable, keep the "Input delay" parameter for digital input modules as low as possible. This is because short input delays result in a shorter Time Ti and thus in shorter overall reaction times. The critical setting here the longest input delay time for the DP slaves.

Settings at the DP Slave (DP Interface Module)

Isochrone input and output modules have to be made known to the DP interface modules (i.e. IM 151-1 High Feature) as isochrone components. To do so, proceed as follows:

1. Double-click the icon for the DP slave (i.e. IM 151-1 High Feature).
2. In the "Properties - DP Slave" dialog box, select the "Isochrone Mode" tab and make the following settings:
 - Select the "Synchronize DP slave to constant bus cycle time for DP cycle..." check box.
 - Select the modules desired for "isochrone operation." Modules that do not support isochrone mode or for which this option was not selected will not be included in a calculation of the T_i (read in process values) times and the T_o (output process values) times.
3. Confirm your entries and close the dialog box by clicking "OK".

After this, a message will appear to remind you that the T_i and T_o times in the configuration of the DP master system are not yet updated.

Updating the Times (T_i , T_o and the lag time)

To update the T_i and T_o times, go to the "Options" dialog box and select the "Constant Bus Cycle Time" tab, as previously described in the section "Settings at the DP Master System". Then click the "Recalculate" button.

The calculation process will enter a cycle time in the "Constant DP Cycle" field. This cycle time is one that will ensure adherence to the DP cycle time even in the case of strong interference (i.e. EMC related disturbances). Under very stable conditions, this value can be reduced down to the minimum value. The system requires that new values be changed in terms of the specified interval. For this reason, use a stepping switch to change this value. A greater DP cycle time may be necessary to ensure that OB6x has enough calculation time available to it.

During automatic calculation, the values for T_i and T_o are set to their minimum values. These values can also be changed and set within the limits shown. The maximum values for T_i and T_o can be extended by setting a greater constant DP cycle time.

To update the lag time between the global control frame and the call of the synchronous cycle interrupt OB, open the properties sheet for the CPU, select the "Synchronous Cycle Interrupts" tab and then click the "Default" button to have the value recalculated. In some isolated cases, it may be necessary to move up the start of OB6x. In this case, correct the calculated value manually. The value entered is understood to be in milliseconds.

Optimizing the Configuration

To assist you in optimizing the configuration, the "Isochrone Mode" dialog box provides an overview of all clocking-related parameters. To open this dialog box, go to HW Config and select the **Edit > Isochrone Mode** menu command.

The dialog box is divided into a hierarchy containing "PROFIBUS", "Slave" and "Module" display areas. When you select a master system in the "PROFIBUS" area, the "Slave" area will automatically display the associated slaves. Similarly, when you select a DP slave, the "Module" area will automatically display the associated modules. For a detailed description of the columns displayed in the dialog box, see the relevant online help section.

Creating a User Program

Create the required synchronous cycle interrupt OBs (i.e. OB 61).

At the start of the synchronous cycle interrupt OBs, the SFC 126 'SYNC_PI' must be called to update the process image partition for inputs, and at the end of OB 61, SFC 127 'SYNC_PO' must be called to update the process image partition for outputs. The process image partition to be used here is the one configured in the CPU ("Synchronous Cycle Interrupts" tab).

Notes

In particular, the following situation can arise with very short DP cycle times: The runtime of the user program (OB6x with SFC 126/127 called) is greater than the smallest cycle (see the technical data for the CPU, Section "Isochrone Mode"). In this case, you will have manually increase the DP cycle time that was automatically calculated by STEP 7.

The runtime for individual OBs can be determined for different periods of time with SFC 78 'OB_RT' (WinAC RTX only).

3.12.3 Connecting a PG/PC to a Constant-Cycle PROFIBUS network via Industrial Ethernet and an IE/PB Link

The IE/PB link (Version 1.3) can be connected with the DP interface to a constant-cycle PROFIBUS-DP.

This configuration allows you to use the programming device/PC connected to the Industrial Ethernet to access stations on the constant-cycle PROFIBUS-DP (routing).

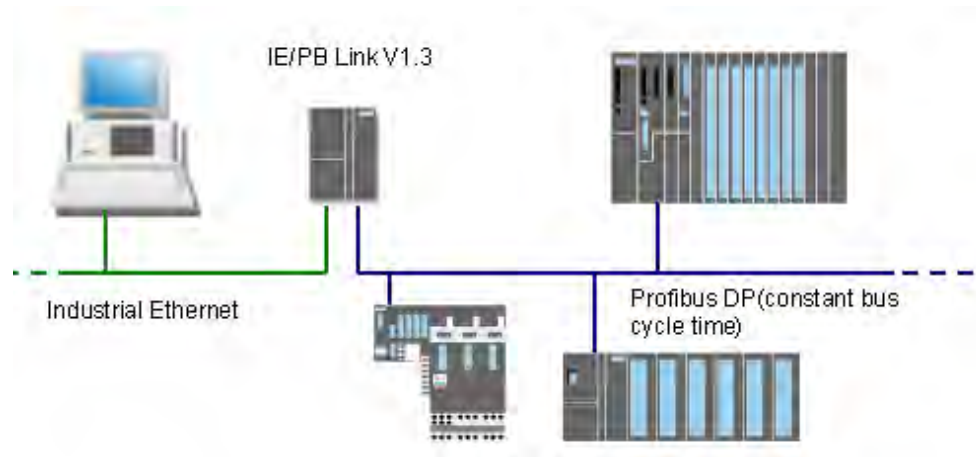

Configuring the IE/PB Link as the S7 Router

To configure the IE/PB link, proceed as follows:

1. Create a station of type SIMATIC 300.
2. Using drag & drop, add the IE/PB-Link (V1.3) to the station.

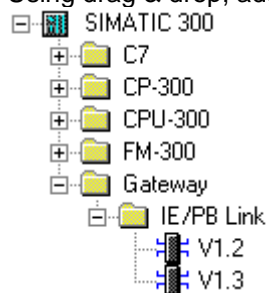

3. When adding the link, you will have to edit dialog boxes as follows:
 - To set the properties for the Industrial Ethernet interface, and
 - To set the properties for the PROFIBUS interface.
 After the IE/PB link has been added, it is in "DP master" operating mode.
4. Double-click the "PROFIBUS/DP" line for the IE/PB link.
5. Select the "Operating mode" tab.
6. Select the "No DP" option.
In this operating mode, the IE/PB link at the PROFIBUS behaves like a programming device/PC.

3.12.4 Shortening the Process Reaction Time by Overlapping Ti and To

If, in your configuration, you select DP slaves that allow overlapping of Ti and To, you can then shorten the DP cycle and, with it, the process reaction time even further.

For example, IM 153-2 (as of 6ES7 153-2BAx1) supports overlapping of Ti and To.

This has no influence on the selection process during configuration, since STEP 7 automatically determines the times and, based on the configuration selected, calculates the shortest possible DP cycle time.

Please note the following for the configuration:

- In the tab "Constant Bus Cycle Time", deactivate the option "Times Ti and To same for all slaves" and set these times for each slave.
- If modules using inputs as well as outputs are to be used in isochrone mode, then overlapping Ti and To times are possible.

Overlapping Processing

The principle governing the overlapping of Ti and To functions as follows.

The peripheral input module is already reading the inputs while the peripheral output module is sending the process reaction from the user program on to the outputs.

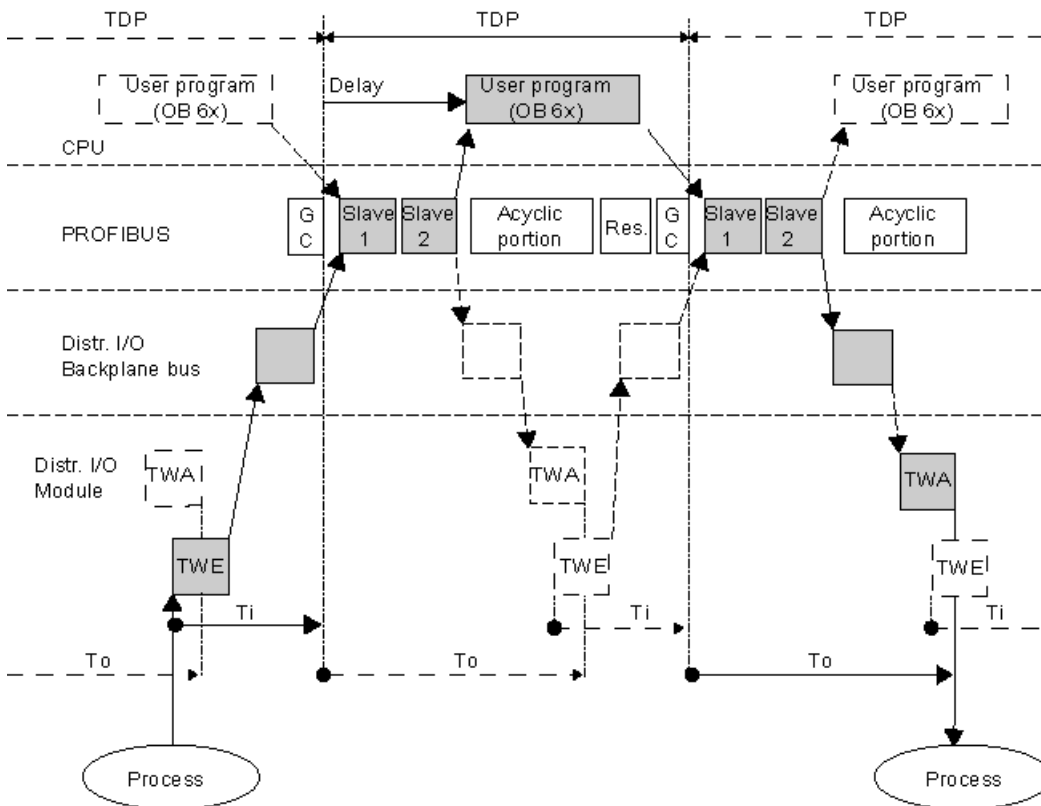

4 Configuring PROFINET IO Devices

4.1 What You Should Know about PROFINET IO

4.1.1 What is PROFINET IO?

PROFINET is the Ethernet based automation standard of the German PROFIBUS User Organization [PROFIBUS Nutzerorganisation e.V. (PNO)] in Karlsruhe, Germany. It defines a communications, automation and engineering model that applies to all manufacturers.

Objectives

The objectives of PROFINET are:

- Consistent, uniform communication over field bus and Ethernet
- Open, distributed automation
- Use of open standards

Architecture

The PROFIBUS User Organization (PROFIBUS International) specifies the following characteristics for PROFINET architecture:

- Communication between controllers as components in distributed systems
- Communication between field devices such as peripheral (I/O) devices and drives

Implementation by Siemens

The requirement for "communication between controllers as components in distributed systems" is implemented by means of "Component-based Automation" (CbA). With "Component based Automation", you create a distributed automation solution based on prefabricated components and parts solutions. You can use SIMATIC iMap as a configuration tool.

The requirement for "communication between field devices" is implemented by Siemens with "PROFINET IO". As with PROFIBUS DP, STEP 7 can be used to fully configure and program the components involved.

The following sections discuss configuring the communication between field devices with PROFINET IO.

4.1.2 PROFIBUS DP and PROFINET IO: Similarities and Differences

Compatibility and continuity – and, in doing so, protecting system investments – characterizes the further development of field technology from PROFIBUS DP to PROFINET IO.

The following section contains an introduction to the new concepts and terminology. It concludes with information on the similarities and differences between PROFIBUS DP and PROFINET IO.

For more detailed information, please refer to the brochure "From PROFIBUS DP to PROFINET IO".

Comparison of the designations used with PROFIBUS DP and PROFINET IO

The following graphic shows the general designations of the most important devices used for PROFIBUS and PROFINET. The table after the graphic lists the names of the individual components used in PROFINET and PROFIBUS.

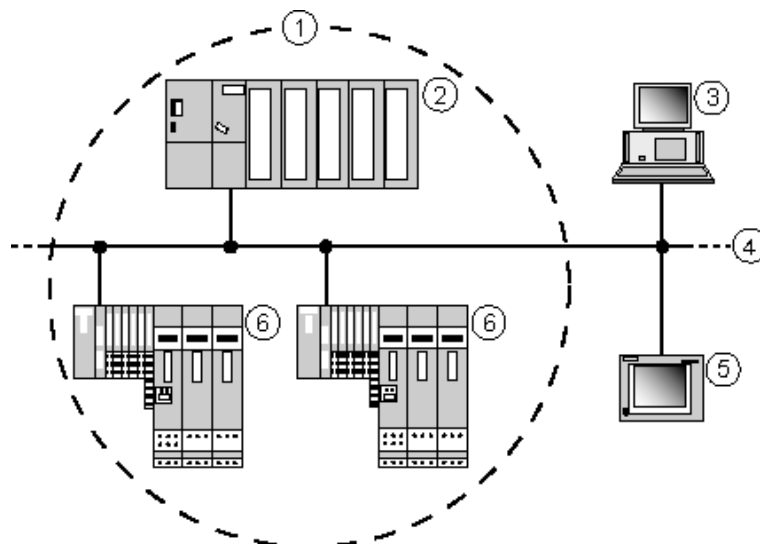

No.	PROFINET	PROFIBUS	Comment
(1)	IO system	DP master system	All IO devices (DP slaves) assigned to an IO controller (DP master)
(2)	IO controller	DP master	Controller in which the user program runs
(3)	IO supervisor (PG/PC)	PG/PC	Initial start up, HMI and diagnostics
(4)	Industrial Ethernet	PROFIBUS	Subnet type
(5)	HMI	HMI	Device for operator control and monitoring
(6)	IO device	DP slave	Distributed field device assigned to a controller (i.e. remote IO, valve terminal, frequency converter)

Note: PG = "Programmiergerät" = "programming device"

Similarities and differences

The following table contains key words and phases pertaining to the fundamental characteristics of field bus systems along with explanations of the similarities and differences between PROFIBUS DP and PROFINET IO from the standpoint of PROFINET IO.

Function	Explanation
Real-time communication	<p>Deterministic, with update times determined by STEP 7 based on the hardware configuration.</p> <p>With PROFINET IO, STEP 7 automatically determines the resulting update time, which can be manually increased, based on the hardware configuration.</p> <p>Since PROFINET IO, in contrast to PROFIBUS DP, is based on another communication process, you do not need to deal with profiles and bus parameters.</p>
Integration of field devices	<p>Done through installation of GSD files for both PROFIBUS DP and PROFINET IO.</p> <p>With PROFINET IO, the GSD files are in XML format, but the files themselves are handled in the same manner as for PROFIBUS DP.</p>
Configuration	<p>PROFINET IO is configured similarly to a DP master system. The only difference has to do with address assignment (due to Ethernet specifications).</p> <p>For detailed information on address assignment, refer to the section in which this topic is discussed.</p>
Slot model	<p>PROFINET IO is based on the slot model of PROFIBUS DP (DPV1): PROFINET interface modules plug into slot "0" of the IO device; the modules or submodules with user data start with slot "1".</p>
Download or download to programming device (PG)	<p>No difference in configuration between PROFINET IO and PROFIBUS DP</p>
Diagnosis	<p>Same diagnostic paths as for PROFIBUS DP (e.g. via station online, via accessible nodes) and options (i.e. module status).</p> <p>Diagnostic extent similar to that for PROFIBUS DP (only the structure of the diagnostic data is somewhat different; only channel diagnosis is possible).</p> <p>The structure of the diagnostic data records is, as with PROFIBUS DP, documented at the field devices (IO devices).</p>
Blocks for the S7 user program and the system status lists (SSL)	<p>Due to the larger data volumes for PROFINET IO, the system function blocks and the standard function blocks have to be adapted or re-implemented.</p> <p>Similar to the situation for the blocks, the system status lists (SSL) were also adapted.</p> <p>The new blocks and SSLs are also available for PROFIBUS DP.</p> <p>The list of the affected blocks and SSLs is in the <i>From PROFIBUS DP to PROFINET IO</i> programming manual.</p>

Note: PG = "Programmiergerät" = "programming device"

4.1.3 Assigning Addresses and Names for PROFINET IO Devices

IP addresses

All PROFINET devices use the TCP/IP protocol; for this reason, they need an IP address when operated on the Ethernet.

To simplify configuration, you will only be prompted once to assign an IP address: when configuring the IO controller in HW Config.

At this point, STEP 7 displays a dialog for selecting the IP address and the Ethernet subnet. If the network is an isolated one, you can accept the default IP address and subnet mask assigned by STEP 7. If the network is part of an existing Ethernet company network, then you will have to ask your network administrator for this data.

The IP addresses of IO devices are generated by STEP 7 and normally assigned to the IO devices at the time the CPU is started up. The IP addresses of IO devices always have the same subnet mask as the IO controller and are assigned, starting from the IP address of the IO controller, in ascending order.

Device names

An IO device must have a device name before it can be addressed by an IO controller. PROFINET uses this method because names are easier to use and recall than complex IP addresses.

Assigning a device name for a specific IO device is comparable to setting the PROFIBUS address for a DP slave.

In their original, delivered condition, IO devices have no device names. IO devices can be addressed by an IO controller only after having been assigned a name by a programming device (PG)/PC, such as for transmitting configuration data (including the IP address) at startup or for the exchanging user data in cyclical operation.

Devices on an Ethernet subnet must have unique names.

If an IO controller in another station is going to be operated at the same time as the IO device (e.g. CP 1616), then in the project the name assigned to this IO device must be the same as the name assigned to the IO controller on the hardware side. This is the only case in which two nodes will have the same device names on the configured Ethernet subnet.

The device names must satisfy DNS conventions:

- Names are limited to a total of 127 characters (letters, numbers, dashes or dots)
- Any component part (that is, a character string between two dots) of the device name may only be up to 63 characters long.
- Names cannot contain any special characters such as umlauts, parentheses, underscores, forward or backward slashes, empty spaces, etc. The dash is the only special character allowed.
- Names must neither start nor end with the "-" sign.

Structured device names

You can also structure the device name according to DNS conventions. To help you in structuring the names, use a period (".") as shown.

...<Subdomain Name>.<Domain Name>.<Top Level Domain Name>

STEP 7 supports you here by providing a prompt-driven dialog for using the name of the IO system in the device name:

<Name of specific device>.<Name of IO system>

You can set the name of the IO system at central location in the property dialog of the IO system.

When you copy an IO device to another IO system, STEP automatically applies the name of the IO system into which the device was inserted.

Device number

In addition to the device name, STEP 7 assigns a device number to the device when it is inserted. These numbers start with "1".

These device numbers are used to identify IO devices (e.g. SFC 71 "LOG_GEO") in the user program. Unlike the device name, the device number is not visible in the user program.

4.1.4 Integrating Existing PROFIBUS DP Configurations

Connecting PROFINET and PROFIBUS

PROFIBUS devices can be connected to the local PROFIBUS interface for a PROFINET device. In this way, you can integrate already existing PROFIBUS configurations into PROFINET.

The following illustration shows the network types supported for PROFINET: Industrial Ethernet and PROFIBUS.

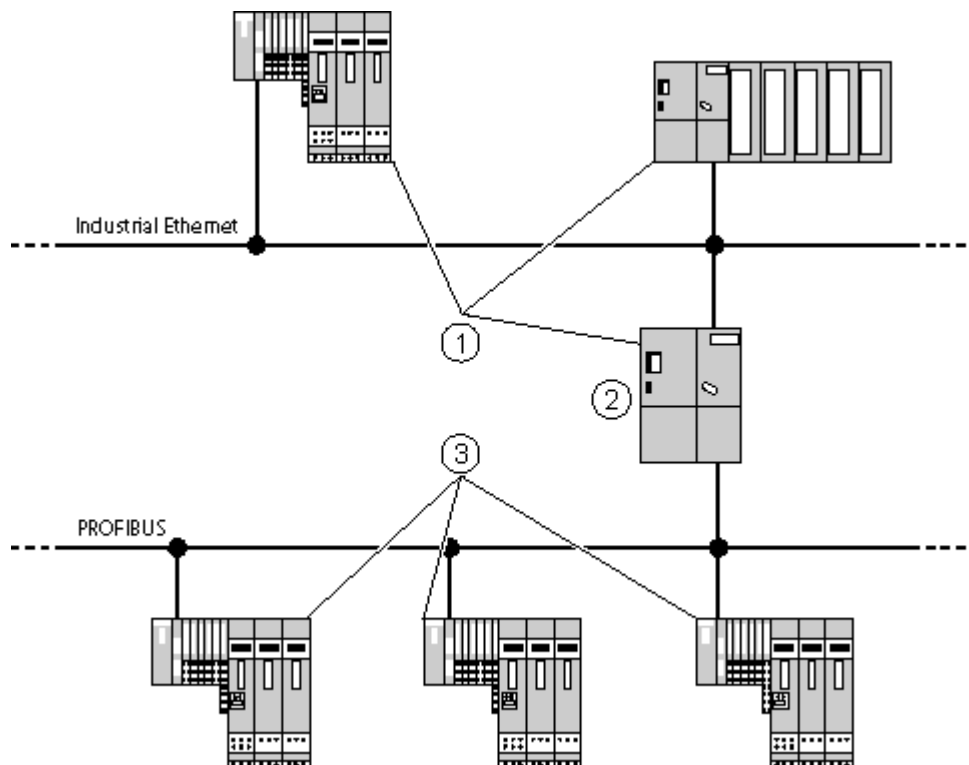

No.	Description
(1)	PROFINET device
(2)	PROFINET device with proxy functionality (e.g. IE/PB link)
(3)	PROFIBUS devices

PROFINET devices with proxy functionality = Generic

The PROFINET device with proxy functionality is the substitute equivalent of a PROFIBUS device on the Ethernet. The proxy functionality allows a PROFIBUS device to communicate not only with its master but also with all nodes on PROFINET.

With this proxy functionality, there are no problems in integrating existing PROFIBUS systems into PROFINET communication.

For example, if you connect a PROFIBUS device to PROFINET by means of an IE/PB link, the IE/PB link establishes the communication via PROFINET as a substitute for the PROFIBUS-components.

4.1.5 Update Times For Cyclical Data Exchange

Because of the fully different kind of communication process used with PROFINET IO, you do not have deal with a series of bus parameters, unlike with PROFIBUS DP.

However, just like with PROFIBUS DP, STEP 7 automatically determines a time period within which a PROFINET IO device has exchanged its user data with the associated IO controller: this is known as the "update time".

Based on the hardware configuration in use and the resulting amount of cyclical data, STEP 7 automatically calculates update times, which you can increase manually if necessary. You can set equal update times for all IO devices in the PROFINET IO system or set individual times for each IO device.

If you consider a single IO device in the PROFINET IO system, the IO controller provides this IO device with new data (outputs) within this update time, and the IO device has sent its latest data (inputs) to the IO controller within this time.

Properties of the update time

The update times can only be set in certain fixed intervals (time bases). The values that are considered are determined by STEP 7 from the properties (that is, from the GSD files) of the IO devices concerned.

If you change the hardware configuration, such as by adding new IO devices, the update time may have been changed. If so, the next time you open the dialog, a message will inform you that a change has been made.

What factors influence the update time?

- The number of IO devices
- The number of inputs and outputs
- The percentage of time reserved for PROFINET IO
- The properties (performance) of the IO controller
- The IRT time (if isochronous realtime communication was configured)

Reading and setting the update time globally from a central location

To open the dialog to read and change the update time, proceed as follows:

1. Double-click the IO system (the "railroad track").
2. Select the "Update Time" tab.
 - If, in addition to PROFINET IO, other cyclical services (i.e. from Component-based Automation, CBA) have to be taken into consideration: Go to the "Communication Component (PROFINET IO)" field and select a percentage that should be reserved for PROFINET IO.
If at least one IO device is configured, then the default setting is 100%.
If no IO device is configured, then the default setting is 0%.
 - Select the desired option for setting the update time: for the entire IO system or for a specific device.
3. If you like, you can increase the update time (for the entire IO system or for a specific IO device).

Tip

Regardless of the option that you select: the dialog always shows the calculated or already configured update times. This applies to a setting for the entire IO system or a setting for a specific IO device.

Reading and setting the update time at the IO device

To open the dialog to read and change the update time for specific IO device, proceed as follows:

1. Double-click the IO device.
2. Select the "IO Cycle" tab.
3. Check the current setting for the update time. If necessary, change it and then confirm the settings with "OK".

4.1.6 Setting a Specific Update Time for an IO-Device

With STEP 7 V5.3, Service Pack 1, you can set an update time that applies to all IO devices in a PROFINET IO system. In this case, the slowest IO device will determine the update time, even if shorter update times would be possible for individual IO devices.

As of STEP 7 V5.3, Service Pack 2, you have the option of setting separate update times for individual IO devices. This option is called "Set a specific update time for an IO device". The option of setting a uniform update time for all IO devices is still available. This option is called "Set update time for all IO systems".

Procedure

1. Double-click the IO system (the "railroad track").
2. Select the "Update Time" tab.
 - If, in addition to PROFINET IO, other cyclical services (i.e. from Component-based Automation, CBA) have to be taken into consideration: Go to the "Communication Component (PROFINET IO)" field and select a percentage that should be reserved for PROFINET IO.
If at least one IO device is configured, then the default setting is 100%.
If no IO device is configured, then the default setting is 0%.
 - Select the "Set a specific update time for an IO device" (if it is not already selected by default).
 - The IO devices are listed in the field below. STEP 7 has already calculated an optimal update time for each IO device.
The update times for IO devices that do not exchange user data (e.g. a switch) are identified with an asterisk (*). As a rule, the update times for these PROFINET devices are higher than those for the remaining IO devices.
 - If necessary, sort the information displayed in a column by clicking the column header. To display the information in the opposite sequence, click the column header again
 - To change the update time, double-click the row with the desired device number.

Tip

To set the update time at once for several IO devices, select the IO devices concerned (multiple selection) and click the "Edit" button". To select multiple devices, you can select each one in sequence while holding the CTRL key down.

Optimizing the update times for individual IO devices

Based on the configuration, STEP 7 calculates the optimized (the shortest possible) update times. However, by increasing the update times for individual IO devices that supply data that do not have to be absolutely available at a definite time (not time-critical), you can expand the leeway available in order to allow shorter update times for other IO devices.

4.2 Steps For Configuring a PROFINET IO System

4.2.1 Overview: From Configuration To Cyclical Data Exchange

The following sections describe the basic steps required to place a PROFINET IO system in operation. It tells you how to configure PROFINET components, assign addresses and how the system starts.

Configuring an IO system in HW Config

1. Assign parameters to an IO controller (i.e. CPU 317-2 PN/DP) in HW Config. While assigning the interface parameters, assign an Ethernet subnet and an IP address.
2. Arrange all required IO devices in the IO system ("railroad track").
3. For each IO device: check the device name, and, if necessary, change it and set its parameters.

Assign addresses

1. Each IO device must have the configured device name assigned to it.
2. Download the hardware configuration while the CPU is in STOP mode. The configured IP address is automatically assigned to the PN interface (e.g. a CPU) when the hardware configuration is downloaded.

Startup

At startup, the CPU transfers the downloaded configuration via the PN interface to the IO devices. As with PROFIBUS DP, the "Finished" message by modules" and "Transfer of parameters to modules" monitoring times that are assigned as parameters apply here as well.

At startup, the CPU can identify the IO devices by their device names and automatically transfer the associated IP addresses.

After the addresses and parameters have been successfully transferred within the monitoring times, the PROFINET devices start their cyclical data exchange.

If the addresses and parameters were not successfully transferred, the CPU goes into STOP or RUN mode, depending on the setting of the "Startup when expected/actual config. differ" parameter.

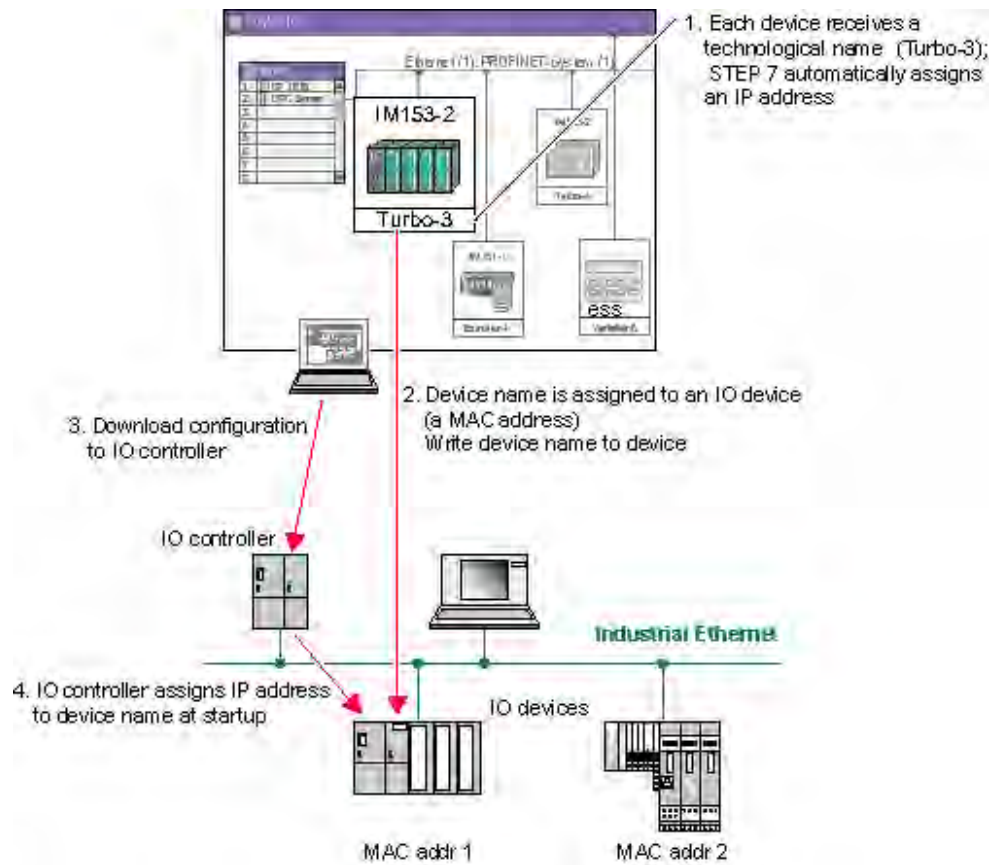

4.2.2 Basic Procedure for Configuring a PROFINET IO System

If you know how to configure a PROFIBUS DP system, then you already know how to configure a PROFINET IO system – the procedure is largely the same.

Station window as an image of the real IO system

When have placed an IO controller (e.g. a CPU 317-2 PN/DP) in position, STEP automatically draws a line that represents the IO system. You then place the IO devices to be assigned to this IO controller in position by using drag-and-drop to move them there from the "Hardware Catalog" window in "PROFINET IO".

When an IO device is put in position, a name is automatically assigned to it (the default name is the name in the GSD file).

STEP 7 also automatically assigns an IP address. Starting with the IP address of the IO controller, STEP 7 searches for the next available IP address. However, this IP address is not relevant when handling the objects when configuring the system. Nevertheless, it is necessary because all nodes on Ethernet with TCP/IP protocol must have an IP address.

In addition, STEP 7 assigns device number that you can use to work with the device in the user program (e.g. with SFC 71 "LOG_GEO"). This number is also displayed in the symbol for the IO device.

The IO device does not appear in the "Hardware Catalog" window

If an IO device does not appear in the "Hardware Catalog" window, then you need to install the corresponding GSD file after STEP 7 has been started (menu command: **Options > Install GSD File**). Follow the dialog prompts to install the new GSD file. The newly installed IO device then appears in the "Hardware Catalog" window under "PROFIBUS IO", either under the name of the device family (for Siemens devices) or under "Additional Field Devices."

The screenshot displays the SIMATIC Manager interface. On the left, a rack configuration window shows modules in slots 1 through 8: PS 307 5A, CPU 317-2 PN, MPI/DP, PN-IO, CP 343-1 IT, and AI2x12Bit. In the center, a network diagram shows an Ethernet(1) PROFINET-IO-System (100) connected to a PROFIBUS(1) DP master system, which includes IM151-3 and IE-PB modules, and two ET 200S stations. On the right, the Hardware Catalog window is open, showing a tree view of device families including PROFIBUS DP, PROFIBUS-PA, PROFIBUS IO, Additional Field D, Gateway, I/O, ET200S, SIMATIC 300, SIMATIC 400, SIMATIC PC Based C, and SIMATIC PC Station. Below the rack configuration, a detailed view for the selected IM151-3PN module is shown in a table format.

Slot	Module	Order Number	I Address	Q address	Diagnostic addr...
0	IM151-3PN	6ES7 151-3AA00-0AB0			8188*
1	PM-E DC24V / AC	6ES7 138-4CB10-0AB0			8187*
2	2DO DC24V/2A H	6ES7 132-4BB30-0AB0		1	

Configuring the IO device in the detailed view

When you select an IO device, then the configuration (slots with modules/submodules) and I/O addresses are displayed in the detailed view of the station window.

4.2.3 Creating a PROFINET IO System

Requirement

You have arranged a module rack in the station window, and it is now opened (slots in the rack are visible).

PROFINET IO Controller

You can use the following devices as an IO controller:

- A CPU with an integral or insertable PROFINET interface (integral, such as CPU 317-2 PN/DP)
- A CP along with a CPU (e.g. CP 443-1 Advanced connected to a suitable S7-400-CPU)
- A PC station (e.g. with CP 1612)

Procedure

1. In the "Hardware Catalog" window, select an IO controller (e.g. CPU 317-2 PN/DP).
2. Drag-and-drop the module to a permissible row in the module rack. The "Properties – Ethernet Node" dialog box then opens. Here you can do the following:
 - Create a new Ethernet subnet or select an existing one
 - Set the properties for the Ethernet subnet (such as the name)
 - Set the IP address of the IO controller
3. Confirm the settings with "OK"

The following symbol appears for CPUs with an integral IO controller:



This symbol is the "peg board" for the IO devices in the IO system.

External IO Controllers

CPs that can be used as external IO controllers support numerous options for communications. As such, they are not "predetermined" for use as IO controllers.

If you use an external IO controller (e.g. CP 443-1 Advanced), then you have to insert an IO system after inserting the IO controller (context menu command: "Insert PROFINET IO System").

4.2.4 Selecting and Arranging IO Devices

The procedure for selecting and arranging IO devices is essentially the same as the one for PROFIBUS DP.

Requirement

An IO system must be available and visible in the station window.

Procedure

1. As with PROFIBUS DP, you will find the IO devices (correspond to the slaves used with PROFIBUS DP) in their own catalog section called "PROFINET IO". Open the folder desired under "PROFINET IO".
2. Drag-and-drop the IO devices to position them or double-click an IO system.
3. If you are dealing with a modular IO device, then insert the required modules or submodules into the IO device.

The IO devices are represented with symbols in the station window, much like the slaves on PROFIBUS. A symbols contains the device number (possibly abbreviated) and the device name.

Configuring IO devices

IO devices have property sheets in which you can change the address information (device number and device name) automatically assigned by STEP 7 when the device is inserted as well as the diagnostic address of the IO device.

In such a property sheet you can start the dialog for changing the interface and the subnet properties. To do this, click the "Ethernet" button in the property sheet. The dialog box that then appears contains the IP address, which you can then change.

Depending on the IO device, you can select a check box to disable the assignment of the IP address by the IO controller.

Parameters that apply to the entire IO device can be set in this dialog box. The properties of an IO device are determined by its associated GSD file.

Navigation options

To locate IO devices quickly, you can select the **Edit > Go To > Ethernet Node** menu command. The dialog box that is then displayed lists all IO systems and the IO devices connected to them. For IO systems, the associated subnet is shown. For IO devices, the designation (device name), device number and the IP address are shown.

4.2.5 Where Are The IO Devices Located In The Hardware Catalog?

All IO devices are shown in the Hardware Catalog under "PROFINET IO".

The structure of the Hardware Catalog is determined only by the GSD files. If several GSD files for an IO device family are available in STEP 7 data management (e.g. caused by importing different file versions), then the last (that is, the most recent) version is always used to display the device properties.

IO devices made by Siemens appear directly in "PROFINET IO" below the folder with the name for the respective device family (e.g. ET 200S).

If other GSD files are available for the device family, they are also displayed in the Hardware Catalog under their family name in a "GSD" subfolder. The non-GSD variants offer easy and convenient options for configuring (such as easier packing of addresses, etc.).

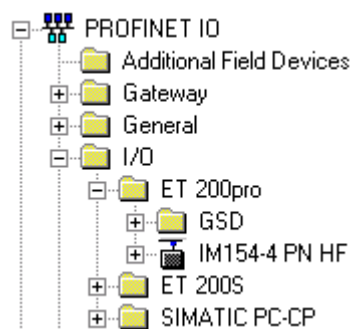

Other IO devices installed with a GSD are displayed under "Additional Field Devices".

In the case of modular IO devices, the insertable modules/submodules are located below the IO device interface modules.

4.2.6 Handling PROFINET IO Systems

Designations for IO Systems

The designations of IO systems are structured similarly to those used for DP master systems:

The first part of the name designates the Ethernet subnet. This part is followed by a colon (":").

The second part of the name consists of the designation "IO system", followed by the number of the IO system in parentheses. While the numbering for DP master systems starts with "1", STEP 7 starts numbering IO systems with "100".

Changing the settings of an IO system

In addition to the name and number, the changeable properties of an IO systems also include the update time.

To change the settings, proceed as follows:

1. Double-click the IO system ("railroad track")
2. Select the appropriate tab
(the "General" tab to change the name and the IO system number, or the "Update Time" tab to read or change the update time for the IO system).

Disconnecting an IO system

As with a DP master system, you can also disconnect an IO system. To do so, select the **Edit > PROFINET IO > PROFINET IO System > Disconnect** menu command.

The IO system then remains as an "orphaned" IO system and is visible in the station.

If the IO system has no IO devices on it, the IO system is deleted.

Inserting an IO system

If you have configured one or more IO systems and then disconnected them from the PROFINET interface, you can insert one of the "orphaned" IO systems back into the selected PROFINET interface. To do so, select the **Edit > PROFINET IO > PROFINET IO System > Insert** menu command.

4.3 Examples of Configurations with PROFINET IO

- Configuration with an Integrated IO Controller
- Configuration with an External IO Controller
- Configuration with IE/PB Link
- Configuration with SIMATIC PC Stations

4.3.1 Configuration with an Integrated IO Controller

Whenever a CPU is inserted into an integrated IO controller (e.g. CPU 317-2 PN/DP), STEP 7 automatically creates an IO system. You can then drag-and-drop the desired IO devices from the Hardware Catalog to this PROFINET IO system.

The screenshot displays the SIMATIC Manager interface. On the left, a rack configuration table shows the following modules:

Slot	Module
1	PS 307 5A
2	CPU 317-2 PN DP
X1	MPI/DP
X2	PN-IO
3	
4	CP 343-1 IT
5	AI2x12Bit
6	
7	
8	
9	

The main diagram shows the hardware configuration for the IM151-3PN module. It is connected to an Ethernet network (100) and a PROFIBUS network (DP master). The hardware catalog on the right shows the configuration of the IM151-3PN module, including its slot, module name, order number, and I/Q addresses.

Slot	Module	Order Number	I Address	Q address	Diagnostic addr...
0	IM151-3PN	6ES7 151-3AA00-0AB0			8188*
1	PM-E DC24V / AC	6ES7 138-4CB10-0AB0			8187*
2	2DO DC24V/2A H	6ES7 132-4BB30-0AB0		1	

4.3.2 Configuration with an External IO Controller

CPs that can be used as external IO controllers, support numerous communications options. For this reason, they are not "predetermined" to be used as IO controllers.

If you use an external IO controller (e.g. CP 443-1 Advanced), then after inserting the controller, you must insert an IO system (context menu command: "Insert PROFINET IO System").

You can then drag-and-drop the desired IO devices from the Hardware Catalog to this PROFINET IO system.

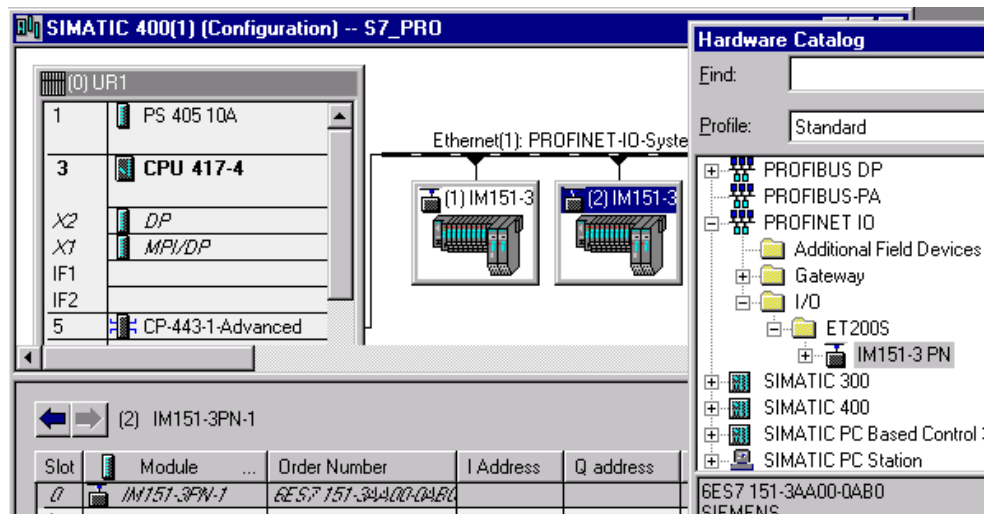

4.3.3 Configuration with IE/PB Link

You can use the IE/PB link to connect PROFIBUS DP configurations to PROFINET IO.

From the standpoint of the CPU, PROFIBUS DP slaves are on the same network as the IE/PB link. These slaves have the same device names and IP addresses as the IE/PB link, but do have different device numbers. In addition, they also still have specific PROFIBUS addresses.

In addition to the device number, the symbol for the IE/PB link also shows the PROFIBUS address, since this device has two address schemas.

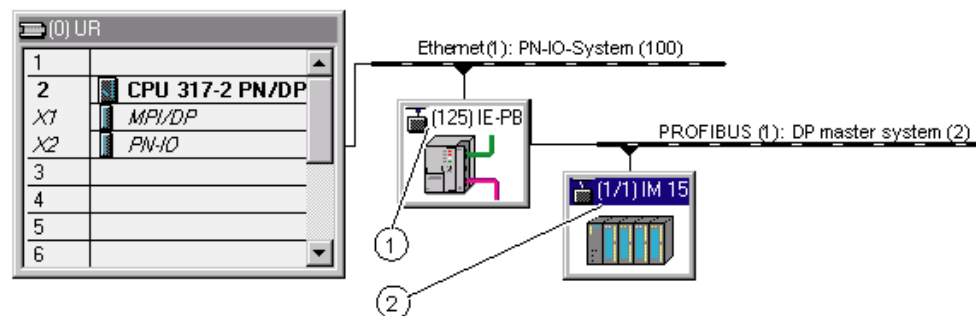

(1) Device number of the IE/PB link

(2) Device number and PROFIBUS address of the DP slave

Handling device numbers and PROFIBUS addresses at the master system

When IO devices are positioned, STEP 7 assigns the same number for the device number and the PROFIBUS address.

To get an overview of the device numbers and the PROFIBUS addresses being used, double-click the symbol for the IE/PB link and select the "Device Numbers" tab.

Each line in the "Device Numbers" tab represents a DP slave. If you select a line and then click the "Change" button or double-click a line, a dialog box is displayed in which you can change the device number.

You can change the PROFIBUS address in the usual manner:

1. Double-click the symbol for the DP slave to display its properties dialog.
2. In the "General" tab, click the "PROFIBUS" button.
3. In the next dialog box, change the PROFIBUS address.

Restrictions

The configuration described above applies to DP slaves on the PROFIBUS subnet of an IE/PB link, subject to the following restrictions:

- No IE/PB link can be inserted
- No DP/PA link can be inserted
- No Y-link can be inserted
- No CiR compatibility
- No redundant slaves can be inserted
- No isochrone mode/constant bus cycle time can be configured

4.3.4 Configuration with SIMATIC PC Stations

A "PC station" is a PC with communications modules and software components within an automation solution with SIMATIC.

By using appropriate communications modules and software components you can operate a PC stations as a PROFINET IO controller.

Your PC applications in the PC station can access the PROFINET IO controller in the following ways:

- As an OPC client over the PROFINET IO OPC server
- Directly over the PROFINET IO user interface (RTE base programming interface)

Only one of these access options can be used by PC applications at any one time (open/close sequence).

Functions	PROFINET IO OPC Server	RTE Base Programming Interface
Read and write IO data	Yes	Yes
Read and write data records	Yes	Yes
Receive and acknowledge interrupts	No	Yes

The following illustration shows a PC station with the components described. The lower illustration shows the corresponding configuration of the station in HW Config.

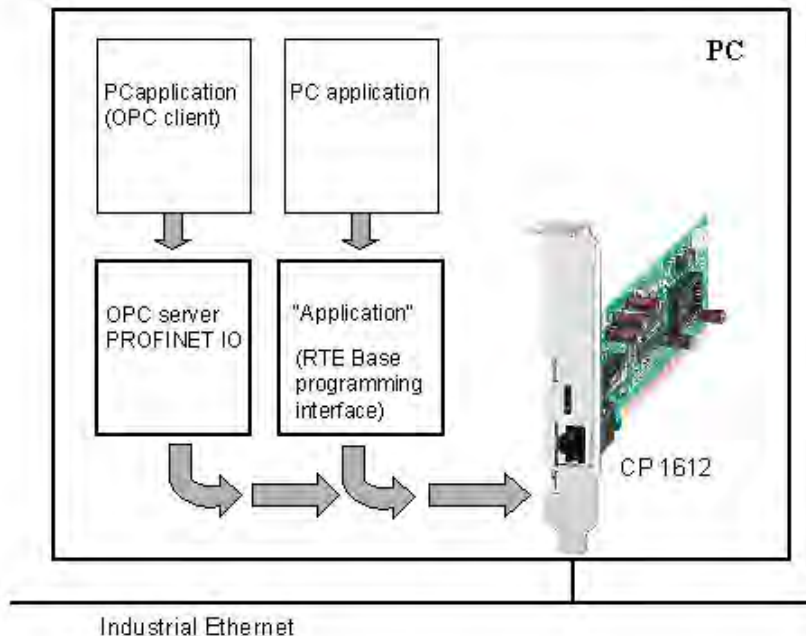

Configuring in HW Config

As with other types of stations, the IO devices to be addressed are assigned to the IO system of the IO controller (here CP 1612).

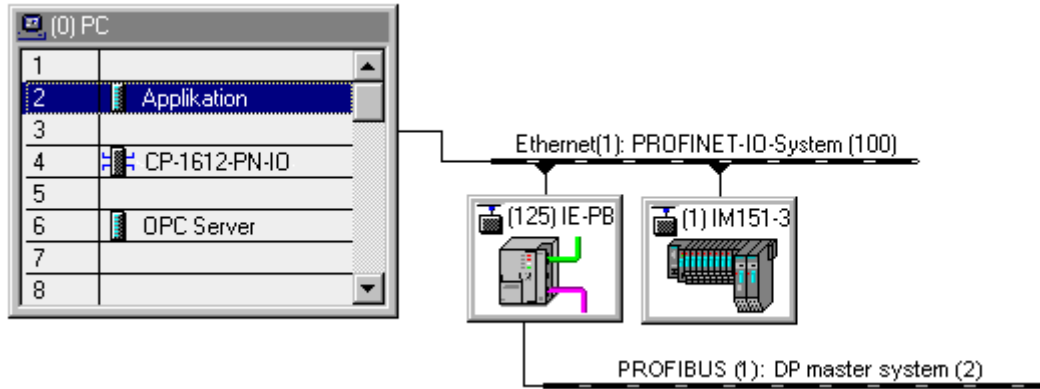

4.4 Placing PROFINET IO Devices in Operation

4.4.1 Accessing PROFINET IO Devices Online via Ethernet

Requirements

You have set up the programming device (PG)/PC interface to work with a TCP/IP interface card, which means that the Ethernet interface of your programming device (PG)/PC can be accessed from STEP 7.

Be sure to observe the guidelines for connecting your programming device (PG)/PC to the CPU. For CPU 317-2 PN/DP, both devices (CPU and PG/PC) must be connected to one switch.

It may be necessary to adjust the properties of the Ethernet interface in the Control Panel of the programming device (PG) (the properties of the Internet Protocol (TCP/IP)). If, in addition to the programming device (PG), you have only connected S7-CPU and PROFINET IO devices, you must not enable the "Obtain an IP address automatically" option in Windows.

Online access as with MPI or PROFIBUS

The commands in the "PLC" menu used to establish online access to IO devices can be used in all applications that provide this menu, such as in HW Config, in the SIMATIC Manager and in NetPro.

In general, you have the same options via Ethernet (PROFINET) as you do with other online paths (MPI or PROFIBUS).

Exceptions

Special functions not available over PROFINET:

- The menus available through **PLC > PROFIBUS** only apply to PROFIBUS
- Prepare line diagnostics (only suitable for diagnostic repeaters on PROFIBUS DP)

4.4.2 Displaying Ethernet Nodes in the "Accessible Nodes" Window

Requirements

You have set up the programming device (PG)/PC interface to work with a TCP/IP interface card, which means that the Ethernet interface of your programming device (PG)/PC can be accessed from STEP 7.

For an online connection via the "Accessible Nodes" window, the programming device (PG)/PC and "Accessible Nodes" must be connected to the same physical Ethernet subnet.

If nodes are only accessible via intermediate switches or routers (with the use of a protocol), they will not be displayed in the list of "Accessible Nodes".

Nodes displayed

The following components are shown in the "Accessible Nodes" window:

- S7-CPs
- S7-CPU
- SIMATIC PC stations
- SIMATIC network components (PROFINET devices)
- All PROFINET devices (in general, all devices that support the DCP protocol)
- IE/PB link with its subordinate DP slaves

Depending on the type of component, there may be more less information displayed in the detailed view of the "Accessible Nodes" window.

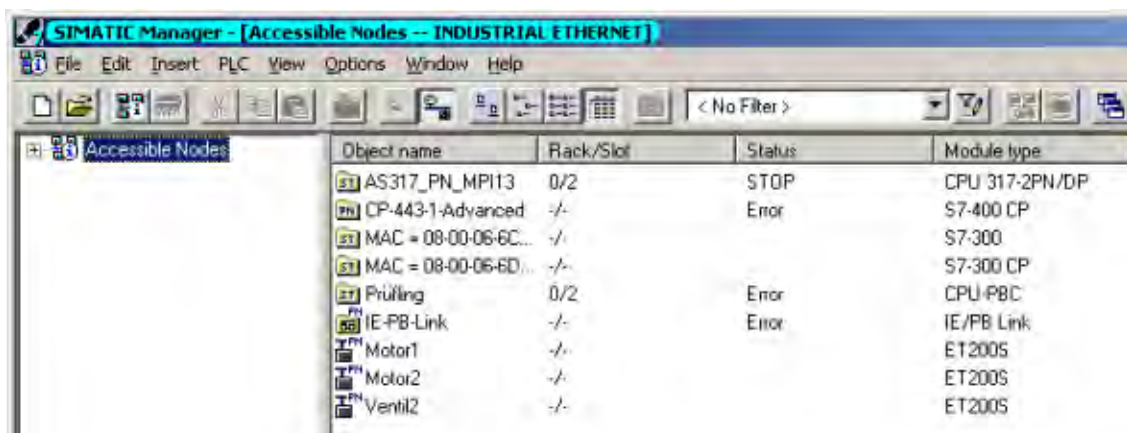

The following table shows what information is displayed in the "Object Name" column:

Accessible Nodes is...	Displayed in the "Object Name" column	Explanation
PROFINET IO device with assigned device name	Device name	IP address and MAC address can be determined in a properties dialog. The "Details" view also shows the device type as well as status information (e.g. IP addresses inadvertently assigned twice ("doubled-up"), errors, etc.).
PROFINET IO device without assigned device name	IP address	As a substitute (for an unassigned IP address) the MAC address is displayed.
S7 CP	Name (of the station)	Only if an IP address was assigned to the CP; otherwise, MAC address. The "Details" view also shows the operating mode and the module type.
S7 CPU, PC stations	Name (of the station)	The "Details" view also shows the operating mode and the module type, and, if available, information from the associated STEP 7 project (station name, CPU name, plant designation).
IE/PB link	See PROFINET device	Special issue: if you select the IE/PB link in the "Accessible Nodes" list, the detailed list then displays the connected DP slaves along with their PROFIBUS addresses as well as other information.
Other nodes (no S7 nodes or devices with DCP protocol)	----	Cannot be displayed

Calling diagnostic functions

You can perform system diagnostics from the "Accessible Nodes" window. To do so, proceed as follows:

1. Select the component to be diagnosed.
2. Select the appropriate menu command (menu: **PLC > Diagnostics/Settings > ...**).

As of STEP 7 V5.3 Service Pack 2, the "Module Information" diagnostic function can also be used for DP slaves "behind" the IE/PB link; that is, for those devices that are not directly connected to the Ethernet.

4.4.3 Downloading to PROFINET IO Devices

Downloading to the CPU serving as IO controller for the first time in HW Config

After you have configured the whole IO system, you now have to download this configuration to the CPU. In this way, the IP address is assigned to the CPU (or more exactly: the IO controller).

Before starting the download, you should perform a consistency check in order to have the configuration checked for addresses that have been used twice and names that are not unique.

Find out if the CPU to receive the download can be downloaded to for the first time via the PROFINET interface. If not, you will then have to first download the hardware configuration via the MPI interface.

The following description of the procedure presumes that there is a connection existing between the programming device (PG) and the CPU via Ethernet.

1. Select the **PLC > Download** menu command.
2. Select the modules to be downloaded to.
3. If necessary, in the "Select Station Address" dialog box, click the "Display" button to display the modules that are actually accessible (including the CPU to receive the download with its current IP address or its MAC address if an IP address is still not available).
4. In the accessible modules, select the CPU to receive the download . This module is then displayed in the "Enter connection to target station" field.
5. Start the download by clicking the "OK" button.
During this process, the CPU (i.e. the IO controller) also gets its configured IP address assigned to it.

Downloading to the CPU serving as IO controller for the first time in the SIMATIC Manager or NetPro

As an alternative method, you can download to the station (with the CPU of the IO controller) in the SIMATIC Manager or NetPro (menu command: **PLC > Download**).

If you trigger the download in the SIMATIC Manager, the configuration must have already been compiled (in HW Config or NetPro).

If you download in the SIMATIC Manager or in NetPro, the "Select Station Address" dialog box is also displayed since the configured IP address no longer matches the actual IP address. In this case, proceed as described in the previous section in order to reach the modules to be downloaded.

Assigning a device name to an IO device (online)

In order for the configured CPU to be able to address the PROFINET IO devices, you must assign the configured device name to each individual IO device.

In order to use the following procedure, the IO devices must be accessible online for the programming device (PG)/PC on the Ethernet.

Procedure

1. In HW Config or in NetPro, select the **PLC > Ethernet > Assign Device Name** menu command
2. In the "Assign Device Name" dialog box, go to the "Device Name" field and select a device. Then, in the "Available Devices" field, select the device to receive the selected device name.
3. To make the device easier to identify, click the "Flashing" button to cause a display LED in the selected device to flash.
4. Click the "Assign Name" button.
5. Repeat steps 2 through 4 until you have assigned a name to all the devices.

Starting the CPU

After the names are all assigned, you can put the CPU into RUN mode.

At startup, the CPU distributes the configuration information to the IO devices and then goes into cyclical operation.

4.4.4 Assigning Device Names via a Memory Card (MMC)

As of STEP 7 V5.3 SP2, you can also configure the device names of PROFINET IO devices offline.

To do this, you save a configured device name to an MMC and then insert the MMC into the appropriate IO device.

If a device becomes defective and an IO device has to be completely exchanged, the IO controller automatically assigns the parameters to the new device and configures it. With an MMC card, a device can be exchanged without using a programming device (PG).

Requirements

- The programming device (PG)/PC has a prommer for MMCs.
- The IO device must support the "Assign the device name via MMC" function.
- The station with its PROFINET IO system is configured.

Procedure

1. Insert the MMC in the prommer.
2. In HW Config or in NetPro, select the IO device to be assigned the device name via MMC.
3. Select the **PLC > Save Device Name to Memory Card** menu command.
4. If the MMC has other data on it, a message will inform you of this condition so that you can delete the MMC before saving the device name.

4.4.5 Changing the IP-Address or the Device Name During Operation

Assigning an IP address or device name for a single node

Before a new IP address or a device name can be assigned, the following conditions must be met:

There is no data being exchanged with the IO controller.

If the SIMATIC Manager or the list of accessible nodes is open, you can assign each PROFINET-device an/another IP address another device name. To do this, select the **PLC > Assign Ethernet Address** menu command.

Changing IP addresses from a central location

If you have to check or change the IP addressees for several IO devices, proceed as follows:

1. In HW Config, select the PROFINET IO system (the "railroad track") and then select **Edit > PROFINET IO > PROFINET IO System > IP Addresses** menu command. Alternative method: you can also find this function by selecting an IO system and then right-clicking to display the context menu.
2. The dialog box that is then displayed shows all the IO devices with their current device names and IP addresses. You can change all the IP addresses from this central location.
3. Download the changed IP addresses (menu command: **PLC > Download to Module**).

When an IO controller or an IO device is selected, you can also call this function in NetPro by selecting the **Edit > PROFINET IO > PROFINET IO System > IP Addresses** menu command.

4.4.6 Diagnosing PROFINET IO Devices

The same diagnostic paths available to you in STEP 7 for PROFIBUS DP components are also available for PROFINET IO. The procedures used are identical.

When you click the **Station > Open Online** menu command in HW Config, you can then diagnose PROFINET IO devices in addition to S7 stations. This view also shows the slaves "behind" an IE/PB link.

However, the procedure for evaluating diagnostic information by means of SFBs/SFCs in the user program is somewhat different.

For PROFINET IO, there is a consistent structure for data records with diagnostic information for all device manufacturers. Diagnostic information is only collected for faulty channels.

The system status lists (SSLs), SFB 54 and SFB 52 have been expanded in order to also make the status of PROFINET IO systems and the diagnostic information available for an S7 user program.

- For example, to get a complete overview of the status of the PROFINET IO system, you can read SSL 0x0X91 (SFC 51).
- To read out diagnostic records directly from a faulty module, use SFB 52 (read data record) to get detailed error information on its current status.
- To read event-related (e.g. triggered by an error OB) diagnostic records, use SFB 54 in the corresponding error OB (read additional information on interrupt).

SFB 52 and SFB 54 can also continue to be used for PROFIBUS DP.

For information on which SSLs and which diagnostic records are defined for PROFINET IO and how diagnostic data records are structured, please refer to the programming manual *From PROFIBUS DP to PROFINET IO*.

4.4.7 Configuring the Watchdog Time

You can configure a watchdog time for PROFINET IO devices.

If the IO device does not receive IO data from the IO controller within the configured watchdog time, the device goes into safe mode.

You do not enter the watchdog time directly, but as a "Number of accepted update cycles with missing IO data". This makes it easier to make the setting because the update time can be shorter or longer, depending on the performance of the IO device or the setting.

STEP 7 uses the "Number of accepted update cycles without IO data" to calculate the resulting watchdog time.

Procedure

To set the update time for an individual IO device, proceed as follows:

1. Double-click an IO device.
2. Select the "IO Cycle" tab.
3. Check the set watchdog time and change it, if necessary. To do this, change the factor for "Number of accepted update cycles without IO data". Confirm your settings with "OK".

You only change the default setting in special cases, such as when placing a device in service.

5 Configuring IRT Communication

5.1 Introduction: Isochronous Realtime Ethernet

In STEP 7 V5.4 you can configure PROFINET devices that support data exchange over Isochronous Realtime Ethernet (IRT). IRT frames are transmitted in a deterministic manner over planned communications paths in a specified sequence in order to achieve the best possible synchronization and performance.

Topology-based IRT requires special network components that support planned data transmission.

Constant Bus Cycle Time and Isochrone Mode now also with PROFINET

The constant bus cycle times and isochrone mode with PROFIBUS DP are now available for PROFINET IO.

With PROFIBUS DP, all nodes operated with constant bus cycle times are synchronized by a global control signal generated by the DP master.

With PROFINET IO with IRT, a "sync master" generates a signal with which the "sync slaves" are synchronized. The sync master and the sync slaves belong to a "sync domain", which is assigned a name during configuration. In principle, an IO controller or an IO device can serve as a sync master. A sync domain has exactly one sync master.

Correlation: Sync Domain and IO Systems

The important thing to recognize here is that sync domains do not have to be restricted to one PROFINET IO system: The devices in several IO systems can be synchronized by a single sync master, as long as they are all connected on the same Ethernet subnet.

Conversely, the following also applies: An IO system may only belong to a single sync domain.

Propagation Delay Cannot Be Neglected

With these extremely precise synchronization intervals, the lengths of the connecting lines, that is, the related delay times, must be taken into account. By using a topology editor, you can enter the properties of the lines between the ports on the switches. Using this data along with the other data in the configuration, STEP 7 will then calculate an optimized run-time for IRT communication and the resulting update time.

Limiting Network Load

To limit the load on the network caused by extremely short update times, update groups are configured for IRT data. If only a few devices require the shortest update time, they are assigned to the first update group. Each additional update group has an update time that is "n times" the previous update group (the factor "n" can be configured). This means that their data are updated less often, thus reducing the network load.

In STEP 7 V5.4 there is only one update group.

IRT Runs in Parallel to Realtime and TCP/IP Communication

In addition to IRT communication, for which a specified bandwidth within the update time is reserved, RT communication and TCP/IP communication are also allowed during the update time "n".

With RT communication (realtime communication), the cyclical data is transmitted between the IO controller and the IO device, but without the "best-possible synchronization".

Unsynchronized IO devices exchange their data automatically using RT communication.

Since TCP/IP communication is also possible, other non-realtime data or configuration data or diagnostic data can also be transported.

5.2 Overview: Basic Procedure For Configuring IRT

If you want to expand a plant with PROFINET IO by adding IRT for motion control applications, proceed in the following three steps:

1. Configure stations with PROFINET IO controllers and PROFINET IO devices. PROFINET devices that you need for motion control applications must support IRT.
2. Now specify what is synchronized with what. To do this, you must configure a sync domain with a sync master with several sync slaves.

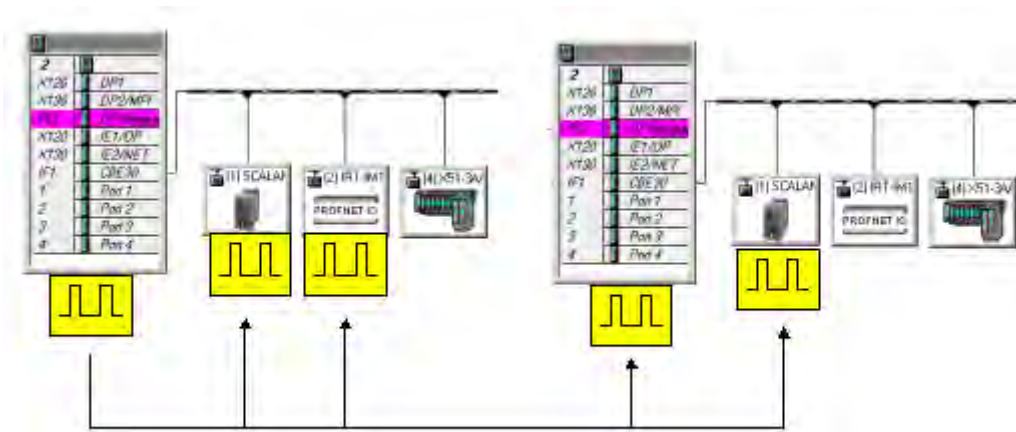

3. Now configure the topology; that is, specify how the ports for the individual devices are interconnected.

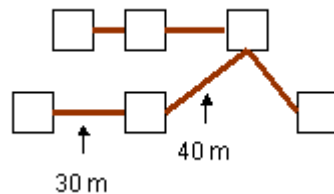

4. Download the configuration to the devices.

This basic description is extremely simplified. For detailed instructions, refer to the information available through the links listed below.

5.3 Creating a PROFINET IO Configuration

A PROFINET IO configuration is required to configure IRT; that is, one or more stations have to be configured with an IO controller and IO devices.

IRT communication is limited to components designed for it. In the Hardware Catalog, you will recognize such components by a reference in the infotext.

5.4 Creating a Sync Domain

All components included in IRT communication must belong to what is known as a "sync domain".

A sync domain is a group of PROFINET devices that are synchronized to a common cycle. Only one device can serve as the sync master (cycle clock); all the other devices function as sync slaves.

Procedure

1. Open the station with PROFINET devices that are to take part in IRT communication.
2. Select the **Edit > PROFINET IO > Manage Sync Domain** menu command. The "Manage Sync Domain" dialog box is displayed showing a tab with a list of all devices that support synchronization.
3. Double-click the device to be configured as the sync master. The property sheet for this device is displayed.
4. Enter a suitable name for the sync domain and set the synchronization type to "sync master".
Confirm your settings with "OK".
5. Now select all devices to be configured as sync slaves (to select these devices as a group, hold the CTRL key down and select each device one after the other).
Now click the "Device Properties" button.
6. In the dialog box that is then displayed, set the synchronization type to "sync slave".
Confirm your settings with "OK".

All devices that are set to "not synchronized" will not be included in IRT communication but will automatically take part in RT communication.

5.5 Setting Update Times

Update times are set for a group of PROFINET devices. Since STEP 7 V5.4 only provides for one update group, there is no need to manually assign devices to an update group. All devices are assigned to the same update group and will have the same update time.

1. In the "Manage Sync Domain" dialog box, select the "Update Groups" tab.
2. If possible select a suitable transmission cycle time. The transmission cycle time is smallest possible transmission interval.
If there are IO devices that do not support IRT communication configured, then the transmission cycle time has a default setting of 1 ms (this setting cannot be changed).
3. Click the "Update" button.
Based on the specified transmission cycle time, STEP calculates the length of time for RT communication and TCP/IP communication.
4. Double-click the update group.
In the "Update Group..." dialog box you can change the name of the update group and specify whether the Ti and To times for all IO devices should be the same (Ti/To same = "Yes") or whether these times should be set for each individual IO device (Ti /To same = "No").
5. Confirm your settings with "OK".

Times Ti and To with IRT

In PROFINET with IRT, the mechanism for isochronous reading and outputting of IO signals functions in a way similar to that for isochronous PROFIBUS DP. With PROFINET, the times Ti and To are also derived from the constant bus cycle time, and the IO devices with their modules ensure that the signals are read in and output at equal intervals. However, the mechanism is different in that with PROFINET there is no "Global Control" that serves as the time clock. Instead, the times are multiples of the transmission cycle time - yielding the same result as for PROFIBUS DP.

The diagrams showing the flow of the isochronous data exchange for PROFIBUS DP also similarly apply to PROFINET IO.

Note

IO devices that are only involved in IRT data exchange are not included in the list shown in the "Update Time" tab (double-click the IO system in HW Config to display the "Properties PROFINET IO System" dialog box).

5.6 Configuring the Topology

IRT communication requires a topology configuration.

There are two ways to specify the properties of the lines between the ports of the switches:

- Use the topology editor. It provides an overview of all ports in the project and a central location for interconnecting them.
To start the topology editor, select the **Edit > PROFINET IO > Topology** menu command in HW Config or NetPro.
- Alternate method: Use the "Port Properties..." dialog box (property sheet) for a port to select a partner port. This specifies the line between two ports. You can also edit the properties for this line here as well.
To open the property sheet, go to HW Config and select a port. Then select the **Edit > Object Properties** menu command. You can also simply double-click the port.
After property sheet is opened, select the "Topology" tab.

5.7 Configuring Direct Data Exchange

Data ranges can be cyclically exchanged between two IO controllers that are in a sync domain and take part in IRT communication by means of direct data exchange.

Principle

Like with PROFIBUS DP, data ranges (I/O areas) are configured by CPUs. A CPU uses these areas to send or receive data.

The CPU with a data range that is configured as the "Sender" sends data via outputs.

The CPU with a data range that is configured as the "Receiver" receives data via inputs.

Recommendation

We recommend that the sender ranges for all IO controllers be configured first, and then the receiver ranges.

Configuring the Sender

1. Open the property sheet for the IO controller (double-click the corresponding row in the configuration table in HW Config).
2. Select the "Sender" tab.
3. Click the "New" button.
4. In the property sheet for the sender, enter the start address of the sender and the length of the address area that will be used when sending.
Add some comments about this data range so that the data sent using this range can be identified later on.
5. Confirm your settings with "OK".
6. Repeat steps 3 to 5 for additional sender ranges.
7. If you like, change the default address for the sender ranges .
For communication in which an IO controller is used as sender for direct data exchange, only one diagnostic address can be assigned.

Configuring the Receiver

1. Open the property sheet for the IO controller (double-click the corresponding row in the configuration table in HW Config).
2. Select the "Receiver" tab.
3. Click the "New" button.
4. In the property sheet for the receiver, click the "Assign Sender" button.
5. In the "Assign Sender" dialog box that is displayed, select the data range of the desired station. This is the data range to be received by the local CPU.
6. Confirm your settings with "OK".
7. In the property sheet for the receiver, enter the start address of the address area that will be used when receiving.
The length of the address area should not be changed since it will be automatically adjusted to the length of the sender range.
Note: The configuration can only be compiled if the sender range and the receiver range have the same lengths!
8. Repeat steps 3 to 7 for additional receiver ranges .
9. Each assigned sender has a diagnostic address reserved for it. The receiver can detect failure of the sender by means of its diagnostic address.
Click the "Diagnostic Addresses" button to edit these addresses

5.8 Downloading an IRT Configuration

The configuration data must be downloaded to all devices that are involved in IRT communication.

Before downloading, first perform a consistency check and eliminate any errors that may exist.

Recommendation

Sync domains are not limited to one station. Download the IRT configuration from the network configuration (NetPro).

To do this, select the Ethernet subnet and then select the **PLC > Download to Current Project > Stations on the Subnet** menu command.

5.9 Media Redundancy

5.9.1 What You Should Know a About Media Redundancy

Media redundant transmission means that the data in IRT communication are transmitted in two frames over two separate paths. A frame is the unit in which data are transmitted over the Ethernet.

The "media-redundant transmission" property can be configured as follows:

- For an entire IO device
- For each individual address area in a controller-controller communication relationship (direct data exchange)

Media Redundancy for an Entire IO Device

All data in the communication relationship between the IO controller and the IO device are transmitted in a media-redundant manner.

Media Redundancy for an Individual Address Area in a Controller-Controller Communication Relationship (Direct Data Exchange)

Media-redundant transmission is configured for each address area between sender and receiver. This means that, in each case, this corresponds to one row in the "Sender/Receiver" tab in the property sheet for an IO controller interface.

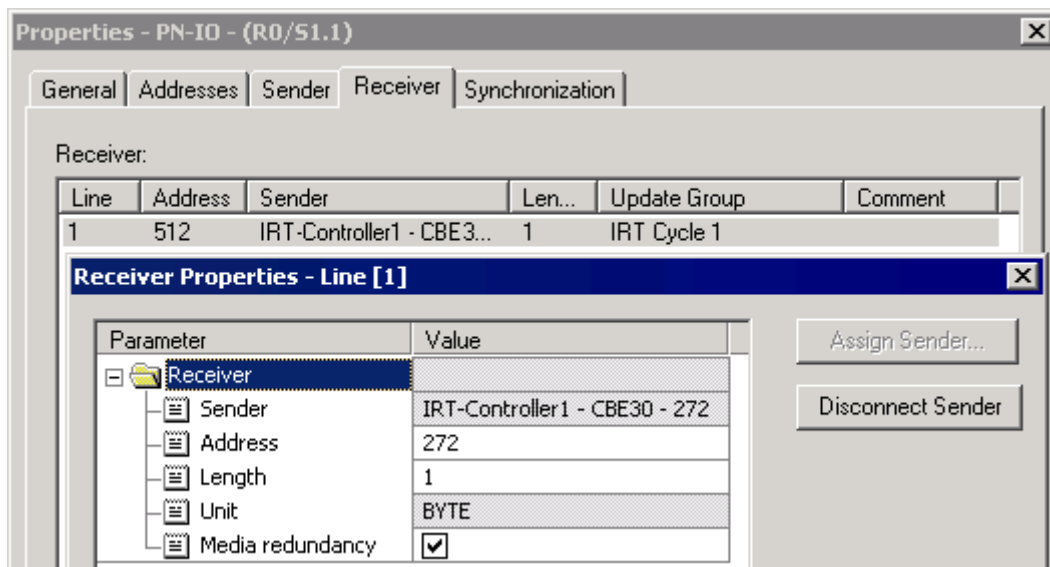

Default Setting

When the communication relationship is created, media-redundant transmission is disabled. This means that the data in an IRT communication relationship are transmitted over precisely one path of the IRT network. If media redundancy is not enabled, this means that the data are transmitted over exactly one path between the IO controller and the IO device of the IRT network. If this path is interrupted, then the data transfer will come to a halt.

Topology for Media-Redundant Transmission

To increase the reliability of data transmission, media-redundant transmission may be used. When doing so, the topology must be configured so that there are at least two different paths available between the sender switch and the receiver switch. These paths are different when the switches for one path are not used by the other one.

A ring topology would fulfill this need 100%. The device to be used as a switch should be one that supports the planned IRT communication.

In addition, several rings can be combined with each other as long as the condition is met that a switch is used in only precisely one path. If the topology of the network will not allow this, then the paths must be as "resource-independent" as possible. In case, however, media redundancy is not fully ensured.

The consistency check in HW Config will indicate whether switches between the sender and the receiver are being used by more than one path.

In addition to being configured for media redundant transmission, the network also requires a redundancy manager.

Function of the Redundancy Manager

The redundancy manager is an IO device that supports the planned IRT communication and for which IRT topology must also be configured. This manager is necessary in order to open the ring structures, which are necessary for media-redundant transmission, for TCP/IP frames. Otherwise, the TCP/IP frames would continually circulate in the network. As far as IRT is concerned, the redundancy manager is "porous" since IRT communication is running as planned and there are thus no frames circulating in the network.

The redundancy manager functions as an intelligent switch:

- It sends test frames to both ring connection points.
- If the ring is still closed and functioning correctly, these frames are received again at the respective other sides.

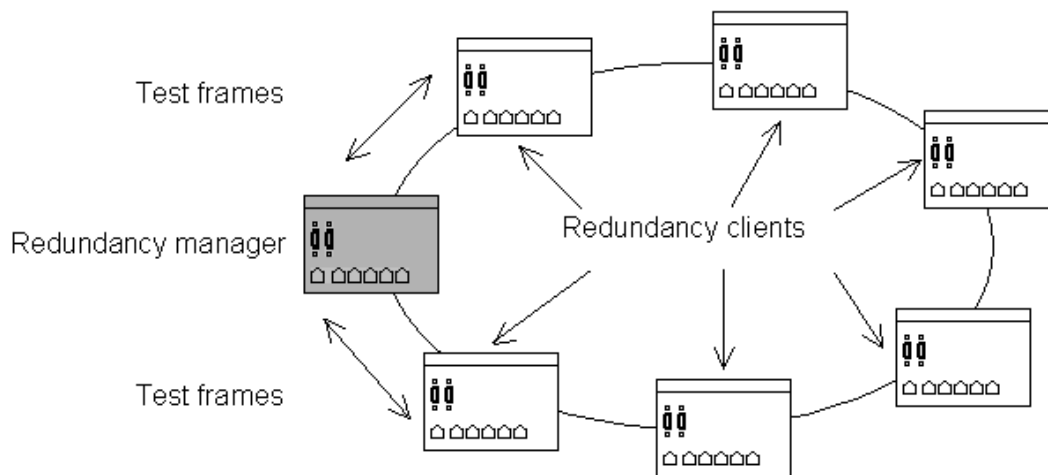

If no test frames arrive within a time interval, the manager lets TCP/IP frames through again. In this way, a communications path for TCP/IP frames, which had been previously interrupted for the reason cited above, is created again. If the ring opens, the redundancy manager generates a redundancy interrupt.

Note

Enabling media-redundant transmission will increase the communications load since the data now have to be transmitted twice over two pathways.

5.9.2 Configuring Media Redundancy

Configuring Media Redundancy for an Entire IO Device

All data in the communications relationship between the IO controller and the IO device are transmitted in a media-redundant manner.

Requirements

- A topology with two independent paths has been configured.
- The IO device supports the function.
- A redundancy manager has also been configured.

Procedure

1. In HW Config, select the relevant IO device.
2. In the detail view of the IO device, double-click "Interface Submodule" for the IO device to open the property sheet.
3. Select the "Media Redundancy" tab.

Configuring Media Redundancy for an Individual Address Area in a Controller-Controller Communication Relationship (Direct Data Exchange)

Media-redundant transmission is configured for each address area between sender and receiver.

Requirements

- A topology with two independent paths has been configured.
- A redundancy manager has also been configured.

Procedure

1. Double-click "Interface Submodule" for the IO controller (e.g. IF1).
2. Select the "Receiver" tab.
3. Create a new row ("New" button) and assign a sender to the receiver.
4. In the "Receiver Properties" dialog box, select the "Media Redundancy" check box.

6 Configuring a SIMATIC PC Station (SIMATIC PC based)

6.1 Creating and Assigning Parameters to SIMATIC PC Stations

Introduction

The SIMATIC PC station (referred to here simply as "PC station") represents a PC or an operator station that includes the SIMATIC components as applications (such as WinCC), slot PLCs, or software PLCs for automation tasks. These components are configured within the PC station, or they can be the end point of a connection.

Overview: Configuring a SIMATIC PC Station and the Connections for It

The complete configuration of a PC station is handled with the "SIMATIC PC Station" station type. The components that are configured there are then available for configuring connections. You can configure the following components in a SIMATIC PC station:

- Software PLC WinLC (Version V3.0 and higher)
- Slot PLC CPU 41x-2 PCI (WinAC Slot 412 and WinAC Slot 416)
- SIMATIC communication processor for the PC
- SIMATIC HMI: WinCC and ProTool Pro
- Applications (such as user applications based on SAPI)
- OPC-Server

For PC-based components such as WinLC (\leq V2.x) or CPU 416-2 DP ISA, you must continue to use the SIMATIC 300 or SIMATIC 400 station type. You can find the components in the "Hardware Catalog" window under SIMATIC PC Based Control 300/400.

The following figure shows the structure of the Hardware Catalog for SIMATIC PC stations:

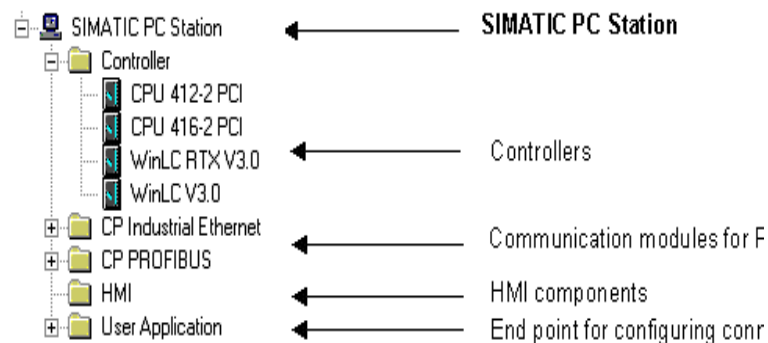

Procedure

1. In the SIMATIC Manager, insert a SIMATIC PC station in your project) menu command **Insert > SIMATIC PC Station**).
2. Change the name of the SIMATIC PC station as you see fit.
If the computer that you are now using for configuration and for loading stations is identical with the SIMATIC PC station inserted in the SIMATIC Manager, then the name of this station must be identical with the name specified in the Component Configuration Editor. Only then is the SIMATIC PC station properly "assigned" in the project; in other words, it is then recognized in the SIMATIC Manager and in the network view as an assigned SIMATIC PC station.
3. Double-click the SIMATIC PC station object and then the Configuration object. HW Config opens for editing the station configuration. Row 125 of the configuration table is occupied by the station manager (cannot be deleted).
4. Use a drag-and-drop operation to insert those components into the configuration table of the SIMATIC PC station that represent the configuration of the real PC. The components are located in the "Hardware Catalog" window under SIMATIC PC Station:
 - Software PLC WinLC in slot 2 (for information on expanded configuration options, see Slot Rules for PC-based SIMATIC Controllers)
 - Slot PLC CPU 41x-2 PCI (WinAC Slot 412 and WinAC Slot 416) in slot 3 (for information on expanded configuration options, see Slot Rules for PC-based SIMATIC Controllers)
 - CPs in one of the slots from 1 to 32 (if necessary, observe the restrictions in the Product Information for the current slot-CP!)
 - SW placeholder for configuring connections such as "User Application" or HMI components (if installed) also in slots 1 to 32
 - OPC Server for OPC Clients accessing the variables of remote automation systems via configured connections also in slots 1 to 32.

5. Call up the Properties dialog of the PC station (menu command **Station > Properties**), select the Configuration tab, and put the path for storing the configuration file (*.XDB file) there.
The connection data and addresses for CPs and applications are stored in this file (see step 6).
6. Select the menu command **PLC > Save and Compile**.
When the configuration of a SIMATIC PC station is saved and compiled, system data and a configuration file (*.XDB file) are created. This system data and the configuration file must then be downloaded to the programmable logic controller or installed (see Downloading a PC Station).
You set the location of the configuration file on the PC station by means of the "Set PG/PC Interface" program ("Configuring STEP 7" tab).
You can find more information on installing on a programming device/PC in the description "SIMATIC NET, S7 Programming Interface" and in the online Help on the "Configuring STEP 7" tab.
7. If you want to configure connections for the SIMATIC PC station:
 - Select the menu command **Options > Configure Network**. In NetPro, you can configure S7 connections for the control components and for applications. You can also configure redundant S7 connections for the OPC server. If you want to edit the SIMATIC PC configuration from NetPro, double-click the SIMATIC PC station object (as you would for SIMATIC 300/400 stations).

If you want to download the configuration:

 - Select the menu command **PLC > Download**. Only PC-based controls will be offered for the download (see Downloading a PC Station).

Special Features of Configuring WinLC V3.0 and Applications

The PROFIBUS-DP interface for WinLC is already included in WinLC as an integrated interface of WinLC (DP-Master in slot 2.1). Accordingly, the card required for this function (communications module such as CP 5613) is not placed and configured explicitly in HW Config. The configuration is handled by means of the DP Master entry in slot 2.1.

Configuration with Applications and PROFIBUS CPs

Applications can access distributed I/O by means of PROFIBUS-DP configuration. To create the configuration, proceed as follows:

1. Place an application and a PROFIBUS-DP CP in the configuration table for the SIMATIC PC station.
2. Double-click the CP to call up the Properties dialog.
3. In the Properties dialog, assign an application to the CP.

6.2 Slot Rules for a SIMATIC PC Station

Components such as CPs, PC-based user programs for configuring connections and OPC servers can be inserted in slots (index) 1 to 32.

SoftPLC

Up to STEP 7 V 5.2 Service Pack 1, the software PLC WinLC can only be inserted in Index 2. As of STEP 7 V 5.3, the WinLC variant V 4.1 is supported. It can be inserted in all slots and can be operated with up to four SlotPLCs (CPU 41x-2 PCI as of V 3.4).

SlotPLC

Up to STEP 7 V 5.2 Service Pack 1, the SlotPLC CPU 41x-2 PCI (WinAC Slot 412 and WinAC Slot 416) can only be inserted in Index 3.

As of STEP 7 V 5.3, the CPU 41x-2 PCI V 3.4 is supported. It can be inserted in all slots. Up to 4 of these CPUs can be inserted, even together with the new SoftPLC WinLC V 4.1.

Address Areas with Multi-PLC Operation

If there are several WinAC controllers inserted in a PC station, then each of them has its own I/O address areas. The controllers (e.g. SlotPLCs) can communicate with each other by means of S7 communications mechanisms (BSEND/BRCV); otherwise, however, they function independently of each other, comparable to the operation of S7-400 CPUs in a segmented rack, such CR1. This property allows the compactness and integration density of a PLC to be increased.

Further Information

For further information, please refer to the manuals for the SoftPLCs and SlotPLCs as well as the manual "Commissioning PC Stations - Manual and Quick Start".

6.3 Comparison: S7 Station - PC Station

The configuration of S7 stations is represented in the SIMATIC Manager by the Hardware object; if you double-click Hardware, you start the application for configuring an S7 station. End points of a connection are modules that are plugged in to the real station. Configurable CPUs, CPs, or interface modules form the interfaces to subnets.

The configuration of PC stations is represented in the SIMATIC Manager by the Configuration object; if you double-click Configuration, you start the application for configuring a PC station (as of STEP 7 V5.0 Service Pack 3).

6.4 Appending SIMATIC PC Configurations of Previous Versions

PC Configurations of STEP 7 V5.1 Projects (up to SP 1)

As of STEP 7 V5.1, Service Pack 2 you can download communications to the PC station in the same way as to an S7-300 or S7-400 station (without having to take the roundabout via configuration file). Nevertheless, a configuration file is always generated during a storing or compiling operation in order to enable the transmission of the configuration to the target PC station using this method.

This bears the consequence that "older" PC stations cannot interpret some of the information included in the newly generated configuration files. STEP 7 automatically adapts itself to this circumstance:

- If you create a **new** SIMATIC PC station configuration with STEP 7 as of V5.1, Service Pack 2, STEP 7 assumes that the target PC station was configured with the help of SIMATIC NET CD as of 7/2001, that is, under the presumption that S7RTM (Runtime Manager) is installed. The configuration files are generated in such a way that they can be interpreted by a "new" PC station.
- If you append a SIMATIC PC station configuration of a previous version (for example, the PC station was configured with STEP 7 V5.1, Service Pack 1), STEP 7 does **not** presume that the target PC station was configured with the help of SIMATIC NET CD as of 7/2001. Those configuration files are then generated in such a way that they can be interpreted by an "old" PC station.

If this default behavior does not match your requirements, you can modify it as described below:

Setting in the Context Menu "Configuring Hardware ":

1. Open the PC station hardware configuration
2. Right-click on the station window (white area)
3. Select the context-sensitive menu "Station Properties"
4. Check or clear the "Compatibility" checkbox.

Setting in the Context Menu "Configuring Networks"

1. Open the network configuration
2. Highlight the PC station
3. Select the menu command **Edit > Object properties**
4. In the dialog, select the "Configuration" tab
5. Check or clear the "Compatibility" checkbox.

PC Configurations of STEP 7 V5.0 Projects

You must convert the station if you want to edit a SIMATIC PC station configuration with STEP 7 as of V5.0, Service Pack 3 to configure new components that are only supported by Service Pack 3 or higher:



1. In the SIMATIC Manager, highlight the SIMATIC PC station and select the menu command **Edit > Object properties**.
2. In the "Functions" tab of the properties dialog, click on the "Expand" button. The SIMATIC PC station is then converted. Now, it can only be edited with STEP 7 V5.0, Service Pack 3 or later versions.

6.5 Highlighting the SIMATIC PC Station to be Configured in the Network View

If the SIMATIC PC station that you are using to create the STEP 7 project is to be have a highlighted display in the network view and in the SIMATIC manager for the project, the following prerequisites must be met:

- No programming device (PG)/PC can be assigned
- The PG/PC interface must be set to "PC internal (local)"
- The PC station must be configured with the Component Configurator, which is available on the SIMATIC NET CD as of 7/2001.
- The name of the PC station entered must be **identical** in the Component Configurator and in STEP 7 (station properties of the SIMATIC PC station).

Since this name is then identical everywhere, STEP 7 can then make the correct association and highlight the assigned PC station. Should any one of the above-mentioned prerequisites not be met, then the "standard" icon for the PC station is displayed.

Meaning	Icon
SIMATIC PC station highlighted	
SIMATIC PC station not highlighted	

7 Saving, Importing and Exporting Configurations

7.1 Saving a Configuration and Checking the Consistency

To save a configuration with all set parameters and addresses, select the menu command **Station > Save** or **Station > Save and Compile**.

If you use the menu command **Station > Save and Compile**, the configuration is saved in the active project as a "Station" object and if valid system data blocks (SDB) could be created, they are stored in the (offline) "Blocks" folder for the associated modules ("SDB carrier," for example, CPU). The system data blocks are represented by the "System Data" folder/symbol.



Symbol for system data

To be able to save incomplete configurations, select the menu command **Station > Save**. Using this command no system data blocks are created when saving. The save procedure takes less time than if you save and compile, but you should be aware that there may be inconsistencies between the configuration saved in the "Station" object and the configuration saved in the system data.

Before downloading, you should check your station configuration for errors using the menu command **Station > Consistency Check**.

7.2 Importing and Exporting a Configuration

Introduction

From STEP 7 V5 you can handle station configurations not only together with the whole project (for example, save or open them), but also export and import them independently of the project in text form (ASCII file).

Applications

- You can distribute files by electronic means (for example, by e-mail)
- You can save files for use with future STEP 7 versions
- You can print export files using word processing systems or process them for documentation purposes.

What is exported/imported?

During hardware configuration the data that can be exported or imported are those data required for the configuration and parameter assignment of modules. As of STEP 7 V5.1, Service Pack 1, it is also possible to export and import subnet data.

The following data are **not** acquired:

- Data which are managed via other applications (for example, programs, connections, shared data)
- The CPU password which was set (for this reason, with F-CPU's the setting "CPU contains safety program" is reset since it cannot be made without a password).
- Data not specific to one station (for example, links to intelligent DP slaves or configuration for direct data exchange)

Note

If your configuration contains modules from earlier optional packages, it is possible that not all module data will be acquired when you use the "Export Station" function. In this case, you should check that the module data are complete after importing.

Export File

You can set what is stored in the exported text file and in what form it is stored when you export (**Station > Export** menu command):

- Legible or Compact Format
 - Important:** If you export the station configuration in order to read it in with other STEP 7 versions, select the "**Compact**" option.
- The name of the file can be (*.cfg) freely selected
- With or without symbols
- With or without subnets
- Default values for module parameters can be left out (STEP 7 "knows" the default values and adds them from the internal module data when you import)



Caution

If you export a station configuration with symbols, you can no longer import this file with STEP 7 V5, SP 1 or an older STEP 7 version.

Procedure (Exporting)

1. Open a station configuration or save the station configuration you are currently editing (**Station > Save** menu command).
2. With a station configuration open, select the menu command **Station > Export**.
3. In the dialog box that appears, enter the path and name of the export file, the format, and other options.
4. Confirm your settings with "OK."

Procedure (Importing)

Recommendation: Do not import an exported station configuration from the same project. In this case, STEP 7 cannot resolve the network assignment. For the import, select a different or new project.

1. Make sure that you have the same Windows language setting for the import as for the preceding export. Different Windows language settings for export and import may lead to errors during imports.
2. With an empty station configuration open, select the menu command **Station > Import**
If no station configuration is open, a dialog box appears for the selection of a project. In this case, navigate to the project into which you want to import the station configuration.
3. In the dialog box that appears, navigate to the text file you want to import.
4. Confirm your settings with "OK."
On importing, STEP 7 checks the imported file for errors and consistency and outputs messages.

Importing into an Existing Station

You can also import a station into an open station configuration. On importing, STEP 7 queries whether already configured modules/interface submodules should be overwritten. For every component you can decide whether you want to keep it or overwrite it.

When a component is overwritten, all settings (parameters) in the import file become valid. Any settings that are not included in the import file remain in the station configuration.

7.3 Exporting and Importing CAx Data

As of STEP 7 V5.4, you can export stations in a format that is "understood" by CAx systems, where they can be processed further.

Similarly, you can also export station data from a compatible CAx system and import them into a station in an STEP 7 project.

In this sense, "CAx" stands for CAD, CAE, E-CAD and E-CAE and refers to the data used in these special programs.

This feature saves you from having to enter the same data twice.

What is Exported?

- SIMATIC stations (S7-300, S7-400, S7-400H, PC stations)
- GSD-based modules (PROFIBUS DP, PROFINET IO)
- Subnets

What is Not Exported?

The CAx interface does not supply parameters of objects. For this reason, the export is not complete, which means that you will have to expect data loss after a station has been exported and then imported. The export is intended to make data from Hardware Configuration in STEP 7 usable in CAx systems.

In particular, the following items are **not** exported:

- Blocks, parameters and connections
- CiR submodules (for configuration changes in RUN mode)
- Intelligent DP slaves (I slaves) that are configured in their own station

Export Files

For each station, an export file is created in XML format. This XML file follows the SimaticML-CAx-v1.0-xsd scheme.

If there are slaves or IO devices in the station that are integrated by means for GSD files, these files are also copied into the target folder.

Procedure: Exporting CAx Data

1. Open the project containing the stations to be exported.
2. If you want to export an individual station, select it in the SIMATIC Manager. If you want to export several stations, then select the project (no station selected).
3. In the SIMATIC Manager, select the **Options > CAx Data > Export** menu command.
4. In the "Export CAx Data" dialog box, select the destination folder, and, if applicable, the stations to be exported.
5. Click the "Export" button.
If an export file from a station is already present in the destination folder, select the appropriate option in the dialog that is displayed (Replace, Don't Replace...).
The status (success or failure) of the export process is displayed in the "Status" column.

Import

An import can be made into an "empty" station or into an already configured station.

If the station already contains objects (racks, modules, slaves, ...) then a comparison of the incoming and existing objects is carried out during the import. The result of this comparison are shown in the import dialog box. The following criteria apply during the comparison:

- Modules/submodules are compared in terms of their slots.
- Subnets are compared in terms of their names and types.
- Racks and slaves are compared in terms of their numbers.

Procedure: Importing CAx Data

1. Open the station to receive data imported from a CAx system.
2. In the SIMATIC Manager, select the **Options > CAx Data > Import** menu command.
3. In the dialog that is then displayed, go to the XML file that was generated by the CAx system.
4. Confirm your selection with "OK".
5. In the "Import CAx Data" dialog box, select the objects to be imported ("Selection" column).
If the station to receive data imported from a CAx system already contains objects, then these objects may have other properties than the objects in the XML file. In this case, you will have to decide which properties are to apply (see the Help on the dialog box).
6. Click the "Import" button.

7. After the import is completed, evaluate the status of the objects. If necessary, take a look at the log of the import process. To do so, click the "Show Log" button. The log file contains status information on the complete import process. This log will be overwritten during the next import.
8. If components with GSD files were used in the CAx system, you will have to install these components for the corresponding stations.

Error Analysis after Import

Errors during imports are shown in red.

If a module or an object cannot be created, check whether the values are set for the following attributes:

- Order number
- Version
- Submodule
- Slot
- Subslot (for a submodule)

If the modules still cannot be imported, then it is probably incompatible with an existing configuration.

After the import is complete, you should run a consistency check and eliminate any inconsistencies found.

8 Synchronous Operation of Multiple CPUs (Multicomputing)

8.1 What You Should Know About Multicomputing

What is Multicomputing Operation?

Multicomputing means the simultaneous operation of more than one CPU with multicomputing capability (up to a maximum of four) in one central rack of the S7-400.

The participating CPUs automatically change their operating modes synchronously, meaning the CPUs start up together and go into STOP mode together. The user program for each CPU executes independently of the user programs in the other CPUs. This means control tasks can be run in parallel.

Example

The following figure shows a programmable controller that will operate in multicomputing mode. Each CPU can access the modules assigned to it (FM, CP, SM).

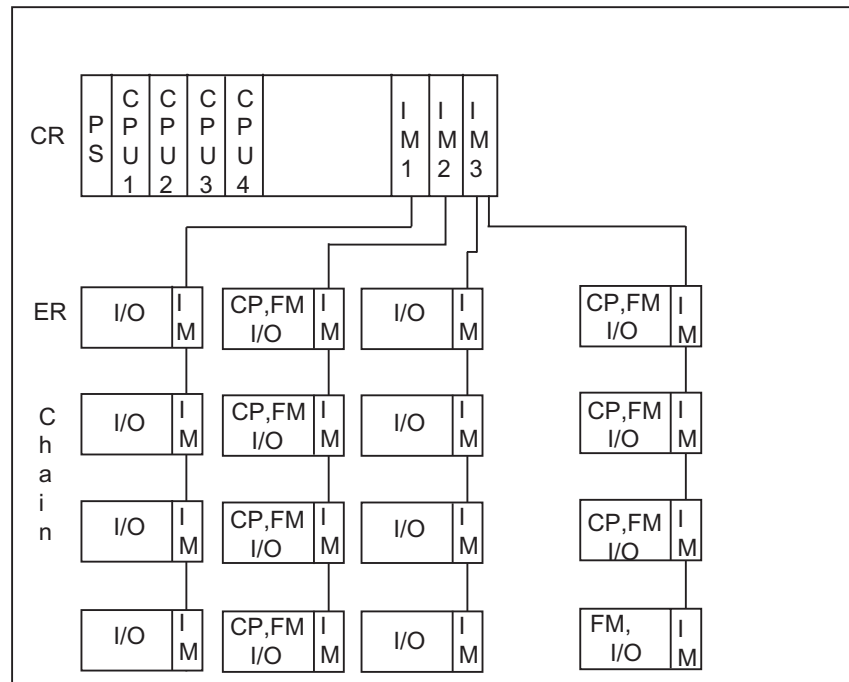

Difference Between Multicomputing and Operation in Segmented Racks

Simultaneous unsynchronized operation of more than one CPU in a segmented rack CR2 (physically segmented, cannot be set by user) is also possible. This is, however, not multicomputing. The CPUs in a segmented rack form their own independent subsystem and behave like single processors. There is no shared address area.

"Multicomputing mode" and "unsynchronized operation in a segmented rack" at the same time is not possible.

8.1.1 Special Features of Multicomputing

Slot Rules

In multicomputing mode up to four CPUs can be inserted simultaneously in a central rack in any order.

If you use CPUs that can manage only module start addresses that are divisible by four (generally CPUs before 10/98), you must follow this rule for **all** configured CPUs when you assign the addresses. The rule applies to a case where you are also using CPUs that permit byte-by-byte assignment of module start addresses in single-computing operation.

Bus Connection

The CPUs are interconnected via the communication bus (corresponds to a connection via MPI).

Behavior During Startup and Operation

During startup the CPUs in multicomputing operation check automatically whether they can synchronize. Synchronization is only possible:

- If all (and only) the configured CPUs are inserted and not defective
- If correct configuration data (SDBs) were created and downloaded for all inserted CPUs.

If one of these prerequisites is not met, the event is entered in the diagnostic buffer under the ID 0x49A4. You will find explanations of the event IDs in the reference online help on standard and system functions (SFBs/SFCs).

When the CPUs exit STOP mode, the startup types are compared (COLD RESTART/WARM RESTART/HOT RESTART). This ensures that all the CPUs in the programmable controller execute the same type of startup and all CPUs have the same operating mode.

Address and Interrupt Assignment

In multicomputing mode the individual CPUs can access the modules assigned to them during configuration with STEP 7. The address area of a module is always exclusively assigned to a CPU.

All CPUs share the same address space; this means that the logical address of a module is only present once in the multi-computing station.

An interrupt input is assigned to every CPU. Interrupts received at this input cannot be received by the other CPUs. The assignment of the interrupt line is made automatically during parameter assignment of the modules.

The following rules apply to interrupt servicing:

- Hardware interrupts and diagnostic interrupts are sent to only one CPU.
- If there is a module failure, the interrupt is serviced by the CPU to which the module was assigned with STEP 7.
- If a rack fails, OB86 is called on every CPU.

You will find more detailed information on OB86 in the reference online help on organization blocks.

8.1.2 When to Use Multicomputing

Multicomputing has advantages in the following situations:

- When your user program is too large for one CPU and memory is used up, distribute your program among more than one CPU.
- If part of your system must be processed quickly, take these program sections out of the main program and run them on a separate fast CPU.
- If your system consists of various parts that can be clearly delineated and can be controlled relatively autonomously, run the program for system section 1 on CPU 1 and system section 2 on CPU 2 etc.

8.2 Configuring Multicomputing Operation

Setting Multicomputing Operation

Multicomputing operation results implicitly when you insert a second (third or fourth) multicomputing CPU in a rack suitable for this kind of operation (for example, the rack UR1). When a module is selected, the info text in the "Hardware Catalog" window tells you whether the CPU has multicomputing capability.

Requirements

Before you can configure modules in your programmable controller for multicomputing mode, the following conditions must be satisfied:

- You must have set up your programmable controller as described in the "S7-400, M7-400 Programmable Controllers, Hardware and Installation" manual.
- You must have opened the configuration table in the project window by double-clicking the "Hardware" object.
- You must have arranged a rack in the station window and the rack is shown as being open (the rack slots are visible).

Basic Procedure

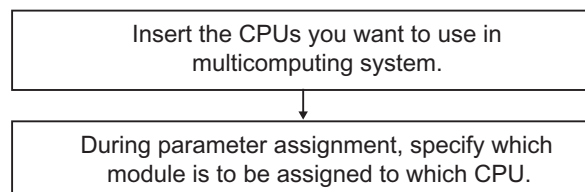

Note when Downloading and Uploading

Only the complete station configuration should be downloaded to all CPUs. This avoids inconsistent configurations.

When uploading to a programming device, the station configuration is loaded from all programmable modules, one after another (CPU by CPU). You have the option of aborting the upload process even if not all the configuration data (SDBs) were uploaded. In this case, parameter assignment information will be lost.

8.2.1 Configuring Modules for Multicomputing Operation

To configure the programmable controller in multicomputing mode, proceed as follows:

1. Use the drag & drop function to copy the CPUs you want to work in multicomputing operation from the "Hardware Catalog" window to the appropriate rows of the rack.
2. Double-click on a CPU and set the CPU number in the "Multicomputing" tab (when you insert the CPU, the CPU numbers are assigned automatically in ascending order).
3. For all modules to be assigned to CPU1, proceed as follows:
 - Arrange the modules at the intended position in the rack.
 - Double-click on the module and select the "Addresses" tab.
 - In the "CPU No." box select CPU 1.

Note: The CPU assignment is displayed for modules that can trigger interrupts in the "Inputs" or "Outputs" tab as the "Target CPU for interrupt."

4. Repeat the steps listed under 3 for the modules that are to be assigned to the remaining CPUs.

8.2.2 Displaying the CPU Assignment

You have a choice of two methods of highlighting the modules that are assigned to a specific CPU:

- Select the menu command **View > Filter > CPU No. x - Modules** (x = CPU number).

All module names in the configuration table that are not assigned to this CPU are grayed out (exception: distributed I/O modules, interface modules, and power supplies).

- Select the relevant CPU and select the pop-up menu command **Filter Assigned Modules**.

Note

The filter you set has no effect on the print function or the "Address Overview" dialog box.

You can modify the CPU assignment via the "Addresses" tab (exception: interface modules and power supplies).

8.2.3 Changing the CPU Number

If you have inserted several CPUs and want to change the CPU number, proceed as follows:

1. If four **CPUs** are inserted: Delete one of the inserted CPUs.
If two or three CPUs are inserted: Continue with the next step.
2. Double-click the CPU whose number you want to change.
3. Select the "Multicomputing" tab.
4. Select the required CPU number.

8.3 Programming CPUs

Programming

Programming for the multicomputing mode is essentially the same as programming a single CPU.

Extra steps are, however, necessary if you want to synchronize the CPUs so that they react to events together.

Calling SFC35

If you want all the CPUs to react to events (for example, interrupts) together in the multicomputing mode, you program an SFC35 "MP_ALM" call. Calling SFC35 triggers a multicomputing interrupt that causes a synchronized request for OB60 on all CPUs. This OB contains local variables that specify the triggering event in greater detail.

When SFC35 is called, the information about the events is transferred to all CPUs in a job identifier. The job identifier allows 16 different events to be distinguished.

When they service the multicomputing interrupt, both the sending user program and the user programs on the other CPUs check whether or not they recognize the job and then react as programmed.

You can call SFC35 at any point in your program. Since the call is only of practical use in RUN mode, the multicomputing interrupt is suppressed if it is triggered in STARTUP mode.

The multicomputing interrupt can only be triggered again after the current multicomputing interrupt has been serviced (acknowledged).

You will find more detailed information on SFC35 in the reference online help on SFBs/SFCs.

Programming OB60

You can program a specific OB60 for each separate CPU and download it to the CPU. This means that the execution times can differ from CPU to CPU. This leads to the following behavior:

- The interrupted priority classes on the CPUs are continued at different times.
- A multicomputing interrupt is not serviced if it occurs during the execution of OB60 on any of the CPUs. A message is, however, generated and you can check this and react accordingly.

If OB60 is not loaded on one of the CPUs, this CPU returns immediately to the last priority class and continues the program there.

You will find more detailed information on OB86 in the reference online help on organization blocks.

9 Modifying the System during Operation (CiR)

CiR (Configuration in RUN) represents a method you can use to modify a system that is operated with a standard S7-400 CPU or an S7-400-H-CPU in single operation. Modifications are made while your system is in operation, that is, except for a small interval of at most 2.5 seconds, your CPU will remain in RUN mode.

For more information, refer to the "Modifying the System During Operation via CiR" manual. It is also available electronically as a PDF file.

10 Configuring H-Systems

Overview

H-systems ("high-availability" systems) are fault-tolerant automation systems that are employed to increase system availability and thus reduce production stops and downtimes.

For more information, refer to the "Automation System S7-400H - Fault-tolerant Systems" manual.

11 Networking Stations

11.1 Networking Stations within a Project

Context: Network Configuration and STEP 7 Projects

Subnets lie directly beneath a project in the object hierarchy and can therefore only be managed within a project. You can, however, connect nodes together that were configured in different projects.

If possible, you should create and configure nodes that you want to connect in networks in the same project.

Subnets and Stations

You can create the subnets and stations in a STEP 7 project and then configure the stations for communication very easily.

As a result of the different tasks of the stations or the fact that the plant has increased in size and scope, it may be necessary to run a number of subnets. These subnets can also be managed in one project. A station can be assigned to a number of subnets by assigning the communication nodes (for example, CPs) accordingly.

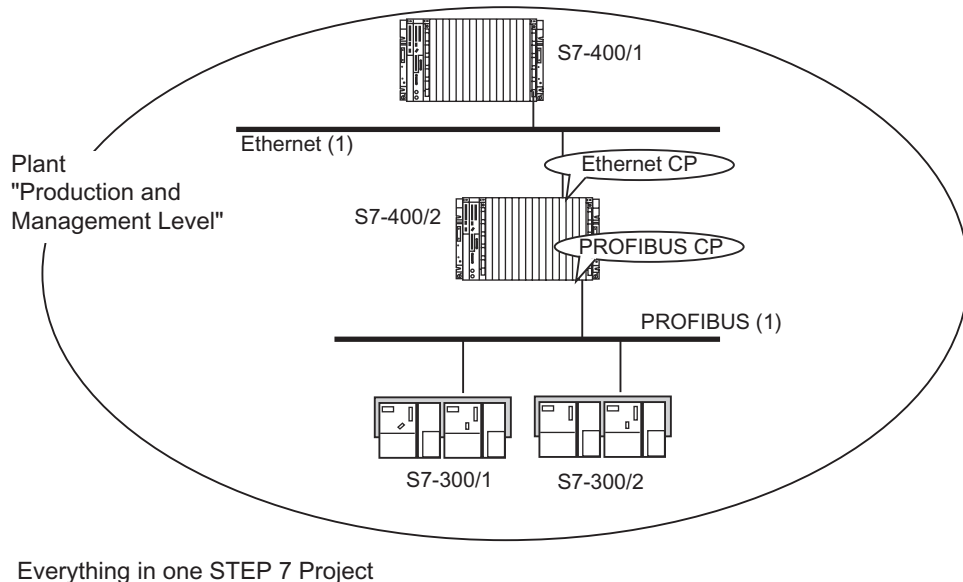

11.2 Properties of Subnets and Communication Nodes

Setting the Properties of Subnets and Communication Nodes in a Project

It does not matter whether you are intending to communicate in the network using global data or communication connections: the basis for communication is always a configured network.

With STEP 7:

- You create a graphic view of your network (comprising one or more subnets)
- You set the subnet properties/parameters for each subnet
- You set the node properties for each networked module
- You document your network configuration.

The following table shows how you are given support by STEP 7 when configuring your communication task.

Communication Method	Configured How?	Remarks
PROFIBUS-DP	Configuring the hardware	Also possible in NetPro
Actuator-sensor interface (AS-i)	Configuring the hardware	Linked to S7 stations via the DP/AS-i Link
Communication by means of non-configured connections (S7 Standard communication)	Configuring the hardware	Set the properties of the MPI subnet and the MPI nodes. The user program provides special system functions for non-configured connections.
Communication by means of configured connections (S7 communication)	NetPro (Configuring Networks and Connections)	S7 and point-to-point (PTP) connections can be configured with the STEP 7 Standard package. Optional packages are required for other connection types (for example, FMS for PROFIBUS).
Global data communication	Defining Global Data	Set the properties of the MPI subnet and the MPI nodes and configure address areas for data exchange in the GD table

11.3 Rules for Network Configuration

You should observe the following rules for configuring networks:

Every node in a subnet must have a different node address.

CPUs are shipped with the default node address 2. However, you can only use this address once in a subnet, so you will have to change the default address for any other CPUs.

For S7-300 stations, the following applies: When planning the MPI addresses for a number of CPUs you must leave "MPI address gaps" for FMs and CPs with their own MPI addresses to avoid double address assignments.

Only when all the modules in a subnet have unique addresses and when your actual structure matches the network configuration you have created should you load the settings via the network.

Assigning MPI Addresses

- Assign the MPI addresses in ascending order.
- Reserve the MPI address 0 for a programming device.
- You can connect up to 126 (addressable) nodes in an MPI network; up to 8 nodes for a transmission rate of 19.2 kbits/s.
- All MPI addresses in an MPI subnet must be unique.

Refer to the S7-300 or S7-400 Hardware Installation Manuals for other rules concerning the installation of a network.

Assigning PROFIBUS Addresses

- Every DP master and DP slave in the PROFIBUS network must be assigned a unique PROFIBUS address in the range 0 through 125.
- Assign the PROFIBUS addresses in ascending order.
- Reserve the "0" PROFIBUS address for a programming device that you later connect briefly to the PROFIBUS network for service purposes.

11.4 Ethernet Address Assignment

To configure an Ethernet CP, you must assign a MAC address or IP address to the Ethernet interface.

You can find extensive information on Ethernet CPs in the SIMATIC NCM documentation. In this documentation you can find principal information on how to configure an Ethernet partner in STEP 7.

Configuring Partners and Determining the Interface Properties

1. In the opened hardware configuration, select an Ethernet CP from the hardware catalog. Drag and drop it to a suitable row of the configuration table.
2. Double-click on the CP symbol in the configuration table
3. In the "General" tab, click on "Properties" (this button is located in the area of the interface parameters).
4. Establish a network assignment, that is, in the "Subnet" field, highlight an existing Ethernet subnet or click on "New" to create a new Ethernet subnet.
5. Enter the MAC address or IP address in the "Parameter" tab.
The appearance of this part of the tab depends on the type of CP.

MAC Address

Every Ethernet CP requires a unique MAC address that must be entered when a CP is configured. As a rule, the manufacturer has imprinted this address on the module.

The box looks as follows for CP requiring the input of a MAC address:

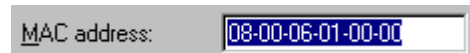

The box looks as follows for new CPs equipped with a fixed factory set MAC address - and therefore not requiring the input of a MAC address:

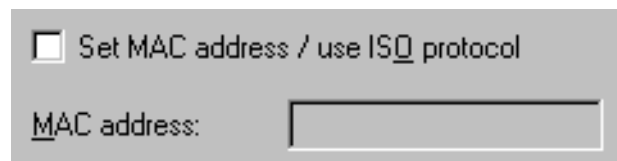

You must check the checkbox and enter the module MAC address only if you are using the **ISO** protocol (for example, for ISO network-independent transport connections), or if you are using the ISO as well as the TCP/IP protocol.

You must not activate the checkbox if you want to configure **only** communication types that require **TCP/IP** protocol (TCP connections, ISO-over-TCP connections, UDP connections). In this case, you can **not** enter a MAC address and the address that is imprinted on the module is maintained.

IP Address

The IP parameters are only visible if the Ethernet CP supports the TCP/IP protocol.

The IP address consists of 4 decimal numbers, value range from 0 to 255. The decimal numbers are separated by a dot.

The screenshot shows a configuration window with two main sections. The left section has two input fields: 'IP address:' containing '140.80.0.4' and 'Subnet mask:' containing '255.255.0.0'. The right section is titled 'Gateway' and contains two radio buttons: 'Do not use router' (unselected) and 'Use router' (selected). Below the 'Use router' button is an 'Address:' field containing '140.80.0.4'.

The IP address consists of

- The (sub)net address
- The partner address (generally referred to as host or network node)

The subnet mask separates those two addresses. It determines the IP address sections used to address the network and the node IP.

The set bits of the subnet mask determine the network component of the IP address.

In the example above:

Subnet mask: 255.255.0.0 = 11111111.11111111.00000000.00000000

Meaning: the first 2 bytes of the IP address determine the subnet - that is, 140.80. The last two bytes address the node - that is, 2.

Generally valid is:

- The network address is the result of the logic operation IP address AND subnet mask.
- The node address is the result of the logic operation IP address AND NOT subnet mask.

Relationship between the IP address and the default subnet mask

The relationship between the IP address areas and the so-called "Default Subnet Masks" is defined. The first decimal of the (left to right) determines the (binary) structure of the default, that is, the number of "1" values as follows:

IP address (dec.)	IP address (bin.)	Address class	Default subnet mask
0 to 126	0xxxxxxx.xxxxxxxx...	A	255.0.0.0
128 to 191	10xxxxxx.xxxxxxxx...	B	255.255.0.0
192 to 223	110xxxxx.xxxxxxxx...	C	255.255.255.0

Note

The first decimal number of the IP address can also have a value between 224 and 255 (address class D etc). However, we recommend you do not use these values, as STEP 7 does not check them.

Forming further subnet masks

The subnet mask allows you to extend the structure of a subnet that is assigned to address class A, B or C and to create "private" subnets by setting the least significant bits of the subnet mask to "1". The number of "private" networks will double with each bit that is set to "1" and reduces the number of network nodes to half. Seen from the outside this still network has the same effect as a single network.

Example:

In an address class B subnet (e.g.. IP address 129.80.xxx.xxx) you change the default subnet mask as follows:

Masks	Decimal	Binary
Default subnet mask	255.255.0.0	11111111.11111111.00000000.00000000
Subnet mask	255.255.128.0	11111111.11111111.10000000.00000000

Result:

All nodes at the addresses 129.80.001.xxx to 129.80.127.xxx are assigned to the same subnet, whereas all nodes at the addresses 129.80.128.xxx to 129.80.255.xxx are assigned to a different subnet.

Network gateway (Router)

Network gateways (routers) interconnect subnets. An IP datagram sent to another network must first be passed on to a router. To enable this feature, you must enter the router address for each one of the network nodes.

The IP address of a subnet node and of the network gateway (router) may only differ at the "0" bits of the subnet mask.

11.5 Importing and Exporting Stations in the Network View

Introduction

As of STEP 7 V5.1, Service Pack 1, in the network view, you can export and import as a text file (ASCII file) those station configurations that have network data but do not have connection data.

If you export several stations of a STEP 7 project that are networked with each other and then import them into another project, these stations are again networked with each other as they were in the original project.

Applications

- Can be distributed by means of electronic media (for example, e-mail)
- Can be read into future STEP 7 versions
- Export file can be printed out with word processing systems or processed further for documentation purposes

Which Network Objects Can Be Exported Or Imported?

You can export and import SIMATIC 300, SIMATIC 400, SIMATIC 400H, and SIMATIC PC stations.

What Is Exported/Imported?

With import and export from the network view, data can be exported/imported that are required for configuration and parameter assignment of the modules, as well as the network configuration.

The network configuration includes:

- Interface parameter assignments (for example, subnet screen and router settings of an Industrial Ethernet interface, bus parameters of a PROFIBUS interface)
- Assignment to the subnets
- Connections

Not included:

- Data that are managed by means of other applications (for example, programs, global data)
- Connections
- CPU password assigned as parameter
- Data that apply to more than one station (for example, the linking of intelligent DP slaves or configuration for direct data exchange)

Note

If your configuration contains modules from older option packages, it is possible that not all data of the module are included in the export function. In this case, check to see if the module data are complete after the import is finished.

Export Files

A text file (*.cfg) is created for each exported station. The default name is "[station name].cfg".

For each station, you can set separately during export what is stored in the exported text file and in what form the information is stored (menu command **Edit > Export**):

- Readable or compact form
 - Important:** If you are exporting the station configuration in order to read it in with other STEP 7 versions, select the option "**Compact**"!
- Name of the file (*.cfg) for each individual station can be anything you want
- With or without symbols
- Preset values for module parameters can be left out optionally (STEP 7 "recognizes" preset values and supplements them during import from the internal module knowledge pool)
- Option "Export Subnets" - by selecting this option, you can also read in the station configuration with older STEP 7 versions (STEP 7 => V5.0).
- Option "Export Connections" - you can select this option to download the station configuration with older STEP 7 versions (STEP 7 => V5.0).

In order to simplify handling the import procedure already during export, you can import all exported stations together later with the option "**With Reference File.**" To do this, you must select a name for this reference file (also a *.cfg file) that contains references to all the stations that were exported together. When you select this file later during import, all the stations that were exported together are imported again automatically.



Caution

If you export a station configuration with symbols, you can no longer import this file with STEP 7 V5, SP 1, or an older STEP 7 version.

Procedure (Export)

1. Open the network view or save the network configuration that you just edited (menu command **Network > Save**).
2. Select one or more stations that you want to export.
The Export dialog box opens. In this dialog box, you can select from a list the stations of the project to be exported.
3. Select the menu command **Edit > Export**.
4. In the dialog box that appears, enter the path and name of the export files, the format, and other options.
5. Format and options can be customized for each station separately.
Select the "Compact" format if you intend to use the export file for other STEP 7 versions.
6. Acknowledge the settings with OK.

Procedure (Import)

1. With the network view open, select the menu command **Edit > Import**.
2. In the dialog box that appears, navigate to the text file that you want to import.
If you exported several stations together by using the option "**With Reference File**," select only this reference file to import all stations with their network assignment together again.
3. Acknowledge the settings with OK.
During import, STEP 7 checks the imported files for errors and consistency and outputs messages.

If both connection partners are imported into a project, STEP 7 will then attempt to restore the connections between these partners.

11.6 How to Configure and Save a Subnet

11.6.1 Procedure for Configuring a Subnet

Method 1: Configuring Hardware

You have the possibility of creating subnets and connecting modules (or rather, their interfaces) to a subnet when you configure a station.

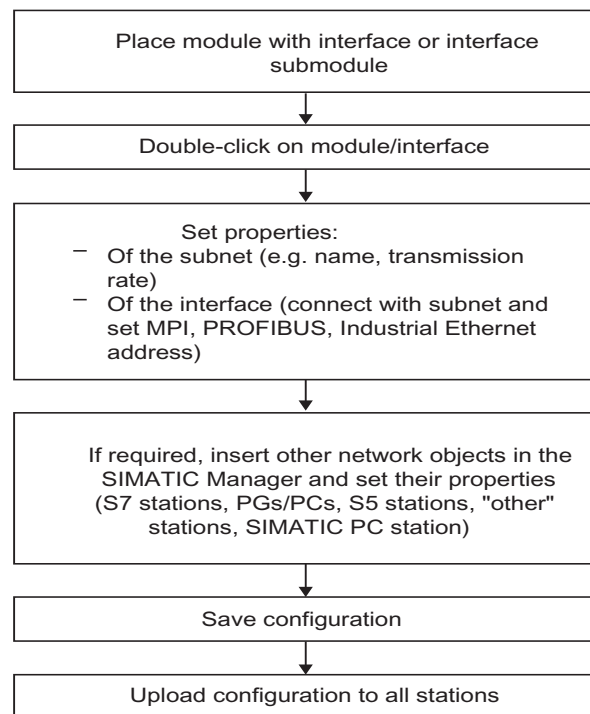

Method 2: Configuring Networks

For complex networked systems it is more advantageous to work in the network view.

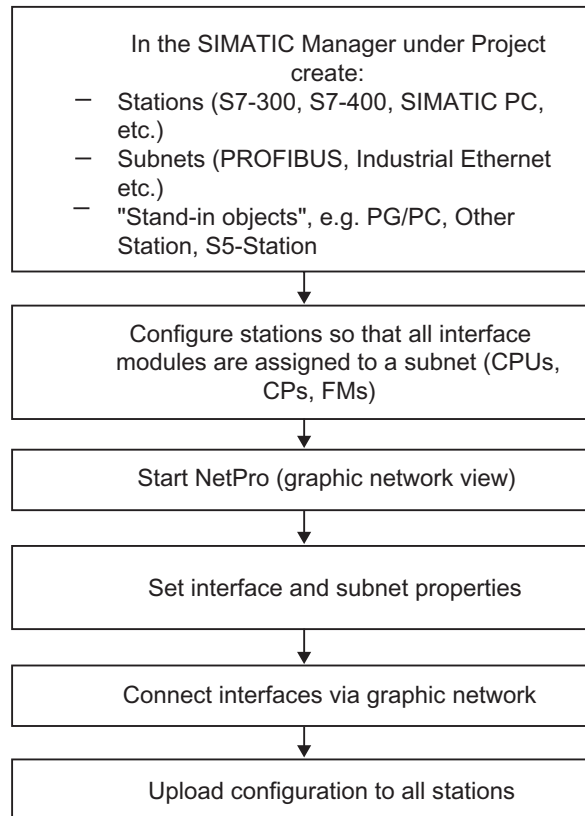

Expanding the Network Configuration in NetPro

You have the possibility in NetPro of inserting all network objects such as subnets or stations by dragging them from a catalog and dropping them in the network view.

What else is to be done after you have inserted the objects:

- Set the object properties by double-clicking the objects
- For an inserted station: start the Hardware Configuration application by double-clicking the station and place the modules.

Opening the Graphic Network View (Starting NetPro)

You can use the following methods to start the network configuration application:

From the SIMATIC Manager	From Configuring Hardware
<ol style="list-style-type: none"> 1. Open the project 2. Double-click a subnet symbol (having created a subnet using the menu command Insert > Subnet > ... if necessary) <p>Alternatively you can also double-click the "Connections" object (icon found under a module that is a connection end point, for example, a CPU). In this case the connection table for the module is opened for editing when NetPro is started.</p>	<p>Menu command Options > Configure Network</p>

Example of a Graphic Network View

When you have opened the network configuration application, the window for the graphic view of the network is displayed. The first time you select it, the following are visible:

- All the existing subnets created in the project
- All the existing stations configured in the project

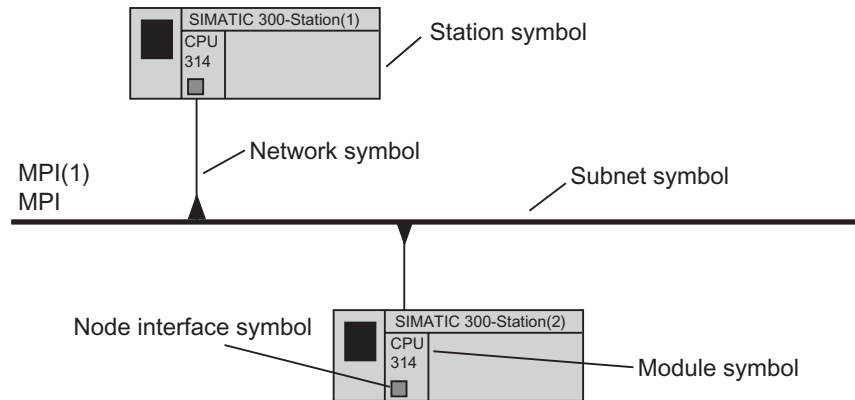

Editing a Station in NetPro

If you double-click an area of the station symbol you can further edit the station:

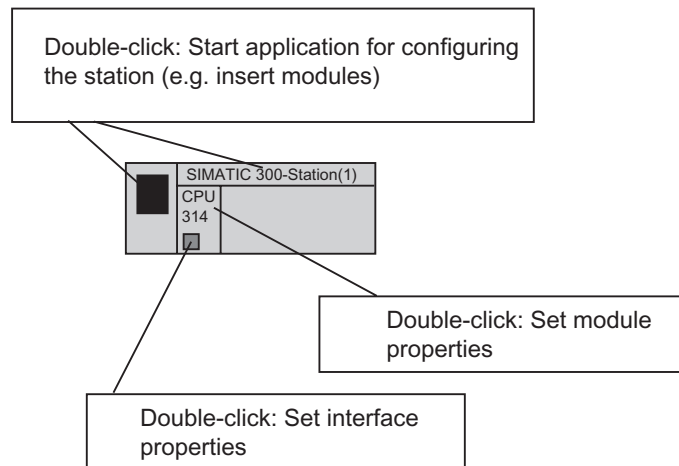

Color Coding in the Network View

After their configurations have been changed (in NetPro or in HW Config), S7 stations are color-coded to indicate their status:

- An orange-colored S7 station means that the configuration was changed (i.e. that the changes have to be compiled).
- An red-colored S7 station means that the changed configuration is not consistent and thus cannot be compiled. In this case, you will have to eliminate the errors detected and logged during a consistency check.
An inconsistent station is colored red only after a consistency check has been carried out; that is, after you have selected the **Network > Check Consistency** or **Network > Save and Compile** menu command.
The red color coding is not saved when the station is saved. This means that this color coding will be current and complete only after a consistency check has been carried out again.

STEP 7 does not detect every need for a compilation after the configuration has been changed:

- If more than one master is connected to a PROFIBUS subnet and a slave that causes a change in the bus parameters is being connected to the subnet: The need for a compilation is only detected for the station of the master system to which the newly added slave is assigned. The other master system that is also connected to the same PROFIBUS subnet will not be color coded.
- If you change the node address of an interface in an S7 station and this station functions as a router (S7 routing) for accesses by programming devices (PG): In this case, the other S7 stations on the subnet will also have to be compiled and downloaded so that they receive the routing information. However, these stations will not be color coded.

11.6.2 Creating and Assigning Parameters to a New Subnet

Requirement

NetPro must be open.

Note

STEP 7 automatically and centrally sets consistent subnet properties (e.g. transmission rate) for all nodes in a given subnet.

If you set or modify subnet properties in STEP 7, you must make sure that each node in the system subnet adopts these settings (Downloading a Configuration to a Programmable Controller).

Procedure

1. If the "Catalog" window is not visible:
Open the "Catalog" window using the menu command **View > Catalog**.
2. Click on "Subnets" in the "Catalog" window.
3. Click on the required subnet, hold the mouse button pressed, and use the drag & drop function to copy the subnet to the window for the graphic network view. Invalid positions for subnets in the view window are shown by a  sign instead of the cursor.
Result: The subnet appears as a horizontal line.
4. Double-click the symbol for the subnet.
Result: The properties dialog box for the subnet is displayed.
5. Assign parameters to the subnet.

Tips:

You can open an information window giving details about the subnet properties by holding the mouse on the symbol for the subnet.

11.6.3 Creating and Assigning Parameters to a New Station

Requirement

NetPro must be open.

Procedure

1. If the "Catalog" window is not visible:
Open the "Catalog" window using the menu command **View > Catalog**.
2. Click on "Stations" in the "Catalog" window.
3. Click on the required type of station, hold the mouse button pressed, and use the drag & drop function to copy the station to the window for the graphic network view.
Invalid positions for stations in the view window are shown by a  sign instead of the cursor.
4. Double-click the station (station symbol or station name).
You **can** now enter the whole hardware configuration for the station and assign its parameters, but you **must** assign the CPU, and any FMs and CPs to a suitable slot. Only these modules can be networked and appear in the graphic network view.
5. Save the hardware configuration.
6. Switch back to NetPro using the taskbar (in Windows).
Result: The node interfaces available are displayed in the station.

Important:

Before you switch between the station configuration and NetPro, you must save the data you entered, otherwise the database will not be updated.

Tip

You can open an information window giving details about the station properties by holding the mouse on the symbol for the station.

11.6.4 Creating and Assigning Parameters to a Network Connection

Requirement

NetPro must be open and the existing configured stations must be visible.

Procedure

1. Click on the symbol for the interface of a node (■), hold the mouse button pressed, and drag the mouse pointer to the subnet.
In the case of invalid connection options (for example, connecting an MPI interface to an Ethernet-type subnet), the mouse cursor changes its shape to indicate that the action is prohibited.

Prohibited action: 

Result: The network connection appears as a vertical line between the station/DP slave and the subnet. If the **View > Reduced Subnet Lengths** menu command is selected, the subnet automatically increases in length so that the network connection is located vertically above the interface.

2. Double-click the symbol for the network connection or the symbol for the interface.

Result: The properties dialog box for the subnet node is displayed.

3. Assign the node properties (for example, the name and address of the node).

The following illustration shows the dragging movement of the mouse cursor when the **View > Reduced Subnet Lengths** option is selected.

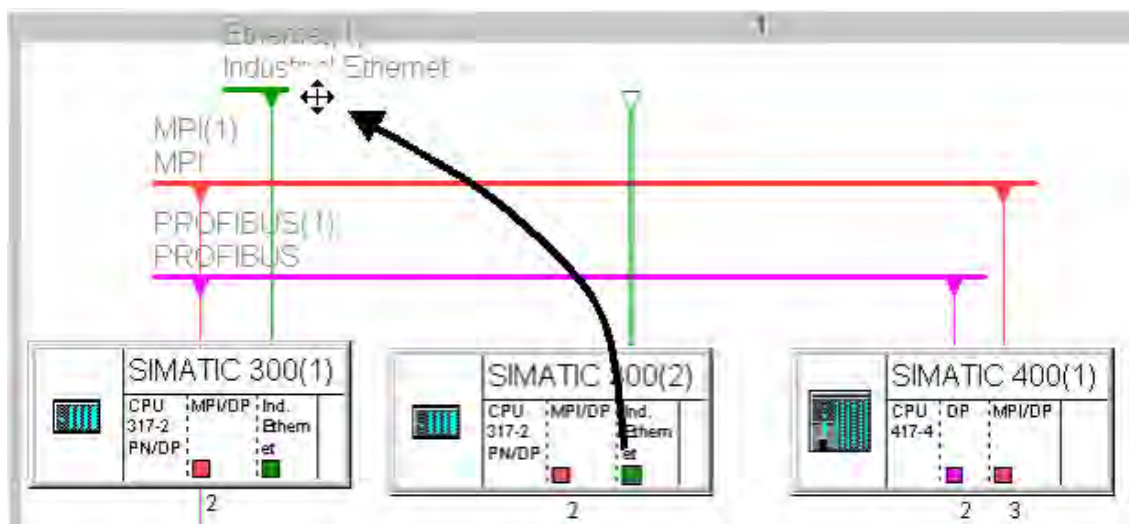

Tips

You can open an information window giving details about the interface properties (module name, subnet type, and, if networked, the node address) by holding the mouse on the interface symbol.

You can show or hide this brief information ("quick info"). To do so, select the **Options > Customize** menu command. In the "Customize" dialog box that is then displayed, go to the "Editor" tab and select or clear the "Display brief information" check box as required.

11.6.5 Creating and Assigning Parameters to a New DP Slave

Requirement:

- You must have assigned a DP master to a station when you configured the hardware in the configuration table.
- DP slaves are displayed in the network view (if not: select the menu command **View > with DP Slaves**).

Procedure

1. If the "Catalog" window is not visible:
Open the "Catalog" window using the menu command **View > Catalog**.
2. In the network view, select the DP master in a station to which you want to assign the DP slave.
3. In the "Catalog" window click on the required DP slave (under "PROFIBUS-DP"), hold the mouse button pressed, and use the drag & drop function to copy it to the window for the graphic network view.
Invalid positions for DP slaves in the view window are shown by a  sign instead of the cursor.
Alternatively you can also double-click the required DP slave in the "Catalog" window.
4. In the properties dialog box which opens automatically, assign a node address for the DP slave.
Result: The DP slave appears in the network view together with its network connection.
5. To assign parameters/set addresses: double-click the DP slave.
Result: Configuring Hardware is started and the DP slave is selected.
6. Set the properties for the DP slave.

Tips

You can open an information window giving details about the DP slave properties by holding the mouse on the symbol for the DP slave.

To find slaves faster in the NetPro catalog, use the "Find" box in the Catalog. This search tool functions just like the one in the Hardware Catalog in HW Config.

11.6.6 Creating and Assigning Parameters to Programming Devices/PCs, 'Other' Stations, and S5 Stations

Overview

What do you do with network nodes that cannot be configured in the current STEP 7 project such as programming devices (PGs), operator stations (OSs), devices made by other manufacturers with their own configuration tool, or S5 devices?

These devices are represented in NetPro by objects such as PG/PC, "other station," and S5 station.

Selecting the Correct Object

The following table shows which object should be inserted in which case:

Object	Purpose	Remarks
PG/PC	To represent in the network view your "own" programming device from which you want to access every node in the subnet online.	Use the "Assignment" tab to establish an assignment between your PG/PC (programming device) and the "PG/PC" object inserted in NetPro. In NetPro the symbol for the PG/PC is specially highlighted.
	For PGs/PCs that are the target for an S7 connection.	For PGs/PCs with S7-SAPI interface
SIMATIC PC station	For PC stations that are the end point of a (two-way) S7 connection; also suitable for redundant S7 connections. For WinLC as of V3.0	The end point of a connection in SIMATIC PC stations is an application such as S7-SAPI ** or WinCC. For a SIMATIC PC station a number of connection end points can be configured.
S5 station	For S5 stations in the subnet	-
Other station	For devices made by other manufacturers which are connected to the subnet.	-

* SIMATIC NET products on CD up to 10/98.

** SIMATIC NET Products on CD as from 10/98, also refer to the Product Information on this CD or S7-REDCONNECT

Procedure

1. If the "Catalog" window is not visible:
Open the "Catalog" window using the menu command **View > Catalog**.
2. In the "Catalog" window click on the required object (under "Stations"), hold the mouse button pressed, and use the drag & drop function to copy it to the window for the graphic network view.
Invalid positions in the view window are shown by a  sign instead of the cursor.
Alternatively you can also double-click the required object in the "Catalog" window.
3. Double-click the object.
Result: A dialog box with tabs for setting the properties is displayed.
4. Set the properties:
 - For all objects except SIMATIC PC stations: in the "Interfaces" tab, create the type of interface that the real object has (for example, PROFIBUS). Via the "Properties" button, set the node and subnet properties.
Result: The object receives an interface symbol for every newly created interface.
 - For the "PG/PC" object: In the "Assignment" tab, set an assignment to an existing module parameter assignment (PC card) if necessary. With this assignment you link the "PG/PC" object in the network view with the actual module parameters of your PG/PC. Advantage: If you, for example, change the transmission rate of the subnet, the module parameters for your PG/PC card change automatically.

11.6.7 Taking Connections for Programming Devices/PCs into Account in the Network Configuration

If you have a networked project with a number of different subnets, you can set up a number of wildcards in the network configuration for a PG (PC) you want to connect up later on. The "PG/PC" object in the network view assumes this "wildcard" function.

This allows you to disconnect a programming device from a subnet and connect it to another subnet. You tell STEP 7 about the PG relocation when you use the **"PLC > Assign PG/PC"** menu command.

The figure below illustrates the setup:

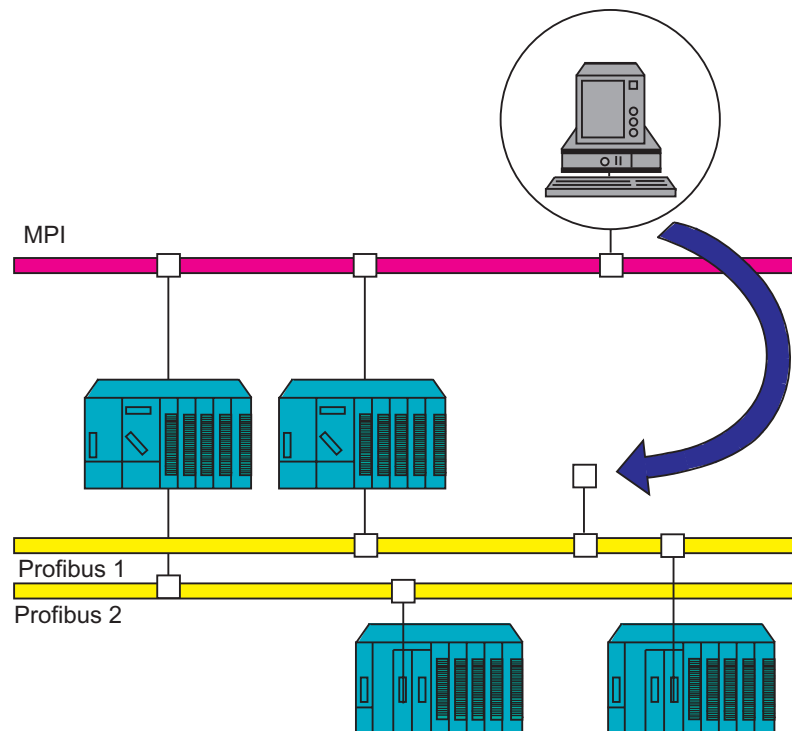

The connection points in the network view look like this ("PG/PC(1)") and ("PG/PC(2)"):

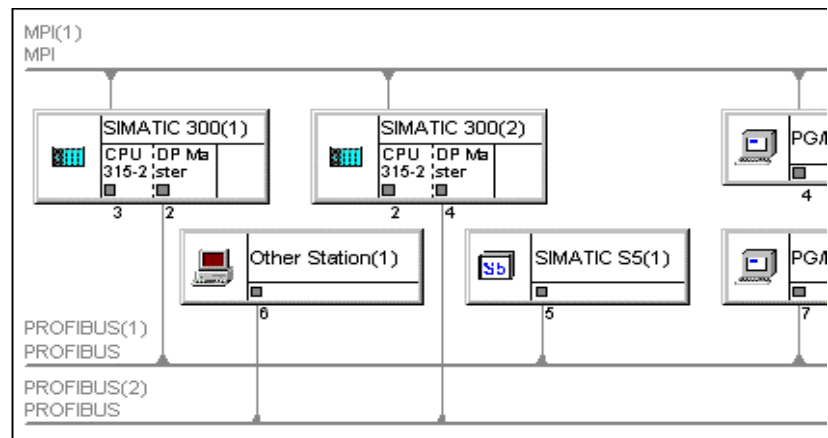

You can now assign your PG one of the "PG/PC" symbols (to identify the device you intend to use for accessing stations online). Assignment updates the interfaces in the programming device (PG or PC) to match the configured settings. If you change your configured settings (e.g. by modifying the transmission rate or another network property), the interface in your PG or PC will be updated automatically.

Procedure

1. If the PG/PC has already been assigned: Reverse the assignment by selecting the "PG/PC" symbol and activating the **PLC > Remove PG/PC Assignment** menu command. The assigned PG/PC symbol differs from the symbol for non-assigned PGs/PCs.
2. Select a "PG/PC" symbol in the network view to represent the programming device you have connected.
3. Select the **PLC > Assign PG/PC** menu command.
4. Use the "Assignment" tab to assign a set of interface parameters in your programming device (your PG/PC) to an interface of the "PG/PC" symbol.

STEP 7 on a SIMATIC PC Station

SIMATIC PC stations as of STEP 7 V5.1, Servicepack 2 are capable of routing.

With STEP 7 on a SIMATIC PC station you can reach all nodes online which are connected to this station. In this case, you do not require a PG/PC assignment to reach the nodes of different subnets.

Conditions to make a SIMATIC PC station routing capable:

- To configure the SIMATIC PC station:
 - STEP 7, version 5.1, Servicepack 2 or
 - SIMATIC NCM PC, version 5.1 including Servicepack 2 (from the SIMATIC NET CD as of 7/2001)
- Runtime conditions for the PC station
 - Installed drivers for CPs: SIMATIC NET CD, as of 7/2001
 - Installed components for WinAC Slot: WinAC Slot 41x, version 3.2

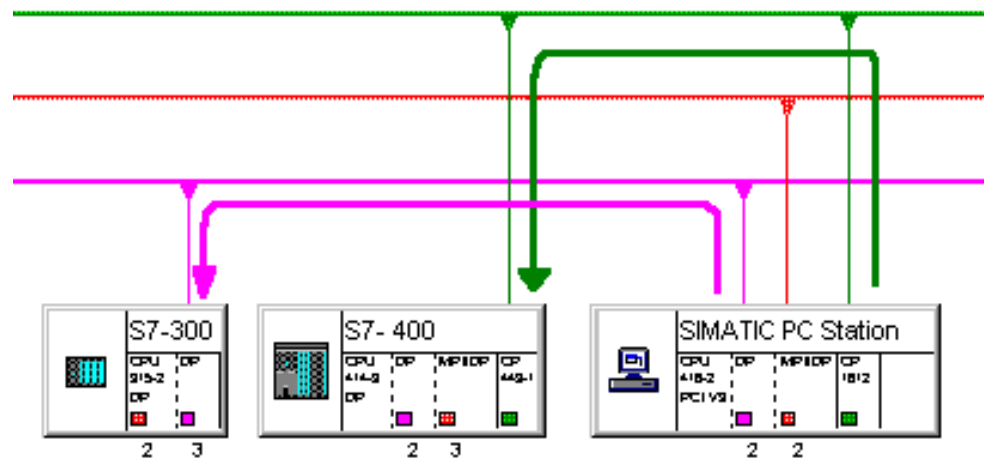

11.6.8 Checking the Consistency of the Network

Before you save, you should check the network configuration for consistency. The following are reported, for example:

- Nodes that are not connected to a subnet (exception: non-networked MPI nodes)
- Subnets that have only one node
- Inconsistent connections

Requirement

NetPro must be open.

Procedure

- Select the menu command **Network > Check Consistency**.
Result: A window "Outputs for Consistency Check" with hints for configuring conflict-free networks and connections is displayed. Inconsistent stations are color-coded in red.

Tip

You can select the window containing the results of the last consistency check at any time using the menu command **View > Errors and Warnings**.

Alternative Procedure

1. Select the menu command **Network > Save and Compile**.
2. In the dialog box, select the option "Check and compile all."

The "Outputs for Consistency Check" Window

Messages and warnings are entered in this window if the consistency check found incorrect project planning/configuration (can refer to the hardware configuration, network or connection planning). A consistency check is carried out during the following actions:

- Menu command **Network > Check Consistency**
- Menu command **Network > Network > Check Cross-Project Consistency**
- Menu command **Network > Save and Compile**
- Download to PLC (consistency check for the stations or connections to which downloading is to be carried out)

Messages in the window "Outputs for Consistency Check" are displayed as **errors**, if no system data (SDBs) could be created during saving and compiling or before downloading to the PLC. Without generated system data it is possible to download the hardware/network and connection configuration cannot be downloaded to the PLC.

Messages in the window "Outputs for Consistency Check" are displayed as **warnings**, if the signaled state allows the generation of system data (SDBs).

If you select a line in the upper section of the output window, this line is repeated in the lower section of the window in word-wrapped text. You do not need to scroll to see all the text.

Selecting a Faulty/Inconsistent Object

Double-click on the corresponding message or warning in the window "Outputs for Consistency Check", or select the **Edit > Go to Error Location** menu command for this window.

Help on a Message/Warning

Select the message or warning and press F1, or select the **Edit > Show Help on Message** menu command.

Saving Messages/Warnings

Select the **File > Save Messages** menu command in the output window.

11.6.9 Saving the Network Configuration

Introduction

To save the connection table, you can choose either of the menu commands **Network > Save** and **Network > Save and Compile**.

Saving

If you have created the network objects in NetPro or changed their properties in NetPro, NetPro saves the following using the menu command **Network > Save**:

- Node addresses
- Subnet properties (such as transmission rate)
- Connections
- Modified module parameters (for example, of CPUs)

Saving and Compiling

When you select the menu command **Network > Save and Compile** you must specify in a dialog box whether you want to compile everything or just the changes:

Independent of the selected option, NetPro checks the consistency of the configuration data throughout the project; any messages are displayed in a separate window.

- "Check and compile all" option
The loadable system data blocks (SDBs) for the entire network configuration are created; they contain all connections, node addresses, subnet properties, input/output addresses, and module parameters.
- "Compile changes only" option
Loadable system data blocks (SDBs) for **modified** connections, node addresses, subnet properties, input/output addresses, and module parameters are created.

11.6.10 Tips for Editing the Network Configuration

Displaying the Network Address Overview

If you want to have an overview of all the assigned node addresses, then select a subnet in the network view.

Depending on the subnet type selected, the lower section of the network view will then show a tabular overview of the MPI, PROFINUS or Ethernet addresses. The remaining columns show the name of the station, the interface and, if a multiproject-oriented network view is open, the project name as well.

Special considerations:

- If an Ethernet subnet is selected, then, depending on the configuration, the IP address, the MAC address or both are shown. If a PROFINET IO system is configured, the device numbers of the nodes are also shown.
- If the multiproject-oriented network view is open and a merged subnet is selected, then the lower section of the window will show all the node addresses for the merged subnet.
- If doubled addresses were issued on the subnet, then they are indicated by an asterisk (*).
- To open the properties sheet for an interface, double-click the corresponding row in the address overview. You cannot change the network address here.

Configuring Connections

If you select a component in the network view that can be an end point of a connection (for example, a CPU), the connection table in which you can configure connections is displayed automatically.

Starting Global Data Configuration

1. In the network view, select an MPI subnet for which you want to configure global data communication.
2. Select the **Options > Define Global Data** menu command.

Result: The GD table for the MPI subnet is opened.

Highlighting the Communication Partners of a Module

If you have already configured connections:

1. Select a programmable module (CPU, FM) in the network view.
2. Select the **View > Highlight > Connections** menu command.

Note: The communication partners of only one programmable module can be highlighted at any one time.

Displaying/Changing the Properties of Components

To display or change the properties of stations or modules, proceed as follows:

1. Select the component (station symbol or module).
2. Select the **Edit > Object Properties** menu command.

Copying Subnets and Stations

1. Select the network objects you want to copy by clicking them with the left mouse button. If you want to copy more than one network object at the same time, select additional network objects with SHIFT + left mouse button.
2. Select the **Edit > Copy** menu command.
3. Click the position in the network view (place the cursor there) where you want to place the copy and select the **Edit > Paste** menu command.

Note: You can copy individual network objects or whole subnets with network connections, stations, and DP slaves. When copying, remember that every node in a subnet must have a unique node address. You should therefore change the node addresses if necessary.

Deleting Network Connections, Stations, and Subnets

1. Select the symbol for the network connection, the station, the DP slave or the subnet.
2. Select the **Edit > Delete** menu command.
When you delete a subnet, the stations which were previously connected to the subnet are retained and can be connected to another subnet if required.

Positioning Stations and Subnets

You can move subnets, stations, and DP slaves (with or without a network connection) anywhere in the view window. This means you can replicate your hardware structure visually on the screen.

- Click the subnet or station/DP slave, hold the mouse button down, and use "drag & drop" to move the subnet or station/DP slave to the required position. Invalid positions for subnets or stations/DP slaves in the view window are shown by a  sign instead of the cursor.

You can also move stations/DP slaves that are already connected to a subnet. The network connections of the stations/DP slaves are retained.

Reducing Subnet Lengths

In NetPro, subnets are displayed in a horizontal line that extends "infinitely." To reduce the length of the subnets so that stations can be grouped with their subnets and arranged in a clearer and more understandable manner, select the **View > Reduced Subnet Lengths** menu command. The length shown is determined by the distance between the networked interfaces and is adapted automatically. The subnet will extend a little bit beyond the networked modules.

If the subnet does not yet have a node connected to it, such as after a new subnet has been inserted, the length shown is "infinite" and is dependent on the setting selected in the "View" menu.

Note

If you change the view, connect stations to subnets or arrange subnets and stations, then it may happen that the subnets overlap each other. In this case, you will have to arrange the stations and subnets again.

Arranging the Network View - Assigning DP Slaves to Their DP Masters

In the graphical network view, in order to rearrange a network configuration that has become confusing, you can assign the DP slaves to their respective DP master stations visually:

Requirement: The "with DP Slaves" view is activated (menu command: **View > With DP Slaves**).

Select the **View > Rearrange** menu command (as of STEP 7 V5.1, Service Pack 1).

Selecting a Master System

You can select a whole master system to copy it, for example.

1. Select a master or a slave in the network view.
2. Select the **Edit > Select > Master System** menu command.

Highlighting a Master System

1. Select a DP master or a DP slave in the network view.
2. Select the **View > Highlight > Master System** menu command.

Online Access to Modules

You have access to the following functions via the "PLC" menu:

- Display module information
- Change the operating mode of a module
- Clear/reset a module
- Set the date and time for a module
- Download and upload

11.7 Networking Stations that Represent Network Gateways

11.7.1 Networking Stations that Represent Network Gateways

Overview

For most programmable logic controller systems, you can operate the programming device exclusively by means of the bus cable (subnet) that is connected to the programmable logic controller directly. For relatively large networked systems, this situation requires that the programming device be connected to various bus cables (subnets) before a remote programmable logic controller can be reached online.

From STEP 7 V5 on, it is possible for you to access programmable logic controllers online with the programming device/PC beyond the limits of a subnet in order, for example, to download user programs or a hardware configuration or to execute test and diagnostics functions.

The "PG Routing" function makes it possible to reach programmable logic controllers from a fixed location in the system beyond the different subnets without having to reconnect the bus connectors. For this purpose, special "routing tables" are generated automatically for the network gateways during network configuration with STEP 7. These routing tables are special system data and must be loaded to the individual network gateways, that is, S7 CPUs or communication processors (CPs). Afterward, when the programming device goes online, the way to the selected programmable logic controller can be found by means of the network gateways.

Network Gateway

The gateway from a subnet to one or more other subnets lies in a SIMATIC station that has interfaces to the respective subnets.

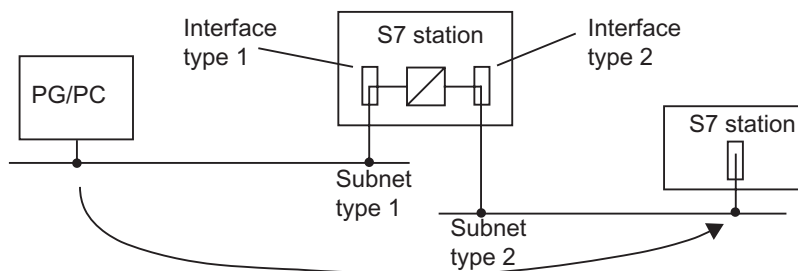

Requirements

- STEP 7 as of Version 5
- The modules with communication capability (CPUs or CPs) that are supposed to establish network gateways between the subnets must be capable of routing (the info text on the respective component can be found in the hardware catalog).
As of STEP 7 Version 5.1, Servicepack 2, SIMATIC PC stations can also be capable of routing.
- All reachable programmable logic controllers or communication partners in a system network must be configured and loaded within an S7 project.
- The desired S7 station is networked and can actually be reached by means of the network gateways.
- The modules must be loaded with the configuration information that contains the current "knowledge" of the entire network configuration for the project.
Reason: All the modules involved in the network gateway must receive information about which subnets can be accessed via which routes (routing tables).
- The programming device/PC with which you want to establish an online connection by means of a gateway must be configured and assigned to your programming device in the network configuration.

Additional Information for Network Gateways

In addition to node address, subnet properties, and connections, STEP 7 V5 also generates routing information that must be loaded onto the corresponding modules.

Routing information includes:

- Module interfaces
- Assignment to connected subnets
- The next network gateways in order to be able to access a remote subnet from one of the connected subnets

This information is generated automatically by STEP 7 when the network or station configuration is compiled (menu command: ... > **Save and Compile**).

Which Modules or Stations Must Be Loaded After a Change to a Network Configuration?

If you change a configuration as follows you have to reload
Delete or add a network connection to a station (station equals network gateway)	All network gateways
Modify an interface address on the subnet (station equals network gateway) or plug a module with its own MPI address into an S7-300 station in such a way that the MPI address of a network gateway (next module inserted) is changed	Network gateways on the same subnet
Add or delete a network gateway	All network gateways
Insert a module with a network connection in another slot (station equals network gateway)	All modules for this station
Add a subnet	-
Delete a subnet (where network gateways are configured on this subnet)	All network gateways
Change a subnet ID	If any network gateways are connected to this subnet: All network gateways

S7 Subnet ID for an Online Connection via Network Gateways

If the network configuration together with all the routing information was downloaded to the affected stations, you must also specify an S7 subnet ID to access the remote station.

The S7 subnet ID that is requested by STEP 7 using dialog boxes is formed from two numbers:

- A number for the project
- A number for the subnet

Both numbers can be determined via the properties dialog box of the subnet with an existing network configuration. If you want to go online with a programming device without a consistent project, you must know the subnet ID. The subnet ID is printed out with the network configuration.

11.7.2 Programming Devices / PCs Connected to a Subnet via TeleService or WAN

A programming device or PC that accesses nodes in a remote subnet via TeleService or WAN (Wide Area Network) is dealt with as follows in the network configuration:

The "PG/PC" object is connected directly to the remote subnet in the network configuration of STEP 7. The network gateway via a TS adapter or router is not visible in the configuration.

Example: Connecting a Programming Device via TeleService

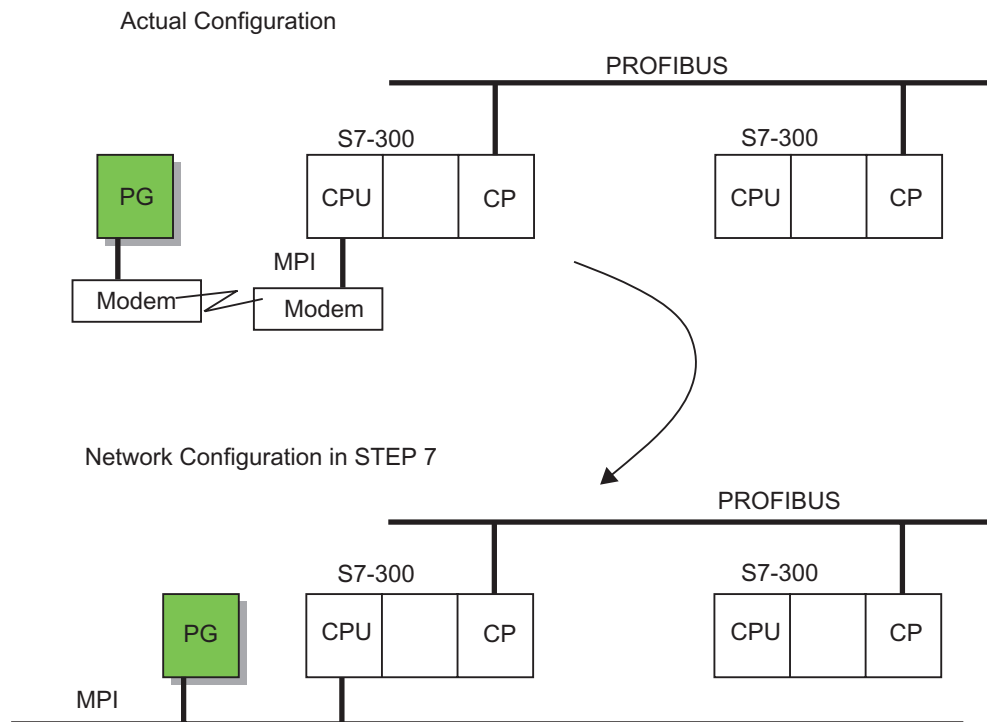

Example: Connecting a Programming Device via WAN

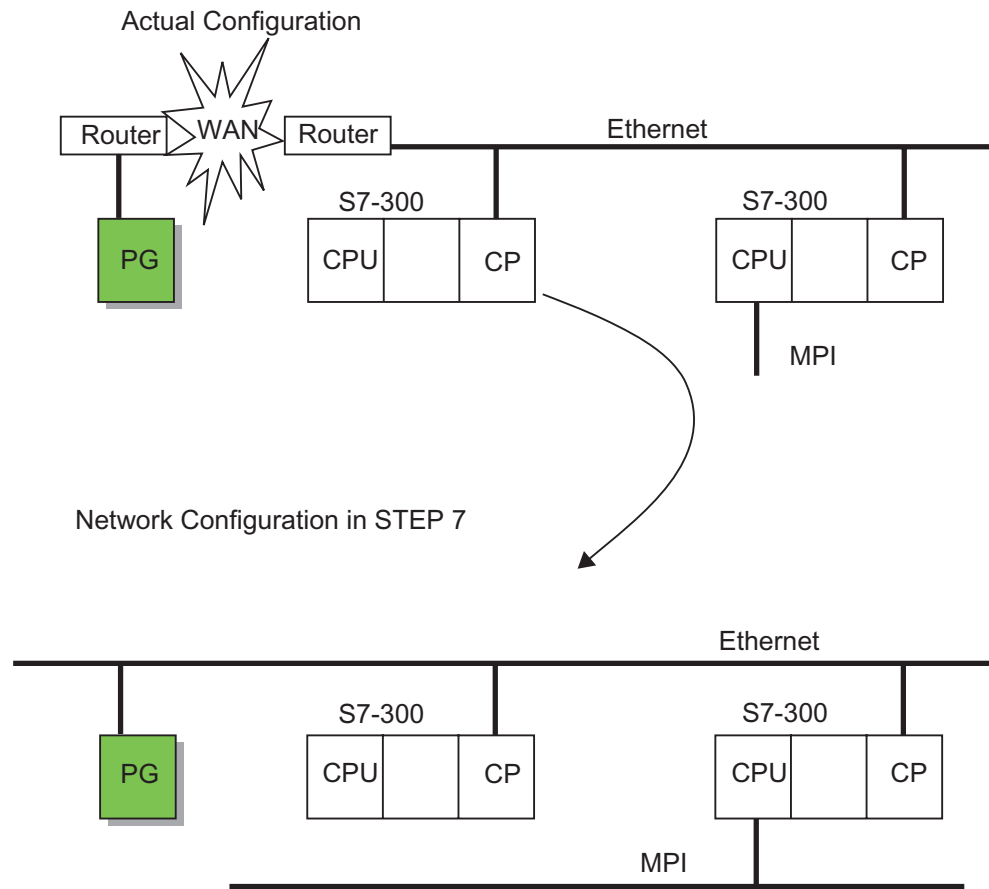

11.8 Networking Stations from Different Projects

Introduction

In complex networked systems, it may be advantageous to manage the stations in more than project.

As of STEP 7 V5.2, you can configure several projects by using a multiproject. This procedure is recommended for new projects.

In the figure below, a networked system is divided into two system parts (projects) "Manuf1" and "Manuf2."

Without a multiproject, the following problem arises: for the project "Manuf1," stations that were configured in the project "Manuf2" are unknown.

Configuring Without a Multiproject

- You must insert the symbol "Other Station" in the project "Manuf1" to represent a station in the project "Manuf2." The "Other Station" as a "stand-in object" is restricted to the properties that are relevant for the network view.
- You must program the subnet to which both parts of the system are connected twice in identical form: once in the project "Manuf1" and once in the project "Manuf2."

The responsibility for the consistency of the network data in the different projects lies with you in this case; STEP 7 cannot ensure consistency "beyond project boundaries."

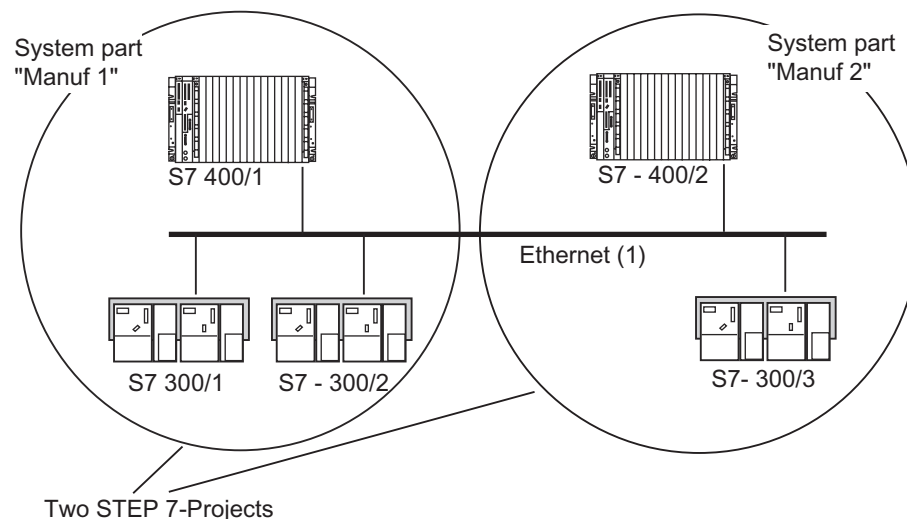

12 Configuring Connections

12.1 Introduction to Configuring Connections

Introduction

Communication connections are always required when you want to exchange data using special communication blocks (SFBs, FBs, or FCs) in the user program.

This section describes how you define connections with *STEP 7*, which particular features you should note, and which communication blocks you can use in the user program.

What is a Connection?

A connection is a logical assignment of two communication partners to execute communications. A connection determines the following:

- The partners involved in communication
- The type of connection (for example, S7, point-to-point, FDL, or ISO transport link)
- Special properties (such as whether a connection remains permanently configured, or whether it is established and disconnected dynamically in the user program, and whether operating mode messages should be sent).

What Happens When You Configure Connections?

When you configure connections, a unique "local ID" is assigned for each connection. Only this local ID is required when you assign parameters to communication blocks. Every programmable module that can be an end point in a connection has its own connection table.

12.2 Configuring Communication with an Ethernet CP

Type of Communication

The Ethernet CP supports the following types of communication, depending on the CP type:

- **S7 communication**
S7 communication forms a simple and efficient interface between SIMATIC S7 stations and PGs/PCs using communication function blocks.
The CP functions as an "S7 communication relay", that passes on the block communication on Industrial Ethernet.
- **S5 compatible communication**
- **SEND-RECEIVE interface**
Depending on the CP type, the SEND-RECEIVE interface allows program-controlled communication on a configured connection from a SIMATIC S7 PLC to another SIMATIC S7 PLC, to a SIMATIC S5 PLC, to PCs/PGs, and to any other station.
- **FETCH/WRITE services (Server)**
FETCH/WRITE services (Server) allow direct access to system memory areas of a SIMATIC S7 CPU from a SIMATIC S5 system or from third-party devices.
- **HTML Process Control**
With the IT-CP, you use the included functions and HTML pages to enquire about important system data by means of a web browser (see the guide to the IT-CP).
- **File management and file access via FTP**
The IT-CP provides additional functions for FTP services.

Communication Services on the SEND/RECEIVE Interface

Depending on the CP type, the following communication services are available:

- **ISO Transport**
optimized for top performance at the self-contained manufacturing level
- **TCP/IP for internet communication with**
 - ISO-on-TCP connections (RFC 1006) and
 - UDP datagram service.
- **Sending E-Mail**
The controller can send messages depending on process events (see the guide to the IT-CP).

12.3 Configuring Communication with a PROFIBUS CP

Type of Communication

The PROFIBUS CP supports the following types of communication (depending on the CP being used):

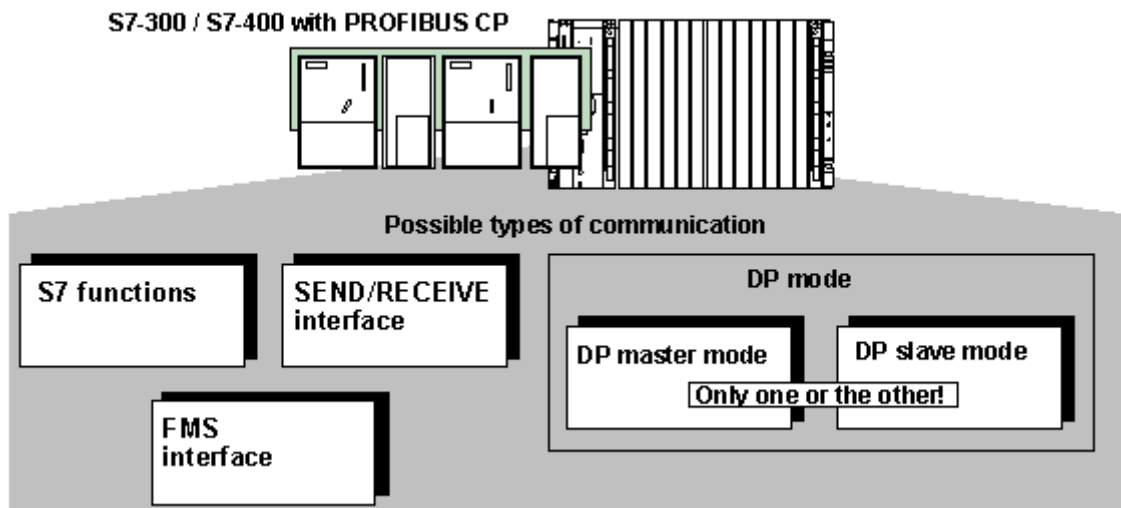

- PG/OP communication
PG/OP communication is used to download programs and configuration data, to perform testing and diagnostics functions as well as for operator control and monitoring of a system via OPs.
- S7 communication
The S7 communication forms a simple and efficient interface between SIMATIC S7 stations and PGs/PCs using communication function blocks.
The CP functions as an "S7 communication relay", that passes on the communication on PROFIBUS.
- S5 compatible communication (SEND-RECEIVE interface)
The SEND/RECEIVE interface allows program-controlled communication on a configured connection from a SIMATIC S7 PLC to another SIMATIC S7 PLC, a SIMATIC S5 PLC and to PCs/PGs.
- Standard communication (FMS interface)
(complying with EN 50170 Vol. 2; FMS client and server function)
The FMS interface allows the program-controlled, neutral transmission of structured data via a configured connection from SIMATIC S7 PLCs to devices that support the FMS protocol.
- PROFIBUS DP
(complying with EN 50170 Vol. 2, DP master or DP slave)
The distributed peripheral I/Os (DP) allow you to use a large number of analog and digital input/output modules in the immediate vicinity of the process in a distributed configuration.

12.4 What You Should Know About the Different Connection Types

Introduction

The following sections provide a brief overview of the connection types you can configure with STEP 7. The "Communicating with SIMATIC" manual provides a more detailed description of the communications possibilities in SIMATIC.

S7 Connections

S7 connections offer the following features:

- Can be configured in all S7/M7 devices
- Can be used in all types of subnet (MPI, PROFIBUS, Industrial Ethernet)
- When using the SFBs BSEND/BRCV: secure transfer of data between SIMATIC S7/M7-400 stations; for example, exchanging data block contents (up to 64 Kbytes)
- Using CPU 317-2 PN/DP as well as CPU 31x and a CP with the FBs BSEND/BRCV from the SIMATIC_NET_CP library or Standard Library also allows secure transmission of data to S7-300 and S7-400.
- When using the SFBs USEND/URCV: fast, unsecured transfer of data independent of the time processing of the communication partner, for example, for event messages and messages.
- Acknowledgement of data transfer from the communication partner via layer 7 of the ISO reference model

S7 Connections, Redundant

- Properties as for S7 connections; however, restricted to S7 H CPUs as well as SIMATIC PC stations (such as OPC servers) and not on MPI subnets
- Depending on the network topology, at least two connection paths between the connection end points are possible with a redundant S7 connection.

Point-to-Point Connection

The local CP 441 provides the link for the connection between an S7-400 CPU and a communication partner connected via a point-to-point connection. On the CP, a conversion is made to the addressing mechanisms of the selected transfer procedure. For this reason, the point-to-point connection ends in the CP 441 and not at the communication partner as for other connection types.

The number of connections to the CP depends on the set procedure.

FMS Connection

PROFIBUS FMS (Field bus Message Specification) has the following features:

- For the transfer of structured data (FMS variables)
- Fulfills the European standard EN 50170 Vol.2 PROFIBUS
- For open communication with non-Siemens devices on PROFIBUS
- Application on the remote communication partner acknowledges receipt of the data
- Can be ordered in layer 7 of the ISO reference model
- FMS services are provided on the PC as C functions

FDL Connection

PROFIBUS FDL (Field bus Data Link) has the following features:

- For the transfer of data to a communication partner (for example, SIMATIC S5 or PC) that supports sending and receiving in accordance with the SDA function (Send Data with Acknowledge)
- The receipt of data is confirmed by the FDL service of the communication partner with an acknowledgement
- For PROFIBUS subnets only
- Fulfills the European standard EN 50170 Vol.2 PROFIBUS
- Can be ordered in layer 2 of the ISO reference model
- FDL services are provided on the PC as C functions

ISO Transport Connection

The ISO Transport connection has the following features:

- Suitable for large quantities of data owing to "data blocking"
- Allows communication to a partner (for example, SIMATIC S5 or PC) that supports sending and receiving of data in accordance with ISO Transport
- You can use the Send/Receive utilities and the Fetch and Write utilities to transmit data.
- For Industrial Ethernet only
- The receipt of data is confirmed by the ISO Transport service of the communication partner with an acknowledgement
- ISO Transport (ISO 8073 class 4) corresponds to layer 4 of the ISO reference model
- ISO Transport services are provided on the PC as C functions

ISO-on-TCP Connection

The ISO-on-TCP connection has the following features:

- Fulfills the TCP/IP (Transmission Control Protocol/Internet Protocol) standard with the extension RFC 1006 in accordance with layer 4 of the ISO reference model. RFC 1006 describes how the services of ISO layer 4 can be mapped onto TCP
- Allows communication to a partner (for example, SIMATIC S5 or PC) that supports sending and receiving of data in accordance with ISO-on-TCP
- You can use the Send/Receive utilities and the Fetch and Write utilities to transmit data.
- The receipt of data is confirmed with an acknowledgement
- For Industrial Ethernet only
- ISO-on-TCP services are provided on the PC as C functions

TCP Connection

The TCP connection has the following features:

- Complies with the TCP/IP standard (Transmission Control Protocol/Internet Protocol)
- Enables communication to a partner (such as a PC or non-Siemens device) that supports sending or receiving data according to TCP/IP.
- You can transmit data by means of the utilities Send/Receive or Fetch and Write.
- For Industrial Ethernet only
- As a rule, you can use the TCP/IP implementation in the operating system of the PC.

UDP Connection

The UDP (User Datagram Protocol) connection has the following features:

- For Industrial Ethernet (TCP/IP protocol)
- Allows unsecured transfer of contiguous blocks of data between two nodes

E-Mail Connection

The e-mail connection has the following features:

- For Industrial Ethernet (TCP/IP protocol)
- Enables process data, for example, to be sent from data blocks via e-mail using an IT communications processor
- Using the e-mail connection, you define the mail server via which all e-mails sent by an IT communications processor are delivered

12.5 What You Should Know About Assigning Connection Resources

Introduction

At the stations involved, each connection requires connection resources for its endpoint and its transition point (i.e. CP). The actual number of connection resources available depends on the CPU/CP in use.

If all the connection resources for a communication partner occupied, then a new connection will not be able to be established. The following discussion treats each type of communication individually. Within the limits imposed by the amount of resources available, combinations of any type are possible.

S7 Connections

For S7 connections established through the **integrated** MPI-/PROFIBUS DP/PN interface, one connection resource for the end point is occupied at the CPU for each S7 connection. This applies to all S7/M7-300/400 and C7-600 CPUs.

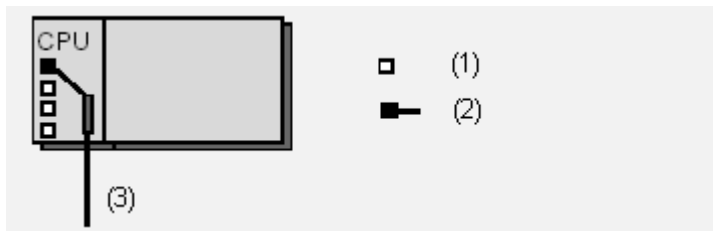

- (1) Available connection resource
- (2) Assigned connection resource
- (3) MPI, PROFIBUS DP or Industrial Ethernet (PROFINET)

For S7 connections established through an **external** CP interface, a connection resource is occupied at the CPU for (the end point) and at the CP (transition point) for each STEP 7 connection. This applies to all S7/M7-300/400 and C7-600-CPU's.

Tip: Connection resources for an S7-300 CPU can be reserved for OP/programming device (PG) communication and S7 basic communication in the properties dialog of the CPU ("Communication" tab). The already configured S7 connections are displayed there as well ("S7 Communication").

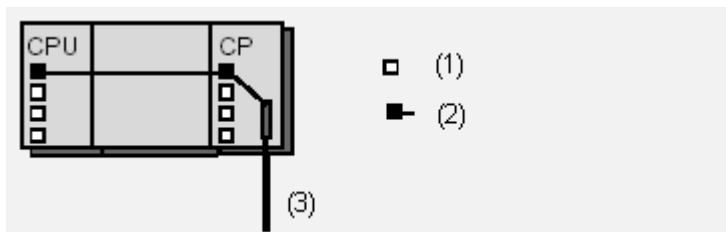

- (1) Available connection resource
- (2) Assigned connection resource
- (3) Industrial Ethernet, PROFIBUS

Note

To execute programming device functions on CPs for the S7-400 through the MPI or through the integrated DP interface, two connection resources are needed at the CPU (for two transition points). This requirement must be taken into account in determining the total number of configured STEP 7 connections.

SEND/RECEIVE Interface

Communication through the SEND/RECEIVE interface takes place only through CPs. Each connection (i.e. FDL, ISO-transport, ISO-on-TCP, UDP and TCP connections) takes up one resource at the CP for the end point.

At an S7-300 CPU and a C7-600 CPU, no connection resources are required for the connection.

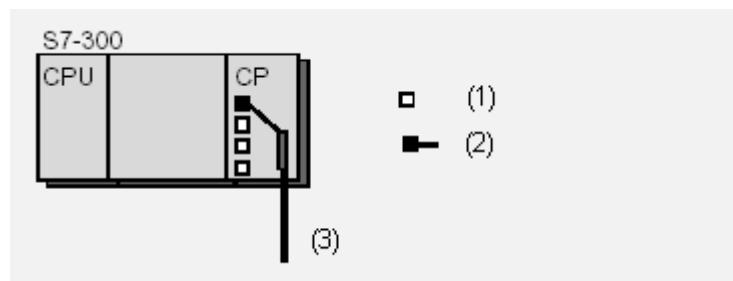

- (1) Available connection resource
- (2) Assigned connection resource
- (3) Industrial Ethernet, PROFIBUS

At a S7-400 CPU, no connection resources are required for SEND/RECEIVE connections (i.e. FDL, ISO-transport, ISO-on-TCP connections).

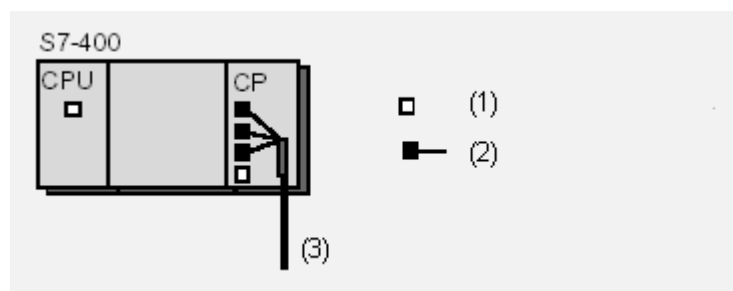

- (1) Available connection resource
- (2) Assigned connection resource
- (3) Industrial Ethernet, PROFIBUS

Note

To execute programming device functions on CPs for the S7-400 through the MPI or through the integrated DP interface, two connection resources are needed at the CPU (for two transition points). This requirement must be taken into account in determining the total number of configured STEP 7 connections.

FMS Interface

Communication through the FMS interface takes place only through CPs. Each FMS connection takes up one resource at the CP for the end point. At the CPU, each CP requires a connection resource for communication to it.

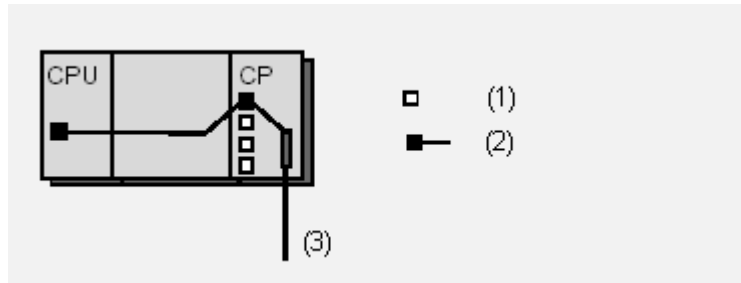

- (1) Available connection resource
- (2) Assigned connection resource
- (3) PROFIBUS

Note

To execute programming device functions on CPs for the S7-400 through the MPI or through the integrated DP interface, two connection resources are needed at the CPU (for two transition points). This requirement must be taken into account in determining the total number of configured STEP 7 connections.

S7 Connections through S7/M7-300 and C7-600

For S7 connections established via the MPI interface, only one connection resource for the end point is occupied at the FM for an S7/M7-300 (for CPU 312-316 only) and C7-600.

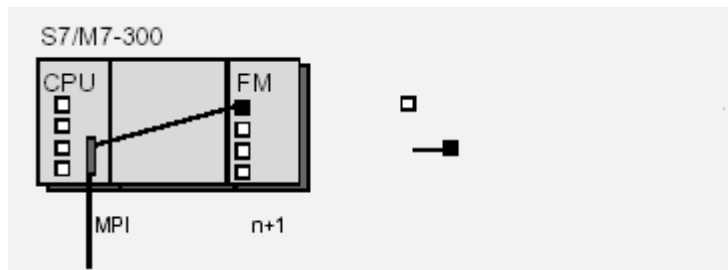

- (1) Available connection resource
- (2) Assigned connection resource

For S7 connections established via the internal MPI-/PROFIBUS DP interface, two connection resources (for two transition points) at the CPU are occupied; at the FM, one is required in each case (for the end point).

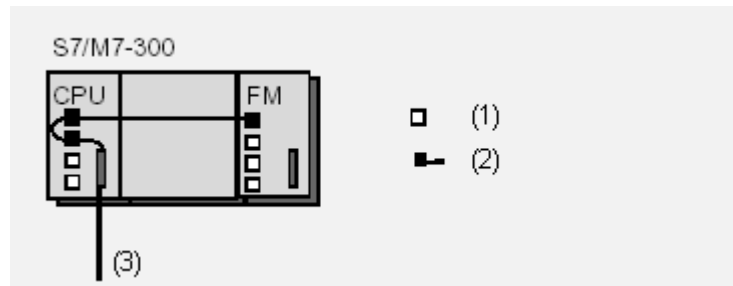

- (1) Available connection resource
- (2) Assigned connection resource
- (3) PROFIBUS DP

S7 Connections through S7/M7-400

For S7 connections established through the internal MPI-/PROFIBUS DP interface, two connection resources (for two transition points) at the CPU are occupied; at the FM, one is required in each case (for the end point). This also applies for each additional CPU (multicomputing) within the same station since this node is on the MPI.

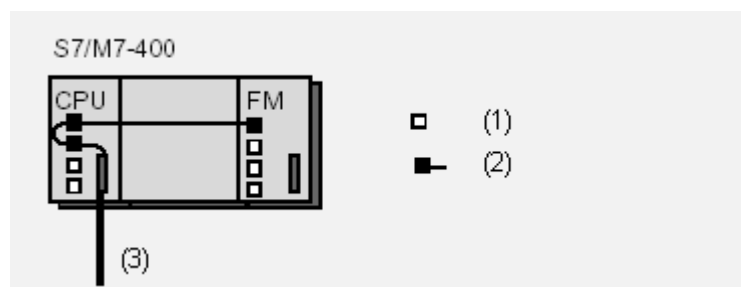

- (1) Available connection resource
- (2) Assigned connection resource
- (3) MPI or MPI/PROFIBUS DP

S7 Connections through M7 FMs

For S7 connections established through the internal MPI-/PROFIBUS DP interface, each S7 connection at the FM requires two connection resources (for two transition points); at an S7/M7 CPU or C7-600 CPU, one is required in each case (for the end point).

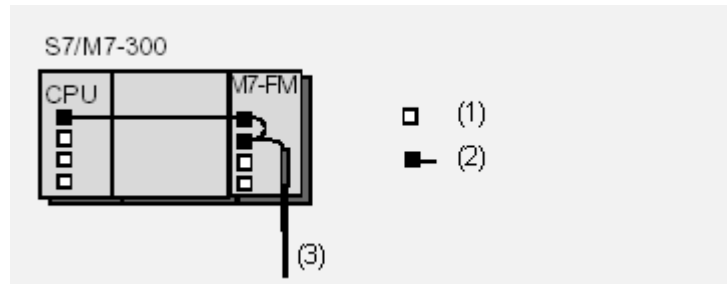

- (1) Available connection resource
- (2) Assigned connection resource
- (3) PROFIBUS DP

12.6 Using Connection Resources with Fault-Tolerant S7 Connections

For H-systems, there are a number of possible configurations that differ with respect to the number of H-CPU's, number of CP's and number of subnets. Depending on the configuration, two or four partial connections are possible for each fault-tolerant S7 connection. These connections ensure communication is maintained even if a component should fail.

The following sections describe the most common configurations and how they use connection resources for a fault-tolerant connection.

Basic Information

At each H-CPU, a connection resource is occupied for each of the endpoints of a fault-tolerant S7 connection (that is, for redundant connections on both H-CPU's concerned).

For each fault-tolerant S7 connection, STEP 7 establishes two partial connections as alternative communication paths. To ensure the availability of both paths, each path must have resources reserved for it. If both partial connections run through the same intermediate CP, then two connection resources are also reserved on this CP.

The following sections explain this situation in detail.

Notes on the Illustrations

For redundant H-stations, the two CPU's are labeled "H-CPU 0" and "H-CPU 1".

The CP's are numbered sequentially (CP 0, CP1, ...).

Case 1: Configuration with redundant H-stations (local and remote), two partial connections possible

As shown in the following illustrations, each of the two CPUs has one resource assigned on it, and each of the CPs involved has one connection resource assigned on it as well.

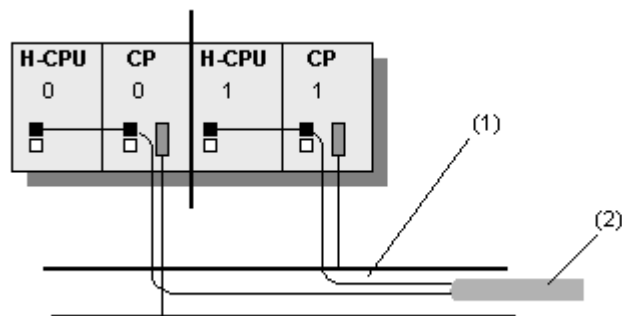
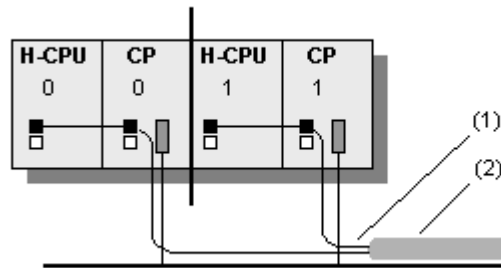

- (1) Partial connection
- (2) Fault-tolerant S7 connection

Case 2: Configuration with non-redundant H-Station (local) and redundant H-Station (remote)

In this case, there is a difference whether the redundant partner station is fitted with a total of two or four CPs.

If the partner station is fitted with a total of two CPs, then one connection resource is reserved on the local H-CPU and two connection resources are reserved on the local CP.

If the partner station is fitted with a total of four CPs and the "Enable max. CP redundancy" option was selected, then a total of four connection paths is possible. Even so, one connection resource is reserved the local H-CPU, and two connection resources are reserved for the local CP. The reason for this is that a maximum of two partial connections can be active.

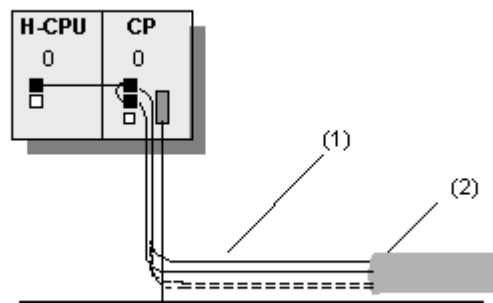

- (1) Partial connection
- (2) Fault-tolerant S7 connection

Case 3: Configuration with redundant H-stations (local and remote), four partial connections possible

If redundant H-stations are connected in a subnet, then a maximum of four partial connections is possible. One connection resource is reserved for each of the H-CPU's, and two connection resources are reserved for each of the CPs involved

The following partial connections are possible:

From H-CPU0/CP0 (local station) to CP0 /H-CPU0 (partner station)

From H-CPU1/CP1 (local station) to CP1 /H-CPU1 (partner station)

From H-CPU0/CP0 (local station) to CP1 /H-CPU1 (partner station)

From H-CPU1/CP1 (local station) to CP0 /H-CPU0 (partner station)

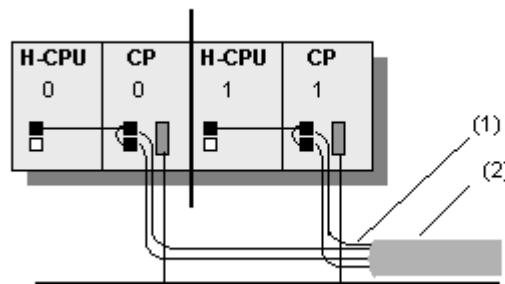

- (1) Partial connection
- (2) Fault-tolerant S7 connection

Case 4: Configuration with non-redundant H-Station and two CPs (local) and a redundant H-Station (remote)

If the local station is fitted with a total of two CPs, then one connection resource is reserved on the local H-CPU and one connection resource is reserved on each of the local CPs.

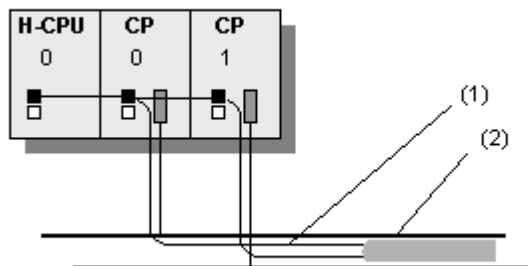

- (1) Partial connection
- (2) Fault-tolerant S7 connection

Call 5: Configuration with redundant H-Station (local) and redundant H-Station (remote) with maximum CP redundancy

If the local station and the partner station are fitted with a total of four CPs and the "Enable max. CP redundancy" option was selected, then a total of four connection paths is possible. STEP 7 reserves one connection resource for the local H-CPU and connection resource for each of the local CPs.

The following partial connections are possible:

From H-CPU0/CP0 (local station) to CP0 /H-CPU0 (partner station)

From H-CPU1/CP2 (local station) to CP2 /H-CPU1 (partner station)

From H-CPU0/CP1 (local station) to CP1 /H-CPU0 (partner station)

From H-CPU1/CP3 (local station) to CP3 /H-CPU1 (partner station)

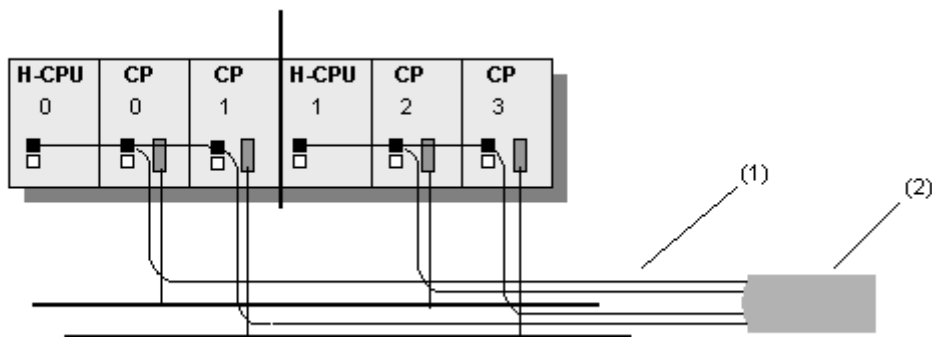

(1) Partial connection

(2) Fault-tolerant S7 connection

12.7 Blocks for Different Connection Types

Blocks for Use with S7 Connections

The system function blocks are integrated in the CPUs of the S7-400.

For S7-300, with newer CPUs and CPs, you can operate S7 communication actively (that is, as client) by means of the interface of the CP. The blocks (FBs) have the same number and designation as the SFBs of the S7-400; however, they must be called up cyclically in the user program of the S7-300-CPU. You can find the blocks in the SIMATIC_NET_CP library.

The CP must support the client function for S7 communication.

The CPU 317-2 PN/DP with PROFINET interface can also be configured as a client for S7 communication. In this case, the same blocks are used as in the case for the S7-300 with CP mentioned above. These blocks are also in the Standard Library (Communication Blocks/CPU_300). The client function is only available with the PROFINET interface.

SFB/FB/FC	Designation	Brief Description
SFB8/FB8 SFB9/FB9	USEND URCV	Uncoordinated data exchange using a send and a receive SFB Max. length SFB 8/9: 440 bytes, split into 4x100 bytes. Max. length FB 8/9: 160 bytes
SFB12/FB12 SFB13/FB13	BSEND BRCV	Exchange blocks of data of variable length between a send SFB and a receive SFB Max. length SFB 12/13: 64 KB Max. length FB 12/13: 32 KB
SFB14/FB14	GET	Read data from a remote device Max. length SFB 14: 400 bytes, split into 4x100 bytes Max. length FB 14: 160
SFB15/FB15	PUT	Write data to a remote device Max. length SFB 15: 400 bytes, split into 4x100 bytes Max. length FB 15: 160
SFB19	START	Execute a restart (warm restart) on a remote device
SFB20	STOP	Switch a remote device to STOP mode
SFB21	RESUME	Execute a hot restart in a remote device
SFB22	STATUS	Specific query of the status of a remote device
SFB23	USTATUS	Receive status messages from remote devices
SFC62	CONTROL	Query the status of the connection that belongs to an SFB instance
FC62	C_CNTRL	Query the status of a connection (for S7- 300 CPUs)

Blocks for Use with Point-to-Point Connections

For the PtP connection type you can use the SFBs BSEND, BRCV, GET, PUT, and STATUS (see above table).

You can also use the SFB PRINT:

SFB	Designation	Brief Description
SFB16	PRINT	Send data to a printer

Blocks for Use with FMS Connections

FB	Designation	Brief Description
FB 2	IDENTIFY	Identify the remote device for the user
FB 3	READ	Read a variable from a remote device
FB 4	REPORT	Report a variable to the remote device
FB 5	STATUS	Provide the status of a remote device on request from the user
FB 6	WRITE	Write variables to a remote device

Blocks for Use with FDL, ISO-on-TCP, UDP and ISO Transport Connections as well as Email Connections

FC	Designation	Brief Description
FC 5	AG_SEND	Send data by means of a configured connection to the communication partner (<= 240 bytes).
FC 6	AG_RECV	Receive data by means of a configured connection from the communication partner (<= 240 bytes, not email).
FC 50	AG_LSEND	Send data by means of a configured connection to the communication partner.
FC 60	AG_LRECV	Receive data by means of a configured connection from the communication partner (not email).
FC 7	AG_LOCK	Lock the external data access by means of FETCH/WRITE (not for UDP, email).
FC 8	AG_UNLOCK	Unlock the external data access by means of FETCH/WRITE (not for UDP, email).

12.8 Working with the Connection Table

Displaying and Hiding Columns of the Connection Table

1. Place the pointer in the connection table and click with the right mouse button to display a pop-up menu.
2. In the pop-up menu, select **Show/Hide Columns** >.... In the next pop-up menu, select the name of the column that you want to show or hide.

The names of the visible columns are indicated with a check mark. If you select a visible column, the check mark disappears and the column is hidden.

Optimizing the Column Width

In order to adapt the width of a column to its contents so that all the text in the rows is legible, proceed as follows:

1. Place the pointer **in the header** of the connection table to the right of the column that you want to optimize until the pointer assumes the shape of two parallel lines (as though you wanted to change the width of the column by dragging with the pointer).
2. Double-click this position.

Tip: For columns that are set too narrowly, you can display the complete contents if you allow the pointer to rest for a short time on the field in question.

Sorting the Connection Table

In order to sort the connection table in ascending order according to a column, click the heading of the column.

An additional click on the heading sorts the connection table in descending order.

Note

The column width and which columns are visible are saved for each project when you exit the project. This means that when you open the project on another computer, the settings are also valid on that computer.

Further Information

For further information on the columns of the connection table please refer to the context help (for example for the menu command **View > Display/Hide Columns** ...).

Navigating with Cursor Keys and Calling Up Dialogs for Editing

You can use the UP ARROW and the DOWN ARROW keys to select a connection in the connection table. The selected connection is highlighted.

If you use the RIGHT ARROW key or the LEFT ARROW key to navigate to the field in the "Partner" column and you press ENTER, the Change Connection Partner dialog appears. If you navigate to a different field (such as Local ID) and you press ENTER, the "Properties - Connection dialog appears.

If you have selected multiple connections, that is, if you have highlighted several columns (by holding down the CTRL key and selecting one column after another), and by so doing have called up the accompanying dialog (Change Connection Partner or Properties of the Connection), the dialogs of the highlighted connections appear one after the other.

Changing the Properties of the Connection

If you want to change a connection that has already been configured, for example, to set a different connection path (interface), proceed as follows:

1. Select the connection that you want to change.
2. Select the menu command **Edit > Object Properties**.
In the dialog box that appears, you can change the properties that can be edited.

Changing local data only: As of STEP 7 V5.1, Service Pack 1, you can change the local ID directly in the Local ID column of the connection table.

Go To Partner Station

As of STEP 7 V5.2 you can easily move to the connection table of a connection partner when you edit the connection table:

1. Select a connection from the connection table.
2. Select menu command Edit > Go To Partner Connection.

This function is also available for interproject connections in the multiproject. The project that contains the connection partner must be open.

12.9 Inconsistent Connections

If a connection is inconsistent, the structure of the connection data is disrupted, or the connection would not be capable of functioning in the context of the project.

Inconsistent connections cannot be compiled and loaded - no operation is possible with such a connection.

Inconsistent connections are identified in the connection table by the color **red** and *italics*.

Possible Causes of Inconsistent Connections

- Deleting or altering the hardware configuration
- Missing networking of interfaces in the project that are necessary for a connection
- Exceeding connection resources
- Error in saving data due to insufficient memory
- Connections to an unspecified partner without specifying the partner address
- Connections to a "partner in an unknown project ", whereby the connections have yet to be configured

Detailed information about the causes of inconsistent connections are listed in the Outputs on Consistency Check window (after the consistency check has been run, menu command **Network > Check Consistency** or **Network > Check Cross-Project Consistency**).

Detailed information on the cause of the inconsistency can be obtained by editing the connection properties (highlight the connection and select the menu command **Edit > Object Properties**).

Remedies

For many causes, it is enough to edit the connection properties to reestablish consistency, that is, to correct the connection data. The inconsistent connection can be corrected when the new properties are assumed.

If the connection cannot be repaired by opening the connection properties, changing or reversing the configuration, it may be necessary to delete and recreate the connection.

12.10 Displaying the Connection Status

Connection Status

In order to start up a system or to diagnose errors, you can display the status of the communication connections for a module in the connection table.

Possible Status of a Connection:

- Established
- Not established
- Is being established now
- Not available

Note

The "Connection Status" column has a **yellow** background if the connection is only available online, meaning that it is not available offline in the project. The cause can be that this connection was downloaded to the module without first having been saved in the project.

Requirements

- Displaying the connection status is possible only for the local endpoint of a connection, for example, for a CPU that is selected in the network view.
- The module must support the connection status.
(Possible as of 10/99, this performance feature is documented in the instruction list of the CPU. The CPU must support the SSL ID 0x36 "Connection-Specific Diagnostics.")
- There is an online connection to the connection end point.
- If the connections that are involved are connections that were configured with an optional package, you will need the optional package in order to display the status.
- There is a project for the network configuration on the programming device, or you have uploaded the station to the programming device (menu command **PLC > Upload**).

Procedure

1. Select the module for which you want to display the connection status.
2. Select the menu command **PLC > Activate Connection Status**.

The window becomes an **ONLINE** window and the Connection Status column is placed in front of the connection table.

The status information for each connection is displayed in this column.

The text of the executed menu command changes to "Deactivate Connection Status." You use this menu command to return to the (offline) connection table so that you can configure connections.

3. To get more detailed information concerning the current connection status, double-click the appropriate row of the connection table or select the menu command **Edit > Object Properties** (alternatively, click with the right mouse button to get a pop-up menu and select Object Properties or Status Information).

The Status Information tab appears with additional information on the connection status.

Exiting Connection Status

Use the menu command **PLC > Deactivate Connection Status** to exit the function and return to the (offline) connection table.

12.11 Access to Connection IDs during Programming

When programming (for example, in the Statement List Editor), you can perform the following functions while being prompted by dialogs:

- Access already configured connections
- Create new connections
- Change the connection partner

To call up the dialog, proceed as follows:

1. Program the block call (for example, SFB12, BSEND)
2. Position the mouse pointer on a block parameter (for example, "ID")
3. Click the right mouse button to get a pop-up menu. In the pop-up menu, select "Connections."

A dialog with all the connections that apply in this context appears (depending on the associated stations, already configured connections)

12.12 Configuring Connections to Partners in the Same Project

12.12.1 Connection Types for Connection Partners in the Same Project

Selecting the Connection Type for Connection Partners in the Same Project

The connection type is dependent on the subnet and the transfer protocol via which the connection is established, and on the automation family to which the connection partners belong.

The blocks (SFBs, FBs, or FCs) you can use depend on the connection type.

The following table should make it easier for you to select the connection type for the connection you want to establish.

Connection Type	Subnet Type	Connection between SIMATIC...	SFB/FB/FC
S7 connection	MPI, PROFIBUS, Industrial Ethernet	S7 - S7, S7 - PG/PC, S7 - PG/PC with WinCC with MPI also: M7 - M7, M7 - S7, M7 - PG/PC S7 - partner in another project (S7, PG/PC with WinCC)	SFBs USEND, URCV, BSEND, BRCV, GET, PUT, START, STOP, RESUME, STATUS, USTATUS
S7 connection, fault-tolerant	PROFIBUS, Industrial Ethernet	S7(H) - S7(H), S7(H) - PC station (H)	SFBs USEND, URCV, BSEND, BRCV, START, STOP, RESUME, STATUS, USTATUS
PTP Connection	Point-to-point (computer protocol RK 512/3964(R))	S7 - S7, S7 - S5, S7 - non-Siemens device S7 - partner in another project (S7, no Siemens device)	SFBs BSEND, BRCV, GET, PUT, STATUS, PRINT
FMS connection	PROFIBUS (FMS protocol)	S7 - S7, S7 - S5, S7 - PG/PC, S7 - no Siemens device, S7 - broadcast to all nodes S7 - partner in another project (S7, S5, PG/PC, no Siemens device)	FBs READ, WRITE, IDENTIFY, OSTATUS, REPORT
FDL connection	PROFIBUS (FDL protocol)	S7 - S7, S7 - S5, S7 - PC/PG, S7 -non-Siemens device S7 - partner in another project (S7, S5, PG/PC, non-Siemens device)	FCs AG_SEND, AG_RECV, AG_LSEND, AG_LRECV
ISO transport link	Industrial Ethernet (ISO Transport protocol)	S7 - S7, S7 - S5, S7 - PC/PG, S7 - non-Siemens device, S7 - unspecified S7 - partner in another project (S7, S5, PG/PC, non-Siemens device, unspecified)	FCs AG-SEND, AG-RECEIVE AG_LSEND, AG_LRECV, AG_LOCK, AG_UNLOCK;

Connection Type	Subnet Type	Connection between SIMATIC...	SFB/FB/FC
ISO-on-TCP connection	Industrial Ethernet (TCP/IP protocol)	S7 - S7, S7 - S5, S7 - PC/PG, S7 - non-Siemens device, S7 - unspecified S7 - partner in another project (S7, S5, PG/PC, non-Siemens device, unspecified)	FCs AG-SEND, AG-RECEIVE, AG_LSEND, AG_LRECV, AG_LOCK, AG_UNLOCK
TCP connection	Industrial Ethernet (TCP/IP protocol)	S7 - S7, S7 - S5, S7 - PC/PG, S7 - non-Siemens device, S7 - unspecified S7 - partner in another project (S7, S5, PG/PC, non-Siemens device, unspecified)	FCs AG_SEND*, AG_RECV*, AG_LSEND**, AG_LRECV** AG_LOCK AG_UNLOCK
UDP connection	Industrial Ethernet (TCP/IP protocol)	S7 - S7, S7 - S5, S7 - PG/PC, S7 - non-Siemens device, S7 - unspecified S7 - partner in another project (S7, S5, PG/PC, non-Siemens device, unspecified)	FCs AG-SEND, AG-RECEIVE, AG_LSEND, AG_LRECV
E-mail connection	Industrial Ethernet (TCP/IP protocol)	S7 - unspecified (S7 - mail server)	FCs AG-SEND, AG_LSEND

* The FCs AG_SEND and AG_RECV here can only be used for S7-300 (this depends on release number of the CP, see the documentation for the CP).

** The FCs AG_LSEND and AG_LRECV here can generally be used for S7-400, and in addition for S7-300 (this depends on release number of the CP, see the documentation for the CP).

Special Feature: Connection to Broadcast and Multicast Nodes

For special connection types there is the option of selecting not just one connection partner, but several ones (broadcast and multicast nodes). These options are described in the SIMATIC NET (NCM S7) manuals. The connection partners "all broadcast nodes" or "all multicast nodes" are listed in the dialog box for entering a new connection.

- You can set up a connection to "all broadcast nodes" (simultaneous sending to all broadcast receivers) for the connection types FDL connection and UDP connection.
- You can set up a connection to "all multicast nodes" (simultaneous sending to several nodes) for the connection types FDL connection and UDP connection.

12.12.2 Rules for Creating Connections

Selecting a Connection Path with More Than One Subnet in the Project

If stations are connected to a number of subnets, STEP 7 chooses a connection path via one of the subnets. This connection path was found by STEP 7 to be more efficient than the others. STEP 7 selects a preferred subnet in the following order: Industrial Ethernet before Industrial Ethernet/TCP/IP before MPI before PROFIBUS.

Example: Two stations are networked together via MPI and Industrial Ethernet. STEP 7 chooses the route via Industrial Ethernet.

Note that the route selected by STEP 7 remains even if the connection to the subnet is lost. STEP 7 does not select an alternative route via another subnet (exception: redundant S7 connections).

In an S7 connection, the connection path set automatically by STEP 7 can be changed by the user in the properties dialog box for the connection, for example, from MPI to PROFIBUS.

Number of Possible Connections

The number of possible connections which can be entered in the connection table depends on the resources of the selected module and is monitored by STEP 7.

Information on the connection resources of a module is available in the "Module state" dialog box, "Communication" tab card.

12.12.3 Configuring Connections for Modules in a SIMATIC Station

The following section shows you how to create connections for a connection end point (for example, a CPU) in the network view.

Special Feature

STEP 7 automatically assigns a local ID for each end point of the connection under either of the following conditions:

- If both communication partners are S7-400 stations
- If one communication partner is an S7-400 and the other is a SIMATIC station

In this case, you configure only the connection in the connection table of a partner that has other communication partners, then automatically the matching entry in its connection table.

12.12.3.1 Inserting a New Connection

A connection defines the communication relationship between two nodes. It defines the following:

- The two communication nodes involved
- The connection type (for example, S7, point-to-point, FMS, ISO-on-TCP, FDL, or ISO Transport)
- Special properties which depend on the type of connection (such as whether a connection remains permanently configured, or whether it is set up/broken dynamically in the user program)

Requirement

You must be in the network view of NetPro.

Procedure

1. In the network view, select the module for which you want to create a connection.
Result: The connection table for the selected module is displayed in the lower half of the network view.
2. Double-click an empty row in the connection table, or select a row and select the menu command **Insert > Connection**.
3. In the "New Connection" dialog box select the required connection partner. You can obtain help with selecting a connection partner in the online help for this dialog box.
4. Specify the type of connection.
5. Activate the "Show Properties dialog box" check box if you want to view or change the properties for the connection after clicking "OK" or "Add:"
The contents of the "Properties" dialog box is dependent on the connection selected; you can obtain help with filling it out in the online help for the dialog box.
Result: STEP 7 enters the connection in the connection table of the local (selected) node and assigns the local ID and a partner ID if required for this connection which you will need when programming the communication function blocks (value for the block parameter "ID").

12.12.3.2 Changing the Connection Partner

You can change the connection partner for a previously configured connection. The local ID and the connection type are retained.

Requirement

You must be in the network view of NetPro.

Procedure

1. In the network view, select the module for which you want to modify a connection.
2. Select the row in the connection table containing the connection you want to modify.
3. Double-click the selected area of the "Partner" column or select the menu command **Edit > Connection Partner**.
Result: The "Modify Connection" dialog box appears.
4. In the "Connection Partner" box, select the end point (i.e. a module in the current project or in another project in the multiproject). If the new connection partner that you have selected is a partner "in an unknown project", you will then be prompted to enter a connection name (reference) for this connection.
5. Confirm your entries by clicking "OK."

Notes:

Note that the configured properties of the connection will be returned to the default setting when the connection partner is modified. Use the menu command **Edit > Object Properties** if you wish to change the properties of the connection.

The following applies to S7 connections: You can change an "unspecified" connection partner from STEP 7 V5 onwards (for example, to a SIMATIC 300/400 station). You can also change the SIMATIC station partner to "unspecified."

12.12.3.3 Reserving a Connection

If you wish to reserve the communication resources of a node to expand your project at a later date, or if you do not wish to specify a connection partner yet, you can enter "Unspecified" for the connection partner. Reserving connections is currently not possible for all connection types.

Requirement

You must be in the network view of NetPro. The properties dialog box for the connection is open.

Procedure

1. In the "Station" box, select the option "Unspecified."
Result: The entry in the "Module" box is deactivated.
2. Select the connection type in the "Type" box.
3. Activate the "Show Properties dialog box" check box if you want to view or change the properties for the connection after clicking "OK" or "Add."
4. Confirm your entries by clicking "OK."
Result: STEP 7 enters the connection in the connection table of the local node and assigns the local ID for this connection which you will require for programming the communication blocks.

Note

Note that you can also assign special properties for each connection. To do this, select the menu command **Edit > Object Properties**.

12.12.3.4 Deleting One or More Connections

Requirement:

You must be in the network view of NetPro.

Procedure

1. Select the connections you wish to delete.
2. Select the menu command **Edit > Delete**.
If local ID and partner ID for the connection were entered in the connection table, STEP 7 also deletes the connection in the table for the connection partner.
3. Download the connection tables with the deleted connections to the relevant programmable module. (To delete all the connections of a programmable module, you must download an empty connection table to the module.)

12.12.3.5 Copying Connections

Introduction

Connections are not copied individually but always in context with the project or the station.

You can copy the following:

- Entire projects
- One or more stations within a project or beyond the boundaries of a project

Requirement

The SIMATIC Manager must be open.

Copying a Project

When you copy a project, all configured connections are also copied. There are no settings required for the copied connections because the connections remain consistent.

Copying a Station

When you copy one or more stations within the project boundaries or beyond them, you may have to reassign the connection partners to the local node (modifying a connection).

If no connection partner exists for a connection, you will see this in the connection table, since the row of the connection partner will be displayed in bold.

Connections between stations that are copied beyond the project boundaries remain in tact and consistent if the relevant subnets between these stations are copied along with them.

12.12.4 Configuring Connections for a SIMATIC PC Station

You can configure connections for SIMATIC PC stations. Depending on which interfaces are available on your PC (communication processors, CPs), you can configure the corresponding connection types.

If you want to create or modify connection types other than S7 connections (such as fault-tolerant S7 connections), you must make sure you have installed the corresponding optional package.

Requirements

You have configured a SIMATIC PC station with all the communication end points (applications, OPC servers, software PLCs or slot CPUs) and PC communication cards. You have also configured all the stations that are supposed to be the communication end points of the connections.

To configure connections, you must note the following, depending on the components that you are using:

- WinLC (V3.0): This version does not support any configured connections.
- Slot PLCs (CPU 41x-2 PCI): You can configure connections for these CPUs only by means of exactly one of the configured CPs.
- Applications and OPC servers: Please see the documentation for the applications or programming interfaces that you are using.

How to Configure a Connection

1. Select the communication end point in the SIMATIC PC station in the network view, so that the connection table is visible.
2. Double-click an empty row in the connection table or highlight a row and select the menu command **Insert > Connection**.
3. Select the required connection partner in the "New Connection" dialog box. You can find help on selecting the connection partner in the online help for this dialog box.
4. Define the type of connection.
Special property of the connection: In contrast to S7 stations, STEP 7 assigns a name instead of a numerical value for the local ID (connection ID). You can change this name in the object properties of the connection.
New connections are always two-way connections; that is, STEP 7 automatically enters a connection to the local station in the connection table of the partner.
5. Select the menu command **Network > Save and Compile**.
On compilation, a configuration file ("XDB file") is generated for the PC station. This contains the name of the PC station, the connection descriptions, and the assigned parameters and subnet information for the PC communication cards. You enter the path for the configuration file in the "Configuration" tab (object properties of the SIMATIC PC Station).
6. If the PC stations are configured with the Station Configuration Editor, you can load the PC station (see Downloading a PC Station).
Otherwise, continue with step 7.

7. Copy the configuration file to the PC station (programmable logic controller).
The location of the configuration file is to be set on the PC station by means of the "Set PG/PC Interface" program ("STEP 7 Configuration" tab).
You can find additional information concerning installation on a programming device/PC in the description "SIMATIC NET, S7 Programming Interface" and in the online Help for the "STEP 7 Configuration" tab.

12.12.4.1 Configuring Routed S7 Connections for a SIMATIC PC Station

For OPC servers (part of the CD SIMATIC NET PC software products as of Version 6.1) you can configure S7 connections between a SIMATIC PC station/SIMATIC HMI station and an S7 station that is connected to a different subnet.

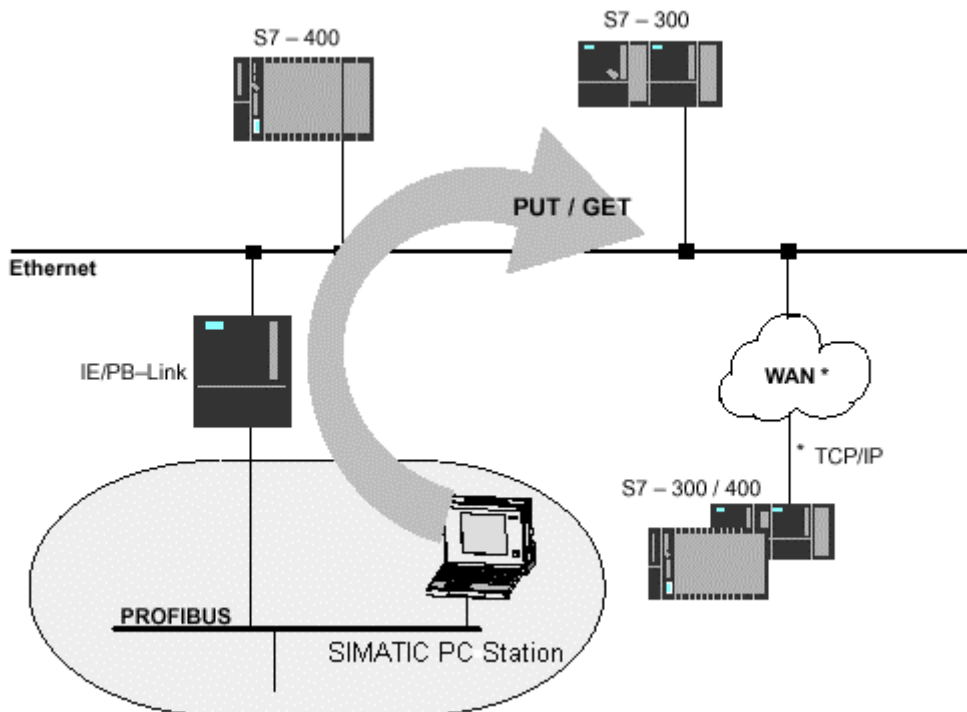

Requirements

Both of the subnets must be interconnected across a router, for example IE/PB Link. Routing functions can also be performed by an S7 station or a SIMATIC PC station that is interconnected to both subnets via CPs or CPU.

The end point in the SIMATIC PC/HMI station (currently only an OPC server) must support routed subnets.

The connection partner must be located in the same project.

What to do if only one-way S7 connections can be configured

The S7 station can only be operated as communication server for configured one-way S7 connections on interconnected subnets.

In this case, use NetPro to configure a one-way S7 connection for a SIMATIC PC station/HMI station at the other subnet. This enables you to access data of the S7 station in the user program of the SIMATIC PC station, via the functions PUT (write access) and GET (read access).

12.12.5 Programming Devices / PCs as Connection Partners

If you want to configure connections for an end point on a programming device or PC, you have various options. Select either the "PG/PC" object or the "SIMATIC PC Station" object in the network view:

- "SIMATIC PC Station" for applications that use configuration files (*.xdb files) for communication to a SIMATIC S7 station, for example:
 - For redundant connections with the optional package S7-REDCONNECT (fail-safe S7 communication) or
 - For SAPI-S7 interface
 - For OPC server

Please check in the product information of the SIMATIC NET product to see if configuration by means of a configuration file is possible.

- "PG/PC" for applications that use LDB files for communication to a SIMATIC S7 station (SAPI-S7 interface)

12.12.5.1 S7 Connection to a PG/PC

An S7 connection from an S7 station to a PG/PC is only possible if the PG/PC has an SAPI-S7 programming interface (C programming interface for access to SIMATIC S7 components) or an OPC Server.

You will find more information on filling out the dialog box in the online help for this dialog.

For the Connection Partner "PG/PC"

One method of configuring connections is by creating an LDB (local database):

1. Configure the PG/PC in the network view.
2. Configure the station from which a connection should go to the PG/PC.
3. When you create the S7 connection you must select "PG/PC" as the connection partner.
4. Edit the "Address Details" dialog box (accessible via the properties of the connection). In this dialog box you enter the name of the connection and the virtual field device name of the programming device/PC. You will find more information in the online help for this dialog box.
5. Then double-click the configured programming device/PC and generate the local database (LDB).
6. Transfer the database to the programming device/PC.
7. Download the connection(s) to the station.

For the Connection Partner "SIMATIC PC Station"

For the programming device/PC you create a SIMATIC PC station in the network view. The "Application" forms the end point of a connection with this station type.

12.12.5.2 S7 Connection to a PG/PC with WinCC

For the Connection Partner "Unspecified"

You can create S7 connections to PGs/PCs with *WinCC* within a project or beyond project boundaries. When you create the S7 connection you must select "Unspecified" as the connection. You enter special address information for *WinCC* in the "Address Details" dialog box.

For the Connection Partner "SIMATIC PC Station"

For the programming device/PC you create a SIMATIC PC station in the network view. WinCC forms the end point of a connection with this station type.

12.13 Configuring Connections to Partners in Other Projects

12.13.1 Connection Types for Partners in Other Projects

Selecting the Connection Type to Communication Partners in Other Projects

When you have set up a multiproject, you can then configure interproject connections.

The connection type is dependent on the subnet and the transfer protocol through which the connection is established and on the automation family to which the connection partners belong.

The blocks (SFBs, FBs, or FCs) you can use depend on the connection type.

The following table should make it easier for you to select the connection type for the connection you want to establish.

Connection Type	Subnet Type	Connection Between SIMATIC ...	SFB/FB/FC
S7 connection	MPI, PROFIBUS, Industrial Ethernet	S7 - S7, S7 - PG/PC, S7 - PG/PC with WinCC with MPI also: M7 - M7, M7 - S7, M7 - PG/PC	SFBs USEND, URCV, BSEND, BRCV, GET, PUT, START, STOP, RESUME, STATUS, USTATUS
S7 connection, fault-tolerant	PROFIBUS, Industrial Ethernet	S7(H) - S7(H), S7(H)- PC-Station (H)	SFBs USEND, URCV, BSEND, BRCV, START, STOP, RESUME, STATUS, USTATUS
FDL connection	PROFIBUS	S7 - S7, S7 - S5, S7 - PC/PG, S7 – non-Siemens device, S7 - broadcast to all nodes	FBs READ, WRITE, IDENTIFY, OSTATUS, REPORT
ISO Transport connection	Industrial Ethernet (ISO-transport protocol)	S7 - S7, S7 - S5, S7 - PC/PG, S7 – non-Siemens device, S7 – unspecified	FCs AG_SEND, AG_RECV, AG_LSEND, AG_LRECV
ISO-on-TCP connection	Industrial Ethernet (TCP/IP protocol)	S7 - S7, S7 - S5, S7 - PC/PG, S7 – non-Siemens device S7 – unspecified S7 - partner in another project (S7, S5, PG/PC, non-Siemens device, unspecified)	FCs AG_SEND, AG_RECV, AG_LSEND, AG_LRECV AG_LOCK AG_UNLOCK

Connection Type	Subnet Type	Connection Between SIMATIC ...	SFB/FB/FC
TCP connection	Industrial Ethernet (TCP/IP protocol)	S7 - S7, S7 - S5, S7 - PC/PG, S7 - non-Siemens device, S7 - unspecified	FCs AG_SEND*, AG_RECV*, AG_LSEND**, AG_LRECV** AG_LOCK AG_UNLOCK
UDP connection	Industrial Ethernet (TCP/IP protocol)	S7 - S7, S7 - S5, S7 - PC/PG, S7 – non-Siemens device, S7 – unspecified	FCs AG_SEND, AG_RECV, AG_LSEND, AG_LRECV

- * The FCs AG_SEND and AG_RECV here can only be used for S7-300 (this depends on release number of the CP, see the documentation for the CP).
- ** The FCs AG_LSEND and AG_LRECV here can generally be used for S7-400, and in addition for S7-300 (this depends on release number of the CP, see the documentation for the CP).

Special Feature: Connection to Broadcast and Multicast Nodes

For special connection types there is the option of selecting not just one connection partner, but several ones (broadcast and multicast nodes). These options are described in the SIMATIC NET (NCM S7) manuals. The connection partners "all broadcast nodes" or "all multicast nodes" are listed in the dialog box for entering a new connection.

- You can set up a connection to "all broadcast nodes" (simultaneous sending to all broadcast receivers) for the connection types FDL connection and UDP connection.
- You can set up a connection to "all multicast nodes" (simultaneous sending to several nodes) for the connection types FDL connection and UDP connection.

12.13.2 Basic Procedure for Configuring Connections between Projects

Configuring Connections with Multiproject

AS of STEP 7 V5.2 you can easily create interproject connections with the help of the multiproject (see also the section: What you Should Know About Multiprojects).

Possible Connection Partners in the Other Project (without Multiproject)

There are two methods of setting up connections to connection partners in other STEP 7 projects (without multiproject):

- Set up a connection to an "other station," a "PG/PC," or a "SIMATIC S5 station"
- Set up a connection to an "unspecified" connection partner

Note:

Connections to "other stations," "SIMATIC S5 stations," "PG/PC," and "unspecified" connection partners are also possible within a STEP 7 project. To which of these connection partners connections can be set up depends, among other things, on the connection type.

Differences Between the Two Methods

- You must configure an "other station", a "PG/PC", or a "SIMATIC S5 station" as subnet nodes in the current STEP 7 project. **Restriction:** For "other stations" and SIMATIC S5 stations you cannot configure S7 connections. All other connection types are possible.
- No subnet node needs to be configured in the current STEP 7 project for an unspecified partner. You can set up S7 connections, PTP connections, ISO Transport connections, and ISO-on-TCP connections to unspecified connection partners.

Special Case for PtP Connections

In contrast to the case for STEP 7 connections, the configuration of PtP connections to an unspecified partner does not require networking of the local node. You only have to network the communication partners in an actual plant before you place the connection in operation.

12.13.3 Creating a New Connection to an Unspecified Partner

FMS, FDL, ISO-Transport, and ISO-on-TCP Connections

FMS, FDL, ISO-Transport, and ISO-on-TCP connections are described in the SIMATIC NET, and SIMATIC NCM manuals.

S7 Connections

You can use unspecified connection partners in order to configure S7 connections to a connection partner in a different project.

Requirement

You must be in the connection table view (NetPro).

Procedure

You create an S7 or point-to-point connection to an "unspecified" connection partner as follows:

1. Select a module from which you want to run the connection (local node).
2. Double-click an empty row in the connection table, or select a row and select the menu command **Insert > Connection**.
3. In the "New Connection" dialog box select "Unspecified" as the connection partner.
4. Set the properties for the connection:
For PtP connections: in the properties dialog box for the PtP connection change the name of the partner from "unspecified" to a suitable name (the name is also entered in the connection table).
For S7 connections: enter the address of the interface of the connection partner and click the Address Details button in the properties dialog box. Depending on the connection partner, different settings are necessary in the "Address Details" dialog box. You will find more information on filling out the dialog box in the online help.

"Address Details" Dialog Box for S7 Connections to a Partner in a different Project

In the dialog boxes for the connection properties (Properties S7 Connection dialog box and Address Details dialog box) of an unspecified partner, you have to enter or select the address (of the interface), the end point of the connection (rack/slot), and the connection resources of each "Other Side" (that is, of the connection partner).

Example: The following configuration is a prerequisite:

The stations are in different projects. The CPU as connection end point is in the central controller (rack 0) slot 4 in both projects. Both stations are networked by means of the PROFIBUS interface of a CP.

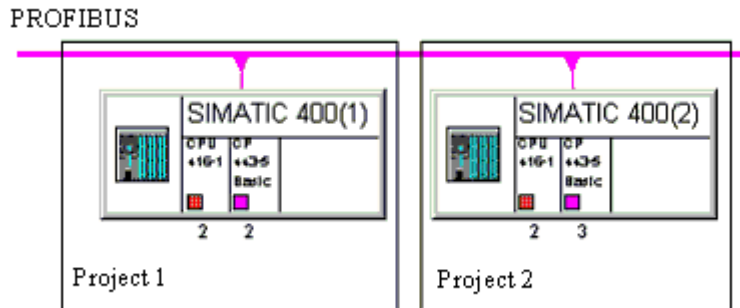

The following table shows which supplementary information is required for the configuration shown in order to enable a connection setup in operation.

Information in Dialog Boxes on the Unspecified Connection Partner...	... for Project 1	...for Project 2	Comments
Active connection setup	Yes	No	Dialog box: Properties S7 Connection
Address (interface) Local/Partner	Local: 2 Partner: 3	Local: 3 Partner: 2	Dialog box: Properties S7 Connection, under Connection Path; the addresses have to match "crosswise".
Rack/slot	Local: 0/4 Partner: 0/4	Local: 0/4 Partner: 0/4	Dialog box: Address Details"
Connection resource (hex) (Local/Partner)	Local: 10 Partner: 11	Local: 11 Partner: 10	Dialog box: Address Details; connection resources cannot be assigned twice and must match "crosswise".
TSAP (Transport Service Access Point)	Is displayed (cannot be changed)	Is displayed (cannot be changed)	Dialog box: Address Details; for station-internal addressing of the interface, by means of the connection "Running" (is made up of the address details)

12.13.4 Creating a Connection to an 'Other Station', a 'PG/PC', or a 'SIMATIC S5 Station'

Requirement

You must have created the entire network configuration in both projects.

Stations that were configured in one project must be entered in the other project as an "other station."

The network view (NetPro) must be open.

Procedure

The procedure is the same as for creating connections to a partner (PG/PC, "other station," and SIMATIC S5) within one project.

12.14 Saving Connections

NetPro saves connections (menu command **Network > Save**) implicitly with all network and station data that are relevant for a functioning network configuration. For further information please refer to the section "Saving and Downloading the Network Configuration and Consistency Check".

13 Configuring Global Data Communication

13.1 Overview: Global Data Communication

Introduction

Global data communication (GD communication) is a simple method of communication integrated in the operating system of the S7-300 and S7-400 CPUs.

GD communication allows the cyclic exchange of data between CPUs via the multipoint interface. Cyclic data exchange takes place with the normal process image.

Global data communication is configured with STEP 7; transferring global data is done by the system and is not therefore programmed.

The following sections show how you can estimate using the technical specifications as given for every CPU (number of GD circles, size and number of GD packets etc.) what quantities of data can be exchanged between CPUs using the "GD communication" process.

The following are also listed:

- Send and receive conditions to be observed
- The formula for estimating the approximate response time

What Are Global Data?

Global data as they are used in the GD communication process are the following address areas in the CPU:

- Inputs, outputs (from the process image)
- Bit memory
- Data block areas
- Timers, counters (not recommended because the values are no longer current at the receiver; can only be configured as send address areas)

Peripheral areas (PI and PQ) and local data cannot be used for global data communication.

Data Transfer Process

Global data communication functions according to the broadcast method, meaning the receipt of the global data is not acknowledged. The sender does not receive information as to whether a receiver and which receiver has received the sent global data. If the process requires secure data exchange, use another service such as S7 functions.

Subnets for Global Data Communication

GD communication is possible:

- Via an MPI subnet only (between different stations) or
- Via the backplane bus only (for example, between S7 CPUs in a rack in multicomputing)

How Does an Address Area Become a Send/Receive Area?

The address areas that are involved in global data communication are configured in a global data table (GD table) using STEP 7:

- Every column is assigned to exactly one CPU which means the columns represent the CPUs involved in the data exchange (**maximum 15 CPUs**)
- Every row (or more exactly: every cell that can be edited in a row) represents the address areas via which one CPU only sends and one or more CPUs receive

When you have filled out the table, compiled it, and downloaded it to the CPUs involved, these CPUs send and receive cyclically via these address areas at the scan cycle checkpoint (meaning at the time at which the process image update takes place).

Special Feature: With the S7-400, configured global data can also be sent using SFC60 (GD_SND) for event-driven sending and received using SFC61 (GD_RCV).

13.2 Determining the Communication Capabilities from the GD Resources

You can determine how high the performance of an S7 CPU is with regard to GD communication using the following technical specifications ("GD resources"):

- The number of GD circles (in which the CPU can participate)
- The maximum number of net data per GD packet
- The maximum number of receive GD packets per GD circle
- The length of the consistent data per packet

The remaining documented GD resources are identical for all S7 CPUs and are not therefore relevant for selecting a CPU.

The technical data listed above provide indirect information about how much data the CPUs that are connected together via an MPI subnet or S7-400 backplane bus can exchange cyclically. How send data are "bundled up" to form GD packets and how many GD circles are used is illustrated in the following sections.

Tip

If you only want to transfer small amounts of data (only a few bytes) between a few CPUs, simply enter the address areas in the GD table and compile the table.

STEP 7 packs the data and allocates the resources automatically. You can see the total resources (GD circles and GD packets) used up after compilation in the first column ("GD Identifier") of the GD table.

The following sections outline the principle according to which GD packets and GD circles are used up.

13.2.1 Required Number of GD Packets

A GD packet is a data frame that is sent from one CPU only to one or more other CPUs "in one shot."

A GD packet contains the following maximum number of net data (see also the technical specifications of the CPUs):

- A maximum of 22 bytes in S7-300
- A maximum of 54 bytes in S7-400

Example 1:

You want to use the maximum send area for an S7-300 CPU to send from a data block. The bit memory area is to be used for the receiver CPU.

You enter the following in the GD table as the send area for an S7-300 CPU:

- DB8.DBB0:22 (that is an area of 22 data bytes in DB8 from data byte 0)

You enter the following in the GD table as the receive area for another CPU (must always be exactly the same size as the send area):

- MW100:11 (that is 11 memory words from MW100)

Rules

- If you want to send from more than one address area, you must take off two bytes from the maximum number of net data for each additional address area used.
- A bit address (for example, M 4.1) uses one byte of net data in the GD packet.

Example 2:

You want to send from a data block and from the process image of the outputs. The GD packet can then only be 20 bytes in size.

You enter the following in the GD table as the send areas for an S7-300 CPU:

- DB8.DBB0:10 (that is an area of 10 data bytes in DB8 from data byte 0)
- QW0:10 (that is an area of 10 output words from QW0)

You enter the receive areas for the other CPUs similarly to the first example; the width of the receive area must be identical to the send area.

13.2.2 Required Number of GD Circles

What is a GD Circle?

All CPUs participating as sender or receiver in exchanging a common data packet form a GD circle.

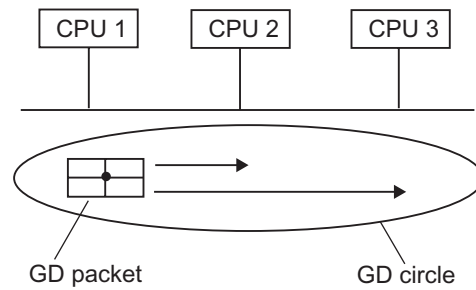

Example for Converting to a GD Table (After Compiling)

GD Identifier	CPU 1	CPU 2	CPU 3
GD 1.1.1	> MW0	IW0	IW0

Legend for GD table:

">" indicates the sender

Structure of the GD Identifier:

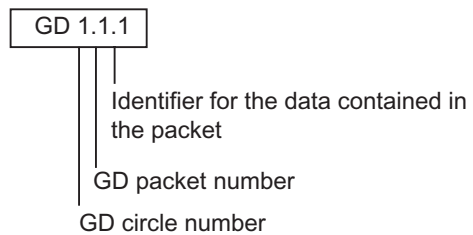

When is Another GD Circle Required? (Case 1)

If more data are to be sent and received than can fit in one GD packet, an additional GD circle is required.

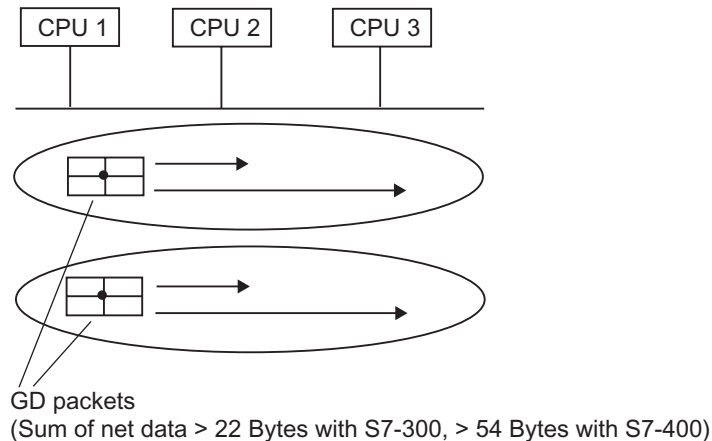

Example for Converting to a GD Table (After Compiling)

GD Identifier	CPU 300 (1)	CPU 300 (2)	CPU 300 (3)
GD 1.1.1	>MW0:10	IW0:10	IW0:10
GD 2.1.1	> MW100:4	IW30:4	IW20:4

When is Another GD Circle Required? (Case 2)

An additional GD circle is also required if the send and receive CPUs are not the same (then a new GD packet must be created).

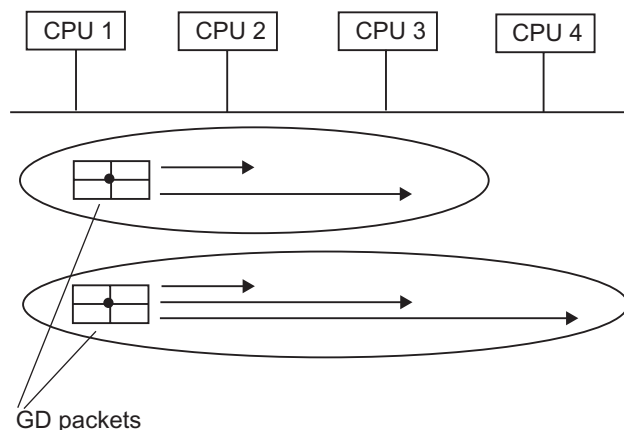

Example for Converting to a GD Table (After Compiling)

GD Identifier	CPU 300 (1)	CPU 300 (2)	CPU 300 (3)	CPU 300 (4)
GD 1.1.1	> MW0	IW0	IW0	
GD 2.1.1	> MW100:4	IW30:4	IW20:4	IW30:4

Tip

It may be advisable to determine a CPU as the receiver for a GD packet although the packet is not required for these CPUs (as CPU 4 in the example above). If the sender and the receiver CPUs are the same, the number of GD circles can be reduced in this way, for example, for the sender CPU. In the example above, CPUs 1,2, and 3 would then only form one GD circle because both GD packets would be grouped together to form one GD packet.

Maximum Number of GD Circles

The number of GD circles is limited to 16. CPUs that have a GD circle number greater than 16 cannot be loaded with the global data configuration. However, STEP 7 does not prevent saving and compiling GD tables with a greater number of GD circles.

13.2.3 Exceptions for Calculating the GD Circles Required

Under certain conditions, the number of GD circles required can be reduced:

For S7-300:

If an S7-300 CPU ("sender CPU") sends one GD packet only to one other S7-300 CPU ("receiver CPU") only and this receiver CPU sends only one GD packet back to the sender CPU, only **one** GD circle is used.

This property reflects the technical data "max. number of receive GD packets per GD circle = 1."

In the example below you will see from the GD identifier (GD packet number) that only one GD circle is required.

Example (GD Table After Compiling)

GD Identifier	CPU 300 (1)	CPU 300 (2)
GD 1.1.1	> MW100	IW2
GD 1.2.1	IW4:3	>MW10:3

For S7-400:

If a maximum of three CPUs exchange GD packets and each of the three CPUs only sends one GD packet to the other two, only **one** GD circle is required here too.

This property reflects the technical data "max. number of receive GD packets per GD circle = 2."

In the example below you will see from the GD identifier (GD packet number) that only one GD circle is required.

Example (GD Table After Compiling)

GD Identifier	CPU 400 (1)	CPU 400 (2)	CPU 400 (3)
GD 1.1.1	> MW0	IW0	IW0
GD 1.2.1	IW2	IW2	> MW0
GD 1.3.1	IW0	> MW0	IW2

13.3 Conditions for Sending and Receiving

With the aid of a scan rate you can set the following for every CPU participating in the exchange of a GD packet:

- After how many cycles the GD packet is sent (only for the CPU designated as sender)
- After how many cycles the GD packet is received

Special Case: scan rate "0" means that the sending of the GD packet is event-driven (not cyclic) (only possible in S7-400 with SFC60/SFC61).

Example:

A scan rate of 20 entered for a GD packet at the sender CPU means that the CPU sends the GD packet at the scan cycle checkpoint after every 20 cycles.

A scan rate of 8 entered for a GD packet at the receiver CPU means that the CPU receives the GD packet at the scan cycle checkpoint after every 8 cycles (or more exactly, enters the received GD packet into the address area).

Sender Scan Rate

The following conditions should be maintained, however, to keep the communication load on the CPU at a low level:

S7-300 CPUs: scan rate × scan cycle time ≥ 60 milliseconds

S7-400 CPUs: scan rate × scan cycle time ≥ 10 milliseconds

Receiver Scan Rate

To prevent the loss of GD packets, they must be received more often than they are sent.

To guarantee this, the following must apply:

Scan rate (receiver) × scan cycle time (receiver) × scan rate (sender) × scan cycle time (sender).

13.3.1 Relationship between the Scan Rate and Scan Cycle Time

Valid Scan Rates

Valid scan rates for senders as well as for receivers are 0 and values between 1 and 255. Note that scan rates which are too small overload the CPU.

Recommendation: Maintain the default scan rate or make sure that the product of scan cycle time x scan rate is greater than 0.5 s. For higher communication requirements, you should use different communication mechanisms, such as connection by means of PROFIBUS-DP.

The scan rate 0 identifies event-driven data transmission using system functions (SFCs) in a user program (not possible with all CPUs).

If you do not enter any scan rates, the default settings are used.

Example for Scan Rates

The product of scan cycle time x scan rate determines the time interval of global data exchange.

Assumption: The user program in a CPU 412 has a scan cycle time of approximately 50 ms. The default scan rate is 22.

$$50 \text{ ms} \times 22 = 1100 \text{ ms}$$

Global data are thus sent or received by this CPU every 1.1 s.

If the scan cycle time is increased by the user program to 80 ms, for example, global data will be sent or received every $80 \text{ ms} \times 22 = 1760 \text{ ms}$.

If the value 1100 ms is reached again, you must recalculate the scan rate.

$$\text{Scan rate (new)} = 1100 \text{ ms} / 80 \text{ ms} = 13.75$$

That is, because of the extension of the scan cycle, you have to set the scan rate to 14 in order to maintain the time interval.

13.4 Response Time

The response time for two stations that exchange GD packets via an MPI subnet can be calculated approximately.

Requirement for Calculating the Response Time

- Transmission rate 187.5 kbit/s
- No other communication by means of MPI (for example, by connected programming devices or operator panels)

Calculation

$\text{response time} \approx \text{scan rate (sender)} \times \text{scan cycle time (sender)} + \text{scan rate (receiver)} \times \text{scan cycle time (receiver)} + \text{number (of MPI nodes)} \times 10 \text{ ms}$

For higher transmission rates, the factor " $\times 10 \text{ ms}$ " is smaller; however, this factor does not diminish linearly with an increase in transmission speed.

Tip

Because the response time is very dependent on the scan cycle times and on the other communication load over the MPI, you must determine the response time in your system empirically and, where appropriate, adapt the scan rate.

13.5 How to Configure and Save Global Data Communication

13.5.1 Procedure for Configuring Global Data Communication

Requirement

You must have configured an MPI subnet with all the required stations.

Overview Procedure

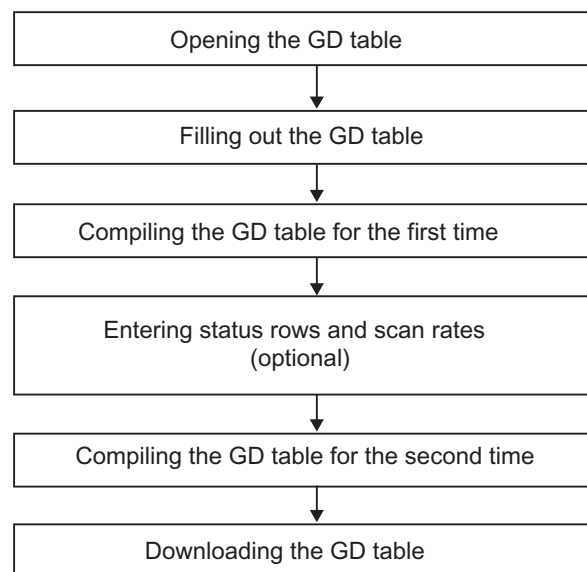

13.5.2 Opening the GD Table

There are two ways of opening a global data table:

- Open the entire GD table for a subnet
- Open the GD table for a CPU

Opening the GD Table for a Subnet (Recommended)

- In the SIMATIC Manager select an MPI subnet and select the menu command **Options > Define Global Data**.
Result: The GD table for the selected subnet is opened.

Opening the GD Table for a CPU

The following option for opening a global data table is recommended if you want to retrieve the GD table from the CPU during servicing and when searching for faults.

1. Select the menu command **GD Table > Open > Global Data for CPU**. The dialog box "Open" appears, in which you can select the project and station for the required CPU.
2. Select one of the following options:
 - "Online" to read the data directly from the CPU, or
 - "Offline" to obtain the system data for the CPU from the offline project
3. Select the project and double-click the station in which the required CPU is located to open it.
4. Select the "Blocks" object of the CPU whose GD table you wish to display.
5. Confirm your selection by clicking "OK."
Result: A global data table appears in which all CPUs participating in global data communication are entered in the column headers. However, the table only contains the values for the selected CPU.

To complete the empty cells of the GD table, you must update the table.

- Select the menu command **View > Update**. The GD table is now displayed with all entries.

13.5.3 Tips for Working with GD Tables

Inserting Global Data Rows

- Select the menu command **Insert > GD Row**

Deleting Global Data Rows

- Select a row and select the menu command **Edit > Delete.**

Inserting and Deleting CPU Columns

- Select the menu command **Insert > CPU Column.**

Deleting CPU Columns

- Select a column and select the menu command **Edit > Delete.**

Note on Deleting CPU Columns

If you delete a CPU column from a global data table, the corresponding system data of the CPU (offline) are deleted. Bear in mind that you must also delete the online data in the CPU for the deleted CPU column.

Requirement: The programming device must be connected to the CPU via the multipoint interface and the CPU must be in STOP mode.

Select the menu command **GD Table > Delete Global Data for CPU** and in the dialog box that follows, select the option "Online." Select the "Blocks" folder and confirm by clicking "OK."

Modifying the Column Width

The width of each CPU column can be modified. You can also make a column so narrow that it cannot be seen.

- Position the cursor on the right-hand side of the CPU cell in the table header, press and hold down the left mouse button, and drag the border horizontally to resize the column.

13.5.4 Filling Out the GD Table

Requirement

The scan rates and the GD status must be toggled off in the GD table.

Entering CPUs in the Table Header

1. In the global data table, click on a column in the table header. The column is then selected.
2. Select the menu command **Edit > Assign CPU**. The dialog box "Open" will then appear. Alternatively, you can open this box by double-clicking the column header.
3. Select the current project and double-click to open the station for the required CPU.
4. Select the CPU and confirm your selection by clicking "OK."
Result: The name of the selected CPU is displayed in the table header.

Entering Data in GD Rows

Requirement: You must have entered the relevant CPU in the table header (see above).

1. Position the cursor in a table cell and enter the required address. You can only enter absolute addresses (for example, IW0); symbolic entries are not possible.
Tip: A set of continuous addresses of the same data type requires only one entry in the global data table. In this case, enter a colon after the address and then the repetition factor. The repetition factor defines the size of the data area.

Example: IW4: 3 means: 3 words from IW4.
2. Switch from overwrite to insert mode by pressing the F2 key.
3. Edit the table as you would normally. You can also use the menu commands **Edit > Cut**, **Edit > Copy**, or **Edit > Paste**.
4. Finish your entries with RETURN.

Note

In a GD circle, use only either the communication bus (within an S7-400 station) or the MPI subnet (outside the stations). Mixed operation is not possible.

Defining Sender and Receiver Cells

Each global data row contains only one sender and one or more receivers. ">" indicates a sender. All cells in the global data table are preset as receivers.

- To define a data cell as a sender, highlight the cell and select the menu command **Edit > Sender**.
- To define a data cell as a receiver, highlight the cell and select the menu command **Edit > Receiver**.

Note

Cells that contain timers and counters can be used only as senders.

13.5.5 Saving and Compiling the GD Table for the First Time

Saving

When saving, you store the data which you have entered in your global data table in a source file.

- Select the menu command **GD Table > Save**
or
 1. Select the menu command **GD Table > Save As**
 2. Navigate to the project in which you want to save the global data table.
 3. Confirm with "OK."

Note

In order for the changes you made in the global data table to be saved in the system data as well, you must compile the global data table.

The data will automatically be saved in the system data of the relevant CPUs directly after compiling.

The data consistency between the source file and the system data can only be guaranteed if each change to the GD table is saved both in the source file (save) and in the system data (compile).

Compiling

A compiler run is necessary in order to compile the data you enter in the global data table into a language that the CPUs can understand.

The tabular data in the global data table are compiled into system data that the CPUs can process.

For each CPU column, the compiler creates the exact system data necessary for communicating with that particular CPU. For this reason, each CPU has its own GD configuration.

- Click the appropriate button in the toolbar or select the menu command **GD Table > Compile**. The global data table will be compiled to phase 1.
Result: STEP 7 checks:
 - The validity of the CPU specified in the CPU column headers
 - The syntax of the addresses you entered in the table cells.
 - The size of the data areas for the sender and receiver (the data areas for the sender and receiver must be of equal size)
 - That the global data in a row are exchanged either via the communication bus only or via the MPI subnet only. Mixed operation is not possible.

After the first compilation has been completed successfully, the GD table is in phase 1. In phase 1 you can edit the status rows and scan rates in the GD table.

13.5.6 Entering Scan Rates

Introduction

Global data exchange occurs as follows:

- The sender CPU sends the global data at the end of a cycle.
- The receiver CPU reads the data at the start of a cycle.

With the aid of the scan rate, you can determine after how many cycles the data will be sent or received.

Procedure

1. Compile the global data table if it is not already in phase 1 (you can view this information in the status bar at the bottom edge of the screen).
2. If no scan rates are displayed in the GD table, select the menu command **View > Scan Rates**.
3. Enter the required scan rates. You can enter data only in the columns in which the GD packet in question has entries.
Note: When you view status rows and/or scan rate rows, you can edit these rows only.
4. Compile the global data table again (phase 2).

13.5.7 Entering Status Rows

Introduction

For each global data (GD) packet you can specify a status double word for each participating CPU. Status double words have the ID "GDS" in the table. If you assign the status double word (GDS) to a CPU address of the same format, you can evaluate the status in the user program or in the status row.

Group Status

STEP 7 creates a group status (GST) for all global data packets.

The group status, which is also a double word with an identical structure to the status double word (GDS), is formed by linking all the status double words with an OR logic operation.

Procedure

1. Compile the global data table if it is not already in phase 1 (you can view this information in the status bar at the bottom edge of the screen).
2. If no GD status rows are displayed in the GD table, select the menu command **View > GD Status**.
3. Enter the required status double words. You can enter data only in the columns in which the GD packet in question has entries. Enter addresses according to the syntax of the STEP 7 programming languages.
Note: When you view status rows and/or scan rate rows, you can edit these rows only.
4. Compile the global data table again (phase 2).

Structure of the Status Double Word

The following figure shows the structure of the status double word and an explanation of the bits set.

A bit remains set until it is reset by the user program or via a programming device operation.

Any bits not listed are reserved and have no significance at present. The global data status occupies a double word; to make it clearer, MD120 has been used in the figure.

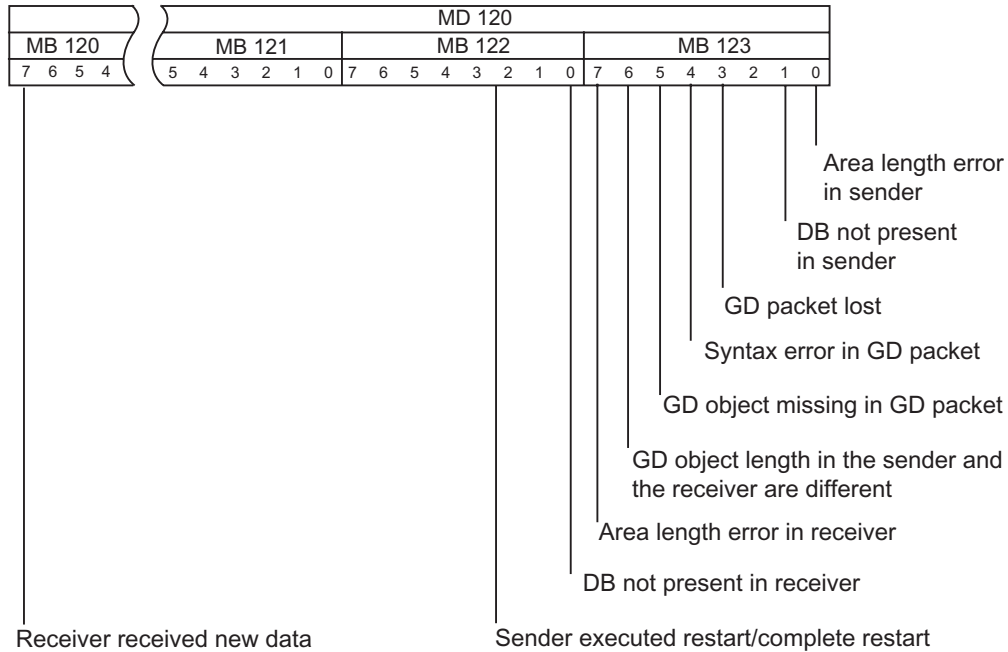

13.5.8 Compiling the GD Table for a Second Time

After editing the status rows and/or scan rate rows, recompile the global data table to ensure that the new information is incorporated in the system data.

The system data generated in phase 1 are sufficient for running global data communication. You can download this data to the CPUs from the programming device. Phase 2 is necessary only if you want to change default values for the scan rates or make entries in the status rows.

13.6 Global Data Transmission Using System Functions

Event-driven data transmission is supported for S7-400 CPUs. A command from the system functions (SFC) in the user program determines when the data exchange occurs. SFC60 "GD_SND" (send global data) is available to send global data and SFC61 "GD_RCV" (receive global data) is available to receive global data. If the CPU supports event-driven data transmission, you must enter the scan rate "0" in the global data table. If a value greater than "0" is entered, global data transmission is cyclic and event-driven.

14 Downloading

14.1 Downloading a Configuration to a Programmable Controller

Tip

Before downloading, use the **Station > Check Consistency** menu command to make sure there are no errors in your station configuration. STEP 7 then checks to see whether downloadable system data can be created from the present configuration. Any errors found during consistency checking are displayed in a window.

Requirements for Downloading

- The programming device (PG) is connected to the MPI interface of the CPU using an MPI cable.
- In a networked system (programming device is connected to a subnet): All modules in a subnet must have different node addresses and the actual configuration must match the network configuration you created.
- The present configuration must match the actual station structure. A configuration can only be downloaded to the station if it is consistent and free of errors. Only then can system data blocks (SDBs) be created which can in turn be downloaded to the modules.
- If the station structure contains modules that were configured and assigned parameters using optional software packages: The optional package must be authorized.

Procedure

- Select the menu command **PLC > Download To Module**.
STEP 7 guides you by means of dialog boxes to the result.

The configuration for the complete programmable controller is downloaded to the CPU. The CPU parameters become active immediately. The parameters for the other modules are transferred to the modules during startup.

Note

Partial configurations, for example, the configuration of individual racks, cannot be downloaded to a station. For consistency reasons, STEP 7 always downloads the whole configuration to the station.

Changing the CPU Operating Mode During Downloading

When you trigger the function **PLC > Download**, you can execute the following actions on the programming device guided by the dialog boxes:

- Switch the CPU to STOP
(if the mode selector is set to RUN-P or the connection to the CPU is authorized by password)
- Compress the memory
(if not enough continuous free memory is available)
- Switch the CPU back to RUN

14.2 Downloading the Network Configuration for the First Time

Before you download for the first time, the modules connected to the subnet do not yet have their configured node address, but a default address. In order that your network functions correctly, each node in a subnet must have a different node address.

- **MPI subnet with connection via the CPU**
CPUs are supplied with the default address 2. However, you can only use this address once in a subnet, so you will have to change the default node address for any other CPUs.
- **PROFIBUS and Industrial Ethernet subnets with CPs**
The CPs of the stations that are run via these subnets must be configured and assigned a node address. You should, for example, assign the address via the MPI of the station before you can download and communicate via the subnet (you will find more information in the SIMATIC NET and SIMATIC NCM manuals).
- There are also Industrial Ethernet CPs (e.g. CP 443-1EX11) or CPUs with an integrated PN interface that have a fixed MAC address. These modules support the direct download of an initial configuration via Industrial Ethernet. There is no need to "name" the station via MPI. All PG functions can be executed via the Ethernet.

If the Network Node is Not an S7 Station...

If the network node is not an S7 station, the network and node properties must be assigned using the tool or switches intended for this purpose. This is the case for DP slaves, for example, whose PROFIBUS address must be set using switches.

Ensure that these settings match the settings for the objects in the network view (PG/PC, Other Station, S5 Station).

Changing the PROFIBUS Address of DP Slaves

DP slaves connected to a PROFIBUS subnet must also have a unique PROFIBUS address. If the DP slave you want to connect supports the function "Set_Slave_Add" (for example, ET 200C), you can assign the address with STEP 7:

In the SIMATIC Manager and in Configuring Hardware you can assign a new PROFIBUS address using the menu command **PLC > PROFIBUS > Assign PROFIBUS Address**.

Tip: If you are not entirely certain of the current address assignment, you should connect the DP slaves to the PG/PC one by one and re-address them.

Changing the Node Address of S7 Stations

To change the preset node address, proceed as follows for S7 stations:

1. Configure the station; set the node address of the connected module (for example, a CPU) in the "General" tab ("Properties" button under "Interface").
2. Switch the module to STOP and connect your programming device to the interface on the module via a connecting cable.
3. Determine the preset node address of the connected module (using, for example, the menu command **PLC > Display Accessible Nodes** in the SIMATIC Manager).
4. Download the configuration with the new node address to the programmable controller (that is, to the connected module):
 - In the station view (Configuring Hardware) using the menu command **PLC > Download**
 - In the network view (NetPro) select the station you want to download and select the menu command **PLC > Download > In The Current Project > Selected Stations**. Enter the "old" (still valid) preset address.

14.3 Downloading the Network Configuration to a Programmable Controller

Requirement

Here we shall assume that the entire project was already configured, meaning you have:

- Configured all stations
- Created all subnets and set their properties
- Configured connections (if required)
- Set the PG/PC interface so that communication between the PG/PC and the programmable controller is possible via the connected subnet.
- Checked the configuration for consistency

Only when a configuration is free of errors, meaning when all networked modules in a subnet have unique node addresses and when their actual configuration matches the network configuration you have created should you download the configuration via the subnet (Industrial Ethernet, PROFIBUS or MPI) to the programmable controllers.

14.4 Downloading to a PC Station

As of STEP 7 V5.1, Service Pack 2, you can completely load PC stations - such as S7-300 or S7-400 stations.

Prerequisites

- To download STEP 7 completely to the PC station, you must configure the PC station as target system via Component Configurator (this Component Configurator is part of the SIMATIC NET CD as of 7/2001). An index is here assigned to the PC component. This procedure corresponds with the insertion of modules into an S7-300/400 station.
Once you have entered your configuration of the PC station, you can use the SIMATIC NCM PC wizards to store it as a project for subsequent reuse in STEP 7 (for example, you can copy it by drag-and-drop to your STEP 7 project and then configure connections to other stations).
- The PC Station must be accessible online: either STEP 7 is installed on the PC station or the PC station is accessible for the creating system (PG/PC with STEP 7) via subnet and respective interfaces (CPs or integrated interfaces).

Downloading while Configuring Networks

You can carry out all load functions while you configure networks with STEP 7 (for example **Download > Selected and Partner Station, ... Subnet Stations** etc.). The procedure is the same as for loading S7-300/400 stations.

System files and a configuration file (*.XDB file) are still generated when a SIMATIC PC configuration is compiled and stored. However, you do not need this configuration file to 'convey' the communication configuration to the PC station.

Routing information for Slot PLCs and Software PLCs (WinLC) is automatically downloaded to the PC station if it represents a network interface.

Previously, download to a PC station was only possible via the integrated interfaces of Slot PLCs or via a CP on Index (slot) 9.

Downloading While Configuring Hardware

Note the following, especially when you download a hardware configuration:

Index (row) 125 in the configuration table of a PC station contains the fixed entry of the 'Station Manager'. The Station Manager represents, on the project side (STEP 7), the entire configuration of the SIMATIC PC station.

On the target system side (PC station), a SIMATIC NCM runtime component function interprets the downloaded configuration data (SDBs). This runtime component is created with the Component Configurator (on the SIMATIC NET CD as of approx. 7/2001). In this way, the PC station can compare the downloaded configuration with the actual configuration and, in case of error, for example, transmit messages relating to differences between the default and actual configuration.

14.5 Downloading Changes to the Network Configuration

Requirements

All networked modules in a subnet must have unique node addresses and the actual configuration must match the network configuration you created.

If you connect a new station to a subnet and the preset node address is already present in the subnet, you should proceed as described under "Downloading for the First Time."

What is Downloaded Where?

After compiling the network configuration (menu command **Network > Save and Compile**) or after **PLC > Download > ...** NetPro creates system data blocks (SDBs) for modules that can interpret the information in the SDBs. The SDBs can contain connection tables, node addresses, subnet properties, input/output addresses, and module parameters.

Depending on which menu command you choose for downloading, different contents are downloaded to different programmable control systems.

Note

When the CPUs concerned are in RUN-P mode, you can only download by using the option **PLC > Download > Connections and Gateways**. For all other options the CPU must be switched to STOP.

For S7-300 CPUs, connections can only be downloaded when the CPU is in STOP mode. Individual connections cannot be downloaded.

Menu Command PLC > Download >	What is Downloaded?	Where?
... Selected Station(s)	Connection tables, node addresses, subnet properties, input/output addresses, and module parameters for the selected stations	To the selected stations
... Selected and Partner Stations	Connection tables, node addresses, subnet properties, input/output addresses, and module parameters for the selected station and the connection partners of the selected station	To the selected station and to all stations that are connection partners of this station
... Stations on Subnet	Connection tables, node addresses, subnet properties, input/output addresses, and module parameters	One after another to all stations on the selected subnet
... Selected Connections	Selected connections (multiple selections possible)	To the local station and (for two-way connections) to the corresponding partner stations

Menu Command PLC > Download >	What is Downloaded?	Where?
... Connections and Network Gateways	Connections (an empty connection table is also possible) and network gateway information	To the selected module (possible in RUN-P mode)

Procedure

1. Connect the programming device to the subnet to which the node you want to load is connected.
2. Open NetPro.
3. Select the station you want to download or the subnet (for **PLC > Download > Stations on Subnet**) in the network view.
4. Select one of the above options for the menu command **PLC > Download**.

Further Information

Further information on the menu commands related to downloading can be found in the context-specific help (select the menu command and press F1).

14.6 Downloading a Changed HW Configuration to an S7-400H Station

With an H-station, you can download a changed HW configuration, without the H-station having to go in STOP mode. To ensure that the H-station can modify the process without interruption during the download; that is, that one of the two CPUs is always in RUN mode, you must absolutely follow the prescribed sequence of operations. For a complete, detailed description of the functions and procedures, refer to the following manual: *Automation System S7-400H Fault-Tolerant Systems*.

As of STEP 7 V5.3 Service Pack 2, you have the option of letting the download procedure after changing the hardware configuration run almost completely automatically. STEP 7 will automatically prepare the next action required. To have this action carried out, you will only have to confirm the step by clicking the "Next" button.

You can also configure this function so that the switchover from one CPU to the other happens mostly automatically.

Requirements and Restrictions for an Automatic Download

- Downloading a changed HW configuration to an S7-400 H-station can only be done in HW Config.
- The changed configuration can only be downloaded to CPUs. The configuration will not be downloaded to any modules that receive their configuration data directly (FM 456-2, FM 456-4).
- When downloading, you cannot reconfigure node addressees; the node addresses configured for the H-CPU's must match the existing node addresses.
- At least one of the two H-CPU's must be able to be reached online.
- The H-station does not necessarily have to be in redundant mode; it is sufficient to have one of the CPU's in RUN mode. For an automated download, the H-station will be placed in redundant mode when the reserve CPU is restarted.
- The operating mode switch for both CPU's must be in RUN position (RUN-P for CPU's with a keyswitch).

If all of these requirements are not met, then the "Download station configuration in RUN mode" option will not be available.

Procedure

1. In HW Config, select the **PLC > Download to Module** menu command.
2. In the "Download to Module" dialog box that is then displayed, select the "Download station configuration in RUN mode" option.
Note: With the "Download in STOP mode" option, select the "not automated" variant of the download procedure.
3. Confirm the selection with "OK".
The "Download to H-Station" dialog box is now displayed.
4. If both CPUs in the H-station can be reached online, then select one of the CPUs shown that is to receive the download of the new configuration (system data blocks). By default, the reserve CPU is preselected to receive the download. The prompt to select a CPU is also displayed in the "Next Action" field.
If only one of the two CPUs can be reached online, then this CPU is automatically selected to receive the download. This default selection cannot be changed.
5. If you want the actions to be switched over from one CPU to the other without interruption, then you should select the "Automatic switchover" check box.
6. Click the "Next" button.
During the download, each action that has been started is displayed in the "Next Action" field.
All completed actions are identified in the "Status" field by a checkmark.
7. Regardless of whether the "Automatic switchover" check box is selected or not, you will have to manually confirm the "Switch to CPU with changed HW configuration" action by clicking "Next".
After this, the CPU with the changed HW configuration automatically goes into RUN mode and the other CPU into STOP mode. After the HW configuration on both CPUs has been brought up to the same, updated version, the system then automatically goes into redundant mode.

14.7 Downloading the Global Data Configuration

During the compiler run, the data in the global data table are converted into system data. If no errors are displayed during compiling, you can transfer the system data to the CPUs:

- Select the menu command **PLC > Download**.

Maximum Number of GD Circles

The number of GD circles is limited to 16. CPUs that have a GD circle number greater than 16 cannot be loaded with the global data configuration.

14.8 Uploading a Configuration from a Station

Requirement

You have used an MPI cable to connect the programming device (PG) to the MPI interface of the CPU.

Tips

Upload stations to a newly created, empty project.

Stations that are dependent on other stations in a particular way (I slave on a DP master station, receiver and sender in a configuration with direct data exchange/lateral communication link) should always be uploaded together to one project. Reason: Without the particular "partners" for a station of this type, the project would remain inconsistent.

Procedure

1. Select the menu command **PLC > Upload**.
The dialog box to open the configuration appears.
2. Select the project in which the configuration will be stored later and confirm with "OK."
3. In the dialog box which then appears, set the node address, rack number, and slot in the module from which the configuration should be read (generally CPU). Confirm with "OK."

You can use the **Station > Properties** menu command to assign a station name to this configuration and then store it in the default project (**Station > Save** menu command).

14.9 Uploading a Network Configuration

Overview

You have the possibility of uploading the real network structure of your project station by station to your programming device.

Firstly you can upload the whole configuration for a project station by station to the programming device in the SIMATIC Manager (menu command **PLC > Upload**). STEP 7 then creates a new station object in the current project for each station you want to upload.

Alternatively you can upload a station configuration when you configure the hardware (menu command **PLC > Upload**).

Below is a description of how you can upload the whole network configuration station by station in NetPro.

Requirements

The PG/PC is connected to the same subnet as the stations you want to upload or the stations are accessible via network gateways. The node addresses and racks/slots of the modules connected to the subnet are known.

Procedure

1. Connect the programming device to the subnet to which the node you want to load is connected.
2. Create a new project for the loaded network configuration if necessary.
3. Open NetPro via a project to which you want to save the uploaded network configuration at a later stage (for example, via a newly created project).
4. Select the menu command **PLC > Upload Station**.
The menu command can be selected only when a project is open.
5. In the following dialog box, specify the station to be uploaded by giving its node address and rack/slot.
The "Station" object appears in the network view with all modules that have a network connection. The subnets to which the station is connected are also displayed. You can change the name of the station assigned by the system using the menu command **Edit > Object Properties**.
The configured connections are also uploaded and are visible when you select a module that is the end point of connections.
6. You can modify the station configuration or the connections as well and then load the changes into the station. For connections that were created using optional packages, the optional package must be installed so that these connections can be edited and loaded into the station again.
7. Proceed as described above until you have loaded all the required stations.
8. If required, you can save the network configuration in the current project (menu command **Network > Save** or **Network > Save and Compile**).

Special Features of Connections Uploaded to the Programming Device

In the connection table, the connection partner configured offline is missing - the connection partner is "unspecified." However, address details are available in the dialog box that follows the properties dialog box.

The communication direction of PTP connections cannot be determined by STEP 7 in every case; but a message informs you of which communication directions are likely.

If both connection partners are uploaded to the programming device (PG), STEP 7 will then attempt to restore the connections between these partners.

15 Multi-User Editing Projects

15.1 Multi-User Configuration in a Network

Overview

In STEP 7 you can work in Windows 2000/XP work groups and on 2000/2003 Servers in a multi-user configuration. You can either work with the multiproject or consider one of the following configurations:

- The project is on a local drive and is also used from another workstation.

Example: Workstations 1 and 2 access project A on workstation 1.

- The project is on a network server.

Example: Workstations 1 and 2 access project C on the network server.

- The projects are distributed among the local drives and one or more network servers.

Example: Workstations 1 and 2 access projects A, B, and C.

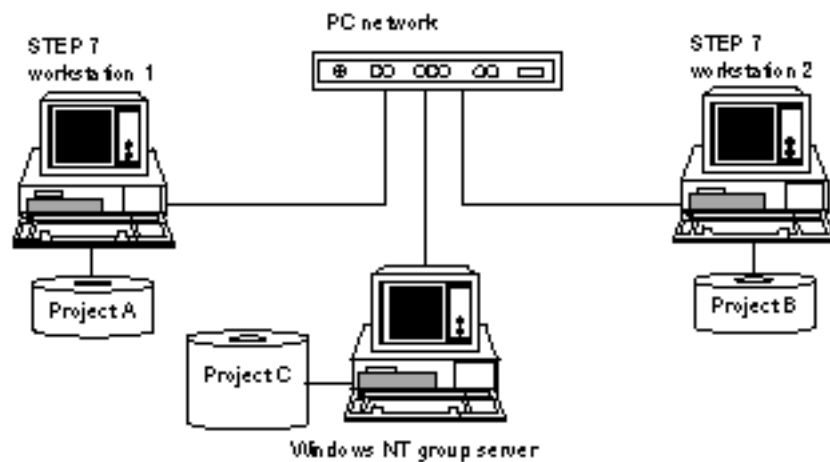

Guidelines for Storing Projects on Network Servers

- As of Version 5.2 you can use the UNC notation when you store your projects on network servers, that is, it is no longer required to assign the project path to a drive.
- When you store your projects on network servers or on enabled drives of other network users, the Windows operating system can only be shut down on those servers or network nodes when all STEP 7 applications that access the projects are closed.
- If you store your projects on network servers or on shared drives of other network stations, ensure that STEP 7 is installed on the network server or the computer of the network station.

Guidelines for Multi-User Editing of S7 Programs

You should note the following:

- Before more than one user can work on one S7 program, you must set the workstation configuration (menu command **Start > Simatic > STEP 7 > Configure SIMATIC Workspace**). Note the corresponding Help on the dialog box.
- Blocks and STL source files:
Each user should program a different block or source file. If two users attempt to edit a block or source file at the same time, a message is displayed, and access is denied for the second user.
- Symbol table:
Several users can open the symbol table at the same time but only one user can edit it. If two users attempt to edit the symbol table at the same time, a message is displayed, and access is denied for the second user.
- Variable tables:
Several users can open the variable table at the same time but only one user can edit it. If two users attempt to edit the variable table at the same time, a message is displayed, and access is denied for the second user. There can be a number of variable tables in an S7 program. These can, of course, be edited separately and independently of each other.

Guidelines for Multi-User Editing of Stations

You should note the following:

- The hardware configuration and the network configuration of a station should only be edited centrally by one user.

15.1.1 Setting the Workstation Configuration

To work on a project from different STEP 7 workstations, you must make the following settings at each workstation.

1. In the Windows start bar, select the menu command **Start > Simatic > STEP 7 > Configure SIMATIC Workstation**.
2. Select the option "Multi-terminal system" and the network protocol you want to use.

15.2 Single Terminal Configuration on Non-Networked Workstations

15.2.1 Merging Several S7 Programs into One

STEP 7 does not offer support with merging S7 programs on non-networked workstations. The only way to merge S7 programs in this case is to copy individual blocks or source files. Shared data for the project such as the symbol table or the variable table must be edited manually after copying.

1. Copy blocks and source files to their respective folders in an S7 program.
2. Export the symbol tables of the individual S7 programs to ASCII format and import them into the symbol table of the merged S7 program.
3. Check whether symbols have been used more than once.

Tip: You can also integrate short symbol tables using the clipboard (copy and paste).

4. Copy the variable tables you want to use or integrate the various variable tables using the clipboard

15.2.2 Copying S7 Programs with Message Attributes

If you have assigned message attributes to blocks, note the following restrictions when you copy S7 programs:

Assigning Project-Oriented Message Numbers

Message numbers could overlap. To avoid conflicts:

- Use the menu command **Edit > Special Object Properties > Message Numbers** to allocate a fixed message number range to each S7 program.
- When you copy S7 programs, make sure they do not overwrite other S7 programs.
- Note that only message types (FBs) can be programmed separately from the S7 program.

Assigning CPU-Oriented Message Numbers

- Programs can be copied within a project to interprojects without a change of message number.
- The message number will change when you copy single blocks. Here you need to recompile the block in order to implement the changed message number in the program.

Copying a Program with Project-Oriented Message Number Assignment into a Project with CPU-Oriented Message Number Assignment

- To copy a program whose message numbers were assigned project oriented to another project that contains a program whose message numbers were assigned CPU oriented, select the required program, call menu command **File > Save As...** and enable the "Reorganize" check box in the pop-up dialog box.
- Message attributes are assigned by default when copying. Inconsistent assignments are displayed in a pop-up dialog box. In this box you can choose your assignment.

Copying a Program with CPU-Oriented Message Number Assignment into a Project with Project-Oriented Message Number Assignment

You can only copy single FBs with messages.

Caution

The assignment of message numbers in the program of a project must be uniform!

When you copy a message-type block that contains a cross-reference to a text library to another program, you must include the corresponding text libraries or create another text library of the same name, or modify the cross-reference in the message text.

16 Working With Projects in the Multiproject

16.1 What You Should Know About Multiprojects

What is a multiproject?

The term multiproject refers to the folder containing all projects and libraries of an automation solution with one or several STEP 7 projects as well as the (optional) libraries. The projects of a multiproject can contain objects linked to other objects (e.g. S7 cross-project connections).

What are the benefits of a multiproject?

Projects as part of a multiproject can be split into smaller objects that are much easier to survey.

You can also use the multiproject, for example, to create projects for distributed authoring and assign a station to each author for offline editing of the project.

Functions linked to other projects (cross-project functions) allow you to handle a multiproject almost in the same way as a single project.

Examples of cross-project functions

STEP 7 cross-project functions (standard software package):

- Save As (storing a multiproject with all projects at other locations)
- Archiving (multiproject with all projects)
- Adjustment of the cross-project network (e.g. merging subnets)
- Update of views (all projects of a multiproject)

Further cross-project functions (with PCS 7, BATCH flexible)

- Transfer of AS-OS connection data
- Exporting BATCH flexible system data

Project structure without multiproject

In a usual project structure without multiproject all objects must be available in a central project, for example, to allow the transfer of AS-OS connection data.

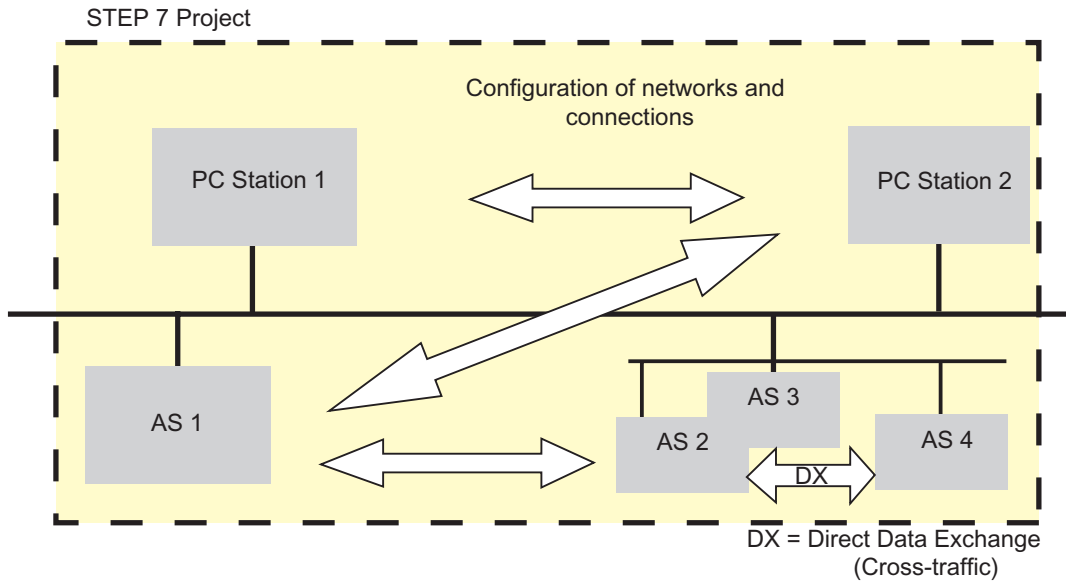

Project structure with multiproject

STEP 7 projects are edited at distributed locations and can therefore be shared by several authors.

Cross-project functions allow the user to split the projects of a multiproject into smaller objects that are much easier to survey.

You can configure one or several automation systems for a project.

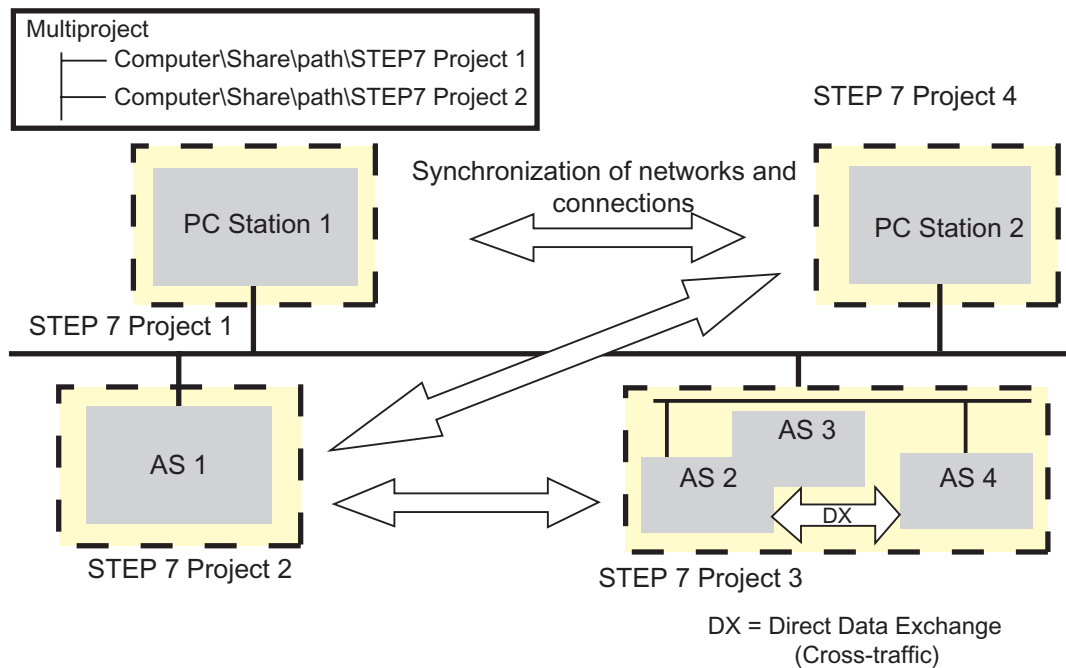

Access protection

- When working on a password-protected multiproject, you can only open those projects to which you have been allowed access a project editor or administrator. All the other project names in the SIMATIC Manager have a gray (dimmed) background.
- To synchronize users, you must be authenticated as a project administrator in the "SIMATIC Logon" administration tool.
- To open an access-protected project or library, you must be authenticated as a project editor or administrator in the SIMATIC Logon administration tool or know the project password.

16.2 Multiproject - Requirements and Recommendations

Different methods of working with the multiproject

The multiproject lets you configure a flexible system. In the foreground is time-saving, parallel creation of projects that can be merged by the system.

Basically we can differentiate between two working methods:

- Several members of a user group in a network environment share a multiproject. The projects of the multiproject are stored in different network folders.
 - In this case, all communication partners are available online for the configuration of connections, for example.
 - Only the execution of cross-project functions on the networks must be agreed upon between the partners, because read/write access to the projects is not permitted while these functions are active.
- The project administrator manages the multiproject at the master database, defines the structure of projects (locally, if required), controls distributed transactions for external authors, then transfers the incoming projects to the multiproject, adjusts the cross-project data via the system functions (file update synchronization) and executes necessary cross-project functions.
 - In this case, for example, you must declare connection names, because during the adjustment of projects the S7 connections could easily be merged due to identical names.
 - The user can also combine those two working methods. STEP 7 supports the distribution of projects across the network as well as the simple insertion and removal of projects of the multiproject, regardless of the method used.

Basic requirements

Prerequisite for the distribution of projects to different network folders is:

- The projects are stored in folders with read/write attribute. This implies in particular:
 - Read/write access to drives storing the multiproject or projects must have been granted prior to the creation of the multiproject.
 - Release names must be unique within the network. We recommend you choose a release name that consists of the computer name and the drive name (e.g. PC52_D).
 - Access rights and release names must not be modified for any resources (folders) participating in the multiproject. The reason is: When a project is inserted into the multiproject, STEP 7 will generate a reference to the location of this project. This reference is determined by access rights and the release name of the corresponding resources.
 - A project can only be found under the release name it was assigned when it was implemented in the multiproject.

- Access to the complete drive hierarchy must be denied. Access rights to a folder may only be granted at one hierarchy level.

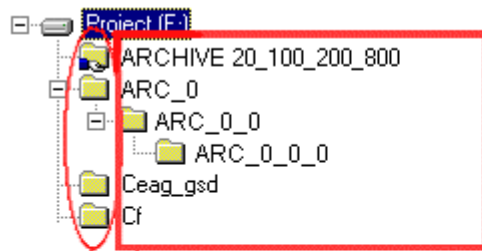

No additional subordinate or superior folders can be enabled.

Only one level can be enabled at a time!

- STEP 7 or PCS 7 must be installed on computers that contain the project folders. The reason being: STEP 7 or PCS 7 provides the required database functions on the server for access to the projects.
- When you implement projects for which you have configured messages into a multiproject, note the following:
 - When assigning message numbers for the project (project-oriented message numbers), the message number ranges for the CPUs must not overlap. If you insert several subprojects with project-oriented message numbers into a multiproject, no automatic redundancy check of message numbers is carried out. You yourself have to check to make sure that message numbers only occur once.

Requirements for cross-project functions

When initiating cross-project functions within such a constellation, you must ensure that:

- All computers containing projects or the multiproject must be available online on the network as long as any projects are being processed.
- Processing of projects is not allowed while these cross-project functions are being executed.

If this can not be ensured, we recommend that you transfer all projects to a PG/PC and then execute the cross-project functions locally.

Multiple users editing to the same object:

- A station should always be edited only by one author at a given time (not only in the multiproject).
- When you split the projects into projects containing only one station, you can be sure that only one author is accessing a project at a given time.

Recommendations and rules for project size

Generally speaking, there is really no way to say how many stations a project should have. Nonetheless, here are a few points that may make it easier for you to make a decision:

- The more complex the station, the less stations the project should have.
- The number of team members available for configuring the system can also be a criterion for specifying your distributed transactions. Each author could work in parallel on a project of the multiproject, independently of others. You could then optimize the size of each project to meet all deadlines for the completion of all projects.
- Stations interconnected via Direct Data Exchange ("cross-traffic") **must be located in the same project**. Note that you can not configure Direct Data Exchange across project boundaries.
- Stations that are operating in global data communication via an MPI subnet also **must be located in the same project**.
- Stations you want to include in your network visualization (NetPro) must also be located in the same project.
- Important for commissioning is: Download functions available under NetPro have no cross-project effect, but rather take effect only within the project. Affected are the functions:
 - **Download in the Current Project > Selected and Partner Stations**
 - Download in the Current Project > Stations on the Subnet
 - Download in the Current Project > Selected Connections
- Compile and save operations are also restricted to the currently active project.

If an S7 connection is a cross-project connection, for example, the network configuration of both participating projects must be compiled.

16.3 Handling Multiprojects

Creating a new multiproject

1. Select menu command **File > New**.
2. In the "Name" box of the "New" dialog box, assign a name to the multiproject and select a "Multiproject" type.
Click on "Find" or edit the path to determine a storage location for the multiproject.

Example:



1. Confirm the dialog with "OK".

Notes on path definitions

Wherever possible you should use UNC conventions to specify your paths. This allows you flexible and future-proof handling of STEP 7 projects.

Example: UNC path definition under Windows 2000:

UNC path: **\\Computer\Share\Path**

\\	double backslash (<Alt> <9><2>)
Computer	Server name: max. string length = 15 characters Name of the computer that supplies the resource (File, directory, ..).
Share	Release name: Under Windows, access to resources of other Windows computers is only possible if corresponding rights have been granted.
Path	This is an optional setting.

Creating a new project for the multiproject

While you create a new project, you can also assign a new project to the current multiproject in the same step.

The multiproject to be inserted in the new project must already be open.

1. Select menu command **File > New**.
2. In the "Name" box of the "New" dialog box, assign a name to the project and select the type "Project".
Activate the "Insert project in current Multiproject" check box.
Click the "Browse" button to determine a storage location for the project. If you are operating in a computer network, you can store the project file on a network drive to provide access to other team members.
3. Confirm the dialog with "OK".

As an alternative, you can also use menu command **File > Multiproject > Create in Multiproject** to generate a multiproject in the current multiproject.

Separating a project from a multiproject or removing a project for editing

For distributed authoring (for example, by external authors) you can also remove projects from the multiproject and reinsert them after they have been edited.

When you remove the project, the dependencies to other projects will be maintained (e.g. cross-project connections) and the projects will still be available for compilation.

1. Select the project(s) you want to remove from the multiproject.
2. Select menu command **File > Multiproject > Remove From Multiproject** or the menu command **File > Multiproject > Remove for Editing**

You can now save the project to a storage medium with "Save As" and distribute it to external authors.

Tip

Another method of preparing projects for external editing:

Create a copy of the project for the external authors with **File > Save As** and keep this "unprocessed" copy in the multiproject, for example, so that you will still be able to debug the cross-project functions.

Then, after the external project has been completed, you can call menu command **File > Add to Multiproject** and replace the original with the edited project.

In this case, you must ensure that only the project copy is edited, rather than both the copy and the original project!

Inserting projects into a multiproject or returning projects to a multiproject after editing

Any existing project can be newly inserted into or returned to a multiproject. For this procedure it is irrelevant whether the object in question had been moved previously or whether a "third-party" or new project is added.

1. Open a multiproject.
2. Select **File > Multiproject > Insert into Multiproject** menu command or the **File > Multiproject > Reapply After Editing** menu command.
3. In the next dialog, select the project you want to add.
4. Confirm the dialog with "OK".

Now you can call the "Adjusting Projects in a Multiproject" wizard to merge cross-project subnets and to adjust the connection configurations.

Note

SIMATIC Manager identifies an open project that is part of a multiprojects with a grayed out multiproject icon:

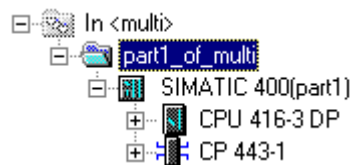

Adjusting projects in a multiproject

The "Adjusting Projects in a Multiproject" wizard merges the subnets and adjusts cross-project connection data.

Start this wizard in SIMATIC Manager under menu command **File > Multiproject > Adjust Projects**.

The adjustment is carried out automatically (as far as possible) and step by step. The wizard logs all inconsistencies. Open NetPro to debug errors that might have occurred.

Copying the multiproject ("Save As")

Regardless whether or not the projects of a multiprojects are distributed to network locations: Whenever you copy the multiproject (use menu command **File > Save As** to save the multiproject), all objects of the multiproject, that is, the actual multiproject and all its projects will be saved to this location. It is here not possible to distribute the projects to several different target folders!

Copying a project in a multiproject ("Save As")

Depending on the current arrangement in the SIMATIC Manager, you have different options available for copying a project that is part of a multiproject:

Case 1: The multiproject is open and a project in the multiproject is selected:

1. Select the menu command **File > Save As**.
2. In the dialog box that appears, select from the following options:
 - "Add to multiproject":
By default, the copy is inserted in the current multiproject. You can also insert the project in another multiproject selected from the list.
If this option is not selected, then the copy is saved as a "normal" project with no relationship to a multiproject. The original project remains in the multiproject.
 - "Replace current project":
The copy is inserted in the current multiproject. The original project is removed from the multiproject and remains in STEP 7 database as a "normal" project with no relationship to a multiproject.
3. Exit the dialog with "OK".

Case 2: The project in a multiproject is open:

1. Select the menu command **File > Save As**.
2. In the dialog box that appears, select from the following options:
 - "Add to multiproject":
By default, the copy is inserted in the first multiproject in the list of multiprojects. You can also insert the project in another multiproject selected from the list.
If this option is not selected, then the copy is saved as a "normal" project with no relationship to a multiproject. The original project remains in the multiproject.
The option "Replace current project" is not available.
3. Exit the dialog with "OK".

Copying projects of a multiproject to an MMC

You can archive the multiproject with all its projects (menu command **File > Archive**) and then save these data to a Micro Memory Card (MMC) that is equipped with sufficient memory space.

Multiproject data you have not archived can **not** be written to a single Micro Memory Card (MMC).

However, you have the option of "spanning" all projects of the multiproject across multiple MMCs. When you save the data to MMC, the multiproject component is automatically included, so that the multiproject structure can be "restored" completely from these volumes at a later time.

We recommend you create a text file to log the multiproject components and their respective storage locations (e.g. CPU IDs), and to include this log file in your data transfer to the MMCs. When service tasks are to be carried out (PG without project information), this procedure saves you a tiresome search to find relevant CPUs that have saved the multiproject objects to the MMC.

How to move projects from one multiproject to another multiproject

You can move a project that is part of a multiproject to another multiproject. To do this, proceed as follows:

1. Open the multiproject to which you want to move the project
2. Select menu command **File > Multiproject > Add to Multiproject**
3. In the dialog box that appears, select the project to be moved.
4. A message is displayed asking you if the project should be added to the current multiproject
Select "Yes" to move the project to the current multiproject.

Moving stations within a multiproject

You can move stations (e.g. S7-400 or SIMATIC PC stations) to other locations in the multiproject.

When a station is moved between projects of a multiproject (e.g. via drag-and-drop), the cross-project connections among the projects will be maintained.

Setting a Library as Master Data Library

You can not only add projects to a multiproject, but also implement libraries, one of which you can identify as master data library. In this master data library you can store blocks used globally for all projects. This function is especially useful for PCS 7 engineering, for example.

The master data library may contain only one program of each type (S7, M7, etc.)

1. Open the library you want to identify as master data library.
2. Select menu command **File > Multiproject > Set as Master Data Library**.
This is the icon for master data library:



16.4 Online Access to PLCs in a Multiproject

Cross-project access with an assigned PG/PC

The "Assign PG/PC" function for the objects "PG/PC" and "SIMATIC PC Station" are also available for the multiproject.

You can specify the target module for online access in any project of the multiproject. This procedure is the same as if you were working with one project only.

Requirements

- PGs/PCs or PC stations you want to use for online access to PLCs must have been assigned in any one project of the multiproject.
Note: The assigned PG/PC or PC station is highlighted in yellow color when the corresponding project is open.
The PG/PC assignment is only visible if the PG that opens the project is properly assigned.
- The cross-project subnets are merged.
- All projects of the multiproject have been compiled and configuration data have been downloaded to the participating stations; for example, to provide routing information to all participating modules for establishing connections between the PG/PC and the target module.
- The target modules can be accessed across the networks.

Possible problems when working with distributed projects

The PG/PC assignment is not visible if the allocation of projects is changed and a project is opened on a PG/PC on which it was not created.

Nonetheless, the configured PG/PC object still maintains the "assigned" status - but with the "wrong" PG/PC.

In this case you must clear the existing assignment and then reassign the PG/PC object. Online access to modules available within the multiproject is then possible without any problem.

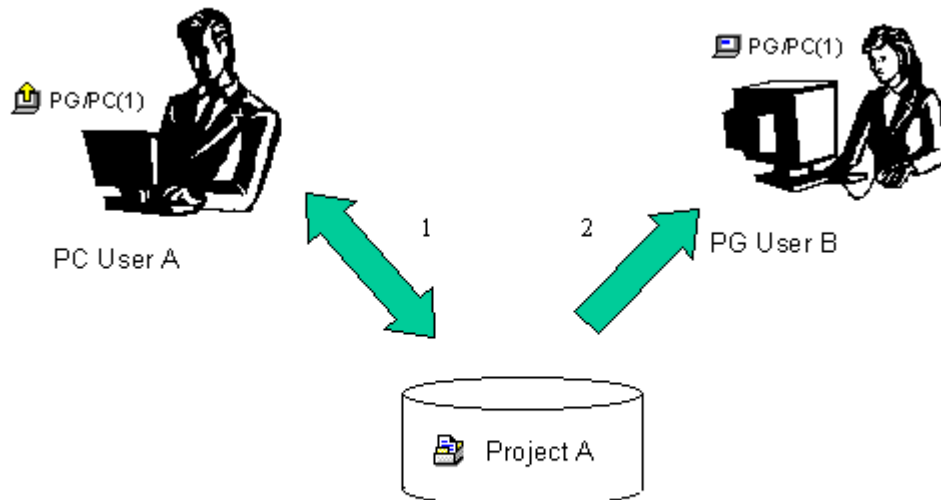

1. Save project A with assigned PG/PC on the network
2. Open the same project A with a different computer

Tip for working with distributed projects

If more than one of the team members want to access the PLCs online on their PG, it would be useful to create one "PG/PC" or "SIMATIC PC station" object in the multiproject and then set up an assignment for each one of the PGs.

Depending on which PG has opened the project, SIMATIC Manager indicates only the object assigned to this PG with a yellow arrow.

16.5 Creating Cross-Project Subnets

Concept of cross-project subnets

Under STEP 7 V5.2 you can configure cross-project subnets that you can use to configure connections.

Subnets "that run across several projects" (that is, are cross-project subnets) are not created in a single operation. Rather, already configured subnets in the different projects of the multiproject are **merged!**

Individual subnets of a merged subnet will be maintained as usual. When grouped, they are assigned to a logical "Subnet Group" that represents the properties that are common to all assigned subnets.

Merged subnets (that is, cross-project subnets) are of the same subnet type, with identical S7 subnet IDs. They are identified under NetPro by their name suffix "(cross-project)".

In the SIMATIC Manager merged subnets are represented by the following special icons.

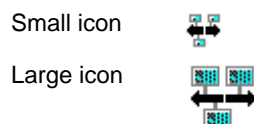

Subnets that can be merged

Industrial Ethernet, PROFIBUS and MPI subnets can be merged.

Subnets that cannot be merged

- PtP subnets **cannot** be merged.
- Constant-cycle PROFIBUS subnets also cannot be merged. Reason: Constant bus cycle time can only be configured for mono-master systems, which means that cross-project communications connections do not make sense in this configuration.
- For this same reason, PROFIBUS subnets that have H stations connected to them as DP masters also cannot be merged.
- If a subnet with a configured sync domain is located in an Ethernet subnet group, no other Ethernet subnet with a sync domain may be added to this group.

Requirements

To merge subnets, write access must have been granted to the participating projects and their subnets.

How to merge subnets in NetPro

To merge or unmerge subnets, proceed as follows:

1. Select the menu command **Edit > Merge / Unmerge Subnets > ...**
Select the type of subnet in the last part of this menu command.
2. In the next dialog, assign the multiproject subnets to a merged subnet.
 - In the right-hand field ("Merged"), select a whole subnet.
 - In the left-hand field ("Subnets in the multiproject"), select subnet that is to be made part of the merged subnet.
 - Click the button with the arrow pointing to the right.

Subnets are grouped so that you can maintain an overview of the subnets you are going to assign common properties (e.g. an identical S7 subnet ID).

All subnets are merged to form a "Merged Subnet" (Default name, for example: PROFIBUS_merged(1)). You can change the default name of the merged subnet.

The properties of the first subnet you add to the subnet group determine the properties of all subnets you subsequently add to the group. You can later specify another "leading" subnet, that is, the one that determines the properties of all others via the "Select" button. The icon for the leading subnet has green border to clearly identify it.

3. If you need more merged subnets, click the "New" button and assign subnets from the field ("Subnets in the multiproject") to this merged subnet, as described above.
4. If required, you can change the subnet properties via the "Properties" button. This may be necessary, for example, for changing the bus parameters of PROFIBUS subnets you are going to merge.
5. Confirm the settings with "OK" or "Apply".
The transferable subnet properties of a leading subnet are then applied to all other subnets of the group.

The picture below highlights the context:

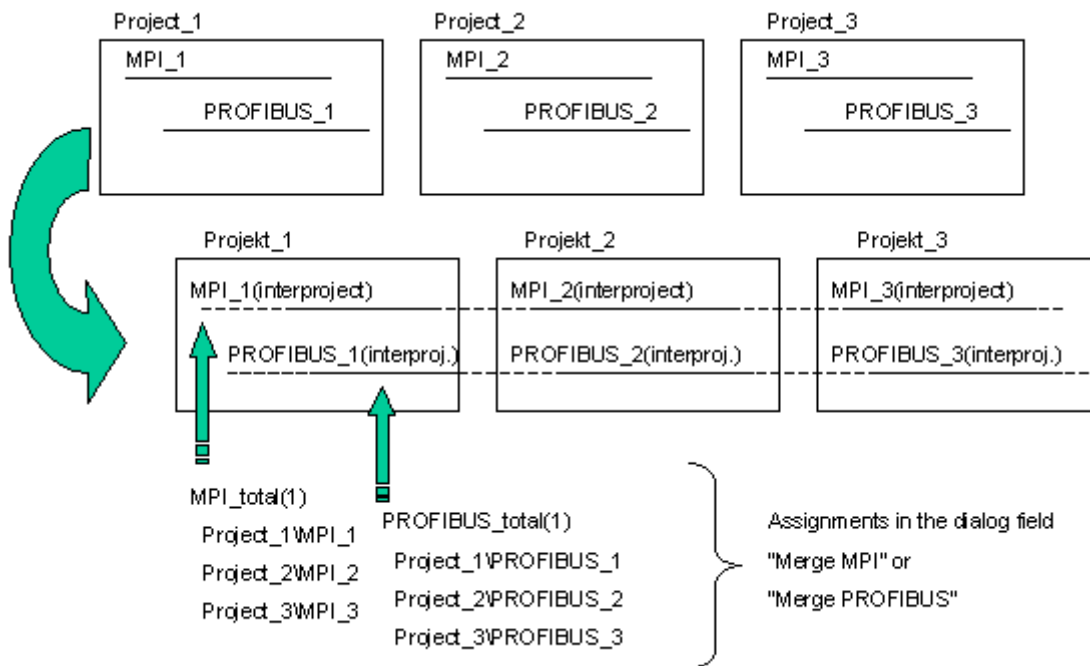

How to unmerge subnets

To unmerge subnets, proceed as follows:

1. Select the menu command **Edit > Merge / Unmerge Subnets > ...**
Select the type of subnet in the last part of this menu command.
2. In the next dialog, select a subnet in the right-hand field ("Merged") that is to be removed from the merged subnet.
3. Click the button with the arrow pointing to the left.
The selected subnet now appears in the left-hand field ("Subnets in the multiproject").

Properties of merged subnets

When you merge subnets, the transferable properties of the master subnet are transferred to the other subnets of the same group.

In addition to the S7 subnet ID, these properties are (for example, with PROFIBUS subnets) the profile, transmission speed, highest address, and the number of nodes to be taken into account.

The following subnet parameters will **not** be adapted - which means that the individual subnets of a group will maintain their own subnet properties:

- Name
- Author
- Comment

16.6 Display Of Merged Subnets In The Network View

The "Multiproject" Window

NetPro displays the "Multiproject" window when you open a project that is part of the multiproject.

Use menu command **View > Multiproject** to hide or show this window. You can also control the view with an icon.

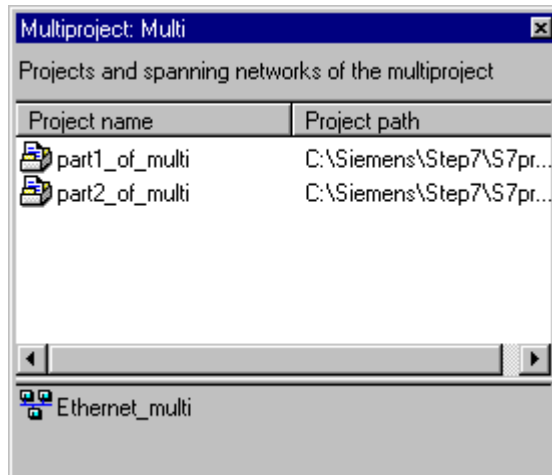

The upper section of the window displays the projects of the multiproject. The lower section displays all cross-project subnets of the multiproject under their master subnet name.

After you have selected the projects in the upper section of the window (multiple selection is also possible), the lower section of this window displays exactly those cross-project subnets that are routed through all the selected projects.

Tip: You can quickly navigate 'through the projects' of a multiprojects by double-clicking on the corresponding project in the "Multiproject" window. STEP 7 will then open the network view of the corresponding project in a separate window.

Network View

The network view displays all cross-project subnets with the name suffix "...(cross-project)".

16.7 Multiproject-Oriented Network View

The multiproject-oriented network view provides an overview of all stations in a multiproject with the connections to their respective subnets.

Cross-project subnets are only shown in this view in context (i.e. like a subnet). The name of the displayed cross-project subnet is the name of the subnet group.

You can print out the multiproject-oriented network view, and you can download to all stations from this view. However, you cannot edit or save projects in this view.

Requirements

- This function can only be started from a project that is part of a multiproject.
- All changes made to projects in the multiproject must be saved. If necessary, you will be prompted to do so.
- All project in the multiproject must be accessible (this is relevant for distributed projects).
- Projects in a multiproject must not be write-protected (read-only).
- No connection status must be activated in an opened project (from which multiproject-oriented network view is supposed to be started).

Procedure

1. In the network view, select a project with the **View > Multiproject-Oriented Network View** menu command.
After this, the menu command is enabled with a check mark.
2. Position the objects as you like. You can also print out the multiproject-oriented network view.
3. From this view, you can download to all stations in the multiproject (command: **PLC > Download ...**)
4. To return to the "normal" network view of the project, select the **View > Multiproject-Oriented Network View** menu command once again.

When you close the project, all positions of the object are automatically saved as well.

Properties of the multiproject-oriented network view

- After this function is called for the first time from a project, all objects are rearranged. You can change the positions of the objects. If you deactivate the multiproject-oriented network view and then call it again from another project in the multiproject, the objects will again be shown in the same arrangement.
- Features of the multiproject-oriented network view such as the zoom factor, the subnet lengths (reduced or not reduced), with or without DP slaves/IO devices, etc. are all determined by the project from which the multiproject-oriented network view has been called.
- When the multiproject-oriented network view is active, you can not make any changes to the projects. However, you can trigger a cross-project consistency test. For this reason, you **cannot** use the **Save** command (**Network > Save**) in the multiproject-oriented network view. If you do select the **Network > Save Compile** menu command, the network configuration **will only be compiled**.
- In the multiproject-oriented network view, a configuration can be downloaded to all stations in the multiproject.
- Only one multiproject-oriented network view can be opened at one time. If another STEP 7 user attempts to start the multiproject-oriented network view from another project, this action will be canceled and an error message will be displayed.

16.8 Configuring Cross-Project Connections

Introduction

After you have configured cross-project subnets, STEP 7 also allows you to configure connections with such master subnets. The end points of these connections may be located in different projects.

STEP 7 offers support for the **creation** of cross-project connections within the multiproject as well as for the **adjustment** of connections configured with no multiproject context.

Connection types of cross-project connections

Under STEP 7 you can create cross-project connections for redundant and S7 connections.

Under SIMATIC NET you can also configure further cross-project connection types - with the exception of FMS connections. For further information, refer to the SIMATIC NET documentation.

Cross-project connections to a specified partner

Cross-project connections to a to a specified partner (e.g. a CPU) are created same as internal connections of a project (identical procedure). The dialog for selecting the connection partner has been expanded and now lets you select - apart from selecting the end point (e.g. a module) - a project in the multiproject in which the end point is located.

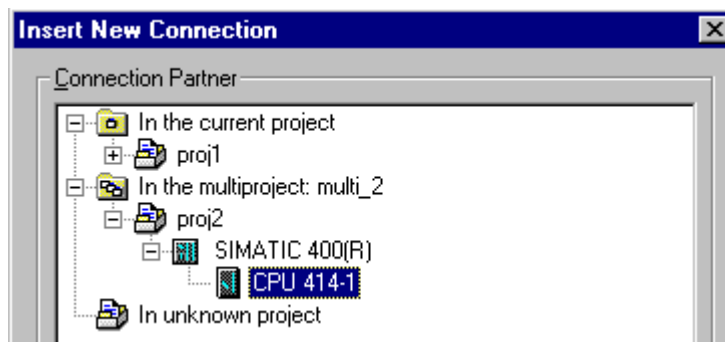

The condition is, that the projects are part of a multiproject and that the subnets have been merged (e.g. by using the "Adjusting Projects in a Multiproject" wizard of SIMATIC Manager).

Properties of cross-project connections

Consistency of cross-project connections is maintained when projects of a multiproject are handled. Cross-project connections within a multiproject stay fully operational and can be compiled, even if the project that contains the connection partner is removed from the multiproject.

The following applies to STEP 7 connections: STEP 7 prompts you to split the connection before the properties dialog pops up only when you call this dialog to view the connection properties. You can only modify the connection properties after you have confirmed this prompt with "Yes". You must adjust the connection properties manually when you change the properties, same as with S7 connections to an unspecified connection partner. Whenever you change connection properties, there is a risk of malfunctions during runtime.

Only the local ID for a connection can be changed without terminating the connection.

Fault-tolerant STEP 7 connections cannot be terminated.

Tip

STEP 7 uses the S7 subnet ID - an object property of a subnet - to adjust cross-project connections.

When you attempt to configure cross-project connections without having merged both of the corresponding subnets (which are to form the connection path), for example because other, similarly affected projects are temporarily unavailable, you can help yourself in the following way:

Adjust the S7 subnet ID at all subnets. Select the respective subnet and view its object properties via the context-sensitive menu. Enter **identical** S7 subnet IDs for both of the subnets.

You can then specify that the nodes on "manually adjusted" subnets of the other project form the connection end point. However, this process still does not confirm the uniqueness of individual subnets from the viewpoint of NetPro. The consistency test would report an error if the projects are connected through a common, cross-project subnet. In this case, the same subnet IDs in different projects will be detected and recognized as errors.

For this reason, merge the subnets in NetPro.

Cross-project connections to a partner in an "unknown" projects

If you can not "lay your hands" on the connection partner in the multiproject, simply because the corresponding project was created at another location or is currently being edited and therefore locked, you can select a connection with "Partner In Unknown Project". Repeat this selection at the partner project.

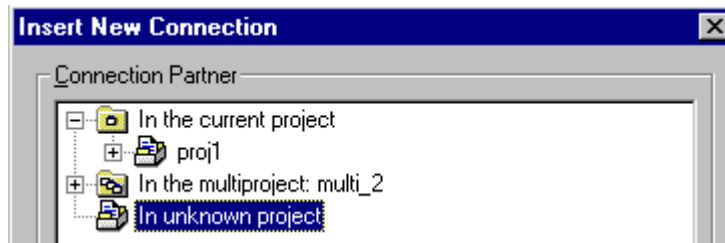

This procedure generates a standby connection in both projects. You can use this connection later to automatically adjust the partner project, after it has been incorporated into the multiproject.

In this case you need to configure an **identical connection name (reference)** in the connection properties of both projects. Using the connection name, you can assign a connection partner and also adjust the connection properties (Menu command **Edit > Merge Connections**).

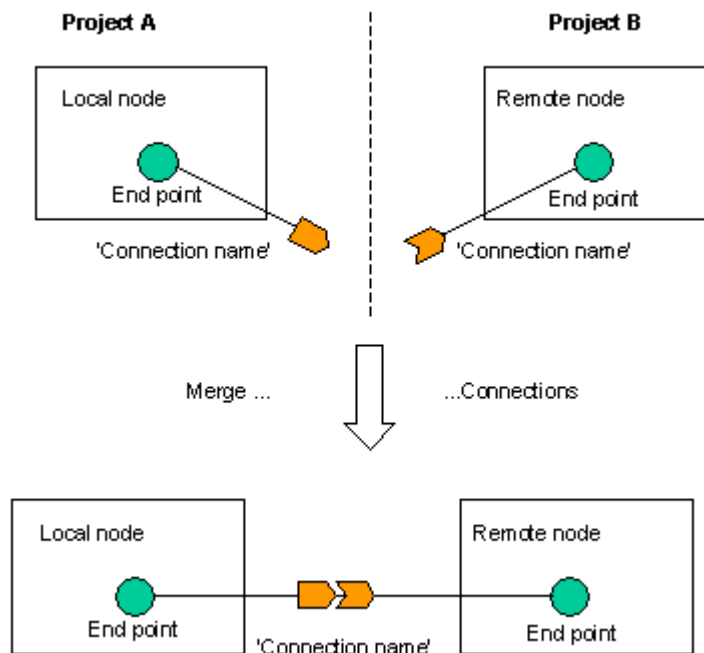

Special considerations for downloads

After you have configured cross-project subnets and connections, you must download the network configuration to all participating modules. They represent the end points of the connection as well as the participating routers.

When you upload these data to the PG (Download to PG) the network configurations and the connections are merged automatically as soon as all conditions for this action have been met (e.g. both end points have been uploaded).

The download functions provided under NetPro do not affect cross-project data. rather, they only have an effect within a project. Functions affected are:

- Download in the Current Project > Selected and Partner Stations
- Download in the Current Project > Stations on the Subnet
- Download in the Current Project > Selected Connections

Save and compile functions are also restricted to the currently active project. An S7 cross-project connection requires of you to compile both participating projects.

These restrictions apply to the "standard" network view of a project. You can also download throughout the entire project ("cross-project") in the cross-project (multiproject-oriented) network view.

16.9 Options for Merging Cross-Project Connections

You can merge cross-project connections such as STEP 7 connections.

- When adjusting projects within a multiproject in the SIMATIC Manager (menu command **File > Multiproject > Adjust Projects**)
- In NetPro with the menu command **Edit > Merge Connection**

However there are the following difference between both procedures:

In the SIMATIC Manager, only those connections are merged that were configured in the affected projects as "Connection partners in unknown project" with the **identical connection names** (reference). In NetPro, however, you can relate connections that have similar or different connection names to each other.

When merging in the SIMATIC Manager, you cannot know in advance which connection partner has which connection properties or which connection partner is the one that adapts its connection properties (i.e. is the active connection partner). When merging in NetPro, the partner adapts its connection properties to those of the local module. In addition, the properties of the connections can be changed in a dialog for merging the connections.

STEP 7 connections to an unspecified partner can only be merged to a cross-project S7 connection in NetPro. Such connections are not handled in the SIMATIC Manager.

16.10 S7 Connections to Unspecified Connection Partners

When you insert a project that contains unspecified S7 connections in a multiproject, you can use a simple method to merge these S7 connections with cross-project S7 connections:

1. Merge the subnets across which the unspecified S7 connection is routed.
2. Call menu command **Edit > Merge Connections**.
STEP 7 will automatically merge the matching unspecified S7 connections.

16.11 Adjusting Projects in the Multiproject

After projects were inserted into a multiproject, the projects must be adjusted in the multiproject. You also call this function after you have modified subnets and connections in a multiproject. Always execute this function when you prepare your configuration for commissioning.

16.12 Archiving and Retrieving Multiprojects

Archiving multiproject data

You can add multiprojects, individual projects or libraries to a compressed (packed) archive file that can be stored on a hard disk drive or on a mobile storage medium (e.g. Zip disk).

If segments of the multiproject are stored on network drives, you can only use the following file compression tools to create an archive for multiproject data:

- PKZip Commandline V4.0 (supplied with the STEP 7 package)
- WinZip from version 6.0
- JAR from version 1.02

Prerequisite for archiving:

Since the archiving function affects all projects of the multiproject (that is, is a cross-project function), the relevant projects must not be accessed by any other processes.

Procedure

1. In SIMATIC Manager, select the multiproject
2. Select menu command **File > Archive**
3. Confirm the multiproject in the next dialog and click "OK".
4. In the next dialog, select the archive name and path as well as the archiving program (e.g. PKZip 4.0)
5. Confirm the dialog with "OK".

How to retrieve multiproject archives

1. In the SIMATIC Manager, select menu command **File > Retrieve**
2. In the next dialog, select the multiproject archive and click on "Open".
3. In the "Select destination directory" dialog that appears, select the target directory for unpacking the archive files.
A new directory is generated in the selected directory. The complete project directory structure of the unpacked multiproject will then appear on the same level below this directory.

17 Commissioning and Service

Preparations for commissioning

For initial commissioning of networked stations you must initially download configuration data to each one of the PLCs separately via menu command **PLC > Download** (SIMATIC Manager). This supplies the PLCs with their required hardware configuration as well as their network node address. After that you can access the network with the menu command **PLC > Compile And Download Objects**.

What has to be done if modifications were made during a commissioning or service phase

If a multiproject is affected, we recommend that you adjust the projects before you download them to the PLC (In SIMATIC Manager, call menu command **File > Multiproject > Adjust projects**). After that you can call the central function "Compile and download objects" to download the changes to the PLC.

17.1 Commissioning PROFIBUS Nodes

As of STEP 7 V5.2 you can use your PG for online access to PROFIBUS nodes, even if only DP slaves and are connected to the PROFIBUS apart from the PG.

At these nodes you can perform diagnostics, monitor their inputs and modify the outputs. You can also reconfigure the nodes and save the currently displayed configuration as the new configuration (select the menu command **PLC > PROFIBUS > Save PROFIBUS Online Configuration as**).

You can use the configuration saved in this manner as a basis for configuring new station (in HW Config, select the menu command **Station > Open**).

How to start online access

In SIMATIC Manager, start this function with menu command **PLC > PROFIBUS > Operator Control/Monitoring And Diagnosis Of Nodes**, or, when you configure the hardware for an open offline station, with menu command **PLC > Operator Control/Monitoring And Diagnosis Of Nodes**.

You will be displayed a view similar to that of HW Config (**Station > Open Online**). The difference is here that you can specify nodes (e.g. via the context-sensitive menu **Specify Module**), modify parameters and save the new configuration as new station.

Offline and online views

After you open the stored configuration ("Offline view") and then start the "Online view" under menu command **PLC > Operator Control/Monitoring And Diagnosis Of Nodes**, the following relationship is applied:

- The Online view displays all nodes found, irrespective of the number of nodes in the offline configuration.
- STEP 7 uses the manufacturer ID and the configuration data as base for an attempt to find a corresponding node in the offline view for each node in the online view.
If successful, (that is, all nodes are identical), the offline view parameters are applied to the online view.

This method ensures that changes made and saved during the commissioning phase are immediately available again when the online is opened.

Operator control and monitoring

In the online view you can read inputs and control outputs. Here, the programming device (PG) functions as the DP master.

1. Select the required node.
2. Call menu command **PLC > Operator Control/Monitoring**.

The operator control/monitoring dialog box pops up. The path definition indicates that online access was performed directly via PROFIBUS services.

The difference of calling this function during the hardware configuration (online via assigned CPU services) to direct access via PROFIBUS services is that triggering conditions can not be applied to DP slaves.

The dialog displays all inputs/outputs of a module in one line.

Using a saved configuration as a basis for configuring a new station

The PROFIBUS nodes determined online can be saved as a station configuration (menu command **PLC > PROFIBUS > Save PROFIBUS Online Configuration As...**). Any changes made (in "Specify Module" or "Change Properties") are also saved.

This newly saved configuration does not, however, contain any specific configuration data for the DP master connected to the PROFIBUS. For this reason, the DP masters are only shown symbolically, in a way similar to DP slaves.

You have the option of configuring DP masters at a later time and then replacing a DP master determined online (and represented symbolically) with the newly configured one.

Procedure:

1. Open the saved PROFIBUS online configuration.
2. Configure the same number of DP masters as the number of DP master systems that were determined online (the complete rack with CPU and PROFIBUS CP or CPUs with integral DP interfaces).
3. Select one of the DP masters determined online that you want to replace with a newly configured DP master.
4. Select the menu command **Options > Assign Master**.
5. In the dialog that is displayed, assign a configured master to a master that was determined online.
6. Repeat steps 3 to 5 until all of the DP masters determined online are replaced by configured ones.

17.2 Identification and Maintenance (I&M)

I&M functions are information functions that you can use to retrieve information about a device, such as the manufacturer, version, ordering information. I&M functions let you find out information about a device concerning its configuration, placement in service, diagnostics and repair.

What Devices Support I&M Data?

In general, PROFIBUS DPV1 slaves can support I&M data. No I&M data are defined for PROFIBUS DPV0 slaves.

What's New about I&M Functions

I&M functions are an integral part of S7 components, known by the designation "Module Identification."

What's new about I&M functions is that accessing this information is now standardized by the German PROFIBUS User Organization [PROFIBUS Nutzerorganisation e.V. (PNO)]. Since STEP 7 also supports this access, you can also process I&M data from non-S7 components.

I Data

I data are information on the module. Some of this information may also be printed on the module housing.

You can read I data by using the module diagnosis function in STEP 7 (in "Module Information" go to the "General" tab and the "Identification" tab).

M Data

M data are plant-dependent information such as the Plant ID (AKZ), Location ID (OKZ), installation data and any comments.

M data can be written to the module online.

17.3 Changing M-Data in the SIMATIC Manager

Requirements

- The module must support I&M data.
- There is an online connection through PROFIBUS ("Accessible Nodes") to the module.

Procedure

To edit M data (such as the Plant ID), proceed as follows:

1. Select the module in the "Accessible Nodes" window, and then select the **PLC > Change Module Identification** menu command.
2. In the "Change Module Identification" dialog, change the M-data as required. For redundant modules, you must edit the data for both the left and right module.
3. To transfer this new data to the module, select the "Include" check box.
4. Confirm your settings with "OK".

The M data will be transferred to the module

17.4 Entering or Changing M-Data in HW Config

Requirements

- The module must support I&M data.
- There is an online connection through PROFIBUS to the module.

Procedure

To edit M data (such as the Plant ID), proceed as follows:

1. Double-click the module. In the property sheet that is displayed, select the "Identification" tab.
2. Enter the M data and then confirm your entries with "OK".
3. Select the **PLC > Download Module Identification** menu command.
4. In the "Download Module Identification" dialog box, compare the offline data in the STEP 7 database with the data at the module ("ONLINE").
5. To overwrite the online data with the offline data, select the "Include" check box.
6. Confirm your settings with "OK".

The M data will be transferred to the module

Index

*

*.cfg File 7-2, 11-7

A

ACCESS 12-19
Accessible Nodes 4-26
Accessing Connection IDs during Programming 12-25
Accessing IO Devices Online via Ethernet 4-24
Active Connection Setup 12-42
Additional Field Devices (Folder in the HW Catalog) 3-4
Address (Interface) 12-42
Address Assignment for Multicomputing Operation 8-3
Address Details (for an Unspecified Connection Partner) 12-41
Address Overview 2-13
Addresses 2-12, 2-14, 3-17, 3-18, 14-3
 Assigning Symbols to I/O Addresses 2-14
 Packing (ET 200S) 3-17
 Setting Addresses of Communication Nodes 14-3
Adjusting Projects in the Multiproject 16-24
AG_LOCK 12-19
AG_LRECV 12-19
AG_LSEND 12-19
AG_RECV 12-19
AG_SEND 12-19
AG_UNLOCK 12-19
Application 6-3
Archiving and Retrieving Multiprojects 16-25
Arranging C7 Complete Systems (Special Features) 2-10
Arranging C7 Control Systems (Special Features) 2-10
Arranging Modules in a Module Group (M7-300) 2-3
Arranging Modules in a Rack 2-8
Arranging the Central Rack 2-8
Arranging the Expansion Rack (SIMATIC 400) 2-20
Arranging the Network View 11-27, 11-29
Assigning a Password 1-6

Assigning a PC station 6-7
Assigning a SIMATIC PC station in the network view 6-7
Assigning Addresses 2-12
Assigning Addresses and Names for PROFINET IO Devices 4-4
Assigning Device Names via a Memory Card (MMC) 4-29
Assigning DP Slaves to SYNC/FREEZE Groups 3-15
Assigning I/O Addresses 2-13
Assigning Parameters 1-1
Assigning Parameters for Constant Bus Cycle Time and Isochrone Mode in HW Config 3-87
Assigning Parameters in the User Program 1-6
Assigning Parameters to CPU Interfaces 1-6
Assigning Parameters to Interrupts 1-6
Assigning PG/PC 11-21
Assigning Properties to Modules/Interfaces 2-11
Auto-positioning in the Network View 11-27

B

Basic Procedure for Configuring a DP Master System 3-1
Basic Procedure for Configuring a PROFINET IO System 4-13
Basic Procedure for Configuring Hardware 1-3
Basic Steps for Configuring a Station 1-3
Blocks for Configured Connections 12-26
Blocks for Different Connection Types 12-18
BRCV 12-18, 12-19, 12-26
Broadcast Node 12-26
BSEND 12-18, 12-19, 12-26
Bus Cycle Time 3-78, 3-79, 3-80, 3-81
Bus error 3-70
Bus Profile 3-78

C

C7 Complete Systems Configuring 2-10
Cascade 2-19
Catalog (HW Config) 1-9

- Catalog (NetPro) 11-14
- Catalog Profile 1-9
- Causes of Inconsistent Connections 12-22
- Central Rack 2-4, 2-8
- Changing in the Connection Table 12-20
- Changing the Connection Partner 12-30
- Changing the CPU Number 8-7
- Changing the IP-Address or the Device Name During Operation 4-30
- Changing the Name of a DP Master System 3-12
- Changing the Node Address 14-4
- Changing the Node Address for STEP 7 Stations 14-3
- Changing the Number of a DP Master System 3-12
- Changing the Operating Mode of CPU during a Download 14-1
- Changing the PROFIBUS Address for DP Slaves 14-3
- Changing the Properties of a DP Master System 3-12
- Checking Consistency 12-22
- Checking the Consistency of a Station Configuration 14-1
- Checking the Consistency of the Network 11-24
- CiR 9-1
- Color Coding in the Network View 11-13
- Color Coding of Changes in the Network View 11-10
- Column Width 12-20
- Commissioning and Service 17-1
- Commissioning PROFIBUS Nodes 17-1
- Communication 3-78, 3-80, 11-2, 11-3, 11-24, 11-27, 11-30, 11-31, 14-3, 14-5, 14-7
 - Blocks for Configured Connections 12-26
- Communication (GD Communication) 13-1
- Communication Nodes
 - Properties 11-2
- Communication Processors 2-17
- Comparison S7 Station - PC Station 6-4
- Comparison of Startup Types
 - Multicomputing 8-3, 8-4
- Compatibility for Import/Export of a Configuration 7-2
- Compiling the GD Table 13-17
- Compiling the GD Table for a Second Time 13-20
- Component configurator 6-7
- Conditions for Sending and Receiving 13-8
- Configuration 4-14
 - Importing and Exporting 7-2
 - Importing/Exporting 7-2
 - PROFINET IO System 4-13
 - Saving 7-1
 - Uploading 14-11
- Configuration File (for SIMATIC PC Station) 6-1
- Configuration of Hardware (Introduction) 1-1
- Configuration Table as a Representation of a Rack 1-5
- Configuration with an External IO Controller 4-20
- Configuration with an Integrated IO Controller 4-19
- Configuration with IE/PB Link 4-21
- Configuration with Intelligent DP Slaves (Data Exchange I Slave <> Master) 3-7
- Configuration with Intelligent DP Slaves (Direct Data Exchange Slave > I Slave) 3-8
- Configuration with SIMATIC PC Stations 4-22
- Configuration with 'Simple' (Modular or Compact) DP Slaves (Data Exchange Slave <> Master) 3-6
- Configuration with Two DP Master Systems (Direct Data Exchange Slave > I Slave) 3-9
- Configuration with Two DP Master Systems (Direct Data Exchange Slave > Master) 3-10
- Configurations for PROFIBUS-DP 3-6
- Configuring 11-10, 11-11, 11-12, 12-33
 - Connections 12-33
 - Subnets (NetPro) 11-10
- Configuring (When Required?) 1-1
- Configuring and Commissioning the Diagnostic Repeater 3-70
- Configuring Communication with a PROFIBUS-CP 12-3
- Configuring Communication with an Ethernet CP 12-2
- Configuring Compact DP Slaves 3-14
- Configuring Connections 12-1, 12-33
 - In a SIMATIC PC Station 12-33
 - Introduction 12-1
 - to a PG/PC 12-36
 - to a PG/PC with WinCC 12-37
 - to Partners in Another Project 12-38, 12-40
- Configuring Connections for Modules in a SIMATIC Station 12-28
- Configuring consistent data areas (> 4 bytes) 3-5
- Configuring Cross-Project Connections 16-20
- Configuring Direct Data Exchange 5-7
- Configuring Direct Data Exchange between PROFIBUS-DP Nodes 3-45

- Configuring DP-Slaves (GSD Rev. 5) as a Receiver for Direct Data Exchange 3-50
- Configuring DPV1 Devices 3-59
- Configuring Expansion Racks in SIMATIC 300 2-19
- Configuring Expansion Racks in SIMATIC 400 2-19
- Configuring GD Communication 13-12
- Configuring Hardware (Introduction) 1-1
- Configuring Hardware (Starting the Application) 2-7
- Configuring H-Systems 10-1
- Configuring Intelligent DP Slaves 3-30
- Configuring IO Controllers 4-15
- Configuring IO Devices 4-16
- Configuring Locally 1-8
- Configuring Modular DP Slaves 3-14
- Configuring Modules for Multicomputing Operation 8-6
- Configuring Multicomputing Operation 8-5
- Configuring Point-to-Point CPs 2-17
- Configuring S5 Modules 2-18
- Configuring short and equal-length process reaction times on PROFIBUS DP 3-82
- Configuring Software Redundancy 3-26
- Configuring the Clock Memory 1-6
- Configuring the CP 342-5 as a DP Slave 3-30
- Configuring the CPU 315-2 DP as a DP Slave 3-30
- Configuring the Distributed I/O (DP) 3-1
- Configuring the ET 200S 3-17
- Configuring the ET 200S (IM 151/CPU) as a DP slave 3-34
- Configuring the ET 200X (BM 147/CPU) as a DP Slave 3-33
- Configuring The Topology 5-6
- Connecting a PG/PC to a Constant-Cycle PROFIBUS network via Industrial Ethernet and an IE/PB Link 3-91
- Connecting an IE/PB-Link to a Constant-Cycle PROFIBUS network 3-91
- Connection
 - Reserving 12-31
- Connection Partner
 - Changing 12-30
 - in Another Project 12-41
 - Unspecified 12-41, 12-42
- Connection Partners
 - in Another Project 12-38
- Connection Properties
 - Changing 12-20
- Connection Resource 12-8, 12-9, 12-10, 12-11, 12-12, 12-13, 12-14, 12-15, 12-16, 12-17, 12-42
- Connection Resources 12-28
- Connection Table 12-20, 12-21, 12-22, 12-23, 12-24, 12-29
 - Editing with Keyboard 12-20
 - Optimizing Column Width 12-20
 - Showing and Hiding Columns 12-20
 - Sorting 12-20
- Connection Types 12-4, 12-5
 - Blocks That Can Be Used 12-18
 - for Partners in Another Projects 12-38
 - for Partners in the Same Project 12-26
- Connections 12-9, 12-10, 12-25, 12-28
 - Accessing Connection IDs during Programming 12-25
 - Assigning Connection Resources 12-8
 - Changing 12-21
 - Configuring 12-1
 - Copying 12-32
 - Creating 12-43
 - Deleting 12-32
 - Downloading to a Programming Device (PG) 14-12
 - Exporting 11-8
 - Inserting 12-29
 - Merging (Multiproject) 16-24
- Consistency
 - Checking a Station Configuration 14-1
- Consistency Check (NetPro) 11-24
- Constant Bus Cycle Time 3-81
- Control and Feedback Interface 3-20, 3-21
- Controlling DP slaves 17-1
- Copying Connections 12-32
- Copying Multiple DP Slaves 3-13
- Copying Subnets and Stations 11-28
- Coupler 3-26
- CP 342-5 as a DP Slave 3-32
- CPs and FMs with MPI Addresses (S7-300) 2-12
- CPU 317-2 PN/DP 12-18
- CPU 31x2 DP as a DP Slave 3-30
- CR2 Rack
 - Expanding 2-20
- Creating a Connection to an "Other Station" a "PG/PC" or a "SIMATIC S5 Station" 12-43
- Creating a DP Master System 3-11
- Creating a New Connection to an Unspecified Partner 12-41
- Creating a PROFINET IO Configuration 5-3
- Creating a PROFINET IO System 4-15
- Creating a Station 2-7
- Creating a Sync Domain 5-4
- Creating an Alarm in the I Slave with SFB75 'SALRM' 3-42

- Creating and Assigning Parameters to Programming Devices (PGs)/PCs To 'Other Stations' and S5-Stations 11-19
- Creating and Assigning Parameters to a Network Connection 11-16
- Creating and Assigning Parameters to a New DP Slave 11-18
- Creating and Assigning Parameters to a New Station 11-15
- Creating and Assigning Parameters to a New Subnet 11-14
- Creating and Assigning Parameters to SIMATIC PC Stations 6-1
- Creating Connections (Rules) 12-28
- Creating Cross-Project Subnets 16-14
- Cross-Project Subnets 16-18
- Current Modules 1-9
- Customizing the Hardware Catalog 1-9

- D**
- Deleting One or More Connections 12-32
- Determining the Communication Capabilities from the GD Resources 13-3
- Device Name 4-4, 4-5, 4-13, 4-30
 - Assigning 4-27
- Device Number 4-5, 4-13, 4-21
- Diagnosing IO Devices 4-31
- Diagnosing PROFINET IO Devices 4-31
- Diagnosis 4-25
- Diagnostic address 3-60
- Diagnostic Repeater 3-73, 3-74
- Digital Simulation Module
 - SIM 374 IN/OUT 16 2-2
- Direct Communication (Lateral Communication) 3-47
- Direct Slave to Slave Communication 3-45
- Disconnecting IO Systems 4-18
- Display of Merged Subnets in the Network View 16-17
- Displaying Information on Components in the Hardware Catalog 1-17
- Displaying Module Information 1-17
- Displaying the Address Overview 2-13
- Displaying the Address Table for a Subnet 11-27
- Displaying the Connection Status 12-23
- Displaying the CPU Assignment 8-6
- Displaying the Node Addresses for a Subnet 11-27
- Displaying the Overview of the Node Addresses for a Subnet 11-27
- Displaying the Topology with the Help of Diagnostic Repeaters 3-73

- Displaying the Version of the CPU Operating System in the 'Hardware Catalog' Window 2-9
- Displaying/Changing the Properties of Components in the Network View 11-27
- Distributed I/O 3-7, 3-8, 3-9, 3-10, 3-47
 - Configuring 3-1
- Distributed reading and writing of consistent data (> 4 bytes) 3-5
- Download (Network Configuration) 14-7
- Downloading 14-1, 14-2, 14-7, 14-8, 14-10
 - a Hardware Configuration to a Programmable Controller 14-1
 - Connections 14-7, 14-8
 - Network Configuration to a Programmable Controller 14-5
- Downloading a Changed HW Configuration to an S7-400H Station 14-9
- Downloading a Configuration to a CPU 14-1
- Downloading a Configuration to a Programmable Controller 14-1
- Downloading a Network Configuration 14-7
- Downloading a Station Configuration to a Programmable Controller 14-1
- Downloading an IRT Configuration 5-8
- Downloading Changes to the Network Configuration 14-7
- Downloading Configuration changes to an H-Station 14-9
- Downloading Connections 14-7
- Downloading the Global Data Configuration 14-10
- Downloading the Network Configuration 14-3
- Downloading the Network Configuration for the First Time 14-3
- Downloading the Network Configuration to a Programmable Controller 14-5
- Downloading to a PC Station 14-6
- Downloading to PROFINET Devices 4-27
- DP Cycle 3-82, 3-85
- DP Cycle Time 3-92
- DP Interface of the CPU 1-6
- DP Master 3-11
- DP Master System 3-11
 - Configuring 3-3
 - Inserting 3-12
 - Separating 3-12
- DP Slave 11-18
- DP Slave is an Intelligent DP Slave 3-4
- DP Slave is bought separately (with new GSD file) 3-4
- DP Slaves
 - Copying 3-13
 - Selecting and Arranging 3-13
- DP Slaves (Compact) 3-14

- DP Slaves (Modular) 3-14
- DP V0 Slaves 3-4
- DP/AS-i Link
 - Configuring 3-17
- DP/PA Coupler 3-25
- DP/PA Link 3-25
- DPV0 3-4
- DPV1 3-58, 3-59, 3-60, 3-61, 3-62, 3-63
- Dummy Module (DM 370 Dummy) 2-2

E

- Editing 11-12, 11-13
 - a Station in NetPro 11-13
- Editing the Local ID in the Connection Table 12-20
- Editing the Network View 11-10
- E-Mail 12-2
- E-Mail Connection 12-27
- E-Mail Connections 12-4
- Entering Scan Rates 13-18
- Entering Status Rows 13-19
- Errors 11-24
- ET 200 X (BM 147/CPU) as a DP Slave 3-30
- ET 200iS 3-23, 3-24
- ET 200L
 - Configuring 3-17
- ET 200M 3-27, 3-28
- ET 200S 3-17, 3-19
- ET 200S (IM 151/CPU) as a DP slave 3-30
- ET 200S in DPV1 mode 3-22
- ET 200S with Option Handling 3-20
- Ethernet 4-2, 4-3, 4-24, 4-25, 4-26
- Ethernet Address Assignment 11-4
- Ethernet CP 12-2
- Example of Configuring an S7-400 as I-Slave 3-35
- Example of Configuring Direct Data Exchange 3-47
- Examples of Configurations with PROFINET IO 4-19
- Exceptions for Calculating the GD Circles Required 13-8
- Exchanging and Moving Modules 1-13
- Exchanging Racks
 - C7 Devices and DP Slaves 1-14
- Expanding the Central Rack with Expansion Racks 2-19
- Expansion Rack 2-4
- Expansion Racks
 - Configuring 2-19
- Export File 7-3
- Exporting 7-2
 - Connections 11-7, 11-9
 - Station 7-2, 7-3, 7-4

- Stations in the Network View 11-7
- Exporting and Importing CAX Data 7-5
- Extending the Network Configuration in NetPro 11-10

F

- Fault-Tolerant PLC Systems 10-1
- Fault-Tolerant S7 Connections 12-26
- FDL Connections 12-4, 12-18, 12-26
- Filling Out the GD Table 13-15
- Finding FAQs on the Internet 1-17
- Finding Manuals on the Internet 1-17
- Finding Module Manuals
 - on the Internet 1-17
- Finding Product Support Information on the Internet 1-17
- First Assignment of Network Nodes 14-3
- FMs and CPs with MPI Addresses (S7-300) 2-12
- FMS Connections 12-4, 12-19, 12-26
- FMS Interface 12-3
- FREEZE 3-15, 3-16, 3-80
- From Configuration To Cyclical Data Exchange (PROFINET IO) 4-11

G

- GC (Global Control) 3-82
- GD Circle 13-5, 13-6
- GD Circle (Calculation) 13-8
- GD Communication 13-10
 - Configuring 13-12
 - Scan Rate and Scan Cycle Time 13-10
- GD Packet 13-4
- GD Resources 13-3
- GD Table 13-14, 13-17
 - Compiling 13-20
 - Opening 13-13
- GET 12-18, 12-19, 12-26
- Global Control Frame 3-84
- Global Data Communication 13-12
- Global Data Communication (Overview) 13-1
- Global Data Configuration
 - Downloading 14-10
- Global Data Transmission Using System Functions 13-21
- Global Data Communication 16-4
- GSD file 3-55
- GSD File 3-4, 3-50, 3-53, 3-54
- GSD Files for IO Devices 3-57
- GSD revision 3-55
- GSDML Schema 3-57

H

Handling DP Master Systems 3-12
Handling IO Systems 4-18
Handling Multiprojects 16-7
Hardware Catalog 1-3, 1-10, 2-9, 3-4, 4-17
 Customizing 1-9
HART Modules 3-26
Highlighting the Communication Partners of
 a Module in the Network View 11-27
Highlighting the DP Master System 11-27
Highlighting the SIMATIC PC station to be
 configured in the network view 6-7
Hot Restart 12-18
H-Station 14-9, 14-10
H-Systems 10-1, 12-13
HTML Process Control 12-2
HW Catalog 1-9, 1-10
HW Config 1-1

I

I Slave 3-42, 3-43
I/O Addresses 2-12
IDENTIFY 12-19
IE/PB Link 4-21, 12-35
IM 153 3-26
IM 153-2 as of V4 3-27
Importing 7-2, 7-3, 7-4
 Station 7-2
Importing and Exporting a
 Configuration 7-2
Importing and Exporting Stations in the
 Network View 11-7
Importing/Exporting a Hardware
 Configuration 7-2
Inconsistent Connections 11-24, 12-22
Industrial Ethernet 4-2
Inserting
 a New Connection 12-29
Inserting a DP Master System 3-12
Inserting a New Connection 12-29
Inserting IO Systems 4-18
Installing a *.GSD File 3-53
Installing Hardware Components 1-18
Installing Hardware Updates 1-18
Integrating Existing PROFIBUS DP
 Configurations 4-6
Intelligent DP Slave 3-4, 3-7, 3-37, 3-38
Intelligent DP Slaves 3-32, **3-33**, 3-34
Interface Submodules and Interfaces
 (Representation in HW Config) 2-8
Interproject Connections 12-38
Interrupt Handling
 Multicomputing Operation 8-3
Introduction
 Isochronous Realtime Ethernet 5-1

Introduction to Configuring Hardware 1-1
IO Controller 4-2, 4-13, 4-15, 4-19, 4-20,
 4-22, 4-23
IO Device 3-57, 4-2, 4-3, 4-8, 4-9, 4-13,
 4-14, 4-16, 4-17, 4-27, 4-31
IO Supervisor (PG/PC) 4-2
IO System 4-2
IO Systems 4-18
IO-Controller 4-27
IO-System 4-11
IP Address 4-4, 11-4, 11-5, 11-6
IRT 5-9, 5-10, 5-12
 Media Redundancy 5-9, 5-12
I-Slave 3-35, 3-41
ISO Transport 12-2
ISO Transport Connections 12-4, 12-19,
 12-26
Isochrone Mode 3-87, 3-88, 3-89
Isochrone Mode with PROFIBUS DP 3-82,
 3-87
Isochronous Mode 3-92
Isochronous mode (see Constant bus cycle
 time) 3-55
ISO-on-TCP Connections 12-4, 12-18,
 12-26
IT-CP 12-2

L

Lag Time 3-89
Language Setting 7-3
Lateral Communication 3-45
Lateral Communication (Direct Data
 Exchange) 3-6, 3-8, 3-9, 3-10, 3-45
Lateral Communication (Example) 3-47
Layout of the Station Window 1-4
LDB 12-36
LDB (Local Database) 12-36
Line diagnostics 3-70, 3-71
Linking PROFINET and PROFIBUS 4-6
Loadable STEP 7 Communication (S7-300
 as Client) 12-18
Local Data Area 1-6
Local Database (LDB) 12-36
Local End Point of a Connection 12-23
Local ID of a Connection
 Changing 12-20

M

M7-300 2-3
M7-400
 Slot Rules 2-5
MAC Address 11-4
Manufacturer Specific Interrupt 3-61
Master System 3-12
Media Redundancy 5-9, 5-10, 5-12
Merging Connections 16-20

Merging Connections (Multiproject) 16-20, 16-24
 Merging Cross-Project Connections 16-24
 Merging Subnets (Multiproject) 16-14
 Merging/Unmerging Subnets 16-14
 Message Frame Error 3-75
 Modifying Outputs 2-14
 Modifying the System during Operation via CiR 9-1
 Modifying Variables 2-15
 Modular DP Slaves
 Configuring 3-14
 Module Catalog (see Hardware Catalog) 1-9, 2-8
 Module Group (M7-300) 2-3
 Module Information
 for the Diagnostic Repeater 3-70
 Module status 3-71
 Modules 1-6, 2-14, 2-16
 Exchanging and Moving 1-13
 Monitoring/Modifying 2-14
 Moving 1-13
 Setting Properties 1-6
 Subsequent Installation 1-18
 Monitoring Inputs 2-14
 Monitoring Variables 2-14
 Mono-Master System 3-6, 3-7, 3-8
 Moving Modules 1-13
 MPI Addresses 2-12
 MPI Addresses of FMs and CPs (S7-300) 2-12
 MPI Interface of the CPU 1-6
 Multicast Nodes 12-27
 Multicomputing 2-20, 8-1, 8-2, 8-4
 Comparison of Startup Types 8-3
 Interrupt Handling 8-3
 Programming 8-8
 Rules for Address Assignment 8-3
 Multi-PLC Operation 6-4
 Multiple Master System 3-9, 3-10
 Multiproject 16-14, 16-15
 Archiving and Retrieving 16-25
 Configuring Cross-Project Connections 16-20
 Creating Cross-Project Subnets 16-14
 Display of Merged Subnets in the Network View 16-17
 Handling 16-7
 Online Access to PLCs in 16-12
 Multiproject - Requirements and Recommendations 16-4
 Multiproject-Oriented Network View 16-18

N

NetPro 11-1, 11-14, 11-29
 Network Address Overview 11-27
 Network Configuration
 Rules 11-3
 Saving 11-26
 Network Configuration and STEP 7 Project 11-1
 Network Gateways 11-30, 11-31, 11-32
 Network View 12-23, 16-18, 16-19
 Networking Stations
 that Represent Network Gateways 11-30
 Networking Stations from Different Projects 11-35
 Networking Stations within a Project 11-1
 Node Addresses 2-12

O

OB 61 3-84
 OB 62 3-82
 OB 63 3-82
 OB 64 3-82
 OB55 3-61
 OB56 3-61
 OB57 3-61
 OB61 to OB 64 3-87
 Online Access to Ethernet Nodes in the "Accessible Nodes" Window 4-25
 Online Access to Modules in NetPro 11-27
 Online Access to PLCs in a Multiproject 16-12
 OPC Client 4-22
 OPC Server 6-2, 6-3, 12-34, 12-36
 OPC Server PROFINET IO 4-22
 Opening More Stations 2-7
 Opening Stations 2-7
 Opening the GD Table 13-13
 Opening the Graphical Network View (Starting NetPro) 11-10
 Operator Control/Monitoring of Distributed I/O 17-1
 Operator Control/Monitoring of DP slaves 17-1
 Operator Control/Monitoring of DP Slaves 17-1
 Optimized Speed 3-78
 Optimizing The DP Cycle Time For Isochronous Processing 3-92
 Option Handling 3-20, 3-21
 Optional Package 10-1
 Optional Software 2-17
 Orange-Colored S7 Station 11-13
 Organization Blocks for Synchronous Cycle Interrupts (OB61 to OB64) 3-82
 Orphaned DP Master System 3-12

- OSTATUS 12-18
- Other Station 11-19, 12-43
 - Object in NetPro 11-19
- Outdoor 1-9
- Overlapping Ti and T 3-92
- Overview Basic Procedure For Configuring IRT 5-3

- P**
- PA Coupler 3-26
- PA Link 3-26
- PA Master 3-25
- PA Master System 3-25
- Packing Address Spaces (ET 200S) 3-17
- Password 7-2
- PBK (See Blocks for Configured Connections) 12-26
- PC Application 4-22
- PC Station 4-22, 6-4, 6-5, 6-6, 11-23, 12-33, 12-34
- PC Station (SIMATIC PC Station) 6-1
- PC-based SIMATIC Controllers 6-4
- PDM 3-24
- PG/PC 11-19, 11-20, 12-43
- PG/PC with SAPI-S7 Interface 12-36
- Point-to-Point Connection 2-17
- Point-to-Point Connections 12-4, 12-19, 12-26
- Point-to-Point CPs 2-17
- Pop-Up Menu 12-20
- Positioning Stations and Subnets in NetPro 11-27
- Power Supply Modules
 - Redundant 2-5
- PRINT 12-19
- Printer 2-17
- Priorities for Interrupts 1-6
- Procedure for Configuring and Assigning Parameters to a Local Configuration 1-8
- Process Image Partition 3-88, 3-90
- Process Reaction Times 3-82, 3-83, 3-84, 3-85
- PROFIBUS DP 3-4, 3-12
- PROFIBUS DP and PROFINET IO (Similarities and Differences) 4-2
- PROFIBUS DP Interface of the CPU 1-6
- PROFIBUS PA 3-25
- PROFIBUS-CPs 12-3
- PROFIBUS-DP 3-1, 3-6, 3-47, 3-78, 3-79, 3-80, 3-86
 - Configurations 3-6
 - Direct Data Exchange (Lateral Communication) 3-6
 - Intelligent DP Slave 3-6
 - Shared Input 3-6
- PROFIBUS-DP Partners 3-45
- Profile (DP) 3-78
- Profile (Hardware Catalog) 1-9
- PROFINET Device with Proxy Functionality 4-6, 4-7
- PROFINET IO 3-57, 4-1, 4-2, 4-3, 4-6, 4-8, 4-9, 4-11, 4-13, 4-15, 4-18, 4-19, 4-20, 4-21, 4-22, 4-24, 4-26, 4-27, 4-30, 4-31
- PROFINET IO Controller 4-15, 4-19, 4-20, 4-22
- PROFINET IO Device 4-16
- PROFINET IO Systems 4-18
- Programming CPUs 8-8
- Programming Device Access by Means of Integrated PROFIBUS-DP Interface 3-12
- Programming Devices (PGs)/PCs
 - Object in NetPro 11-19
 - Representing as Programming Device in the Network View 11-19
- Programming Devices / PCs as Connection Partners 12-36
- Programming DPV1 Devices 3-61
- Programming DPV1 Slaves (OB55 to OB57) 3-61
- Programming the CPUs 8-8
- Properties of Subnets and Communication Nodes 11-2
- PtP Connection 2-17
- Publisher 3-51, 3-52
- Publisher (Publisher in Lateral Communication) 3-45
- PUT 12-18, 12-19, 12-26

- R**
- READ 12-18, 12-19
- Reading Diagnostics with SFC13 3-61
- Reading the System Status List 3-62
- Reading/writing Data Records 3-62
- Rearranging DP Slaves in the Network View 11-27
- Receiving Global Data 13-8
- Red-Colored S7 Station 11-13
- Reducing Subnet Lengths 11-16, 11-27, 11-29
- Redundant Power Supply Modules 2-5
- Redundant S7 Connections 12-4
- Reference Junctions 3-19
- Reflection Error 3-75
- REPORT 12-19
- Representation of Interfaces and Interface Submodules 2-8
- Representing the Programming Device in the Network View 11-19
- Required Number of GD Circles 13-5
- Required Number of GD Packets 13-4
- RESERVE Module 3-20

Reserving a Connection 12-31
 Resource 12-28
 Resources 12-13, 12-15, 12-16
 Response Time for
 GD Communication 13-11
 Results of the Consistency Check 11-24
 RESUME 12-18, 12-26
 Routed S7 Connections 12-34
 Router 11-6, 12-35
 Routers 11-30
 Routing 3-91
 RTD Module 3-19
 RTE Base Programming Interface 4-22
 Rules for Arranging Modules
 (SIMATIC 300) 2-1
 Rules for Arranging Modules (SIMATIC
 400) 2-4
 Rules for Configuring an ET 200S 3-17
 Rules for Connecting Expansion Racks
 (SIMATIC 400) 2-20
 Rules for Creating Connections 12-28
 Rules for Network Configuration 11-3

S

S5 Station 11-19
 Object in NetPro 11-19
 S7 Communication 12-18
 S7 Connections 12-4, 12-8, 12-10, 12-11,
 12-12, 12-34, 12-35, 12-36, 12-37, 16-24
 Assigning Connection Resources 12-8
 Blocks That Can Be Used 12-18
 Interconnected Subnets for a PC Station
 Through a Router 12-34
 to a PG/PC 12-36
 to a PG/PC with WinCC 12-37
 S7 Connections (Interconnected Subnets)
 12-34
 S7 Connections (Redundant) 12-4
 S7 Connections (Unspecified) 16-24
 S7 Connections to Unspecified Connection
 Partners 16-24
 S7 Functions (S7 Communication) 12-2
 S7 Slaves 3-4
 S7 Subnet ID 16-16
 S7-400H 10-1, 14-9
 S7-Connections 12-41
 S7RTM (see Component Configurator) 6-7
 SAPI-S7 Interface 12-36
 Saving a Configuration 7-1
 Saving and Compiling 13-17
 Saving and Compiling the GD Table for the
 First Time 13-17
 Saving Connections 12-43
 Saving the Network Configuration 11-26
 Scan Rates
 Entering 13-18

Searching 1-10
 in the Hardware Catalog 1-10
 Searching in the Catalog (NetPro) 11-18
 Searching in the Hardware Catalog 1-10
 Segment 3-70, 3-71, 3-72, 3-73
 Segment error 3-70, 3-73
 Selecting a DP Mastersystem 11-27
 Selecting and Arranging DP Slaves 3-13
 Selecting and Arranging IO Devices 4-16
 Selecting Nodes on the Subnet
 (NetPro) 11-19
 SEND/RECEIVE Interface 12-2, 12-9
 Sending Global Data 13-8
 SEND-RECEIVE Interface 12-3
 Separating a DP Master System from the
 PROFIBUS Interface 3-12
 Setting a Specific Update Time
 for an IO-Device 4-10
 Setting Constant Bus Cycle Times
 (PROFIBUS) 3-78
 Setting Constant Bus Cycle Times for
 PROFIBUS Subnets 3-78
 Setting Priority Classes 1-6
 Setting the Level of Protection 1-6
 Setting the Properties of Components 1-6
 Setting the Retentive Characteristics 1-6
 Setting the System Reaction 1-6
 Setting Update Times 5-5
 SFB 12-26
 BRCV 12-26
 BSEND 12-26
 GET 12-26
 PUT 12-26
 RESUME 12-26
 START 12-26
 STATUS 12-26
 STOP 12-26
 URCV 12-26
 USEND 12-26
 USTATUS 12-26
 SFB 52 (read data record) 4-31
 SFB 54 (read additional information on
 interrupt) 4-31
 SFB54 RALRM 3-61
 SFB75 'SALRM' 3-42
 SFC 126 'SYNC_PI' 3-82
 SFC 127 'SYNC_PO' 3-82
 SFC 78 'OB_RT' 3-82, 3-90
 SFC126 'SYNC_PI' 3-87
 SFC127 'SYNC_PO' 3-87
 Shortening the Process Reaction Time by
 Overlapping Ti and To 3-92
 Showing and Hiding Columns 12-20
 SIMATIC PC - Appending Configurations of
 Previous Versions 6-5
 SIMATIC PC Station 4-22, 6-1, 6-2, 6-3,
 6-4, 6-5, 11-19, 11-21, 12-33

- Object in NetPro 11-19
 - SIMATIC PC Stations 4-22
 - SIMATIC PC-Station 12-34, 12-36
 - SIMATIC PDM 3-23, 3-24, 3-26
 - SIMATIC S5 12-43
 - Simulation Module SIM 374 IN/OUT 16 2-2
 - SIPROM (see SIMATIC PDM) 3-26
 - Slave 11-18
 - Slot PLC 6-1, 6-2, 6-4
 - Slot Rules (S7-300) 2-1
 - Slot Rules and Other Rules (Configuring Hardware) 1-7
 - Slot Rules for a SIMATIC PC Station 6-4
 - Soft PLC 6-4
 - Software PLC 6-1, 6-2
 - Software Redundancy 3-27
 - Software Redundancy Configuring 3-26
 - Special Features of Multicomputing 8-3
 - Special Rules for M7-400 2-5
 - Special Rules for Power Supply Modules with Redundant Capability (S7-400) 2-5
 - Special Rules for PROFIBUS-DP Interface Submodules (M7-400) 2-6
 - Special Rules for the Digital Simulation Module SIM 374 IN/OUT 16 2-2
 - Special Rules for the Dummy Module (DM 370 Dummy) 2-2
 - Standard 3-78
 - Standard Slave 3-4, 3-50
 - START 12-18, 12-26
 - Starting a Global Data Configuration from NetPro 11-27
 - Starting the Application to Configure the Hardware 2-7
 - Startup Characteristics 1-6
 - Station
 - Editing in Netpro 11-10
 - Importing/Exporting 7-2
 - Station Configuration
 - Uploading 14-11
 - Stations from Different Projects
 - Networking 11-35
 - Statistical Data 3-77
 - STATUS 12-18, 12-19, 12-26
 - Status Information 12-24
 - Status Interrupt 3-61
 - Status of the Communication Connections 12-23
 - Status of the Global Data Communication 13-19
 - Status Rows
 - Entering 13-19
 - STEP 7 Connections 12-18, 12-26
 - to an Unspecified Partners 12-41
 - STEP 7 Connections (Cross-Project) 16-20
 - STEP 7 Connections (Redundant) 12-26
 - STOP 12-26
 - Structure of a DPV1 Slave 3-59
 - Subnet 11-27, 11-28, 11-29
 - Properties 11-2
 - Subnet ID 11-32, 16-14
 - Subnet Length
 - Reducing 11-16
 - Subnet mask 11-5, 11-6
 - Subnets and Stations 11-1
 - Subscriber 3-50, 3-51, 3-52, 3-55
 - Subscriber (Subscriber in Lateral Communication) 3-45
 - Subsequent Installation of Components 1-18
 - Switch 4-24, 4-25
 - Switching over the DP Master Interface 3-59
 - Symbols
 - Assigning Symbols to I/O Addresses When Configuring Modules 2-14
 - Symbols (Diagnostic Repeater) 3-70
 - SYNC 3-15, 3-16
 - Sync Domain 5-1
 - Sync Master 5-1
 - Sync Slave 5-1
 - SYNC/FREEZE 3-80
 - Synchronous Cycle Interrupts 3-87
 - System Data Block (SDB) 7-1
- ## T
- Taking Connections for Programming Devices/PCs into Account in the Network Configuration 11-21
 - TC Module 3-17
 - TCP/IP 12-2
 - TeleService 11-33
 - Terminating STEP 7 Connections (Multiproject) 16-20
 - Testing DP Slaves 17-1
 - Testing Inputs/Outputs 2-14
 - That's me - Function for PC stations 6-7
 - That's me (see Assigning PG/PC) 11-21
 - The Slot Model of DPV1 Slaves with I-Slaves 3-65
 - Thermocouple 3-19
 - Ti 3-86
 - Ti and To 3-92
 - Tips for Editing Station Configurations 1-11
 - Tips for Editing the Network Configuration 11-27
 - Tips for Working with GD Tables 13-14
 - To 3-83, 3-84, 3-85, 3-86
 - Topology 3-70, 3-71
 - Topology Data 3-75, 3-76, 3-77
 - Topology View 3-76
 - TSAP (Transport Service Access Point) 12-42

Type File 3-4
 Type File (see GSD File) 3-53

U

UDP Connections 12-4, 12-26
 Unmerging Cross-Project Subnets 16-14
 Unmerging Subnets (Multiproject) 16-14
 Unspecified Connection Partner 12-31,
 12-37, 12-42
 Update Interrupt 3-61
 Update Times For Cyclical Data Exchange
 (PROFINET) 4-8
 Upload (Uploading a Network Configuration
 to a Programming Device) 14-12
 Uploading 14-11
 Configuration from a Station 14-11
 Hardware Configuration to a
 Programmable Controller 14-11
 Uploading a Configuration to a
 Programmable Controller 14-11
 Uploading a Hardware Configuration to a
 Programmable Controller 14-11
 Uploading a Network Configuration 14-12
 Uploading a Station Configuration to a
 Programmable Controller 14-11
 Uploading to a Programming Device (PG)
 (Network Configuration and Connections)
 14-12
 URC 12-18
 URCV 12-26
 USEND 12-18, 12-26
 User Application 6-1
 Using Connection Resources with Fault-
 Tolerant S7 Connections 12-13
 USTATUS 12-18, 12-26

W

WAN 11-33, 11-34
 Warm Restart 12-18
 Warning 11-25
 What Is PROFINET IO? 4-1
 What You Should Know a About Media
 Redundancy 5-9
 What You Should Know About Assigning
 Connection Resources 12-8
 What You Should Know about GSD Files
 for IO Devices 3-57
 What you should know about GSD
 revisions 3-55
 What You Should Know About
 Multicomputing 8-1
 What You Should Know About Multiprojects
 16-1
 What You Should Know About PROFIBUS
 DPV1 3-58
 What You Should Know About Slot Rules
 and Other Rules 1-7
 What You Should Know About the Different
 Connection Types 12-4
 When to Use Multicomputing 8-4
 Where Are the DP Slaves in the Hardware
 Catalog Window? 3-4
 Where Are The IO Devices Located In The
 Hardware Catalog? 4-17
 WinAC 6-1, 6-2, 6-4
 WinCC (configuring connections to...)
 12-37
 Windows Language Setting 7-2
 WinLC 6-1, 6-2, 6-3
 Working with *.GSD Files 3-53
 Working with the Connection Table 12-20
 Working With the Topology View 3-75
 WRITE 12-18, 12-19

X

XDB file (see Configuration File) 6-1

