

SIEMENS



SIMATIC

S7-1500 / ET 200MP

数字量输入模块 DI 16x24...125VUC HF (6ES7521-7EH00-0AB0)

手册

版本

11/2015

Answers for industry.

SIEMENS

SIMATIC

S7-1500/ET 200MP 数字量输入模块 DI 16x24...125VUC HF (6ES7521-7EH00-0AB0)

设备手册

前言

文档指南

1

产品概述

2

接线

3

参数/地址空间

4

中断/诊断报警

5

技术规范

6

尺寸图

A

参数数据记录

B



Open Source Software

C

法律资讯

警告提示系统

为了您的人身安全以及避免财产损失，必须注意本手册中的提示。人身安全的提示用一个警告三角表示，仅与财产损失有关的提示不带警告三角。警告提示根据危险等级由高到低如下表示。

 危险
表示如果不采取相应的小心措施， 将会 导致死亡或者严重的人身伤害。
 警告
表示如果不采取相应的小心措施， 可能 导致死亡或者严重的人身伤害。
 小心
表示如果不采取相应的小心措施，可能导致轻微的人身伤害。
注意
表示如果不采取相应的小心措施，可能导致财产损失。

当出现多个危险等级的情况下，每次总是使用最高等级的警告提示。如果在某个警告提示中带有警告可能导致人身伤害的警告三角，则可能在该警告提示中另外还附带有可能导致财产损失的警告。

合格的专业人员

本文件所属的产品/系统只允许由符合各项工作要求的**合格人员**进行操作。其操作必须遵照各自附带的文件说明，特别是其中的安全及警告提示。由于具备相关培训及经验，合格人员可以察觉本产品/系统的风险，并避免可能的危险。

按规定使用 Siemens 产品

请注意下列说明：

 警告
Siemens 产品只允许用于目录和相关技术文件中规定的使用情况。如果要使用其他公司的产品和组件，必须得到 Siemens 推荐和允许。正确的运输、储存、组装、装配、安装、调试、操作和维护是产品安全、正常运行的前提。必须保证允许的环境条件。必须注意相关文件中的提示。

商标

所有带有标记符号 © 的都是西门子股份有限公司的注册商标。本印刷品中的其他符号可能是一些其他商标。若第三方出于自身目的使用这些商标，将侵害其所有者的权利。

责任免除

我们已对印刷品中所述内容与硬件和软件的一致性作过检查。然而不排除存在偏差的可能性，因此我们不保证印刷品中所述内容与硬件和软件完全一致。印刷品中的数据都按规定经过检测，必要的修正值包含在下一版本中。

前言

本文档的用途

本手册是对系统手册《S7-1500/ET 200MP (<http://support.automation.siemens.com/WW/view/zh/59191792>)》的补充。

在这些系统手册中，介绍了与这些系统相关的各种功能。

本手册和系统/功能手册中介绍的信息将为您进行系统调试提供技术支持。

约定

本手册中使用的术语“CPU”既可指代 S7-1500 自动化系统的 CPU，也可指代 ET 200MP 分布式 I/O 系统的接口模块。

请注意下列注意事项：

说明

这些注意事项包含有关本文档中所述产品、产品操作或文档中应特别关注部分的重要信息。

安全信息

西门子为其产品及解决方案提供工业安全功能，以支持工厂、解决方案、机器、设备和/或网络的安全运行。这些功能是整个工业安全机制的重要组成部分。有鉴于此，西门子不断对产品和解决方案进行开发和完善。西门子强烈建议您定期检查产品的更新和升级信息。

要确保西门子产品和解决方案的安全操作，还须采取适当的预防措施（例如：设备单元保护机制），并将每个组件纳入全面且先进的工业安全保护机制中。此外，还需考虑到可能使用的所有第三方产品。更多有关工业安全的信息，请访问 Internet (<http://www.siemens.com/industrialsecurity>)。

要及时了解有关产品的更新和升级信息，请订阅相关产品的实事信息。更多相关信息，请访问 Internet (<http://support.automation.siemens.com>)。

开源软件

在所述产品的固件中采用了开源软件 (Open Source Software)。“开源软件”免费提供。我们根据适用于产品的规定对所述产品及包含在内的开源软件负责。Siemens 不对开源软件的非预期用途或因修改开源软件引起的任何故障承担任何责任。

出于法律上的原因，我们有责任原文公布许可条件和版权提示。相关信息请参见附录。

目录

	前言	4
1	文档指南	7
2	产品概述	10
2.1	特性	10
3	接线	13
3.1	接线图和方框图	13
4	参数/地址空间	16
4.1	参数	16
4.2	参数声明	18
4.3	地址空间	19
5	中断/诊断报警	24
5.1	状态和错误指示灯	24
5.2	中断	26
5.3	诊断报警	28
6	技术规范	29
A	尺寸图	33
A.1	尺寸图	33
B	参数数据记录	35
B.1	参数分配和参数数据记录的结构	35
B.2	参数数据记录的结构	36
C	Open Source Software	38
C.1	开源软件	38

SIMATIC S7-1500 自动化系统和 SIMATIC ET 200MP 分布式 I/O 系统的文档分为 3 个部分。

这样，用户可以根据具体需求快速访问自己所需内容。

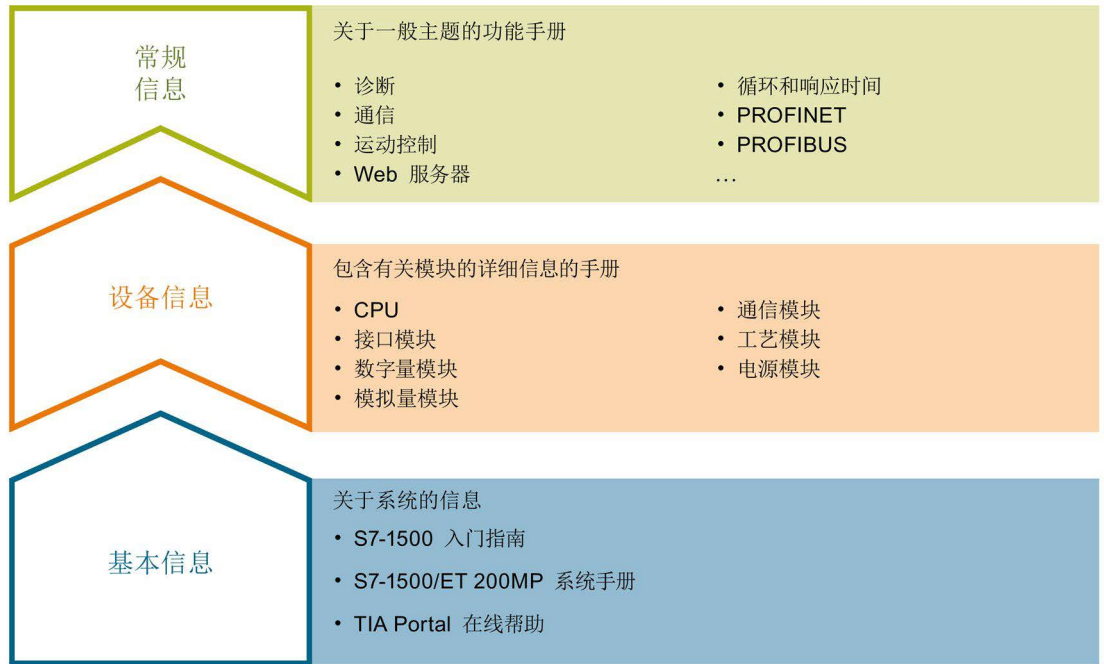

基本信息

系统手册和入门指南中详细介绍了 SIMATIC S7-1500 和 ET 200MP 系统的组态、安装、接线和调试等信息。STEP 7 在线帮助用户提供了组态和编程方面的支持。

设备信息

产品手册中包含模块特定信息的简要介绍，如特性、接线图、功能特性和技术规范。

常规信息

功能手册中包含有关 SIMATIC S7-1500 和 ET 200MP 系统常规主题的详细介绍，如诊断、通信、运动控制、Web 服务器等等。

相关文档，可从 Internet (<http://www.automation.siemens.com/mcms/industrial-automation-systems-simatic/en/manual-overview/tech-doc-controllers/Pages/Default.aspx>) 免费下载。

产品信息中记录了对这些手册的更改和补充信息。

相关产品信息，可从 Internet (<https://support.industry.siemens.com/cs/cn/zh/view/68052815>) 免费下载。

手册集 S7-1500/ET 200MP

该手册集中，将 SIMATIC S7-1500 自动化系统和 ET 200MP 分布式 I/O 系统的所有文档都归纳一个文件中。

该手册集可从 Internet (<http://support.automation.siemens.com/WW/view/zh/86140384>) 下载。

“我的技术支持”

通过“我的技术支持”（我的个人工作区），“工业在线技术支持”的应用将更为方便快捷。

在“我的技术支持”中，用户可以保存过滤器、收藏夹和标签，请求 CAx 数据以及编译“文档”区内的个人数据库。此外，支持申请页面还支持用户资料自动填写。用户可随时查看当前的所申请的支持请求。

要使用“我的技术支持”中的所有功能，必须先进行注册。

有关“我的技术支持”，敬请访问 Internet (<https://support.industry.siemens.com/My/ww/zh>)。

“我的技术支持” - 文档

在“我的技术支持”中的“文档”区域，用户可以使用整个手册或部分手册生成自己的手册。也可以将手册导出为 PDF 文件或后期可编辑的其它格式。

有关“我的技术支持” - 文档，敬请访问 Internet (<http://support.industry.siemens.com/My/ww/zh/documentation>)。

“我的技术支持” - CAx 数据

在“我的技术支持”中的 CAx 数据区域，可以访问 CAx 或 CAe 系统的最新产品数据。

仅需轻击几次，用户即可组态自己的下载包。

在此，用户可选择：

- 产品图片、二维码、3D 模型、内部电路图、EPLAN 宏文件
- 手册、功能特性、操作手册、证书
- 产品主数据

有关“我的技术支持” - CAx 数据，敬请访问 Internet

(<http://support.industry.siemens.com/my/ww/zh/CAxOnline>)。

应用示例

应用示例中包含有各种工具的技术支持和各种自动化任务应用示例。自动化系统中的多个组件完美协作，可组合成各种不同的解决方案，用户无需再关注各个单独的产品。

有关应用示例，敬请访问 Internet

(<https://support.industry.siemens.com/sc/ww/zh/sc/2054>)。

TIA Selection Tool

通过 TIA Selection Tool，用户可选择、组态和订购全集成自动化 (TIA) 中所需设备。

该工具是 SIMATIC Selection Tool 的新一代产品，在一个工具中完美集成了自动化技术的各种已知组态程序。

通过 TIA Selection Tool，用户可以根据产品选择或产品组态生成一个完整的订购列表。

有关 TIA Selection Tool，敬请访问 Internet

(<http://w3.siemens.com/mcms/topics/en/simatic/tia-selection-tool>)。

产品概述

2.1 特性

零件号:

6ES7521-7EH00-0AB0

模块视图



图 2-1 DI 16x24...125VUC HF 模块的视图

特性

该模块具有下列技术特性：

- 16 个数字量输入，按每组 1 个进行电气隔离
- 额定输入电压 24 V UC 到 125 V UC
- 可组态的诊断（按通道）
- 可组态的硬件中断（每个通道）
- 可编程输入延时（仅 DC）
- 适用于开关以及 2/3/4 线接近开关

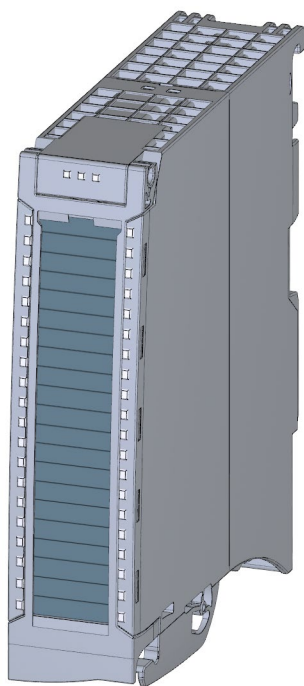
模块支持以下功能：

表格 2-1 模块功能与版本的相关性

功能	模块的固件版本	组态软件	
		STEP 7 (TIA Portal) V13 SP1 + HSP 0142 及以上版本	STEP 7 (TIA Portal) V12 及以上版本或 STEP 7 V5.5 SP3 及以上版本的 GSD 文件中
固件更新	V1.0.0 或更高版本	√	--- / √
标识数据 I&M0 到 I&M3	V1.0.0 或更高版本	√	√
RUN 模式下的参数分配	V1.0.0 或更高版本	√	√
模块内部 shared input (MSI)	V1.0.0 或更高版本	√ (仅限 PROFINET IO)	√ (仅限 PROFINET IO)
可组态子模块/Shared Device 子模块	V1.0.0 或更高版本	√ (仅限 PROFINET IO)	√ (仅限 PROFINET IO)

可通过 STEP 7 (TIA Portal) 和 GSD 文件组态模块。

附件

以下附件既可以随模块一起提供，也可以作为备件单独订购：

- 标签条
- U 型连接器
- 通用前盖板

其它组件

以下组件需单独订购：

前连接器，包括电位跳线和扎带

有关附件的更多信息，请参见系统手册《S7-1500/ET 200MP
(<http://support.automation.siemens.com/WW/view/zh/59191792>)》。

接线

3.1 接线图和方框图

下面介绍了模块的方框图以及各种连接方式。

有关前连接器的接线和铺设电缆屏蔽等信息，请参见系统手册《S7-1500/ET 200MP (<http://support.automation.siemens.com/WW/view/zh/59191792>)》中的“铺设屏蔽电缆”部分。

说明

请勿插入前连接器附带的电位跳线！

3.1 接线图和方框图

方框图和端子分配

下图显示了如何连接模块以及如何为通道分配地址（输入字节 a 和输入字节 b）。

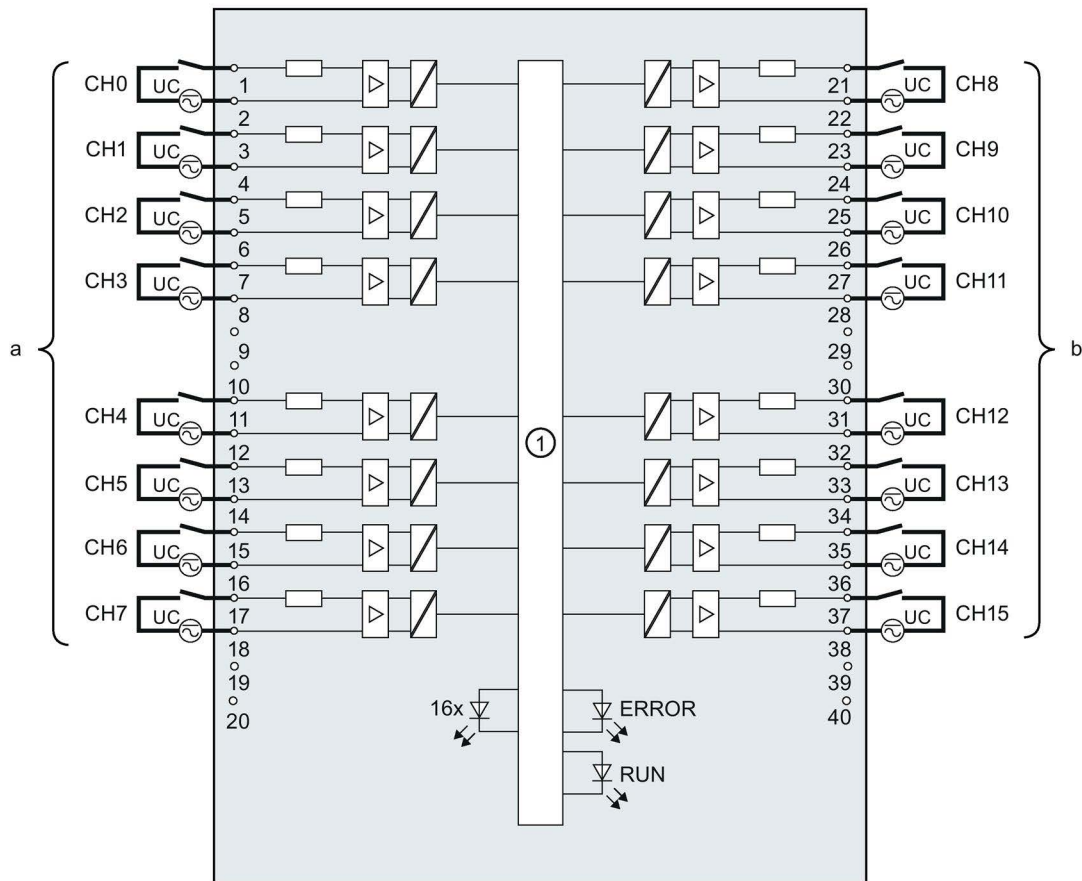

- ① 背板总线接口
- CHx 通道或通道状态 LED 指示灯（绿色/红色）
- RUN 状态 LED 指示灯（绿色）
- ERROR 错误 LED 指示灯（红色）

图 3-1 方框图和端子分配

编码器的电阻电路

要检测断路故障，必须有足够大的静态电流流过，甚至需要打开编码器触点。为此，需在编码器触点上连接一个电阻，见下图所示。

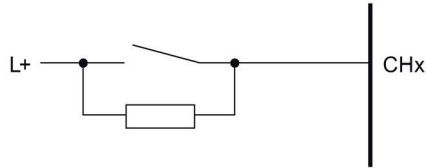

额定输入电压:	电阻:
24 VUC	16 k Ω 到 21 k Ω , 1.0 W
48 VUC	37 k Ω 到 53 k Ω , 0.5 W
125 VUC	101 k Ω 到 156 k Ω , 0.25 W

图 3-2 编码器的电阻电路

参数/地址空间

4.1 参数

DI 16x24...125VUC HF 参数

在 STEP 7 中指定模块参数时，可使用不同的参数来设置模块属性。下表列出了可组态的参数。可组态参数的有效范围取决于组态的类型。支持以下组态方式：

- 使用 S7-1500 CPU 进行统一操作
- 在 ET 200MP 系统中，通过 PROFINET IO 进行分布式操作
- 在 ET 200MP 系统中，通过 PROFIBUS DP 进行分布式操作

在用户程序中进行参数分配时，可通过 WRREC 指令（RUN 模式下的参数分配）和数据记录将这些参数传送到模块中；请参见章节 参数分配和参数数据记录的结构 (页 35)。

表格 4-1 可组态的参数及其默认值

参数	取值范围	默认设置	RUN 模式下的参数重新分配	组态软件（例如 STEP 7）的有效范围	
				集成在硬件目录中（STEP 7 V13 SP1 及更高版本）或 PROFINET IO GSD 文件中	PROFIBUS DP GSD 文件
诊断					
• 断路	√/-	-	√	通道	通道组 (CH0 到 CH7, CH8 到 CH15)
输入延时	0.05 ms、 0.1 ms、0.4 ms、 1.6 ms、3.2 ms、 12.8 ms、20 ms	<ul style="list-style-type: none"> • 20 ms • AC 时，固定值为 20 ms 	√	通道	通道组 (CH0 到 CH7, CH8 到 CH15)
硬件中断					
• 上升沿	√/-	-	√	通道	通道
• 下降沿	√/-	-	√	通道	通道
• 上升沿和下降沿	√/-	-	√	通道	通道

说明

AC 输入电压的输入延时

如果模块中正在操作的通道带有交流输入电压，则需将这些通道的输入延时设置为 20 ms。

如果设置其它输入延时，则输入信号可能发生错误变更且读取的值错误。

4.2 参数声明

断路

如果连接编码器的线路断路，则启用诊断。

输入延时

此参数可用于抑制信号中断。仅在信号更改的持续暂挂时间大于所设置的输入延时时间时，才能检测到该更改。

硬件中断

指定是否禁用硬件中断或触发硬件中断的事件。

- 上升沿
- 下降沿
- 上升沿和下降沿

4.3 地址空间

在 STEP 7 中，可采用不同方式对模块进行组态；具体设置，请见下表。根据组态的不同，将在输入的过程映像中另外指定地址或指定不同地址。

模块上印有字母“a”和“b”。例如，“IB a”是指模块起始地址输入字节 x。

DI 16x24...125VUC HF 的组态方式

可通过 STEP 7 (TIA Portal) 或 GSD 文件组态模块。

使用 GSD 文件组态模块时，可使用不同的缩写/模块名来表示组态。

可进行以下组态：

表格 4-2 组态方式

组态	GSD 文件中的简短标识 / 模块名	组态软件，如 STEP 7 (TIA Portal)	
		集成在硬件目录 STEP 7 (TIA Portal) V13 SP1 + HSP 0142 及更高版本中	STEP 7 (TIA Portal) V12 或更高 版本/STEP 7 V5.5 SP3 或更高版本中的 GSD 文 件
1 x 16 通道（不带值状态）	DI 16x24...125VUC HF	√	√
1 x 16 通道（带值状态）	DI 16x24...125VUC HF QI	√	√
2 x 8 通道（不带值状态）	DI 16x24...125VUC HF S	√ (仅限 PROFINET IO)	√ (仅限 PROFINET IO)
2 x 8 通道（带值状态）	DI 16x24...125VUC HF S QI	√ (仅限 PROFINET IO)	√ (仅限 PROFINET IO)
1 x 16 通道（带最多 4 个子模 块中模块内部共享输入的值状 态）	DI 16x24...125VUC HF MSI	√ (仅限 PROFINET IO)	√ (仅限 PROFINET IO)

4.3 地址空间

值状态 (Quality Information, QI)

以下模块的值状态始终为激活状态:

- DI 16x24...125VUC HF QI,
- DI 16x24...125VUC HF S QI
- DI 16x24...125VUC HF MSI

系统将为每个通道的值状态指定一个附加位。通过值状态位，可指示所读取的数字值是否有效。(0 = 值不正确)。

组态为 16 通道 DI 16x24...125VUC HF QI 的地址空间

下图显示了组态为带值状态的 16 通道模块的地址空间分配。其中，模块的起始地址可任意指定。各通道的地址将从该起始地址开始分配。



图 4-1 组态为 16 通道 DI 16x24...125VUC HF QI 的地址空间 (带值状态)

组态为 2 x 8 通道 DI 16x24...125VUC HF S QI 的地址空间

组态为 2 x 8 通道模块时，模块的通道应分为多个子模块。在共享设备中使用该模块时，可将子模块分配给不同的 IO 控制器。

可用的子模块数量取决于所使用的接口模块。请遵循本手册中有关特定接口模块的信息。

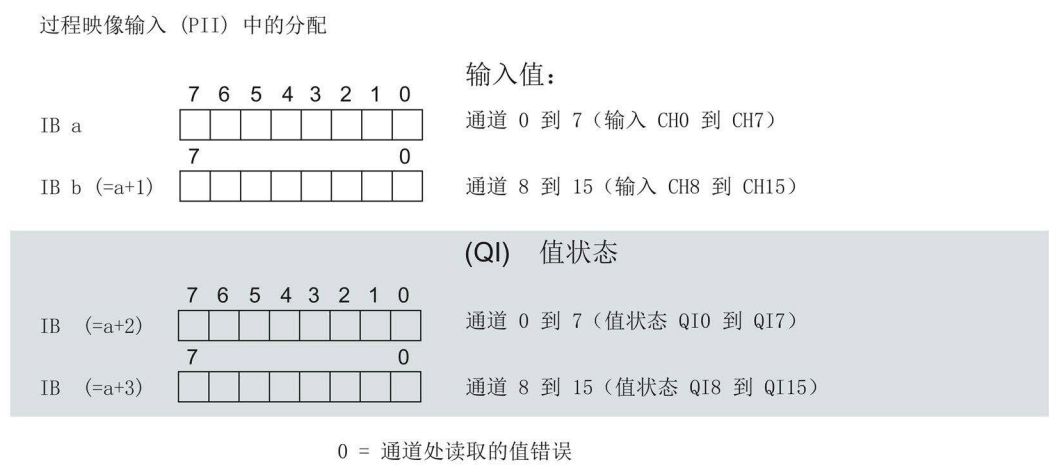
与 1 x 16 通道模块组态不同，这 2 个子模块都可任意指定起始地址。



图 4-2 组态为 2 x 8 通道 DI 16x24...125VUC HF S QI 的地址空间

组态为 1 x 16 通道 DI 16x24...125VUC HF MSI 的地址空间

组态 1 x 16 通道模块（模块内部共享输入，MSI）时，可在最多 4 个子模块中复制模块的通道 0 到 15。之后，在各个子模块中通道 0 到 15 的输入值都将相同。在共享设备中使用该模块时，可将这些子模块分配给最多 4 个 IO 控制器。而每个 IO 控制器都对这些通道具有读访问权限。

IO 控制器数量取决于所使用的接口模块。请遵循本手册中有关特定接口模块的信息。

值状态 (Quality Information, QI)

值状态的含义取决于各自的子模块。

对于第一个子模块（基本子模块），值状态为 0 表示值不正确。

对于第二到第四个子模块（MSI 子模块），值状态为 0 表示值不正确或基本子模块尚未组态（未就绪）。

4.3 地址空间

下图显示了子模块 1 和 2 的地址空间分配和值状态。

第 1 个和第 2 个子模块上过程映像输入 (PII) 中的分配



图 4-3 组态为 1 x 16 通道 DI 16x24...125VUC HF MSI 的地址空间

下图显示了子模块 3 和 4 的地址空间分配和值状态。

第 3 个和第 4 个子模块上过程映像输入 (PII) 中的分配

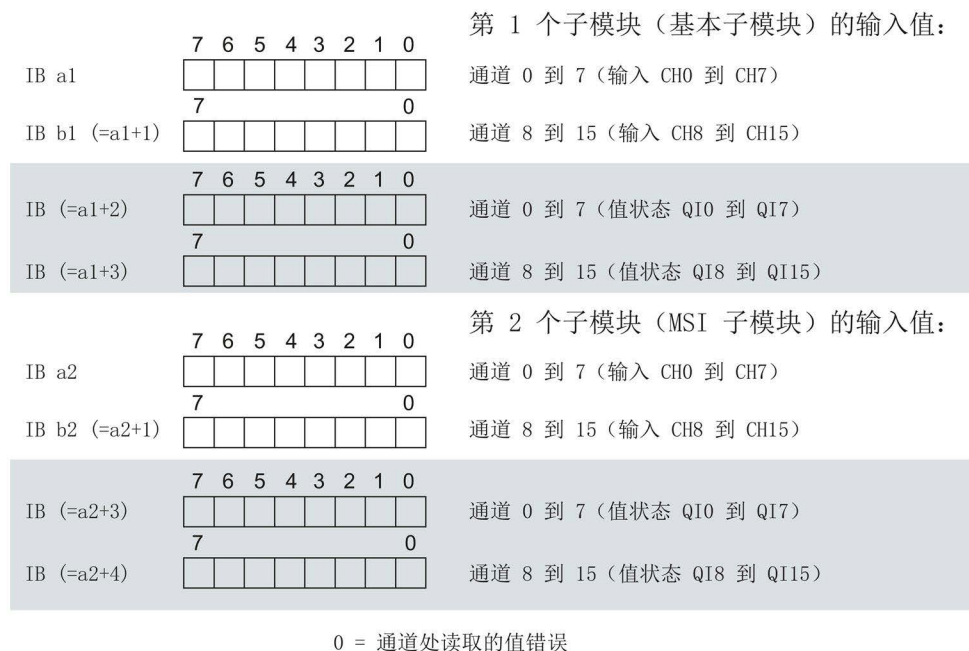

图 4-4 组态为 1 x 16 通道 DI 16x24...125VUC HF MSI 的地址空间

参考

有关模块内部共享输入/共享输出 (MSI/MSO) 功能的信息, 请参见《使用 STEP 7 V13 组态 PROFINET (<https://support.industry.siemens.com/cs/cn/zh/view/49948856>)》手册中的“模块内部共享输入/共享输出 (MSI/MSO)”部分。

中断/诊断报警

5.1 状态和错误指示灯

LED 指示灯

下图为模块的 LED 指示灯（状态和错误指示灯）。



图 5-1 DI 16x24...125VUC HF 模块的 LED 指示灯

LED 指示灯的含义

下表说明了状态和错误指示灯的含义。

LED RUN/ERROR

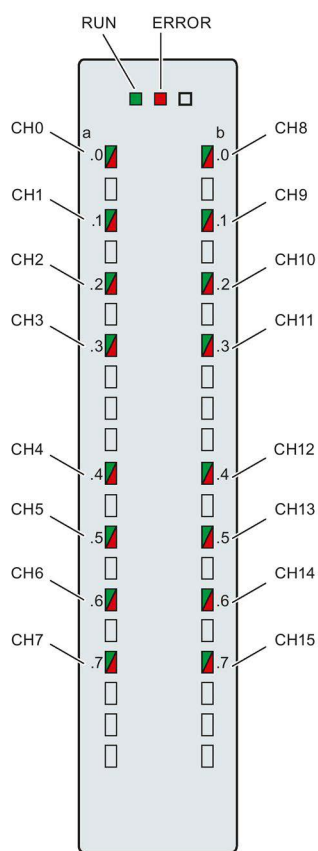
表格 5-1 RUN/ERROR 状态和错误指示灯

LED		含义	解决方法
RUN	ERROR		
□ 灭	□ 灭	背板总线上电压缺失或过低。	<ul style="list-style-type: none"> • 接通 CPU 和/或系统电源模块。 • 验证是否插入了 U 型连接器。 • 检查是否插入了过多的模块。
⚡ 闪烁	□ 灭	模块启动并在设置有效参数分配之前一直闪烁。	---
■ 亮	□ 灭	模块准备就绪。	
■ 亮	⚡ 闪烁	表示模块错误（至少一个通道上存在故障，如断路）。	判断诊断数据并消除该错误（如，断路）。
⚡ 闪烁	⚡ 闪烁	硬件缺陷。	更换模块。

LED CHx

表格 5-2 CHx 的状态指示灯

LED CHx	含义	解决方法
□ 灭	0 = 输入信号的状态。	---
■ 亮	1 = 输入信号的状态。	---
■ 亮	诊断：断路或硬件中断丢失	检查接线。使用简单开关输入时，可以禁用诊断或在编码器触点上接线一个电阻。

5.2 中断

数字量输入模块 DI 16x24...125VUC HF 支持诊断和硬件中断。

有关错误事件的详细信息，请参见指令“RALRM”（读取其它中断信息）的硬件中断、硬件中断组织块以及 STEP 7 在线帮助。

诊断中断

在发生以下事件时，该模块将生成诊断中断：

- 断路
- 参数分配错误
- 硬件中断丢失

硬件中断

在发生以下事件时，该模块将生成硬件中断：

- 上升沿
- 下降沿
- 上升沿和下降沿

触发硬件中断的模块通道记录在组织块的起始信息中。下图显示了本地数据中地址为 8 的双字的各个位的分配。



图 5-2 组织块的启动信息

附加中断信息的结构

表格 5-3 USI 结构 = W#16#0001

数据块名称	内容	注释	字节
USI (用户结构标识符)	W#16#0001	I/O 模块硬件中断的附加中断信息	2
触发硬件中断的通道紧随其后。			
通道	B#16#00 到 B#16#0F	事件触发型通道的数量 (模块的通道 0 到通道 15)	1
跟随在触发硬件中断的错误事件后。			
事件	B#16#01	上升沿	1
	B#16#02	下降沿	

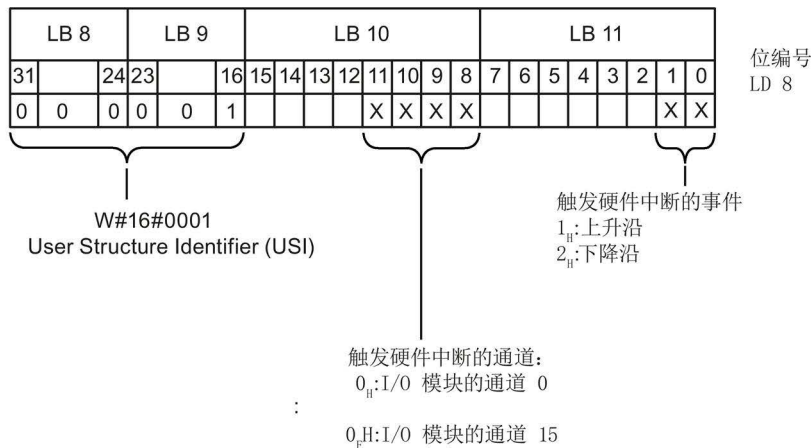
5.3 诊断报警

诊断报警

为模块上的每个诊断事件生成一个诊断报警，同时 **ERROR LED** 指示灯闪烁。例如，可在 **CPU** 的诊断缓冲区中读取诊断报警。并通过用户程序评估该错误代码。

如果在 **ET 200MP** 系统中通过 **PROFIBUS DP** 对模块进行分布式操作，则可使用指令 **RDREC** 或 **RD_REC** 通过数据记录 0 和 1 读取诊断数据。有关数据记录结构，请参见 Internet 上的《接口模块 **IM 155-5 DP ST (6ES7155-5BA00-0AB0)** 手册》。

表格 5-4 诊断报警、含义以及更正措施

诊断报警	错误代码	含义	更正措施
断路	6H	编码器电路的阻抗过高	使用其它型号的编码器或更改接线方式，例如，使用横截面积较大的电缆
		模块与传感器之间断路	连接电缆
		通道未连接（断开）	<ul style="list-style-type: none"> • 禁用诊断 • 在编码器触点上接线电阻： <ul style="list-style-type: none"> – 24 VUC 且 1.0 W 时，16 kΩ 到 21 kΩ – 48 VUC 且 0.5 W 时，37 kΩ 到 53 kΩ – 125 VUC 且 0.25 W 时，101 kΩ 到 156 kΩ
参数分配错误	10H	<ul style="list-style-type: none"> • 模块无法评估通道参数 • 参数分配错误 	更正参数分配
硬件中断丢失	16H	由于之前的中断尚未确认，因此模块无法触发中断；可能是由于组态错误	更改 CPU 中的中断处理，并在必要时编辑模块参数（模块分配新参数后，该错误才会消失）。

DI 16x24...125VUC HF 的技术规范

	6ES7521-7EH00-0AB0
常规信息	
产品型号标识	DI 16x24 ... 125VUC HF
硬件功能状态	FS01
固件版本	V1.0.0
产品功能	
I&M 数据	√: (I&M0 到 I&M3)
工程组态方式	
TIA Portal 中 STEP 7 可组态的版本/可集成的版本 (或更高版本)	V13 SP1 / -
STEP 7 可组态的版本/可集成的版本 (或更高版本)	V5.5 SP3 / -
支持 PROFIBUS 的最低 GSD 版本/GSD 修订版	V1.0 / V5.1
支持 PROFINET 的最低 GSD 版本/GSD 修订版	V2.3 / -
操作模式	
DI	√
MSI	√
功率	
背板总线上的功耗	1.2 W
数字量输入	
输入数量	16
数字量输入, 可组态	√
漏型/源型输入	√; 读取 p
输入特性曲线符合 IEC 61131, 类型 3	√; 24 V DC 时

6ES7521-7EH00-0AB0	
输入电压	
输入电压的类型	AC/DC
直流额定电压	24 V; 48 V、125 V
额定交流电压	24 V; 48V, 125 V (50 到 60 Hz)
信号“0”	-5 到 +5 V
信号“1”	+11 V DC 到 +146 V DC
输入电流	
信号“1”，典型值	3 mA; 24 V DC 时
输入延时（在输入额定电压时）	
标准输入	
<ul style="list-style-type: none"> • 可组态 	√; 直流电压: 0.05 / 0.1 / 0.4 / 1.6 / 3.2 / 12.8 / 20 ms; 交流电压: 20 ms 固定值
<ul style="list-style-type: none"> • 从“0”到“1”时的最短时间 	0.05 ms
<ul style="list-style-type: none"> • 从“0”到“1”时的最长时间 	20 ms
<ul style="list-style-type: none"> • 从“1”到“0”时的最短时间 	0.05 ms
<ul style="list-style-type: none"> • 从“1”到“0”时的最长时间 	20 ms
中断输入	
<ul style="list-style-type: none"> • 可组态 	√
电缆长度	
最大屏蔽电缆长度	1000 m
最大非屏蔽电缆长度	600 m
编码器	
可连接的编码器	
2 线制传感器	√
<ul style="list-style-type: none"> • 允许的最大静态电流（2 线制传感器） 	1.5 mA
中断/诊断/状态信息	
中断	
诊断中断	√
硬件中断	√

6ES7521-7EH00-0AB0	
诊断报警	
诊断	√
断路	√, I < 550 μA 时
短路	-
熔断器熔断	-
诊断 LED 指示灯	
RUN LED 指示灯	√; 绿色 LED 指示灯
ERROR LED 指示灯	√; 红色 LED 指示灯
电源电压监视 (PWR LED)	-
通道状态指示灯	√; 绿色 LED 指示灯
通道诊断	√; 红色 LED 指示灯
模块诊断	√; 红色 LED 指示灯
电气隔离	
通道的电气隔离	
通道之间	√
通道之间, 每组个数	1
通道与背板总线之间	√
允许的电位差	
不同电路之间	146 V DC / 132 V AC
绝缘	
绝缘测试	1200 V DC
环境条件	
运行时的环境温度	
水平安装时的最低温度	0 °C
水平安装时的最高温度	60 °C
垂直安装时的最低温度	0 °C
垂直安装时的最高温度	40 °C
分布式模式	
优先化启动	√

6ES7521-7EH00-0AB0	
尺寸	
宽	35 mm
高	147 mm
深	129 mm
重量	
约重	240 g

各模块安装位置和环境温度与功率降低（减额）的关系

下图显示了 S7-1500/ET 200MP 自动化系统在不同安装位置和环境温度下可同时使用的通道数量 (CHx)。



图 6-1 每个模块中可同时使用的通道数量：

尺寸图

A

A.1 尺寸图

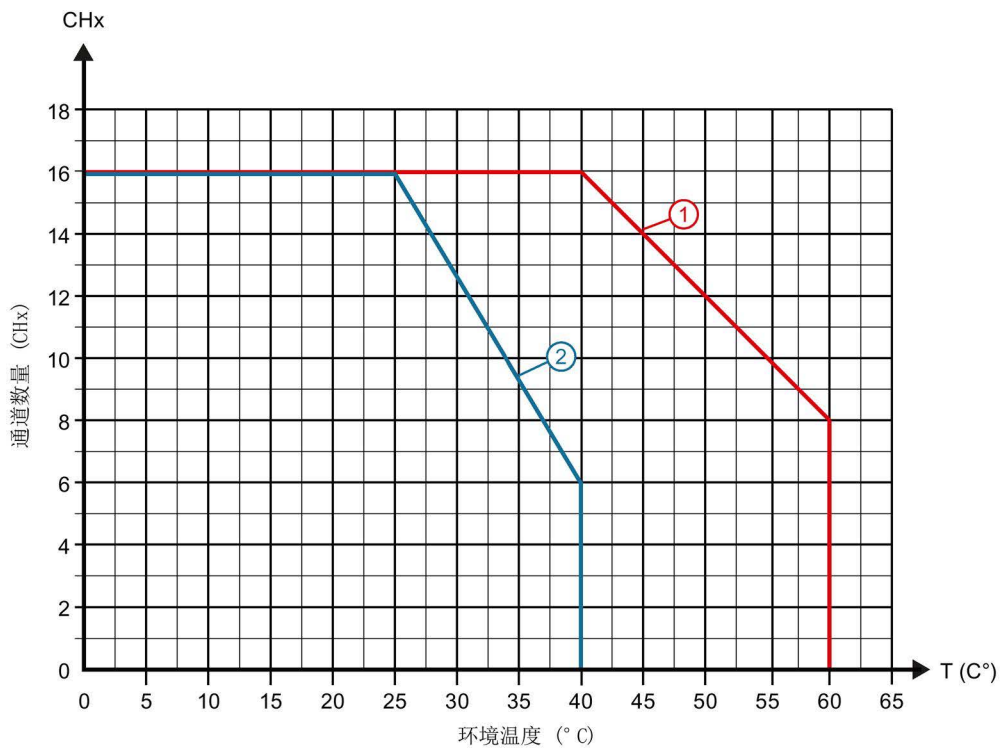
在附录中提供模块在安装轨道上的尺寸图，以及带开放式前盖的尺寸图。在控制柜、控制室等位置中安装时，请务必遵循具体的尺寸要求。



图 A-1 DI 16x24...125VUC HF 模块的尺寸图



图 A-2 DI 16x24...125VUC HF 模块的尺寸图，前盖板打开时的侧视图

参数数据记录

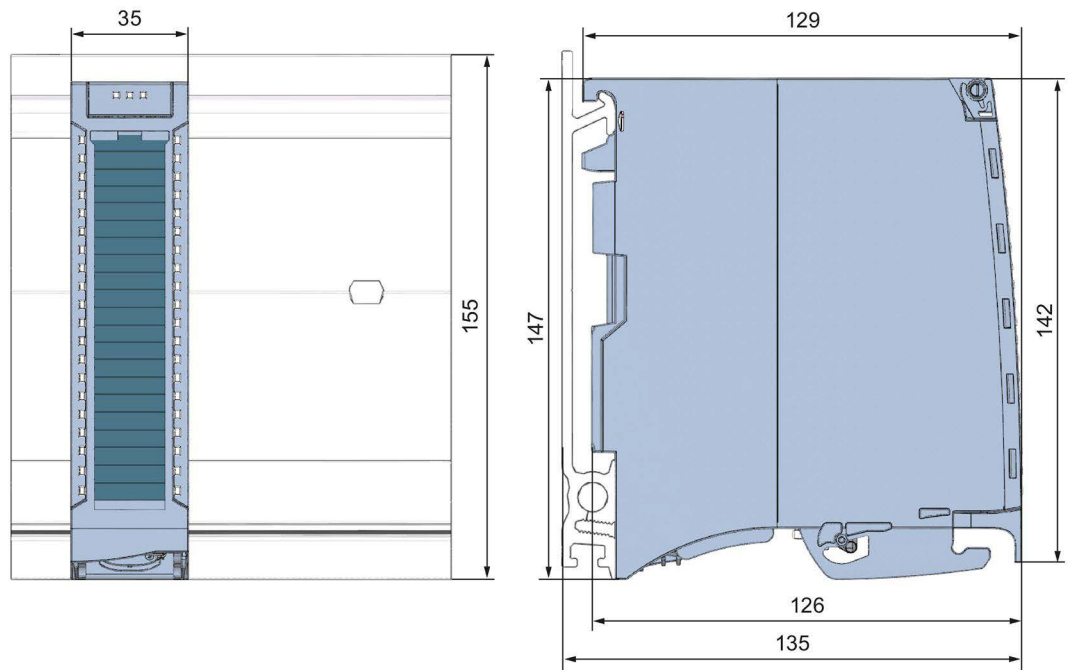
B.1 参数分配和参数数据记录的结构

该模块的数据记录结构相同，与通过 PROFIBUS DP 或 PROFINET IO 组态模块无关。

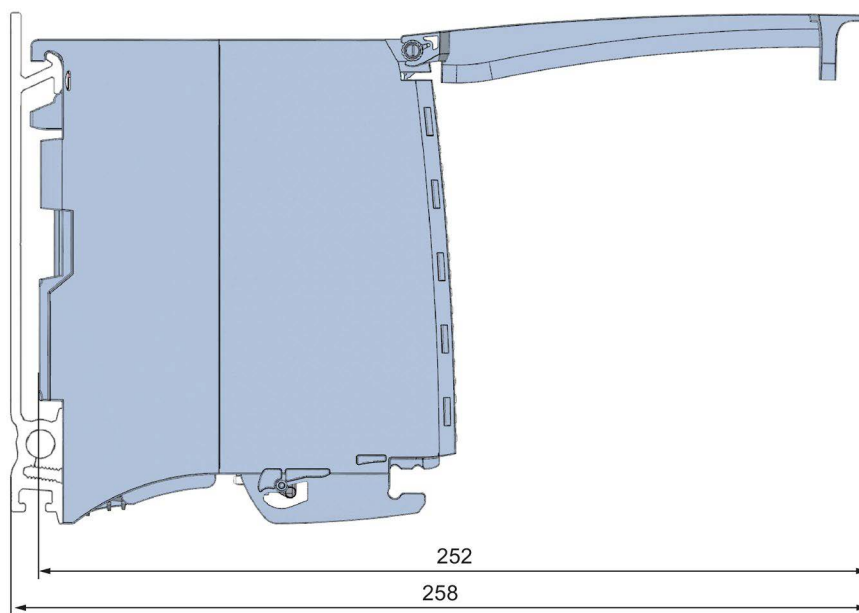
GSD 文件与组态的相关性

使用 GSD 文件组态模块时，在进行“分配参数”时将采用 GSD 文件中数据。

但与该模块没有相关性。可按不同的组合形式进行参数分配。

用户程序中的参数分配

在 RUN 模式下，可以对模块进行重新组态（例如，可以对所选通道的输入延时值进行编辑，而不影响其它通道）

RUN 模式下的参数分配

WRREC 指令用于通过数据记录 0 到 15 将参数传送到模块。STEP 7 中设置的参数在 CPU 中保持不变。即，STEP 7 中设置的参数在重新启动后仍然有效。

在传送后，模块仅对参数进行真实性检查。

输出参数 STATUS

该模块将忽略 WRREC 指令在传输参数过程中发生的错误，并继续使用之前分配的参数进行操作。但会将相应的错误代码写入 STATUS 输出参数中。

有关 WRREC 指令的说明和错误代码，请参见 STEP 7 在线帮助。

PROFIBUS DP 接口模块后的模块操作

如果操作 PROFIBUS DP 接口模块后面的模块，则系统不会回读参数数据记录 0 和 1。通过回读参数数据记录 0 和 1，可获得诊断数据记录 0 和 1。更多信息，请参见 Internet 上 PROFIBUS DP 接口模块设备手册的“中断”部分。

B.2 参数数据记录的结构

数据记录和通道的分配

组态为 1 x 16 通道模块时，参数将位于数据记录 0 到 15 中，并进行如下分配：

- 数据记录 0 对应通道 0
- 数据记录 1 对应通道 1
- ...
- 数据记录 14 对应通道 14
- 数据记录 15 对应通道 15

组态为 4 x 8 通道模块时，该模块带有 4 个子模块且每一个子模块 8 个通道。通道参数将分别位于数据记录 0 到 7 中，具体分配如下所示：

- 数据记录 0 到 7 对应通道 0 到 7（子模块 1）
- 数据记录 8 到 15 对应通道 8 到 15（子模块 2）

进行数据记录传输时，将寻址相应的子模块。

数据记录的结构

下图举例说明了通道 0 中数据记录 0 的结构。通道 1 到 15 的结构相同。字节 0 和字节 1 中的值为固定值，不可更改。

通过将相应位设置为“1”，可启用该参数。

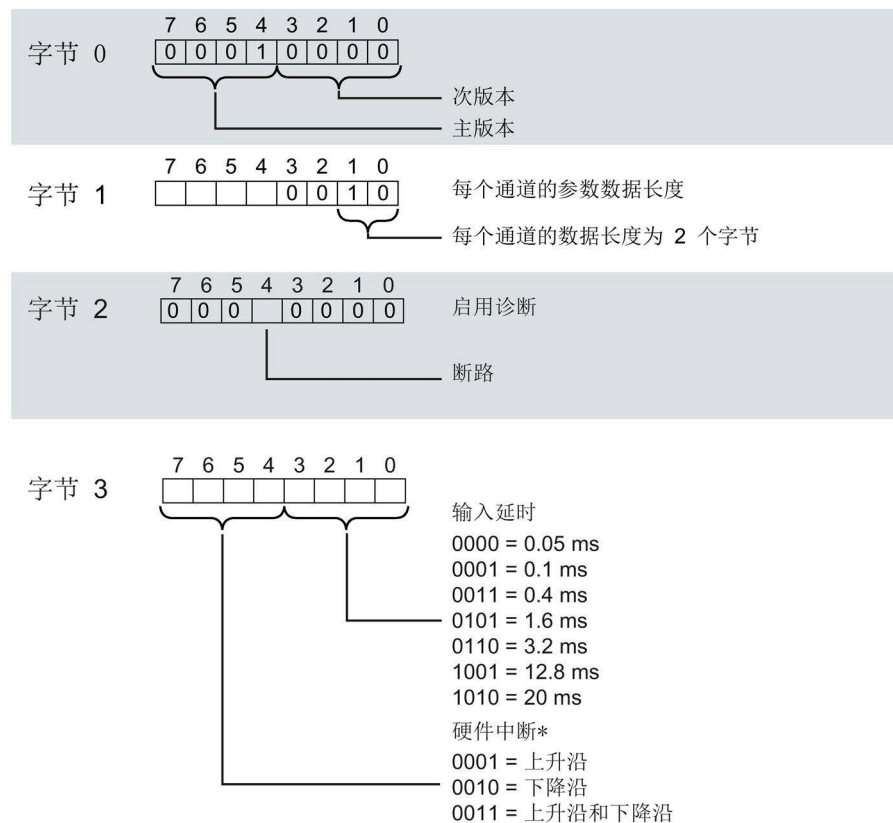

* 仅在 STEP 7 中为通道分配了硬件中断 OB 时，才能通过数据记录启用硬件中断

图 B-1 数据记录 0 的结构：字节 0 到 3

Open Source Software

C.1 开源软件

适用于经销商：为避免经销商或买方违反许可条件，须将此说明和许可条件提供给买方。

开源软件及其它已授权软件的许可条件和免责声明

在产品“Digital Modules, Analog Modules, Technological Modules, Communication Modules and Power Supply Modules of the SIMATIC S7-1500, ET 200MP”版权所有 Siemens AG, 2013 - 2014（以下称为“产品”）中，对开源软件及下面提到的其它授权软件，应以其原模式或经我方修改的模式使用。

对开源软件承担的责任

“开源软件”免费提供。我们将按照适用于“产品”的许可条件对“产品”以及其中所包含的“开源软件”承担责任，但明确排除未按产品专用流程使用“开源软件”的一切责任。

“产品”一旦被修改，我们将不再提供任何技术支持。

请仔细阅读开源软件和其它已授权软件的许可条件和版权提示：

Component	Open Source Software [Yes/No]	Acknowledgements	Copyright Information / File
Dinkumware C/C++ Library - 5.01	NO		LICENSE AND COPYRIGHT INFORMATION FOR COMPONENT DINKUMWARE C/C++ LIBRARY - 5.01
GNU GCC libgcc - 4.3.2	YES		LICENSE AND COPYRIGHT INFORMATION FOR COMPONENT GNU GCC LIBGCC - 4.3.2
GNU GCC libstdc++ / libsupc++ - 4.3.2	YES		LICENSE AND COPYRIGHT INFORMATION FOR COMPONENT GNU GCC LIBSTDC++ / LIBSUPC++ - 4.3.2

LICENSE CONDITIONS AND COPYRIGHT NOTICES

Commercial Software: Dinkumware C/C++ Library - 5.01

Enclosed you'll find the license conditions and copyright notices applicable for Commercial Software Dinkumware C/C++ Library - 5.01

License conditions:

Copyright (c) 1991-1999 Unicode, Inc. All Rights reserved.
This file is provided as-is by Unicode, Inc. (The Unicode Consortium). No claims are made as to fitness for any particular purpose. No warranties of any kind are expressed or implied. The recipient agrees to determine applicability of information provided. If this file has been provided on optical media by Unicode, Inc., the sole remedy for any claim will be exchange of defective media within 90 days of receipt. Unicode, Inc. hereby grants the right to freely use the information supplied in this file in the creation of products supporting the Unicode Standard, and to make copies of this file in any form for internal or external distribution as long as this notice remains attached.

© Copyright William E. Kempf 2001 Permission to use, copy, modify, distribute and sell this software and its documentation for any purpose is hereby granted without fee, provided that the above copyright notice appear in all copies and that both that copyright notice and this permission notice appear in supporting documentation. William E. Kempf makes no representations about the suitability of this software for any purpose. It is provided "as is" without express or implied warranty.

Copyright © 1994 Hewlett-Packard Company Permission to use, copy, modify, distribute and sell this software and its documentation for any purpose is hereby granted without fee, provided that the above copyright notice appear in all copies and that both that copyright notice and this permission notice appear in supporting documentation. Hewlett-Packard Company makes no representations about the suitability of this software for any purpose. It is provided "as is" without express or implied warranty.

Copyrights:

Copyright 1992 - 2006 by p.j. plauger and jim brodie. all rights reserved.

Copyright 1992-2006 by p.j. plauger. all rights reserved.ip

Copyright 1992-2006 by p.j. plauger. portions derived from work copyright 1994 by hewlettpackard company. all rights reserved

Copyright 1992-2006 by dinkumware, ltd. all rights reserved

Copyright 1992-2006 by dinkumware, ltd. portions derived from work copyright 2001 by william e. kempf. all rights reserved

Copyright 1994 hewlettpackard company

Copyright 1994 by hewlettpackard company

Copyright william e. kempf 2001

Copyright 1989-2006 by p.j. plauger. all rights reserved

Copyright (c) by p.j. plauger. all rights reserved.

Copyright (c) by dinkumware, ltd. all rights reserved.

Copyright (c) unicode, inc. all rights reserved.

(c) Copyright william e. kempf 2001

Copyright (c) hewlettpackard company

Copyright (c) by p.j. plauger. all rights reserved.

Copyright 2006 by dinkumware, ltd.

copyright (c) by p.j. plauger, licensed by dinkumware, ltd. all rights reserved.

the dinkum cec++ library reference is copyright (c) by p.j. plauger. this code is protected by copyright. all rights reserved.

the dinkum cc++ library reference is copyright (c) by p.j. plauger. this code is protected by copyright. all rights reserved.

dinkum compleat library, vc++ package (vc++ compilers only) the dinkum compleat library and the dinkum compleat library reference are copyright (c) by p.j. plauger. all rights reserved.

LICENSE CONDITIONS AND COPYRIGHT NOTICES

Open Source Software: GNU GCC libgcc - 4.3.2

Enclosed you'll find the license conditions and copyright notices applicable for Open Source Software GNU GCC libgcc - 4.3.2

License conditions:

GCC is free software; you can redistribute it and/or modify it under the terms of the GNU General Public License as published by the Free Software Foundation; either version 2, or (at your option) any later version.

In addition to the permissions in the GNU General Public License, the Free Software Foundation gives you unlimited permission to link the compiled version of this file into combinations with other programs, and to distribute those combinations without any restriction coming from the use of this file. (The General Public License restrictions do apply in other respects; for example, they cover modification of the file, and distribution when not linked into a combine executable.)

GCC is distributed in the hope that it will be useful, but WITHOUT ANY WARRANTY; without even the implied warranty of MERCHANTABILITY or FITNESS FOR A PARTICULAR PURPOSE. See the GNU General Public License for more details

You should have received a copy of the GNU General Public License along with GCC; see the file COPYING. If not, write to the Free Software Foundation, 51 Franklin Street, Fifth Floor, Boston, MA

GNU GENERAL PUBLIC LICENSE
Version 2, June 1991

Copyright (C) 1989, 1991 Free Software Foundation, Inc.

59 Temple Place, Suite 330, Boston, MA 02111-1307 USA

Everyone is permitted to copy and distribute verbatim copies of this license document, but changing it is not allowed.

Preamble

The licenses for most software are designed to take away your freedom to share and change it. By contrast, the GNU General Public License is intended to guarantee your freedom to share and change free software--to make sure the software is free for all its users. This General Public License applies to most of the Free Software Foundation's software and to any other program whose authors commit to using it. (Some other Free Software Foundation software is covered by the GNU Library General Public License instead.) You can apply it to your programs, too.

When we speak of free software, we are referring to freedom, not price. Our General Public Licenses are designed to make sure that you have the freedom to distribute copies of free software (and charge for this service if you wish), that you receive source code or can get it if you want it, that you can change the software or use pieces of it in new free programs; and that you know you can do these things.

To protect your rights, we need to make restrictions that forbid anyone to deny you these rights or to ask you to surrender the rights. These restrictions translate to certain responsibilities for you if you distribute copies of the software, or if you modify it.

For example, if you distribute copies of such a program, whether gratis or for a fee, you must give the recipients all the rights that you have. You must make sure that they, too, receive or can get the source code. And you must show them these terms so they know their rights.

We protect your rights with two steps: (1) copyright the software, and (2) offer you this license which gives you legal permission to copy, distribute and/or modify the software.

C.1 开源软件

Also, for each author's protection and ours, we want to make certain that everyone understands that there is no warranty for this free software. If the software is modified by someone else and passed on, we want its recipients to know that what they have is not the original, so that any problems introduced by others will not reflect on the original authors' reputations.

Finally, any free program is threatened constantly by software patents. We wish to avoid the danger that redistributors of a free program will individually obtain patent licenses, in effect making the program proprietary. To prevent this, we have made it clear that any patent must be licensed for everyone's free use or not licensed at all.

The precise terms and conditions for copying, distribution and modification follow.

GNU GENERAL PUBLIC LICENSE TERMS AND CONDITIONS FOR COPYING, DISTRIBUTION AND MODIFICATION

0. This License applies to any program or other work which contains a notice placed by the copyright holder saying it may be distributed under the terms of this General Public License. The "Program", below, refers to any such program or work, and a "work based on the Program" means either the Program or any derivative work under copyright law: that is to say, a work containing the Program or a portion of it, either verbatim or with modifications and/or translated into another language. (Hereinafter, translation is included without limitation in the term "modification".) Each licensee is addressed as "you".

Activities other than copying, distribution and modification are not covered by this License; they are outside its scope. The act of running the Program is not restricted, and the output from the Program is covered only if its contents constitute a work based on the Program (independent of having been made by running the Program). Whether that is true depends on what the Program does.

1. You may copy and distribute verbatim copies of the Program's source code as you receive it, in any medium, provided that you conspicuously and appropriately publish on each copy an appropriate copyright notice and disclaimer of warranty; keep intact all the notices that refer to this License and to the absence of any warranty; and give any other recipients of the Program a copy of this License along with the Program.

You may charge a fee for the physical act of transferring a copy, and you may at your option offer warranty protection in exchange for a fee.

2. You may modify your copy or copies of the Program or any portion of it, thus forming a work based on the Program, and copy and distribute such modifications or work under the terms of Section 1 above, provided that you also meet all of these conditions:

a) You must cause the modified files to carry prominent notices stating that you changed the files and the date of any change.

b) You must cause any work that you distribute or publish, that in whole or in part contains or is derived from the Program or any part thereof, to be licensed as a whole at no charge to all third parties under the terms of this License.

c) If the modified program normally reads commands interactively when run, you must cause it, when started running for such interactive use in the most ordinary way, to print or display an announcement including an appropriate copyright notice and a notice that there is no warranty (or else, saying that you provide a warranty) and that users may redistribute the program under these conditions, and telling the user how to view a copy of this License. (Exception: if the Program itself is interactive but does not normally print such an announcement, your work based on the Program is not required to print an announcement.)

These requirements apply to the modified work as a whole. If identifiable sections of that work are not derived from the Program, and can be reasonably considered independent and separate works in themselves, then this License, and its terms, do not apply to those sections when you distribute them as separate works. But when you distribute the same sections as part of a whole which is a work based on the Program, the distribution of the whole must be on the terms of this License, whose permissions for other licensees extend to the entire whole, and thus to each and every part regardless of who wrote it.

Thus, it is not the intent of this section to claim rights or contest your rights to work written entirely by you; rather, the intent is to exercise the right to control the distribution of derivative or collective works based on the Program.

In addition, mere aggregation of another work not based on the Program with the Program (or with a work based on the Program) on a volume of a storage or distribution medium does not bring the other work under the scope of this License.

3. You may copy and distribute the Program (or a work based on it, under Section 2) in object code or executable form under the terms of Sections 1 and 2 above provided that you also do one of the following:

a) Accompany it with the complete corresponding machine-readable source code, which must be distributed under the terms of Sections 1 and 2 above on a medium customarily used for software interchange; or,

b) Accompany it with a written offer, valid for at least three years, to give any third party, for a charge no more than your cost of physically performing source distribution, a complete machine-readable copy of the corresponding source code, to be distributed under the terms of Sections 1 and 2 above on a medium customarily used for software interchange; or,

c) Accompany it with the information you received as to the offer to distribute corresponding source code. (This alternative is allowed only for noncommercial distribution and only if you received the program in object code or executable form with such an offer, in accord with Subsection b above.)

The source code for a work means the preferred form of the work for making modifications to it. For an executable work, complete source code means all the source code for all modules it contains, plus any associated interface definition files, plus the scripts used to control compilation and installation of the executable. However, as a special exception, the source code distributed need not include anything that is normally distributed (in either source or binary form) with the major components (compiler, kernel, and so on) of the operating system on which the executable runs, unless that component itself accompanies the executable.

If distribution of executable or object code is made by offering access to copy from a designated place, then offering equivalent access to copy the source code from the same place counts as distribution of the source code, even though third parties are not compelled to copy the source along with the object code.

4. You may not copy, modify, sublicense, or distribute the Program except as expressly provided under this License. Any attempt otherwise to copy, modify, sublicense or distribute the Program is void, and will automatically terminate your rights under this License. However, parties who have received copies, or rights, from you under this License will not have their licenses terminated so long as such parties remain in full compliance.

5. You are not required to accept this License, since you have not signed it. However, nothing else grants you permission to modify or distribute the Program or its derivative works. These actions are prohibited by law if you do not accept this License. Therefore, by modifying or distributing the Program (or any work based on the Program), you indicate your acceptance of this License to do so, and all its terms and conditions for copying, distributing or modifying the Program or works based on it.

6. Each time you redistribute the Program (or any work based on the Program), the recipient automatically receives a license from the original licensor to copy, distribute or modify the Program subject to these terms and conditions. You may not impose any further restrictions on the recipients' exercise of the rights granted herein. You are not responsible for enforcing compliance by third parties to this License.

7. If, as a consequence of a court judgment or allegation of patent infringement or for any other reason (not limited to patent issues), conditions are imposed on you (whether by court order, agreement or otherwise) that contradict the conditions of this License, they do not excuse you from the conditions of this License. If you cannot distribute so as to satisfy simultaneously your obligations under this License and any other pertinent obligations, then as a consequence you may not distribute the Program at all. For example, if a patent license would not permit royalty-free redistribution of the Program by all those who receive copies directly or indirectly through you, then the only way you could satisfy both it and this License would be to refrain entirely from distribution of the Program.

If any portion of this section is held invalid or unenforceable under any particular circumstance, the balance of the section is intended to apply and the section as a whole is intended to apply in other circumstances.

It is not the purpose of this section to induce you to infringe any patents or other property right claims or to contest validity of any such claims; this section has the sole purpose of protecting the integrity of the free software distribution system, which is implemented by public license practices.

Many people have made generous contributions to the wide range of software distributed through that system in reliance on consistent application of that system; it is up to the author/donor to decide if he or she is willing to distribute software through any other system and a licensee cannot impose that choice.

This section is intended to make thoroughly clear what is believed to be a consequence of the rest of this License.

8. If the distribution and/or use of the Program is restricted in certain countries either by patents or by copyrighted interfaces, the original copyright holder who places the Program under this License may add an explicit geographical distribution limitation excluding those countries, so that distribution is permitted only in or among countries not thus excluded. In such case, this License incorporates the limitation as if written in the body of this License.

9. The Free Software Foundation may publish revised and/or new versions of the General Public License from time to time. Such new versions will be similar in spirit to the present version, but may differ in detail to address new problems or concerns.

Each version is given a distinguishing version number. If the Program specifies a version number of this License which applies to it and "any later version", you have the option of following the terms and conditions either of that version or of any later version published by the Free Software Foundation. If the Program does not specify a version number of this License, you may choose any version ever published by the Free Software Foundation.

10. If you wish to incorporate parts of the Program into other free programs whose distribution conditions are different, write to the author to ask for permission. For software which is copyrighted by the Free Software Foundation, write to the Free Software Foundation; we sometimes make exceptions for this. Our decision will be guided by the two goals of preserving the free status of all derivatives of our free software and of promoting the sharing and reuse of software generally.

NO WARRANTY

11. BECAUSE THE PROGRAM IS LICENSED FREE OF CHARGE, THERE IS NO WARRANTY FOR THE PROGRAM, TO THE EXTENT PERMITTED BY APPLICABLE LAW. EXCEPT WHEN OTHERWISE STATED IN WRITING THE COPYRIGHT HOLDERS AND/OR OTHER PARTIES PROVIDE THE PROGRAM "AS IS" WITHOUT WARRANTY OF ANY KIND, EITHER EXPRESSED OR IMPLIED, INCLUDING, BUT NOT LIMITED TO, THE IMPLIED WARRANTIES OF MERCHANTABILITY AND FITNESS FOR A PARTICULAR PURPOSE. THE ENTIRE RISK AS TO THE QUALITY AND PERFORMANCE OF THE PROGRAM IS WITH YOU. SHOULD THE PROGRAM PROVE DEFECTIVE, YOU ASSUME THE COST OF ALL NECESSARY SERVICING, REPAIR OR CORRECTION.

12. IN NO EVENT UNLESS REQUIRED BY APPLICABLE LAW OR AGREED TO IN WRITING WILL ANY COPYRIGHT HOLDER, OR ANY OTHER PARTY WHO MAY MODIFY AND/OR REDISTRIBUTE THE PROGRAM AS PERMITTED ABOVE, BE LIABLE TO YOU FOR DAMAGES, INCLUDING ANY GENERAL, SPECIAL, INCIDENTAL OR CONSEQUENTIAL DAMAGES ARISING OUT OF THE USE OR INABILITY TO USE THE PROGRAM (INCLUDING BUT NOT LIMITED TO LOSS OF DATA OR DATA BEING RENDERED INACCURATE OR LOSSES SUSTAINED BY YOU OR THIRD PARTIES OR A FAILURE OF THE PROGRAM TO OPERATE WITH ANY OTHER PROGRAMS), EVEN IF SUCH HOLDER OR OTHER PARTY HAS BEEN ADVISED OF THE POSSIBILITY OF SUCH DAMAGES

END OF TERMS AND CONDITIONS

How to Apply These Terms to Your New Programs

If you develop a new program, and you want it to be of the greatest possible use to the public, the best way to achieve this is to make it free software which everyone can redistribute and change under these terms.

To do so, attach the following notices to the program. It is safest to attach them to the start of each source file to most effectively convey the exclusion of warranty; and each file should have at least the "copyright" line and a pointer to where the full notice is found. <one line to give the program's name and a brief idea of what it does.> Copyright (C) <year> <name of author>

This program is free software; you can redistribute it and/or modify it under the terms of the GNU General Public License as published by the Free Software Foundation; either version 2 of the License, or (at your option) any later version.

This program is distributed in the hope that it will be useful, but WITHOUT ANY WARRANTY; without even the implied warranty of MERCHANTABILITY or FITNESS FOR A PARTICULAR PURPOSE. See the GNU General Public License for more details.

You should have received a copy of the GNU General Public License along with this program; if not, write to the Free Software Foundation, Inc., 59 Temple Place, Suite 330, Boston, MA 02111-1307 USA

Also add information on how to contact you by electronic and paper mail.

If the program is interactive, make it output a short notice like this when it starts in an interactive mode:

Gnomovision version 69, Copyright (C) year name of author Gnomovision comes with ABSOLUTELY NO WARRANTY; for details type `show w'. This is free software, and you are welcome to redistribute it under certain conditions; type `show c' for details.

The hypothetical commands `show w' and `show c' should show the appropriate parts of the General Public License. Of course, the commands you use may be called something other than `show w' and `show c'; they could even be mouse-clicks or menu items--whatever suits your program.

You should also get your employer (if you work as a programmer) or your school, if any, to sign a "copyright disclaimer" for the program, if necessary. Here is a sample; alter the names:

Yoyodyne, Inc., hereby disclaims all copyright interest in the program `Gnomovision' (which makes passes at compilers) written by James Hacker.

<signature of Ty Coon>, 1 April 1989
Ty Coon, President of Vice

This General Public License does not permit incorporating your program into proprietary programs. If your program is a subroutine library, you may consider it more useful to permit linking proprietary applications with the library. If this is what you want to do, use the GNU Library General Public License instead of this License.

Copyrights:

Copyright (C) 2003 Free Software Foundation, Inc.

Copyright (C) 2005, 2006 Free Software Foundation

Copyright (C) 2007 Free Software Foundation, Inc.

Copyright 1997, 1998, 1999, 2000, 2001, 2002, 2003, 2004, 2005, 2006, 2007, # 2008 Free Software Foundation, Inc.

LICENSE CONDITIONS AND COPYRIGHT NOTICES

Open Source Software: GNU GCC libstdc++ / libsupc++ - 4.3.2
Enclosed you'll find the license conditions and copyright notices applicable for Open Source Software GNU GCC libstdc++ / libsupc++ - 4.3.2

License conditions:

GCC is free software; you can redistribute it and/or modify it under the terms of the GNU General Public License as published by the Free Software Foundation; either version 2, or (at your option) any later version.

GCC is distributed in the hope that it will be useful, but WITHOUT ANY WARRANTY; without even the implied warranty of MERCHANTABILITY or FITNESS FOR A PARTICULAR PURPOSE. See the GNU General Public License for more details. You should have received a copy of the GNU General Public License along with GCC; see the file COPYING. If not, write to the Free Software Foundation, 51 Franklin Street, Fifth Floor, Boston, MA 02110-1301, USA.

As a special exception, you may use this file as part of a free software library without restriction. Specifically, if other files instantiate templates or use macros or inline functions from this file, or you compile this file and link it with other files to produce an executable, this file does not by itself cause the resulting executable to be covered by the GNU General Public License. This exception does not however invalidate any other reasons why the executable file might be covered by the GNU General Public License.

This library is free software; you can redistribute it and/or modify it under the terms of the GNU General Public License as published by the Free Software Foundation; either version 2, or (at your option) any later version.

This library is distributed in the hope that it will be useful, but WITHOUT ANY WARRANTY; without even the implied warranty of MERCHANTABILITY or FITNESS FOR A PARTICULAR PURPOSE. See the GNU General Public License for more details.

You should have received a copy of the GNU General Public License along with this library; see the file COPYING. If not, write to the Free Software Foundation, 51 Franklin Street, Fifth Floor, Boston, MA 02110-1301, USA.

As a special exception, you may use this file as part of a free software library without restriction. Specifically, if other files instantiate templates or use macros or inline functions from this file, or you compile this file and link it with other files to produce an executable, this file does not by itself cause the resulting executable to be covered by the GNU General Public License. This exception does not however invalidate any other reasons why the executable file might be covered by the GNU General Public License.

This library is free software; you can redistribute it and/or modify it under the terms of the GNU General Public License as published by the Free Software Foundation; either version 2, or (at your option) any later version. This library is distributed in the hope that it will be useful, but WITHOUT ANY WARRANTY; without even the implied warranty of MERCHANTABILITY or FITNESS FOR A PARTICULAR PURPOSE. See the GNU General Public License for more details. You should have received a copy of the GNU General Public License along with this library; see the file COPYING. If not, write to the Free Software Foundation, 59 Temple Place - Suite 330, Boston, MA 02111-1307, USA.

As a special exception, you may use this file as part of a free software library without restriction. Specifically, if other files instantiate templates or use macros or inline functions from this file, or you compile this file and link it with other files to produce an executable, this file does not by itself cause the resulting executable to be covered by the GNU General Public License. This exception does not however invalidate any other reasons why the executable file might be covered by the GNU General Public License. ---

GNU GENERAL PUBLIC LICENSE Version 2, June 1991

Copyright (C) 1989, 1991 Free Software Foundation, Inc.

59 Temple Place, Suite 330, Boston, MA 02111-1307 USA

Everyone is permitted to copy and distribute verbatim copies of this license document, but changing it is not allowed.

Preamble

The licenses for most software are designed to take away your freedom to share and change it. By contrast, the GNU General Public License is intended to guarantee your freedom to share and change free software--to make sure the software is free for all its users. This General Public License applies to most of the Free Software Foundation's software and to any other program whose authors commit to using it. (Some other Free Software Foundation software is covered by the GNU Library General Public License instead.) You can apply it to your programs, too.

When we speak of free software, we are referring to freedom, not price. Our General Public Licenses are designed to make sure that you have the freedom to distribute copies of free software (and charge for this service if you wish), that you receive source code or can get it if you want it, that you can change the software or use pieces of it in new free programs; and that you know you can do these things.

To protect your rights, we need to make restrictions that forbid anyone to deny you these rights or to ask you to surrender the rights. These restrictions translate to certain responsibilities for you if you distribute copies of the software, or if you modify it.

For example, if you distribute copies of such a program, whether gratis or for a fee, you must give the recipients all the rights that you have. You must make sure that they, too, receive or can get the source code. And you must show them these terms so they know their rights. We protect your rights with two steps: (1) copyright the software, and (2) offer you this license which gives you legal permission to copy, distribute and/or modify the software.

Also, for each author's protection and ours, we want to make certain that everyone understands that there is no warranty for this free software. If the software is modified by someone else and passed on, we want its recipients to know that what they have is not the original, so that any problems introduced by others will not reflect on the original authors' reputations.

Finally, any free program is threatened constantly by software patents. We wish to avoid the danger that redistributors of a free program will individually obtain patent licenses, in effect making the program proprietary. To prevent this, we have made it clear that any patent must be licensed for everyone's free use or not licensed at all.

The precise terms and conditions for copying, distribution and modification follow.

GNU GENERAL PUBLIC LICENSE TERMS AND CONDITIONS FOR COPYING, DISTRIBUTION AND MODIFICATION

0. This License applies to any program or other work which contains a notice placed by the copyright holder saying it may be distributed under the terms of this General Public License. The "Program", below, refers to any such program or work, and a "work based on the Program" means either the Program or any derivative work under copyright law: that is to say, a work containing the Program or a portion of it, either verbatim or with modifications and/or translated into another language. (Hereinafter, translation is included without limitation in the term "modification".) Each licensee is addressed as "you".

Activities other than copying, distribution and modification are not covered by this License; they are outside its scope. The act of running the Program is not restricted, and the output from the Program is covered only if its contents constitute a work based on the Program (independent of having been made by running the Program). Whether that is true depends on what the Program does.

1. You may copy and distribute verbatim copies of the Program's source code as you receive it, in any medium, provided that you conspicuously and appropriately publish on each copy an appropriate copyright notice and disclaimer of warranty; keep intact all the notices that refer to this License and to the absence of any warranty; and give any other recipients of the Program a copy of this License along with the Program. You may charge a fee for the physical act of transferring a copy, and you may at your option offer warranty protection in exchange for a fee.

2. You may modify your copy or copies of the Program or any portion of it, thus forming a work based on the Program, and copy and distribute such modifications or work under the terms of Section 1 above, provided that you also meet all of these conditions:

a) You must cause the modified files to carry prominent notices stating that you changed the files and the date of any change.

b) You must cause any work that you distribute or publish, that in whole or in part contains or is derived from the Program or any part thereof, to be licensed as a whole at no charge to all third parties under the terms of this License.

c) If the modified program normally reads commands interactively when run, you must cause it, when started running for such interactive use in the most ordinary way, to print or display an announcement including an appropriate copyright notice and a notice that there is no warranty (or else, saying that you provide a warranty) and that users may redistribute the program under these conditions, and telling the user how to view a copy of this License. (Exception: if the Program itself is interactive but does not normally print such an announcement, your work based on the Program is not required to print an announcement.)

These requirements apply to the modified work as a whole. If identifiable sections of that work are not derived from the Program, and can be reasonably considered independent and separate works in themselves, then this License, and its terms, do not apply to those sections when you distribute them as separate works. But when you distribute the same sections as part of a whole which is a work based on the Program, the distribution of the whole must be on the terms of this License, whose permissions for other licensees extend to the entire whole, and thus to each and every part regardless of who wrote it.

Thus, it is not the intent of this section to claim rights or contest your rights to work written entirely by you; rather, the intent is to exercise the right to control the distribution of derivative or collective works based on the Program.

In addition, mere aggregation of another work not based on the Program with the Program (or with a work based on the Program) on a volume of a storage or distribution medium does not bring the other work under the scope of this License.

3. You may copy and distribute the Program (or a work based on it, under Section 2) in object code or executable form under the terms of Sections 1 and 2 above provided that you also do one of the following:

a) Accompany it with the complete corresponding machine-readable source code, which must be distributed under the terms of Sections 1 and 2 above on a medium customarily used for software interchange; or,

b) Accompany it with a written offer, valid for at least three years, to give any third party, for a charge no more than your cost of physically performing source code distribution, a complete machine-readable copy of the corresponding source code, to be distributed under the terms of Sections 1 and 2 above on a medium customarily used for software interchange; or,

c) Accompany it with the information you received as to the offer to distribute corresponding source code. (This alternative is allowed only for noncommercial distribution and only if you received the program in object code or executable form with such an offer, in accord with Subsection b above.)

The source code for a work means the preferred form of the work for making modifications to it. For an executable work, complete source code means all the source code for all modules it contains, plus any associated interface definition files, plus the scripts used to control compilation and installation of the executable. However, as a special exception, the source code distributed need not include anything that is normally distributed (in either source or binary form) with the major components (compiler, kernel, and so on) of the operating system on which the executable runs, unless that component itself accompanies the executable.

If distribution of executable or object code is made by offering access to copy from a designated place, then offering equivalent access to copy the source code from the same place counts as distribution of the source code, even though third parties are not compelled to copy the source along with the object code.

4. You may not copy, modify, sublicense, or distribute the Program except as expressly provided under this License. Any attempt otherwise to copy, modify, sublicense or distribute the Program is void, and will automatically terminate your rights under this License. However, parties who have received copies, or rights, from you under this License will not have their licenses terminated so long as such parties remain in full compliance.

5. You are not required to accept this License, since you have not signed it. However, nothing else grants you permission to modify or distribute the Program or its derivative works. These actions are prohibited by law if you do not accept this License. Therefore, by modifying or distributing the Program (or any work based on the Program), you indicate your acceptance of this License to do so, and all its terms and conditions for copying, distributing or modifying the Program or works based on it.

6. Each time you redistribute the Program (or any work based on the Program), the recipient automatically receives a license from the original licensor to copy, distribute or modify the Program subject to these terms and conditions. You may not impose any further restrictions on the recipients' exercise of the rights granted herein. You are not responsible for enforcing compliance by third parties to this License.

7. If, as a consequence of a court judgment or allegation of patent infringement or for any other reason (not limited to patent issues), conditions are imposed on you (whether by court order, agreement or otherwise) that contradict the conditions of this License, they do not excuse you from the conditions of this License. If you cannot distribute so as to satisfy simultaneously your obligations under this License and any other pertinent obligations, then as a consequence you may not distribute the Program at all. For example, if a patent license would not permit royalty-free redistribution of the Program by all those who receive copies directly or indirectly through you, then the only way you could satisfy both it and this License would be to refrain entirely from distribution of the Program.

If any portion of this section is held invalid or unenforceable under any particular circumstance, the balance of the section is intended to apply and the section as a whole is intended to apply in other circumstances.

It is not the purpose of this section to induce you to infringe any patents or other property right claims or to contest validity of any such claims; this section has the sole purpose of protecting the integrity of the free software distribution system, which is implemented by public license practices.

Many people have made generous contributions to the wide range of software distributed through that system in reliance on consistent application of that system; it is up to the author/donor to decide if he or she is willing to distribute software through any other system and a licensee cannot impose that choice.

This section is intended to make thoroughly clear what is believed to be a consequence of the rest of this License.

8. If the distribution and/or use of the Program is restricted in certain countries either by patents or by copyrighted interfaces, the original copyright holder who places the Program under this License may add an explicit geographical distribution limitation excluding those countries, so that distribution is permitted only in or among countries not thus excluded. In such case, this License incorporates the limitation as if written in the body of this License.

9. The Free Software Foundation may publish revised and/or new versions of the General Public License from time to time. Such new versions will be similar in spirit to the present version, but may differ in detail to address new problems or concerns.

Each version is given a distinguishing version number. If the Program specifies a version number of this License which applies to it and "any later version", you have the option of following the terms and conditions either of that version or of any later version published by the Free Software Foundation. If the Program does not specify a version number of this License, you may choose any version ever published by the Free Software Foundation.

10. If you wish to incorporate parts of the Program into other free programs whose distribution conditions are different, write to the author to ask for permission. For software which is copyrighted by the Free Software Foundation, write to the Free Software Foundation; we sometimes make exceptions for this. Our decision will be guided by the two goals of preserving the free status of all derivatives of our free software and of promoting the sharing and reuse of software generally.

NO WARRANTY

11. BECAUSE THE PROGRAM IS LICENSED FREE OF CHARGE, THERE IS NO WARRANTY FOR THE PROGRAM, TO THE EXTENT PERMITTED BY APPLICABLE LAW. EXCEPT WHEN OTHERWISE STATED IN WRITING THE COPYRIGHT HOLDERS AND/OR OTHER PARTIES PROVIDE THE PROGRAM "AS IS" WITHOUT WARRANTY OF ANY KIND, EITHER EXPRESSED OR IMPLIED, INCLUDING, BUT NOT LIMITED TO, THE IMPLIED WARRANTIES OF MERCHANTABILITY AND FITNESS FOR A PARTICULAR PURPOSE. THE ENTIRE RISK AS TO THE QUALITY AND PERFORMANCE OF THE PROGRAM IS WITH YOU. SHOULD THE PROGRAM PROVE DEFECTIVE, YOU ASSUME THE COST OF ALL NECESSARY SERVICING, REPAIR OR CORRECTION.

12. IN NO EVENT UNLESS REQUIRED BY APPLICABLE LAW OR AGREED TO IN WRITING WILL ANY COPYRIGHT HOLDER, OR ANY OTHER PARTY WHO MAY MODIFY AND/OR REDISTRIBUTE THE PROGRAM AS PERMITTED ABOVE, BE LIABLE TO YOU FOR DAMAGES, INCLUDING ANY GENERAL, SPECIAL, INCIDENTAL OR CONSEQUENTIAL DAMAGES ARISING OUT OF THE USE OR INABILITY TO USE THE PROGRAM (INCLUDING BUT NOT LIMITED TO LOSS OF DATA OR DATA BEING RENDERED INACCURATE OR LOSSES SUSTAINED BY YOU OR THIRD PARTIES OR A FAILURE OF THE PROGRAM TO OPERATE WITH ANY OTHER PROGRAMS), EVEN IF SUCH HOLDER OR OTHER PARTY HAS BEEN ADVISED OF THE POSSIBILITY OF SUCH DAMAGES.

END OF TERMS AND CONDITIONS

How to Apply These Terms to Your New Programs

If you develop a new program, and you want it to be of the greatest possible use to the public, the best way to achieve this is to make it free software which everyone can redistribute and change under these terms.

To do so, attach the following notices to the program. It is safest to attach them to the start of each source file to most effectively convey the exclusion of warranty; and each file should have at least the "copyright" line and a pointer to where the full notice is found.

<one line to give the program's name and a brief idea of what it does.> Copyright (C) <year> <name of author>

C.1 开源软件

This program is free software; you can redistribute it and/or modify it under the terms of the GNU General Public License as published by the Free Software Foundation; either version 2 of the License, or (at your option) any later version.

This program is distributed in the hope that it will be useful, but WITHOUT ANY WARRANTY; without even the implied warranty of MERCHANTABILITY or FITNESS FOR A PARTICULAR PURPOSE. See the GNU General Public License for more details.

You should have received a copy of the GNU General Public License along with this program; if not, write to the Free Software Foundation, Inc., 59 Temple Place, Suite 330, Boston, MA 02111-1307 USA

Also add information on how to contact you by electronic and paper mail.

If the program is interactive, make it output a short notice like this when it starts in an interactive mode:

Gnomovision version 69, Copyright (C) year name of author
Gnomovision comes with ABSOLUTELY NO WARRANTY; for details type `show w'. This is free software, and you are welcome to redistribute it under certain conditions; type `show c' for details.

The hypothetical commands `show w' and `show c' should show the appropriate parts of the General Public License. Of course, the commands you use may be called something other than `show w' and `show c'; they could even be mouse-clicks or menu items--whatever suits your program.

You should also get your employer (if you work as a programmer) or your school, if any, to sign a "copyright disclaimer" for the program, if necessary. Here is a sample; alter the names:

Yoyodyne, Inc., hereby disclaims all copyright interest in the program 'Gnomovision' (which makes passes at compilers) written by James Hacker.

<signature of Ty Coon>, 1 April 1989
Ty Coon, President of Vice

This General Public License does not permit incorporating your program into proprietary programs. If your program is a subroutine library, you may consider it more useful to permit linking proprietary applications with the library. If this is what you want to do, use the GNU Library General Public License instead of this License.

Distributed under the Boost Software License, Version 1.0. (See accompanying file LICENSE_1_0.txt or copy at http://www.boost.org/LICENSE_1_0.txt)

Boost Software License - Version 1.0 - August 17th, 2003

Permission is hereby granted, free of charge, to any person or organization obtaining a copy of the software and accompanying documentation covered by this license (the "Software") to use, reproduce, display, distribute, execute, and transmit the Software, and to prepare derivative works of the Software, and to permit third-parties to whom the Software is furnished to do so, all subject to the following:

The copyright notices in the Software and this entire statement, including the above license grant, this restriction and the following disclaimer, must be included in all copies of the Software, in whole or in part, and all derivative works of the Software, unless such copies or derivative works are solely in the form of machine-executable object code generated by a source language processor.

THE SOFTWARE IS PROVIDED "AS IS", WITHOUT WARRANTY OF ANY KIND, EXPRESS OR IMPLIED, INCLUDING BUT NOT LIMITED TO THE WARRANTIES OF MERCHANTABILITY, FITNESS FOR A PARTICULAR PURPOSE, TITLE AND NON-INFRINGEMENT. IN NO EVENT SHALL THE COPYRIGHT HOLDERS OR ANYONE DISTRIBUTING THE SOFTWARE BE LIABLE FOR ANY DAMAGES OR OTHER LIABILITY, WHETHER IN CONTRACT, TORT OR OTHERWISE, ARISING FROM, OUT OF OR IN CONNECTION WITH THE SOFTWARE OR THE USE OR OTHER DEALINGS IN THE SOFTWARE.

Permission to use, copy, modify, distribute and sell this software and its documentation for any purpose is hereby granted without fee, provided that the above copyright notice appear in all copies and that both that copyright notice and this permission notice appear in supporting documentation. Silicon Graphics makes no representations about the suitability of this software for any purpose. It is provided "as is" without express or implied warranty.

Permission to use, copy, modify, sell, and distribute this software is hereby granted without fee, provided that the above copyright notice appears in all copies, and that both that copyright notice and this permission notice appear in supporting documentation. None of the above authors, nor IBM Haifa Research Laboratories, make any representation about the suitability of this software for any purpose. It is provided "as is" without express or implied warranty.

Permission to use, copy, modify, distribute and sell this software and its documentation for any purpose is hereby granted without fee, provided that the above copyright notice appear in all copies and that both that copyright notice and this permission notice appear in supporting documentation. Hewlett-Packard Company makes no representations about the suitability of this software for any purpose. It is provided "as is" without express or implied warranty.

Copyrights:

(C) Copyright Jeremy Siek 2000.

Copyright © 1994 Hewlett-Packard Company

Copyright © 1998 by Information Technology Industry Council.

Copyright © 2007 Free Software Foundation, Inc.

Copyright (C) Microsoft Corporation 1984-2002. All rights reserved.

Copyright (C) 1994, 1995, 1996, 1997, 1998, 1999, 2000, 2001 // Free Software Foundation

Copyright (C) 1994, 1995, 1996, 1997, 1998, 1999, 2000, 2001, 2002 // Free Software Foundation

Copyright (C) 1994, 1995, 1996, 1997, 1998, 1999, 2000, 2001, 2002, # 2003, 2004, 2005 Free Software Foundation, Inc.

Copyright (C) 1994, 1995, 1996, 1997, 1998, 1999, 2000, 2001, 2002, // 2003, 2004, 2005, 2006, 2007 // Free Software Foundation

Copyright (C) 1994, 1995, 1996, 1997, 1998, 1999, 2000, 2001, 2002, // 2003, 2004, 2005, 2006, 2007 Free Software Foundation, Inc.

Copyright (C) 1994, 1995, 1996, 1998, 1999, 2000, 2001, 2004 // Free Software Foundation

Copyright (C) 1994, 1996, 1997, 1998, 1999, 2000, 2001, 2002 // Free Software Foundation

Copyright (C) 1994, 1996, 1997, 1998, 1999, 2000, 2001, 2002, 2007 // Free Software Foundation

Copyright (C) 1994, 1999, 2000, 2003 Free Software Foundation, Inc.

Copyright (C) 1994, 1999, 2000, 2003, 2005 Free Software Foundation, Inc.

Copyright (C) 1994, 1999, 2001, 2002, 2003 Free Software Foundation, Inc.

Copyright (C) 1994, 1999, 2001, 2003 Free Software Foundation, Inc.

Copyright (C) 1995, 1996, 1997, 1998, 1999, 2000, 2001, 2002, 2003, // 2004, 2005, 2006, 2007 // Free Software Foundation

Copyright (C) 1996, 1997, 1998, 1999, 2000, 2001, 2002, 2003, 2004, # 2005 Free Software Foundation, Inc.

Copyright (C) 1996, 1997, 1998, 1999, 2000, 2001, 2002, 2003, 2004, // 2005, 2006, 2007 // Free Software Foundation

Copyright (C) 1996, 1997, 1998, 1999, 2000, 2001, 2002, 2003, 2004, 2005 # Free Software Foundation, Inc.

C.1 开源软件

Copyright (C) 1998, 1999, 2003, 2004 Free Software Foundation, Inc.
Copyright (C) 1999 Free Software Foundation, Inc.
Copyright (C) 1999, 2000 Free Software Foundation, Inc.
Copyright (C) 1999, 2000, 2001, 2002, 2003 Free Software Foundation
Copyright (C) 1999, 2000, 2001, 2002, 2003 Free Software Foundation, Inc.
Copyright (C) 1999, 2000, 2001, 2002, 2003, 2004 // Free Software Foundation, Inc.
Copyright (C) 1999, 2000, 2001, 2002, 2003, 2004 Free Software Foundation
Copyright (C) 1999, 2000, 2001, 2002, 2003, 2004, 2005 // Free Software Foundation, Inc.
Copyright (C) 1999, 2000, 2001, 2002, 2003, 2004, 2005, 2006 // Free Software Foundation
Copyright (C) 1999, 2000, 2001, 2002, 2003, 2004, 2005, 2006 // Free Software Foundation, Inc.
Copyright (C) 1999, 2000, 2001, 2002, 2003, 2004, 2005, 2006, 2007 // Free Software Foundation, Inc.
Copyright (C) 1999, 2000, 2001, 2002, 2003, 2004, 2005, 2006, 2007, 2008 // Free Software Foundation, Inc.
Copyright (C) 1999, 2000, 2001, 2002, 2003, 2005 // Free Software Foundation, Inc.
Copyright (C) 1999, 2000, 2001, 2002, 2003, 2005 Free Software Foundation
Copyright (C) 1999, 2000, 2001, 2002, 2003, 2006 // Free Software Foundation, Inc.
Copyright (C) 1999, 2000, 2001, 2002, 2004, 2005 // Free Software Foundation, Inc.
Copyright (C) 1999, 2000, 2001, 2003 Free Software Foundation
Copyright (C) 1999, 2000, 2001, 2003, 2004, 2005 // Free Software Foundation, Inc.
Copyright (C) 1999, 2000, 2001, 2004, 2005 Free Software Foundation, Inc.
Copyright (C) 1999, 2000, 2002, 2003 Free Software Foundation
Copyright (C) 1999, 2000, 2002, 2003 Free Software Foundation, Inc.
Copyright (C) 1999, 2000, 2002, 2003, 2004, 2005 // Free Software Foundation, Inc.
Copyright (C) 1999, 2000, 2002, 2003, 2005 Free Software Foundation
Copyright (C) 1999, 2000, 2003 Free Software Foundation
Copyright (C) 1999, 2000, 2003 Free Software Foundation, Inc.
Copyright (C) 1999, 2001, 2002, 2003, 2004 Free Software Foundation
Copyright (C) 1999, 2001, 2002, 2003, 2004, 2005 // Free Software Foundation, Inc.
Copyright (C) 1999, 2001, 2002, 2003, 2004, 2005 Free Software Foundation
Copyright (C) 1999, 2001, 2002, 2003, 2004, 2005, 2006 // Free Software Foundation, Inc.
Copyright (C) 1999, 2001, 2002, 2005, 2006 Free Software Foundation, Inc.
Copyright (C) 1999, 2001, 2003 Free Software Foundation
Copyright (C) 1999, 2001, 2003 Free Software Foundation, Inc.

Copyright (C) 1999, 2001, 2003, 2004 Free Software Foundation
Copyright (C) 1999, 2001, 2003, 2007 Free Software Foundation, Inc.
Copyright (C) 1999, 2001, 2004, 2005 Free Software Foundation, Inc.
Copyright (C) 1999, 2002 Free Software Foundation, Inc.
Copyright (C) 1999, 2002, 2003 Free Software Foundation, Inc.
Copyright (C) 1999, 2002, 2003, 2004 Free Software Foundation, Inc.
Copyright (C) 1999, 2002, 2003, 2004, 2005 // Free Software Foundation, Inc.
Copyright (C) 1999, 2002, 2003, 2004, 2005 Free Software Foundation, Inc.
Copyright (C) 1999, 2002, 2003, 2005 Free Software Foundation, Inc.
Copyright (C) 1999, 2002, 2004, 2005 Free Software Foundation, Inc.
Copyright (C) 1999, 2003 Free Software Foundation
Copyright (C) 1999, 2003 Free Software Foundation, Inc.
Copyright (C) 1999, 2003, 2004, 2005 Free Software Foundation, Inc.
Copyright (C) 1999, 2003, 2005 Free Software Foundation
Copyright (C) 1999, 2003, 2005 Free Software Foundation, Inc.
Copyright (C) 1999, 2004, 2005 Free Software Foundation, Inc.
Copyright (C) 1999, 2007 Free Software Foundation, Inc.
Copyright (C) 1999-2001, 2002, 2003 Free Software Foundation, Inc.
Copyright (C) 1999-2001, 2002, 2003, 2004, 2005 // Free Software Foundation, Inc.
Copyright (C) 2000 Free Software Foundation, Inc.
Copyright (C) 2000, 1999 Free Software Foundation, Inc.
Copyright (C) 2000, 2001 Free Software Foundation
Copyright (C) 2000, 2001, 2002 Free Software Foundation,
Copyright (C) 2000, 2001, 2002 Free Software Foundation, <abbrev>Inc.</abbrev>
51 Franklin <abbrev>St</abbrev>, Fifth Floor, Boston, <abbrev>MA</abbrev>
02110-1301
Copyright (C) 2000, 2001, 2002 Free Software Foundation, Inc.
Copyright (C) 2000, 2001, 2002, 2003 Free Software Foundation
Copyright (C) 2000, 2001, 2002, 2003 Free Software Foundation, Inc.
Copyright (C) 2000, 2001, 2002, 2003, 2004 Free Software Foundation
Copyright (C) 2000, 2001, 2002, 2003, 2004, 2005 // Free Software Foundation, Inc.
Copyright (C) 2000, 2001, 2002, 2003, 2004, 2005, 2006 // Free Software Foundation
Copyright (C) 2000, 2001, 2002, 2003, 2004, 2005, 2006 // Free Software Foundation, Inc.
Copyright (C) 2000, 2001, 2002, 2003, 2004, 2005, 2006, 2007 // Free Software Foundation, Inc.
Copyright (C) 2000, 2001, 2002, 2003, 2004, 2005, 2006, 2007 // Free Software Foundation
Copyright (C) 2000, 2001, 2002, 2003, 2004, 2005, 2006, 2007 // Free Software Foundation, Inc.
Copyright (C) 2000, 2001, 2002, 2003, 2004, 2005, 2006, 2007 // Free Software Foundation, Inc.
Copyright (C) 2000, 2001, 2002, 2003, 2004, 2005, 2006, 2007, 2008 // Free

Software Foundation, Inc.

Copyright (C) 2000, 2001, 2002, 2003, 2004, 2005, 2007 ## Free Software Foundation, Inc.

Copyright (C) 2000, 2001, 2002, 2003, 2004, 2006, 2007 // Free Software Foundation, Inc.

Copyright (C) 2000, 2001, 2002, 2003, 2005 Free Software Foundation

Copyright (C) 2000, 2001, 2002, 2003, 2005 Free Software Foundation, Inc.

Copyright (C) 2000, 2001, 2002, 2003, 2006 Free Software Foundation, Inc.

Copyright (C) 2000, 2001, 2002, 2003, 2007 Free Software Foundation

Copyright (C) 2000, 2001, 2003 Free Software Foundation, Inc.

Copyright (C) 2000, 2001, 2003, 2004 Free Software Foundation, Inc.

Copyright (C) 2000, 2001, 2003, 2004, 2005 Free Software Foundation, Inc.

Copyright (C) 2000, 2001, 2003, 2004, 2005, 2006 // Free Software Foundation, Inc.

Copyright (C) 2000, 2001, 2003, 2005 Free Software Foundation, Inc.

Copyright (C) 2000, 2001, 2004, 2005 Free Software Foundation, Inc.

Copyright (C) 2000, 2001, 2005, 2006 Free Software Foundation, Inc.

Copyright (C) 2000, 2002 Free Software Foundation, Inc.

Copyright (C) 2000, 2002, 2003 Free Software Foundation

Copyright (C) 2000, 2002, 2003 Free Software Foundation, Inc.

Copyright (C) 2000, 2002, 2003, 2004 Free Software Foundation

Copyright (C) 2000, 2002, 2003, 2004, 2006, 2007 Free Software Foundation, Inc.

Copyright (C) 2000, 2002, 2003, 2005 Free Software Foundation

Copyright (C) 2000, 2002, 2004, 2005 Free Software Foundation, Inc.

Copyright (C) 2000, 2002, 2005 Free Software Foundation, Inc.

Copyright (C) 2000, 2002, 2005, 2008 Free Software Foundation, Inc.

Copyright (C) 2000, 2002, 2006 Free Software Foundation, Inc.

Copyright (C) 2000, 2003 Free Software Foundation

Copyright (C) 2000, 2003 Free Software Foundation, Inc.

Copyright (C) 2000, 2003, 2004 Free Software Foundation

Copyright (C) 2000, 2003, 2004 Free Software Foundation, Inc.

Copyright (C) 2000, 2003, 2004, 2005 Free Software Foundation, Inc.

Copyright (C) 2000, 2005 Free Software Foundation, Inc.

Copyright (C) 2001 Free Software Foundation

Copyright (C) 2001 Free Software Foundation, Inc.

Copyright (C) 2001 Free Software Foundation, Inc. # Benjamin Kosnik <bkoz@redhat.com>, 2001.

Copyright (C) 2001, 2002 Free Software Foundation, Inc.

Copyright (C) 2001, 2002, 2003 Free Software Foundation

Copyright (C) 2001, 2002, 2003 Free Software Foundation, Inc.

Copyright (C) 2001, 2002, 2003 Peter Dimov

Copyright (C) 2001, 2002, 2003, 2004 Free Software Foundation

Copyright (C) 2001, 2002, 2003, 2004 Free Software Foundation, Inc.

Copyright (C) 2001, 2002, 2003, 2004, 2005 Free Software Foundation

Copyright (C) 2001, 2002, 2003, 2004, 2005 Free Software Foundation, Inc.

Copyright (C) 2001, 2002, 2003, 2004, 2005, 2006 // Free Software Foundation, Inc.

Copyright (C) 2001, 2002, 2003, 2004, 2005, 2006, 2007 // Free Software Foundation

Copyright (C) 2001, 2002, 2003, 2004, 2005, 2006, 2007 // Free Software Foundation, Inc.

Copyright (C) 2001, 2002, 2003, 2004, 2005, 2006, 2007 // Free Software Foundation, Inc.

Copyright (C) 2001, 2002, 2003, 2004, 2005, 2006, 2007, 2008 ## Free Software Foundation, Inc.

Copyright (C) 2001, 2002, 2003, 2004, 2005, 2006, 2007, 2008 // Free Software Foundation

Copyright (C) 2001, 2002, 2003, 2004, 2005, 2006, 2007, 2008 // Free Software Foundation, Inc.

Copyright (C) 2001, 2002, 2003, 2004, 2005, 2006, 2007, 2008 // Free Software Foundation, Inc.

Copyright (C) 2001, 2002, 2003, 2004, 2008 Free Software Foundation, Inc.

Copyright (C) 2001, 2002, 2003, 2005 Free Software Foundation, Inc.

Copyright (C) 2001, 2002, 2003, 2005 Free Software Foundation

Copyright (C) 2001, 2002, 2003, 2005 Free Software Foundation, Inc.

Copyright (C) 2001, 2002, 2003, 2005, 2006 Free Software Foundation

Copyright (C) 2001, 2002, 2003, 2005, 2007 Free Software Foundation, Inc.

Copyright (C) 2001, 2002, 2003, 2006 Free Software Foundation, Inc.

Copyright (C) 2001, 2002, 2003, 2006, 2008 Free Software Foundation, Inc.

Copyright (C) 2001, 2002, 2004 Free Software Foundation, Inc.

Copyright (C) 2001, 2002, 2004, 2005 Free Software Foundation

Copyright (C) 2001, 2002, 2004, 2005 Free Software Foundation, Inc.

Copyright (C) 2001, 2002, 2004, 2005, 2006 Free Software Foundation, Inc.

Copyright (C) 2001, 2002, 2004, 2005, 2007 Free Software Foundation, Inc.

Copyright (C) 2001, 2002, 2004, 2005, 2008 Free Software Foundation, Inc.

Copyright (C) 2001, 2002, 2004, 2006 Free Software Foundation, Inc.

Copyright (C) 2001, 2002, 2005 Free Software Foundation, Inc.

Copyright (C) 2001, 2002, 2005, 2007 Free Software Foundation, Inc.

Copyright (C) 2001, 2002, 2005, 2008 Free Software Foundation, Inc. See license.html for license.

Copyright (C) 2001, 2003 Free Software Foundation

Copyright (C) 2001, 2003 Free Software Foundation

C.1 开源软件

Copyright (C) 2001, 2003 Free Software Foundation, Inc.
 Copyright (C) 2001, 2003, 2004 Free Software Foundation, Inc.
 Copyright (C) 2001, 2003, 2004, 2005 Free Software Foundation, Inc.
 Copyright (C) 2001, 2003, 2005 Free Software Foundation, Inc.
 Copyright (C) 2001, 2003, 2005 Free Software Foundation
 Copyright (C) 2001, 2003, 2007 Free Software Foundation, Inc.
 Copyright (C) 2001, 2004 Free Software Foundation, Inc.
 Copyright (C) 2001, 2004, 2005 Free Software Foundation, Inc.
 Copyright (C) 2001, 2005 Free Software Foundation, Inc.
 Copyright (C) 2001, 2007 Free Software Foundation, Inc.
 Copyright (C) 2002 // Free Software Foundation, Inc.
 Copyright (C) 2002 Free Software Foundation
 Copyright (C) 2002 Free Software Foundation, Inc.
 Copyright (C) 2002 Peter Dimov
 Copyright (C) 2002, 2003 Free Software Foundation
 Copyright (C) 2002, 2003 Free Software Foundation, Inc.
 Copyright (C) 2002, 2003, 2004, 2005 Free Software Foundation
 Copyright (C) 2002, 2003, 2004, 2005 Free Software Foundation, Inc.
 Copyright (C) 2002, 2003, 2004, 2005, 2006, 2007 // Free Software Foundation, Inc.
 Copyright (C) 2002, 2003, 2004, 2005, 2006, 2007, 2008 ## Free Software Foundation, Inc.
 Copyright (C) 2002, 2003, 2004, 2005, 2006, 2007, 2008 Free // Software Foundation
 Copyright (C) 2002, 2003, 2004, 2005, 2007 Free Software Foundation, Inc.
 Copyright (C) 2002, 2003, 2004, 2007 Free Software Foundation, Inc.
 Copyright (C) 2002, 2003, 2005 Free Software Foundation, Inc.
 Copyright (C) 2002, 2003, 2005 Free Software Foundation, Inc.
 Copyright (C) 2002, 2003, 2007 Free Software Foundation, Inc.
 Copyright (C) 2002, 2004 Free Software Foundation
 Copyright (C) 2002, 2004 Free Software Foundation, Inc.
 Copyright (C) 2002, 2004, 2005 Free Software Foundation, Inc.
 Copyright (C) 2002, 2004, 2005, 2007 Free Software Foundation, Inc.
 Copyright (C) 2002, 2004, 2006 Free Software Foundation, Inc.
 Copyright (C) 2002, 2005, 2007 Free Software Foundation, Inc.
 Copyright (C) 2002, 2007 Free Software Foundation, Inc.
 Copyright (C) 2003 // Free Software Foundation, Inc.
 Copyright (C) 2003 Free Software Foundation
 Copyright (C) 2003 Free Software Foundation, Inc.
 Copyright (C) 2003, 2004 // Free Software Foundation, Inc.
 Copyright (C) 2003, 2004 Free Software Foundation

Copyright (C) 2003, 2004 Free Software Foundation, Inc.
 Copyright (C) 2003, 2004, 2005 // Free Software Foundation, Inc.
 Copyright (C) 2003, 2004, 2005 Free Software Foundation, Inc.
 Copyright (C) 2003, 2004, 2005 Free Software Foundation
 Copyright (C) 2003, 2004, 2005 Free Software Foundation, Inc.
 Copyright (C) 2003, 2004, 2005, 2006 // Free Software Foundation, Inc.
 Copyright (C) 2003, 2004, 2005, 2006 Free Software Foundation
 Copyright (C) 2003, 2004, 2005, 2006 Free Software Foundation, Inc.
 Copyright (C) 2003, 2004, 2005, 2006, 2007 // Free Software Foundation, Inc.
 Copyright (C) 2003, 2004, 2005, 2006, 2007 Free Software Foundation
 Copyright (C) 2003, 2004, 2005, 2006, 2007 Free Software Foundation, Inc.
 Copyright (C) 2003, 2004, 2005, 2006, 2007, 2008 // Free Software Foundation, Inc.
 Copyright (C) 2003, 2004, 2005, 2006, 2007, 2008 Free Software // Foundation, Inc.
 Copyright (C) 2003, 2004, 2005, 2007 Free Software Foundation
 Copyright (C) 2003, 2004, 2005, 2007 Free Software Foundation, Inc.
 Copyright (C) 2003, 2004, 2006 Free Software Foundation, Inc.
 Copyright (C) 2003, 2005 Free Software Foundation
 Copyright (C) 2003, 2005 Free Software Foundation, Inc.
 Copyright (C) 2003, 2005, 2006 // Free Software Foundation, Inc.
 Copyright (C) 2003, 2005, 2006 Free Software Foundation, Inc.
 Copyright (C) 2003, 2006 // Free Software Foundation, Inc.
 Copyright (C) 2003, 2007 Free Software Foundation, Inc.
 Copyright (C) 2004 Ami Tavory and Vladimir Dreizin, IBM-HRL.
 Copyright (C) 2004 Free Software Foundation
 Copyright (C) 2004 Free Software Foundation, Inc.
 Copyright (C) 2004, 2005 Free Software Foundation, Inc.
 Copyright (C) 2004, 2005 Free Software Foundation
 Copyright (C) 2004, 2005 Free Software Foundation, Inc.
 Copyright (C) 2004, 2005, 2006 Free Software Foundation
 Copyright (C) 2004, 2005, 2006 Free Software Foundation, Inc.
 Copyright (C) 2004, 2005, 2006, 2007 Free Software Foundation
 Copyright (C) 2004, 2005, 2006, 2007 Free Software Foundation, Inc.
 Copyright (C) 2004, 2005, 2006, 2007, 2008 // Free Software Foundation, Inc.
 Copyright (C) 2004, 2005, 2006, 2007, 2008 Free Software Foundation, Inc.
 Copyright (C) 2004, 2005, 2007 Free Software Foundation
 Copyright (C) 2004, 2005, 2007 Free Software Foundation, Inc.
 Copyright (C) 2004, 2006 Free Software Foundation, Inc.
 Copyright (C) 2004, 2006, 2008 Free Software Foundation, Inc.

Copyright (C) 2004, 2007 Free Software Foundation, Inc.

Copyright (C) 2005 Free Software Foundation, Inc.

Copyright (C) 2005 Free Software Foundation

Copyright (C) 2005 Free Software Foundation, Inc.

Copyright (C) 2005, 2006 // Free Software Foundation, Inc.

Copyright (C) 2005, 2006 Free Software Foundation, Inc.

Copyright (C) 2005, 2006, 2007 Free Software Foundation

Copyright (C) 2005, 2006, 2007 Free Software Foundation, Inc.

Copyright (C) 2005, 2006, 2007, 2008 Free Software Foundation, Inc.

Copyright (C) 2005, 2006, 2008 Free Software Foundation, Inc.

Copyright (C) 2005, 2007 Free Software Foundation, Inc.

Copyright (C) 2006 // Free Software Foundation, Inc.

Copyright (C) 2006 Free Software Foundation

Copyright (C) 2006 Free Software Foundation

Copyright (C) 2006 Free Software Foundation, Inc.

Copyright (C) 2006, 2006 Free Software Foundation

Copyright (C) 2006, 2007 Free Software Foundation

Copyright (C) 2006, 2007 Free Software Foundation, Inc.

Copyright (C) 2006, 2007, 2008 // Free Software Foundation, Inc.

Copyright (C) 2006, 2007, 2008 Free Software Foundation

Copyright (C) 2006, 2007, 2008 Free Software Foundation, Inc.

Copyright (C) 2006, 2008 // Free Software Foundation, Inc.

Copyright (C) 2006-2007 Free Software Foundation, Inc.

Copyright (C) 2007 // Free Software Foundation, Inc.

Copyright (C) 2007 Free Software Foundation

Copyright (C) 2007 Free Software Foundation, Inc.

Copyright (C) 2007, 2008 Free Software Foundation

Copyright (C) 2007, 2008 Free Software Foundation, Inc.

Copyright (C) 2007,2008 Free Software Foundation, Inc.

Copyright (C) 2008 Free Software Foundation

Copyright (C) 2008 Free Software Foundation, Inc.

Copyright (c) 1994 * Hewlett-Packard Company

Copyright (c) 1996 * Silicon Graphics Computer Systems, Inc.

Copyright (c) 1996,1997 * Silicon Graphics

Copyright (c) 1996,1997 * Silicon Graphics Computer Systems, Inc.

Copyright (c) 1996-1997 * Silicon Graphics Computer Systems, Inc.

Copyright (c) 1996-1998 * Silicon Graphics Computer Systems, Inc.

Copyright (c) 1996-1999 * Silicon Graphics Computer Systems, Inc.

Copyright (c) 1997 * Silicon Graphics Computer Systems, Inc.

Copyright (c) 1997-1999 * Silicon Graphics Computer Systems, Inc.

Copyright (c) 1998 * Silicon Graphics Computer Systems, Inc.

Copyright (c) 2001, 2002, 2003 Peter Dimov and Multi Media Ltd.

Copyright 2008 FSF

Copyright Ami Tavory and Vladimir Dreizin, IBM-HRL, 2004, and Benjamin Kosnik, Red Hat, 2004.

Copyright © 1989, 1991 Free Software Foundation, Inc.

Copyright © 1998 ISO.

Copyright © 1999 The Open Group/The Institute of Electrical and Electronics Engineers, Inc..

Copyright © 1999 ISO.

Copyright © 2000 Addison Wesley Longman, Inc..

Copyright © 2000 Addison Wesley, Inc..

Copyright © 2000, 2001, 2002, 2003, 2004, 2005, 2006, 2007, 2008

Copyright © 2002 OOPSLA.

Copyright © 2004, 2005, 2006, 2007 Free Software Foundation, Inc., 51 Franklin Street, Fifth Floor, Boston, MA 02110-1301, USA

Copyright © 2004, 2005, 2006, 2007 Free Software Foundation, Inc., 51 Franklin Street, Fifth Floor, Boston, MA 02110-1301, USA

Copyright © 2007 FSF.

Copyrighted by the Free Software Foundation

Copyrighted by the Free Software Foundation

索引

Keine Indexeinträge gefunden.

