

MODBUS® Interface Module

User's Manual

mitsubishi

Q series
Q series

Mitsubishi
Programmable Controller

MELSEC-Q

QJ71MB91
GX Configurator-MB
(SW1D5C-QMBU-E)

● SAFETY PRECAUTIONS ●

(Always read these instructions before using this product.)

Before using this product, please read this manual and the relevant manuals introduced in this manual carefully and pay full attention to safety to handle the product correctly.

The instructions given in this manual are concerned with this product. For the safety instructions of the programmable controller system, please read the user's manual of the CPU module used.

In this manual, the safety instructions are ranked as "DANGER" and "CAUTION".



Indicates that incorrect handling may cause hazardous conditions, resulting in death or severe injury.



Indicates that incorrect handling may cause hazardous conditions, resulting in medium or slight personal injury or physical damage.

Note that the  CAUTION level may lead to a serious consequence according to the circumstances. Always follow the instructions of both levels because they are important to personal safety.

Please save this manual to make it accessible when required and always forward it to the end user.

[DESIGN PRECAUTIONS]

DANGER

- For the operating status of each station in the case of a communication error, see the manual of each station. Erroneous output or malfunction may cause an accident.
- When controlling a running programmable controller (modifying data) by connecting peripheral devices to the CPU module or connecting a personal computer to the intelligent function module, configure an interlocking circuit in a sequence program so that the safety of the overall system is always maintained. Also, before performing other control operations (program modifications and operation status modifications (status control)) on the running programmable controller, be sure to read the manual carefully and thoroughly confirm the safety.
Especially in the above mentioned control operations that are performed from an external device to a remote programmable controller, any problems on the programmable controller side may not be dealt with promptly due to faulty data communication. In addition to configuring an interlocking circuit in a sequence program, determine how the system handles data communication errors between the devices and the programmable controller CPU.
- Do not write any data in the "system area (Use prohibited)" of the buffer memory of the intelligent function module. Also, do not output (turn on) the "use prohibited" signal, which is one of the output signals from the programmable controller CPU to the intelligent function module. If data is written to the "system area (Use prohibited)" or the "use prohibited" signal is output, there is a risk that the programmable controller system may malfunction.

[DESIGN PRECAUTIONS]

CAUTION

- Do not bundle the control wires and the communication cables with the main circuit and the power wires, and do not install them close to each other. They should be installed at least 100 mm (3.94 in.) away from each other. Failure to do so may generate noise that may cause malfunctions.

[INSTALLATION PRECAUTIONS]

CAUTION

- Use the programmable controller in the operating environment that meets the general specifications described in the user's manual of the CPU Module to use. Using the programmable controller in any other operating environments may cause electric shocks, fires or malfunctions, or may damage or degrade the module.
- While pressing the installation lever located at the bottom of module, insert the module fixing tab into the fixing hole in the base unit until it stops. Then, set the module in position using the fixing hole as a supporting point. Incorrect mounting may cause malfunctions, failure or a drop of the module. Secure the module with screws in an environment of frequent vibrations.
- Be sure to tighten the screws using the specified torque. If the screws are loose, it may cause a short circuit, malfunctions or a drop of the module. Overtightening the screws may damage the screws and/or module, resulting in a short circuit, malfunctions or a drop of the module.
- Before mounting/dismounting the module, be sure to shut off all phases of the external power supply used by the system. Failure to do so may cause product damage.
- Do not directly touch the conductive area or electronic components of the module. Doing so may cause malfunction or failure in the module.

[WIRING PRECAUTIONS]

DANGER

- Be sure to shut off all phases of the external power supply used in the system before wiring. Failure to do so may result in an electric shock or damage to the product.
- When powering up the system for operation after completing the wiring, make sure that supplied terminal covers are correctly attached. Not attaching the terminal covers could result in an electric shock.

CAUTION

- Properly crimp, press-fit or solder the wires of the connector for external connections using the manufacturer-specified tools.
Incomplete connection may cause a short circuit, fire, or malfunction.
- Fully connect the connector to the module.
- Before wiring the module, check the rated voltage and the terminal layout. Connecting a power supply that is different from the rating or incorrectly wiring the product could result in fire or damage.
- Make sure to place the communication and power cables to be connected to the module in a duct or fasten them using a clamp. If the cables are not placed in a duct or fastened with a clamp, their positions may be unstable or moved, and they may be pulled inadvertently.
This may damage the module and the cables or cause the module to malfunction due to poor cable connection.
- Wire the module correctly after confirming the type of the connected interface. If the cable is connected to a different interface or wired incorrectly, it may cause a fire or breakdown.
- Tighten the terminal screws within the range of the specified torque. If the terminal screws are loose, it may result in a short circuit or malfunction. If the screws are tightened too much, it may cause damage to the screw and/or the module, resulting in a drop of the module, short circuit or malfunction.
- When removing a communication or power cable from the module, do not pull the cable part. For the cable with connector, hold the connector part connected to the module. When removing the cable connected to the terminal block, first loosen the screws on the terminal block. Pulling a cable connected to the module may damage the module and/or cable and cause a malfunction due to poor contact.
- Carefully prevent foreign matter such as wire chips from entering the module.
Failure to do so may cause a fire, breakdown or malfunction of the module.
- A protective film is attached onto the module top in order to prevent foreign matter such as wire chips from entering the module while wiring.
Do not remove this protective film during wiring work. However, be sure to remove it for heat dissipation before system operation.

[STARTUP/MAINTENANCE PRECAUTIONS]

DANGER

- Do not touch the terminals while power is on. Doing so could cause an electric shock.
- Before cleaning up and retightening terminal screws and module fixing screws, be sure to shut off all phases of the external power supply used by the system. Not doing so may cause failure or malfunction of the module. If the screws are loose, it may cause a drop of the module, short circuit, or malfunction. If the screws are tightened too much, it may cause damages to the screws and/or the module, resulting in a drop of the module, short circuit or malfunction.

CAUTION

- Before performing online operations (especially, program modification, forced output or operating status change) by connecting a peripheral device to a running CPU, read the manual carefully and ensure the safety. Incorrect operation will cause mechanical damage or accidents.
- Do not disassemble or modify each module. Doing so could cause failure, malfunction, injury or fire.
- When using a wireless communication device such as a cellular phone, keep a distance of 25cm (9.85 inch) or more from the programmable controller in all directions. Failure to do so can cause a malfunction.
- Before mounting/dismounting the module, be sure to shut off all phases of the external power supply used by the system. Failure to do so may cause module failure or malfunctions.
- Do not install/remove the module to/from the base unit, or the terminal block to/from the module more than 50 times after the first use of the product.(IEC 61131-2 compliant)
Failure to do so may cause malfunction.
- Before handling the module, touch a grounded metal object to discharge the static electricity from the human body. Failure to do so may cause a failure or malfunctions of the module.

[OPERATING PRECAUTIONS]

DANGER

- Please read the manual carefully and ensure the safety before performing control operations (especially, data or program modification and operation status change) to a running programmable controller. Incorrect data or program modifications or improper operating status change may cause system malfunctions, mechanical damages or accidents.

[DISPOSAL PRECAUTIONS]

CAUTION

- When disposing of this product, treat it as an industrial waste.

REVISIONS

* The manual number is given on the bottom left of the back cover.

Print Date	* Manual Number	Revision
Nov., 2005	SH(NA)-080578ENG-A	First edition
Feb., 2006	SH(NA)-080578ENG-B	Modifications Section 2.1, 2.3, 10.1
Oct., 2006	SH(NA)-080578ENG-C	Modifications SAFETY PRECAUTIONS, Section 2.1, 6.6, 10.1
Jan., 2008	SH(NA)-080578ENG-D	Modifications SAFETY PRECAUTIONS, About the Generic Terms and Abbreviations, Meanings and Definitions of Terms, Section 2.1, 2.4, 3.1, 3.2.1, 3.3.1, 3.3.2, 3.4.1, 4.1.6, 5.1, 5.2.1, 6.1, 6.3, 6.4.1, 6.4.2, 6.5.2, 6.6, 7.2.1, 7.3.1, 7.3.2, Chapter 8, 9.1.2, 9.3.1, 9.3.2, 10.2, 10.3, 11.1, 11.2, 11.4.1, 11.4.3, 11.5.1, Appendix 3 Added Section 2.3 Section 2.3 changed to Section 2.4.
Mar., 2008	SH(NA)-080578ENG-E	Modifications Compliance with the EMC and Low Voltage Directives, Section 2.1, 2.4, 4.16, 6.3, 6.4.1, 8.5, 8.6, Appendix 3
May, 2008	SH(NA)-080578ENG-F	Change of a term "PLC" was changed to "programmable controller". Modifications About the Generic Terms and Abbreviations, Section 2.1, 4.16, 6.1, 6.6, 7.3.1, 8.2.1, 8.3.1, 8.3.3, 8.4, 8.5, 8.6, 10.2, 10.3, 11.4.3
Apr., 2009	SH(NA)-080578ENG-G	Modifications Section 1.1, 2.1, 2.4, 3.1, 3.4.1, 3.5.1, 4.16, 5.2.1, 8.2.1, 9.1.1 to 9.3.2, 10.1 to 10.3, 11.1, 11.4.3 Added Section 10.4, Appendix 1 Appendix numbers 1 and 2 changed to 2 and 3.

Japanese Manual Version SH-080567-H

This manual confers no industrial property rights or any rights of any other kind, nor does it confer any patent licenses. Mitsubishi Electric Corporation cannot be held responsible for any problems involving industrial property rights which may occur as a result of using the contents noted in this manual.

INTRODUCTION

Thank you for purchasing the MELSEC-Q series programmable controller.

Before using the equipment, please read this manual carefully to develop full familiarity with the functions and performance of the Q series programmable controller you have purchased, so as to ensure correct use.

CONTENTS

SAFETY PRECAUTIONS	A - 1
REVISIONS	A - 5
INTRODUCTION	A - 6
CONTENTS	A - 6
Compliance with the EMC and Low Voltage Directives	A - 11
The Manual's Usage and Structure	A - 12
About the Generic Terms and Abbreviations	A - 14
Meanings and Definitions of Terms	A - 15
Product Configuration	A - 15

CHAPTER1 OVERVIEW 1 - 1 to 1 - 4

1.1 Features	1 - 1
--------------	-------

CHAPTER2 SYSTEM CONFIGURATION 2 - 1 to 2 - 11

2.1 Applicable Systems	2 - 1
2.2 Network Configuration	2 - 4
2.3 Precautions for System Configuration	2 - 8
2.4 How to Check the Function Version/Software Version	2 - 9

CHAPTER3 SPECIFICATIONS 3 - 1 to 3 - 23

3.1 Performance Specifications	3 - 1
3.2 RS-232 Interface Specification	3 - 3
3.2.1 RS-232 connector specification	3 - 3
3.2.2 RS-232 cable specification	3 - 5
3.3 RS-422/485 Interface Specification	3 - 6
3.3.1 RS-422/485 terminal block specification	3 - 6
3.3.2 RS-422/485 cable specification	3 - 7
3.3.3 Precautions when transferring data using RS-422/485 line	3 - 8
3.4 I/O Signals for Programmable Controller CPU	3 - 10
3.4.1 I/O signal list	3 - 10
3.5 Applications and Assignment of Buffer Memory	3 - 13
3.5.1 Buffer memory list	3 - 13

CHAPTER4 MODBUS(R) STANDARD FUNCTIONS**4 - 1 to 4 - 60**

4.1	MODBUS(R) Standard Function Support List	4 - 1
4.2	Frame Specifications	4 - 10
4.2.1	Frame mode	4 - 11
4.3	Protocol Data Unit Formats by Functions	4 - 15
4.4	Read Coils (FC: 01)	4 - 18
4.5	Read Discrete Inputs (FC: 02)	4 - 19
4.6	Read Holding Registers (FC: 03)	4 - 20
4.7	Read Input Registers (FC: 04)	4 - 21
4.8	Write Single Coil (FC: 05)	4 - 22
4.9	Write Single Register (FC: 06)	4 - 23
4.10	Read Exception Status (FC: 07)	4 - 24
4.11	Diagnostics (FC: 08)	4 - 25
4.11.1	Return query data (sub-function code: 00)	4 - 25
4.11.2	Restart communications option (sub-function code: 01)	4 - 26
4.11.3	Return diagnostic register (sub-function code: 02)	4 - 28
4.11.4	Change ASCII input delimiter (sub-function code: 03)	4 - 30
4.11.5	Force listen only mode (sub-function code: 04)	4 - 31
4.11.6	Clear counters and diagnostic register (sub-function code: 10)	4 - 33
4.11.7	Return bus message count (sub-function code: 11)	4 - 35
4.11.8	Return bus communication error count (sub-function code: 12)	4 - 36
4.11.9	Return bus exception error count (sub-function code: 13)	4 - 37
4.11.10	Return slave message count (sub-function code: 14)	4 - 38
4.11.11	Return slave no response count (sub-function code: 15)	4 - 39
4.11.12	Return slave NAK count (sub-function code: 16)	4 - 40
4.11.13	Return slave busy count (sub-function code: 17)	4 - 41
4.11.14	Return bus character overrun count (sub-function code: 18)	4 - 42
4.11.15	Return IOP overrun error count (sub-function code: 19)	4 - 43
4.11.16	Clear overrun counter and flag (sub-function code: 20)	4 - 44
4.12	Get Communications Event Counter (FC: 11)	4 - 45
4.13	Get Communications Event Log (FC: 12)	4 - 47
4.14	Write Multiple Coils (FC: 15)	4 - 50
4.15	Write Multiple Registers (FC: 16)	4 - 52
4.16	Report Slave ID (FC: 17)	4 - 53
4.17	Read File Record (FC: 20) (SC: 06)	4 - 55
4.18	Write File Record (FC: 21) (SC: 06)	4 - 57
4.19	Mask Write Register (FC: 22)	4 - 59
4.20	Read/Write Multiple Registers (FC: 23)	4 - 60

CHAPTER5 FUNCTIONS**5 - 1 to 5 - 22**

5.1	Function List	5 - 1
5.2	Master Function	5 - 3

5.2.1	Automatic communication function	5 - 3
5.2.2	Communication by dedicated instructions	5 - 16
5.3	Slave Function	5 - 17
5.3.1	Automatic response function	5 - 17
5.3.2	MODBUS(R) device assignment function	5 - 18
5.3.3	Link operation function	5 - 21

CHAPTER6 PRE-OPERATIONAL PROCEDURES AND SETTINGS **6 - 1 to 6 - 24**

6.1	Handling Precautions	6 - 1
6.2	Pre-Operational Procedures and Settings	6 - 2
6.3	Part Names	6 - 4
6.4	Unit Tests	6 - 6
6.4.1	Hardware test	6 - 6
6.4.2	Self-loopback test	6 - 8
6.5	Connection to a Target Device	6 - 11
6.5.1	How to connect the RS-232 interface	6 - 12
6.5.2	How to connect the RS-422/485 interface	6 - 14
6.6	Intelligent Function Module Switch Setting	6 - 19
6.7	Maintenance, Inspection	6 - 24
6.7.1	Maintenance, inspection	6 - 24
6.7.2	When removing or installing the module	6 - 24

CHAPTER7 PARAMETER SETTING **7 - 1 to 7 - 31**

7.1	Parameter Settings and Setting Procedure	7 - 1
7.2	Automatic Communication Parameter	7 - 4
7.2.1	Automatic communication parameter details	7 - 4
7.3	MODBUS(R) Device Assignment Parameter	7 - 11
7.3.1	MODBUS(R) device assignment to the programmable controller CPU device memory	7 - 13
7.3.2	MODBUS(R) extended file register assignment to the programmable controller CPU file register	7 - 23
7.3.3	QJ71MB91 buffer memory assignment	7 - 24
7.3.4	Specifying the error status read device	7 - 26
7.3.5	Specifying access target when mounted to MELSECNET/H remote I/O station	7 - 29
7.3.6	Specifying the CPU response monitoring timer	7 - 30

CHAPTER8 UTILITY PACKAGE (GX Configurator-MB) **8 - 1 to 8 - 37**

8.1	Functions of the Utility Package	8 - 1
8.2	Installing and Uninstalling the Utility Package	8 - 2
8.2.1	Handling precautions	8 - 2
8.2.2	Operating environment	8 - 5
8.3	Utility Package Operation	8 - 7
8.3.1	Common utility package operations	8 - 7
8.3.2	Operation overview	8 - 10
8.3.3	Starting the Intelligent function module utility	8 - 12

8.4	Initial Setting	8 - 15
8.4.1	Automatic communication parameter	8 - 17
8.4.2	MODBUS(R) device assignment parameter	8 - 19
8.5	Auto Refresh Setting	8 - 22
8.6	Monitor/Test.....	8 - 24
8.6.1	X/Y Monitor/test.....	8 - 29
8.6.2	MODBUS(R) device assignment parameter status.....	8 - 31
8.6.3	Automatic communication status.....	8 - 32
8.6.4	Error log	8 - 34
8.6.5	Communication status.....	8 - 35

CHAPTER9 PROGRAMMING

9 - 1 to 9 - 44

9.1	Parameter Setting	9 - 1
9.1.1	Automatic communication parameters	9 - 1
9.1.2	MODBUS(R) device assignment parameters.....	9 - 4
9.2	Program Example for Normal System Configuration	9 - 8
9.2.1	Automatic communication parameters	9 - 8
9.2.2	MODBUS(R) device assignment parameters.....	9 - 14
9.2.3	When using the automatic communication function and the communication by dedicated instructions (MBRW, MBREQ) on the same channel	9 - 18
9.3	Program Examples for Use in MELSECNET/H Remote I/O Network	9 - 25
9.3.1	Automatic communication parameters	9 - 25
9.3.2	MODBUS(R) device assignment parameters.....	9 - 37

CHAPTER10 DEDICATED INSTRUCTIONS

10 - 1 to 10 - 32

10.1	Dedicated Instruction List and Available Devices.....	10 - 1
10.2	Z(P).MBRW	10 - 2
10.3	Z(P).MBREQ.....	10 - 14
10.4	ZP.UINI	10 - 25

CHAPTER11 TROUBLESHOOTING

11 - 1 to 11 - 47

11.1	Troubleshooting	11 - 1
11.2	Checking QJ71MB91 Status.....	11 - 11
11.3	Checking the Communication Status of QJ71MB91	11 - 17
11.4	Error Codes	11 - 21
11.4.1	Error code storage area.....	11 - 21
11.4.2	Exception code list	11 - 28
11.4.3	Error code list	11 - 30
11.5	Turning Off the ERR. LED	11 - 41
11.5.1	Turning off the ERR. LED by GX Configurator-MB	11 - 41
11.5.2	Turning off the ERR. LED by sequence program	11 - 45
11.5.3	Turning off the ERR. LED by request message from the master	11 - 47

APPENDICES**App - 1 to App - 14**

Appendix 1	Function Upgrade of the QJ71MB91	App - 1
Appendix 2	A Series Modules	App - 2
Appendix 2.1	Comparisons in performance specifications	App - 2
Appendix 2.2	Functional comparisons.....	App - 3
Appendix 2.3	Utilization of existing programs	App - 4
Appendix 3	Processing Time	App - 7
Appendix 4	External Dimensions	App - 13

INDEX**Index - 1 to Index - 2**

Compliance with the EMC and Low Voltage Directives

(1) For programmable controller system

To configure a system meeting the requirements of the EMC and Low Voltage Directives when incorporating the Mitsubishi programmable controller (EMC and Low Voltage Directives compliant) into other machinery or equipment, refer to Chapter 9 "EMC AND LOW VOLTAGE DIRECTIVES" of the QCPU User's Manual (Hardware Design, Maintenance and Inspection).

The CE mark, indicating compliance with the EMC and Low Voltage Directives, is printed on the rating plate of the programmable controller.

(2) For the product

No additional measures are necessary for the compliance of this product with the EMC and Low Voltage Directives.

The Manual's Usage and Structure

This manual lists the process and functions up to systems operation using the MODBUS® interface module (QJ71MB91), divided into subjects. Refer to the corresponding section when you need to know the following:

(1) Features (☞ CHAPTER 1)

CHAPTER 1 describes the features of the QJ71MB91.

(2) System Configuration (☞ CHAPTER 2)

Section 2.1 lists the applicable programmable controller CPU and corresponding software package.

Section 2.2 lists network configuration example.

(3) Performance and Specifications (☞ CHAPTER 3)

Section 3.1 lists the performance specifications of the QJ71MB91.

Section 3.2 and 3.3 list the specifications of each interface.

Section 3.4 and 3.5 list the I/O signals and buffer memory of the QJ71MB91.

(4) MODBUS® Standard Functions Supporting QJ71MB91 (☞ CHAPTER 4)

Section 4.1 lists the MODBUS® standard functions supporting QJ71MB91.

Sections 4.2 to 4.20 list the frame specifications of the MODBUS® standard functions supporting QJ71MB91.

(5) Usable Functions (☞ CHAPTER 5)

CHAPTER 5 describes the functions of the QJ71MB91.

(6) Settings and Procedures Necessary for System Operation

(☞ CHAPTER 6)

CHAPTER 6 describes the pre-operation settings and procedures.

(7) Parameter Settings of the QJ71MB91 (☞ CHAPTER 7)

CHAPTER 7 describes the parameter setting procedures and parameter details.

(8) Setting Parameters from the Utility Package (☞ CHAPTER 8)

CHAPTER 8 describes how to use the utility package.

(9) Setting Parameters from the Sequence Program (☞ CHAPTER 9)

CHAPTER 9 describes the I/O signals used for parameter settings, the I/O signal timing charts, and program examples.

(10) Reading from/Writing to the MODBUS® Device using the Sequence Program (☞ CHAPTER 10)

CHAPTER 10 describes the dedicated instructions designed to read or write MODBUS® device data with sequence programs.

(11)Error Code and Corresponding Process Details (👉 CHAPTER 11)

Section 11.1 lists troubleshooting.

Section 11.2 lists the confirmation methods of the module conditions.

Section 11.3 lists the confirmation of the communication conditions.

Section 11.4 lists the storage location and details of the error codes.

Section 11.5 lists the methods to turn off the ERR. LED.

▪ About the notation of the numerical values used in this manual

In this manual, the numerical values with the suffix "H" are displayed in hexadecimal values.

(Example) 10.....Decimal
 10H....Hexadecimal

About the Generic Terms and Abbreviations

Unless otherwise specified, this manual uses the following generic terms and abbreviations to explain the QJ71MB91 MODBUS® interface module.

General term/Abbreviation	Description
QJ71MB91	Abbreviation for the QJ71MB91 MODBUS® interface module.
GX Developer	Generic product name for SWnD5C-GPPW-E, SWnD5C-GPPW-EA, SWnD5C-GPPW-EV, and SWnD5C-GPPW-EVA. ("n" means version 4 or later.) "-A" and "-V" mean "volume license product" and "version-upgrade product" respectively.
MODBUS® Protocol	Generic term for the protocol designed to use MODBUS® protocol messages.
FC	Abbreviation for the function code.
SC	Abbreviation for the sub code.
Programmable controller CPU	Generic term for the Q00JCPU, Q00CPU, Q01CPU, Q02CPU, Q02HCPU, Q06HCPU, Q12HCPU, Q25HCPU, Q02PHCPU, Q06PHCPU, Q12PHCPU, Q25PHCPU, Q12PRHCPU, Q25PRHCPU, Q00UJCPU, Q00UCPU, Q01UCPU, Q02UCPU, Q03UDCPU, Q04UDHCPU, Q06UDHCPU, Q10UDHCPU, Q13UDHCPU, Q20UDHCPU, Q26UDHCPU, Q03UDECPU, Q04UDEHCPU, Q06UDEHCPU, Q10UDEHCPU, Q13UDEHCPU, Q20UDEHCPU and Q26UDEHCPU
Master	The side from which a request is sent to execute a function.
Slave	The side where the execution request from the master is processed and its execution result is sent.
Master function	The function that allows communication with the MODBUS® compatible slave device as the master of MODBUS® .
Slave function	The function that allows communication with the MODBUS® compatible master device as the slave of MODBUS® .
Request message	The message used to give a function execution request to the slave In the MODBUS® protocol, a function execution request is given from the master to the slave. A function execution request cannot be given from the slave to the master.
Response message	The message with which the slave returns a function execution result to the master.
Target device	Abbreviation of the connected communication targets (devices corresponding to personal computers, other QJ71MB91 MODBUS® interface modules, MODBUS® protocols) for data communication.
Personal computer	Abbreviation for DOS/V personal computers of IBM PC/AT and compatible.
MELSECNET/H	Abbreviation of the MELSECNET/H network system.
MBRW	Abbreviation for Z.MBRW or ZP.MBRW.
MBREQ	Abbreviation for Z.MBREQ or ZP.MBREQ.
UINI	Abbreviation for ZP.UINI.
Windows Vista®	Generic term for the following: Microsoft® Windows Vista® Home Basic Operating System, Microsoft® Windows Vista® Home Premium Operating System, Microsoft® Windows Vista® Business Operating System, Microsoft® Windows Vista® Ultimate Operating System, Microsoft® Windows Vista® Enterprise Operating System
Windows® XP	Generic term for the following: Microsoft® Windows® XP Professional Operating System, Microsoft® Windows® XP Home Edition Operating System

Meanings and Definitions of Terms

The following explains the meanings and definitions of the terms used in this manual.

Term	Description
MODBUS [®] protocol	Communication protocol developed for programmable controller by Schneider Electric SA.
MODBUS [®] device	Device used for communication using the MODBUS [®] protocol
Sequence program	Programming system devised to make a contact type sequence compatible with the programmable controller language as-is. Draw two vertical control buses and describe contacts, etc. between the buses to perform programming.
Device memory	Memory provided for the programmable controller CPU to record the data handled in sequence program operation.
Listen only mode	Mode detaching the slave station from the circuit.

Product Configuration

The following indicates the product configuration of the QJ71MB91 MODBUS[®] interface module.

Model	Product name	Quantity
QJ71MB91	QJ71MB91 MODBUS [®] interface module	1
	Terminal resistor 330 Ω 1/4 W (for RS-422 communication)	2
	Terminal resistor 110 Ω 1/2 W (for RS-485 communication)	2
SW1D5C-QMBU-E	GX Configurator-MB Version 1 (1-license product) (CD-ROM)	1
SW1D5C-QMBU-EA	GX Configurator-MB Version 1 (Multiple-license product) (CD-ROM)	1

CHAPTER1 OVERVIEW

This manual explains the specifications, functions, programming, and troubleshooting of the MELSEC-Q series QJ71MB91 MODBUS[®] interface module (hereinafter referred to as QJ71MB91).

The QJ71MB91 is used when a MELSEC-Q series programmable controller is connected to the MODBUS[®] protocol system.

MODBUS[®] is a registered trademark of Schneider Electric S.A.

1.1 Features

(1) Supporting the master function of MODBUS[®] communication

The QJ71MB91 supports the master function of the MODBUS[®] communication, which is an open network system for factory automation, and thereby is compatible with various MODBUS[®] slave devices (hereinafter referred to as slave) of other manufacturers.

The master function includes the following two functions.

(a) Automatic communication function

By setting the automatic communication parameters, MODBUS[®] device data can be automatically read from or written to the slaves at the specified intervals using the QJ71MB91 buffer memory.*1

Data can be transferred between the QJ71MB91 buffer memory and programmable controller CPU device memory by making the auto refresh setting with the utility package (GX Configurator-MB) or by accessing any intelligent function module device with a sequence program.

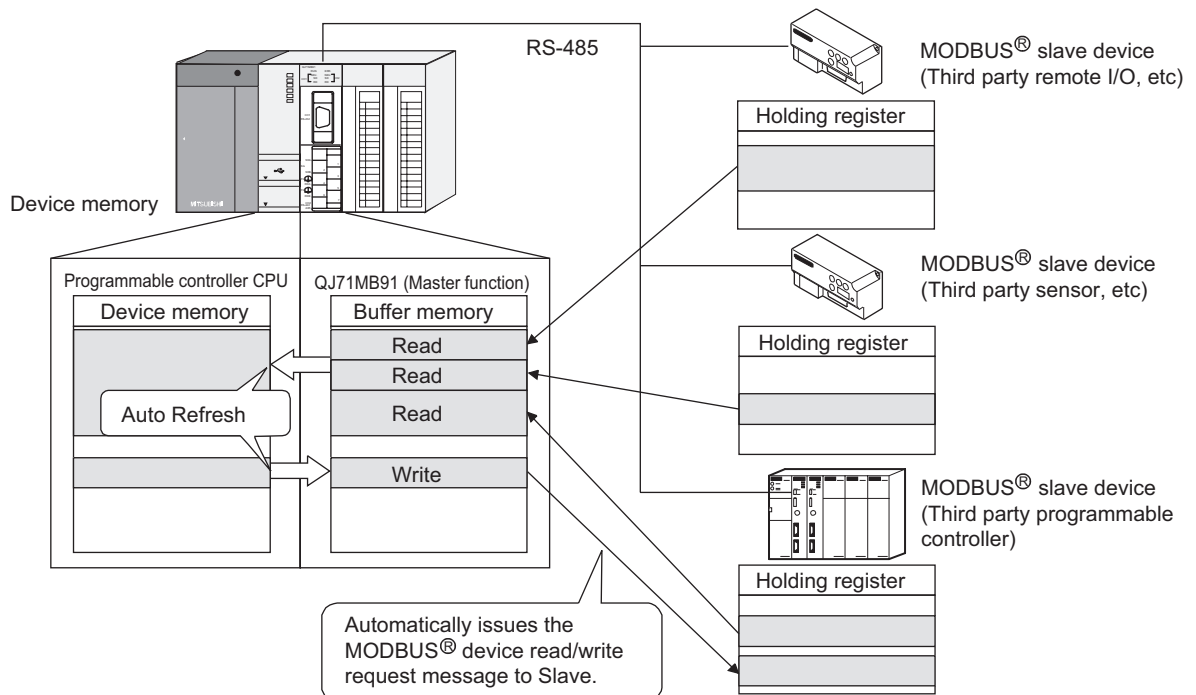

Figure 1.1 Communication using the automatic communication function

* 1 The MODBUS[®] device is defined as a device area of the slave where data can be read/written in response to a request from the master.

(b) Communication using dedicated instruction

Dedicated instructions can be used to make communication from sequence programs at any timing.

The following dedicated instructions are available for the QJ71MB91. (☞ CHAPTER 10)

1) MBRW instruction

Reads or writes MODBUS[®] device data from or to a slave.

This enables reading slave data to the programmable controller CPU device memory or writing programmable controller CPU data to slaves.

2) MBREQ instruction

The user-determined request message format (function code + data unit) can be issued to the slaves.

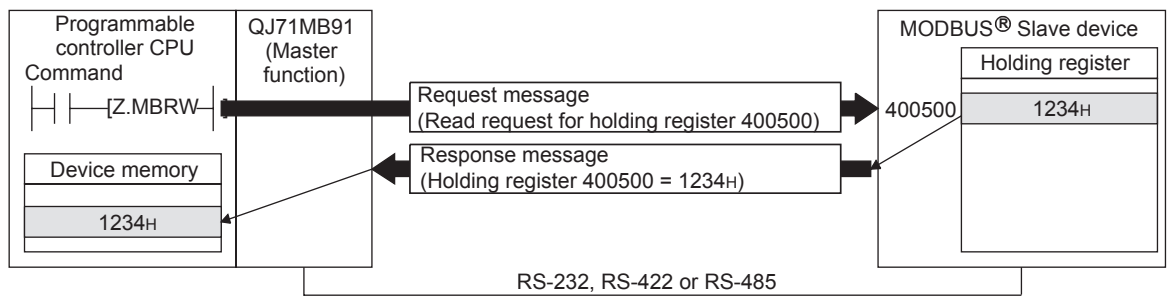

Figure 1.2 Communication using dedicated instruction

(2) Supporting the slave function of MODBUS[®] communication

The QJ71MB91 supports the slave function of the MODBUS[®] communication, which is an open network system for factory automation, and thereby is compatible with various MODBUS[®] master devices (hereinafter referred to as master) of other manufacturers.

The slave function includes the following two functions.

(a) Automatic response function

The QJ71MB91 can automatically respond to a request message received from the master.

Any sequence program for the slave function is not needed.

(b) MODBUS[®] device assignment function

Using MODBUS[®] device assignment parameters, the MODBUS[®] devices are correlated with the programmable controller CPU device memory.

This enables direct access from the master to the programmable controller CPU device memory.

Supporting the MODBUS[®] devices of large capacity, the QJ71MB91 allows all device memories of the programmable controller CPU to be assigned.

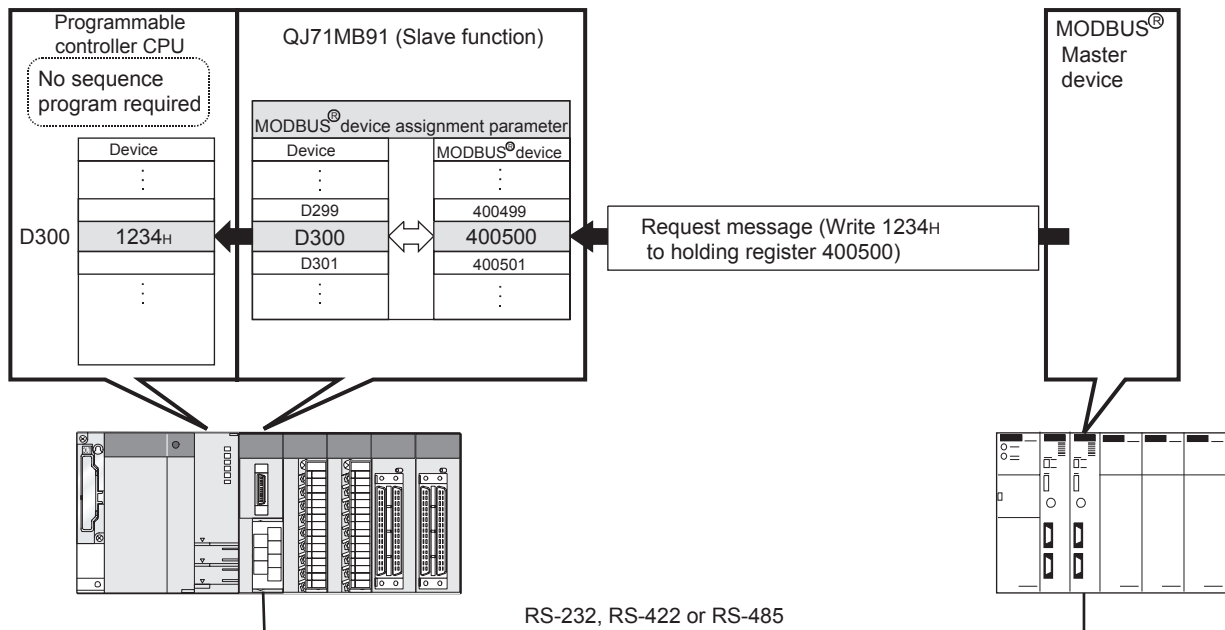

Figure 1.3 MODBUS[®] device assignment function

(3) Link operation function

The master connected to the CH1 side (RS-232) can communicate with multiple slaves connected to the CH2 side (RS-422/485) via the QJ71MB91.

This function allows the MODBUS[®] master device with RS-232 interface (for one-on-one communication) to communicate with multiple MODBUS[®] slave devices.

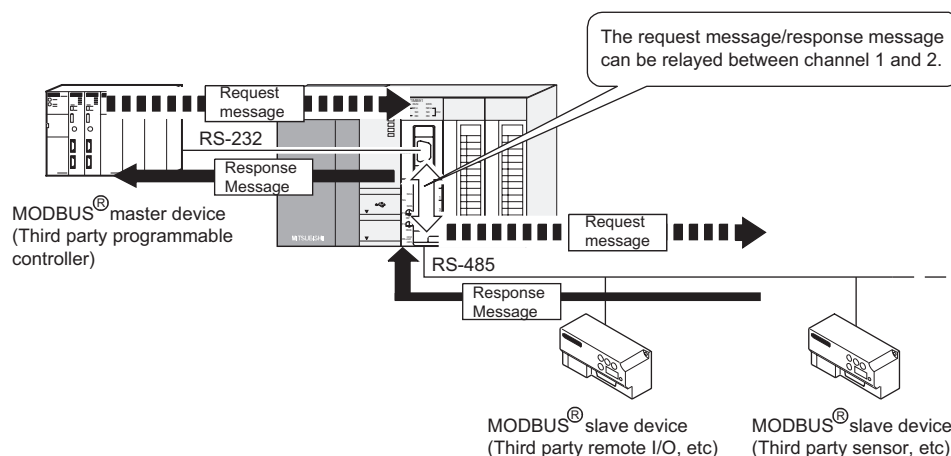

Figure 1.4 Communication using the link operation function

(4) Supporting high-speed communication of 115200 bps.

The total transmission speed of up to 115200bps is available for Channel 1 and 2.

(5) Easy setting by GX Configurator-MB

GX Configurator-MB, which is separately available, allows easy configuration of the QJ71MB91.

It can reduce programming steps for sequence programs, and the setting and operating states of each module can be checked easily.

Therefore, GX Configurator-MB is recommended to be used for the QJ71MB91.

By setting various parameters in GX Configurator-MB, the QJ71MB91 can communicate without creating sequence programs.

CHAPTER2 SYSTEM CONFIGURATION

This chapter explains the system configuration of the QJ71MB91.

2.1 Applicable Systems

This section describes the applicable systems.

(1) Applicable modules and base units, and No. of modules

(a) When mounted with a CPU module

The table below shows the CPU modules and base units applicable to the QJ71MB91 and quantities for each CPU model.

Depending on the combination with other modules or the number of mounted modules, power supply capacity may be insufficient.

Pay attention to the power supply capacity before mounting modules, and if the power supply capacity is insufficient, change the combination of the modules.

Table2.1 Applicable CPU modules and base units, and No. of modules

Applicable CPU module		No. of modules*1	Base unit*2		
CPU type	CPU model		Main base unit*1	Extension base unit	
Programmable controller CPU	Basic model QCPU	Q00JCPU	Up to 8	○	○
		Q00CPU	Up to 24		
		Q01CPU			
	High Performance model QCPU	Q02CPU	Up to 64	○	○
		Q02HCPU			
		Q06HCPU			
		Q12HCPU			
	Process CPU	Q02PHCPU	Up to 64	○	○
		Q06PHCPU			
		Q12PHCPU			
		Q25PHCPU			
	Redundant CPU	Q12PRHCPU	Up to 53	×	○
		Q25PRHCPU			
	Universal model QCPU	Q00UJCPU	Up to 8	○	○
		Q00UCPU	Up to 24		
		Q01UCPU	Up to 36		
		Q02UCPU			
		Q03UDCPU	Up to 64		
		Q04UDHCPU			
Q06UDHCPU					
Q10UDHCPU					
Q13UDHCPU					
Q20UDHCPU					
Q26UDHCPU					

○: Applicable, ×: N/A

* 1 Limited within the range of I/O points for the CPU module.

* 2 Can be installed to any I/O slot of a base unit.

(Continued on next page)

Table2.1 Applicable CPU modules and base units, and No. of modules (Continued)

Applicable CPU module		No. of modules* ¹	Base unit* ²	
CPU type	CPU model		Main base unit* ¹	Extension base unit
Programmable controller CPU	Universal model QCPU	Q03UDECPU	○	○
		Q04UDEHCPU		
		Q06UDEHCPU		
		Q10UDEHCPU		
		Q13UDEHCPU		
		Q20UDEHCPU		
	Q26UDEHCPU			
Safety CPU	QS001CPU	×	×* ³	
C Controller module	Q06CCPU-V	N/A	×	×
	Q06CCPU-V-B			

○: Applicable, ×: N/A

- * 1 Limited within the range of I/O points for the CPU module.
- * 2 Can be installed to any I/O slot of a base unit.
- * 3 Extension base unit cannot be installed to a safety CPU.

(b) Mounting to a MELSECNET/H remote I/O station

The table below shows the network modules and base units applicable to the QJ71MB91 and quantities for each network module model.

Depending on the combination with other modules or the number of mounted modules, power supply capacity may be insufficient.

Pay attention to the power supply capacity before mounting modules, and if the power supply capacity is insufficient, change the combination of the modules.

Table2.2 Mountable network modules, No. of mountable modules, and mountable base unit

Applicable network module	No. of modules* ¹	Base unit* ²	
		Main base unit of remote I/O station	Extension base unit of remote I/O station
QJ72LP25-25	Up to 64	○	○
QJ72LP25G			
QJ72LP25GE			
QJ72BR15			

○: Applicable, ×: N/A

- * 1 Limited within the range of I/O points for the network module.
- * 2 Can be installed to any I/O slot of a base unit.

Remark

The Basic model QCPU or C Controller module cannot create the MELSECNET/H remote I/O network.

(2) Support of the multiple CPU system

Please refer to the following manual before using the QJ71MB91 in the multiple CPU system.

QCPU User's Manual (Multiple CPU System)

(a) Compatible QJ71MB91

The function version of the first released QJ71MB91 is B, and it supports multiple CPU systems.

(b) Intelligent function module parameters

Write intelligent function module parameters to only the control CPU of the QJ71MB91.

(3) Supported software package

Relation between the system containing the QJ71MB91 and software package is shown in the following table.

GX Developer is required to start up the system in which the QJ71MB91 is used.

Table2.3 Supported software package

Item		Software version	
		GX Developer	GX Configurator-MB
Q00J/Q00/Q01CPU	Single CPU system	Version 7 or later	Version 1.05F or later
	Multiple CPU system	Version 8 or later	
Q02/Q02H/Q06H/ Q12H/Q25HCPU	Single CPU system	Version 4 or later	
	Multiple CPU system	Version 6 or later	
Q02PH/Q06PHCPU	Single CPU system	Version 8.68W or later	
	Multiple CPU system		
Q12PH/Q25PHCPU	Single CPU system	Version 7.10L or later	
	Multiple CPU system		
Q12PRH/Q25PRHCPU	Redundant system	Version 8.45X or later	
Q00UJ/Q00U/Q01UCPU	Single CPU system	Version 8.76E or later	
	Multiple CPU system		
Q02U/Q03UD/ Q04UDH/Q06UDHCPU	Single CPU system	Version 8.48A or later	
	Multiple CPU system		
Q10UDH/Q20UDHCPU	Single CPU system	Version 8.76E or later	
	Multiple CPU system		
Q13UDH/Q26UDHCPU	Single CPU system	Version 8.62Q or later	
	Multiple CPU system		
Q03UDE/Q04UDEH/Q06UDEH/ Q13UDEH/Q26UDEHCPU	Single CPU system	Version 8.68W or later	
	Multiple CPU system		
Q10UDEH/Q20UDEHCPU	Single CPU system	Version 8.76E or later	
	Multiple CPU system		
When mounted to MELSECNET/H remote I/O station		Version 6.01B or later	Version 1.05F or later

2.2 Network Configuration

The following shows MODBUS® network configuration examples using the QJ71MB91.

Table 2.4 Network configuration using QJ71MB91

QJ71MB91		System Configuration	Reference
Master/Slave	Line Used		
Master	RS-232	1:1	This section (1) (a)
	RS-422/485		This section (1) (b)
	RS-232, RS-422/485		This section (1) (c)
	RS-485	1:n	This section (1) (d)
Slave	RS-232	1:1	This section (2) (a)
	RS-422/485		This section (2) (b)
	RS-232, RS-422/485		This section (2) (c)
	RS-485	1:n	This section (2) (d)
	RS-232, RS-485 (with link operation function)	1:n	This section (2) (e)
Master/Slave	RS-232 (Master), RS-485 (Slave)	1:n	This section (3) (a)
	RS-232 (Slave) RS-485 (Master)		This section (3) (b)

(1) Using the QJ71MB91 as a master station

(a) Connecting to a slave station (1:1) with a RS-232 line

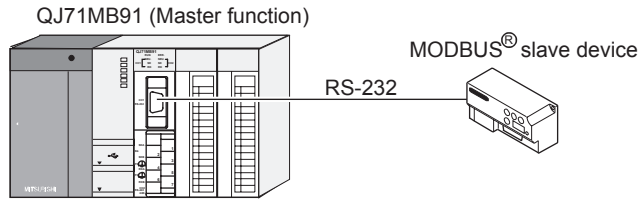

Figure 2.1 Connecting to a slave station (1:1) with a RS-232 line

(b) Connecting to a slave station (1:1) with a RS-422/485 line

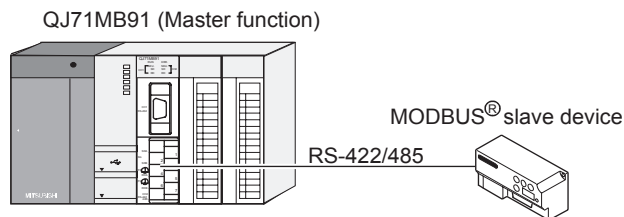

Figure 2.2 Connecting to a slave station with a RS-422/485 line

(c) Connecting to slave stations (1:1) with RS-232 and RS-422/485 lines

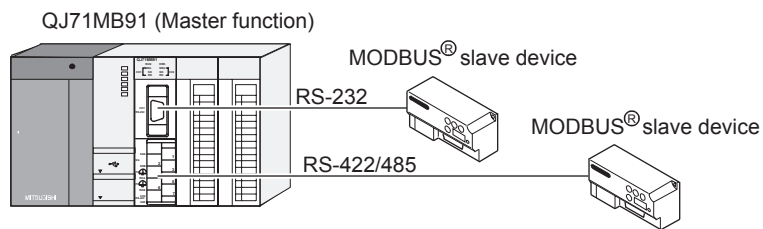

Figure 2.3 Connecting to slave stations (1:1) with RS-232 and RS-422/485 lines

(d) Connecting to slave stations (1:n)

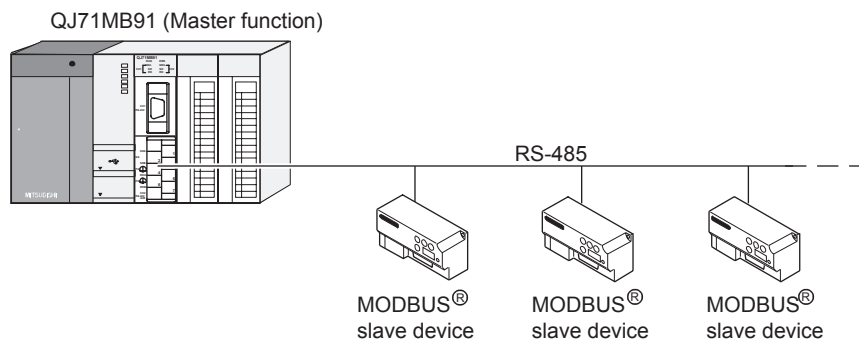

Figure 2.4 Connecting to slave stations (1:n)

(2) Using the QJ71MB91 as a slave station

(a) Connecting to a master station (1:1) with a RS-232 line

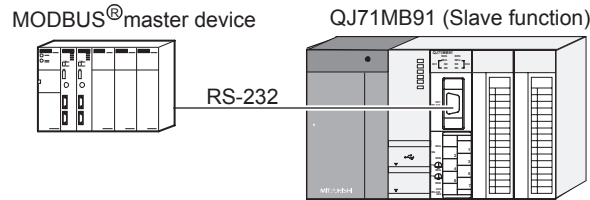

Figure 2.5 Connecting to a master station (1:1) with a RS-232 line

(b) Connecting to a master station (1:1) with a RS-422/485 line

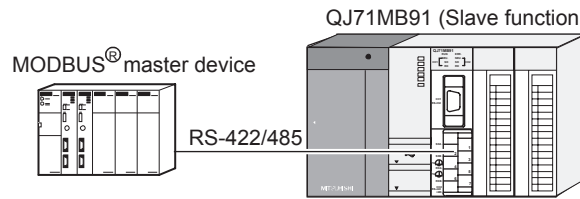

Figure 2.6 Connecting to a master station (1:1) with a RS-422/485 line

(c) Connecting to master stations (1:1) with RS-232 and RS-422/485 lines

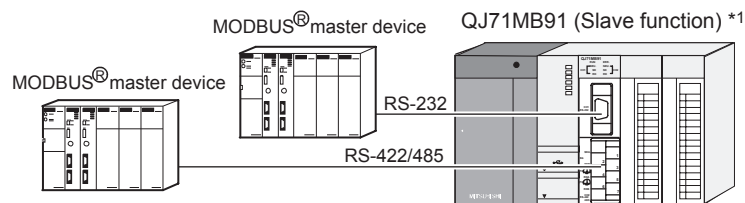

Figure 2.7 Connecting to master stations with RS-232 and RS-422/485 lines

* 1 The same station number is used for both RS-232 and RS-422/485 interfaces.

(d) Connecting to a master station (1:n)

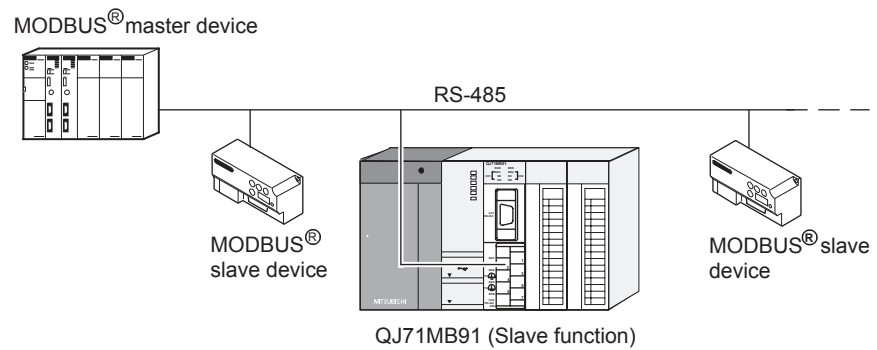

Figure 2.8 Connecting to a master station (1:n)

(e) Connecting to a master station (1:n) with the link operation function

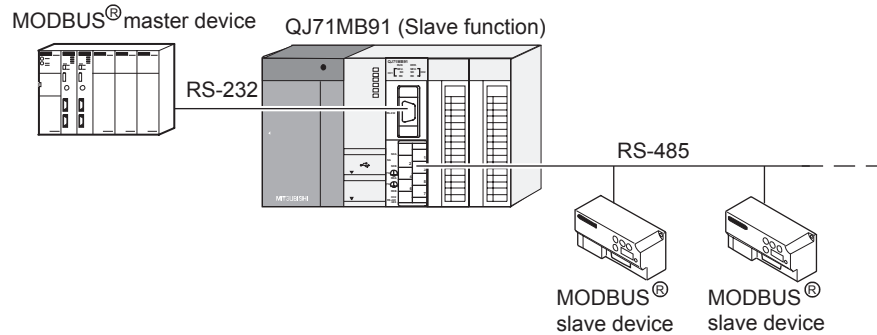

Figure 2.9 Connecting to a master station (1:n) with the link operation function

(3) Connecting master and slave stations separately through each interface

(a) Using the RS-232 interface as the master station and the RS-422/485 interface as the slave station

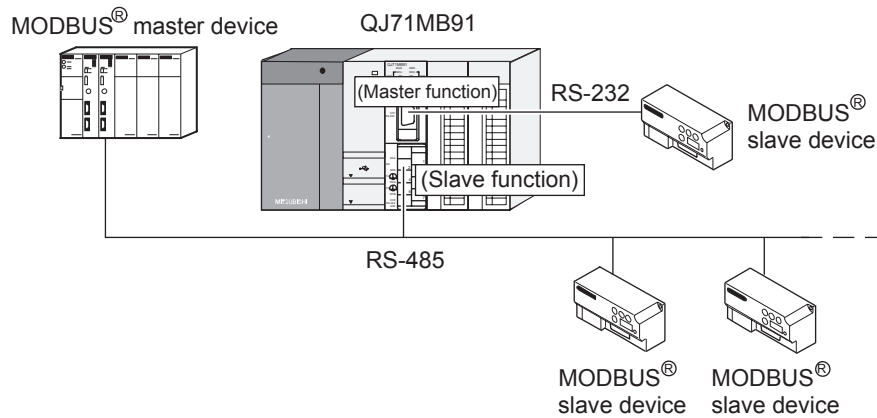

Figure 2.10 Using the RS-232 interface as the master station and the RS-422/485 interface as the slave station

(b) Using the RS-232 interface as the slave station and the RS-422/485 interface as the master station

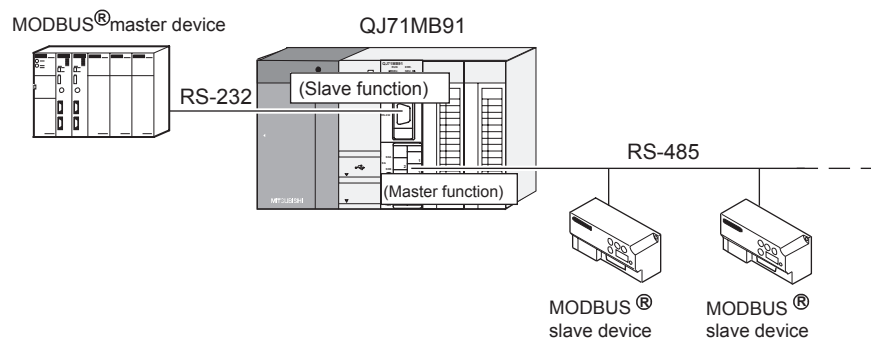

Figure 2.11 Using the RS-232 interface as the slave station and the RS-422/485 interface as the master station

2.3 Precautions for System Configuration

(1) For Use with Redundant CPU

(a) About dedicated instructions

Dedicated instructions cannot be used.

Instead of the MBRW instruction, use the automatic communication function.

(☞ Section 9.2.1, Section 9.3.1)

The MBREQ instruction cannot be used.

The UINI instruction cannot be used.

(b) GX Configurator-MB

GX Configurator-MB cannot be used when accessing the redundant CPU via an intelligent function module on an extension base unit from GX Developer.

Connect a personal computer with a communication path indicated below.

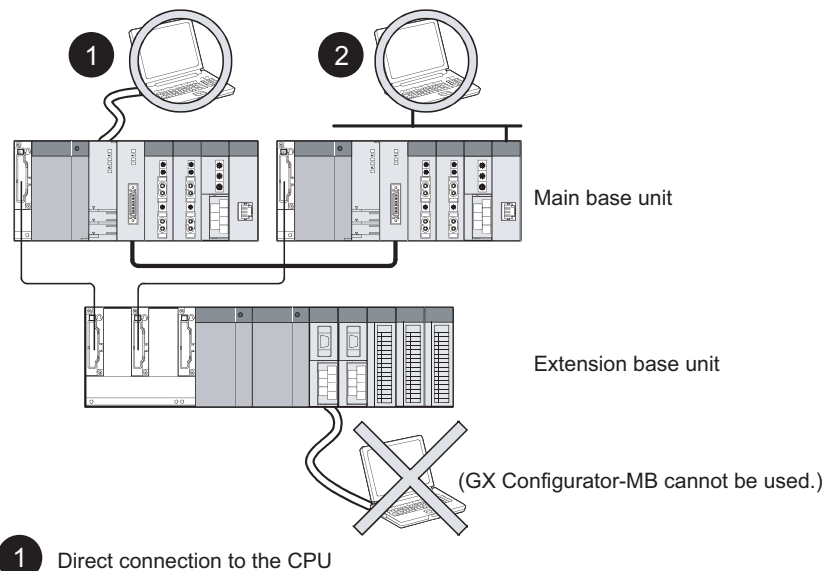

1 Direct connection to the CPU

2 Connection through an intelligent function module on the main base unit
(Through Ethernet module, MELSECNET/H module, or CC-Link module)

Figure 2.12 Communication paths available for GX Configurator-MB

2.4 How to Check the Function Version/Software Version

Check the function version and serial No. of the QJ71MB91 and the GX Configurator-MB software version by the following methods.

(1) Checking the version and serial No. of the QJ71MB91 functions

The serial No. and function version of the QJ71MB91 can be confirmed on the rating plate and GX Developer's system monitor.

(a) Confirming the serial number on the rating plate

The rating plate is situated on the side face of the QJ71MB91.

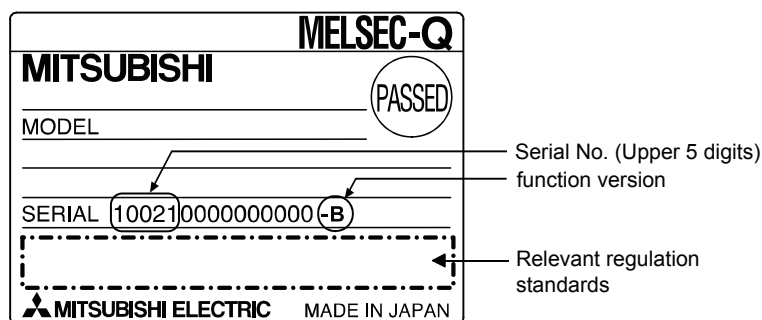

Figure 2.13 Rating plate

(b) Checking on the front of the module

The serial No. and function version on the rating plate are also indicated on the front of the module (lower part).

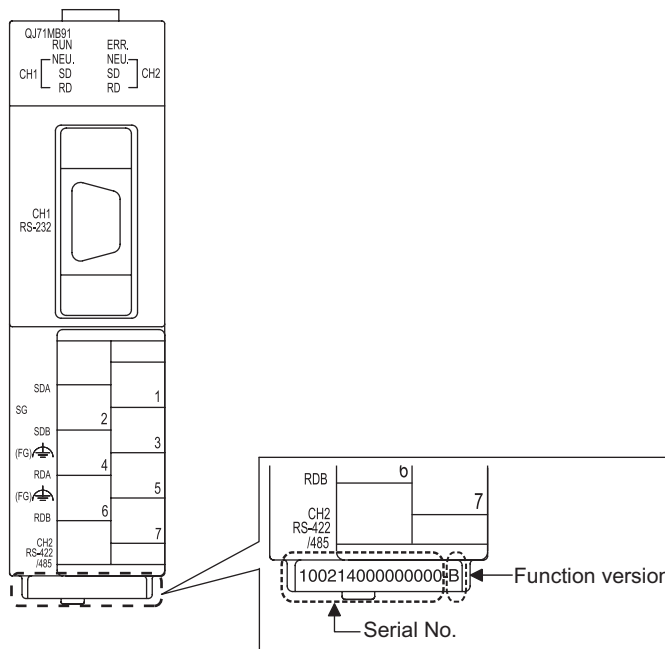

Figure 2.14 Front face of QJ71MB91

Remark

The serial number is displayed on the front of the module from January 2008 production. Products manufactured during switching period may not have the serial number on the front of the module.

- (c) Confirming the serial number on the system monitor (Product Information List)
 To display the system monitor, select [Diagnostics] → [System monitor] → Product Inf. List button of GX Developer.

Slot	Type	Series	Model name	Points	I/O No.	Master PLC	Serial No.	Ver.	Product No.
PLC	PLC	Q	Q06UDHCPU	-	-	-	0909200000000000	B	091013092955016-B
0-0	Intelli. Q	QJ71MB91		32pt	0000	-	0709100000000000	B	-
0-1	-	-	None	-	-	-	-	-	-
0-2	-	-	None	-	-	-	-	-	-
0-3	-	-	None	-	-	-	-	-	-
0-4	-	-	None	-	-	-	-	-	-

Figure 2.15 Product information list

- 1) Production number display
 Since the QJ71MB91 does not support the production number display, "-" is displayed.

☒ POINT

The serial No. displayed in the Product Information List of GX Developer may be different from the one on the rating plate and the front of the module.

- The serial No. on the rating plate and the front of the module indicates the management information of the product.
- The serial No. in the Product Information List of GX Developer indicates the functional information on the product, which is updated when a new function is added.

(2) Checking the software versio of GX Configurator-MB

The software version of GX Configurator-MB can be checked GX Developer's "Product information" screen.

[Operating Procedure]

GX Developer → [Help] → [Product information]

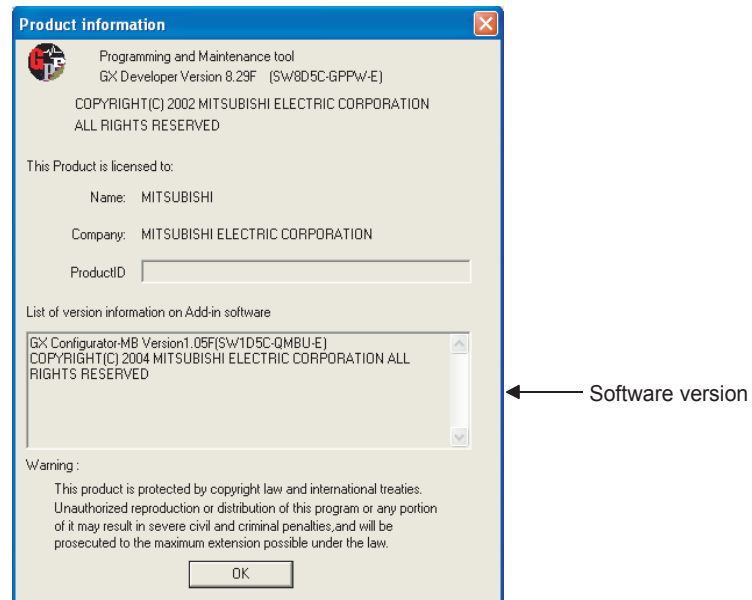

Figure 2.16 Product information

CHAPTER3 SPECIFICATIONS

This chapter explains the performance specifications of the QJ71MB91, interface specifications, I/O signals for communications with programmable controller CPU, and buffer memory.

Please refer to the following manual for general specifications.

 QCPU User's Manual (Hardware Design, Maintenance and Inspection)

3.1 Performance Specifications

This section provides the performance specifications of QJ71MB91.

Table3.1 Performance specifications

Item		Specifications	Reference												
Transmission specifications	Number of interfaces	RS-232 × 1 channel, RS-422/485 × 1 channel	-												
	Transmission speed	<table border="1"> <tr> <td>300</td> <td>600</td> <td>1200</td> <td>2400</td> </tr> <tr> <td>4800</td> <td>9600</td> <td>14400</td> <td>19200</td> </tr> <tr> <td>28800</td> <td>38400</td> <td>57600</td> <td>115200</td> </tr> </table> (bps) Communication is available with total transmission speed of two interfaces within 115200bps.	300	600	1200	2400	4800	9600	14400	19200	28800	38400	57600	115200	Section 6.6
	300	600	1200	2400											
	4800	9600	14400	19200											
28800	38400	57600	115200												
Transmission distance (Overall distance)	RS-232	Max. 15m (49.2 ft.)	-												
	RS-422/485	Max. 1200m (4592.4 ft.) (Overall distance)	-												
Master function	Automatic communication function	Number of slaves*1	32 per channel	-											
		Function (for send)	7 functions	Section 7.2.1											
		Input area size	4k words	Section 3.5.1											
		Output area size	4k words												
	Communication by dedicated instructions (MBRW, MBREQ)	Number of instructions that can be executed concurrently*2	1 per channel	CHAPTER 10											
		Function (for send)	MBRW instruction: 9 functions MBREQ instruction: 19 functions												
		Input area size	Max. 253 bytes per instruction												
		Output area size	Max. 253 bytes per instruction												

(Continued on next page)

Table3.1 Performance specifications (Continued)

Item		Specifications	Reference	
Slave function	Automatic response function	Function (for receive)	17 functions	CHAPTER 4
	MODBUS [®] Device size	Coil	64k points	Section 7.3.1
		Input	64k points	
		Input register	64k points	
		Holding register	64k points	
		Extended file register	Max. 4086k points	
	No. of simultaneously acceptable request messages		1 request per channel	-
Station No.		1 to 247	Section 6.6	
Number of occupied I/O points		32 points	-	
5VDC internal current consumption		0.31A	-	
External dimensions		98 (3.86 in.) (H) × 27.4 (1.08 in.) (W) × 90 (3.54 in.) (D) [mm]	Appendix 4	
Weight		0.20kg	-	

* 1 Indicates the maximum number of slaves that can be communication targets.

* 2 Indicates the maximum number of dedicated instructions that can be executed simultaneously from a sequence program.

3.2 RS-232 Interface Specification

This section explains RS-232 interface specifications.

3.2.1 RS-232 connector specification

This section provides the specifications of RS-232 connector that is connected to a target device.

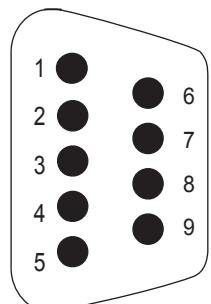

Pin number	Signal code	Signal name	Signal direction QJ71MB91 ←→ Target device
1	(Use prohibited)	(Use prohibited)	-
2	RD (RXD)	Reception data	←
3	SD (TXD)	Transmission data	→
4	(Use prohibited)	(Use prohibited)	-
5	SG (GND)	Signal ground	↔
6	(Use prohibited)	(Use prohibited)	-
7 ^{*1}	-	Output for cable disconnection detection	↺
8 ^{*1}	-	Input for cable disconnection detection	
9	(Use prohibited)	(Use prohibited)	-

Figure 3.1 RS-232 connector specification

* 1 Connect Pin 8 to Pin 7.

Without connecting Pin 7 and 8, Pin 8 turns off and the CS signal may turn off (error code: 7403 H).

(1) Descriptions of control signals

The following explains control signals. (The pin number of the connector is indicated within the brackets.)

- (a) RD signal (2)
Signal for receiving data.
- (b) SD signal (3)
Signal for sending data.

(2) ON/OFF status of each signal

The ON and OFF statuses of a signal are indicated below.

	(Output side)	(Input side)
ON5V to 15VDC,	3V to 15VDC
OFF-5V to -15VDC,	-3V to -15VDC

(3) Interface connector

For QJ71MB91 RS-232 interface connector, use a 9-pin D sub (female) screw type connector.

Use metric screws.

3.2.2 RS-232 cable specification

The RS-232 cable should be based on RS-232 standards and used within 15m(49.2ft).

3.3 RS-422/485 Interface Specification

This section explains RS-422/485 interface specifications.

3.3.1 RS-422/485 terminal block specification

This section provides the specifications of RS-422/485 terminal block that is connected to a target device.

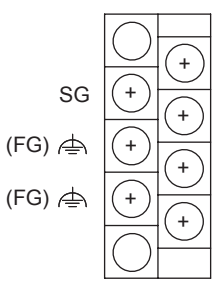

Signal code	Signal name	Signal direction QJ71MB91 ↔ Target device
SDA	Transmission data (+)	→
SDB	Transmission data (-)	→
RDA	Reception data (+)	←
RDB	Reception data (-)	←
SG	Signal ground	↔
FG	Frame ground	↔
FG	Frame ground	↔

Figure 3.2 RS-422/485 terminal block specifications

(1) The following explains control signals.

- (a) SDA, SDB signal
Signal for QJ71MB91 to send data to a target device
- (b) RDA, RDB signal
Signal for QJ71MB91 to receive data from a target device

(2) Terminating resistor

Connect the terminating resistor according to Section 6.5.2.

3.3.2 RS-422/485 cable specification

This section explains the specifications of RS-422/485 cable.

(1) RS-422/485 cable to be used

The RS-422/485 cable should meet the following specifications and used within 1200m(4592.4ft).

(2) When making a 1:n connection

When connecting to multiple devices (1:n), ensure that the overall distance is within 1200 m(4592.4ft).

(3) RS-422/485 cable specifications

Table3.2 RS-422/485 cable specifications

Item	Description
Cable type	Shielded cable
Number of pairs	3P
Conductor resistance (20°C)	88.0 Ω /km or less
Insulation resistance	10000M Ω -km or more
Dielectric withstand voltage	500VDC, 1 minute
Electrostatic capacitance (1 kHz)	60nF/km or less by an average
Characteristic impedance (100 kHz)	110±10 Ω
Recommended conductor size	0.2 mm ² to 0.75 mm ²

3.3.3 Precautions when transferring data using RS-422/485 line

Note the following points when performing data communication with a target device through the RS-422/485 interface of QJ71MB91.

For the target device side, pay attention to the following when sending/receiving data.

(1) Preventive measures against faulty data reception on the target device side

If the target device receives error data, install a pull-up or pull-down resistor to the target device as shown below.

Installing a pull-up or pull-down resistor (resistance value: approx. $4.7\text{ k}\Omega$, $1/4\text{ W}$) can prevent the reception of error data.

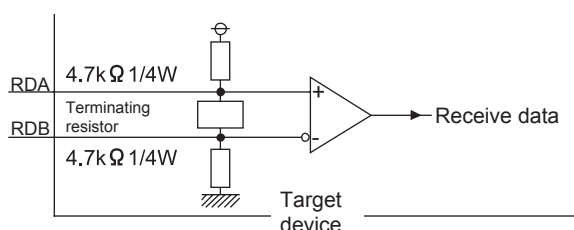

Figure 3.3 Preventive measures against faulty data reception

POINT

Error data will not be received if a pull-up or pull-down resistor is connected on the target device side.

Remark

The case where any pull-up or pull-down resistor is not connected on the target device is described below.

When any station is not performing transmission, the transmission line is in a high impedance status and the line status is not stable due to noises, and the target device may receive error data.

In such a case, parity or framing error may have occurred. Skip data reading for error data.

(2) RS-422/485 interface operation

(a) RS-422/485 interface configuration

For RS-422/485 interface, the configuration of driver (send)/receiver (receive) component of the QJ71MB91 is as shown in the following diagram.

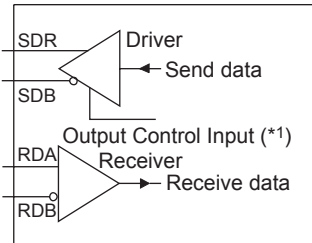

Figure 3.4 RS-422/485 interface configuration

* 1 The "output control input" (also referred to as send gate) of the driver (send) component determines whether to output data externally from SDA, SDB.

(b) RS-422/485 interface operation

When the "output control input" in the above figure is ON, the impedance status is low (data transmittable).

In addition, when the "output control input" is OFF, the impedance status is high (data not transmitted).

(c) QJ71MB91 transmission start timing, transmission process complete timing

- Transmission start timing

After releasing the high impedance status indicated in above (a) and (b), and outputting two or more character data during data transmission, output the actual data.

- Transmission process complete timing

Data transmission time for data of 1 bit or less is required as the H/W gate OFF time to complete the transmission process (high impedance status) after finishing data transmission.

(Transmission speed set in the QJ71MB91 is targeted.)

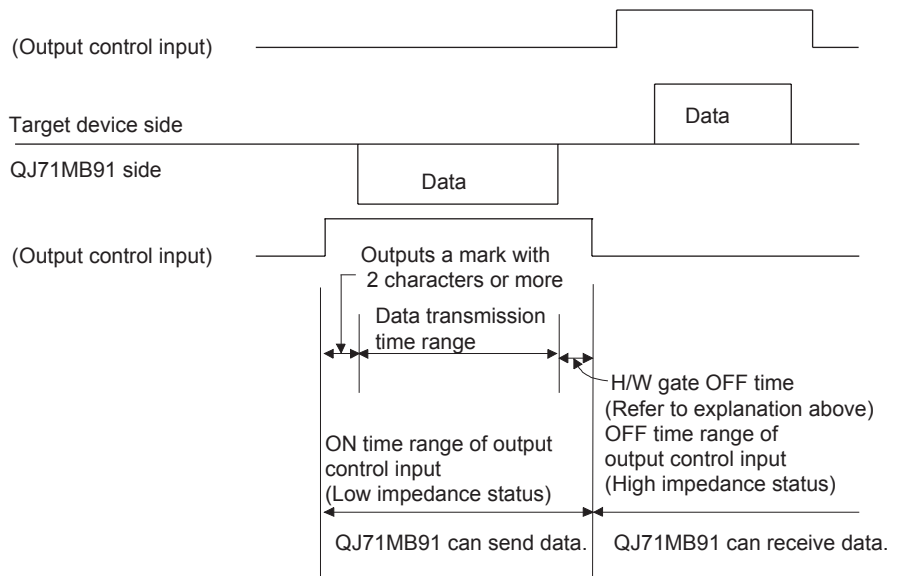

Figure 3.5 Transmission process complete timing

3.4 I/O Signals for Programmable Controller CPU

This section explains the I/O signals for the programmable controller CPU of QJ71MB91.

3.4.1 I/O signal list

This section explains the I/O signals for the QJ71MB91.

The following I/O signal assignment is based on the case where the start I/O No. of the QJ71MB91 is "0000" (installed to slot 0 of the main base unit).

Device X represents an input signal from the QJ71MB91 to the programmable controller CPU.

Device Y means an output signal from the programmable controller CPU to the QJ71MB91.

The I/O signals for programmable controller CPU are listed below.

Refer to the reference sections for the details of each signal.

Table3.3 I/O signal list

Signal direction QJ71MB91 → Programmable controller CPU			Signal direction Programmable controller CPU → QJ71MB91		
Device No.	Signal name	Reference	Device No.	Signal name	Reference
X0	Module READY *1 ON : Accessible OFF : Inaccessible	Section 11.1	Y0	Use prohibited	-
X1	Use prohibited	-	Y1		
X2			Y2		
X3			Y3		
X4	CH1 Automatic communication parameter setting, normally completed ON : Normally completed OFF : -	Section 5.2.1, 9.1.1	Y4	CH1 Automatic communication parameter setting request/automatic communication start request ON : Being requested OFF : Not requested	Section 5.2.1, 9.1.1
X5	CH1 Automatic communication parameter setting, error completed ON : Error completed OFF : -		Y5	Use prohibited	-
X6	CH1 Automatic communication operation status ON : Operating OFF : Stopped		Y6	CH1 Automatic communication stop request ON : Being requested OFF : Not requested	Section 5.2.1
X7	CH1 Automatic communication error status ON : Error occurred OFF : No error	Section 5.2.1	Y7	Use prohibited	-

* 1 Turns ON when the QJ71MB91 is ready after the programmable controller is turned from OFF to ON or after the programmable controller CPU is reset.

(Continued on next page)

Table3.3 I/O signal list (Continued)

Signal direction QJ71MB91 → Programmable controller CPU			Signal direction Programmable controller CPU → QJ71MB91		
Device No.	Signal name	Reference	Device No.	Signal name	Reference
X8	MODBUS [®] device assignment parameter setting, normally completed ON : Normally completed OFF : -	Section 9.1.2	Y8	MODBUS [®] device assignment parameter setting request ON : Being requested OFF : Not requested	Section 9.1.2
X9	MODBUS [®] device assignment parameter setting, error completed ON : Error completed OFF : -		Y9	Use prohibited	-
XA	MODBUS [®] device assignment parameter setting existence ON : Parameters set OFF: No parameters set		YA		
XB	Use prohibited	YB			
XC	CH2 Automatic communication parameter setting, normally completed ON : Normally completed OFF : -	Section 5.2.1, 9.1.1	YC	CH2 Automatic communication parameter setting request/automatic communication start request ON : Being requested OFF : Not requested	Section 5.2.1, 9.1.1
XD	CH2 Automatic communication parameter setting, error completed ON : Error completed OFF : -		YD	Use prohibited	-
XE	CH2 Automatic communication operation status ON : Operating OFF : Stopped		YE	CH2 Automatic communication stop request ON : Being requested OFF : Not requested	Section 5.2.1
XF	CH2 Automatic communication error status ON : Error occurred OFF : No error	Section 5.2.1	YF	Use prohibited	-

(Continued on next page)

Table3.3 I/O signal list (Continued)

Signal direction QJ71MB91 → Programmable controller CPU			Signal direction Programmable controller CPU → QJ71MB91		
Device No.	Signal name	Reference	Device No.	Signal name	Reference
X10	Intelligent function module switch setting change status ON : Setting being changed OFF : Setting not changed	Section 10.4	Y10		
X11	Use prohibited	-	Y11	Use prohibited	-
X12		-	Y12		
X13		-	Y13		
X14		-	Y14		
X15		-	Y15		
X16		-	Y16		
X17		-	Y17		
X18		-	Y18		
X19		-	Y19		
X1A		-	Y1A		
X1B	CH Common/CH1 Error ON : Error occurred OFF : No error	Section 11.2	Y1B	CH Common/CH1 Error clear request ON : Being requested OFF : Not requested	Section 11.5
X1C	CH2 Error ON : Error occurred OFF : No error		Y1C	CH2 Error clear request ON : Being requested OFF : Not requested	
X1D	Use prohibited	-	Y1D	Use prohibited	-
X1E			Y1E		
X1F	Watch dog timer error ON : Module error occurred OFF : Module operating normally	Section 11.1	Y1F		

POINT

Do not output (turn ON) any "Use prohibited" signal among I/O signals for programmable controller CPU.
Doing so may cause the programmable controller system to malfunction.

3.5 Applications and Assignment of Buffer Memory

3.5.1 Buffer memory list

The buffer memory list is shown below.

Table3.4 Buffer memory list

Address	Application	Name	Initial value	Read/Write (*1)	Initial setting (*2)	Reference
0000 _H to 0001 _H (0 to 1)	System area (use prohibited)		-	-	-	-
0002 _H (2)	Status storage area	CH1 side error response code storage area	0 _H	R	×	Section 11.4.2
0003 _H (3)		System area (use prohibited)	-	-	-	-
0004 _H (4)		CH2 side error response code storage area	0 _H	R	×	Section 11.4.2
0005 _H (5)		System area (use prohibited)	-	-	-	-
0006 _H (6)		Detailed LED status	CH1 side detailed LED status storage area	0 _H	R	×
0007 _H (7)	CH2 side detailed LED status storage area		0 _H	R		
0008 _H (8)	Setting area	Detailed LED clear request	CH1 side detailed LED clear request storage area	0 _H	R/W	Section 11.5
0009 _H (9)			CH2 side detailed LED clear request storage area	0 _H	R/W	
000A _H (10)	Setting area	Setting error status read device	Device code	F000 _H	R/W	Section 7.3.4
000B _H (11)			Head device number	0 _H	R/W	
000C _H (12)	System area (use prohibited)		-	-	-	-

* 1 Indicates whether the reading (Read)/writing (Write) from the sequence program is enabled or disabled.

R: Readable W: Writable

* 2 Indicates whether setting on GX Configurator-MB is enabled or disabled.

○: Setting enabled ×: Setting disabled

(Continued on next page)

Table3.4 Buffer memory list (Continued)

Address	Application	Name	Initial value	Read/Write (*1)	Initial setting (*2)	Reference		
000D _H (13)	Setting area	CPU response monitoring timer value Set time = set value × 500ms	A _H	R/W	○	Section 7.3.6		
000E _H (14)		Access target (when mounted to MELSECNET/H remote I/O station)	0 _H	R/W		Section 7.3.5		
000F _H (15)		Allocated error status area	0 _H	R/W		Section 7.3.4		
0010 _H to 01FF _H (16 to 511)	System area (use prohibited)		-	-	-	-		
0200 _H to 0201 _H (512 to 513)	Automatic communication parameter	CH1 Automatic communication parameter 1	Setting parameter existence	0 _H	R/W	○	Section 7.2	
0202 _H (514)			Target station No.	1 _H	R/W			
0203 _H (515)			Request interval timer value Set time = set value × 10ms	0 _H	R/W			
0204 _H (516)			Response monitoring timer value/Broadcast delay value Set time = set value × 10ms	0 _H	R/W			
0205 _H (517)			Type specification of the target MODBUS [®] device	0000 _H	R/W			
0206 _H (518)			Read setting	Head buffer memory address	0000 _H			R/W
0207 _H (519)				Target MODBUS [®] device head number	0 _H			R/W
0208 _H (520)				Access points	0 _H			R/W
0209 _H (521)			Write setting	Head buffer memory address	0000 _H			R/W
020A _H (522)				Target MODBUS [®] device head number	0 _H			R/W
020B _H (523)	Access points	0 _H		R/W				

* 1 Indicates whether the reading (Read)/writing (Write) from the sequence program is enabled or disabled.

R: Readable W: Writable

* 2 Indicates whether setting on GX Configurator-MB is enabled or disabled.

○: Setting enabled ×: Setting disabled

(Continued on next page)

Table3.4 Buffer memory list (Continued)

Address	Application		Name	Initial value	Read/Write (*1)	Initial setting (*2)	Reference
020C _H to 037F _H (524 to 895)	Automatic communication parameter	CH1 Automatic communication parameter 2 to 32	(Same as CH1 Automatic communication parameter 1)			○	Section 7.2
0380 _H to 04FF _H (896 to 1279)		CH2 Automatic communication parameter 1 to 32	(Same as CH1 Automatic communication parameter 1)				
0500 _H to 08FF _H (1280 to 2303)	System area (use prohibited)			-	-	-	-
0900 _H (2304)	MODBUS [®] device assignment parameter	Coil assignment 1	Device code	0 _H	R/W	○	Section 7.3.1
0901 _H (2305)			Head device number	0 _H	R/W		
0902 _H (2306)			Head coil number	0 _H	R/W		
0903 _H (2307)			Assignment points	0 _H	R/W		
0904 _H to 093F _H (2308 to 2367)		Coil assignment 2 to 16	(Same as in Coil assignment 1)				

* 1 Indicates whether the reading (Read)/writing (Write) from the sequence program is enabled or disabled.

R: Readable W: Writable

* 2 Indicates whether setting on GX Configurator-MB is enabled or disabled.

○: Setting enabled ×: Setting disabled

(Continued on next page)

Table3.4 Buffer memory list (Continued)

Address	Application	Name	Initial value	Read/Write (*1)	Initial setting (*2)	Reference	
0940 _H (2368)	MODBUS [®] device assignment parameter	Input assignment 1	Device code	0 _H	R/W	○	Section 7.3.1
0941 _H (2369)			Head device number	0 _H	R/W		
0942 _H (2370)			Head input number	0 _H	R/W		
0943 _H (2371)			Assignment points	0 _H	R/W		
0944 _H to 097F _H (2372 to 2431)		Input assignment 2 to 16	(Same as input assignment 1)				
0980 _H (2432)		Input register assignment 1	Device code	0 _H	R/W	○	
0981 _H (2433)			Head device number	0 _H	R/W		
0982 _H (2434)			Head input register number	0 _H	R/W		
0983 _H (2435)			Assignment points	0 _H	R/W		
0984 _H to 09BF _H (2436 to 2495)		Input register assignment 2 to 16	(Same as in input register assignment 1)				

* 1 Indicates whether the reading (Read)/writing (Write) from the sequence program is enabled or disabled.

R: Readable W: Writable

* 2 Indicates whether setting on GX Configurator-MB is enabled or disabled.

○: Setting enabled ×: Setting disabled

(Continued on next page)

Table3.4 Buffer memory list (Continued)

Address	Application	Name	Initial value	Read/Write (*1)	Initial setting (*2)	Reference	
09C0 _H (2496)	MODBUS [®] device assignment parameter	Device code	0 _H	R/W	○	Section 7.3.1	
09C1 _H (2497)		Holding register assignment 1	Head device number	0 _H			R/W
09C2 _H (2498)		Head holding register number	0 _H	R/W			
09C3 _H (2499)		Assignment points	0 _H	R/W			
09C4 _H to 09FF _H (2500 to 2559)		Holding register assignment 2 to 16	(Same as in holding register assignment 1)				
0A00 _H to 0BFF _H (2560 to 3071)	System area (use prohibited)		-	-	-	-	
0C00 _H (3072)	Setting status	Switch 1: CH1 operation mode setting status	Intelligent function module switch status	R	×	Section 6.6, 11.2	
0C01 _H (3073)		Switch 2: CH1 transmission setting status		R			
0C02 _H (3074)		Switch 3: CH2 operation mode setting status		R			
0C03 _H (3075)		Switch 4: CH2 transmission setting status		R			
0C04 _H (3076)		Switch 5: CH1/CH2 Station No. setting status		R			
0C05 _H (3077)	Module status	LED ON status	0 _H	R	×	Section 6.3, 11.2	
0C06 _H (3078)	Operating status	Switch 1: CH1 operation mode status	Intelligent function module switch status	R	×	Section 10.4	
0C07 _H (3079)		Switch 2: CH1 transmission status		R			
0C08 _H (3080)		Switch 3: CH2 operation mode status		R			
0C09 _H (3081)		Switch 4: CH2 transmission status		R			
0C0A _H (3082)		Switch 5: CH1/CH2 Station No. status		R			
0C0B _H to 0C12 _H (3083 to 3090)	System area (use prohibited)		-	-	-	-	

* 1 Indicates whether the reading (Read)/writing (Write) from the sequence program is enabled or disabled.

R: Readable W: Writable

* 2 Indicates whether setting on GX Configurator-MB is enabled or disabled.

○: Setting enabled ×: Setting disabled

(Continued on next page)

Table3.4 Buffer memory list (Continued)

Address	Application	Name	Initial value	Read/Write (*1)	Initial setting (*2)	Reference	
0C13H (3091)	Operating status	Parameter error information	MODBUS® device assignment parameter error code storage area		0H	R	× Section 11.4.1
0C14H (3092)			MODBUS® device assignment parameter setting result storage area	Error, device type	0H	R	
0C15H (3093)				Error, assigned group No.	0H	R	
0C16H (3094)			CH1 Automatic communication parameter error code storage area		0H	R	
0C17H (3095)			CH1 Automatic communication parameter setting result storage area		0H	R	
0C18H (3096)			CH2 Automatic communication parameter error code storage area		0H	R	
0C19H (3097)			CH2 Automatic communication parameter setting result storage area		0H	R	
0C1AH to 0C1FH (3098 to 3103)			System area (use prohibited)		-	-	

* 1 Indicates whether the reading (Read)/writing (Write) from the sequence program is enabled or disabled.

R: Readable W: Writable

* 2 Indicates whether setting on GX Configurator-MB is enabled or disabled.

○: Setting enabled ×: Setting disabled

(Continued on next page)

Table3.4 Buffer memory list (Continued)

Address	Application	Name	Initial value	Read/Write (*1)	Initial setting (*2)	Reference	
0C20 _H to 0C21 _H (3104 to 3105)	Operating status	Communication condition monitor area	CH1 Automatic communication operation status storage area (Parameters 1 to 32)	0 _H	R	×	Section 11.4.1
0C22 _H to 0C23 _H (3106 to 3107)			CH2 Automatic communication operation status storage area (Parameters 1 to 32)	0 _H	R		
0C24 _H to 0C27 _H (3108 to 3111)			System area (use prohibited)	-	-	-	-
0C28 _H to 0C47 _H (3112 to 3143)			CH1 Automatic communication error code storage area (Parameters 1 to 32)	0 _H	R	×	Section 11.4.1
0C48 _H to 0C67 _H (3144 to 3175)			CH2 Automatic communication error code storage area (Parameters 1 to 32)	0 _H	R		
0C68 _H to 0CA7 _H (3176 to 3239)			System area (use prohibited)	-	-	-	-
0CA8 _H to 0CA9 _H (3240 to 3241)			CH1 Automatic communication setting status storage area (Parameters 1 to 32)	0 _H	R	×	Section 11.4.1
0CAA _H to 0CAB _H (3242 to 3243)			CH2 Automatic communication setting status storage area (Parameters 1 to 32)	0 _H	R		
0CAC _H to 0CAF _H (3244 to 3247)			System area (use prohibited)	-	-	-	-
0CB0 _H to 0CB1 _H (3248 to 3249)			CH1 Automatic communication ready status storage area (Parameters 1 to 32)	0 _H	R	-	Section 9.2.3
0CB2 _H to 0CB3 _H (3250 to 3251)			CH2 Automatic communication ready status storage area (Parameters 1 to 32)	0 _H	R	-	
0CB4 _H to 0CFD _H (3252 to 3325)			System area (use prohibited)	-	-	-	-

* 1 Indicates whether the reading (Read)/writing (Write) from the sequence program is enabled or disabled.

R: Readable W: Writable

* 2 Indicates whether setting on GX Configurator-MB is enabled or disabled.

○: Setting enabled ×: Setting disabled

(Continued on next page)

Table3.4 Buffer memory list (Continued)

Address	Application	Name	Initial value	Read/Write (*1)	Initial setting (*2)	Reference				
0CFE _H (3326)	Operating status	Error log	Number of errors occurred		0 _H	R	Section 11.4.1			
0CFF _H (3327)			Error log write pointer		0 _H	R				
0D00 _H (3328)			Error log 1	Detailed error code	0 _H	R		×		
0D01 _H (3329)				Exception code	0 _H	R				
0D02 _H (3330)				Function code	0 _H	R				
0D03 _H (3331)				CH	0 _H	R				
0D04 _H (3332)				Station No.	0 _H	R				
0D05 _H to 0D06 _H (3333 to 3334)				System area (use prohibited)	-	-			-	-
0D07 _H (3335)				Function	0 _H	R			×	Section 11.4.1
0D08 _H to 0DFF _H (3336 to 3583)			Error log 2 to 32	(Same as Error log 1)				×	Section 11.4.1	
0E00 _H to 0EFF _H (3584 to 3839)			System area (use prohibited)		-	-		-	-	

* 1 Indicates whether the reading (Read)/writing (Write) from the sequence program is enabled or disabled.

R: Readable W: Writable

* 2 Indicates whether setting on GX Configurator-MB is enabled or disabled.

○: Setting enabled ×: Setting disabled

(Continued on next page)

Table3.4 Buffer memory list (Continued)

Address	Application	Name	Initial value	Read/Write (*1)	Initial setting (*2)	Reference		
0F00H (3840)	Communication status	Diagnostic data for Master/Slave	Bus message count	0H	R	Section 11.3		
0F01H (3841)			Bus communication error count	0H	R			
0F02H (3842)			Character overrun error count	0H	R			
0F03H (3843)			Message discard count	0H	R			
0F04H (3844)			Data discard count	0H	R			
0F05H (3845)			Failed transmission count	0H	R			
0F06H (3846)		CH1 Communication status	Diagnostic data for Slave	Slave message count	0H		R	Section 4.12 Section 4.11.4 Section 4.11.5
0F07H (3847)				Slave no-response count	0H		R	
0F08H (3848)			Slave NAK count	0H	R			
0F09H (3849)			Slave busy count	0H	R			
0F0AH (3850)			Exception error count	0H	R			
0F0BH (3851)			Communications event count	0H	R			
0F0CH (3852)			2nd byte of end code	0AH	R			
0F0DH (3853)			Communications mode	0H	R			

* 1 Indicates whether the reading (Read)/writing (Write) from the sequence program is enabled or disabled.

R: Readable W: Writable

* 2 Indicates whether setting on GX Configurator-MB is enabled or disabled.

○: Setting enabled ×: Setting disabled

(Continued on next page)

1	OVERVIEW
2	SYSTEM CONFIGURATION
3	SPECIFICATIONS
4	MODBUS(R) STANDARD FUNCTIONS
5	FUNCTION
6	PRE-OPERATIONAL PROCEDURES AND SETTINGS
7	PARAMETER SETTING
8	UTILITY PACKAGE (GX Configurator-MB)

Table3.4 Buffer memory list (Continued)

Address	Application	Name	Initial value	Read/Write (*1)	Initial setting (*2)	Reference		
0F0E _H (3854)	Communication status	Diagnostic data for Master	Received exception error count	0 _H	R	×	Section 11.3	
0F0F _H (3855)			No-response count	0 _H	R			
0F10 _H (3856)			Broadcast count	0 _H	R			
0F11 _H (3857)			Received NAK count	0 _H	R			
0F12 _H (3858)			Received busy count	0 _H	R			
0F13 _H to 0F1E _H (3859 to 3870)		CH1 Communication status	System area (use prohibited)		-	-	-	-
0F1F _H (3871)			Communication event log (for Slave)	Communications event log count	0 _H	R	×	Section 4.13
0F20 _H to 0F3F _H (3872 to 3903)		Communications event log 1 to 64		0 _H	R			
0F40 _H to 0F7F _H (3904 to 3967)		CH2 Communication status	(Same as CH1 communication status)					Section 4.13
0F80 _H to 0FFD _H (3968 to 4093)		System area (use prohibited)		-	-	-	-	
0FFE _H (4094)	Unit test result	Hardware test result		0 _H	R	×	Section 6.4.1	
0FFF _H (4095)		Self-loopback test result		0 _H	R		Section 6.4.2	

* 1 Indicates whether the reading (Read)/writing (Write) from the sequence program is enabled or disabled.

R: Readable W: Writable

* 2 Indicates whether setting on GX Configurator-MB is enabled or disabled.

○: Setting enabled ×: Setting disabled

(Continued on next page)

Table3.4 Buffer memory list (Continued)

Address	Application	Name	Initial value	Read/Write (*1)	Initial setting (*2)	Reference
1000 _H to 1FFF _H (4096 to 8191)	Automatic communication function buffer	CH1 Automatic communication function buffer input area	0 _H	R	×	Section 5.2.1
2000 _H to 2FFF _H (8192 to 12287)		CH2 Automatic communication function buffer input area	0 _H	R	×	
3000 _H to 3FFF _H (12288 to 16383)		CH1 Automatic communication function buffer output area	0 _H	R/W	×	
4000 _H to 4FFF _H (16384 to 20479)		CH2 Automatic communication function buffer output area	0 _H	R/W	×	
5000 _H to 5FFF _H (20480 to 24575)	User free area		0 _H	R/W	×	Section 7.3.3

* 1 Indicates whether the reading (Read)/writing (Write) from the sequence program is enabled or disabled.

R: Readable W: Writable

* 2 Indicates whether setting on GX Configurator-MB is enabled or disabled.

○: Setting enabled ×: Setting disabled

CHAPTER4 MODBUS(R) STANDARD FUNCTIONS

This chapter explains the MODBUS[®] standard functions supported by the QJ71MB91. Using the MODBUS[®] standard functions allows you to read/write to programmable controller CPU devices and to load the QJ71MB91 status into the master.

4.1 MODBUS(R) Standard Function Support List

(1) MODBUS[®] standard function support list

The following table indicates a list of the MODBUS[®] standard functions supported by the QJ71MB91.

Table4.1 MODBUS[®] standard function support list

Function code (Sub code)	Sub-function code	Function	Description	Accessible devices per message	Broadcast	Reference
01	-	Read coils	Reads the status (ON/OFF) of one or more coils.	1 to 2000 points	×	Section 4.4
02	-	Read discrete inputs	Reads the status (ON/OFF) of one or more inputs.	1 to 2000 points	×	Section 4.5
03	-	Read holding registers	Reads the values of one or more holding registers.	1 to 125 points	×	Section 4.6
04	-	Read input registers	Reads the values of one or more input registers.	1 to 125 points	×	Section 4.7
05	-	Write single coil	Writes a value (ON/OFF) to one coil.	1 point	○	Section 4.8
06	-	Write single register	Writes a value to one holding register.	1 point	○	Section 4.9
07	-	Read exception status	Reads error status.	-	×	Section 4.10

(Continued on next page)

4 MODBUS(R) STANDARD FUNCTIONS

Table4.1 MODBUS[®] standard function support list (continued)

Function code (Sub code)	Sub-function code	Function	Description	Accessible devices per message	Broadcast	Reference
08	00	Return query data	Returns the contents of the request message without change. Used to check if the network or the target device is operating normally. (Loopback test)	-	×	Section 4.11.1
	01	Restart communications option	Initializes the communication port of the receiving channel side and restarts the slave function. (Clears counters such as the message count.) Returns to the online mode when it is in the listen only mode.	-	×	Section 4.11.2
	02	Return diagnostic register	Reads out the detailed LED status of the QJ71MB91 to the master.	-	×	Section 4.11.3
	03	Change ASCII input delimiter	Changes the 2nd byte (LF(0AH)) of the end code in the ASCII mode to a specified data.	-	×	Section 4.11.4
	04	Force listen only mode	Places a slave into the offline mode. Used when disconnecting a slave from the network.	-	×	Section 4.11.5
	10	Clear counters and diagnostic register	Clears counters (e.g. message count). Also, clears the diagnostic register and the error of the channel where the request message has been received.	-	×	Section 4.11.6
	11	Return bus message count	Reads out the number of messages detected on the line to the master.	-	×	Section 4.11.7
	12	Return bus communication error count	Reads out the number of error messages detected on the line to the master.	-	×	Section 4.11.8
	13	Return bus exception error count	Reads out the frequency of exception errors to the master.	-	×	Section 4.11.9
	14	Return slave message count	Reads out the number of the slave message processing to the master. (Including reception of broadcast request messages)	-	×	Section 4.11.10
15	Return slave no response count	Reads out the number of broadcast request messages received to the master.	-	×	Section 4.11.11	

(Continued on next page)

1	OVERVIEW
2	SYSTEM CONFIGURATION
3	SPECIFICATIONS
4	MODBUS(R) STANDARD FUNCTIONS
5	FUNCTION
6	PRE-OPERATIONAL PROCEDURES AND SETTINGS
7	PARAMETER SETTING
8	UTILITY PACKAGE (GX Configurator-MB)

4 MODBUS(R) STANDARD FUNCTIONS

Table4.1 MODBUS[®] standard function support list (continued)

Function code (Sub code)	Sub-function code	Function	Description	Accessible devices per message	Broadcast	Reference
08	16	Return slave NAK count	Reads out the number of NAK responses to the master. The QJ71MB91 always returns "0".	-	×	Section 4.11.12
	17	Return slave busy count	Reads out the number of busy responses to the master. The QJ71MB91 always returns "0".	-	×	Section 4.11.13
	18	Return bus character overrun count	To the master, reads out the number of times the request message size exceeds the upper limit.	-	×	Section 4.11.14
	19	Return IOP overrun error count	Reads the IOP overrun error counter value to the master. The QJ71MB91 returns to the master the number of times the request message size exceeds the upper limit. (Same as the Return bus character overrun count)	-	×	Section 4.11.15
	20	Clear overrun counter and flag	Clears the overrun error counter and flag. The QJ71MB91 clears the character overrun error counter value.	-	×	Section 4.11.16
11	-	Get communications event counter	Acquires the number of messages whose requested processing (read/write, diagnostics, etc.) have been normally completed. Whether the action corresponding to the request message is normally completed or not can be checked.	-	×	Section 4.12
12	-	Get communications event log	Acquires the communications event log of the QJ71MB91 into the master.	-	×	Section 4.13
15	-	Write multiple coils	Writes values (ON/OFF) to multiple coils.	1 to 1968 points	○	Section 4.14

(Continued on next page)

Table 4.1 MODBUS[®] standard function support list (continued)

Function code (Sub code)	Sub-function code	Function	Description	Accessible devices per message	Broadcast	Reference
16	-	Write multiple registers	Writes values to multiple holding registers.	1 to 123 points	○	Section 4.15
17	-	Report slave ID	Acquires the information of the slave (QJ71MB91) mounted station into the master.	-	×	Section 4.16
20(6)	-	Read file record	Reads values of one or more extended file registers.	1 to 124 points	×	Section 4.17
21(6)	-	Write file record	Writes values to one or more extended file registers.	1 to 122 points	×	Section 4.18
22	-	Mask write register	Masks the values stored in a single holding register with AND or OR and writes the value.	1 point	○	Section 4.19
23	-	Read/Write multiple registers	Reads from or writes to multiple holding registers.	Read: 1 to 125 points Write: 1 to 121 points	×	Section 4.20
24*1	-	Read FIFO queue	Reads values from the holding registers in FIFO queue structure.	-	-	-
43*1	-	Read device identification	Reads the module identification information of the slave.	-	-	-

* 1 The slave function of the QJ71MB91 does not support this function.
 (☞ This section (2))

Remark

The usable functions are limited when the QJ71MB91 is installed to a MELSECNET/H remote I/O station. (☞ This section (3))

1 OVERVIEW

2 SYSTEM CONFIGURATION

3 SPECIFICATIONS

4 MODBUS(R) STANDARD FUNCTIONS

5 FUNCTION

6 PRE-OPERATIONAL PROCEDURES AND SETTINGS

7 PARAMETER SETTING

8 UTILITY PACKAGE (GX Configurator-MB)

(2) Standard function support list for the master and slave functions

The following table indicates a standard function support list classified by the master and slave functions of the QJ71MB91.

Table4.2 Standard function support list for the master and slave functions

Function code (Sub code)	Sub-function code	Function	Master function			Slave function
			Automatic communication function	MBRW instruction	MBREQ instruction *1	
01	-	Read coils	○	○	○	○
02	-	Read discrete inputs	○	○	○	○
03	-	Read holding registers	○	○	○	○
04	-	Read input registers	○	○	○	○
05	-	Write single coil	×	×	○	○
06	-	Write single register	×	×	○	○
07	-	Read exception status	×	×	○	○
08	00	Return query data	×	×	○	○
	01	Restart communications option	×	×	○	○
	02	Return diagnostic register	×	×	○	○
	03	Change ASCII input delimiter	×	×	○	○
	04	Force listen only mode	×	×	○	○
	10	Clear counters and diagnostic register	×	×	○	○
	11	Return bus message count	×	×	○	○
	12	Return bus communication error count	×	×	○	○
	13	Return bus exception error count	×	×	○	○
	14	Return slave message count	×	×	○	○
	15	Return slave no response count	×	×	○	○
	16	Return slave NAK count	×	×	○	○

○ : Supported × : Not supported

* 1 Since the MBREQ instruction allows users to create request message frames, function codes other than the above can be also sent. (☞ Section 10.3)

(Continued on next page)

Table4.2 Standard function support list for the master and slave functions (Continued)

Function code (Sub code)	Sub-function code	Function	Master function			Slave function
			Automatic communication function	MBRW instruction	MBREQ instruction *1	
08	17	Return slave busy count	×	×	○	○
	18	Return bus character overrun count	×	×	○	○
	19	Return IOP overrun error count	×	×	○	○
	20	Clear overrun counter and flag	×	×	○	○
11	-	Get communications event counter	×	×	○	○
12	-	Get communications event log	×	×	○	○
15	-	Write multiple coils	○	○	○	○
16	-	Write multiple registers	○	○	○	○
17	-	Report slave ID	×	×	○	○
20(6)	-	Read file record	×	○	○	○
21(6)	-	Write file record	×	○	○	○
22	-	Mask write register	×	×	○	○
23	-	Read/Write multiple registers	○	○	○	○
24	-	Read FIFO queue	×	×	○	×
43	-	Read device identification	×	×	○	×

○ : Supported × : Not supported

* 1 Since the MBREQ instruction allows users to create request message frames, function codes other than the above can be also sent. (☞ Section 10.3)

Remark

The usable functions are limited when the QJ71MB91 is installed to a MELSECNET/H remote I/O station. (☞ This section (3))

(3) List of MODBUS® standard functions supported when accessing a MELSECNET/H remote I/O station

The following MODBUS® standard functions are available when the QJ71MB91 mounted on a MELSECNET/H remote I/O station makes access to the MELSECNET/H remote I/O station.

Table4.3 MODBUS® standard functions available for access to MELSECNET/H remote I/O station

Function code (Sub code)	Sub-function Code	Function	Master function			Slave function *1
			Automatic communication function	MBRW instruction	MBREQ instruction	
01	-	Read coils	○	×	×	△*2
02	-	Read discrete inputs	○			△*2
03	-	Read holding registers	○			△*2
04	-	Read input registers	○			△*2
05	-	Write single coil	×			△*2
06	-	Write single register	×			△*2
07	-	Read exception status	×			△*2

○ : Supported △ : Supported with restrictions × : Not supported

* 1 The access target is the MELSECNET/H remote I/O station.

When the MELSECNET/H remote master station is the access target, available functions are the same as those shown in (2).

* 2 Accessing the MODBUS® device that is not supported by the MELSECNET/H remote I/O station results in error completion. (Exception code: 04H)

If the access target is the MELSECNET/H remote master station, it can be assigned to the control CPU device of the MELSECNET/H remote master station.

(Continued on next page)

4 MODBUS(R) STANDARD FUNCTIONS

Table 4.3 MODBUS® standard functions available for access to MELSECNET/H remote I/O station (continued)

Function code (Sub code)	Sub-function code	Function	Master function			Slave function*1
			Automatic communication function	MBRW instruction	MBREQ instruction	
08	00	Return query data	×			○
	01	Restart communications option	×			○
	02	Return diagnostic register	×			○
	03	Change ASCII input delimiter	×			○
	04	Force listen only mode	×			○
	10	Clear counters and diagnostic register	×			○
	11	Return bus message count	×			○
	12	Return bus communication error count	×			○
	13	Return bus exception error count	×	×	×	○
	14	Return slave message count	×			○
	15	Return slave no response count	×			○
	16	Return slave NAK count	×			○
	17	Return slave busy count	×			○
	18	Return bus character overrun count	×			○
	19	Return IOP overrun error count	×			○
20	Clear overrun counter and flag	×			○	

○ : Supported △ : Supported with restrictions × : Not supported

- * 1 The access target is the MELSECNET/H remote I/O station.
When the MELSECNET/H remote master station is the access target, available functions are the same as those shown in (2).
- * 2 Accessing the MODBUS® device that is not supported by the MELSECNET/H remote I/O station results in error completion. (Exception code: 04H)
If the access target is the MELSECNET/H remote master station, it can be assigned to the control CPU device of the MELSECNET/H remote master station.

(Continued on next page)

1 OVERVIEW

2 SYSTEM CONFIGURATION

3 SPECIFICATIONS

4 MODBUS(R) STANDARD FUNCTIONS

5 FUNCTION

6 PRE-OPERATIONAL PROCEDURES AND SETTINGS

7 PARAMETER SETTING

8 UTILITY PACKAGE (GX Configurator-MB)

Table 4.3 MODBUS® standard functions available for access to MELSECNET/H remote I/O station (continued)

Function code (Sub code)	Sub-function code	Function	Master function			Slave function*1	
			Automatic communication function	MBRW instruction	MBREQ instruction		
11	-	Get communications event counter	×	×	×	○	
12	-	Get communications event log	×			○	
15	-	Write multiple coils	○			△*2	
16	-	Write multiple registers	○			△*2	
17	-	Report slave ID	×			○	
20(6)	-	Read file record	×			×	×
21(6)	-	Write file record	×			×	×
22	-	Mask write register	×			△*2	
23	-	Read/Write multiple registers	○			△*2	
24	-	Read FIFO queue	×			×	
43	-	Read device identification	×	×			

○ : Supported △ : Supported with restrictions × : Not supported

* 1 The access target is the MELSECNET/H remote I/O station.

When the MELSECNET/H remote master station is the access target, available functions are the same as those shown in (2).

* 2 Accessing the MODBUS® device that is not supported by the MELSECNET/H remote I/O station results in error completion. (Exception code: 04H)

If the access target is the MELSECNET/H remote master station, it can be assigned to the control CPU device of the MELSECNET/H remote master station.

POINT

When the QJ71MB91 is mounted to a MELSECNET/H remote I/O station, switch the access target using the Access target (when mounted to MELSECNET/H remote I/O station) in the buffer memory (address: 000EH). (→ Section 7.3.5)

4.2 Frame Specifications

The following shows the frame specifications for the MODBUS® protocol.

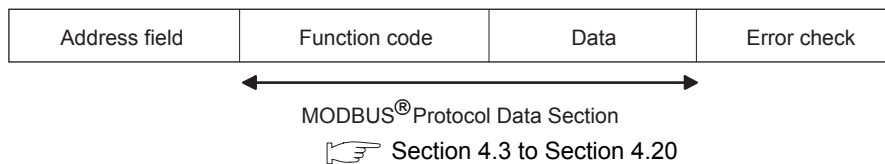

Figure 4.1 Frame specifications

Table 4.4 Frame specifications

Area name	Description
Address field	<p>[When master sends a request message to slave] 0: Sends a request message to all the slaves. (Broadcast) 1 to 247: Stores the target slave station No.</p> <p>[When slave sends a response message to master] The host station number is stored when sending a response message.</p>
Function code	<p>[When master sends a request message to slave] The master specifies the number of the action to be taken by the slave.</p> <p>[When slave sends a response message to master] A requested function code is stored in the case of normal completion. The most significant bit turns ON in the case of error completion.</p>
Data	<p>[When master sends a request message to slave] The information needed to execute the action specified by a function code is stored.</p> <p>[When slave sends a response message to master] The execution result of the action specified by a function code is stored. An exception code is stored when failed.</p>
Error check *1	<p>The master adds a check code in a request message and transmits the request message. The slave, which received the request message, recalculates the check code in the request message and determines whether the message is correct or not. The message is discarded if it has an error.</p>

* 1 The error check method differs depending on the frame mode. (Hand icon Section 4.2.1)

Remark

Refer to the following for the data size of each area.

Hand icon Section 4.2.1

1 OVERVIEW

2 SYSTEM CONFIGURATION

3 SPECIFICATIONS

4 MODBUS(R) STANDARD FUNCTIONS

5 FUNCTION

6 PRE-OPERATIONAL PROCEDURES AND SETTINGS

7 PARAMETER SETTING

8 UTILITY PACKAGE (GX Configurator-MB)

4.2.1 Frame mode

For the QJ71MB91, the following frame modes are available.
The frame mode of the QJ71MB91 must be consistent with that of the target device.

(1) Available frame modes

(a) RTU mode

In this mode, frames are received or sent in binary codes.
The frame specifications are compliant with the MODBUS® protocol specifications.

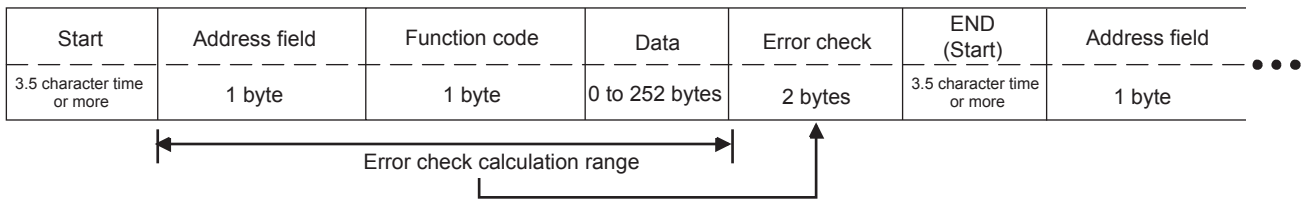

Figure 4.2 Frame in RTU mode

Remark

The error check in the RTU mode is conducted by CRC (Cyclic Redundancy Check).

The QJ71MB91 calculates the CRC by the following steps.

Please follow the same steps to calculate the CRC when conducting an error check on the target device.

- 1) Load the register whose 16 bits are all "1".
- 2) The CRC is calculated every 8 bits from the upper bit of the frame.
Calculate the 8 bits of the frame and the exclusive logical sum (XOR) of the bits in the above 1).
- 3) Shift the result of 2) by 1 bit to the right.
- 4) If the least significant bit of the above 2) is "1", calculate the exclusive OR (XOR) from the result in 3) and the generator polynomial (A001H).
If the least significant bit is "0", do not calculate the exclusive OR (XOR), but shift it by 1 bit to the right.
- 5) Repeat the above steps 3) and 4) until the bit is shifted up to 8 times.
- 6) Calculate the exclusive OR (XOR) from the result of 5) and the next 8 bits of the frame.
- 7) Repeat steps 3) to 6).
- 8) Repeat the above operations until the end of the data unit is reached.
The final value is a calculated CRC value.
- 9) The CRC value is stored in the frame in the order from the lower 8 bits to the upper 8 bits.

4 MODBUS(R) STANDARD FUNCTIONS

The following is a calculation example in the case where function code 07H is sent to station No. 2.

Table4.5 CRC calculation procedures

CRC error check procedure	16-bit register (MSB)				Flag
(Load the register whose 16 bits are all "1")	1111	1111	1111	1111	
02H(Station No.)			0000	0010	
Exclusive OR (XOR)	1111	1111	1111	1101	
Shift 1	0111	1111	1111	1110	1
Generator polynomial	1010	0000	0000	0001	
Exclusive OR (XOR)	1101	1111	1111	1111	
Shift2	0110	1111	1111	1111	1
Generator polynomial	1010	0000	0000	0001	
Exclusive OR (XOR)	1100	1111	1111	1110	
Shift3	0110	0111	1111	1111	0
Shift4	0011	0011	1111	1111	1
Generator polynomial	1010	0000	0000	0001	
Exclusive OR (XOR)	1001	0011	1111	1110	
Shift5	0100	1001	1111	1111	0
Shift6	0010	0100	1111	1111	1
Generator polynomial	1010	0000	0000	0001	
Exclusive OR (XOR)	1000	0100	1111	1110	
Shift7	0100	0010	0111	1111	0
Shift8	0010	0001	0011	1111	1
Generator polynomial	1010	0000	0000	0001	
Exclusive OR (XOR)	1000	0001	0011	1110	
07H(Function)			0000	0111	
Exclusive OR (XOR)	1000	0001	0011	1001	
Shift 1	0100	0000	1001	1100	1
Generator polynomial	1010	0000	0000	0001	
Exclusive OR (XOR)	1110	0000	1001	1101	
Shift2	0111	0000	0100	1110	1
Generator polynomial	1010	0000	0000	0001	
Exclusive OR (XOR)	1101	0000	0100	1111	
Shift3	0110	1000	0010	0111	1
Generator polynomial	1010	0000	0000	0001	
Exclusive OR (XOR)	1100	1000	0010	0110	
Shift4	0110	0100	0001	0011	0
Shift5	0011	0010	0000	1001	1
Generator polynomial	1010	0000	0000	0001	
Exclusive OR (XOR)	1001	0010	0000	1000	
Shift6	0100	1001	0000	0100	0
Shift7	0010	0100	1000	0010	0
Shift8	0001	0010	0100	0001	0
CRC value	12H		41H		

Address field	Function code	CRC (Error check)	
(02H)	(07H)	(41H)	(12H)

Figure 4.3 Frame for CRC calculation

(b) ASCII mode

In this mode, frames are received or sent in units of 2 characters (2 bytes) in ASCII codes.

The frame specifications are compliant with the MODBUS® protocol specifications.

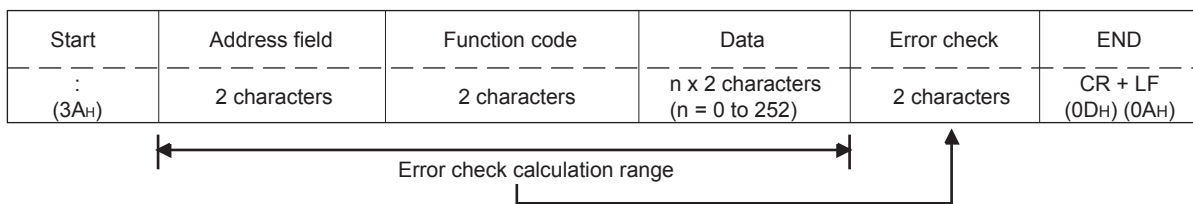

Figure 4.4 Frame in ASCII mode

Remark

The error check in the ASCII mode is conducted by LRC (Longitudinal Redundancy Check).

The QJ71MB91 calculates the LRC by the following steps.

Please follow the same steps to calculate the LRC when conducting an error check on the target device.

- 1) To calculate the LRC, convert the ASCII codes within the error check range into the RTU format (binary).
- 2) Add the figures in units of contiguous 8 bits in the frame. (Excluding carries during addition.)
- 3) Change the result of the above 2) to a 2's complement. (Reverse the bits and add 01H.)
- 4) Convert the result of 3) to an ASCII code.

4 MODBUS(R) STANDARD FUNCTIONS

The following are calculation examples in the case where function code 01H is sent to station No. 2.

Table4.6 LRC calculation procedure (when sending a request message)

LRC in request message transmission			
Station No. (address field)	02	0000	0010
Function code	01	0000	0001
Head coil number (H)	00	0000	0000
Head coil number(L)	00	0000	0000
Read points (H)	00	0000	0000
Read points (L)	08	+0000	1000
Addition result	0B	0000	1011
Bit reversal 1	F4	1111	0100
+1			1
2's complement	F5	1111	0101
LRC (Error check)	F5	F	5

Table4.7 LRC calculation procedure (when receiving a response message)

LRC in reception of a response message			
Station No. (address field)	02	0000	0010
Function code	01	0000	0001
Head coil number(H)	00	0000	0000
Head coil number(L)	00	0000	0000
Read points (H)	00	0000	0000
Read points (L)	08	0000	1000
LRC (Error check)	F5	+1111	0101
Addition result	00	0000	0000

Start :	Address field (02H)		Function code (01H)		Head input number				Read points				CRC (Error check) (F5H)		"CR"	"LF"
					(00H)		(00H)		(00H)		(08H)					
3AH	30H	32H	30H	31H	30H	30H	30H	30H	30H	30H	30H	38H	46H	35H	0DH	0AH

Figure 4.5 Frame for LRC calculation

(2) Frame mode setting

The frame mode is set in the intelligent function module switch setting.

(☞ Section 6.6)

4.3 Protocol Data Unit Formats by Functions

This section describes MODBUS[®] protocol data unit formats used in the QJ71MB91.

(1) Precautions

(a) Device number specified in messages

When specifying a device number in a message, specify it as "(Device number) - 1".

However, this does not apply to the file and device numbers specified for reading/writing the extended file register.

(Example) When reading input 32 (100032) with Read Discrete Inputs (FC: 02)

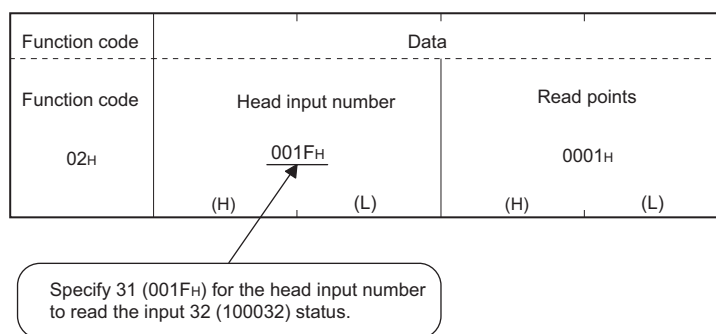

Figure 4.6 Specifying the MODBUS[®] device number

The device number to be stored in the response message is "(Device number of actually read/written device) - 1".

(b) When the QJ71MB91 receives a broadcast request message

Although the processing (read/write, diagnostics, etc.) requested by the request message is performed, no response message is sent to the master.

(c) When the QJ71MB91 receives a request message in the listen only mode

The request message is discarded except for a particular case.
To receive the request message, change it to the online mode.

(☞ Section 4.11.5)

(2) When the processing is completed in error at the slave (QJ71MB91)

When the processing (read/write, diagnostics, etc.) requested by the request message is completed in error, an exception code is sent to the master. (☞ "Response message formats (when completed with an error)" in Section 4.4 to 4.20.)

(a) Storage location of exception code and error code

The exception code is also stored in the buffer memory of the QJ71MB91.

Furthermore, for identification of detailed causes, an error code is stored in the QJ71MB91 buffer memory.

The exception code and error codes can be confirmed by the error log area of the buffer memory (address: 0CFEH to 0DFFH). (☞ Section 11.4)

(3) How to see the request/response message formats provided in Section 4.4 to 4.20

(a) Request/Response message format diagram

The following shows how to see the request/response message format diagrams provided in Section 4.4 to 4.20.

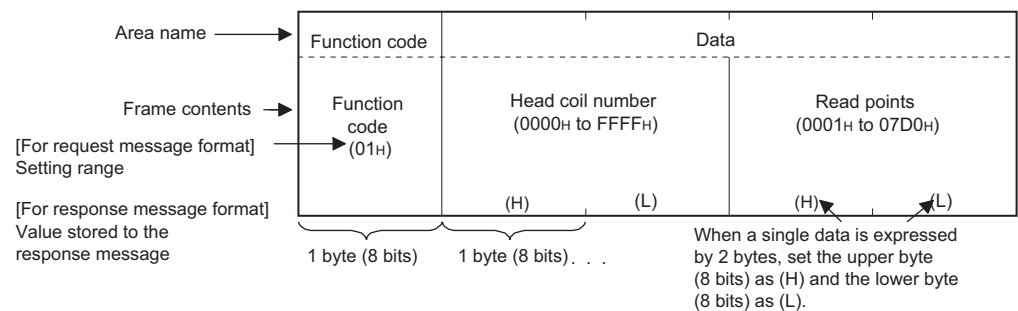

Figure 4.7 Request/Response message format diagram

(b) Frame mode of the message format

The message formats in Section 4.4 to 4.20 are based on the case in the RTU mode.

For use in ASCII mode, convert the values into ASCII codes.

(Conversion example)

(RTU mode)

Function code	Data			
Function code (01H)	Head coil number (006EH)		Read points (003FH)	
	(H)	(L)	(H)	(L)

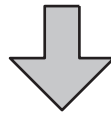

Convert RTU mode to ASCII mode

(ASCII mode)

Function code		Data				Data			
Function code		Head coil number				Read points			
0 (30H)	1 (31H)	0 (30H)	0 (30H)	6 (36H)	E (45H)	0 (30H)	0 (30H)	3 (33H)	F (46H)
(H)	(L)	(H)	(L)	(L)	(L)	(H)	(L)	(L)	(L)

Figure 4.8 Conversion example from RTU mode to ASCII mode

(c) Response message format

The response message formats issued from the slave to the master differs depending on whether the slave has normally completed or failed to handle the requested processing (read/write, diagnostics, etc.)

The formats for normal and error completions are shown in Section 4.4 to 4.20.

4.4 Read Coils (FC: 01)

Reads the status (ON/OFF) of one or more coils.

(1) Request message format (Master → Slave)

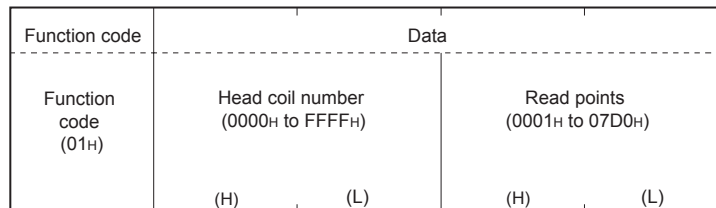

Figure 4.9 Read coils (Request message)

(2) Response message format (Slave → Master) (When completed normally)

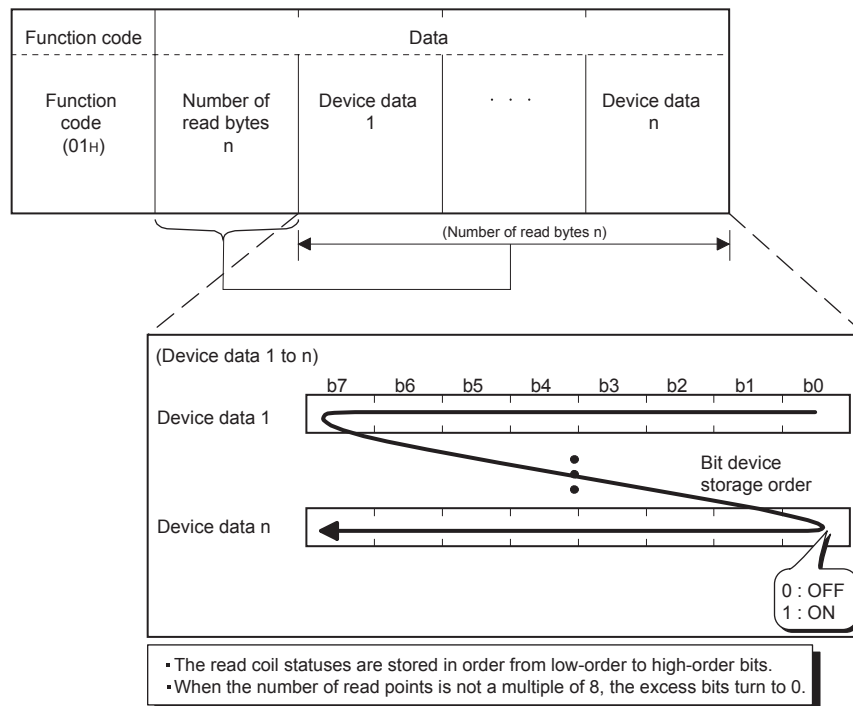

Figure 4.10 Read coils (Normal response message)

(When completed with an error)

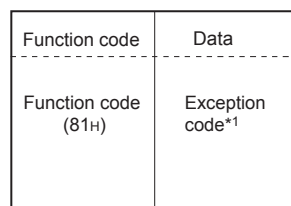

Figure 4.11 Read coils (Exception message)

* 1 Exception and error codes are stored in the buffer memory in the case of error completion. Refer to the following for storage location, confirmation methods, and detailed contents.

☞ Section 11.4

4.5 Read Discrete Inputs (FC: 02)

Reads the status (ON/OFF) of one or more inputs.

(1) Request message format (Master → Slave)

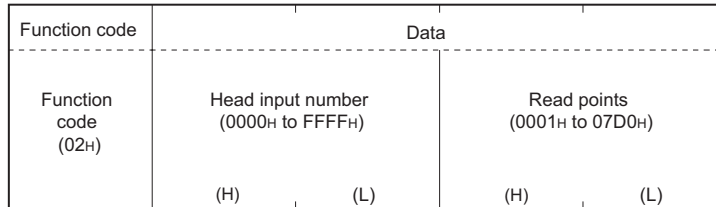

Figure 4.12 Read discrete inputs (Request message)

(2) Response message format (Slave → Master) (When completed normally)

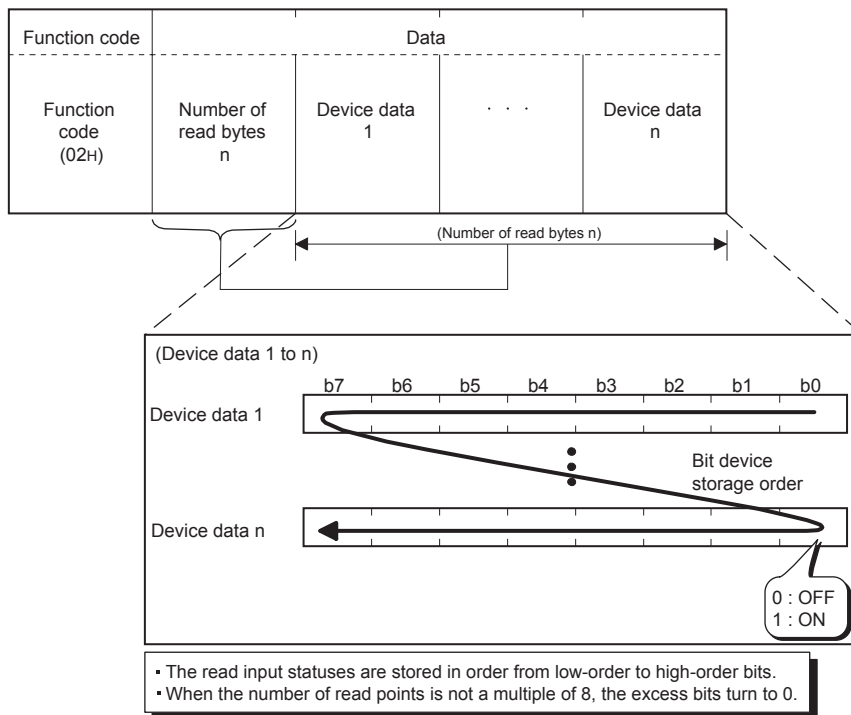

Figure 4.13 Read discrete inputs (Normal response message)

(When completed with an error)

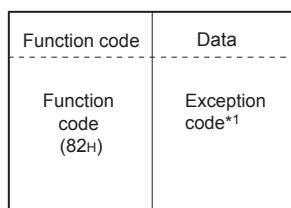

Figure 4.14 Read discrete inputs (Exception message)

* 1 Exception and error codes are stored in the buffer memory in the case of error completion. Refer to the following for storage location, confirmation methods, and detailed contents.

☞ Section 11.4

4.6 Read Holding Registers (FC: 03)

Reads the values of one or more holding registers.

(1) Request message format (Master → Slave)

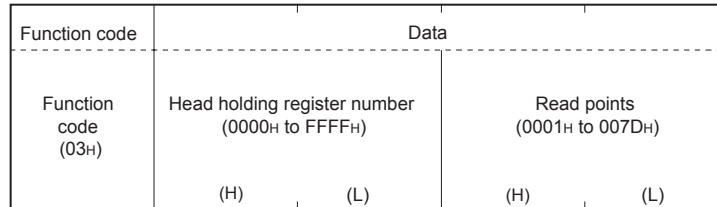
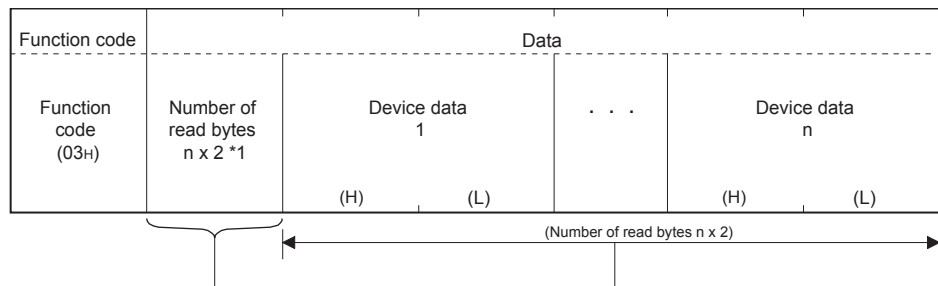

Figure 4.15 Read holding registers (Request message)

(2) Response message format (Slave → Master) (When completed normally)



*1 For example, if $n = 4$, the number of read bytes is calculated as $4 \times 2 = 8$ bytes.

Figure 4.16 Read holding registers (Normal response message)

(When completed with an error)

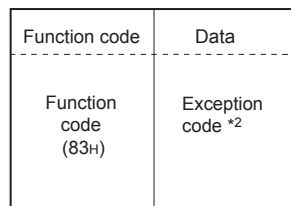

Figure 4.17 Read holding registers (Exception message)

* 2 Exception and error codes are stored in the buffer memory in the case of error completion. Refer to the following for storage location, confirmation methods, and detailed contents.

☞ Section 11.4

4.7 Read Input Registers (FC: 04)

Reads the values of one or more input registers.

(1) Request message format (Master → Slave)

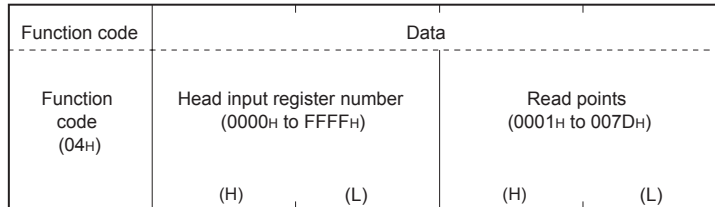
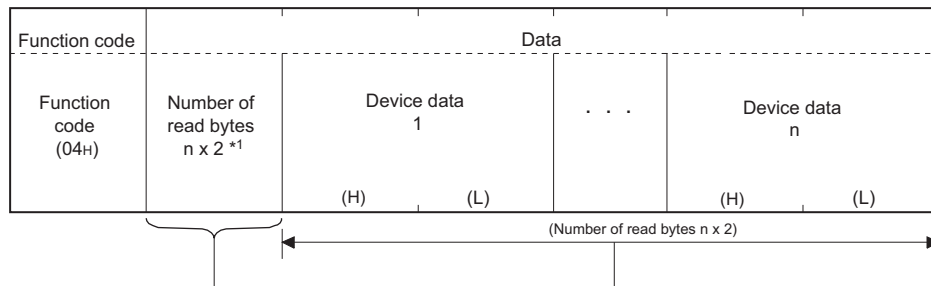

Figure 4.18 Read input registers (Request message)

(2) Response message format (Slave → Master)

(When completed normally)



*1 For example, if $n = 4$, the number of read bytes is calculated as $4 \times 2 = 8$ bytes.

Figure 4.19 Read input registers (Normal response message)

(When completed with an error)

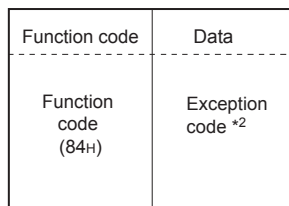

Figure 4.20 Read input registers (Exception message)

* 2 Exception and error codes are stored in the buffer memory in the case of error completion. Refer to the following for storage location, confirmation methods, and detailed contents.

Section 11.4

4.8 Write Single Coil (FC: 05)

Writes a value (ON/OFF) to one coil.

(1) Request message format (Master → Slave)

Function code	Data			
Function code (05H)	Coil number (0000H to FFFFH)		ON/OFF specification (0000H : OFF) (FF00H : ON)	
	(H)	(L)	(H)	(L)

Figure 4.21 Write single coil (Request message)

(2) Response message format (Slave → Master)

(When completed normally)

The slave returns the request message received from the master without change.

(When completed with an error)

Function code	Data
Function code (85H)	Exception code*1

Figure 4.22 Write single coil (Exception message)

* 1 Exception and error codes are stored in the buffer memory in the case of error completion. Refer to the following for storage location, confirmation methods, and detailed contents.

☞ Section 11.4

4.9 Write Single Register (FC: 06)

Writes a value to one holding register.

(1) Request message format (Master → Slave)

Function code	Data			
Function code (06H)	Holding register number (0000H to FFFFH)		Write data (0000H to FFFFH)	
	(H)	(L)	(H)	(L)

Figure 4.23 Write single register (Request Message)

(2) Response message format (Slave → Master)

(When completed normally)

The slave returns the request message received from the master without change.

(When completed with an error)

Function code	Data
Function code (86H)	Exception code*1

Figure 4.24 Write single register (Exception message)

* 1 Exception and error codes are stored in the buffer memory in the case of error completion. Refer to the following for storage location, confirmation methods, and detailed contents.

 Section 11.4

4.10 Read Exception Status (FC: 07)

Reads error status.

(1) Request message format (Master → Slave)

Function code

Function code (07H)

Figure 4.25 Read exception status (Request message)

(2) Response message format (Slave → Master)

(When completed normally)

Function code	Data

Function code (07H)	Error information *1

Figure 4.26 Read exception status (Normal request message)

* 1 The data of the device specified in the Setting error status read device (address: 000AH to 000BH) in the buffer memory are stored in the error information area. (☞ Section 7.3.4)

(When completed with an error)

Function code	Data

Function code (87H)	Exception code *2

Figure 4.27 Read exception status (Exception message)

* 2 Exception and error codes are stored in the buffer memory in the case of error completion. Refer to the following for storage location, confirmation methods, and detailed contents.

☞ Section 11.4

4.11 Diagnostics (FC: 08)

Executes the various diagnostics and checks the QJ71MB91 status and communication status.

4.11.1 Return query data (sub-function code: 00)

Returns the contents of the request message without change.
Used to check if the network or the target device is operating normally. (Loopback test)

(1) Request message format (Master → Slave)

Function code	Sub-function code	Data
Function code (08H)	Sub-function code (0000H) (H) (L)	Arbitrary data

Figure 4.28 Return query data (Request message)

(2) Response message format (Slave → Master)

(When completed normally)

The slave returns the request message received from the master without change.

(When completed with an error)

Function code	Data
Function code (88H)	Exception code*1

Figure 4.29 Return query data (Exception message)

* 1 Exception and error codes are stored in the buffer memory in the case of error completion.
Refer to the following for storage location, confirmation methods, and detailed contents.

Section 11.4

4.11.2 Restart communications option (sub-function code: 01)

Initializes the communication port of the receiving channel side and restarts the slave function.

Restart is performed after returning the response message corresponding to a request message.

The operation status returns to online mode when it was in the listen only mode.

The following data are cleared when executing the restart communications option.

- Data being received
- CH1/2 side error response code storage area in the buffer memory (address: 0002_H/0004_H)*¹
- CH1/2 side detailed LED status storage area in the buffer memory (address: 0006_H/0007_H)*¹
- Diagnostic counter (☞ Section 11.3)
- The ERR. LED OFF*²
- Communications event count (☞ Section 4.12)
- Communications event log (☞ Section 4.13)*³

* 1 Clears only the receiving channel side area.

* 2 Clears the errors of the channel that has received the request message.

As the errors of other channels are not cleared, the LED will not turn off if an error has occurred on any other channel.

* 3 Clears the data when the communications event log clear is specified in the request message.

(1) Request message format (Master → Slave)

Function code	Sub-function code	Data
Function code (08H)	Sub-function code (0001H) (H) (L)	Clear setting of Communications event log (0000H: Not clear FF00H: Clear) (H) (L)

Figure 4.30 Restart communications option (Request message)

(2) Response message format (Slave → Master)

(When completed normally)

The slave returns the request message received from the master without change. However, if a request message is received during listen only mode, the status will only return to online mode and no response message will be returned.

(When completed with an error)

Function code	Data
Function code (88H)	Exception code*1

Figure 4.31 Restart communications option (Exception message)

* 1 Exception and error codes are stored in the buffer memory in the case of error completion. Refer to the following for storage location, confirmation methods, and detailed contents.

 Section 11.4

4.11.3 Return diagnostic register (sub-function code: 02)

Reads out the detailed LED status of the QJ71MB91 to the master.

(1) Request message format (Master → Slave)

Function code	Sub-function code	Data
Function code (08H)	Sub-function code (0002H)	(0000H)
	(H) (L)	(H) (L)

Figure 4.32 Return diagnostic register (Request message)

(2) Response message format (Slave → Master)

(When completed normally)

Function code	Sub-function code	Data
Function code (08H)	Sub-function code (0002H)	Diagnostic register value
	(H) (L)	(H) (L)

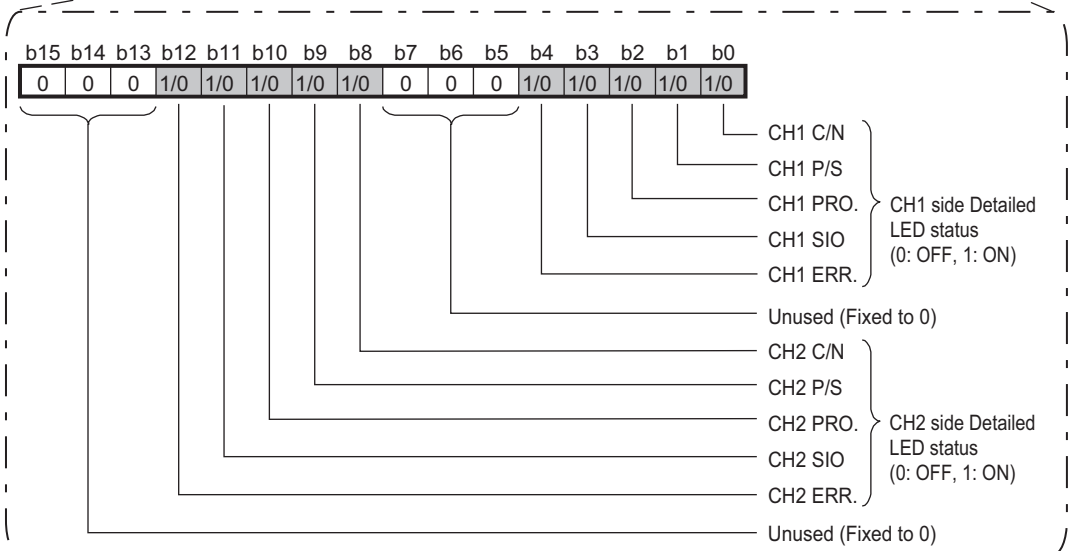

The QJ71MB91 stores the lower 8 bits of the buffer memory's Detailed LED status as a diagnostic register. (address: 0006H/0007H)

Figure 4.33 Return diagnostic register (Normal response message)

Remark

Refer to the following for each items of the detailed LED status.

☞ Section 11.2

1 OVERVIEW

2 SYSTEM CONFIGURATION

3 SPECIFICATIONS

4 MODBUS(R) STANDARD FUNCTIONS

5 FUNCTION

6 PRE-OPERATIONAL PROCEDURES AND SETTINGS

7 PARAMETER SETTING

8 UTILITY PACKAGE (GX Configurator-MB)

(When completed with an error)

Function code	Data
Function code (88H)	Exception code*1

Figure 4.34 Return diagnostic register (Exception message)

* 1 Exception and error codes are stored in the buffer memory in the case of error completion. Refer to the following for storage location, confirmation methods, and detailed contents.

 Section 11.4

4.11.4 Change ASCII input delimiter (sub-function code: 03)

Changes the 2nd byte (LF(0AH)) of the end code in the ASCII mode to a specified data. The specified data is stored in the 2nd byte of end code in the buffer memory. (address: 0F0CH/0F4CH)

Start	Address field	Function code	Data	Error check	END
:	2 characters	2 characters	n x 2 characters (n = 0 to 252)	2 characters	CR + LF (0DH) (0AH)
(3AH)					

Change this into a specified data.

Figure 4.35 Change part in the end code

(1) Request message format (Master → Slave)

Function code	Sub-function code	Data	
Function code (08H)	Sub-function code (0003H)	Input delimiter setting (00H to FFH)	(00H)
	(H) (L)		

Figure 4.36 Change ASCII input delimiter (Request message)

(2) Response message format (Slave → Master)

(When completed normally)

The slave returns the request message received from the master without change.

(When completed with an error)

Function code	Data
Function code (88H)	Exception code*1

Figure 4.37 Change ASCII input delimiter (Exception message)

* 1 Exception and error codes are stored in the buffer memory in the case of error completion. Refer to the following for storage location, confirmation methods, and detailed contents.

☞ Section 11.4

☒ POINT

This function is used only for 1:1 connections.
Do not use this function for 1:n connections.

4.11.5 Force listen only mode (sub-function code: 04)

Places a slave into the offline mode.
Used when disconnecting a slave from the network.

When QJ71MB91 is set in the listen only mode, the status is as follows:

- Ignores all request messages except for those of restart communications option. (☞ Section 4.11.2)
- Stops counting of the diagnostic counter. (☞ Section 11.3)
- Continues recording with the communications event log. (☞ Section 4.13)

(1) Request message format (Master → Slave)

Function code	Sub-function code	Data
Function code (08H)	Sub-function code (0004H)	(0000H)
	(H) (L)	(H) (L)

Figure 4.38 Force listen only mode (Request message)

(2) Response message format (Slave → Master)

(When completed normally)

No response message is returned because the listen only mode (offline status) is active.

(When completed with an error)

Function code	Data
Function code (88H)	Exception code*1

Figure 4.39 Force listen only mode (Exception message)

* 1 Exception and error codes are stored in the buffer memory in the case of error completion. Refer to the following for storage location, confirmation methods, and detailed contents.

☞ Section 11.4

☒ POINT

1. Whether the QJ71MB91 has been switched to listen only mode or not can be checked in the Communications mode of the buffer memory (address: 0F0D_H/0F4D_H).
0000_H: Online mode
0001_H: Listen only mode
2. The listen only mode can be changed to online mode by either of the following:
 - Restart communications option (☞ Section 4.11.2)
 - Power OFF → ON, programmable controller CPU reset

4.11.6 Clear counters and diagnostic register (sub-function code: 10)

Clears counters (e.g. message count).

Also, clears the diagnostic register and the error of the channel where the request message has been received.

The following counters will be cleared. (☞ Section 11.3)

- Bus message count
- Bus communication error count
- Exception error count
- Slave message count
- Slave no-response count
- Slave NAK count
- Slave busy count
- Character overrun error count
- Communications event count (☞ Section 4.12)

The following diagnostic registers will be cleared.

- CH1/2 side detailed LED status storage area of the buffer memory (address: 0006_H/0007_H)*¹
- CH1/2 side error response code storage area of the buffer memory (address: 0002_H/0004_H)*¹

* 1 Clears only the receiving channel side area.

(1) Request message format (Master → Slave)

Function code	Sub-function code	Data
Function code (08H)	Sub-function code (000AH)	(0000H)
	(H) (L)	(H) (L)

Figure 4.40 Clear counters and diagnostic register (Request message)

(2) Response message format (Slave → Master)

(When completed normally)

The slave returns the request message received from the master without change.

(When completed with an error)

Function code	Data
Function code (88H)	Exception code*1

Figure 4.41 Clear counters and diagnostic register (Exception message)

* 1 Exception and error codes are stored in the buffer memory in the case of error completion. Refer to the following for storage location, confirmation methods, and detailed contents.

☞ Section 11.4

4.11.7 Return bus message count (sub-function code: 11)

Reads out the number of messages detected on the line to the master.

(1) Request message format (Master → Slave)

Function code	Sub-function code	Data
Function code (08H)	Sub-function code (000BH)	(0000H)
	(H) (L)	(H) (L)

Figure 4.42 Return bus message count (Request message)

(2) Response message format (Slave → Master)

(When completed normally)

Function code	Sub-function code	Data
Function code (08H)	Sub-function code (000BH)	Bus message count value (0000H to FFFFH) *1
	(H) (L)	(H) (L)

The QJ71MB91 returns the bus message count value of the buffer memory to the master. (address: 0F00H/0F40H)

Figure 4.43 Return bus message count (Normal response message)

* 1 Refer to the following for the relevant counts, count clear methods and precautions.

Section 11.3

(When completed with an error)

Function code	Data
Function code (88H)	Exception code *2

Figure 4.44 Return bus message count (Exception message)

* 2 Exception and error codes are stored in the buffer memory in the case of error completion.

Refer to the following for storage location, confirmation methods, and detailed contents.

Section 11.4

4.11.8 Return bus communication error count (sub-function code: 12)

Reads out the number of error messages detected on the line to the master.

(1) Request message format (Master → Slave)

Function code	Sub-function code	Data
Function code (08H)	Sub-function code (000CH)	(0000H)
	(H) (L)	(H) (L)

Figure 4.45 Return bus communication error count (Request message)

(2) Response message format (Slave → Master)

(When completed normally)

Function code	Sub-function code	Data
Function code (08H)	Sub-function code (000CH)	Bus communication error count value (0000H to FFFFH) *1
	(H) (L)	(H) (L)

The QJ71MB91 returns the bus communication error count value of the buffer memory to the master. (address: 0F01H/0F41H)

Figure 4.46 Return bus communication error count (Normal response message)

* 1 Refer to the following for the relevant counts, count clear methods and precautions.

☞ Section 11.3

(When completed with an error)

Function code	Data
Function code (88H)	Exception code *2

Figure 4.47 Return bus communication error count (Exception message)

* 2 Exception and error codes are stored in the buffer memory in the case of error completion. Refer to the following for storage location, confirmation methods, and detailed contents.

☞ Section 11.4

4.11.9 Return bus exception error count (sub-function code: 13)

Reads out the frequency of exception errors to the master.

(1) Request message format (Master → Slave)

Function code	Sub-function code	Data
Function code (08H)	Sub-function code (000DH)	(0000H)
	(H) (L)	(H) (L)

Figure 4.48 Return bus exception error count (Request message)

(2) Response message format (Slave → Master)

(When completed normally)

Function code	Sub-function code	Data
Function code (08H)	Sub-function code (000DH)	Exception error count value (0000H to FFFFH) *1
	(H) (L)	(H) (L)

The QJ71MB91 returns the exception error count value of the buffer memory to the master. (address: 0F0AH/0F4AH)

Figure 4.49 Return bus exception error count (Normal response message)

* 1 Refer to the following for the relevant counts, count clear methods and precautions.

Section 11.3

(When completed with an error)

Function code	Data
Function code (88H)	Exception code *2

Figure 4.50 Return bus exception error count (Exception message)

* 2 Exception and error codes are stored in the buffer memory in the case of error completion. Refer to the following for storage location, confirmation methods, and detailed contents.

Section 11.4

4.11.10 Return slave message count (sub-function code: 14)

Reads out the number of the slave message processing to the master. (Including receive of request messages from broadcast.)

(1) Request message format (Master → Slave)

Function code	Sub-function code	Data
Function code (08H)	Sub-function code (000EH)	(0000H)
	(H) (L)	(H) (L)

Figure 4.51 Return slave message count (Request message)

(2) Response message format (Slave → Master)

(When completed normally)

Function code	Sub-function code	Data
Function code (08H)	Sub-function code (000EH)	Slave message count value (0000H to FFFFH) *1
	(H) (L)	(H) (L)

The QJ71MB91 returns the slave message count value of the buffer memory to the master. (address: 0F06H/0F46H)

Figure 4.52 Return slave message count (Normal response message)

* 1 Refer to the following for the relevant counts, count clear methods and precautions.

☞ Section 11.3

(When completed with an error)

Function code	Data
Function code (88H)	Exception code *2

Figure 4.53 Return slave message count (Exception message)

* 2 Exception and error codes are stored in the buffer memory in the case of error completion. Refer to the following for storage location, confirmation methods, and detailed contents.

☞ Section 11.4

4.11.11 Return slave no response count (sub-function code: 15)

Reads to out the number of broadcast request messages received to the master.

(1) Request message format (Master → Slave)

Function code	Sub-function code	Data
Function code (08H)	Sub-function code (000FH)	(0000H)
	(H) (L)	(H) (L)

Figure 4.54 Return slave no response count (Request message)

(2) Response message format (Slave → Master)

(When completed normally)

Function code	Sub-function code	Data
Function code (08H)	Sub-function code (000FH)	Slave no-response count value (0000H to FFFFH) *1
	(H) (L)	(H) (L)

The QJ71MB91 returns the slave no response count value of the buffer memory to the master. (address: 0F07H/0F47H)

Figure 4.55 Return slave no response count (Normal response message)

* 1 Refer to the following for the relevant counts, count clear methods and precautions.

Section 11.3

(When completed with an error)

Function code	Data
Function code (88H)	Exception code *2

Figure 4.56 Return slave no response count (Exception message)

* 2 Exception and error codes are stored in the buffer memory in the case of error completion.

Refer to the following for storage location, confirmation methods, and detailed contents.

Section 11.4

4.11.12 Return slave NAK count (sub-function code: 16)

Reads out the number of NAK responses to the master.
The QJ71MB91 always returns "0".

(1) Request message format (Master → Slave)

Function code	Sub-function code	Data
Function code (08H)	Sub-function code (0010H)	(0000H)
	(H) (L)	(H) (L)

Figure 4.57 Return slave NAK count (Request message)

(2) Response message format (Slave → Master)

(When completed normally)

Function code	Sub-function code	Data
Function code (08H)	Sub-function code (0010H)	Slave NAK count value (0000H) *1
	(H) (L)	(H) (L)

The QJ71MB91 returns the slave NAK count value of the buffer memory to the master. (address: 0F08H/0F48H)

Figure 4.58 Return slave NAK count (Normal response message)

* 1 Refer to the following for the relevant counts, count clear methods and precautions.

☞ Section 11.3

(When completed with an error)

Function code	Data
Function code (88H)	Exception code *2

Figure 4.59 Return slave NAK count (Exception message)

* 2 Exception and error codes are stored in the buffer memory in the case of error completion. Refer to the following for storage location, confirmation methods, and detailed contents.

☞ Section 11.4

4.11.13 Return slave busy count (sub-function code: 17)

Reads out the number of busy responses to the master.
The QJ71MB91 always returns "0".

(1) Request message format (Master → Slave)

Function code	Sub-function code	Data
Function code (08H)	Sub-function code (0011H)	(0000H)
	(H) (L)	(H) (L)

Figure 4.60 Return slave busy count (Request message)

(2) Response message format (Slave → Master)

(When completed normally)

Function code	Sub-function code	Data
Function code (08H)	Sub-function code (0011H)	Slave busy count value (0000H) *1
	(H) (L)	(H) (L)

The QJ71MB91 returns the slave busy count value of the buffer memory to the master. (address: 0F09H/0F49H)

Figure 4.61 Return slave busy count (Normal response message)

* 1 Refer to the following for the relevant counts, count clear methods and precautions.

Section 11.3

(When completed with an error)

Function code	Data
Function code (88H)	Exception code *2

Figure 4.62 Return slave busy count (Exception message)

* 2 Exception and error codes are stored in the buffer memory in the case of error completion. Refer to the following for storage location, confirmation methods, and detailed contents.

Section 11.4

4.11.14 Return bus character overrun count (sub-function code: 18)

To the master, reads out the number of times the request message size exceeds the upper limit.

(1) Request message format (Master → Slave)

Function code	Sub-function code	Data
Function code (08H)	Sub-function code (0012H)	(0000H)
	(H) (L)	(H) (L)

Figure 4.63 Return bus character overrun count (Request message)

(2) Response message format (Slave → Master)

(When completed normally)

Function code	Sub-function code	Data
Function code (08H)	Sub-function code (0012H)	Bus character overrun count value (0000H to FFFFH) *1
	(H) (L)	(H) (L)

The QJ71MB91 returns the bus character overrun count value of the buffer memory to the master. (address: 0F02H/0F42H)

Figure 4.64 Return bus character overrun count (Normal response message)

* 1 Refer to the following for the relevant counts, count clear methods and precautions.

☞ Section 11.3

(When completed with an error)

Function code	Data
Function code (88H)	Exception code *2

Figure 4.65 Return bus character overrun count (Exception message)

* 2 Exception and error codes are stored in the buffer memory in the case of error completion. Refer to the following for storage location, confirmation methods, and detailed contents.

☞ Section 11.4

Remark

Refer to the following for the size of request messages.

☞ Section 4.2.1

4.11.15 Return IOP overrun error count (sub-function code: 19)

Reads the IOP overrun error counter value to the master.
 The QJ71MB91 returns to the master the number of times the request message size exceeds the upper limit.
 (Same as the Return bus character overrun count)

(1) Request message format (Master → Slave)

Function code	Sub-function code	Data
Function code (08H)	Sub-function code (0013H)	(0000H)
	(H) (L)	(H) (L)

Figure 4.66 Return IOP overrun error count (Request message)

(2) Response message format (Slave → Master)

(When completed normally)

Function code	Sub-function code	Data
Function code (08H)	Sub-function code (0013H)	Bus character overrun count value (0000H to FFFFH) *1
	(H) (L)	(H) (L)

The QJ71MB91 returns the bus character overrun count value of the buffer memory to the master. (address: 0F02H/0F42H)

Figure 4.67 Return IOP overrun error count (Normal response message)

* 1 Refer to the following for the relevant counts, count clear methods and precautions.

☞ Section 11.3

(When completed with an error)

Function code	Data
Function code (88H)	Exception code *2

Figure 4.68 Return IP overrun error count (Exception message)

* 2 Exception and error codes are stored in the buffer memory in the case of error completion.

Refer to the following for storage location, confirmation methods, and detailed contents.

☞ Section 11.4

4.11.16 Clear overrun counter and flag (sub-function code: 20)

Clears the overrun error counter and flag.
The QJ71MB91 clears the character overrun error counter value.

(1) Request message format (Master → Slave)

Function code	Sub-function code	Data
Function code (08H)	Sub-function code (0014H)	(0000H)
	(H) (L)	(H) (L)

Figure 4.69 Clear overrun counter and flag (Request message)

(2) Response message format (Slave → Master)

(When completed normally)

The slave returns the request message received from the master without change.

(When completed with an error)

Function code	Data
Function code (88H)	Exception code*1

Figure 4.70 Clear overrun counter and flag (Exception message)

* 1 Exception and error codes are stored in the buffer memory in the case of error completion.
Refer to the following for storage location, confirmation methods, and detailed contents.

 Section 11.4

4.12 Get Communications Event Counter (FC: 11)

Acquires the number of messages whose requested actions (read/write, diagnostics, etc.) have been normally completed.

Whether the action corresponding to the request message is normally completed or not can be checked.

(1) Request message format (Master → Slave)

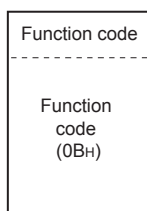
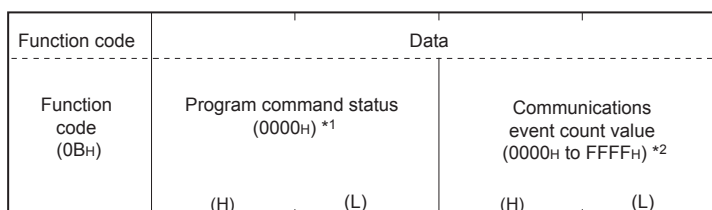

Figure 4.71 Get communications event counter (Request message)

(2) Response message format (Slave → Master)

(When completed normally)



The QJ71MB91 stores the communications event count value of the buffer memory as the communications event count value. (address: 0F0BH/0F4BH)

Figure 4.72 Get communications event counter (Normal response message)

* 1 Since the QJ71MB91 does not support any program commands, 0000H is stored.

* 2 The count is stopped if it has reached FFFFH.

Reset the counter by either of the following methods when restarting the count.

- Clearing the counter and diagnostic register (☞ Section 4.11.6)
- Restart communications option (☞ Section 4.11.2)
- Power OFF → ON, or programmable controller CPU reset

POINT

The communications event counter counts only when the processing (read/write, diagnostics, etc.) has completed normally.

The communications event counter does not count in the case of the following:

- The processing has completed with an error.
- When receiving a request message containing a function code that the QJ71MB91 does not support
- When receiving the Get communications event counter (FC: 11) and Get communications event log (FC: 12)

(When completed with an error)

Function code	Data
Function code (8BH)	Exception code*1

Figure 4.73 Get communications event counter (Exception message)

* 1 Exception and error codes are stored in the buffer memory in the case of error completion. Refer to the following for storage location, confirmation methods, and detailed contents.

 Section 11.4

4.13 Get Communications Event Log (FC: 12)

Acquires the communications event log of the QJ71MB91 into the master.

(1) Request message format (Master → Slave)

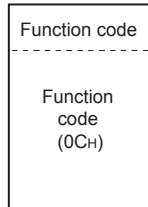

Figure 4.74 Get communications event log (Request message)

(2) Response message format (Slave → Master)

(When completed normally)

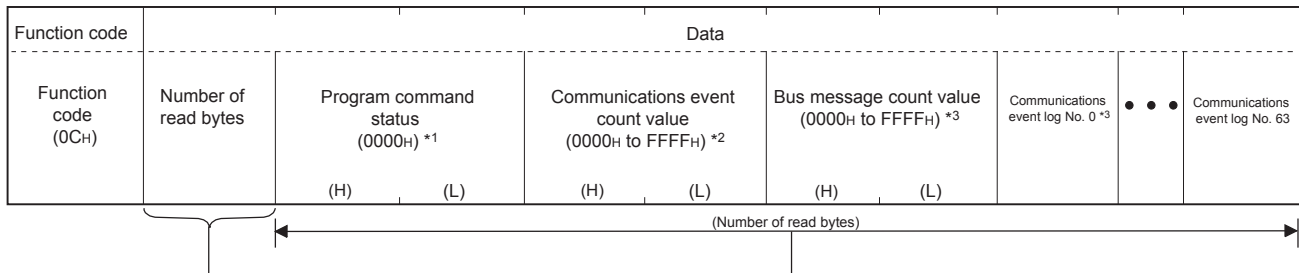

Figure 4.75 Get communications event log (Normal response message)

* 1 Since the QJ71MB91 does not support any program commands, 0000H is always stored.

* 2 Refer to the following for the relevant counts, count clear methods and precautions.

☞ Section 4.12

* 3 Refer to the following for the relevant counts, count clear methods and precautions.

☞ Section 11.3

* 4 Refer to the following for details of the communications event log.

☞ This section (2) (a), (2) (b)

(When completed with an error)

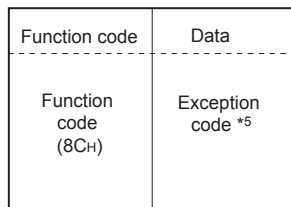

Figure 4.76 Get communications event log (Exception message)

* 5 Exception and error codes are stored in the buffer memory in the case of error completion.

Refer to the following for storage location, confirmation methods, and detailed contents.

☞ Section 11.4

(a) Communications event log

When the slave (QJ71MB91) receives the Get communications event log (FC: 12) from the master, it returns the data of the Communications event log area in the buffer memory to the master.(address: 0F20H to 0F3FH/0F60H to 0F7FH)

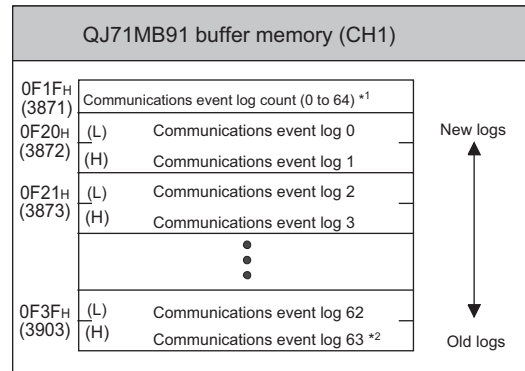

Figure 4.77 Communications event log

- * 1 The number of communications event logs can be confirmed only with the buffer memory. It is different from the communications event counter value in the response message.
- * 2 If the number of communications event logs exceeds 64, the oldest log is deleted and the latest log is stored to Communications event log 0.

Communications event logs are stored in the buffer memory at the following timing.

1) When receiving a request message

The slave (QJ71MB91) stores the communications event log before executing the processing of the request message.

For the relevant communications event, "1" is stored.

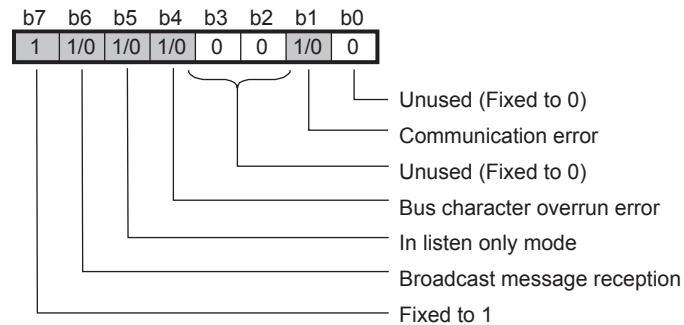

Figure 4.78 Communications event at request message transmission

2) When sending a response message

The slave (QJ71MB91) stores the communications event log after sending the response message.

For the relevant communications event, "1" is stored.

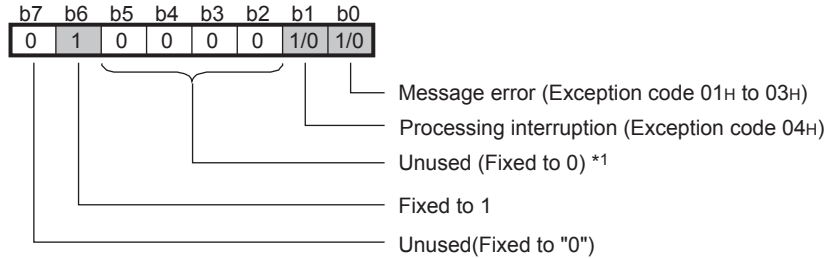

Figure 4.79 Communications event at response message transmission

* 1 While the occurrence of busy status (exception code 05H to 07H) is stored for the MODBUS® protocol, "0" is stored for the QJ71MB01 because this kind of events does not occur in it.

3) When switching to the listen only mode

The slave (QJ71MB91) stores the communications event log when switching to the listen only mode.

04H is stored to the communications event log.

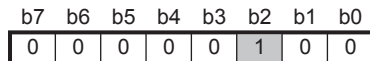

Figure 4.80 Communications event when switching to listen only mode

4) When processing restart communications option

The slave (QJ71MB91) stores the communications event log when processing the restart communications option.

00H is stored to the communications event log.

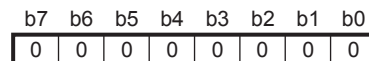

Figure 4.81 Communications event when processing restart communications option

(b) Clearing the communications event log

The communications event can be cleared by either of the following:

- Clear setting of the communications event log with the restart communications option (➡ Section 4.11.2)
- Power OFF → ON, or programmable controller CPU reset

4.14 Write Multiple Coils (FC: 15)

Writes values (ON/OFF) to multiple coils.

(1) Request message format (Master → Slave)

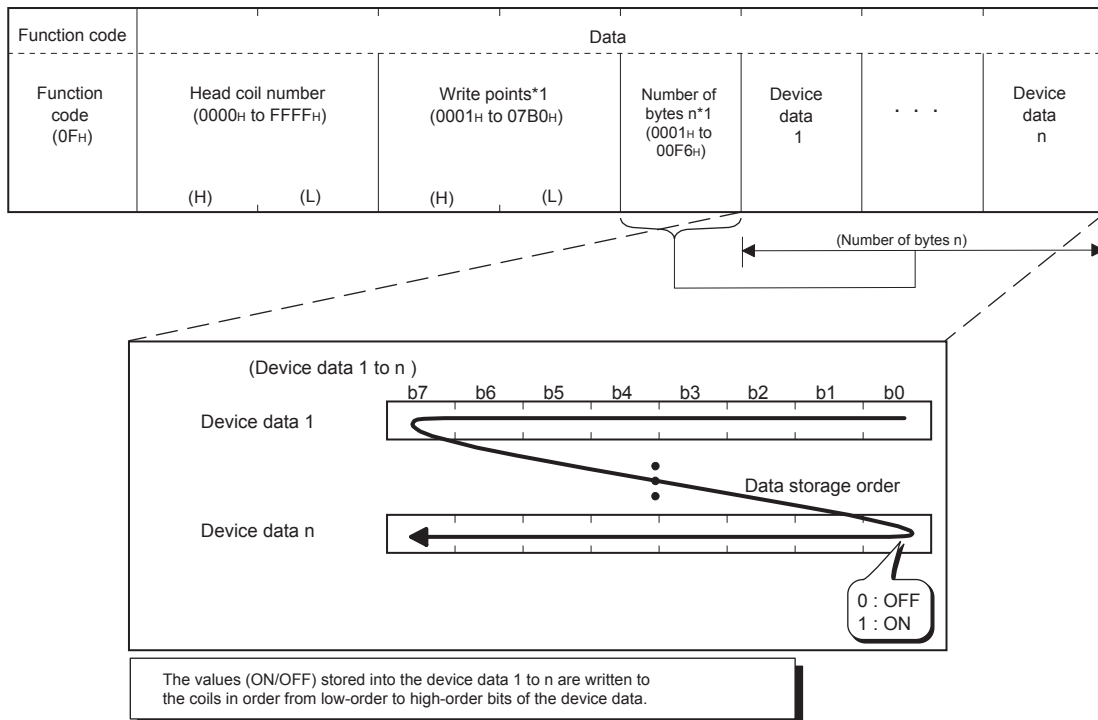

Figure 4.82 Write multiple coils (Request message)

- * 1 The number of the specified write points must be matched with the number of bits specified as the number of bytes.
For example, when the write points are set to 16, set the number of bytes to 2 bytes (= 16 bits).

(2) Response message format (Slave → Master)

(When completed normally)

Function code	Data			
Function code (0FH)	Head coil number (The same head coil number value as in the request message is stored.) (H) (L)		Write points (The same write points value as in the request message is stored.) (H) (L)	

Figure 4.83 Write multiple coils (Normal response message)

(When completed with an error)

Function code	Data
Function code (8FH)	Exception code*1

Figure 4.84 Write multiple coils (Exception message)

* 1 Exception and error codes are stored in the buffer memory in the case of error completion. Refer to the following for storage location, confirmation methods, and detailed contents.

 Section 11.4

4.15 Write Multiple Registers (FC: 16)

Writes values to multiple holding registers.

(1) Request message format (Master → Slave)

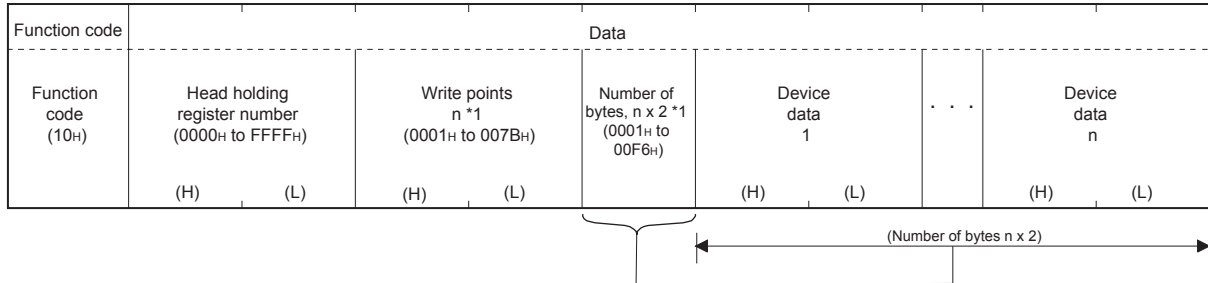

Figure 4.85 Write multiple registers (Request message)

* 1 The number of the specified write points must be matched with the number of bytes.

(2) Response message format (Slave → Master)

(When completed normally)

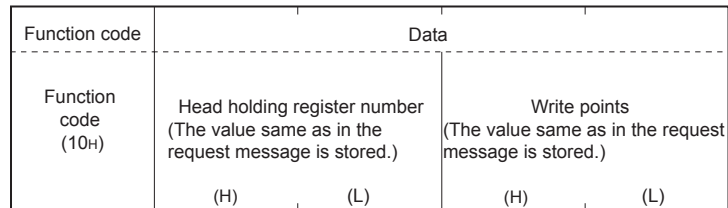

Figure 4.86 Write multiple registers (Normal response message)

(When completed with an error)

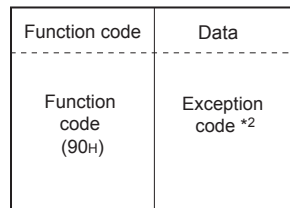

Figure 4.87 Write multiple registers (Exception message)

* 2 Exception and error codes are stored in the buffer memory in the case of error completion. Refer to the following for storage location, confirmation methods, and detailed contents.

☞ Section 11.4

4.16 Report Slave ID (FC: 17)

Acquires the information of the slave (QJ71MB91) mounted station into the master.

(1) Request message format (Master → Slave)

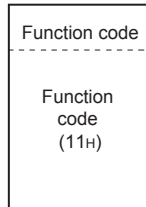

Figure 4.88 Report slave ID (Request message)

(2) Response message format (Slave → Master)

(When completed normally)

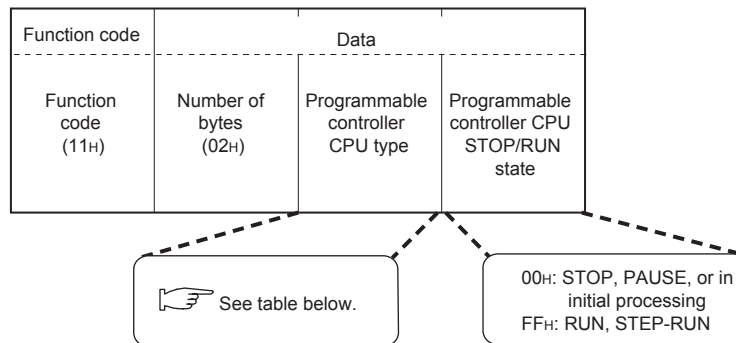

Figure 4.89 Report slave ID (Normal response message)

The slave (QJ71MB91) will return any of the following programmable controller CPU type data.

Table 4.8 Programmable controller CPU type data returned to Master

Module type		Programmable controller CPU type data returned to Master
Programmable controller CPU	Q00JCPU	50H
	Q00CPU	51H
	Q01CPU	52H
	Q02CPU	41H
	Q02HCPU	
	Q06HCPU	42H
	Q12HCPU	43H
	Q25HCPU	44H

(Continued on next page)

Table 4.8 Programmable controller CPU type data returned to Master (Continued)

Module type	Programmable controller CPU type data returned to Master	
Programmable controller CPU	Q02PHCPU	41H
	Q06PHCPU	42H
	Q12PHCPU	43H
	Q25PHCPU	44H
	Q12PRHCPU	4BH
	Q25PRHCPU	4CH
	Q00UJCPU	60H
	Q00UCPU	61H
	Q01UCPU	62H
	Q02UCPU	63H
	Q03UDCPU	68H
	Q04UDHCPU	69H
	Q06UDHCPU	6AH
	Q10UDHCPU	66H
	Q13UDHCPU	6BH
	Q20UDHCPU	67H
	Q26UDHCPU	6CH
	Q03UDECPU	68H
	Q04UDEHCPU	69H
	Q06UDEHCPU	6AH
Q10UDEHCPU	66H	
Q13UDEHCPU	6BH	
Q20UDEHCPU	67H	
Q26UDEHCPU	6CH	
MELSECNET/H remote I/O station	QJ72LP25-25	70H
	QJ72LP25G	
	QJ72LP25GE	
	QJ72BR15	71H

(When completed with an error)

Function code	Data
Function code (91H)	Exception code*1

Figure 4.90 Report slave ID (Exception message)

* 1 Exception and error codes are stored in the buffer memory in the case of error completion. Refer to the following for storage location, confirmation methods, and detailed contents.

☞ Section 11.4

1 OVERVIEW

2 SYSTEM CONFIGURATION

3 SPECIFICATIONS

4 MODBUS(R) STANDARD FUNCTIONS

5 FUNCTION

6 PRE-OPERATIONAL PROCEDURES AND SETTINGS

7 PARAMETER SETTING

8 UTILITY PACKAGE (GX Configurator-MB)

4.17 Read File Record (FC: 20) (SC: 06)

Reads multiple extended file register values.

(1) Request message format (Master → Slave)

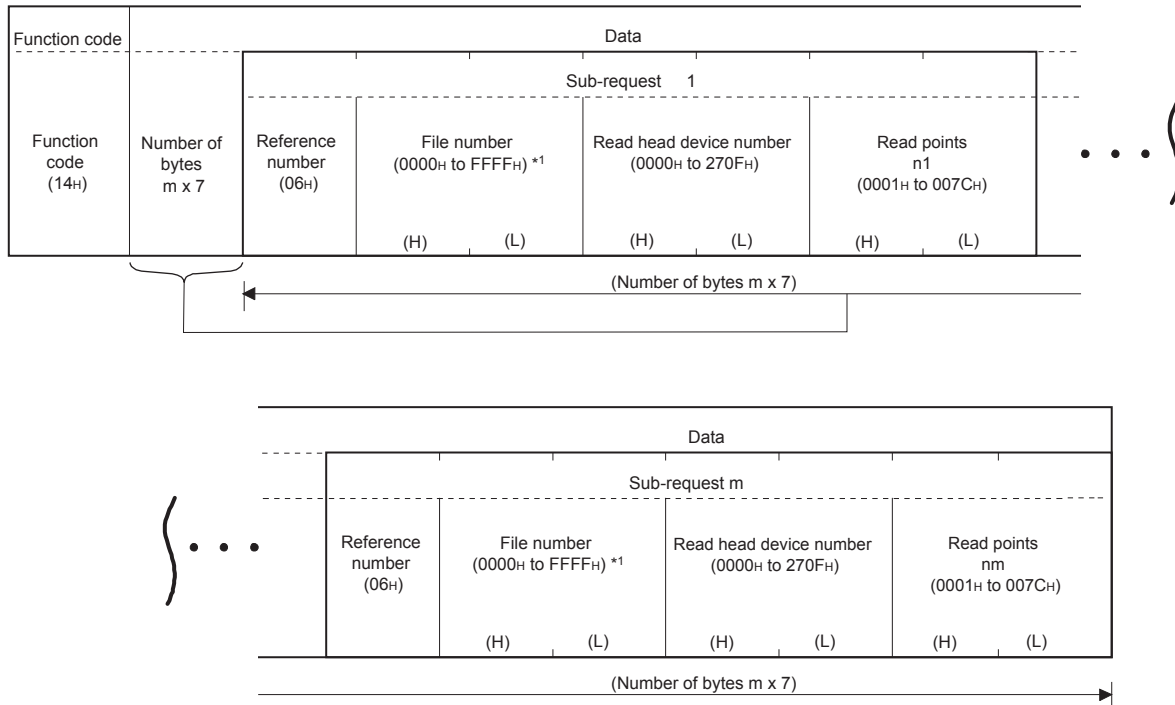

Figure 4.91 Read file record (Request message)

* 1 The maximum file number available for the QJ71MB91 slave function is dependant on the file register size of the mounted programmable controller CPU. (Section 7.3.2)

(a) Number of sub-requests, m

Specify the number of sub-requests, m, so that the protocol data unit size of the request message will not exceed 253 bytes.*²

$$2 + m \times 7 \leq 253^{*2}$$

If the above condition is not satisfied, the request message is discarded.

* 2 When the frame mode is ASCII mode, it is 506 bytes.

(b) Read points of each sub-request

Specify the total points N (n1+...+nm) so that the protocol data unit size of the response message will not exceed 253 bytes.*³

$$2 + m \times 2 + N \times 2 \leq 253^{*3}$$

If the above condition is not satisfied, the slave returns an exception response.

* 3 When the frame mode is ASCII mode, it is 506 bytes.

(2) Response message format (Slave → Master) (When completed normally)

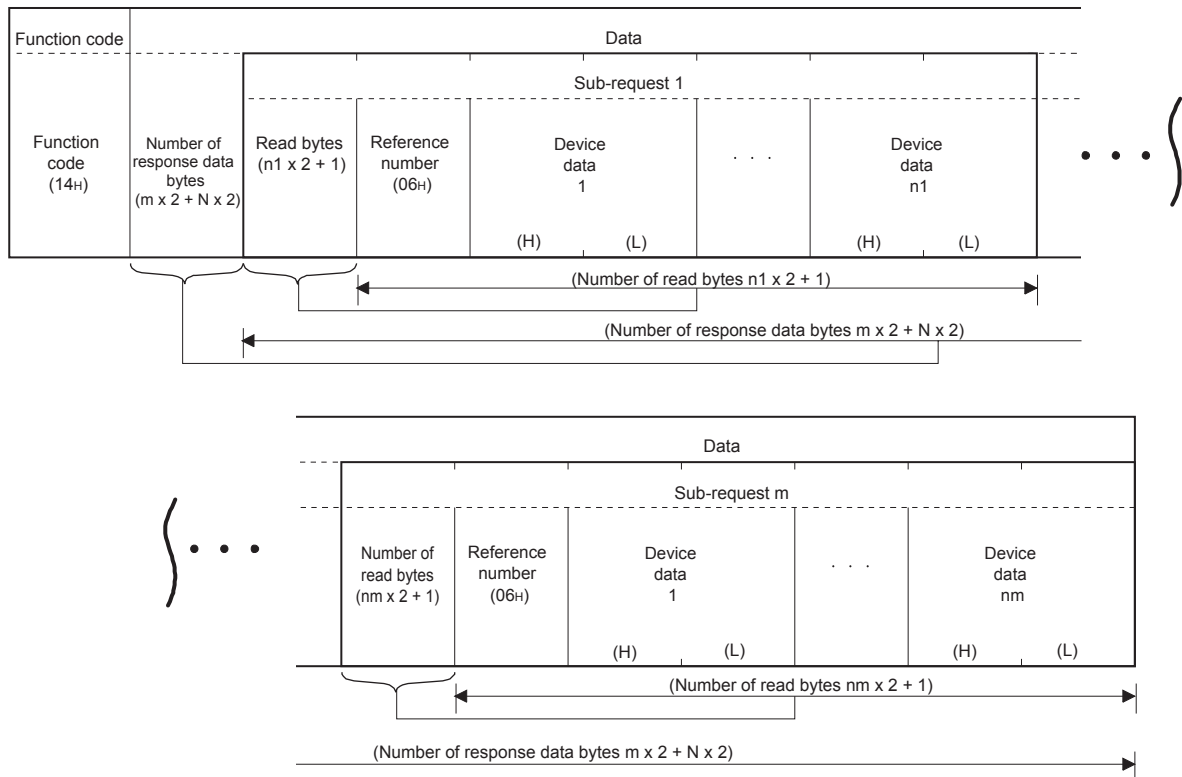

Figure 4.92 Read file record (Normal response message)

"N" in the above diagram represents the total of the device data (n1 + ... + nm).

(When completed with an error)

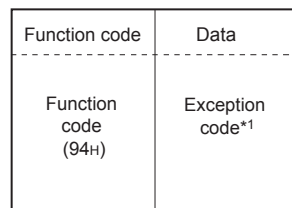

Figure 4.93 Read file record (Exception message)

* 1 Exception and error codes are stored in the buffer memory in the case of error completion. Refer to the following for storage location, confirmation methods, and detailed contents.

☞ Section 11.4

4.18 Write File Record (FC: 21) (SC: 06)

Writes multiple extension file register values.

(1) Request message format (Master → Slave)

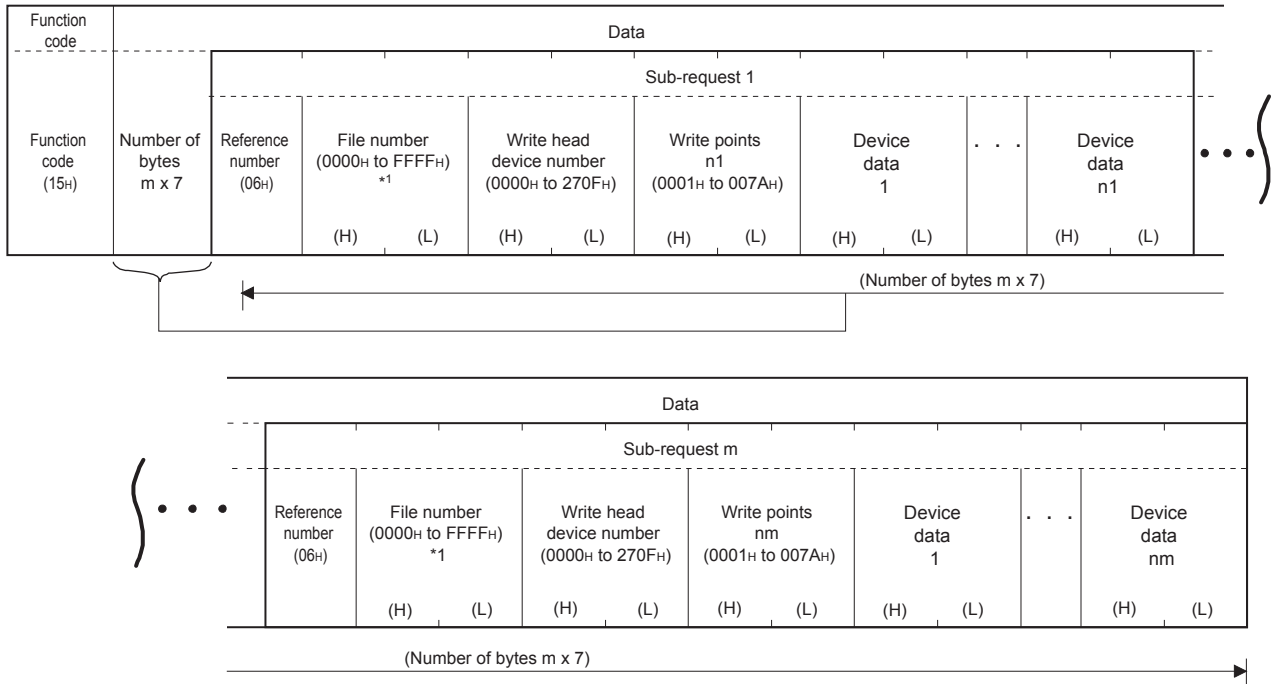

Figure 4.94 Write file record (Request message)

* 1 The maximum file number available for the QJ71MB91 slave function is dependant on the file register size of the mounted programmable controller CPU. (See Section 7.3.2)

(a) Write points of each sub-request

Specify the total points N ($n_1 + \dots + n_m$) so that the protocol data unit size of the response message will not exceed 253 bytes.*2

$$2 + m \times 7 + N \times 2 \leq 253^{*2}$$

If the above condition is not satisfied, the request message is discarded.

* 2 When the frame mode is ASCII mode, it is 506 bytes.

(2) Response message format (Slave → Master)

(When completed normally)

The slave returns the request message received from the master without change.

(When completed with an error)

Function code	Data
Function code (95H)	Exception code*1

Figure 4.95 Write file record (Exception message)

* 1 Exception and error codes are stored in the buffer memory in the case of error completion. Refer to the following for storage location, confirmation methods, and detailed contents.

 Section 11.4

POINT

Even if the slave (QJ71MB91) receives this function with the programmable controller CPU file register (ZR) set as read only (for example, the storage location of the file register [ZR] is a Flash card), the slave responds normally. In this case, however, the Write file record is not performed. When performing the Write file record, previously confirm whether the programmable controller CPU file register (ZR) is writable.

4.19 Mask Write Register (FC: 22)

Masks the values stored in a single holding register with AND or OR and writes the value.

The masked values written to the holding register are as shown below.

(Target register current value \cap AND mask value) \cup (OR mask value \cap AND mask value) = Write value

When the OR mask value is 0000H, only the AND processing of the AND mask value is performed.

When the AND mask value is 0000H, the OR mask value is the write value.

(1) Request Message Format (Master → Slave)

Function code	Data					
Function code (16H)	Target holding register number (0000H to FFFFH)		AND mask value (0000H to FFFFH)		OR mask value (0000H to FFFFH)	
	(H)	(L)	(H)	(L)	(H)	(L)

Figure 4.96 Mask write register (Request message)

(2) Response message format (Slave → Master)

(When completed normally)

The slave returns the request message received from the master without change.

(When completed with an error)

Function code	Data
Function code (96H)	Exception code*1

Figure 4.97 Mask write register (Normal response message)

* 1 Exception and error codes are stored in the buffer memory in the case of error completion. Refer to the following for storage location, confirmation methods, and detailed contents.

Section 11.4

POINT

This function code is used to read the value stored in a specified holding register from the slave, process the value with AND/OR mask in the master, and then write the masked value to the holding register of the slave.

Therefore, if the holding register value is changed during the AND/OR operation, the changed value is overwritten.

4.20 Read/Write Multiple Registers (FC: 23)

Reads from or writes to multiple holding registers.
Writing is executed first and reading is then executed.

(1) Request message format (Master → Slave)

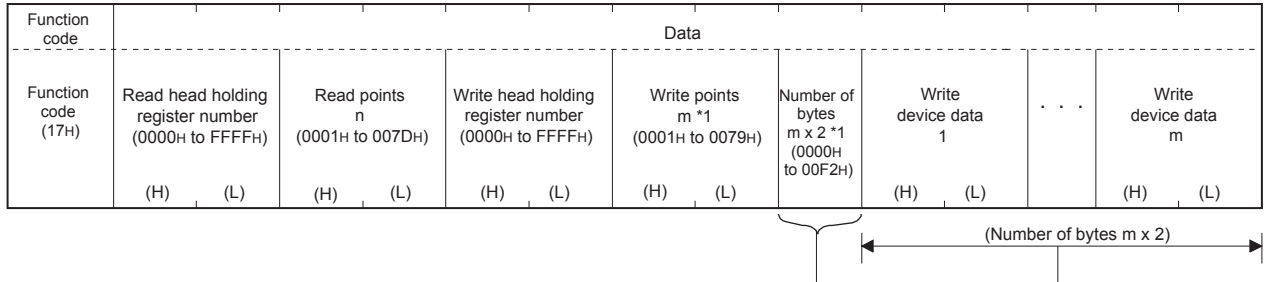

Figure 4.98 Read/Write multiple registers (Request message)

* 1 The number of the specified write points must be matched with the number of bytes.

(2) Response message format (Slave → Master)

(When completed normally)

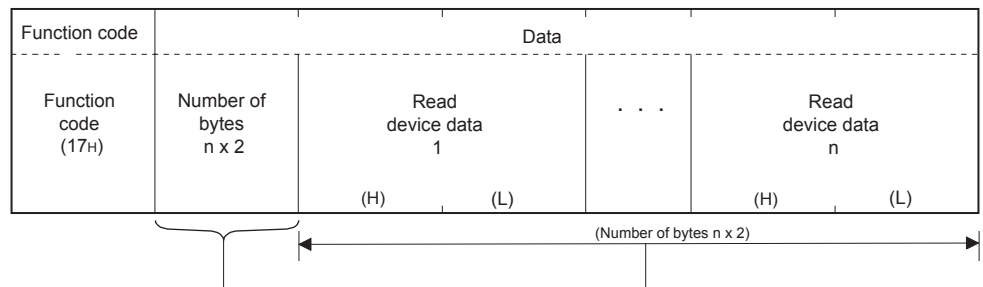

Figure 4.99 Read/Write multiple registers (Normal response message)

(When completed with an error)

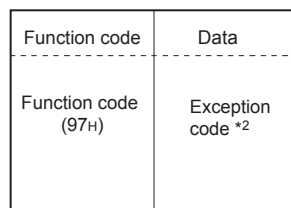

Figure 4.100 Read/Write multiple registers (Exception message)

* 2 Exception and error codes are stored in the buffer memory in the case of error completion. Refer to the following for storage location, confirmation methods, and detailed contents.

☞ Section 11.4

CHAPTER5 FUNCTIONS

This chapter explains the functions of the QJ71MB91.

5.1 Function List

The function list of the QJ71MB91 is shown below.

Table5.1 Function list

Function		Description	Reference
Master function	Automatic communication	Automatically issues device read/write request messages from the master (QJ71MB91) to a MODBUS [®] compatible slave device.	Section 5.2.1
	Communication by dedicated instructions *1	Allows reading/writing of MODBUS [®] devices at any timing with a sequence program.	CHAPTER 10
Slave function	Automatic response function *2	Automatically performs the processing corresponding to the function code in the request message received from the master, and automatically sends a response message.	Section 5.3.1
	MODBUS [®] device assignment function *3	Automatically converts access from the slave (QJ71MB91) to a MODBUS [®] device into access to a QCPU device. Users can assign any access destination. This allows direct access from the MODBUS [®] compatible master device to the programmable controller CPU device memory.	Section 5.3.2
	Link operation function	This function allows the master connected to QJ71MB91's CH1 (RS-232) communicate with several slave stations connected to QJ71MB91's CH2 (RS-422/485). If the link operation function is used, a RS-232 interface (1-to-1 communication) MODBUS [®] master device can communicate with several MODBUS [®] slave devices.	Section 5.3.3

* 1 Dedicated instructions are not available when the QJ71MB91 is installed to a MELSECNET/H remote I/O station or a redundant system.

* 2 When the QJ71MB91 is mounted on a MELSECNET/H remote I/O station, there are restrictions on the function codes supported by the automatic response function. (☞ Section 4.1 (3))

* 3 When the QJ71MB91 is mounted on a MELSECNET/H remote I/O station, there are restrictions on the assignment range of the MODBUS[®] device assignment function. (☞ Section 7.3.1 (2))

(Continued on next page)

Table5.1 Function list (Continued)

Function	Description	Reference
QJ71MB91 status check function	Checks the operations of the QJ71MB91 itself and the send/receive functions.	-
Hardware test	Tests the RAM and ROM of the QJ71MB91.	Section 6.4.1
Self-loopback test	This test checks the send/receive function of the QJ71MB91 and communications with the programmable controller CPU.	Section 6.4.2
Various settings using utility package	By using the utility package (GX Configurator-MB), parameters such as automatic communication parameters or MODBUS [®] device assignment parameters can be set on-screen, and status monitoring is available. This makes the parameter setting and status monitoring easier.	CHAPTER 8

5.2 Master Function

This section explains the functions of the QJ71MB91 acting as a MODBUS[®] master.

5.2.1 Automatic communication function

The automatic communication function is a function by which device read/write request messages are automatically issued from the QJ71MB91 to the MODBUS[®] compatible slave devices.

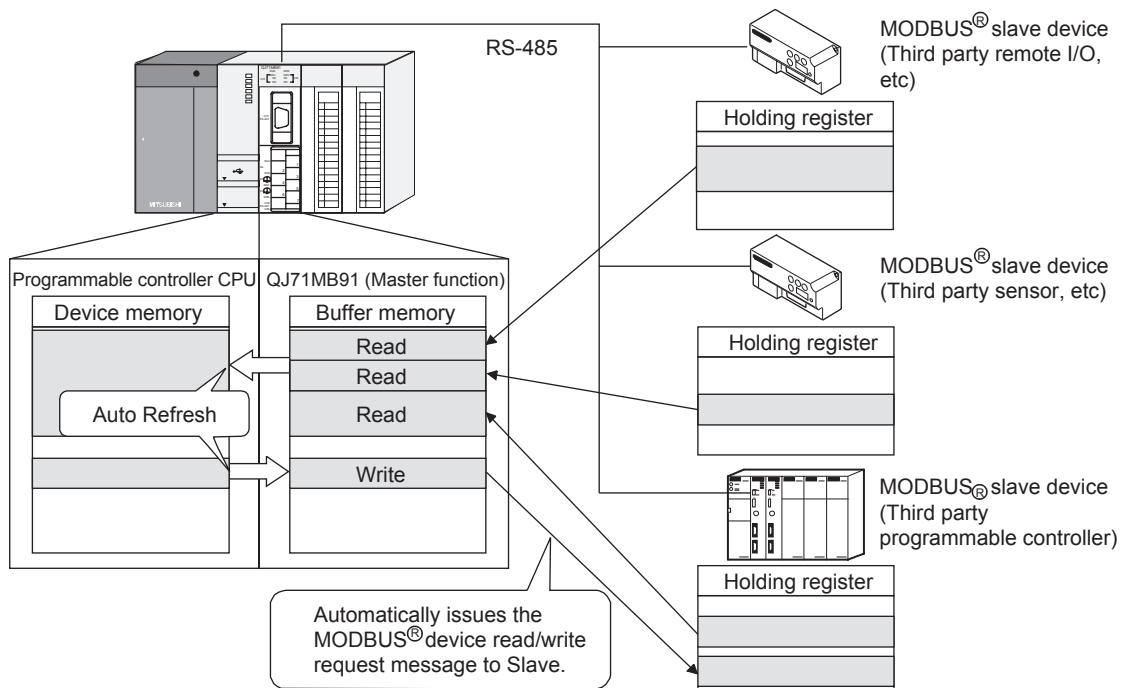

Figure 5.1 Communication using the automatic communication function

(1) To use the automatic communication function

Set the automatic communication parameters to use this function.

(☞ Section 7.2)

Using the preset automatic communication parameters, communication processing is performed automatically.

Refer to (2) and subsequent sections to set the automatic communication parameters.

(2) Automatic communication operation flowchart

Using the preset automatic communication parameters, the automatic communication function operates as shown below based on the request interval timer and response monitoring timer/broadcast delay settings.

Set the automatic communication parameters referring to the following flowchart.

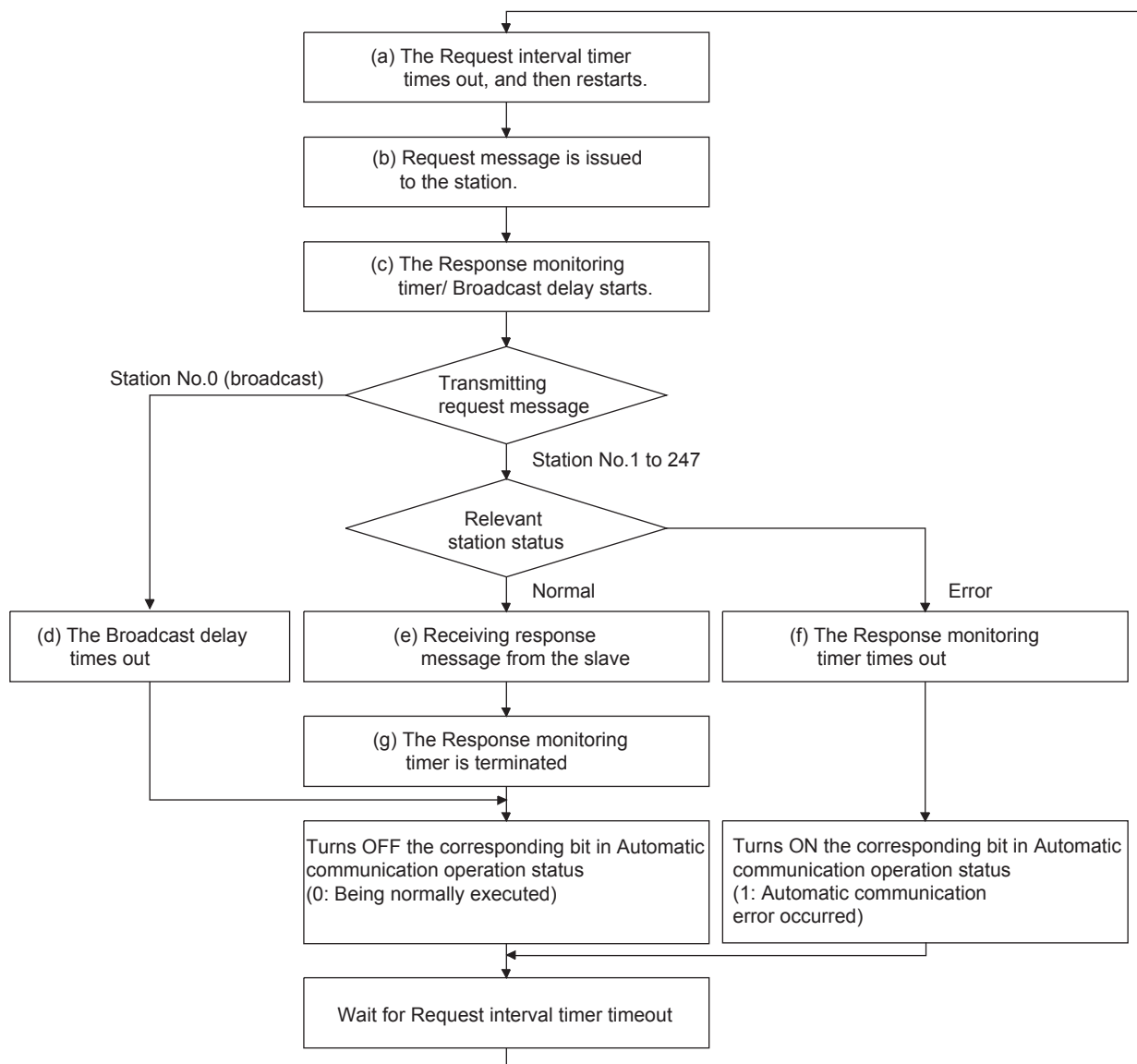

Figure 5.2 Automatic communication operation flowchart

Symbols (a) to (g) in the illustration correspond to sections (a) to (g) on subsequent pages.

- (a) The Request interval timer times out, and then restarts
 The Request interval timer represents the interval between any successive request message transmissions in the automatic communication function.
 (☞ Section 7.2.1 (3))

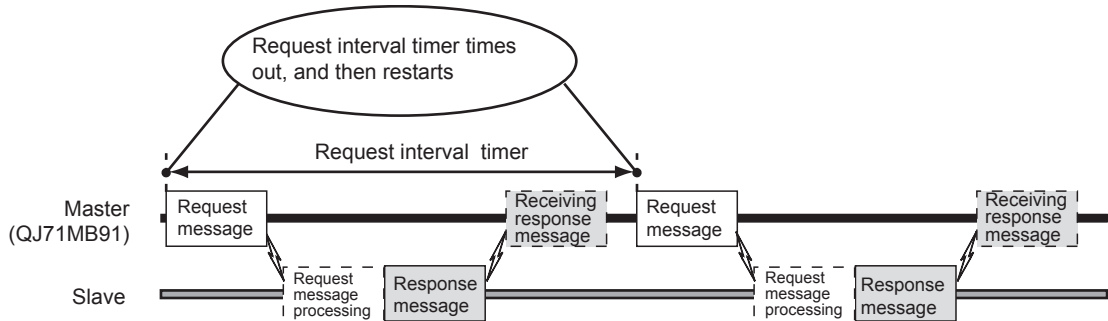
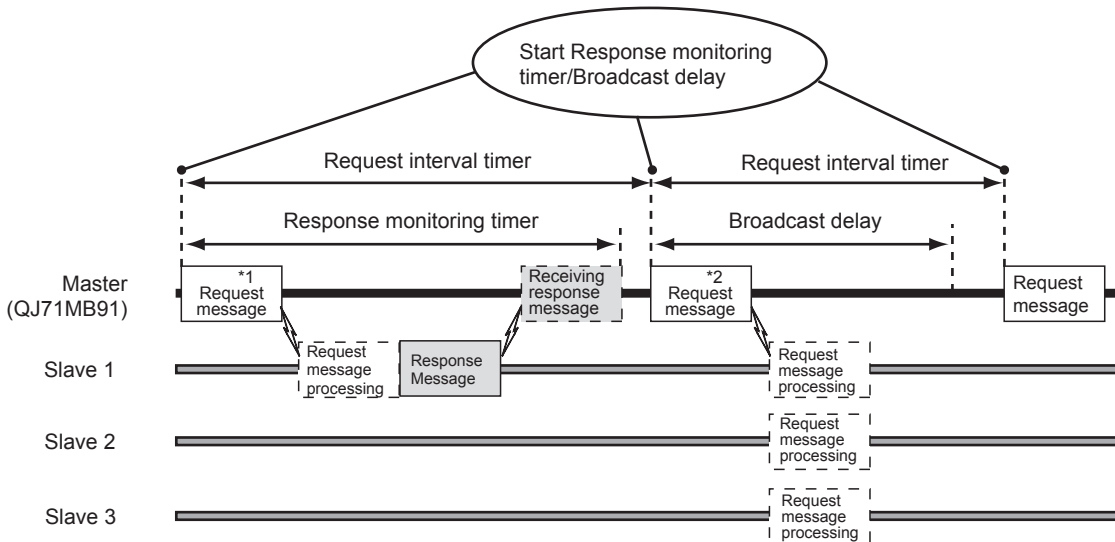

Figure 5.3 Request interval timer operation

- (b) Request message is issued to the station
 Request messages are issued at the timing shown in the above (a).
- (c) The Response monitoring timer/Broadcast delay starts
 The Response monitoring timer is used to monitor the time taken between a response message transmission from QJ71MB91 and reception of a response message from a slave.
 The Broadcast delay monitors the time interval between transmissions when request messages are broadcast.
 The Response monitoring timer/Broadcast delay starts when a request message is sent. (☞ Section 7.2.1 (4))



*1 When request message is addressed to station No.1 to 247

*2 When request message is addressed to station No.0 (Broadcast)

Figure 5.4 Response monitoring timer/Broadcast delay operation

(d) The Broadcast delay times out

When the Broadcast delay times out after transmission of a request message, it means normal completion, and the corresponding bit in the buffer memory's automatic communication operating status storage area turns OFF. (address: 0C20H to 0C21H/0C22H to 0C23H)

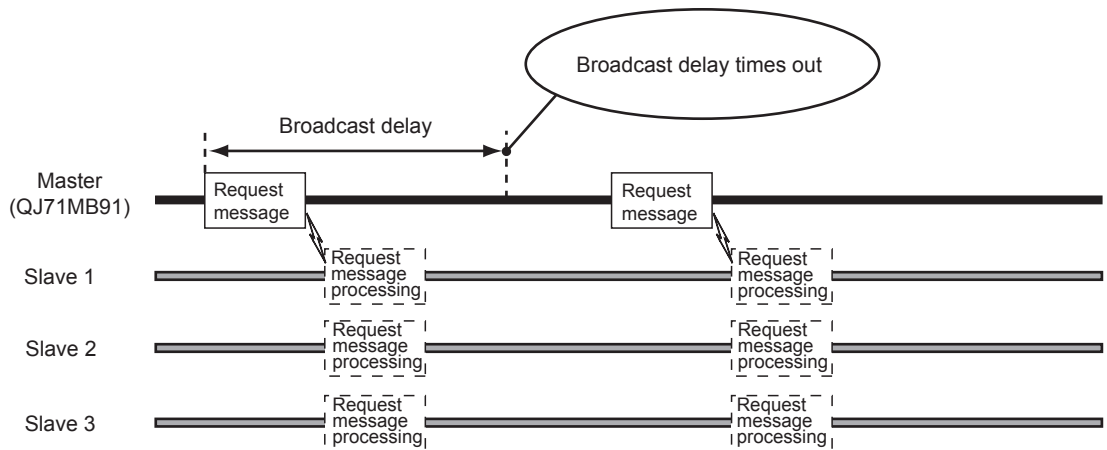

Figure 5.5 Timeout of Broadcast delay

(e) Receiving response message from slave

When slave processing is complete, a response message is received.

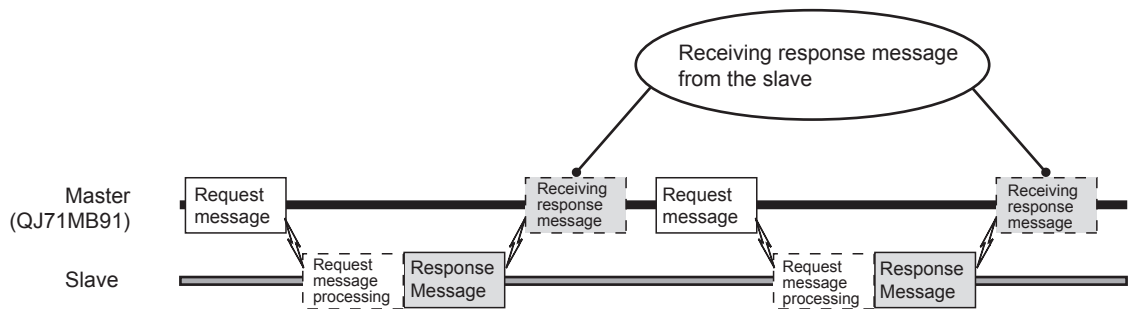

Figure 5.6 Reception of response message

- (f) The Response monitoring timer times out
 If an error occurs at the relevant station (e.g. programmable controller CPU), the slave may not be able to send a response message.
 In such a case, the Response monitoring timer times out.

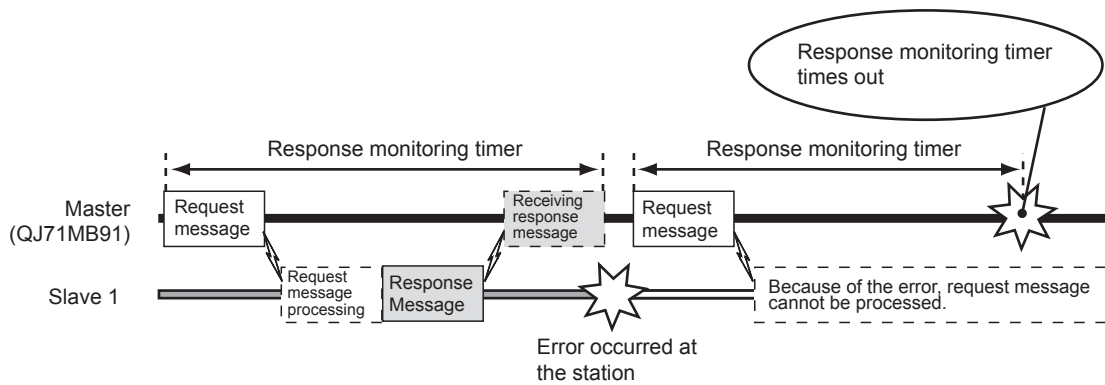

Figure 5.7 Response monitoring timer operation

If the Response monitoring timer times out, the corresponding bit in the buffer memory's automatic communication operating status storage area turns ON. (address: 0C20H to 0C21H/0C22H to 0C23H)

- (g) The Response monitoring timer is terminated
 When the master (QJ71MB91) receives a response message, the Response monitoring timer is terminated.

(3) Execution sequence in the automatic communications

Automatic communication is executed in order from Automatic communication parameter 1.

After the final automatic communication parameter is executed, the automatic communication parameters are executed from automatic communication parameter 1 again.

Example: If Automatic communication parameters 1 to 3 are set

Automatic communications are executed in the order: 1 → 2 → 3 → 1 → 2 ...

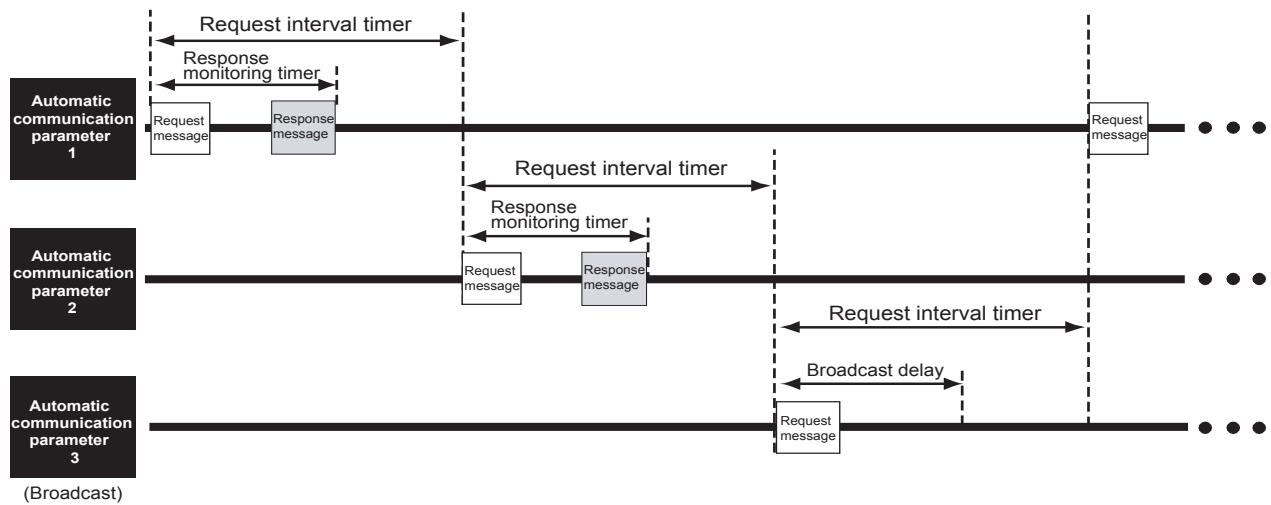

Figure 5.8 Automatic communication execution sequence

POINT

If no automatic communication parameter is set, no automatic communication is executed. (☞ Section 7.2.1 (1))

For example, if Automatic communication parameter 2 has no setting in the Figure 5.8, automatic communication will be executed in the order: 1 → 3 → 1 → 3 ...

(4) Storage location for the data read/written by the automatic communication

Data to be read or written by the automatic communication function are stored in the following buffer memory.

Table5.2 Data storage location (buffer memory)

Name	Description	Buffer memory address
Automatic communication function buffer input area	Area used for storing data read from the slave	CH1: 1000H to 1FFFH (4096 to 8191) CH2: 2000H to 2FFFH (8192 to 12287)
Automatic communication function buffer output area	Area used for storing data written to the slave	CH1: 3000H to 3FFFH (12288 to 16383) CH2: 4000H to 4FFFH (16384 to 20479)

POINT

1. Read/write data in the above areas are stored in RTU mode (binary) even if the frame mode is ASCII mode.
2. Read/write data consistency is secured in units of one word (16 bits).

(a) Transfer direction of the automatic communication function buffer input/output area data

The data to be stored into the buffer memory by the automatic communication function are transferred in the following directions.

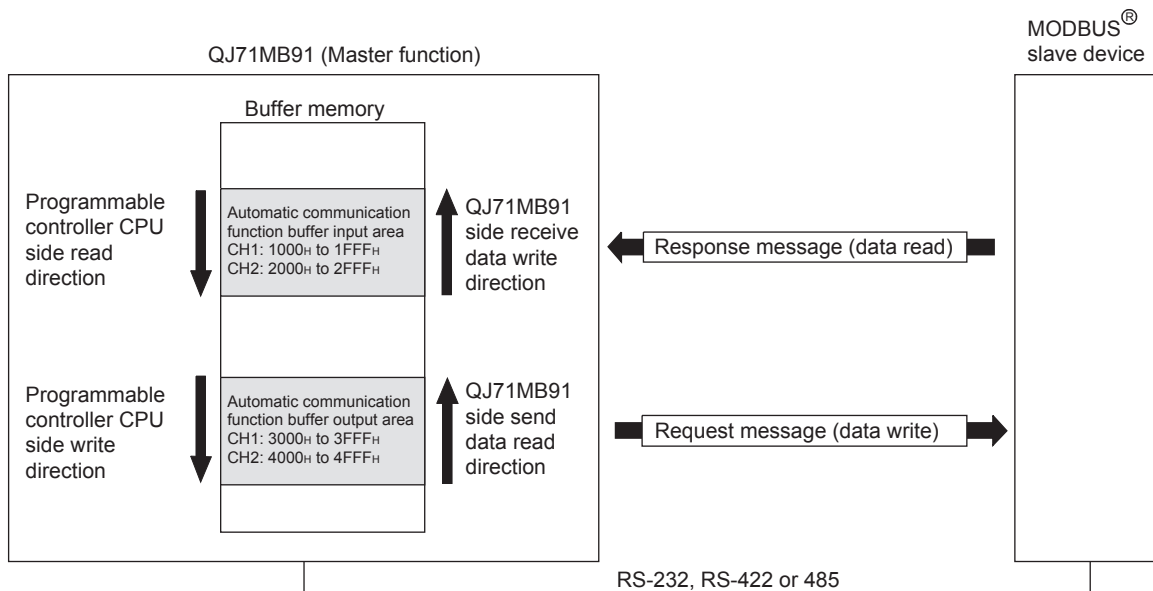

Figure 5.9 Transfer direction of the automatic communication function buffer input/output area data

1) Transfer direction of the automatic communication function buffer input area data

When receiving a response message from a slave, the QJ71MB91 writes data to the automatic communication function buffer input area in descending order of the addresses in 1 word (16 bits) unit.

2) Transfer direction of the automatic communication function buffer output area data

When sending a request message to a slave, the QJ71MB91 creates it by reading data from the automatic communication function buffer output area in descending order of the addresses in units of one word (16 bits).

- (b) Data transfer timing in the automatic communication buffer area
Data are transferred for each data exchange with the target station.
- (c) Data transfer between the automatic communication function buffer areas and programmable controller CPU device memory
Data can be transferred between the automatic communication buffer area and programmable controller CPU device memory by either of the following methods.

Table5.3 Data transfer between automatic communication function buffer areas and programmable controller CPU device memory

Transfer method	Description
Transfer by auto refresh setting	Make the auto refresh setting on GX Configurator-MB. (☞ Section 8.5)
Transfer using the sequence program	Specify the intelligent function module device (Un\G□) in a sequence program to make transfer.*1

* 1 Refer to the following manual for details on the intelligent function module devices.

☞ User's Manual (Function Explanation, Program Fundamentals) for the CPU module used

(5) Start and stop of the automatic communication function

- (a) When the automatic communication parameters are set on GX Configurator-MB
When the automatic communication parameters are set on GX Configurator-MB, no sequence program for start is required.
- 1) Operation timing of the automatic communication function
The automatic communication function is activated by powering ON the programmable controller from OFF or by resetting the programmable controller CPU (with the programmable controller CPU's RUN/STOP switch set to RUN).
The automatic communication will not start if the programmable controller is powered ON from OFF or if the programmable controller CPU is reset (with the programmable controller CPU's RUN/STOP switch set to STOP).
If the QJ71MB91 is mounted on a MELSECNET/H remote I/O station, the automatic communication function is activated when the remote I/O station receives the information notifying the status change (from STOP to RUN) of the remote master station's programmable controller CPU.
 - 2) How to check the activation of the automatic communication function
When the QJ71MB91 starts communication with the slave device with the automatic communication function, the SD and RD LEDs turn ON. (Only when communicating)
 - 3) Automatic communication start/stop test
On the "Automatic communication status" screen of GX Configurator-MB, the start/stop test of the automatic communication function can be performed.
( Section 8.6.3)

(b) When the automatic communication parameters are set with sequence programs
 If the automatic communication parameters are set with sequence programs, the automatic communication function can be started or stopped at any timing.

1) Operation timing of the automatic communication function

To start or stop the automatic communication function from a sequence program, turn on/off Automatic communication parameter setting request/ Automatic communication start request (Y4/YC) and Automatic communication stop request (Y6/YE).

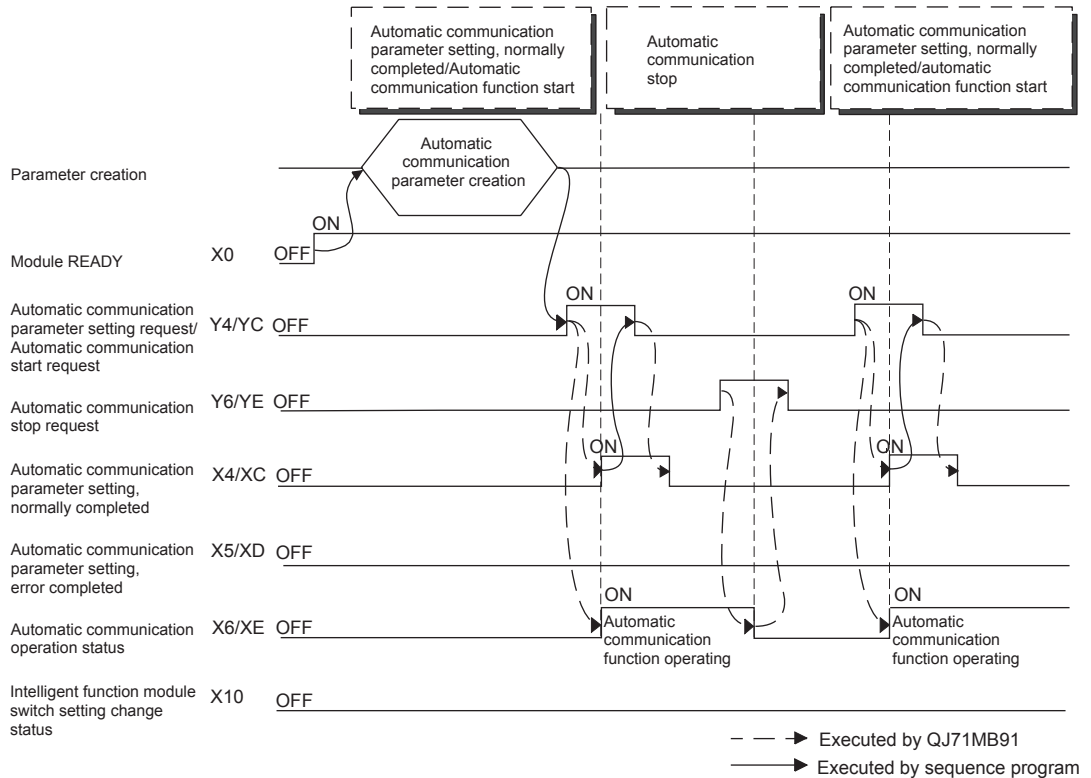

Figure 5.10 Automatic communication time chart

(6) Precautions for starting/stopping the automatic communication function

- (a) When turning ON the Automatic communication parameter setting request/ Automatic communication start request (Y4/YC)
Both of the following conditions must be satisfied before turning ON the request (Y4/YC).
- Condition 1: Module READY (X0) is ON.
 - Condition 2: Intelligent function module switch setting change status (X10) is OFF.

- (b) Automatic communication function stop by Automatic communication stop request (Y6/YE)
When using Automatic communication stop request (Y6/YE) to stop the automatic communication function, satisfy all of the following conditions.
- Condition 1: Module READY (X0) is ON.
 - Condition 2: Automatic communication operation status (X6/XE) is ON.
 - Condition 3: Intelligent function module switch setting change status (X10) is OFF.



Even if no response is sent from the communication target slave, the automatic communication function does not stop until Automatic communication stop request (Y6/YE) turns on.

- (c) When Automatic communication stop request (Y6/YE) is executed while automatic communication is stopped
An error (error code: 7370H) will occur if Automatic communication stop request (Y6/YE) is executed while the automatic communication function is stopped (Automatic communication operation status (X6/XE) is OFF).
- (d) Restarting the automatic communication function after issuing Automatic communication stop request (Y6/YE)
Since Automatic function stop request (Y6/YE) stops the automatic communication at the time of its execution, depending on the timing, the automatic communication may be stopped during or immediately after transmission of a request message.
For this reason, when restarting the automatic communication, allow a sufficient time for the slave to process the request message that is received before the stop.

Failure to do so may cause an error due to collisions of the QJ71MB91 request message and slave's response message when automatic communication is restarted.

- (e) When the automatic communication parameters are set on GX Configurator-MB
When the automatic communication parameters are set on GX Configurator-MB, the automatic communication function will be automatically started at the timing shown in (5) (a) 1) of this section.
When the automatic communication function is active, and when the target slave device is not in normal condition (disconnected, down, not ready for communication, etc.), perform either of the following:
- After the target slave device is recovered, set automatic communication parameters on the sequence program and start the automatic communication function.
 - Ignore the error (Exception message reception (error code: 7360H) or Response monitoring timer timeout error (error code: 7378H), etc.)

(7) Automatic communication operation status

- (a) Checking the automatic communication operation status
Use Automatic communication error status (X6/XE) to confirm the automatic communication operation status.
- (b) Confirming the error occurred
When an error occurs in the automatic communication, Automatic communication error status (X7/XF) turns ON.
Also, any erroneous part of the parameters and error details can be identified by the following:
- 1) Acquisition of the automatic communication parameter number for the error
Check the automatic communication operation status storage area (0C20H to 0C21H/0C22H to 0C23H) in the buffer memory to identify the error.
( Section 11.4.1 (5))
 - 2) Error code check
In the automatic communication error code storage area (0C28H to 0C47H/0C48H to 0C67H) of the buffer memory, check the error code stored in the area corresponding to the automatic communication parameter number identified in the above 1).
( Section 11.4.1 (8), Section 11.4.3)

POINT

On the "Automatic communication status" screen of GX Configurator-MB, the operation status and error code for each automatic communication parameter can be confirmed. ( Section 8.6.3)

(8) Checking presence of the automatic communication function settings

If the automatic communication function does not operate although no error has occurred regarding (7), check the presence of the settings in the automatic communication setting status storage area (address: 0CA8H to 0CA9H/0CAAH to 0CABH) in the buffer memory. ( Section 11.4.1 (7))
Check it with Automatic communication operation status (X6/XE) ON.
If there are no settings, make the settings again.

5.2.2 Communication by dedicated instructions

The dedicated instructions allow reading/writing of MODBUS® devices at any timing with a sequence program.

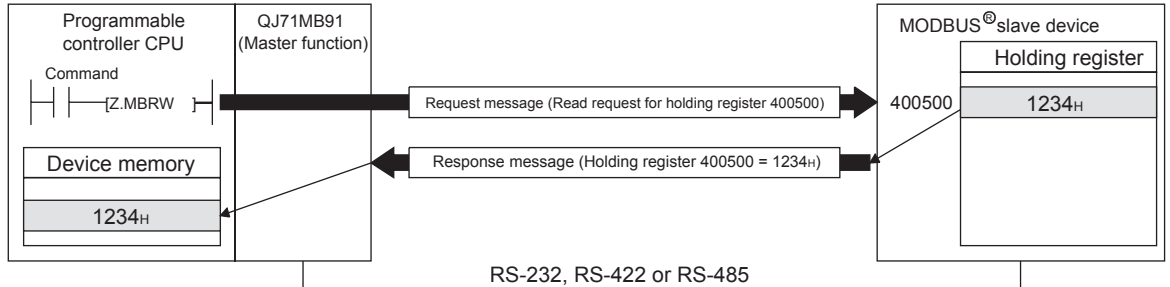

Figure 5.11 Communication by dedicated instruction

The following is a list of available dedicated instructions.

Table 5.4 Dedicated instruction list

Dedicated instruction	Description	Reference
MBRW	Issues a MODBUS® device read/write request message to a slave.	Section 10.2
MBREQ	With this instruction, a request message can be sent to a slave in any given Protocol Data Unit format.	Section 10.3

5.3 Slave Function

This section explains the functions of the QJ71MB91 acting as a MODBUS® slave.

5.3.1 Automatic response function

By the automatic response function, the QJ71MB91 (slave function) automatically executes the processing requested by the function code (☞ Section 4.1) of a request message from the master, and returns a response message to the master.

For device read/write or exception status read, use the MODBUS® device assignment function. (☞ Section 5.3.2)

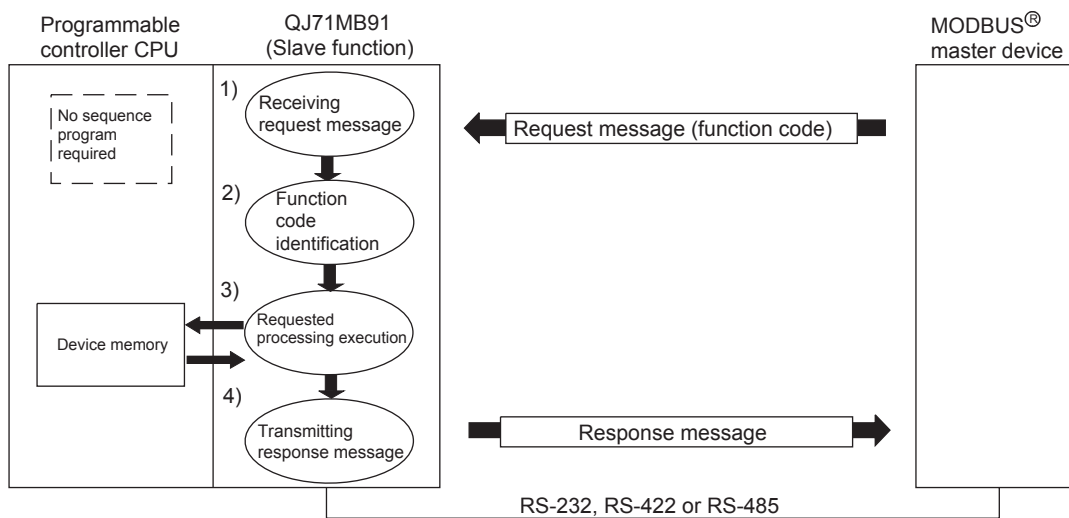

Figure 5.12 Automatic response function

5.3.2 MODBUS(R) device assignment function

The MODBUS® device assignment function automatically converts access to a slave (QJ71MB91) MODBUS® device into access to a programmable controller CPU device. This allows direct access from the MODBUS® compatible master device to the programmable controller CPU device memory.

Supporting the MODBUS® devices of large capacity, the QJ71MB91 allows all device memories of the programmable controller CPU to be assigned. (☞ Section 7.3.1)

(1) MODBUS® device assignment parameter setting

Set the MODBUS® device assignment parameters to the slave (QJ71MB91). The following settings are possible for the MODBUS® device assignment parameters.

- (a) Correlating the MODBUS® device to the programmable controller CPU device memory.

When a message requesting an action such as write coil is received from the master, the access to the MODBUS® device is automatically converted into access to the programmable controller CPU device. (☞ Section 7.3.1 to Section 7.3.3)

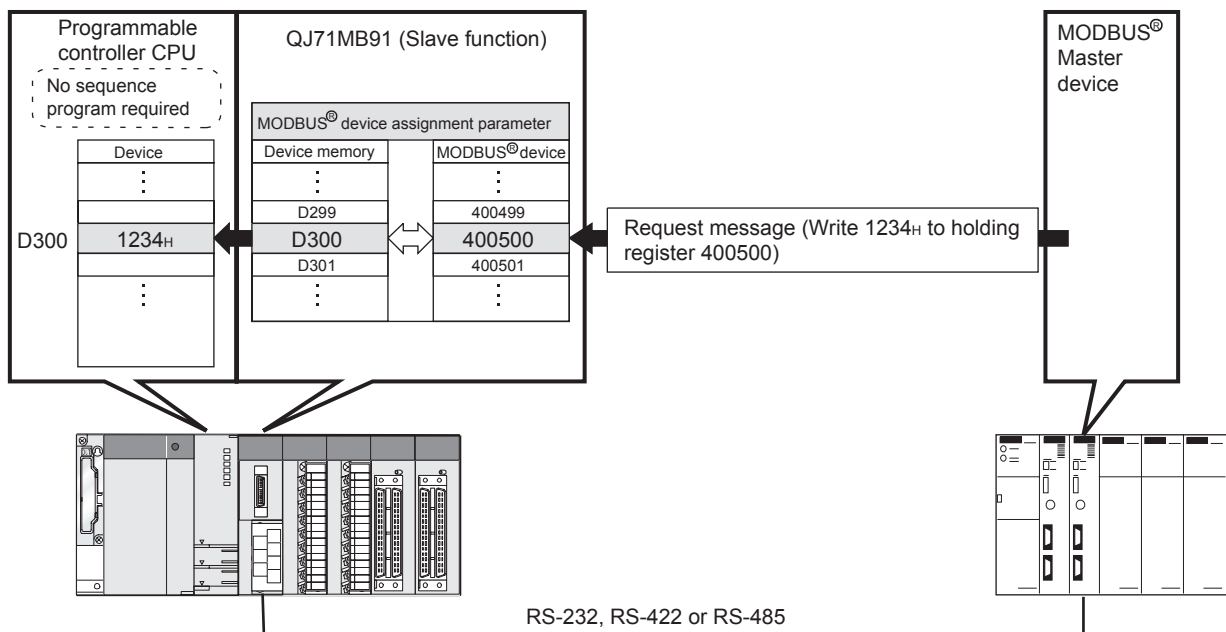

Figure 5.13 MODBUS® device and programmable controller CPU device

(b) Specifying the error status read device

Users can specify the data to be read out as an exception status when the QJ71MB91 (slave) receives Read Exception Status (FC:07) from the master. (☞ Section 7.3.4)

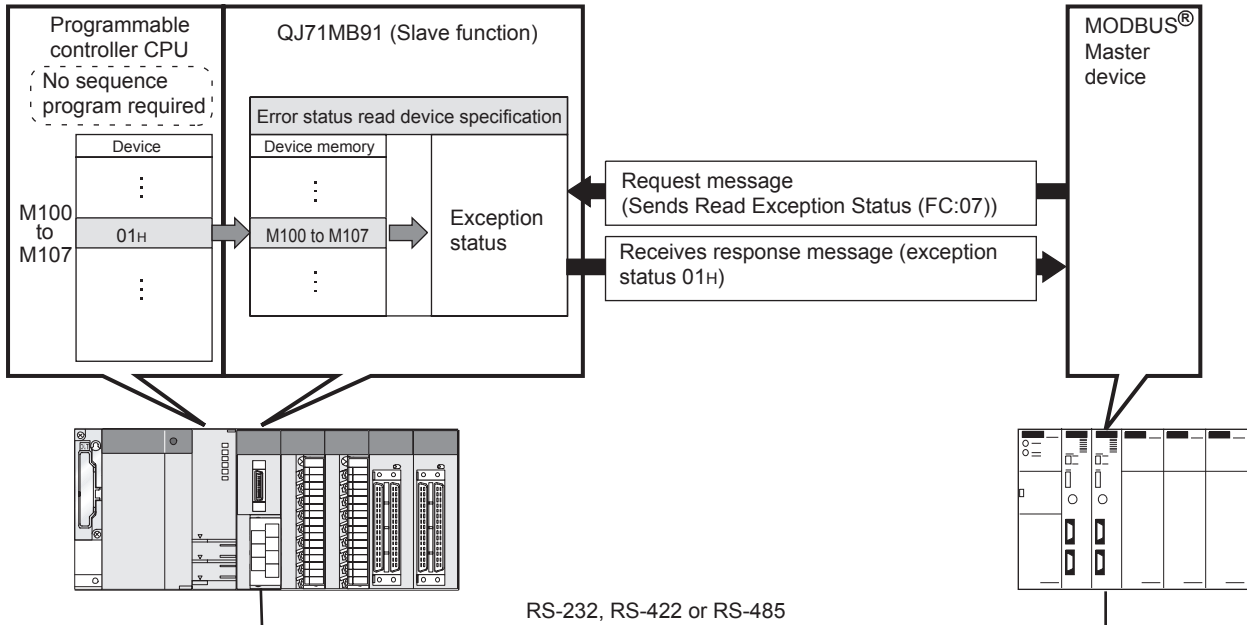

Figure 5.14 Error status read device and programmable controller CPU device

(c) Specifying access target when mounted to MELSECNET/H remote I/O station

For the case where the QJ71MB91 is mounted to a MELSECNET/H remote I/O station, the access target can be specified. (☞ Section 7.3.5)

The access target can be selected from the MELSECNET/H remote master station and the MELSECNET/H remote I/O station.

(d) Specifying the CPU response monitoring timer

Specify the timer value so that the QJ71MB91 will monitor the processing of the access target programmable controller CPU. (☞ Section 7.3.6)

In the case of an error at the access target programmable controller CPU and if any response message cannot be sent, another response message (error complete) can be sent after a given length of time has elapsed.

This will prevent the master from waiting for a response message that will not be received.

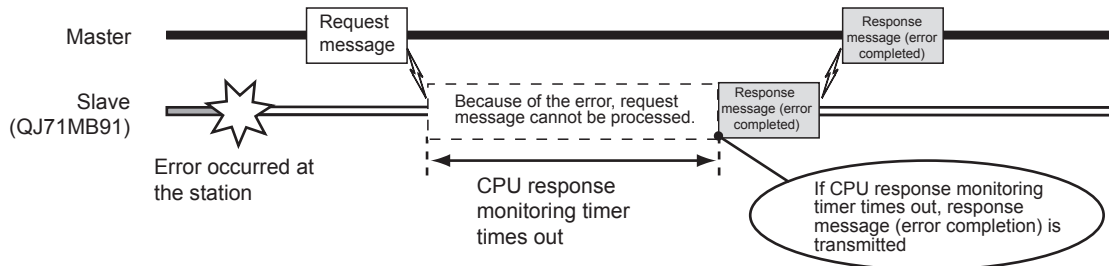

Figure 5.15 CPU response monitoring timer operation

(2) Setting the MODBUS® device assignment parameters

Set the MODBUS® device assignment parameters by the utility package (GX Configurator-MB). (☞ Section 8.4.2)

Setting from a sequence program is also available. (☞ Section 9.1.2)

5.3.3 Link operation function

(1) The link operation function

The link operation function enables the master connected to CH1 (RS-232) to communicate with multiple slaves connected to QJ71MB91's CH2 (RS-422/485). If the link operation function is used, a RS-232 interface (1-to-1 communication) MODBUS[®] master device can communicate with several MODBUS[®] slave devices.

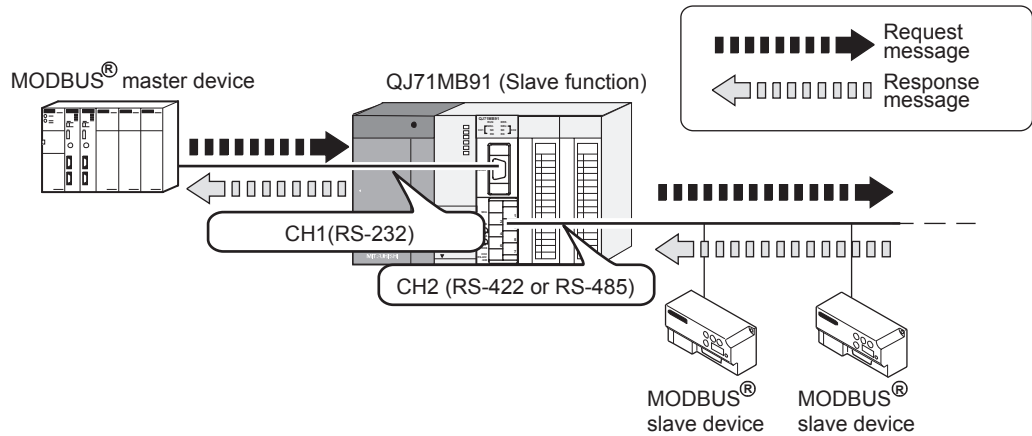

Figure 5.16 Communication using the link operation function

(2) Setting the link operation function

The link operation function can be set with the intelligent function module switch (☞ Section 6.6).

(3) Message flow during link operation

A request message received on CH1 is sent to a slave from CH2.

A response message received from CH2 is sent to the master from CH2.

If a request message addressed to the QJ71MB91 is received, the QJ71MB91 will act as a slave. (The link operation is not performed.)

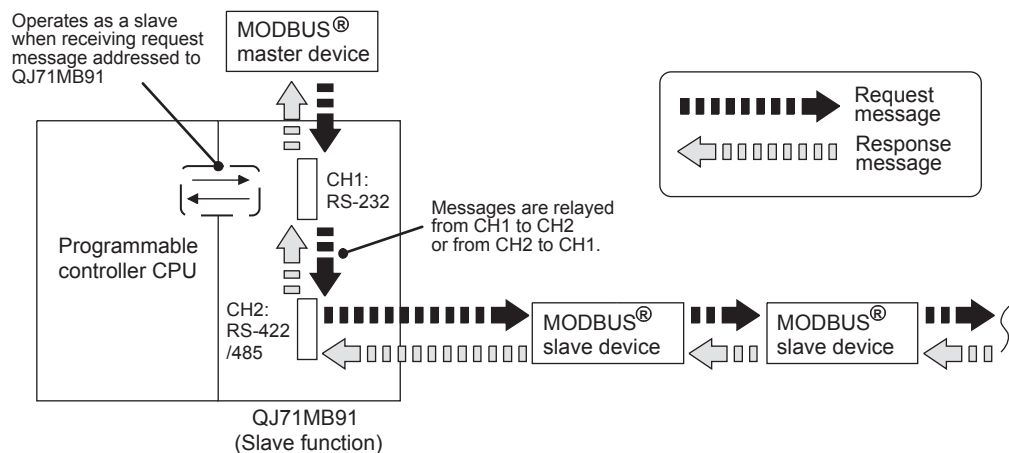

Figure 5.17 Message flow during link operation

(4) Precautions for the link operation function

(a) System configuration

Connect the MODBUS[®] master device to CH1 (RS-232) of the QJ71MB91.

While using the link operation function, the MODBUS[®] master device cannot be connected to CH2 (RS-422/485).

(b) Intelligent function module settings

The intelligent function module switch settings for channels 1 and 2 must be identical.

If not, a switch error will be generated. (Except for MODBUS[®] device assignment parameter starting methods in the transmission speed setting/transmission setting (switch 2, 4).)

CHAPTER6 PRE-OPERATIONAL PROCEDURES AND SETTINGS

This chapter explains the procedures and setting method for operating the QJ71MB91 in a system.

POINT

1. For use of the QJ71MB91, read the safety precautions provided in the first pages of this manual.
2. The QJ71MB91 implementation and installation environment are the same as those of the programmable controller CPU.
Refer to the following manual regarding the QJ71MB91 implementation and installation environment.
 QCPU User's Manual (Hardware Design, Maintenance and Inspection)

6.1 Handling Precautions

This section explains the precautions for handling the QJ71MB91.

- 1) Since the case of the QJ71MB91 is made of resin, do not drop or give it hard impact.
- 2) Before handling modules, touch a grounded metal object to discharge the static electricity from the human body.
Failure to do so may cause failure or malfunctions of the module.
- 3) Tighten the screws such as module fixing screws within the following ranges.

Table6.1 Tightening torque

Screw	Tightening torque range	Remarks
Terminal screw for RS-422/485 terminal block (M3 screw)	0.42 to 0.58 N · m	-
Mounting screw for RS-422/485 terminal block (M3.5 screw)	0.66 to 0.89 N · m	-
RS-232 cable connector screw (M2.6 screw)	0.20 to 0.39 N · m	Screw hole depth:L=3.2mm or less (Internal length from the surface)
Module fixing screw (normally not required) (M3 screw) *1	0.36 to 0.48 N · m	-

* 1 The module can be easily fixed onto the base unit using the hook at the top of the module. However, it is recommended to secure the module with the module fixing screw if the module is subject to significant vibration.

6.2 Pre-Operational Procedures and Settings

A rough procedure for operation is shown below.

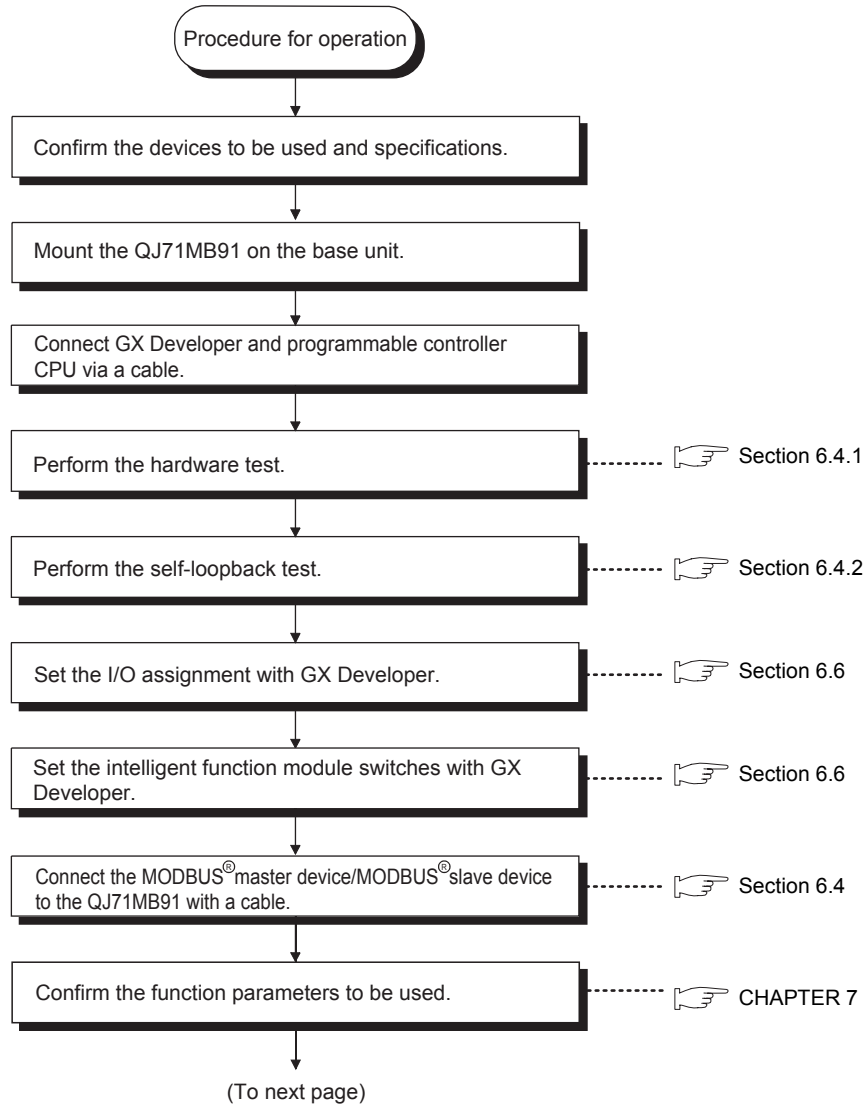

Figure 6.1 Pre-operational procedures and settings

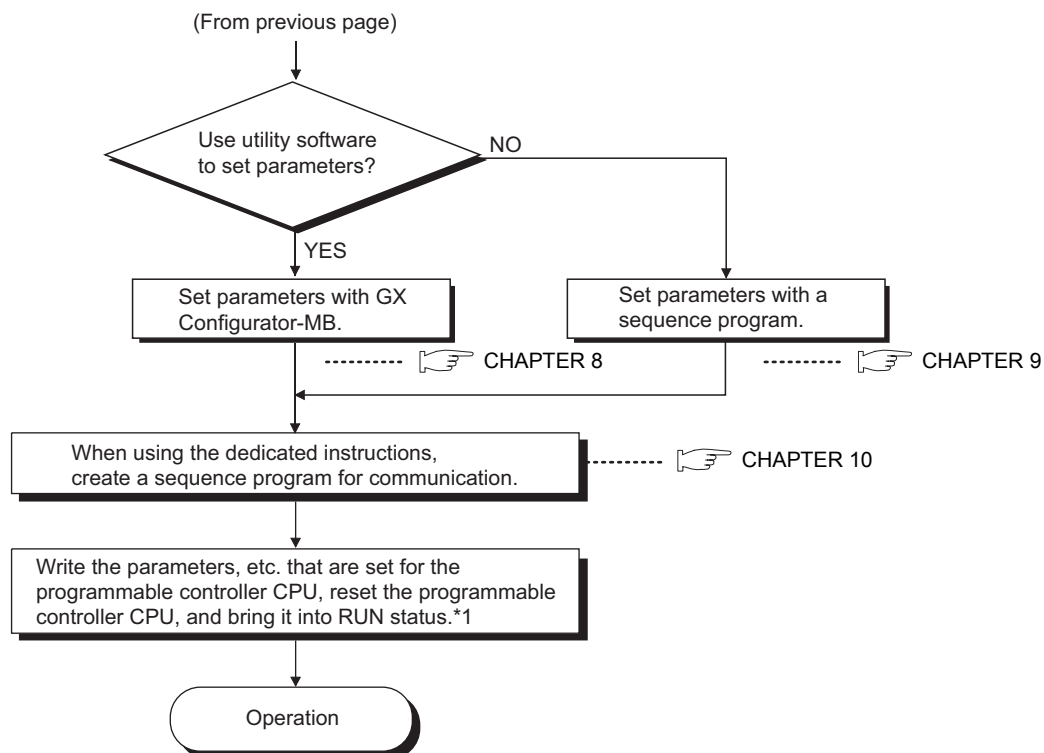

Figure 6.1 Pre-operational procedures and settings (Continued)

* 1 If parameters are set at the GX Configurator-MB, power OFF and then ON or reset the programmable controller CPU with the CPU RUN/STOP switch set at RUN.

POINT

1. When setting parameters, do not write any data to the "System area (use prohibited)" in the QJ71MB91 buffer memory. (☞ Section 3.5.1)
Writing data to the "System area (use prohibited)" may cause malfunction of the programmable controller system.
2. When making any parameter registration request etc., do not output (turn ON) any "Use prohibited" output signal. (☞ Section 3.4.1)
Doing so may cause malfunction of the programmable controller system.
3. Use GX Developer to make I/O assignment and intelligent function module switch setting.
Perform QJ71MB91 automatic communication parameter (☞ Section 7.2) settings at the GX Configurator-MB or the sequence program.
4. To update the parameter settings added/changed on GX Developer, write the parameters to the programmable controller CPU, and then reset the programmable controller CPU.

6.3 Part Names

This section provides the names of the QJ71MB91 parts.

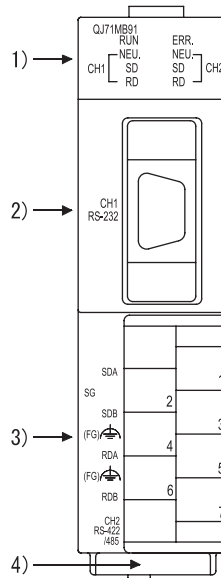

Figure 6.2 QJ71MB91 external diagram

Table 6.2 Part names and descriptions

Name	Description
1) Indicator LED	Indicator LEDs (☞ This section (1))
2) CH1 side RS-232 interface	RS-232 interface for serial communication with target devices (D-Sub 9P)
3) CH2 side RS-422/485 interface	RS-422/485 interface for serial communication with target devices (Detachable terminal block)
4) Serial number plate	Indicates the serial No. of the QJ71MB91.

(1) Display LED list

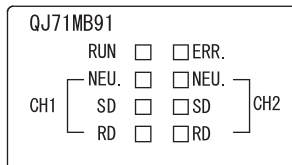

Figure 6.3 QJ71MB91 LEDs

Table 6.3 Description of LEDs

LED name	Indication		Description		
			ON/Flashing	OFF	
RUN	Normal operation		Normal	Watch dog timer error, hardware fault	
ERR.	Error indication *1		Error occurred	Normal	
CH1/ CH2	NEU.	Neutral status	Master function	Request message not transmitted	Waiting for response message from slave
			Slave function	Waiting for request message from master	Request message being processed
	SD	Transmission status	Data being transmitted	Data not transmitted	
	RD	Reception status	Data being received	Data not received	

* 1 For troubleshooting, refer to the following.

CHAPTER 11

6.4 Unit Tests

This section explains the unit tests performed before operating the QJ71MB91.

6.4.1 Hardware test

The hardware test is a test for checking the RAM and ROM of QJ71MB91.

(1) Hardware test procedure

Perform the hardware test according to the following procedure.

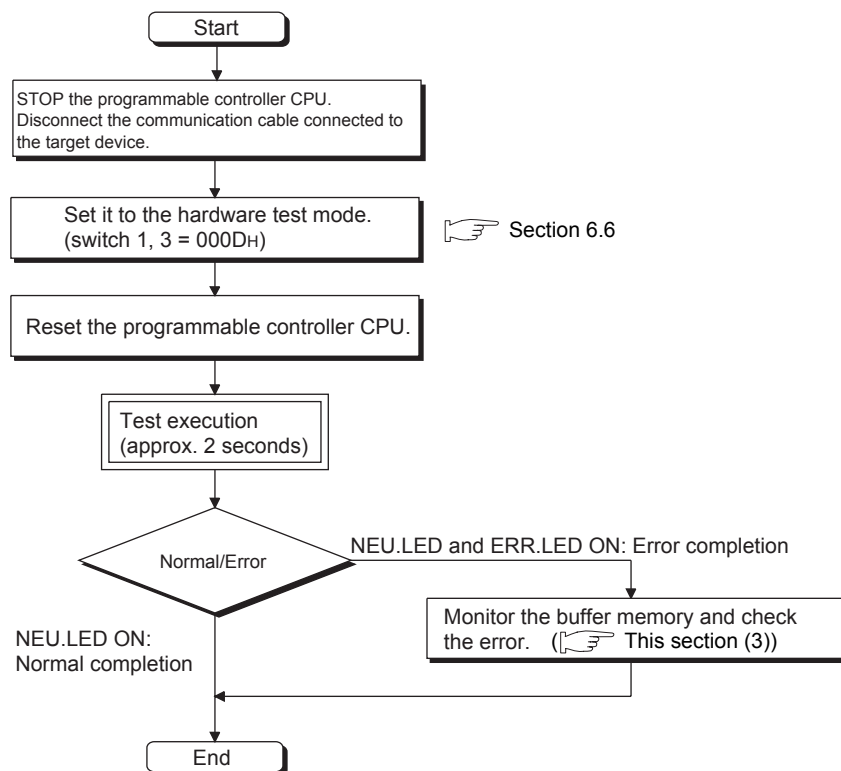

Figure 6.4 Hardware test procedure

(2) Hardware test contents

The QJ71MB91 performs the following tests once.

- (a) ROM check
Reads ROM data and perform a sum check.
- (b) RAM check
Writes test data in RAM and read the written data to perform the check.

(3) Confirmation of hardware test results

When the CH1 NEU.LED turns ON, the test is completed. (Approx. 2 seconds)

(a) When completed normally

The ERR.LED turns OFF at normal completion.

(b) When completed abnormally

The ERR.LED turns ON at abnormal completion.

If the test is completed abnormally, monitor the hardware test result (OFFEH) of the buffer memory to check the error details.

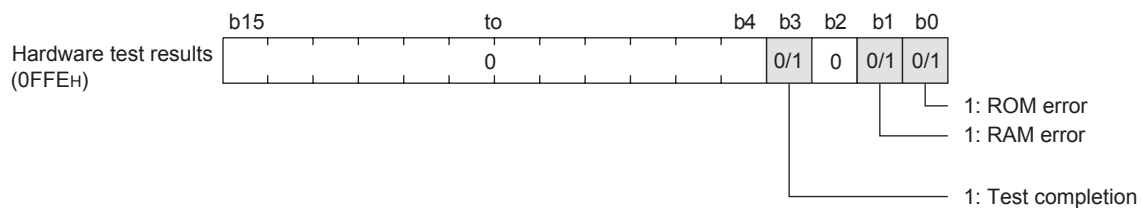

Figure 6.5 Hardware test results storage details

(4) Hardware test completion

After confirming normal completion/abnormal completion of test results, perform the following operations.

(a) When completed normally

To start data communication with a target device after completing the test, perform the following operation to start the data communication.

- Perform the intelligent function module switch settings at GX Developer. (☞ Section 6.6)
- Power OFF the station and connect a communication cable to the target device.
- Power ON the station.

(b) When completed abnormally

If a ROM/RAM error occurs, check the following and re-perform the test.

- The QJ71MB91, power supply module and programmable controller CPU are mounted correctly on the base unit.
- The operating environment of the QJ71MB91 meets the general specifications of the programmable controller CPU. (☞ QCPU User's Manual (Hardware Design, Maintenance and Inspection))
- The power capacity is sufficient.
- The hardware of the programmable controller CPU and base unit is normal according to the manual of each module.

If, after checking the above points and re-performing the test, the hardware test is completed abnormally again, a QJ71MB91 hardware error may have occurred.

Please consult your local Mitsubishi service center or representative, explaining a detailed description of the problem.

6.4.2 Self-loopback test

The self-loopback test checks the send/receive function of the QJ71MB91 and communications with the programmable controller CPU.

(1) Self-loopback test procedure

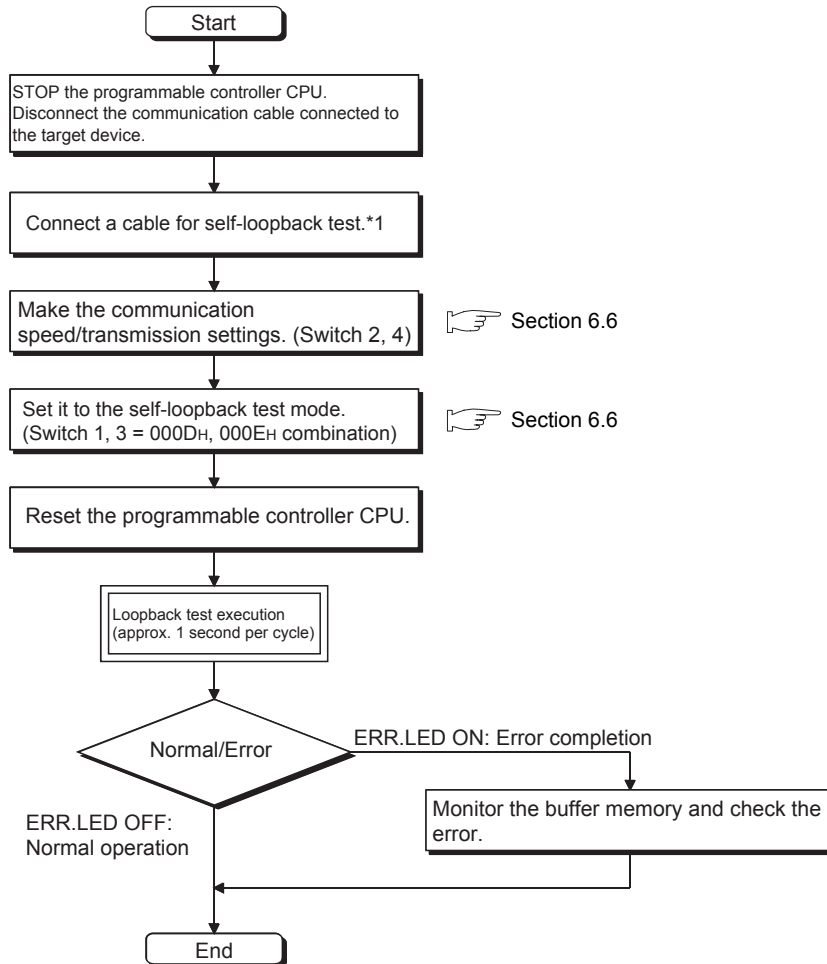

Figure 6.6 Self-loopback test procedure

* 1 This is the cable wiring for self-loopback test.

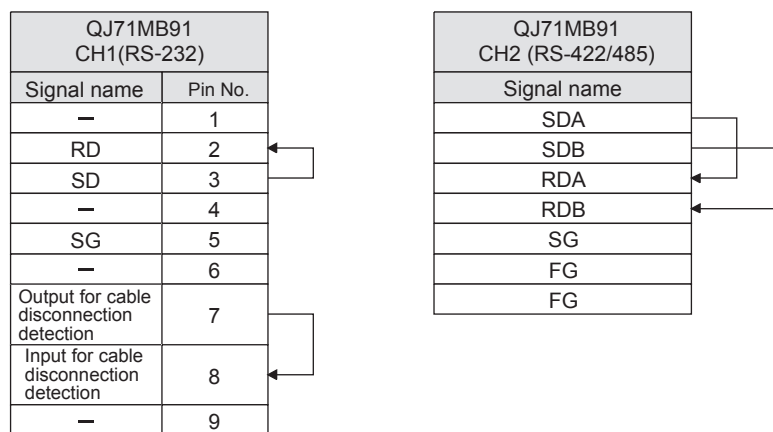

Figure 6.7 Cable wirings for self-loopback test

(2) Self-loopback test details

The QJ71MB91 performs the following test repeatedly. (Test for one cycle is performed in approximately one second.)

- (a) Programmable controller CPU communication check (The CH1 NEU.LED flickers.)
Checks that communication with the programmable controller CPU is enabled.
- (b) Each interface communication function check (The SD/RD LED of the tested interface flickers.)
Performs data send and receive while changing data.*1

* 1 If the data bit length is set to 7 bits, the 8th bit will be ignored during sending and receiving in the test.

(3) Self-loopback test results check

This test is performed repeatedly. If the ERR.LED is OFF, the test is being operated normally.
If the ERR.LED turns ON, the test is completed with an error.

When the test is completed abnormally, monitor the self-loopback test results (0FFF_H) of the buffer memory and check the error details.

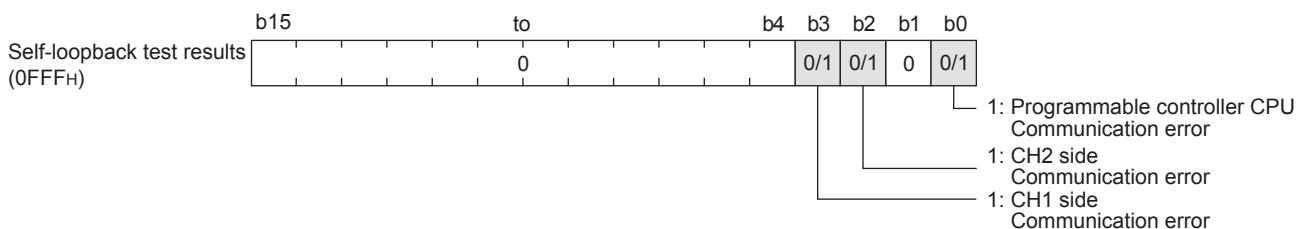

Figure 6.8 Self-loopback test results storage details

Table6.4 Error cause and corrective action

Buffer memory		Cause for corresponding bit ON	Corrective action
Address	Bit position		
0FFF _H (4095)	b0	An error has occurred at programmable controller CPU.	Remove the error cause in the programmable controller CPU.
		The power capacity is not sufficient.	Review the power capacity.
		The module is not mounted correctly.	Mount the module correctly.
		An error has occurred at the base unit, extension cable, programmable controller CPU and QJ71MB91.	Check each module and remove the error cause. <ul style="list-style-type: none"> • Connect the cable correctly. • Mount the module correctly.
	b2	CH2 communication error	Connect the cable correctly.
b3	CH1 communication error	Review the self-loopback test cable wiring connections.	

(4) Self-loopback test completion

(a) When completed normally

To start data communication with a target device after completing the test, perform the following operation to start the data communication.

- Perform the intelligent function module switch settings at GX Developer. (☞ Section 6.6)
- Power OFF the station and connect a communication cable to the target device.
- Power ON the station.

(b) When completed abnormally

If an error occurs, remove the error cause by following the Table 6.4, check the following, and perform the test again.

- The QJ71MB91, power supply module and programmable controller CPU are mounted correctly on the base unit.
- The operating environment of the QJ71MB91 meets the general specifications of the programmable controller CPU module. (☞ QCPU User's Manual (Hardware Design, Maintenance and Inspection))
- The power capacity is sufficient.
- The hardware of the programmable controller CPU and base unit is normal according to the manual of each module.

If, after checking the above points and re-performing the test, the hardware test is completed abnormally again, a QJ71MB91 hardware error may have occurred. Please consult your local Mitsubishi service center or representative, explaining a detailed description of the problem.

6.5 Connection to a Target Device

This section explains the wiring between the QJ71MB91 and target device.

As a wiring precaution and one of the conditions for maximizing the function performance of QJ71MB91 to ensure the highly reliable system, the wiring must be performed so as not being influenced by noise.

(1) About shields

Ground the shield at one end.

(2) When connecting to the target device with an RS-232 line

Refer to the following for the connection cable QJ71MB91 side.

 Section 3.2.1

(3) When connecting to the target device with an RS-422/485 line

Pay attention to the following when making a connection.

(a) Connection cable

Refer to the following regarding the RS-422/485 cable.

 Section 3.3.2

(b) Terminal screws for the terminal block

M3 screws are used on the terminal block for the RS-422/485 interface.

Use a solderless terminal applicable for the terminal.

(4) Connection at the target device side

Make a connection in accordance with the target device's specifications.

(5) Connection cable bending radius

Refer to the following for the connection cable bending radius.

 Appendix 4

6.5.1 How to connect the RS-232 interface

This section describes connection precautions and a connection example for using the QJ71MB91 RS-232 interface.

(1) Connection precautions

(a) Connection cable's FG signal line and shield

Connect the connection cable's FG signal line and shield as follows:

Table 6.5 Connection cable's FG signal line and shield

Item	Connection on the QJ71MB91 side	Remarks
Connection cable's FG signal	Connect to the QJ71MB91 side connector housing.	Do not short-circuit the FG and SG signal lines of the connection cable. When the FG and SG signal lines are connected inside the target device, do not connect the FG signal line to the QJ71MB91 side.
Connecting cable's shield	Connect to the target device's FG terminal or the QJ71MB91 side connector housing.	

(b) Connection diagram

Connect the lines as shown below.

- 1) Connect the FG terminal on the target device and the QJ71MB91 side using the shield of the connection cable.
- 2) Connect each signal line other than SG with the SG signal line in twisted pair.

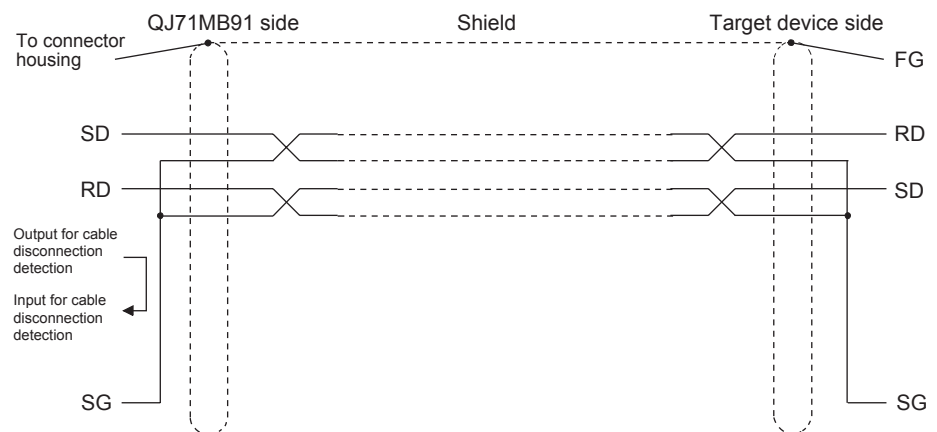

Figure 6.9 RS-232 cable shield

(2) Connection example

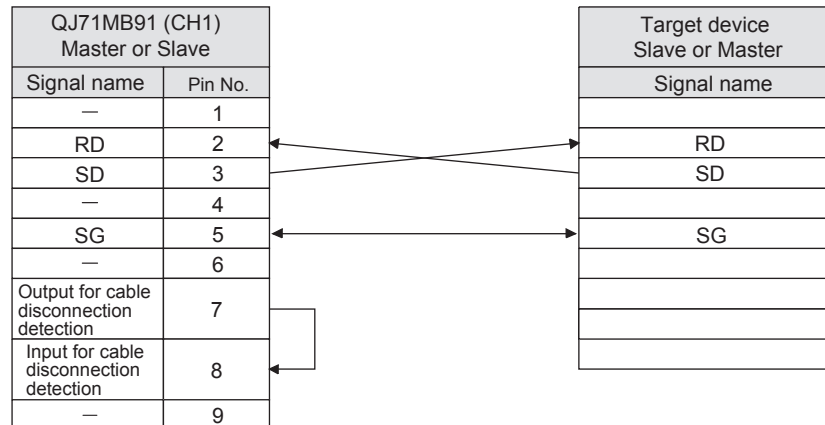

Figure 6.10 RS-232 cable connection example

POINT

For other signal wirings on the target device, refer to the instruction manual of the target device.

6.5.2 How to connect the RS-422/485 interface

This section describes connection precautions and a connection example for using the QJ71MB91 RS-422/485 interface.

(1) Connection precautions

(a) When connecting SG and FG signal lines

When connecting the QJ71MB91 side SG and FG signal lines to the target device, connect them according to the specifications of the target device.

(b) Connecting cable's shield

Connect the shield of the connection cable to either FG terminal on the connected device.

If normal data communication is not available due to external noise even with the above-mentioned wiring, perform the following wiring.

- 1) Make connection between the FGs of both stations with the shield of the connection cable.

For the target device side, follow the instruction manual of the target device.

- 2) Connect the (FG) of the QJ71MB91 to the FG terminal of the power supply module on the station to which the QJ71MB91 is installed, or to the FG terminal of the control panel on which the QJ71MB91 programmable controller is installed.

- 3) Connect nnA and nnB of each signal line of the connection cable in a pair.

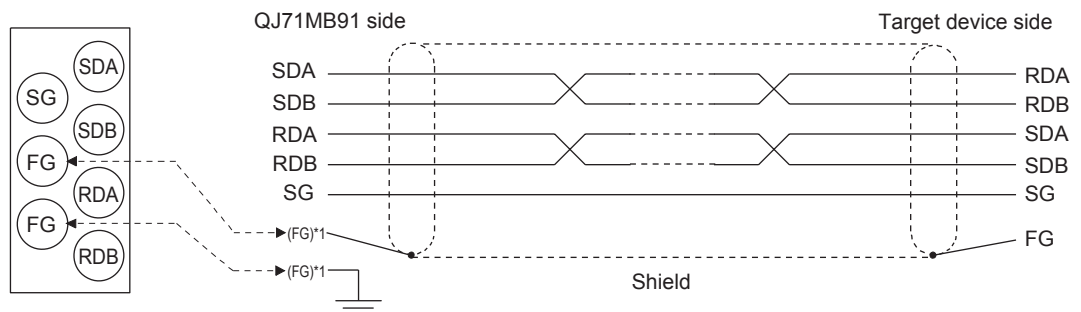

Correspondence between RS-422/485 terminal block and signal position

Figure 6.11 RS-422/485 cable shield

* 1 The QJ71MB91's FG terminal can be connected to either one.

(c) Terminating resistor

Terminating resistor setting (or connection) is required for the stations of both line ends.

For the QJ71MB91 side, connect a terminating resistor (packed with the QJ71MB91), referring to this section and according to the specifications of the target device.

For the target device side, connect or set a terminating resistor according to the instruction manual of the target device.

(Terminating resistor to be connected to the QJ71MB91)

- For RS-422 communications, connect a "330 Ω 1/4W" terminating resistor.
- For RS-485 communications, connect a "110 Ω 1/2W" terminating resistor.

* How to distinguish terminating resistors

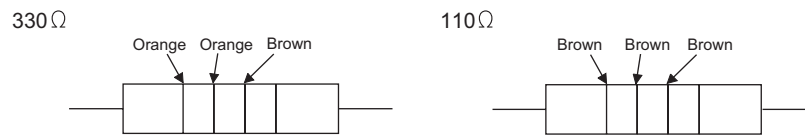

Figure 6.12 How to distinguish terminating resistors

(d) When data communications are not possible at all

If data cannot be exchanged with the target device at all, check the polarity of the target device.

If the polarities of the QJ71MB91 and target device do not match, reverse the polarity of each signal on either device side. This may enable the data communications.

POINT

Devices connected to the QJ71MB91 RS-422/485 interface must be all RS-422 or all RS-485.

(2) Connection examples

(a) Connection for 1:1 communication

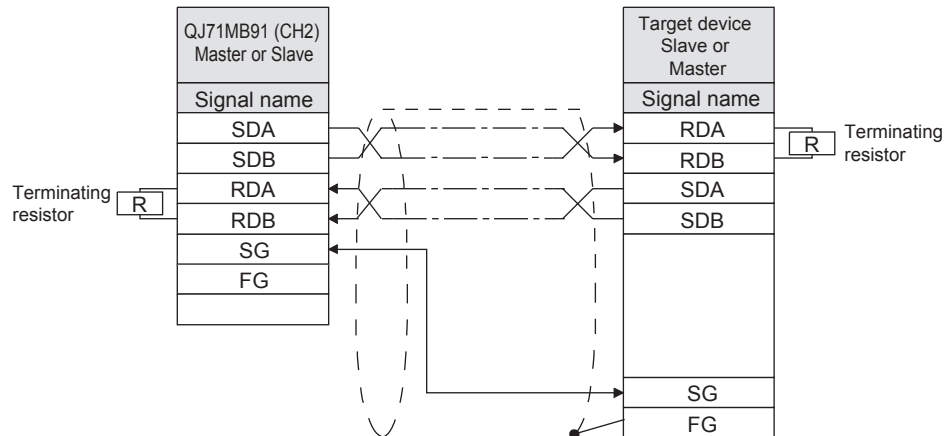

Figure 6.13 Connection for 1:1 communication

(b) Connection for 1:n communication when host is master

1) For 4-wire communications

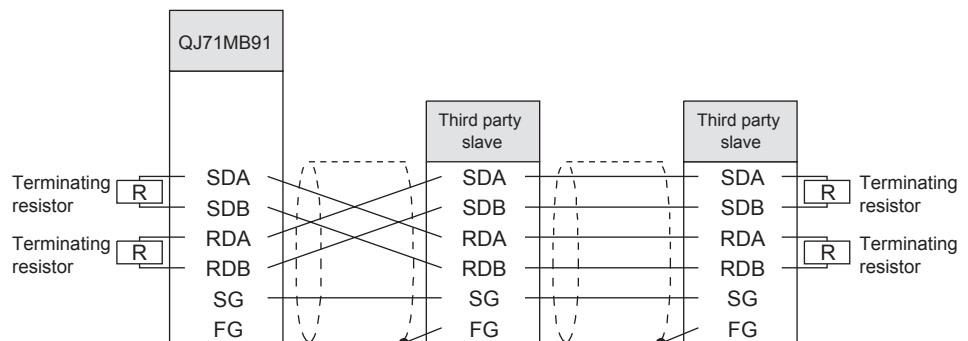

Figure 6.14 Connection (for 1:n communication, 4 wire) when host is master

2) For 2-wire communications

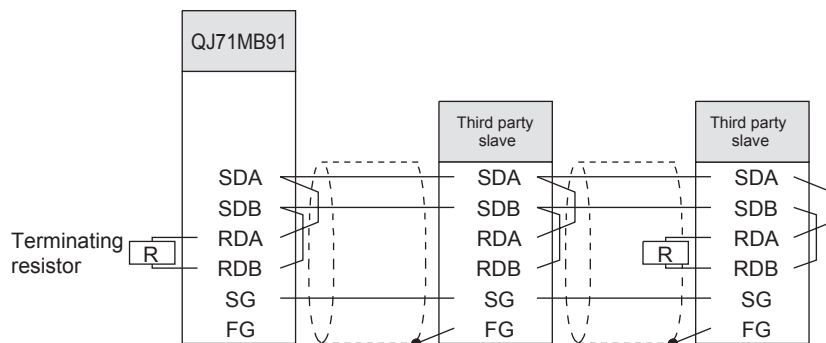

Figure 6.15 Connection (for 1:n communication, 2 wires) when host is master

(c) Connection for 1:n communications when host is slave

1) When performing 1:n communication with third party master station (RS-422/485 interface)

< For 4-wire communications >

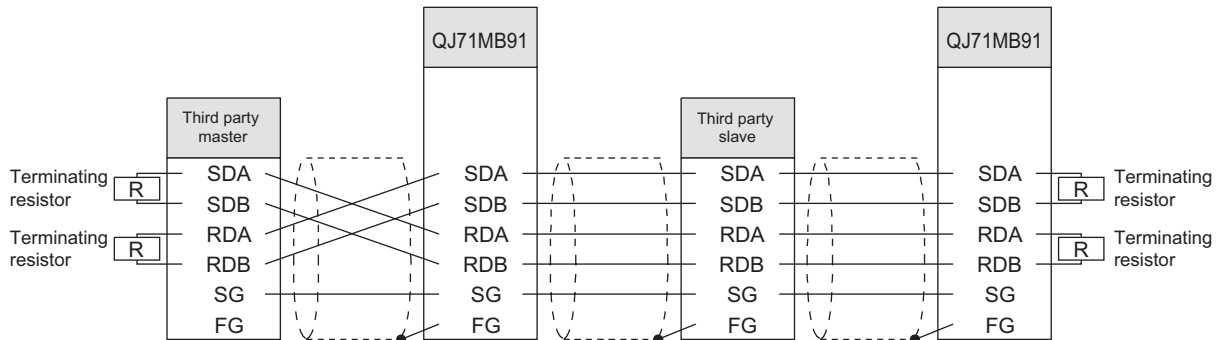

Figure 6.16 Connection (for 1:n communication, 4 wires) when host is slave

< For 2-wire communications >

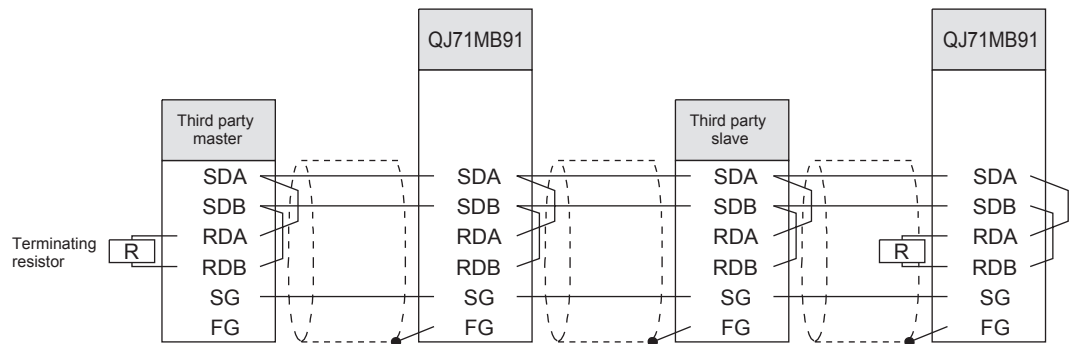

Figure 6.17 Connection (for 1:n communication, 2 wires) when host is slave

- 2) When performing 1:n communication with a third party master station (RS-232 interface)
 (Link operation setting)
 < For 4-wire communications >

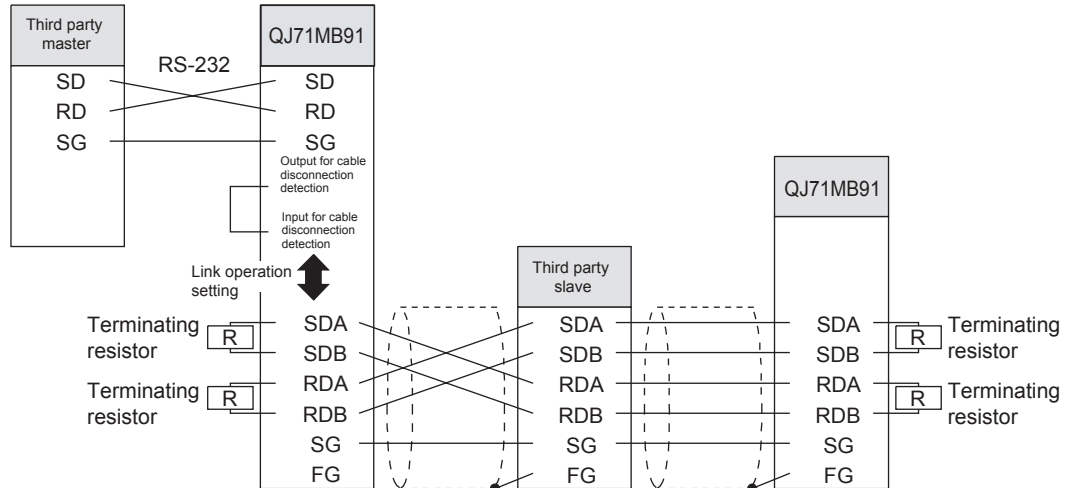

Figure 6.18 Connection (for link operation setting, 1:n communication, 4 wires) when host is slave

< For 2-wire communications >

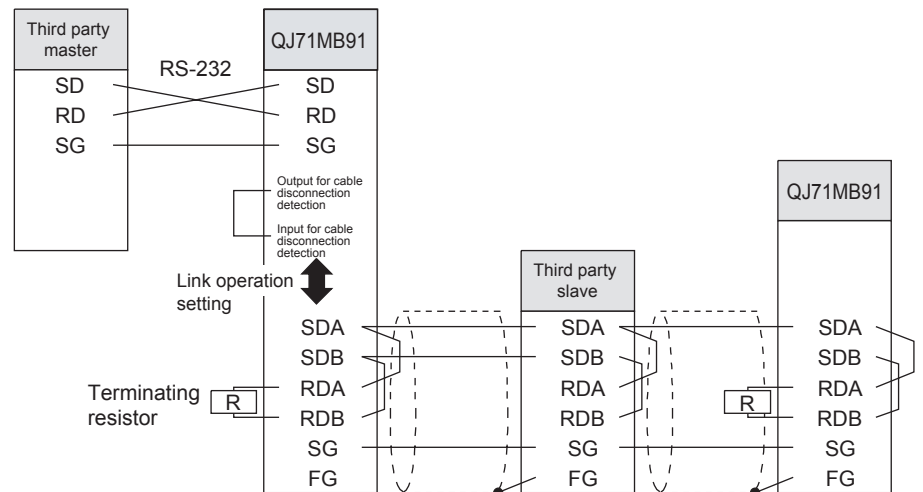

Figure 6.19 Connection (for link operation setting, 1:n communication, 2 wires) when host is slave

6.6 Intelligent Function Module Switch Setting

Set the operation mode, transmission speeds, transmission settings and station numbers.

(1) Setting procedures

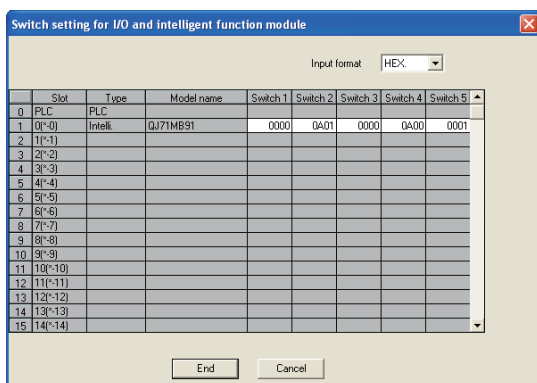
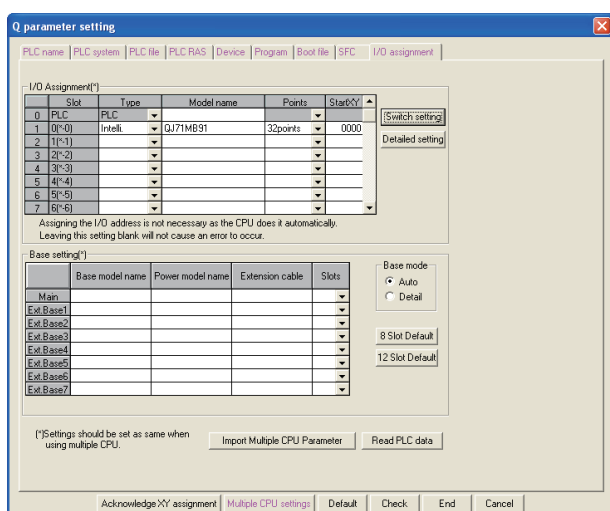
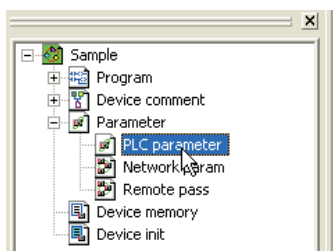

Figure 6.20 Intelligent function module switch setting procedure

1. Start the GX Developer.
2. Double-click "PLC parameter" in the project window of GX Developer.
3. Click the "I/O assignment" tab to display the I/O assignment setting screen.
Set the following to the slot where the QJ71MB91 is mounted.
Type : Select "Intelli".
Model name : Enter the model name of the module.
Points : Select 32 points.
Start XY : Enter the QJ71MB91 head input/output numbers.
Detailed setting : Specify the control CPU of the QJ71MB91 in a multiple CPU system.
4. Click the I/O assignment settings screen **Switch setting** button to display the screen on the left.
Referring to steps (2) and later in this section, make switch settings.
Entering the values in hexadecimal makes the setting easy.
Change the input format into HEX before entering the values.
5. After setting, write the data to the programmable controller, and power the programmable controller OFF, then ON or reset the programmable controller CPU.

(2) Setting details

Details of switches 1 to 5 are shown below.

Table 6.6 Intelligent function module switch

Switch No.	Description		Default	Reference
Switch 1	CH1	Mode setting	0000H	This section (2) (a)
Switch 2		Communication speed/transmission setting	0700H	This section (2) (b)
Switch 3	CH2	Mode setting	0000H	This section (2) (a)
Switch 4		Communication speed/transmission setting	0700H	This section (2) (b)
Switch 5	CH1,2 station No. setting		0000H	This section (2) (c)

POINT

1. The settings made with the intelligent function module switches become effective after power is switched OFF and then ON or after the programmable controller CPU is reset.
Setting change during operation is not available.
2. When no intelligent function module switch setting has been made, the initial values of each switch are used for operation.
3. If using the link operation function, set two channels to the same settings.
(Except for MODBUS[®] device assignment parameter starting methods in the transmission speed setting/transmission setting (switch 2, 4).)

Remark

For the operation method of GX Developer, refer to the following manual.

 GX Developer Operating Manual

(a) Mode setting (Switch 1: CH1 side, Switch 3: CH2 side)
Set the operation mode of the QJ71MB91.

Table6.7 Mode setting

Set value ^{*1}		Operation mode		Description
Switch 1	Switch 3	CH1	CH2	
0000H	0000H	Master function	Master function	Master function : Performs communication as master station. Slave function : Performs communication as slave station.
0000H	0001H	Master function	Slave function	
0001H	0000H	Slave function	Master function	
0001H	0001H	Slave function	Slave function	
0002H	0002H	Link operation (Slave function) ^{*2}		Relays data between CH1 and CH2 with the link operation function. (☞ Section 5.3.3)
000DH	000DH	Hardware test		Performs test to check the RAM and ROM of QJ71MB91. (☞ Section 6.4.1)
000EH	000DH	Self-loopback test	-	Performs tests to check the send/receive function of the QJ71MB91 and communications with the programmable controller CPU. (☞ Section 6.4.2)
000DH	000EH	-	Self-loopback test	
000EH	000EH	Self-loopback test	Self-loopback test	

* 1 Setting a value other than indicated in the table results in a switch error.

* 2 For the link operation (slave function), set "0002H" to both Switch 1 and 3.
Setting it to only one switch results in a switch error.

(b) Communication speed/transmission setting (Switch 2: CH1 side, Switch 4: CH2 side)

Set a speed of communication with the target device, and transmission details.

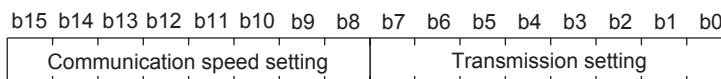

Figure 6.21 Structure of communication speed and transmission settings

1) Transmission setting

Table 6.8 Transmission setting

Bit	Item	OFF (0)	ON (1)	Description	
b0	MODBUS [®] device assignment parameter starting method	Switch 2	Start with the default parameters	Start with the user-set parameters *1	The MODBUS [®] device assignment parameter starting method must be set only for Switch 2 regardless of the channel used. When "Start with the default parameters" is set, the module is started with the parameters assigned by default. (☞ Section 7.3.1 (3)) When "Start with the user-set parameters" is set, the module is started with the MODBUS [®] device assignment parameters set on the sequence program or GX Configurator-MB. (☞ Section 7.3.1 (2)) When setting parameters using the GX Configurator-MB, turn the MODBUS [®] device assignment parameter start method ON.
		Switch 4	Fixed to OFF(0)		-
b1	Data bit *2	8	7	Set data bits.	
b2	Parity bit presence	Present	Not present	Specify whether parity bit is present or not. In the case of "Present", vertical parity check is performed.	
b3	Even/odd parity	Even	Odd	Set even or odd parity. This setting is valid only when "Parity bit presence" is set to "Present".	
b4	Stop bit	1	2	Set the stop bit.	
b5	Frame mode	RTU mode	ASCII mode	Set the frame mode. (☞ Section 4.2.1)	
b6	Online change	Disable	Enable	Set whether to enable or disable data writing to the RUN-status programmable controller CPU by a request message from the master. If this is set to "Disable", when a message requesting the device write is received from the master, the QJ71MB91 returns an error response. This setting is valid only when the slave function is set for the channel.	
b7	Not used	Fixed to OFF(0)		-	

* 1 Set the MODBUS[®] device assignment parameters before sending request messages to the QJ71MB91.

If a request message is sent before the setting, the QJ71MB91 will send a response message (error completion). (The slave function does not operate.)

* 2 Set it to OFF (8 bits) in RTU mode.

1 OVERVIEW
2 SYSTEM CONFIGURATION
3 SPECIFICATIONS
4 MODBUS(R) STANDARD FUNCTIONS
5 FUNCTION
6 PRE-OPERATIONAL PROCEDURES AND SETTINGS
7 PARAMETER SETTING
8 UTILITY PACKAGE (GX Configurator-MB)

2) Communication speed setting ^{*1 *2}

Table6.9 Communication speed setting

Communication speed	Bit position	Communication speed	Bit position
	b15 to b8		b15 to b8
300 bps	00H	14400 bps	06H
600 bps	01H	19200 bps	07H
1200 bps	02H	28800 bps	08H
2400 bps	03H	38400 bps	09H
4800 bps	04H	57600 bps	0AH
9600 bps	05H	115200 bps	0BH

* 1 Total communication speed for 2 channels can be set within 115200bps.

* 2 Do not set any value or set "07H" (Initial value) in the communication speed setting for an unused channel.

(c) CH1, 2 station No. setting (Switch 5)

Set slave station No. of the QJ71MB91.

For the master function, set 00H.

For a slave station number, specify a value within the range shown below.

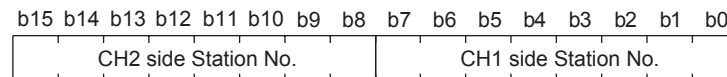

Figure 6.22 CH1, 2 station No. setting structure

Table6.10 Station No. setting

Set value ^{*1}	Description
1H to F7H	Sets a slave station No. (1 to 247).

* 1 Setting a value outside the range shown in the table results in a switch error.

6.7 Maintenance, Inspection

This section explains maintenance, inspection and removal/installation methods for QJ71MB91.

6.7.1 Maintenance, inspection

For the QJ71MB91, except for the following check items, there are no specific inspection items.

For other than shown below, in order to have the system run normally in optimal conditions, perform maintenance as described in the QCPU User's Manual (Hardware Design, Maintenance and Inspection).

(QJ71MB91 inspection items)

- 1) Check that any poor connection is observed at the terminating resistors or connection cables.
- 2) Check that the module fixing screws and the terminal block mounting screws are tightened securely.

POINT

For the QJ71MB91 maintenance and inspection, read the ●safety precautions● provided in the first pages of this manual.

6.7.2 When removing or installing the module

When removing/installing the module, read "6.1 Handling Precautions" and pay full attention to safety to handle the product correctly.
The module replacement procedure is shown below.

< QJ71MB91 replacement operation procedure >

(Procedure 1) Power OFF the station.

(Procedure 2) Disconnect the cable and remove the module.

(Procedure 3) Replace the module and start it according to "6.2 Pre-operational procedures and settings".

<Programmable controller CPU replacement operation procedure >

(Procedure 1) Use the GX Developer to read the PLC parameters from the programmable controller CPU and save them.

(Procedure 2) Replace the programmable controller CPU.

( QCPU User's Manual (Hardware Design, Maintenance and Inspection))

(Procedure 3) Register the PLC parameters saved with the GX Developer to the programmable controller CPU.

CHAPTER 7 PARAMETER SETTING

This chapter explains the setting of the parameters.

7.1 Parameter Settings and Setting Procedure

(1) Parameter types

(a) Automatic communication parameter

Set the automatic communication parameters when using the automatic communication function with the QJ71MB91 operated as a master. (☞ Section 7.2)

Up to 32 automatic communication parameters can be set for each channel. If the automatic communication function is not to be used, setting of these parameters are not required.

(b) MODBUS[®] device assignment parameter

Set the MODBUS[®] device assignment parameters when using the MODBUS device assignment function with the QJ71MB91 operated as a slave. (☞ Section 7.3)

When using the initial values preset to the QJ71MB91, no setting is required for these parameters.

(2) Parameter setting method

Set parameters to the QJ71MB91 by either of the following methods.

(a) Using utility package

Set the parameters from the GX Configurator-MB utility package.

(☞ CHAPTER 8)

(b) Using sequence program

Set the parameters by a sequence program. (☞ Section 9.1 to 9.3)

(3) Parameter setting procedure

Set the parameters by the following procedure.

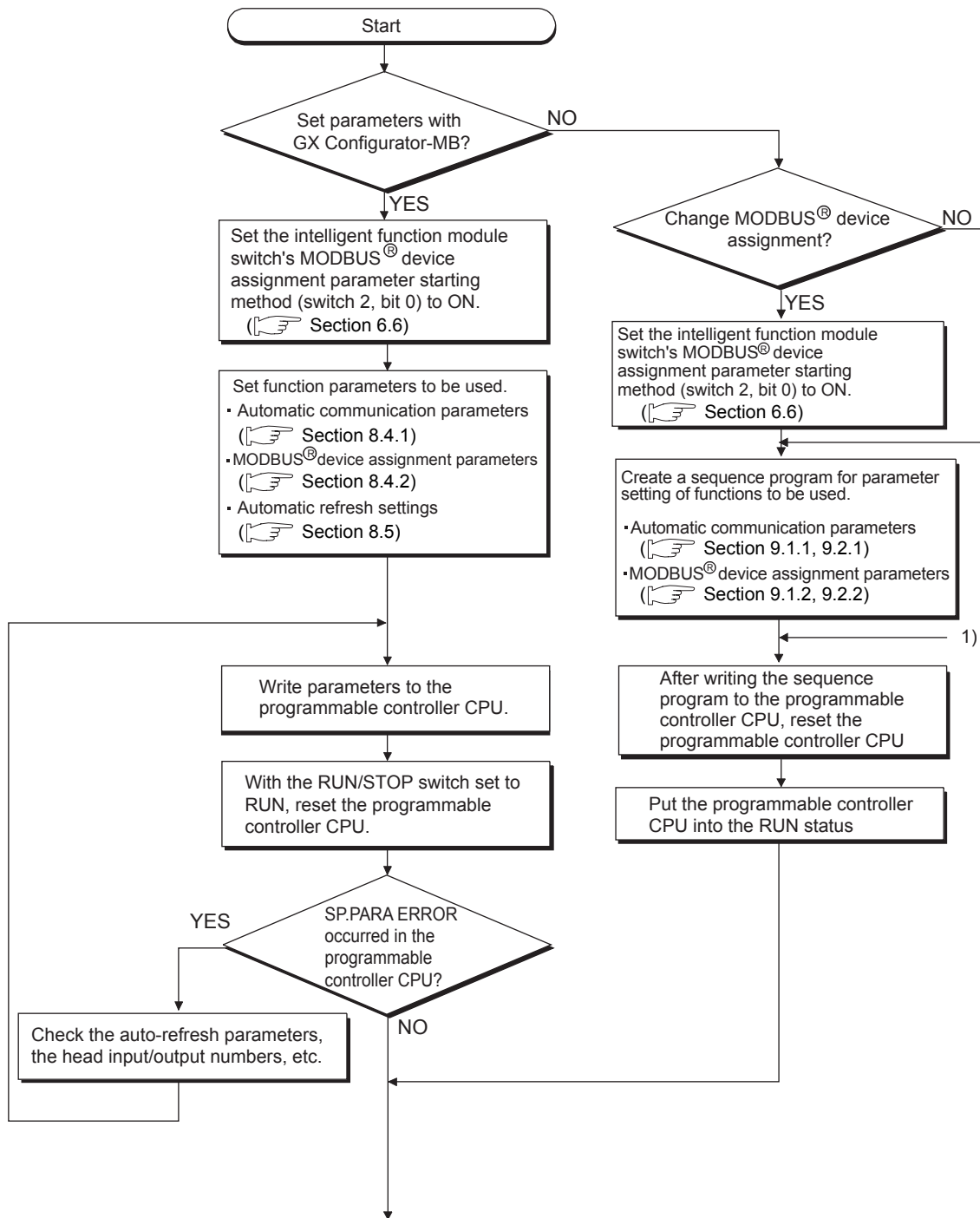

(To next page)

Figure 7.1 Parameter setting procedure

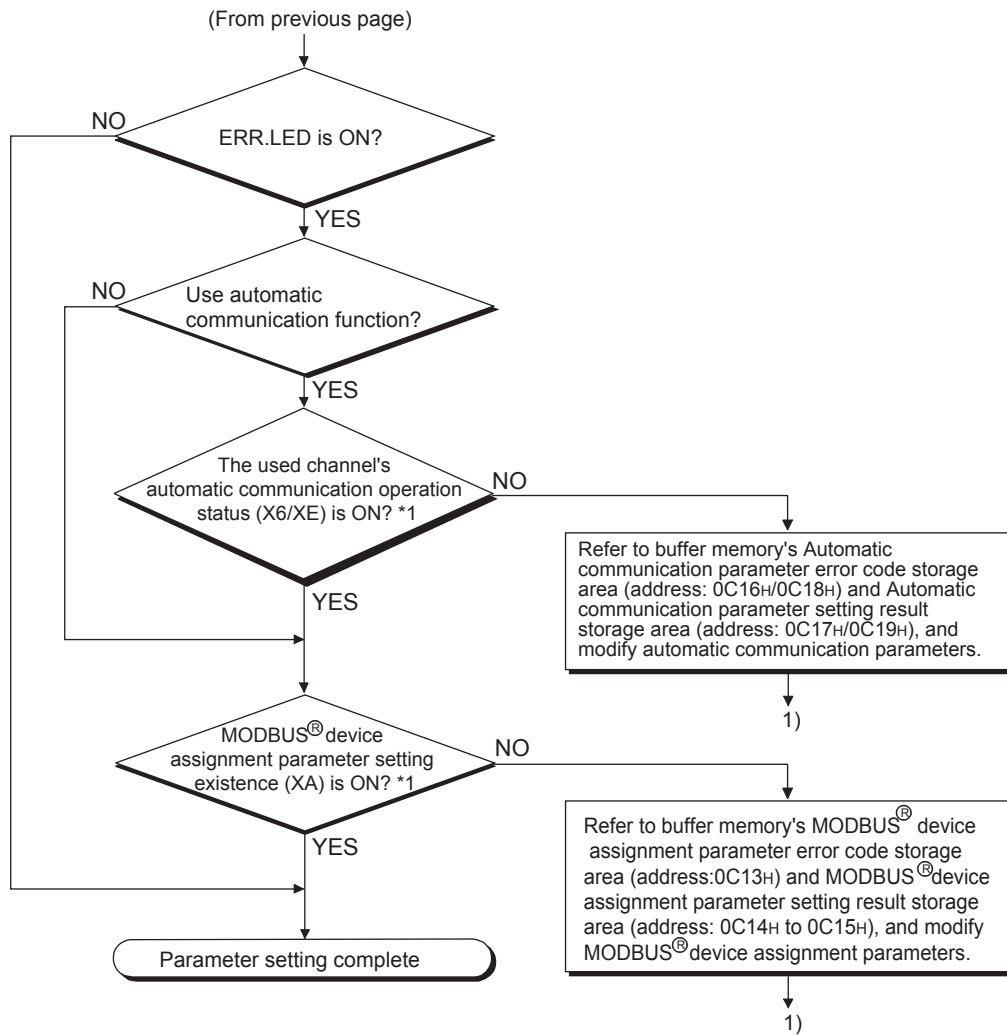

Figure 7.1 Parameter setting procedure (Continued)

* 1 The X signal status can be confirmed on GX Configurator-MB. (☞ Section 8.6.1)

7.2 Automatic Communication Parameter

Set the automatic communication parameters when using the automatic communication function with the QJ71MB91 operated as a master.

(☞ Section 5.2.1)

Up to 32 automatic communication parameters can be set for each channel.

7.2.1 Automatic communication parameter details

Table 7.1 Automatic communication parameter list

Address		Parameter name	Setting range	Default	Reference	
CH1	CH2					
0200 _H to 0201 _H (512 to 513)	0380 _H to 0381 _H (896 to 897)	Automatic communication parameter 1	Setting parameter existence	00000000 _H : Disabled 00000001 _H : Enabled	00000000 _H	This section (1)
0202 _H (514)	0382 _H (898)		Target station No.	0: Broadcast 1 to 247: Slave station No.	1	This section (2)
0203 _H (515)	0383 _H (899)		Request interval timer value	0: Upon reception of a reply message from a slave, immediately issues the next request message. 2 to 65535: The time from when the QJ71MB91 sends a request message until it sends the next request message (Set time = set value × 10 ms)	0	This section (3)
0204 _H (516)	0384 _H (900)		Response monitoring timer value/Broadcast delay value	Response monitoring timer value (Target station No. is 1 to 247) 0 : 30 seconds 2 to 65535: Response monitoring timer (Set time = set value × 10 ms) Broadcast delay value (Target station No. is 0) 0: 400 ms 2 to 65535: Delay time (set time = set value × 10 ms)	0	This section (4)
0205 _H (517)	0385 _H (901)		Type specification of the target MODBUS [®] device	0000 _H : Not specified 0100 _H : Read coils 0200 _H : Read discrete inputs 0400 _H : Read input registers 0500 _H : Read holding registers 0001 _H : Write coils 0005 _H : Write multiple registers 0505 _H : Read/Write multiple registers	0000 _H	This section (5)
0206 _H (518)	0386 _H (902)		Read setting	Head buffer memory address	0000 _H	This section (6)

(Continued on next page)

Table7.1 Automatic communication parameter list (Continued)

Address		Parameter name	Setting range	Default	Reference		
CH1	CH2						
0207 _H (519)	0387 _H (903)	Read Setting	Target MODBUS [®] device head number	0 to 65535	0	This section (7)	
0208 _H (520)	0388 _H (904)		Access points	0 to 2000	0	This section (8)	
0209 _H (521)	0389 _H (905)	Automatic communication Parameter 1	Write setting	Head buffer memory address	0000 _H : None 3000 _H to 3FFF _H : CH1 write data storage area 4000 _H to 4FFF _H : CH2 write data storage area	0000 _H	This section (6)
020A _H (522)	038A _H (906)			Target MODBUS [®] device head number	0 to 65535	0	This section (7)
020B _H (523)	038B _H (907)			Access points	0 to 1968	0	This section (8)
020C _H to 037F _H (524 to 895)	038C _H to 04FF _H (896 to 1279)	Automatic communication Parameter 2 to 32	(Same as in automatic communication parameter 1)				

(1) Setting parameter existence

Set whether to enable or disable the automatic communication parameters.

(2) Target station No.

Specify a slave to which request messages are sent.

The target station No. is entered in the address field of the request message sent to the communication target slave device. (➡ Section 4.2)

(3) Request interval timer value

The Request interval timer represents the interval between any successive request message transmissions in the automatic communication function.

The time from when the QJ71MB91 sends a request message until it sends the next request message is measured.

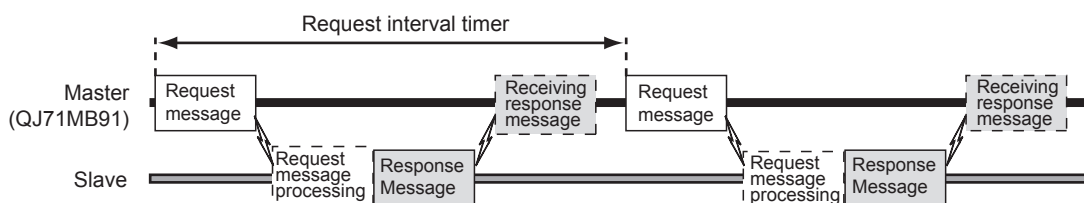

Figure 7.2 Request interval timer

(4) Response monitoring timer value/Broadcast delay value

(a) Response monitoring timer value (Target station No. is 1 to 247)

The Response monitoring timer is used to monitor the time from when the QJ71MB91 sends a response message until it receives a response message from the slave.

If the QJ71MB91 does not receive any response message from the slave before the Response monitoring timer times out, it is recognized that the target slave is faulty.

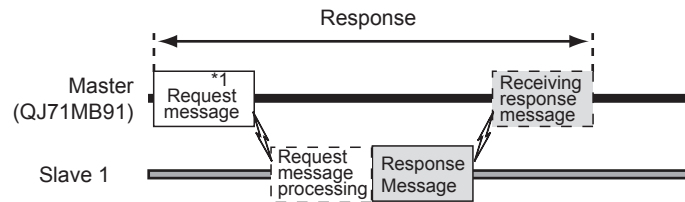

*1 When request message is addressed to any of station No.1 to 247

Figure 7.3 Response monitoring timer

The following areas can be checked to see if the Response monitoring timer has timed out.

- 1) Relevant automatic communication operation status storage area in the buffer memory (address: 0C20H to 0C21H/0C22H to 0C23H) turns ON.
- 2) An error code is stored in the automatic communication error code storage area in the buffer memory (address: 0C28H to 0C47H/0C48H to 0C67H).
(☞ Section 11.4.1)

☒ POINT

1. The Response monitoring timer value should be smaller than the Request interval timer value.
If the Response monitoring timer value is larger than the Request interval timer value, a request interval timer timeout error (error code: 737BH) will occur.
Set an adequate response monitoring timer value, taking the processing time of the target slave device into account.
2. While the Response monitoring timer is on, request messages cannot be sent with the MBRW or MBREQ instruction.
When the automatic communication function and the MBRW or MBREQ instruction are used on the same channel, set appropriate automatic communication parameters and create a proper sequence program so that the MBRW or MBREQ instruction can be executed in the right timing. (☞ Section 9.2.3)

(b) Broadcast delay value (Target station No. is 0)

The Broadcast delay monitors the time interval between transmissions when request messages are broadcast.

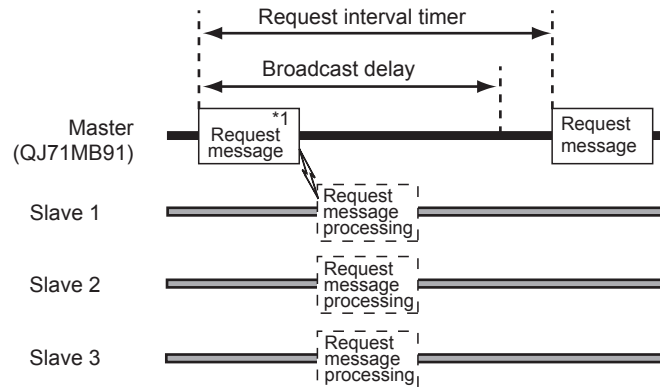

*1 When request message is addressed to station No.0 (broadcast)

Figure 7.4 Broadcast delay

POINT

1. Since requests are broadcast to all slave devices, an adequate broadcast delay value must be set in consideration of each processing time of all slave devices.
If the broadcast delay value is not enough for any of the slave devices, the next request to the slave device may result in an error.
2. The Broadcast delay value should be smaller than the Request interval timer value.
If the Broadcast delay value is greater than the Request interval timer value, request messages will be sent during at the intervals of the Request interval timer.
3. While the Broadcast delay is on, request messages cannot be sent with the MBRW and MBREQ instruction.
When the automatic communication function and the MBRW or MBREQ instruction are used on the same channel, set appropriate automatic communication parameters and create a proper sequence program so that the MBRW or MBREQ instruction can be executed in the right timing. (☞ Section 9.2.3)

(5) Type specification of the target MODBUS® device

Specify the types of the read/write target MODBUS® devices.

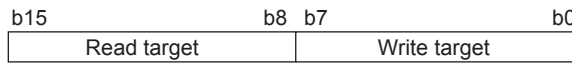

Figure 7.5 Structure for Type specification of the target MODBUS® device

Table 7.2 Type specification of the target MODBUS® device

Setting value	Target MODBUS® device type
00H	No specification
01H	Coil
02H	Input
04H	Input register
05H	Holding register

(a) Setting range

Available combinations of the read and write targets are as shown in the table below.

No other combinations are available.

Table 7.3 Setting range for Type specification of the target MODBUS® device

Type specification of the target MODBUS® device			Function code	
Setting value	Read target	Write target		
0100H	Coil	No specification *1	01	Read coils
0200H	Input		02	Read discrete inputs
0400H	Input register		04	Read input registers
0500H	Holding register		03	Read holding registers
0001H	No specification *1	Coil *3	15	Write multiple coils
0005H		Holding register *3	16	Write multiple registers
0505H	Holding register *2	Holding register	23	Read/write multiple registers

* 1 To perform only read or write, set "0" to each of the following:

- Head buffer memory address (☞ This section (6))
- Target MODBUS® device head number (☞ This section (7))
- Access points (☞ This section (8))

* 2 Reading and writing can be performed simultaneously with one instruction only when 0505H (Read/write multiple registers) is set.

* 3 Broadcast can be performed with 0001H (Write multiple coils) and 0005H (Write multiple registers) only.

(6) Head buffer memory address (Read/Write setting)

Specify the head address of the buffer memory where the data read from or written to the slave are stored.

The head buffer memory addresses should not duplicated among Automatic communication parameters 1 to 32.

(7) Target MODBUS[®] device head number (Read/Write setting)

Specify the head number of the read or write target MODBUS[®] device.

(a) Specifying the head number

As the target MODBUS[®] device head number, set "(Last 5 digits of actual device number) - 1".

Example: Set "17" for the holding register, 400018.

(b) When specifying a value of 32768 (8000H) or more in a sequence program

When specifying a value of 32768 (8000H) or more in a sequence program, set the value in hexadecimal.

(8) Access points (Read/Write setting)

Set the number of points to be written to the MODBUS[®] device and to be read from the MODBUS[®] device.

The access points vary depending on the type specification of the target MODBUS[®] device.

Table7.4 Access points

Type specification of the target MODBUS [®] device			Access points setting range	
Setting value	Read target	Write target	Read points	Write points
0100H	Coil	No specification	1 to 2000 points	-
0200H	Input		1 to 2000 points	-
0400H	Input register		1 to 125 points	-
0500H	Holding register		1 to 125 points	-
0001H	No specification	Coil	-	1 to 1968 points
0005H		Holding register	-	1 to 123 points
0505H	Holding register	Holding register	1 to 125 points	1 to 121 points

POINT

In the access to a bit device (coil/input) of a slave, the fraction bits are handled as described below.

- Bit device read

Automatic communication parameter: Read setting			
Target MODBUS® device type setting	Head buffer memory address	Target MODBUS® device head number	Access points
0200H (input)	1000H (4096)	16628	35

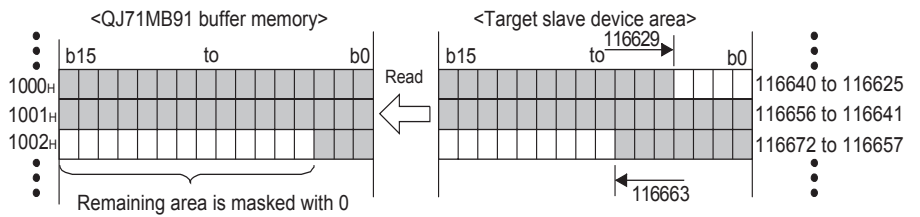

- Bit device write

Automatic communication parameter: Write setting			
Target MODBUS® Device type setting	Head buffer Memory address	Target MODBUS® device head number	Access points
0001H (coil)	3000H (12288)	1305	5

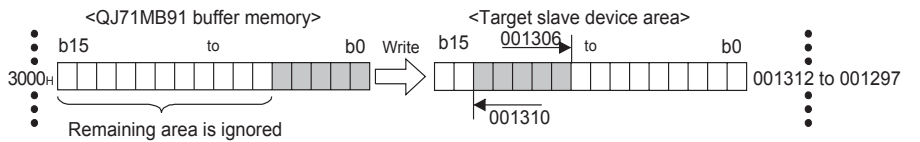

7.3 MODBUS(R) Device Assignment Parameter

Using MODBUS® device assignment parameters, the MODBUS® devices are correlated with the programmable controller CPU device memory.

This allows direct access from the MODBUS® compatible master device to the programmable controller CPU device memory.

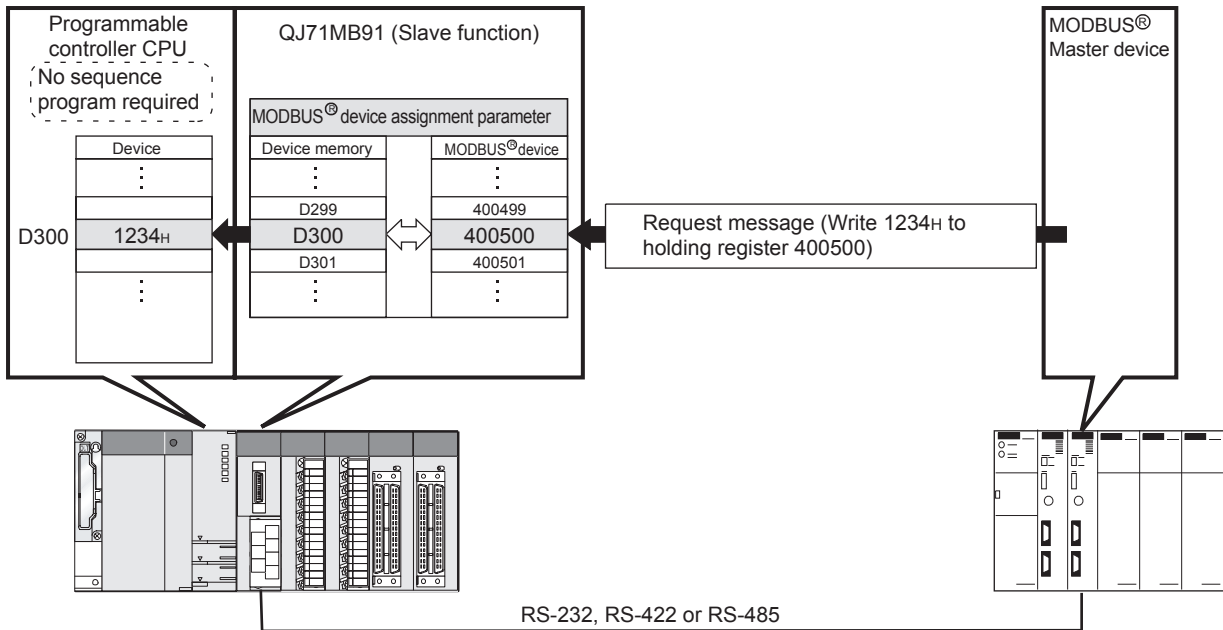

Figure 7.6 MODBUS® device and programmable controller CPU device

[Schematic diagram of MODBUS® device assignment parameter setting]

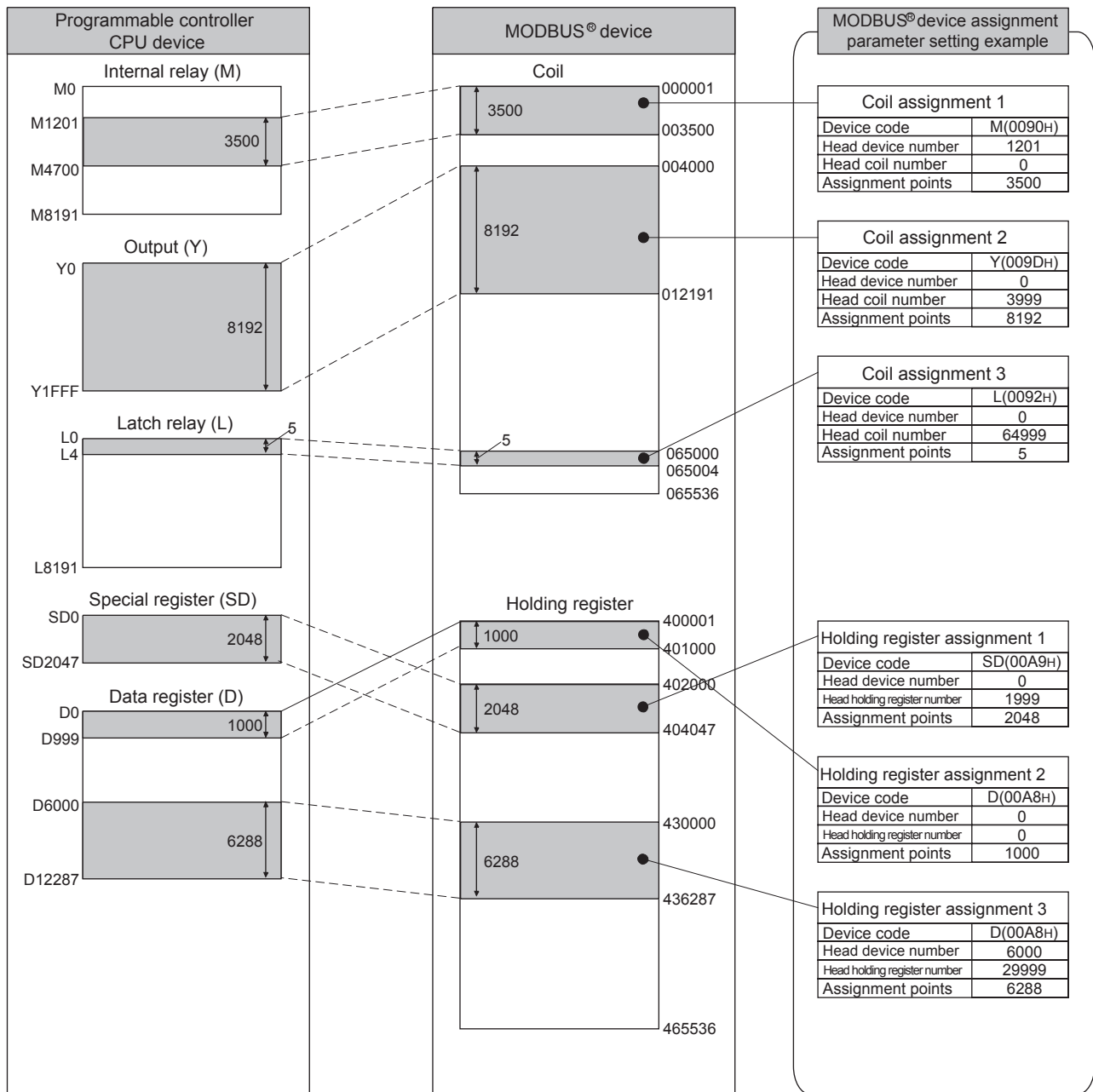

Figure 7.7 MODBUS® device assignment parameter setting diagram

7.3.1 MODBUS(R) device assignment to the programmable controller CPU device memory

(1) MODBUS® device size

The MODBUS® devices available for the QJ71MB91 are shown below.

Table 7.5 MODBUS® device size

MODBUS® device type	Read/Write	Access points	MODBUS® device number
Coil	Read/Write	65536 points	000001 to 065536
Input	Read	65536 points	100001 to 165536
Input register	Read	65536 points	300001 to 365536
Holding register	Read/Write	65536 points	400001 to 465536
Extended file register	(*1)	4184064 points *2	File No.: 0 to 418 *2 600000 to 609999

* 1 The availability of Extended file register read/write depends on that of the file register (ZR) read/write to the programmable controller CPU.
For example, if the file register (ZR) is stored on a Flash card, the extended file register is read only because the file register (ZR) is read only.

User's Manual (Function Explanation, Program Fundamentals) for the CPU module used

* 2 The maximum access points and maximum file number of the extended file register depend on the file register (ZR) assignment size of the programmable controller CPU.

User's Manual (Function Explanation, Program Fundamentals) for the CPU module used

Remark

Refer to the following for assignment of the extended file register and the programmable controller CPU file register (ZR).

Section 7.3.2

(2) Setting details

(a) Before performing setting

With the intelligent function module switch, turn ON the MODBUS® device assignment parameter starting method (switch 2, bit 0). (☞ Section 6.6)
If this switch is set to OFF, the operation will proceed based on the default assignment parameters.

(☞ This section (3))

(b) Setting parameter list

Table 7.6 MODBUS® device assignment parameter list

Address	Parameter name		Setting range	Default	Reference
0900H (2304)	Coil	Coil assignment 1	Device code	0000H: Device code not assigned Other than 0000H: Device code	0000H
0901H (2305)			Head device number	0000H to FFFFH	
0902H (2306)			Head coil number	0000H to FFFFH	
0903H (2307)			Assignment points	0000H to FFFFH	
0904H to 093FH (2308 to 2367)		Coil assignment 2 to 16	(Same as in Coil assignment 1)		
0940H (2368)	Input	Input assignment 1	Device code	0000H: Device code not assigned Other than 0000H: Device code	0000H
0941H (2369)			Head device number	0000H to FFFFH	
0942H (2370)			Head input number	0000H to FFFFH	
0943H (2371)			Assignment points	0000H to FFFFH	
0944H to 097FH (2372 to 2431)		Input assignment 2 to 16	(Same as Input assignment 1)		

This section
(2) (b) 1) to 4)

(Continued on next page)

1	OVERVIEW
2	SYSTEM CONFIGURATION
3	SPECIFICATIONS
4	MODBUS(R) STANDARD FUNCTIONS
5	FUNCTION
6	PRE-OPERATIONAL PROCEDURES AND SETTINGS
7	PARAMETER SETTING
8	UTILITY PACKAGE (GX Configurator-MB)

Table 7.6 MODBUS[®] device association parameter list (continued)

Address	Parameter name		Setting range	Default	Reference	
0980 _H (2432)	Input register	Input register assignment 1	Device code	0000 _H : Device code not assigned Other than 0000 _H : Device code	0000 _H	This section (2) (b) 1) to 4)
0981 _H (2433)			Head device number	0000 _H to FFFF _H		
0982 _H (2434)			Head input register number	0000 _H to FFFF _H		
0983 _H (2435)			Assignment points	0000 _H to FFFF _H		
0984 _H to 09BF _H (2436 to 2495)		Input register assignment 2 to 16	(Same as in Input register assignment 1)			
09C0 _H (2496)	Holding register	Holding register assignment 1	Device code	0000 _H : Device code not assigned Other than 0000 _H : Device code	0000 _H	
09C1 _H (2497)			Head device number	0000 _H to FFFF _H		
09C2 _H (2498)			Head holding register number	0000 _H to FFFF _H		
09C3 _H (2499)			Assignment points	0000 _H to FFFF _H		
09C4 _H to 09FF _H (2500 to 2559)		Holding register assignment 2 to 16	(Same as in Holding register assignment 1)			

1) Device code

Set programmable controller CPU devices and QJ71MB91 buffer memory to be assigned to the MODBUS® devices.

The device codes have different setting abilities depending on the MODBUS® devices.

Refer to the following table for the device code setting availabilities.

Table 7.7 Device code list

Classification	Device name	Device symbol	Device code *5	MODBUS® device					
				Coil	Input	Input Register	Holding Register	Extension File Register	
Internal system device	Special relay	SM *3	0091H	○	○				
	Special register	SD *3	00A9H			○	○		
Internal user device	Input	X *3	009CH	○	○				
	Output	Y *3	009DH	○	○				
	Internal relay	M *3	0090H	○	○				
	Latch relay	L	0092H	○	○				
	Annunciator	F	0093H	○	○				
	Edge relay	V	0094H	○	○				
	Link relay	B *3*4	00A0H	○	○				
	Data register	D *3*6	00A8H			○	○		
	Link register	W *3*4*6	00B4H			○	○		
	Timer	Coil	TC	00C0H	○	○			
		Contact	TS	00C1H	○	○			
		Current value	TN	00C2H			○	○	
	Retentive timer	Coil	SC	00C6H	○	○			
Contact		SS	00C7H	○	○				
Current value		SN	00C8H			○	○		

(Continued on next page)

Table 7.7 Device code list (Continued)

Classification	Device name		Device symbol	Device Code ^{*5}	MODBUS [®] Device				
					Coil	Input	Input Register	Holding Register	Extension File Register
Internal user device	Counter	Coil	CC	00C3H	○	○			
		Contact	CS	00C4H	○	○			
		Current value	CN	00C5H			○	○	
	Special link relay		SB ^{*3}	00A1H	○	○			
	Special link register		SW ^{*3}	00B5H			○	○	
	Step relay		S	0098H	○	○			
Direct device	Direct input		DX	00A2H	○	○			
	Direct output		DY	00A3H	○	○			
Index register	Index register		Z	00CC _H			○	○	
File register	File register		R	00AF _H			○	○	
			ZR ^{*1}	00B0 _H					○
QJ71MB91 buffer memory ^{*2*3}	User free area		-	F000 _H			○	○	

* 1 The assignment to the extended file register is fixed to the file register (ZR).

(Section 7.3.2)

* 2 Refer to the following for the assignment to the QJ71MB91 buffer memory.

(Section 7.3.3)

* 3 When the access target is the MELSECNET/H remote I/O station to which the QJ71MB91 is mounted, only this device is supported.

An error will occur if an access request is received from the master with any other device

assigned. (Section 7.3.5)

* 4 Equivalent to LB and LW of the MELSECNET/H remote I/O stations.

* 5 When setting with GX Configurator-MB, input the head device.

* 6 The extended data register D65536 and higher area and extended link register W10000 and higher area cannot be allocated as input register or holding register.

Use file register (ZR) specification instead.

For file register (ZR) specification of extended data register or extended link register, refer to the following manual.

(User's Manual (Function Explanation, Program Fundamentals) for the CPU module used

Use Read file record (FC: 20) or Write file record (FC: 21) in the above case.

- 2) Head device number
Set the head device number of the programmable controller CPU device memory or the head address of the QJ71MB91 buffer memory to be assigned to the MODBUS[®] device.
- 3) Head MODBUS[®] device number (Head coil number/Head input number/Head input register number/Head holding register number)
As the head MODBUS[®] device number, set the head number of the MODBUS[®] device of the assignment target (QJ71MB91).

Use the following expression to find a setting value of the head MODBUS[®] device number:
Head MODBUS[®] device number = Last 5 digits of relevant MODBUS[®] device number - 1
Example: Set "5139" for the MODBUS[®] device number, 105140.

The head MODBUS[®] device number must not be duplicated among Assignment 1 to 16.
Set unique head MODBUS[®] device numbers.
The slave function of the QJ71MB91 does not run if any of the device number settings are duplicated.
- 4) Assignment points
Set the device points of the programmable controller CPU device memory or QJ71MB91 buffer memory to be assigned to the MODBUS[®] device.

POINT

If the master requests the QJ71MB91 to access the area outside the valid programmable controller CPU device range or the user free area in the QJ71MB91 buffer memory, the QJ71MB91 will send an exception response to the master.

(3) Default assignment parameters

For assignment between the MODBUS[®] devices and programmable controller CPU devices, default assignment parameters are provided as initial values.

(a) Before using default assignment parameters

With the intelligent function module switch, turn OFF the MODBUS[®] device assignment parameter starting method (switch 2, bit 0). (See Section 6.6)

If this switch is set to ON, the operation will proceed based on the set assignment parameters. (See This section (2))

(b) MODBUS[®] device assignment by default assignment parameters

The following shows how the MODBUS[®] devices are assigned by the MODBUS[®] device assignment parameters and the default values set to the QJ71MB91 buffer memory.

MODBUS[®] device assignment by default assignment parameters

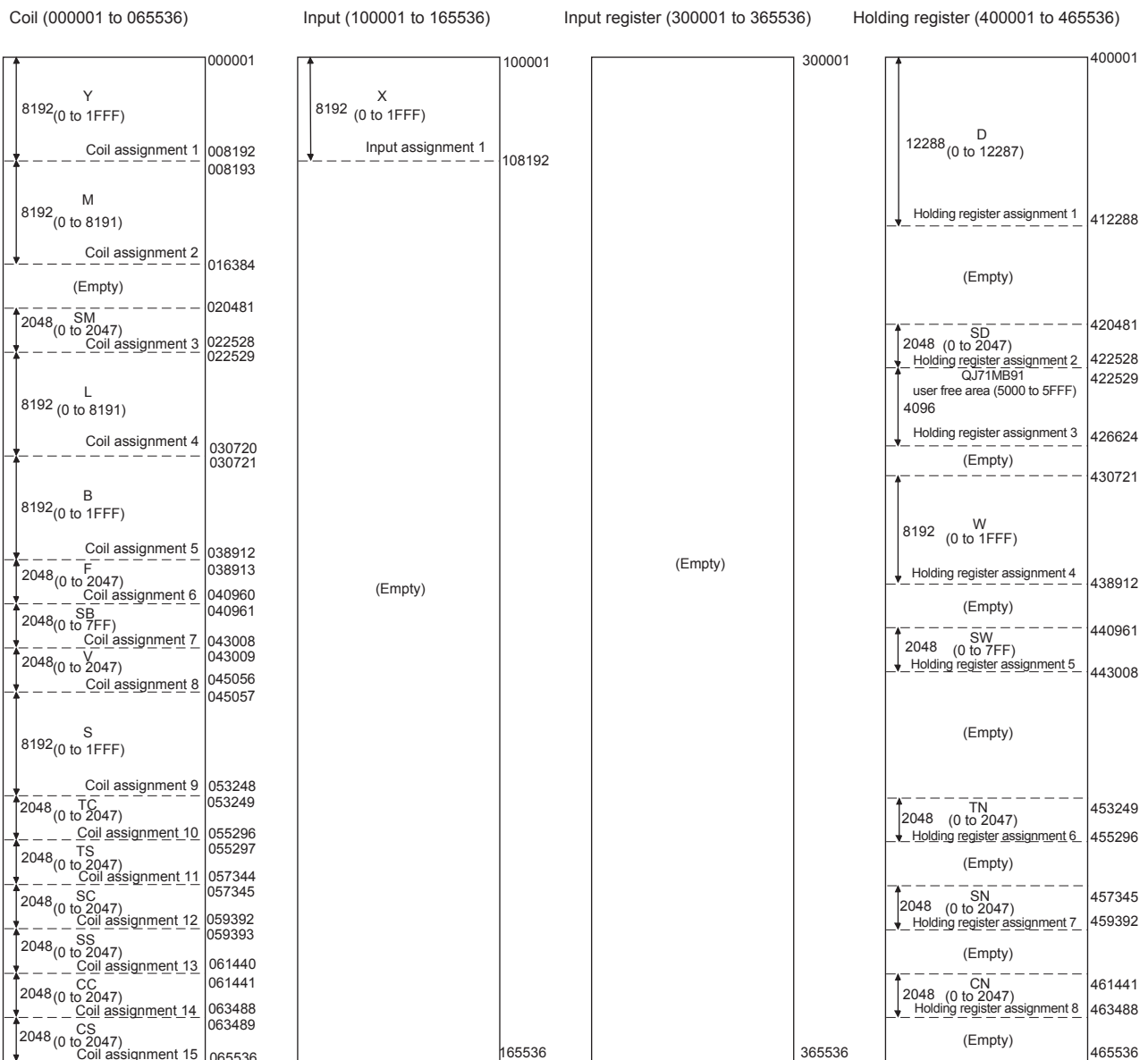

Figure 7.8 Default assignment parameters

(c) Setting values for default assignment parameters

Table 7.8 Setting values for default assignment parameters

Name	Buffer memory address	Default assignment parameter setting items			
		Device code (Device symbol)	Head Device numbers	Head MODBUS [®] device number ^{*1}	Assignment points
Coil assignment 1	0900H to 0903H (2304 to 2307)	009DH (Y)	0000H	0	8192
Coil assignment 2	0904H to 0907H (2305 to 2311)	0090H (M)	0000H	8192	8192
Coil assignment 3	0908H to 090BH (2312 to 2315)	0091H (SM)	0000H	20480	2048
Coil assignment 4	090CH to 090FH (2316 to 2319)	0092H (L)	0000H	22528	8192
Coil assignment 5	0910H to 0913H (2320 to 2323)	00A0H (B)	0000H	30720	8192
Coil assignment 6	0914H to 0917H (2324 to 2327)	0093H (F)	0000H	38912	2048
Coil assignment 7	0918H to 091BH (2328 to 2331)	00A1H (SB)	0000H	40960	2048
Coil assignment 8	091CH to 091FH (2332 to 2335)	0094H (V)	0000H	43008	2048
Coil assignment 9	0920H to 0923H (2336 to 2339)	0098H (S)	0000H	45056	8192
Coil assignment 10	0924H to 0927H (2340 to 2343)	00C0H (TC)	0000H	53248	2048
Coil assignment 11	0928H to 092BH (2344 to 2347)	00C1H (TS)	0000H	55296	2048
Coil assignment 12	092CH to 092FH (2348 to 2351)	00C6H (SC)	0000H	57344	2048
Coil assignment 13	0930H to 0933H (2352 to 2355)	00C7H (SS)	0000H	59392	2048
Coil assignment 14	0934H to 0937H (2356 to 2359)	00C3H (CC)	0000H	61440	2048
Coil assignment 15	0938H to 093BH (2360 to 2363)	00C4H (CS)	0000H	63488	2048
Coil assignment 16	093CH to 093FH (2364 to 2367)	0000H -	0000H	0	0

* 1 Use the following expression to find a setting value of the head MODBUS[®] device number:
 Head MODBUS[®] device number = Last 5 digits of relevant MODBUS[®] device number - 1

(Continued on next page)

1 OVERVIEW

2 SYSTEM CONFIGURATION

3 SPECIFICATIONS

4 MODBUS(R) STANDARD FUNCTIONS

5 FUNCTION

6 PRE-OPERATIONAL PROCEDURES AND SETTINGS

7 PARAMETER SETTING

8 UTILITY PACKAGE (GX Configurator-MB)

Table7.8 Setting values for default assignment parameters (Continued)

Name	Buffer memory Address	Default Assignment Parameter Setting Items			
		Device code (Device symbol)	Head Device numbers	Head MODBUS [®] device number ^{*1}	Assignment points
Input assignment 1	0940H to 0943H (2368 to 2371)	009CH (X)	0000H	0	8192
Input assignment 2 to 16	0944H to 097FH (2372 to 2431)	0000H -	0000H	0	0
Input register assignment 1 to 16	0980H to 09BFH (2432 to 2495)	0000H -	0000H	0	0
Holding register assignment 1	09C0H to 09C3H (2496 to 2499)	00A8H (D)	0000H	0	12288
Holding register assignment 2	09C4H to 09C7H (2500 to 2503)	00A9H (SD)	0000H	20480	2048
Holding register assignment 3	09C8H to 09CBH (2504 to 2507)	F000H -	5000H	22528	4096
Holding register assignment 4	09CCH to 09CFH (2508 to 2511)	00B4H (W)	0000H	30720	8192
Holding register assignment 5	09D0H to 09D3H (2512 to 2515)	00B5H (SW)	0000H	40960	2048
Holding register assignment 6	09D4H to 09D7H (2516 to 2519)	00C2H (TN)	0000H	53248	2048
Holding register assignment 7	09D8H to 09DBH (2520 to 2523)	00C8H (SN)	0000H	57344	2048
Holding register assignment 8	09DCH to 09DFH (2524 to 2527)	00C5H (CN)	0000H	61440	2048
Holding register assignment 9 to 16	09E0H to 09FFH (2528 to 2559)	0000H -	0000H	0	0

* 1 Use the following expression to find a setting value of the head MODBUS[®] device number:
 Head MODBUS[®] device number = Last 5 digits of relevant MODBUS[®] device number - 1

☒ POINT

The programmable controller CPU device range varies depending on the programmable controller CPU.

☞ User's Manual (Function Explanation, Program Fundamentals) for the CPU module used

Depending on the programmable controller CPU, some of the default assignment parameter range may not be usable.

In such a case, observe either of the following not to access the devices outside the allowable range.

- Set the MODBUS® device assignment parameters. (☞ This section (2))
Make the setting within the allowable programmable controller CPU device range.
- Do not access any device outside the allowable range when using the default assignment parameters.

7.3.2 MODBUS(R) extended file register assignment to the programmable controller CPU file register

The MODBUS® extended file register assignment to the programmable controller CPU is fixed to the file register (ZR).
It is assigned to the file register (ZR) of the programmable controller CPU as shown below.

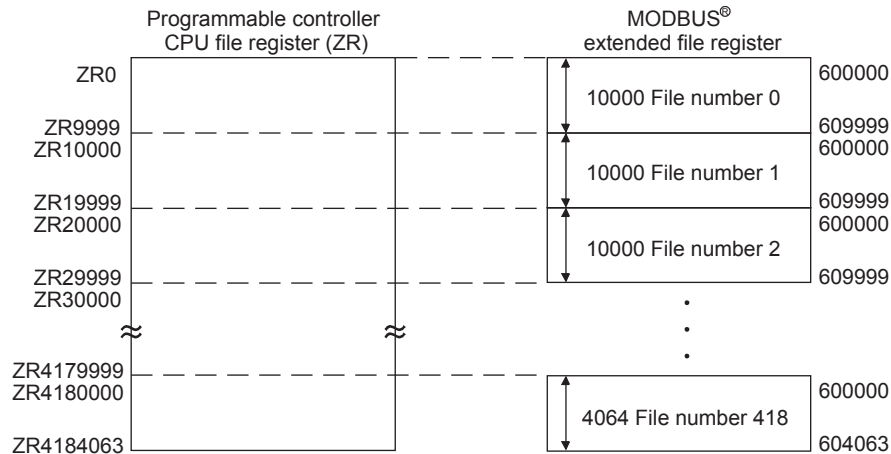

Figure 7.9 Extended file register assignment

(1) Out-of-range read/write request

The QJ71MB91 sends an exception response if the master requests it to read from or write to a nonexistent file register (ZR) of the programmable controller CPU on the station where the QJ71MB91 is mounted.

(2) MODBUS® extended file register size

The MODBUS® extended file register size is dependant on the file register (ZR) size set to the programmable controller CPU on the QJ71MB91-mounted station.

POINT

Even if the slave (QJ71MB91) receives Write File Record (FC:21) when the programmable controller CPU's file register (ZR) is read-only (for example, when stored on a Flash card), it will issue a normal response.

In this case, however, the action for Write File Record is not performed.

To write to the extended file register, check that the programmable controller CPU's file register (ZR) is writable or not in advance.

Remark

For the programmable controller CPU's file register (ZR), refer to the following manual:

User's Manual (Function Explanation, Program Fundamentals) for the CPU module used

7.3.3 QJ71MB91 buffer memory assignment

The QJ71MB91 can assign the MODBUS® devices to the QJ71MB91 buffer memory. By this assignment of the QJ71MB91 buffer memory to the MODBUS device, access to the MODBUS® devices will not be affected by sequence scans. This allows the QJ71MB91 to respond faster to the master.

(1) To assign the QJ71MB91 buffer memory to the MODBUS® device

- (a) When using the MODBUS® device assignment parameter
When setting the MODBUS® device assignment parameter, set F000_H for the device code. (☞ Section 7.3.1 (2))
- (b) When using the default assignment parameter
Use any of the MODBUS® device, 422529 to 426624.
(☞ Section 7.3.1 (3))

(2) Assignment range of MODBUS® devices

The following QJ71MB91 buffer memory addresses can be assigned to the MODBUS® devices.

Table 7.9 Usable buffer memory

Buffer memory Address	Size	Name	Automatic refresh
5000 _H to 5FFF _H (20480 to 24575)	4096	User free area	Setting allowed

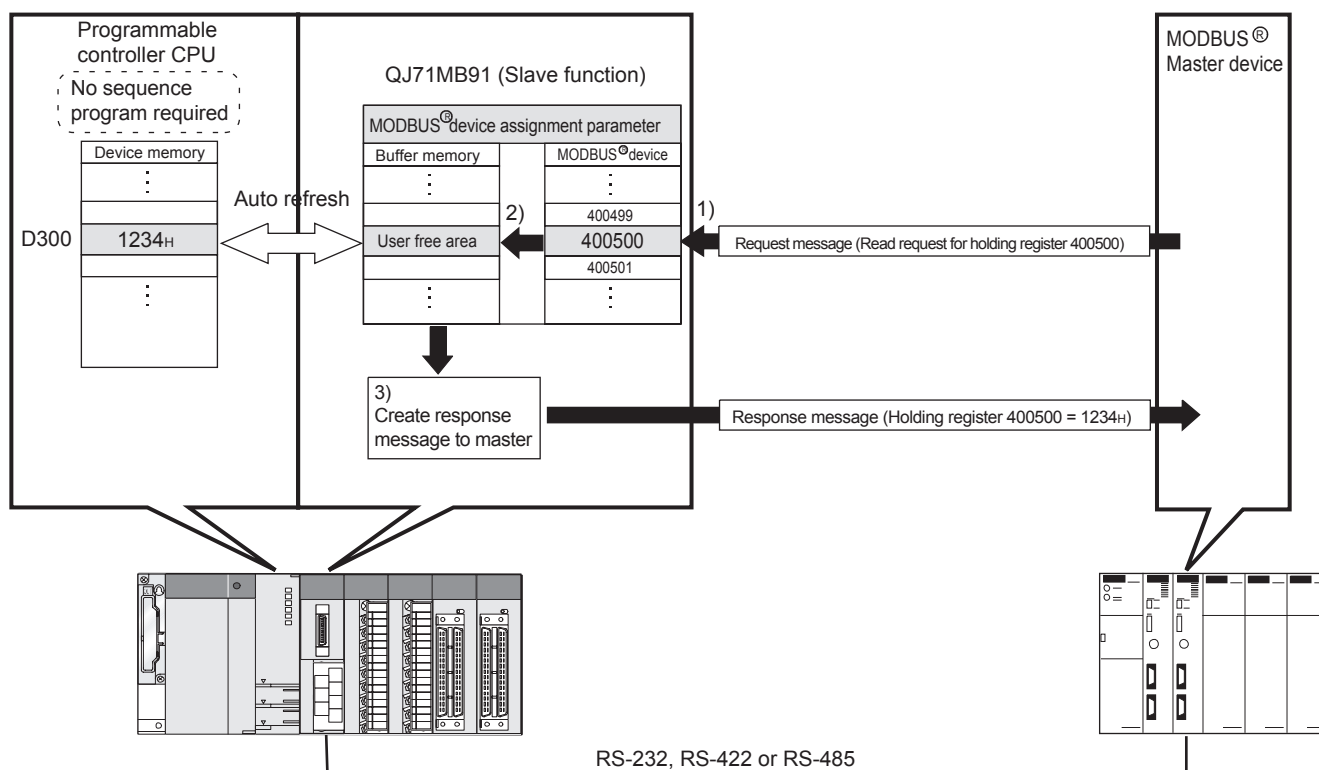

Figure 7.10 MODBUS® device and buffer memory

- 1) The QJ71MB91 receives a "Read holding register 400500" request message from the master.
- 2) The QJ71MB91 reads the data from its own buffer memory according to the value set to the MODBUS® device assignment parameter.
At this time, faster processing is executed since access is not affected by any sequence scan.
- 3) The QJ71MB91 creates a response message and sends it to the master.

POINT

The programmable controller CPU device memory value can be stored in the QJ71MB91 buffer memory, and the QJ71MB91 buffer memory value can be stored in the programmable controller CPU device memory.

Data can be stored by either of the following:

- Automatic refresh setting on GX Configurator-MB (☞ Section 8.5)
- Transfer using intelligent function module devices (Un\G□)
☞ User's Manual (Function Explanation, Program Fundamentals) for the CPU module used

7.3.4 Specifying the error status read device

Users can specify the data to be read out as an exception status when the QJ71MB91 (slave) receives Read Exception Status (FC:07) from the master.

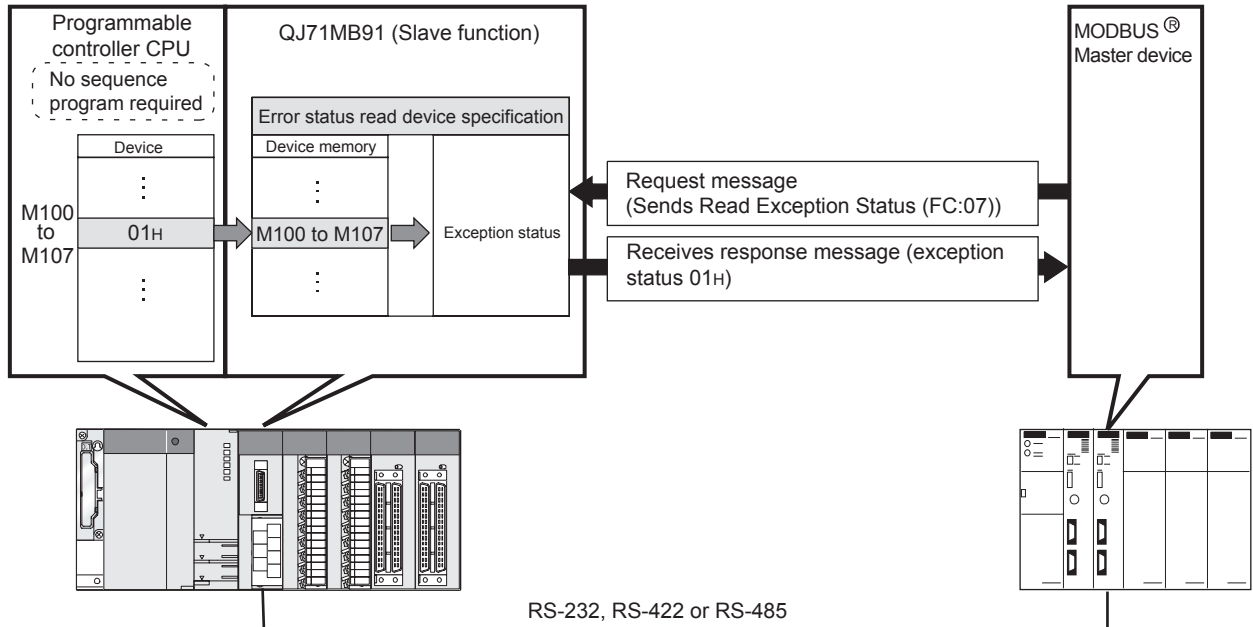

Figure 7.11 Relations between error status and error status read device

(1) To specify the error status read device

Specify a read target device to the addresses shown below.

The 8 points from the specified bit device is regarded as a error status read device.

Table 7.10 Error status read device specification

Address	Parameter name	Setting range	Default
000AH (10)	Error status read device specification	Device code	0000H : Device code not assigned Other than 0000H: Device code
000BH (11)		Head device number	0000H to FFFFH

(a) Device code

Set programmable controller CPU devices and QJ71MB91 buffer memory to be assigned to the MODBUS® devices.

The device codes usable for the error status read devices are indicated below.

Table7.11 Device codes usable for error status read devices

Classification	Device name	Device symbol	Device code *3	
Internal system device	Special relay	SM *1	0091H	
Internal user device	Input	X *1	009CH	
	Output	Y*1	009DH	
	Internal relay	M*1	0090H	
	Latch relay	L	0092H	
	Annunciator	F	0093H	
	Edge relay	V	0094H	
	Link relay	B*1*2	00A0H	
	Timer	Coil	TC	00C0H
		Contact	TS	00C1H
	Retentive timer	Coil	SC	00C6H
		Contact	SS	00C7H
	Counter	Coil	CC	00C3H
		Contact	CS	00C4H
	Special link relay		SB*1	00A1H
Step relay		S	0098H	
Direct device	Direct input	DX	00A2H	
	Direct output	DY	00A3H	
QJ71MB91 buffer memory	Error status read buffer memory (address: 000FH)	-	F00H	

* 1 When the access target is the MELSECNET/H remote I/O station to which the QJ71MB91 is mounted, only this device is supported.
When a device other than the above is assigned, and if Read Exception Status (FC: 07) is sent from the master, an error will be generated. (☞ Section 7.3.5)

* 2 Equivalent to LB of the MELSECNET/H remote I/O stations.

* 3 When setting with GX Configurator-MB, input the head device.

(b) Head device number

Specify the head device number of the programmable controller CPU device memory to be assigned to the MODBUS® device.

The upper limit of the setting is the number resulted from "each device's upper limit minus 8 points".

☒ POINT

If F000H (buffer memory) is specified for the device code, the error status read buffer memory (address: 000FH) will be the error status read target. (No other buffer memory can be set.)

In this case, make the setting as indicated below.

- Set "0000H" to the head device number (address: 000BH).
- Store the error status data in the error status read buffer memory (address: 000FH).

7.3.5 Specifying access target when mounted to MELSECNET/H remote I/O station

For the case where the QJ71MB91 is mounted to a MELSECNET/H remote I/O station, the access target can be specified.

(1) To change the access target

Set the access target as shown below.

Table7.12 Access target when mounted to MELSECNET/H remote I/O station

Address	Parameter name	Setting range	Default
000E _H (14)	Access target (when mounted to MELSECNET/H remote I/O station)	0000 _H : Remote I/O station 0001 _H : Remote master station	0000 _H

- (a) When the access target is a remote I/O station ("0000_H" is set.)
When the QJ71MB91 receives a request message from the master, the MELSECNET/H remote I/O station device is accessed.
- (b) When the access target is a remote master station ("0001_H" is set.)
When the QJ71MB91 receives a request message from the master, a control CPU device of the MELSECNET/H remote master station is accessed.
If the QJ71MB91 is not mounted on the MELSECNET/H remote I/O station, do not make this setting. (An error will occur.)

7.3.6 Specifying the CPU response monitoring timer

When the QJ71MB91 receives a request message from the master and the programmable controller CPU starts its processing, the QJ71MB91 waits for the response from the programmable controller CPU. The time allowed for the QJ71MB91 to wait is set by the CPU response monitoring timer value.

This timer allows the QJ71MB91 to cancel the wait status on the master side when a response to the master is not available due to an error occurred in the programmable controller CPU.

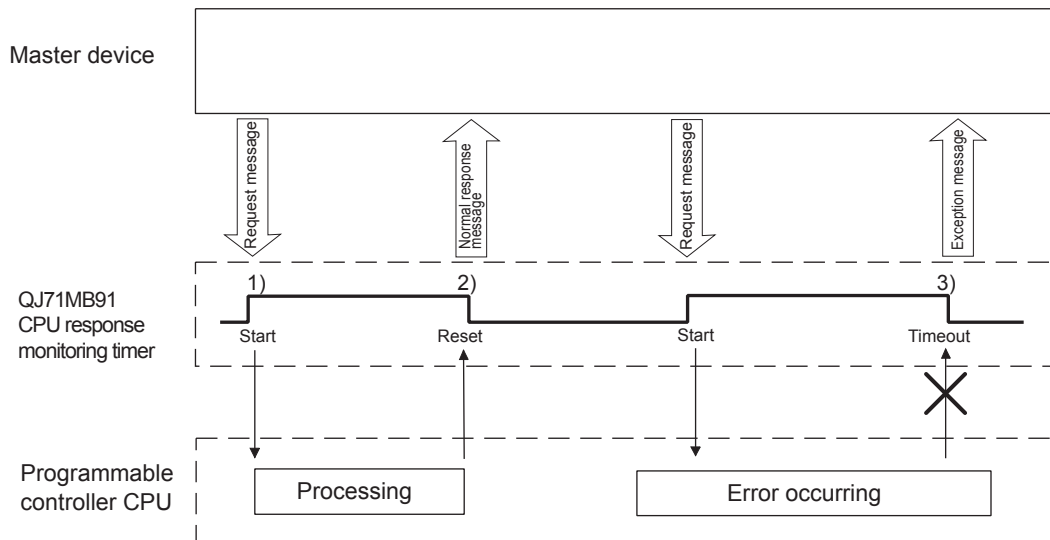

Figure 7.12 CPU response monitoring timer operation

(1) CPU response monitoring timer processing

(a) Start of the CPU response monitor timer

The QJ71MB91 starts the CPU response monitoring timer when it receives a request message from the master. (1) in Figure)

The CPU response monitoring timer monitors the programmable controller CPU processing until the QJ71MB91 starts sending a response message to the master. (2) in Figure)

(b) If the CPU response monitoring timer has timed out.

When the CPU response monitoring timer has timed out, the QJ71MB91 performs the following processes. (In figure 3))

- 1) Issues error code: 7380H. (See Section 11.4.3)
- 2) Issues the exception code: 04H to the master side. (See Section 11.4.2)

(2) To set the CPU response monitoring timer value

Set a CPU response monitoring timer value as specified below.

Table7.13 CPU response monitor timer setting

Address	Parameter name	Setting range	Default
000D _H (13)	CPU response monitoring timer value	0 : Limitless wait 1 to 2400 : CPU response monitoring timer value (Set time = set value x 500ms)	10 (5s)

POINT

When the CPU response monitoring timer value is "0", the QJ71MB91 waits until the programmable controller CPU completes its processing. (Limitless wait)

CHAPTER8 UTILITY PACKAGE (GX Configurator-MB)

GX Configurator-MB is a tool designed to support parameter setting, auto refresh, and monitor/test of the QJ71MB91.

Refer to the following for parameter setting or auto-refresh setting with a sequence program.

 CHAPTER 9

8.1 Functions of the Utility Package

The following table lists the utility Package.

Table8.1 Utility package function list

Item	Description	Reference
Initial setting	<p>Set the following items that require initial setting.</p> <ul style="list-style-type: none"> • Automatic communication parameter • MODBUS[®] device assignment parameter <p>The initially set data are registered as programmable controller CPU parameters, and are automatically written to the QJ71MB91 when the programmable controller CPU enters RUN status.</p>	Section 8.4
Auto refresh setting	<p>The QJ71MB91's buffer memory is configured for automatic refresh.</p> <ul style="list-style-type: none"> • Automatic communication function buffer input area • Automatic communication function buffer output area • Automatic communication operation status storage area • User free area (input/output) <p>The QJ71MB91 buffer memory area data set for auto refresh are automatically read from or written to the specified devices when the END instruction of the programmable controller CPU is executed.</p>	Section 8.5
Monitor/test	<p>The buffer memory and I/O signals of the QJ71MB91 are monitored or tested.</p> <ul style="list-style-type: none"> • Operation mode setting status • Transmission setting status • Station No. setting status • Various module statuses • X/Y Monitor/test • MODBUS[®] device assignment parameter status • Automatic communication status • Error log • Communication status 	Section 8.6

1 OVERVIEW

2 SYSTEM CONFIGURATION

3 SPECIFICATIONS

4 MODBUS(R) STANDARD FUNCTIONS

5 FUNCTION

6 PRE-OPERATIONAL PROCEDURES AND SETTINGS

7 PARAMETER SETTING

8 UTILITY PACKAGE (GX Configurator-MB)

8.2 Installing and Uninstalling the Utility Package

For how to install or uninstall the utility package, refer to "Method of installing the MELSOFT Series" included in the utility package.

8.2.1 Handling precautions

The following explains the precautions on using the GX Configurator-MB.

(1) For safety

Since GX Configurator-MB is add-in software for GX Developer, read "Safety Precautions" and the basic operating procedures in the GX Developer Operating Manual.

(2) About installation

GX Configurator-MB is add-in software for GX Developer Version 4 or later. Therefore, GX Configurator-MB must be installed on the personal computer that has already GX Developer Version 4 or later installed.

(3) Screen error of Intelligent function module utility

Insufficient system resource may cause the screen to be displayed inappropriately while using the Intelligent function module utility.

If this occurs, close the Intelligent function module utility, GX Developer (program, comments, etc.), and other applications, and then start GX Developer and Intelligent function module utility again.

(4) To start the Intelligent function module utility

(a) PLC series set on GX Developer

In GX Developer, select "QCPU (Q mode)" for PLC series and specify a project. If any PLC series other than "QCPU (Q mode)" is selected, or if no project is specified, the Intelligent function module utility will not start.

(b) Activating multiple sets of utility software

Multiple Intelligent function module utilities can be started.

However, [Open parameters] and [Save parameters] operations under [Intelligent function module parameter] are allowed for one Intelligent function module utility only.

Only the [Monitor/test] operation is allowed for the other utilities.

(5) Switching between two or more Intelligent function module utilities

When two or more Intelligent function module utility screens cannot be displayed side by side, select a screen to be displayed on the top of others using the task bar.



Figure 8.1 Task bar when more than one utility is running

(6) Number of parameters that can be set in GX Configurator-MB

When multiple intelligent function modules are mounted, the number of parameter setting must not exceed the following limit.

Table 8.2 Maximum number of parameter settings

When intelligent function modules are installed to:	Maximum number of parameter settings	
	Initial setting	Auto refresh setting
Q00J/Q00/Q01CPU	512	256
Q02/Q02H/Q06H/Q12H/Q25HCPU	512	256
Q02PH/Q06PH/Q12PH/Q25PHCPU	512	256
Q12PRH/Q25PRHCPU	512	256
Q00UJ/Q00U/Q01UCPU	512	256
Q02UCPU	2048	1024
Q03UD/Q04UDH/Q06UDH/Q10UDH/ Q13UDH/Q20UDH/Q26UDH/Q03UDE/ Q04UDEH/Q06UDEH/Q10UDEH/ Q13UDEH/Q20UDEH/Q26UDEHCPU	4096	2048
MELSECNET/H remote I/O station	512	256

For example, if multiple intelligent function modules are installed to the MELSECNET/H remote I/O station, configure the settings in GX Configurator so that the number of parameter setting for all the intelligent function modules does not exceed the limit of the MELSECNET/H remote I/O station.

Calculate the total number of parameter settings separately for the initial setting and for the auto refresh setting.

The number of parameters that can be set for one module in GX Configurator-MB is as shown below.

Table 8.3 Number of parameters that can be set per module

Target module	Initial setting	Auto refresh setting
QJ71MB91	3 (Fixed)	8(Max.)

Example) Counting the number of parameter settings in Auto refresh setting

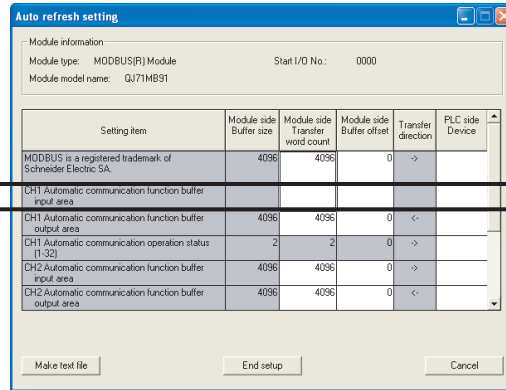

This one row is counted as one setting.
Blank rows are not counted.
Count up all the setting items on this screen, and add the total to the number of settings for other intelligent function modules to get a grand total.

Figure 8.2 How to count auto refresh settings

8.2.2 Operating environment

This section explains the operating environment of the personal computer that runs GX Configurator-MB.

Table 8.4 Operating environment

Item	Description	
Installation (Add-in) target* ¹	Add-in to GX Developer Version 4 (English version) or later.* ²	
Computer	Windows [®] -based personal computer	
	CPU	Refer to the next page "Operating system and performance required for personal computer".
	Required memory	
Hard disk space* ³	For installation	65MB or more
	For operation	10MB or more
Display	800 × 600 dots or more resolution* ⁴	
Operating system	Microsoft [®] Windows [®] 95 Operating System (English version) Microsoft [®] Windows [®] 98 Operating System (English version) Microsoft [®] Windows [®] Millennium Edition Operating System (English version) Microsoft [®] Windows NT [®] Workstation Operating System Version 4.0 (English version) Microsoft [®] Windows [®] 2000 Professional Operating System (English version) Microsoft [®] Windows [®] XP Professional Operating System (English version) Microsoft [®] Windows [®] XP Home Edition Operating System (English version) Microsoft [®] Windows Vista [®] Home Basic Operating System (English version) Microsoft [®] Windows Vista [®] Home Premium Operating System (English version) Microsoft [®] Windows Vista [®] Business Operating System (English version) Microsoft [®] Windows Vista [®] Ultimate Operating System (English version) Microsoft [®] Windows Vista [®] Enterprise Operating System (English version)	

* 1 Install GX Configurator-MB in GX Developer Version 4 or higher in the same language. GX Developer (English version) and GX Configurator-MB (Japanese version) cannot be used in combination, and GX Developer (Japanese version) and GX Configurator-MB (English version) cannot be used in combination.

* 2 GX Configurator-MB is not applicable to GX Developer Version 3 or earlier.

* 3 At least 15GB is required for Windows Vista[®].

* 4 Resolution of 1024 × 768 dots or more is recommended for Windows Vista[®].

Table8.5 Operating system and performance required for personal computer

Operating system	Performance required for personal computer	
	CPU	Memory
Windows® 95 (Service Pack 1 or higher)	Pentium® 133 MHz or more	32MB or more
Windows® 98	Pentium® 133 MHz or more	32MB or more
Windows® Me	Pentium® 150 MHz or more	32MB or more
Windows NT® Workstation 4.0 (Service Pack 3 or higher)	Pentium® 133 MHz or more	32MB or more
Windows® 2000 Professional	Pentium® 133 MHz or more	64MB or more
Windows® XP Professional	Pentium® 300 MHz or more	128MB or more
Windows® XP Home Edition	Pentium® 300 MHz or more	128MB or more
Windows Vista® Home Basic	Pentium® 1 GHz or more	1GB or more
Windows Vista® Home Premium	Pentium® 1 GHz or more	1GB or more
Windows Vista® Business	Pentium® 1 GHz or more	1GB or more
Windows Vista® Ultimate	Pentium® 1 GHz or more	1GB or more
Windows Vista® Enterprise	Pentium® 1 GHz or more	1GB or more

POINT

- (1) The functions shown below are not available for Windows® XP and Windows Vista®.

If any of the following functions is attempted, this product may not operate normally.

- Start of application in Windows® compatible mode
- Fast user switching
- Remote desktop
- Large fonts (Details setting of Display Properties)

Also, 64-bit version Windows® XP and Windows Vista® are not supported.

- (2) Use a USER authorization or higher in Windows Vista®.

8.3 Utility Package Operation

8.3.1 Common utility package operations

(1) Control keys

Special keys that can be used for operation of the utility package and their applications are shown in the table below.

Table8.6 List of control keys used for GX Configurator-MB

Key	Application
Esc	Cancels the current entry in a cell. Closes the window.
Tab	Moves between controls in the window.
Ctrl	Used in combination with the mouse operation to select multiple cells for test execution.
Delete	Deletes the character where the cursor is positioned. When a cell is selected, clears all of the setting contents in the cell.
Back Space	Deletes the character where the cursor is positioned.
↑ ↓ ← →	Moves the cursor.
Page Up	Moves the cursor one page up.
Page Down	Moves the cursor one page down.
Enter	Completes the entry in the cell.

(2) Data created with the utility package

The following data or files that are created with the utility package can be also handled in GX Developer.

How to handle the data/files in which operation is shown below.

(a) Intelligent function module parameter

Initial settings and auto refresh settings are saved in an intelligent function module parameter file in a project created with GX Developer.

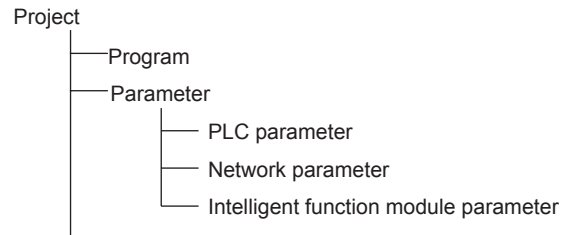

Figure 8.3 Data configuration on GX Configurator-MB

(b) Text files

A text file can be created by clicking the button on the initial setting, Auto refresh setting, or Monitor/Test screen.

The text files can be utilized to create user documents.

This file can be utilized to create user documents.

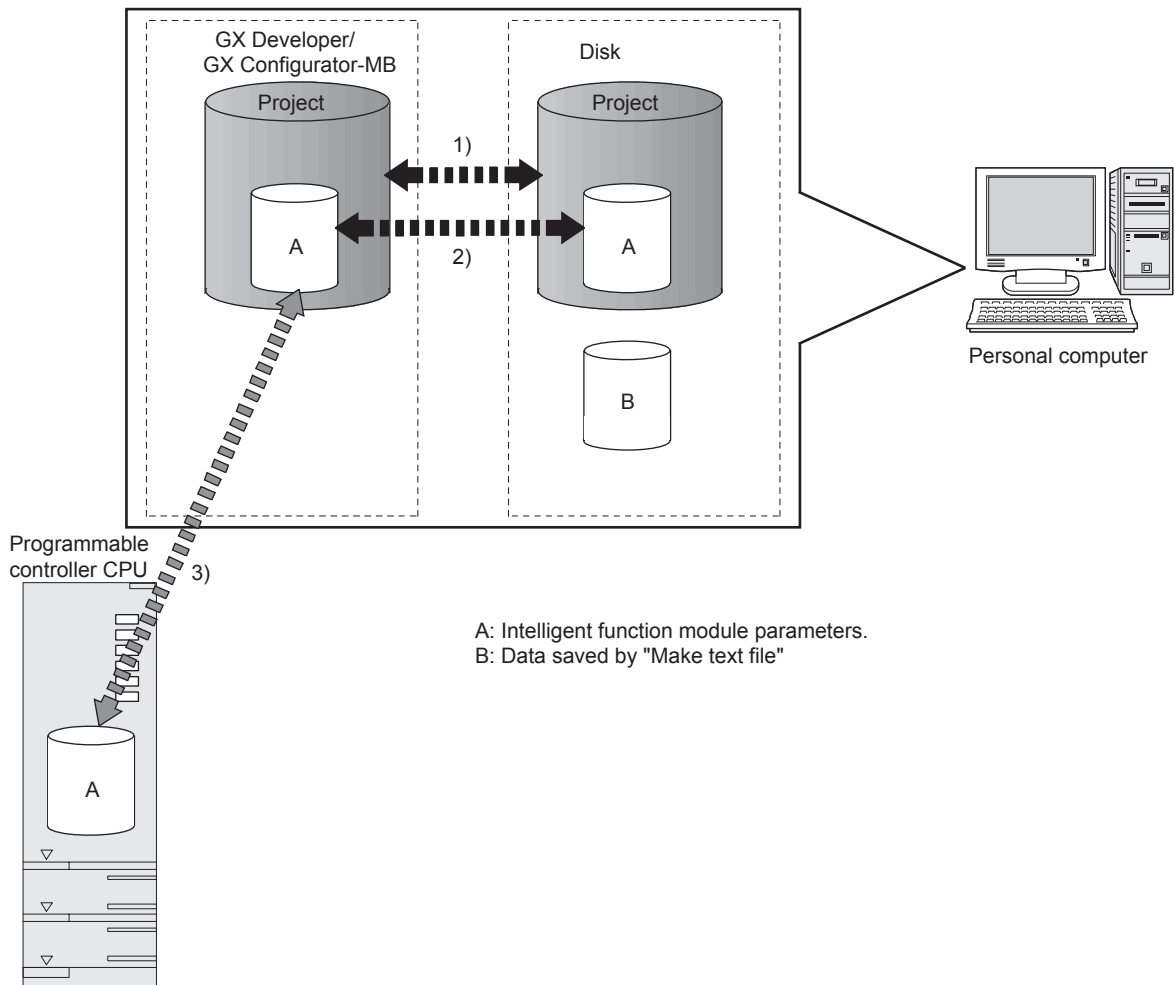

Figure 8.4 Flow of GX Configurator-MB data

Steps 1) to 3) in the figure are performed as shown below.

- 1) From GX Developer, select:
[Project] → [Open project]/[Save]/[Save as]
- 2) On the intelligent function module selection screen of the utility, select:
[Intelligent function module parameter] → [Open parameters]/[Save parameters]
- 3) From GX Developer, select:
[Online] → [Read from PLC]/[Write to PLC] → "Intelligent function module parameter"
Alternatively, from the intelligent function module selection screen of the utility, select:
[Online] → [Read from PLC]/[Write to PLC]

8.3.2 Operation overview

GX Developer screen

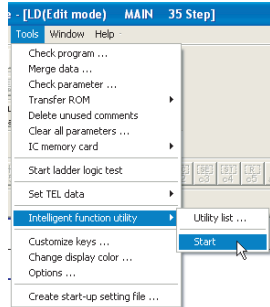

[Tools] - [Intelligent function utility] - [Start]

Select a target intelligent function module screen

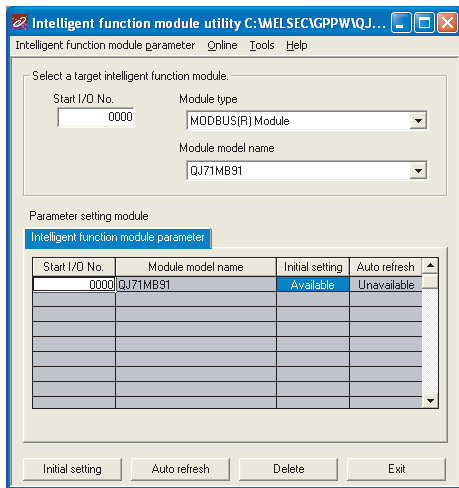

Enter "Start I/O No." and select "Module type" and "Module model name".



Section 8.3.3

Initial setting

Auto refresh

Initial setting screen

Auto refresh setting screen

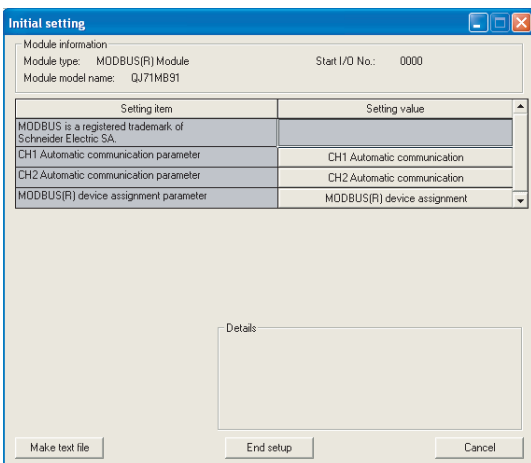

Section 8.4

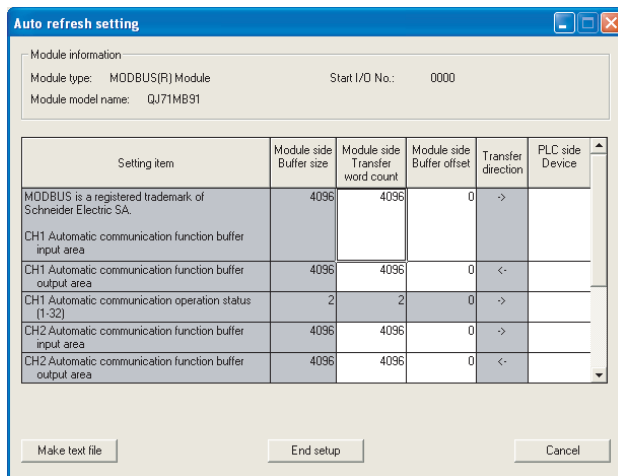

Section 8.5

Figure 8.5 GX Configurator-MB operation overview

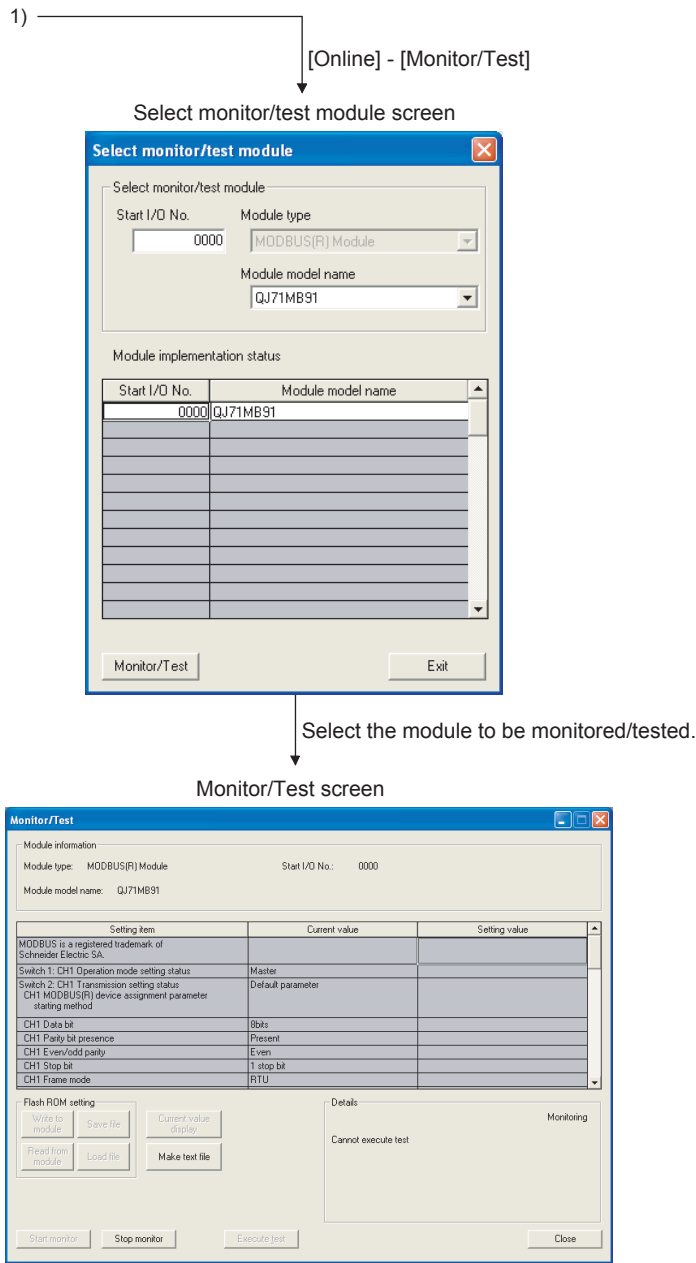

Section 8.6

Figure 8.5 GX Configurator-MB operation overview (Continued)

1 OVERVIEW

2 SYSTEM CONFIGURATION

3 SPECIFICATIONS

4 MODBUS(R) STANDARD FUNCTIONS

5 FUNCTION

6 PRE-OPERATIONAL PROCEDURES AND SETTINGS

7 PARAMETER SETTING

8 UTILITY PACKAGE (GX Configurator-MB)

8.3.3 Starting the Intelligent function module utility

[Operating procedure]

Intelligent function module utility is started from GX Developer.

[Tools] → [Intelligent function utility] → [Start]

[Setting Screen]

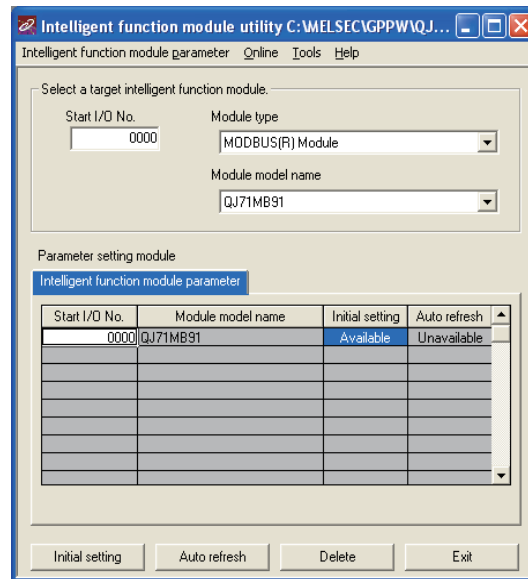

Figure 8.6 Intelligent function module utility

[Explanation of items]

(1) Activation of other screens

Following screens can be displayed from the intelligent function module utility screen.

(a) Initial setting screen

"Start I/O No. *1" → "Module type" → "Module model name" → Initial setting

(b) Auto refresh setting screen

"Start I/O No. *1" → "Module type" → "Module model name" → Auto refresh

(c) Select monitor/test module screen

[Online] → [Monitor/Test]

* 1 Enter the start I/O No. in hexadecimal.

(2) Command buttons

Delete Deletes the initial setting and auto refresh setting of the selected module.

Exit Closes this screen.

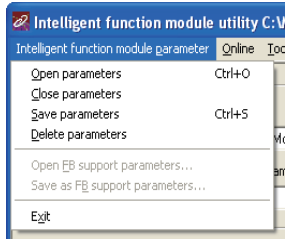

(a) File menu

Intelligent function module parameters of the project opened by GX Developer are handled.

[Open parameters] : Reads a parameter file.

[Close parameters]: Closes the parameter file.

If any data are modified, a dialog asking for file saving will appear.

[Save parameters] : Saves the parameter file.

[Delete parameters] : Deletes the parameter file.

[Exit] : Closes this screen.

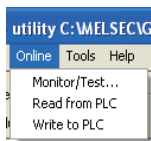

(b) Online menu

[Monitor/Test] : Activates the Select monitor/test module screen.

[Read from PLC] : Reads intelligent function module parameters from a programmable controller CPU.

[Write to PLC] : Writes intelligent function module parameters to a programmable controller CPU.

POINT

1. Saving intelligent function module parameters in a file
Since intelligent function module parameters cannot be saved in a file by the project saving operation of GX Developer, save them on the shown module selection screen.
 2. Reading / writing intelligent function module parameters from / to a programmable controller using GX Developer
 - Intelligent function module parameters can be read from and written into a programmable controller after having been saved in a file.
 - Set a target programmable controller CPU in GX Developer:
[Online] → [Transfer setup].
Only use the control CPU for the QJ71MB91 to write the intelligent function module parameters for a multiple CPU system to the programmable controller.
 - When the QJ71MB91 is mounted on a MELSECNET/H remote I/O station, [Read from PLC] and [Write to PLC] must be performed from GX Developer.
 3. Checking the required utility
While the start I/O is displayed on the Intelligent function module utility setting screen, "*" may be displayed for the model name.
This means that the required utility has not been installed or the utility cannot be started from GX Developer.
Check the required utility, selecting [Tools] - [Intelligent function utility] - [Utility list...] in GX Developer.
-

8.4 Initial Setting

[Purpose]

Set parameters on the initial setting screen.

This setting eliminates the need for parameter setting by sequence programs.

The initial setting are as follows:

- Automatic communication parameter
- MODBUS® device assignment parameter

[Operating procedure]

"Start I/O No. " → "Module type" → "Module model name" → Initial setting

[Setting Screen]

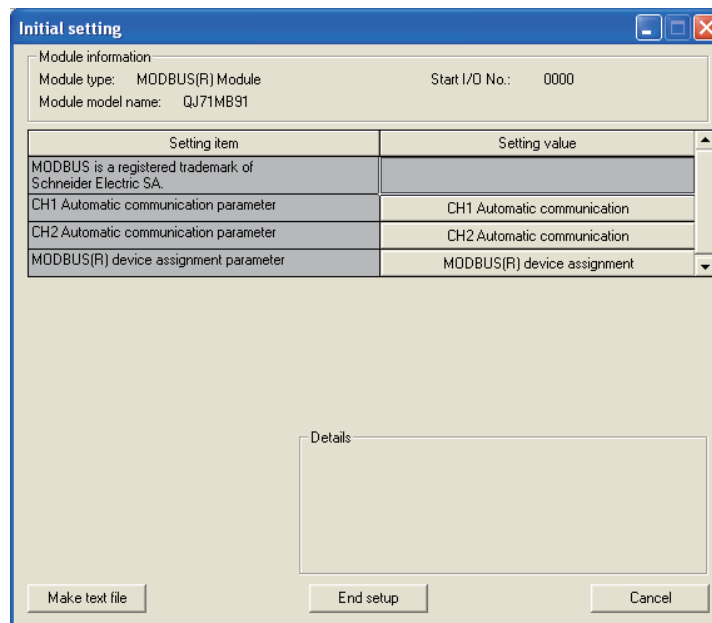

Figure 8.7 Initial setting screen

[Explanation of items]

(1) Parameter settings

Select a button under the Setting value, and set parameters on the corresponding screen.

- Automatic communication parameter (☞ Section 8.4.1)
- MODBUS® device assignment parameter (☞ Section 8.4.2)

(2) Command buttons

Make text file

Creates a file containing the screen data in text file format.

End setup

Saves the set data and ends the operation.

Cancel

Cancels the setting and ends the operation.

POINT

1. The initial settings are stored as the intelligent function module parameters. After the intelligent function module parameters have been written to the programmable controller CPU, the initial setting is updated when the programmable controller is powered ON from OFF or the programmable controller CPU is reset (with the programmable controller CPU's RUN/STOP switch set to RUN).
If the QJ71MB91 is mounted on a MELSECNET/H remote I/O station, the initial settings become effective when the remote I/O station receives the information notifying the status change (from STOP to RUN) of the remote master station's programmable controller CPU.
 2. If the initial settings become effective, the MODBUS[®] device assignment parameter setting existence (XA) turns ON.
Do not write any data to the buffer memory by sequence programs or manipulate Y signals until the MODBUS[®] device assignment parameter setting existence (XA) turns ON.
 3. If the initial setting data are written using a sequence program, the initial setting values are written when the programmable controller CPU is changed from STOP to RUN status. Therefore, perform programming so that the initial setting will be re-executed with the sequence program.
 4. The parameter setting by sequence program has priority over the parameter setting by the initial setting when both of them are used.
-

8.4.1 Automatic communication parameter

[Purpose]

Set the automatic communication parameters on the Automatic communication parameter screen.

[Operating procedure]

Initial setting screen → Automatic communication

[Setting Screen]

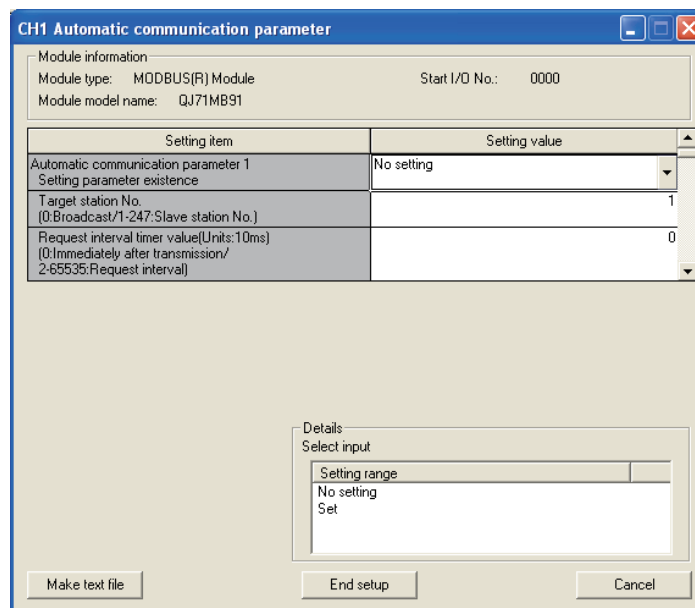

Figure 8.8 Automatic communication parameter setting screen

[Setting items]

For the automatic communication parameter setting, set a value in proper data format or within the setting range for each item in the Setting value column, and click the

button to save all the set values.

Table 8.7 Setting items on Automatic communication parameter setting screen

Setting item		Buffer memory address		Reference	
		CH1	CH2		
Automatic communication parameter 1	Setting parameter existence	0200H to 0201H (512 to 513)	0380H to 0381H (896 to 897)	Section 7.2	
	Target station No.	0202H (514)	0382H (898)		
	Request interval timer value	0203H (515)	0383H (899)		
	Response monitoring timer value/Broadcast delay value	0204H (516)	0384H (900)		
	Type specification of the target MODBUS(R) device	0205H (517)	0385H (901)		
	Read setting	Head buffer memory address	0206H (518)		0386H (902)
		Target MODBUS(R) device head number	0207H (519)		0387H (903)
		Access points	0208H (520)		0388H (904)
	Write setting	Head buffer memory address	0209H (521)		0389H (905)
		Target MODBUS(R) device head number	020AH(522)		038AH(906)
Access points		020BH(523)	038BH(907)		
Automatic communication parameter 2 to 32	(Same as in automatic communication parameter 1)	020CH to 037FH (524 to 895)	038CH to 04FFH(908 to 1279)		

POINT

After the automatic communication parameters have been written to the programmable controller CPU, the automatic communication function is operated when the programmable controller is powered ON from OFF or the programmable controller CPU is reset (with the programmable controller CPU's RUN/STOP switch set to RUN).

8.4.2 MODBUS(R) device assignment parameter

[Purpose]

Set the MODBUS® device assignment parameters on the MODBUS(R) device assignment parameter screen.

[Operating procedure]

Initial settings screen → MODBUS (R) device assignment

[Setting Screen]

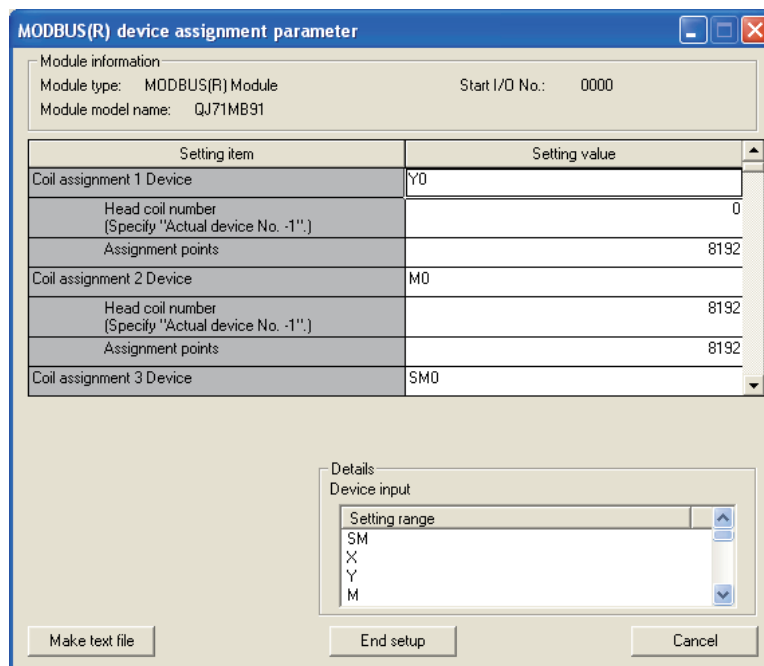

Figure 8.9 MODBUS(R) device assignment parameter setting screen

[Setting items]

For the MODBUS[®] device assignment parameter setting, set a value in proper data format or within the setting range for each item in the Setting value column, and click the **End setup** button to save all the set values.

Table 8.8 Setting items on the MODBUS(R) device assignment parameter setting screen

Setting item		Buffer memory address	Reference
Coil assignment 1	Device	0900H to 0901H (2304 to 2305)	Section 7.3.1 Section 7.3.3
	Head coil number	0902H (2306)	
	Assignment points	0903H (2307)	
Coil assignment 2 to 16	(Same as in coil assignment 1)	0904H to 093FH (2308 to 2367)	
Input assignment 1	Device	0940H to 0941H (2368 to 2369)	
	Head input number	0942H (2370)	
	Assignment points	0943H (2371)	
Input assignment 2 to 16	(Same as input assignment 1)	0944H to 097FH (2372 to 2431)	
Input register assignment 1	Device *1	0980H to 0981H (2432 to 2433)	
	Head input register number	0982H (2434)	
	Assignment points	0983H (2435)	
Input register assignment 2 to 16	(Same as in input register assignment 1)	0984H to 09BFH (2436 to 2495)	
Holding register assignment 1	Device *1	09C0H to 09C1H (2496 to 2497)	
	Head holding register number	09C2H (2498)	
	Assignment points	09C3H (2499)	
Holding register assignment 2 to 16	(Same as in holding register assignment 1)	09C4H to 09FFH (2500 to 2559)	

* 1 If the MODBUS[®] device is an input register or holding register, QJ71MB91 buffer memory (user free area: 5000H to 5FFFH) setting is also possible.
When setting the buffer memory, enter "H*"
For example, when setting buffer memory address 5500H, enter "H5500".

(Continued on next page)

Table 8.8 Setting items on the MODBUS(R) device assignment parameter setting screen (Continued)

Setting item	Buffer memory address	Reference
Error status read device *2	000AH to 000BH (10 to 11)	Section 7.3.4
Allocated error status area *3	000FH (15)	
Access target (when mounted to MELSECNET/H remote I/O station)	000EH (14)	Section 7.3.5
CPU response monitoring timer value	000DH (13)	Section 7.3.6

* 2 When setting the QJ71MB91 buffer memory, enter "H0".
(No other value can be set.)

At this time, set the value to be returned to the master in the case of Read Exception Status (FC:07) into "Allocated error status area".

* 3 "Allocated error status area" is valid only when the QJ71MB91 buffer memory is specified as the error status read device assignment target. (Section 7.3.4)

8.5 Auto Refresh Setting

[Purpose]

Make this setting to store the QJ71MB91 buffer memory data into the specified devices of the programmable controller CPU or to store the programmable controller CPU device data into the QJ71MB91 buffer memory automatically.

[Operating procedure]

"Start I/O No." → "Module type" → "Module model name" → Auto refresh

[Setting screen]

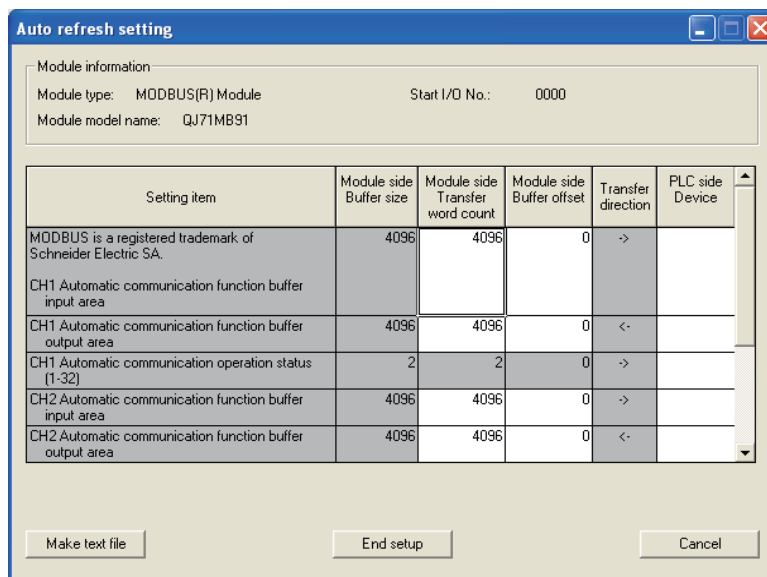

Figure 8.10 Auto refresh setting screen

[Explanation of items]

(1) Display data

(a) Setting items

Table 8.9 Setting items on the Auto refresh setting screen

Setting item	Buffer memory address		Reference
	CH1	CH2	
Automatic communication function buffer input area	1000H to 1FFFH (4096 to 8191)	2000H to 2FFFH (8192 to 12287)	Section 5.2.1
Automatic communication function buffer output area	3000H to 3FFFH (12288 to 16383)	4000H to 4FFFH (16384 to 20479)	
Automatic communication operation status (1 to 32)	0C20H to 0C21H (3104 to 3105)	0C22H to 0C23H (3106 to 3107)	Section 11.4.1 (5)
User free area (input/output)	5000H to 5FFFH (20480 to 24575)		Section 7.3.3

(b) Display items

- 1) Module side Buffer size
Displays the buffer memory size of the setting item.
- 2) Module side Transfer word count
Displays the number of words to be transferred.
- 3) Module side buffer offset
Displays the offset value of the buffer memory data to be transferred.
- 4) Transfer direction
"<-" indicates that data are written from the device to the buffer memory.
"->" indicates that data are loaded from the buffer memory to the device.
- 5) PLC side Device
Enter a programmable controller CPU side device that is to be automatically refreshed.
Applicable devices are X, Y, M, L, B, T, C, ST, D, W, R and ZR.
When using bit devices X, Y, M, L or B, set a number that can be divided by 16 points (examples: X10, Y120, M16, etc.)
Also, buffer memory data are stored in a 16-point area, starting from the specified device number.
For example, if X10 is entered, data are stored in X10 to X1F.
The devices available for MELSECNET/H remote I/O modules are X, Y, M, B, D and W.

(2) Command buttons

Make text file	Creates a file containing the screen data in text file format.
End setup	Saves the set data and ends the operation.
Cancel	Cancels the setting and ends the operation.

POINT

1. The auto refresh settings are stored in an intelligent function module parameter file.
After the intelligent function module parameters have been written to the programmable controller CPU, the auto refresh setting is enabled when the programmable controller is powered ON from OFF or the programmable controller CPU is reset (with programmable controller CPU's RUN/STOP switch set to RUN).
2. The auto refresh settings cannot be changed from sequence programs. However, processing equivalent to auto refresh can be added using the FROM/TO instruction in the sequence program.

8.6 Monitor/Test

[Monitor/Test Purpose]

From this screen, start the monitoring or test of the QJ71MB91 operating status, I/O signals, parameter setting status, automatic communication status, error log or communication status.

[Operating procedure]

"Select monitor/test module" screen → "Start I/O No. *1" → "Module type" → "Module model name" →

* 1 Enter the start I/O No. in hexadecimal.

The screen can also be started from System monitor of GX Developer Version 6 or later.

( GX Developer Operating Manual)

[Monitor/Test Screen]

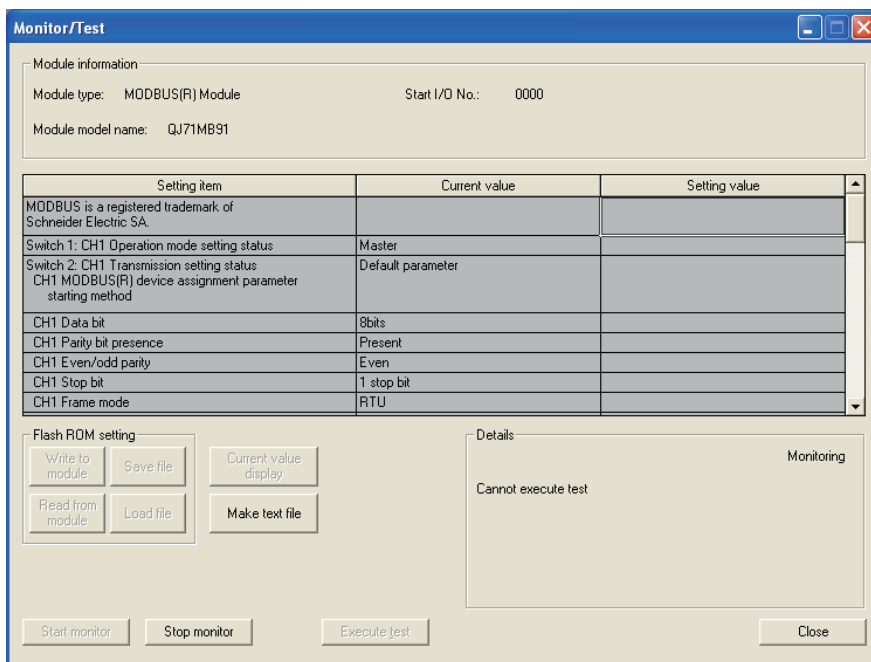

Figure 8.11 Monitor/Test screen

[Monitor/Test Items]

Table 8.10 Setting items on the Monitor/test screen

Monitor/Test item	Buffer memory address		Reference	
	CH1	CH2		
Operation mode setting status	0C00H (3072)	0C02H (3074)		
Transmission setting status				
MODBUS(R) device assignment parameter starting method				
Data bit				
Parity bit presence				
Even/ odd parity	0C01H (3073)	0C03H (3075)	Section 6.6	
Stop bit				
Frame mode				
Online change				
Transmission speed				
Station No. setting status	0C04H (3076)			
Module READY	-			
Watch dog timer error	-			
CH common/CH1 error	-			
CH common/CH1 error clear request *1	-		Section 11.5	
CH2 error	-			
CH 2 error clear request *1	-			
X/Y Monitor/test *2	-		Section 8.6.1	
MODBUS(R) device assignment parameter status *2	-		Section 8.6.2	
Automatic communication status *2	-		Section 8.6.3	
Error log *2	-		Section 8.6.4	
Communication status *2	-		Section 8.6.5	

* 1 For the error clear request, select the corresponding request in the Setting value column. (☞
Section 11.5)

* 2 To move to each sub screen, click the button in the Setting value column.

1	OVERVIEW
2	SYSTEM CONFIGURATION
3	SPECIFICATIONS
4	MODBUS(R) STANDARD FUNCTIONS
5	FUNCTION
6	PRE-OPERATIONAL PROCEDURES AND SETTINGS
7	PARAMETER SETTING
8	UTILITY PACKAGE (GX Configurator-MB)

[Specifications common to Monitor and Test screens (including sub screens)]

The following explains the specifications common to respective screens.

(1) Display data

Setting item : Displays I/O signals and buffer memory names.

Current value : Monitors the I/O signal states and present buffer memory values.

Setting value : Enter or select the data to be written by test operation.

(2) Command buttons

Current value display

Displays the current value of the item selected. (This is used to check the text that cannot be displayed in the current value field. However, in this utility package, all items can be displayed in the display fields.)

Make text file

Creates a file containing the screen data in text file format.

Start monitor / Stop monitor

Selects whether or not to monitor current values.

Execute test

Performs a test on the selected item.

To select more than one item, select them while holding down the **Ctrl** key.

Close

Closes the screen that is currently open and returns to the previous screen.

[Monitor/Test screen - Sub screen shift]

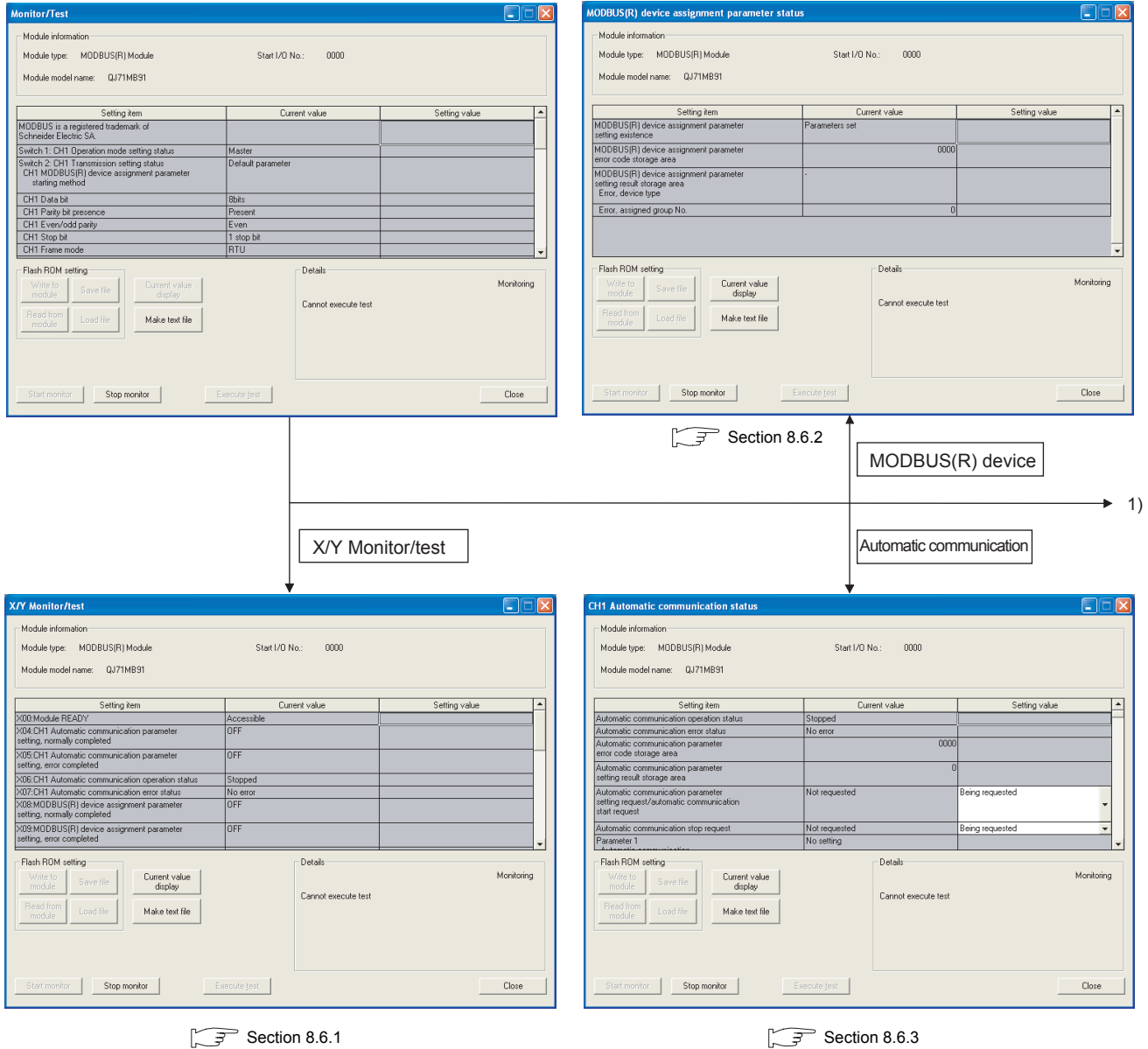
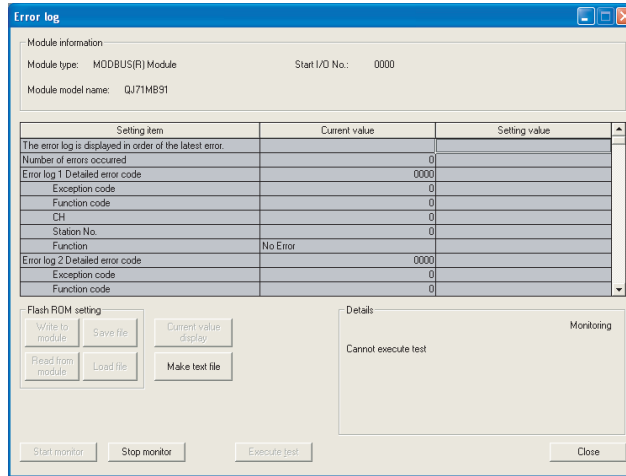

Figure 8.12 Move from the Monitor/Test screen to sub screens

1 OVERVIEW
2 SYSTEM CONFIGURATION
3 SPECIFICATIONS
4 MODBUS(R) STANDARD FUNCTIONS
5 FUNCTION
6 PRE-OPERATIONAL PROCEDURES AND SETTINGS
7 PARAMETER SETTING
8 UTILITY PACKAGE (GX Configurator-MB)



Section 8.6.4

1)

Error log

Communication status

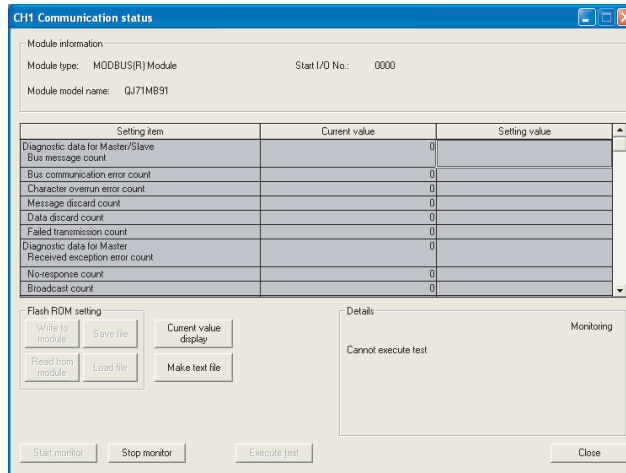

Section 8.6.5

Figure 8.12 Move from the Monitor/Test screen to sub screens (Continued)

8.6.1 X/Y Monitor/test

[Monitor/Test Purpose]

Monitor I/O signals and performs tests on output signals.

[Operating procedure]

Monitor/Test screen → X/Y Monitor/test

[Monitor/Test Screen]

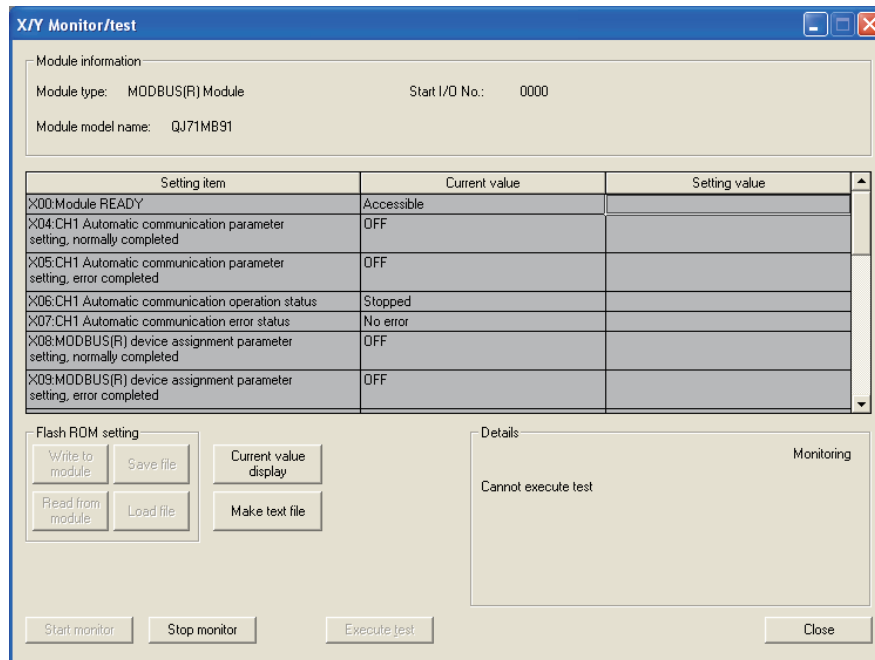

Figure 8.13 X/Y Monitor/test screen

[Monitor/Test Items]

(1) X: Input signals

Table8.11 Setting items on the X/Y Monitor/test screen (Input signals)

Monitor/test item	Buffer memory address	Reference
X00: Module READY	-	Section 9.1.1
X04: CH1 Automatic communication parameter setting, normally completed	-	
X05: CH1 Automatic communication parameter setting, error completed	-	
X06: CH1 Automatic communication operation status	-	
X07: CH1 Automatic communication error status	-	
X08: MODBUS(R) device assignment parameter setting, normally completed	-	Section 9.1.2
X09: MODBUS(R) device assignment parameter setting, error completed	-	
X0A: MODBUS(R) device assignment parameter setting existence	-	
X0C: CH2 Automatic communication parameter setting, normally completed	-	Section 9.1.1
X0D: CH2 Automatic communication parameter setting, error completed	-	
X0E: CH2 Automatic communication operation status	-	
X0F: CH2 Automatic communication error status	-	
X1B: CH common/CH1 error	-	Section 11.5
X1C: CH2 error	-	
X1F: Watch dog timer error	-	-

(2) Y: Output signals

To perform a test on output signals, select any item in the Setting value column and click the button.

Table8.12 Setting items on the X/Y Monitor/test screen (Output signals)

Monitor/test Item	Buffer memory address	Reference
Y04: CH1 Automatic communication parameter setting request/Automatic communication start request	-	Section 9.1.1
Y06: CH1 Automatic communication stop request	-	
Y08: MODBUS(R) device assignment parameter setting request	-	Section 9.1.2
Y0C: CH2 Automatic communication parameter setting request/Automatic communication start request	-	Section 9.1.1
Y0E: CH2 Automatic communication stop request	-	
Y1B: CH common/CH1 error clear request	-	Section 11.5
Y1C: CH2 error clear request	-	

8.6.2 MODBUS(R) device assignment parameter status

[Monitor Purpose]

Monitor the setting status of the MODBUS® device assignment parameters.

[Operating procedure]

Monitor/test screen → MODBUS(R) device

[Monitor Screen]

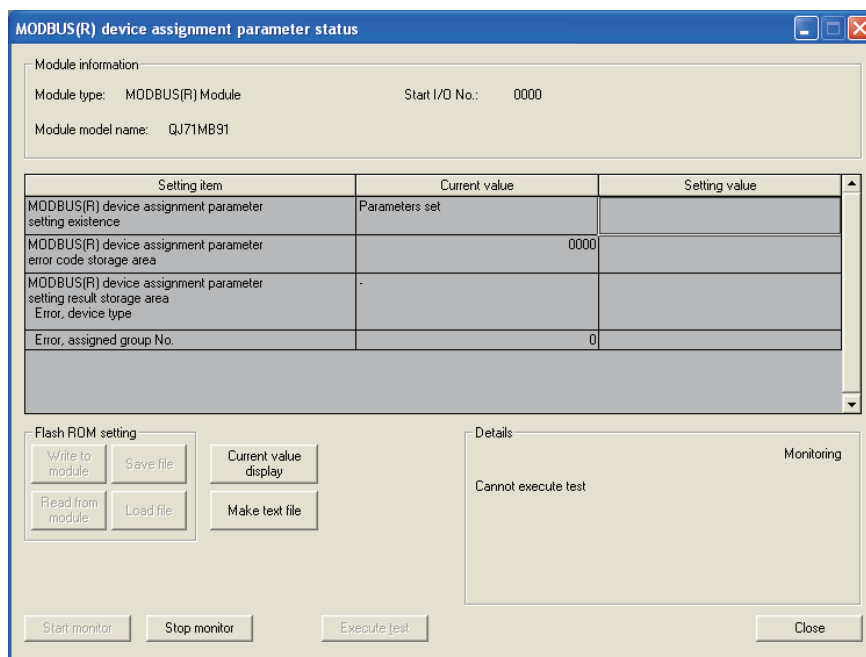

Figure 8.14 MODBUS(R) device assignment parameter status screen

[Monitor Items]

Table 8.13 Setting items on the MODBUS(R) device assignment parameter status screen

Monitor item	Buffer memory address	Reference	
MODBUS(R) device assignment parameter setting existence	-	Section 11.4.1	
MODBUS(R) device assignment parameter error code storage area	0C13H (3091)		
MODBUS(R) device assignment parameter setting result storage area	Error, device type		0C14H (3092)
	Error, assigned group No.		0C15H (3093)

8.6.3 Automatic communication status

[Monitor/Test Purpose]

Monitor the communication status of the automatic communication function.

[Operating procedure]

Monitor/test screen → Automatic communication

[Monitor/Test Screen]

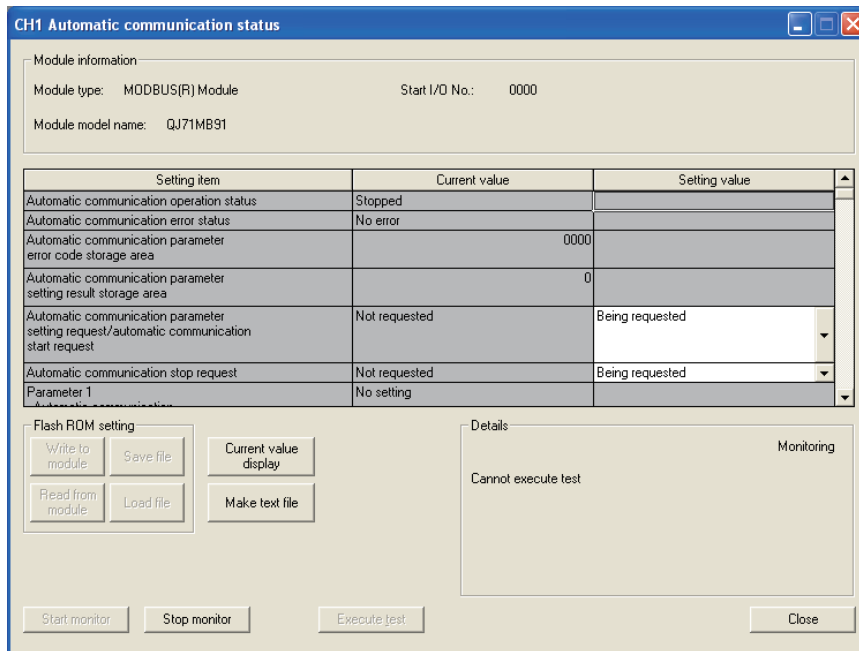

Figure 8.15 Automatic communication status screen

[Monitor/Test Items]

Table 8.14 Setting items on the Automatic communication status screen

Monitor/test items		Buffer memory address		Reference
		CH1	CH2	
Automatic communication operation status		-		Section 11.4.1
Automatic communication error status		-		
Automatic communication parameter error code storage area		0C16H (3094)	0C18H (3096)	
Automatic communication parameter setting result storage area		0C17H (3095)	0C19H (3097)	
Automatic communication parameter setting request/automatic communication start request *1		-		
Automatic communication stop request *1		-		
Parameters 1 to 32	Automatic communication setting status storage area	0CA8H to 0CA9H (3240 to 3241)	0CAAH to 0CABH (3242 to 3243)	
	Automatic communication operation status storage area	0C20H to 0C21H (3104 to 3105)	0C22H to 0C23H (3106 to 3107)	
	Automatic communication error code storage area	0C28H to 0C47H (3112 to 3143)	0C48H to 0C67H (3144 to 3175)	

* 1 To test the automatic communication start request or the automatic communication stop request, select the relevant item in the Setting value column and click the button.

POINT

When conducting a test on the automatic communication start request or automatic communication stop request with "Being requested" set in the Setting value column, make sure that "Not requested" is displayed in the Current value column.

When the current value is "Being requested", the test for "Being requested" setting cannot be performed.

If the current value is "Being requested", change it to "Not requested" and start the test.

1 OVERVIEW

2 SYSTEM CONFIGURATION

3 SPECIFICATIONS

4 MODBUS(R) STANDARD FUNCTIONS

5 FUNCTION

6 PRE-OPERATIONAL PROCEDURES AND SETTINGS

7 PARAMETER SETTING

8 UTILITY PACKAGE (GX Configurator-MB)

8.6.4 Error log

[Monitor Purpose]

Display the errors that occurred in the QJ71MB91.

Error logs are displayed in reverse chronological order (the latest error is displayed as No.1).

[Operating procedure]

Monitor/test Screen →

[Monitor Screen]

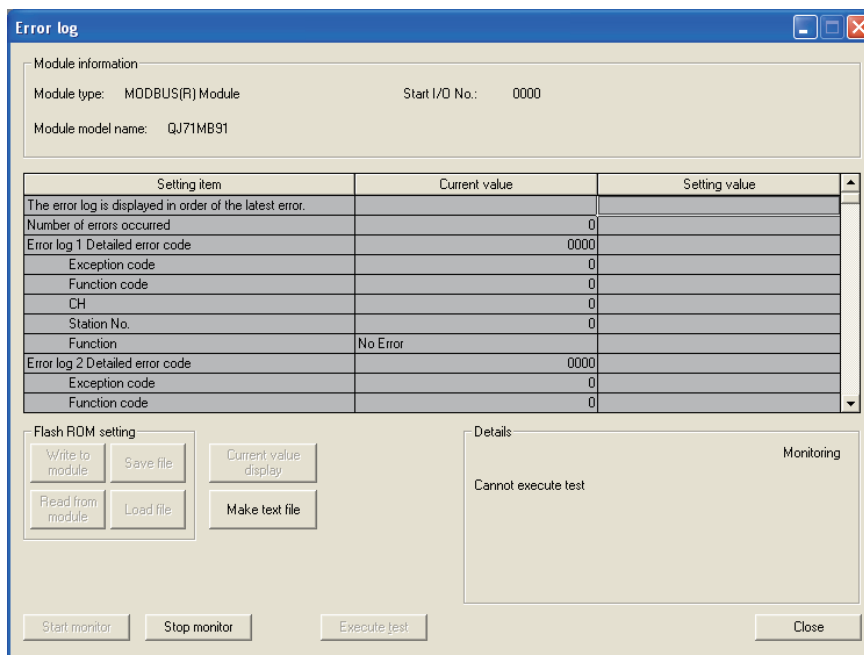

Figure 8.16 Error log screen

[Monitor Items]

Table 8.15 Setting items on the Error log screen

Monitor item		Buffer memory address	Reference
Number of errors occurred		0CFEH (3326)	Section 11.4.1
No. 1	Detailed error code	0D00H(3328)	
	Exception code	0D01H(3329)	
	Function code	0D02H(3330)	
	CH	0D03H(3331)	
	Station No.	0D04H(3332)	
	Function	0D07H(3335)	
No.2 to 32	(Same as in No. 1)	0D08H to 0DFFH (3336 to 3583)	

8.6.5 Communication status

[Monitor Purpose]
Monitor communication status.

[Operating procedure]
Monitor/test screen → Communication status

[Monitor Screen]

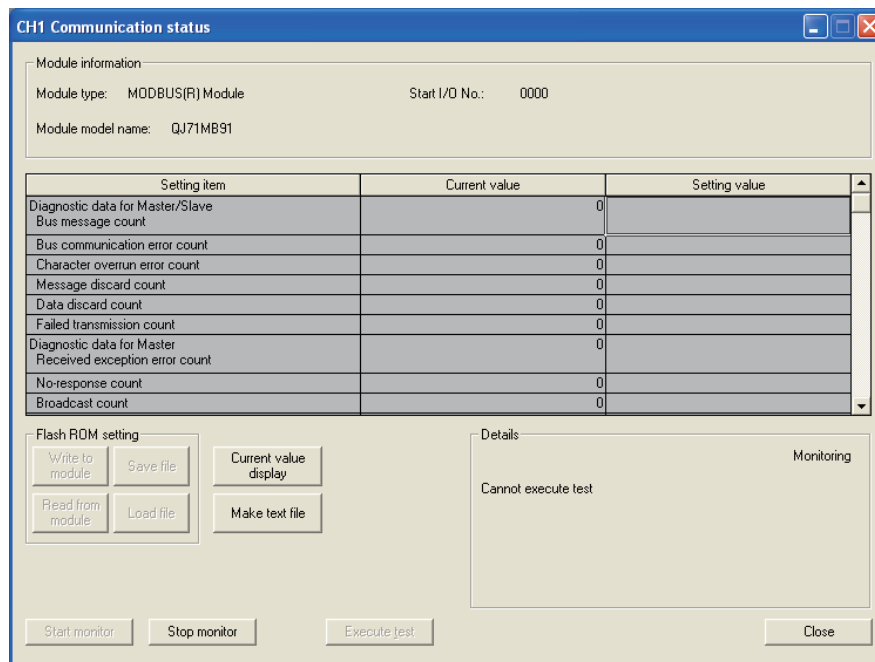

Figure 8.17 Communication status screen

[Monitor Items]

Table 8.16 Setting items on the Communication status screen

Monitor item	Buffer memory address		Reference
	CH1	CH2	
Diagnostic data for Master/Slave	-		Section 11.3
Bus message count	0F00H (3840)	0F40H (3904)	
Bus communication error count	0F01H (3841)	0F41H (3905)	
Character overrun error count	0F02H (3842)	0F42H (3906)	
Message discard count	0F03H (3843)	0F43H (3907)	
Data discard count	0F04H (3844)	0F44H (3908)	
Failed transmission count	0F05H (3845)	0F45H (3909)	
Diagnostic data for Master	-		
Received exception error count	0F0EH (3854)	0F4EH (3918)	
No-response count	0F0FH (3855)	0F4FH (3919)	
Broadcast count	0F10H (3856)	0F50H (3920)	
Received NAK count	0F11H (3857)	0F51H (3921)	
Received busy count	0F12H (3858)	0F52H (3922)	

(Continued on next page)

Table 8.16 Setting items on the Communication status screen (Continued)

Monitor item	Buffer memory address		Reference
	CH1	CH2	
Diagnostic data for Slave	-		
Slave message count	0F06H (3846)	0F46H (3910)	Section 11.3
Slave no-response count	0F07H (3847)	0F47H (3911)	
Slave NAK count	0F08H (3848)	0F48H (3912)	
Slave busy count	0F09H (3849)	0F49H (3913)	
Exception error count	0F0AH (3850)	0F4AH (3914)	
Communications event count	0F0BH (3851)	0F4BH (3915)	Section 4.12
2nd byte of end code	0F0CH (3852)	0F4CH (3916)	Section 4.11.4
Communications mode	0F0DH (3853)	0F4DH (3917)	Section 4.11.5
Communications event log count	0F1FH (3871)	0F5FH (3935)	Section 4.13
Communications event log 1 to 64	0F20H to 0F3FH(3872 to 3903)	0F60H to 0F7FH(3936 to 3967)	
Error response code presence	0006H (6)	0007H (7)	Section 11.4.2
Error response code storage area	0002H (2)	0004H (4)	
LED status	-		
C/N	0006H (6)	0007H (7)	Section 11.2
P/S			
PRO.			
SIO			
NEU.			
ACK.			
NAK			

1	OVERVIEW
2	SYSTEM CONFIGURATION
3	SPECIFICATIONS
4	MODBUS(R) STANDARD FUNCTIONS
5	FUNCTION
6	PRE-OPERATIONAL PROCEDURES AND SETTINGS
7	PARAMETER SETTING
8	UTILITY PACKAGE (GX Configurator-MB)

CHAPTER9 PROGRAMMING

This chapter explains parameter setting methods and program examples when setting parameters with a sequence program.

Before using the program examples introduced in this chapter in an actual system, fully check that there is no problem in control on the target system.

For the QJ71MB91, parameters can be also set on-screen using the utility package (GX Configurator-MB). (→ CHAPTER 8)

9.1 Parameter Setting

9.1.1 Automatic communication parameters

(1) Automatic communication parameter setting method

Set the automatic communication parameters with sequence program as follows.

- 1) Store parameters in the Automatic communication parameter area of the buffer memory (address: 0200_H to 037F_H/0380_H to 04FF_H).
- 2) Turn ON the Automatic communication parameter setting request/Automatic communication start request (Y4/YC).

(2) I/O signals used for automatic communication parameter setting

The automatic communication parameters are set using the following I/O signals.

Table9.1 I/O signals used for automatic communication parameter setting

Signal		Signal name
CH1	CH2	
X0		Module READY ON : Accessible OFF : Not accessible
X4	XC	Automatic communication parameter setting, normally completed ON : Normally completed OFF : -
X5	XD	Automatic communication parameter setting, error completed ON : Error completed OFF : -
X6	XE	Automatic communication operation status ON : Operating OFF : Stopped
X10		Intelligent function module switch setting change status ON : Setting being changed OFF : Setting not changed
Y4	YC	Automatic communication parameter setting request/Automatic communication start request ON : Being requested OFF : No requested

(3) Timing charts for automatic communication parameter setting

(a) When completed normally

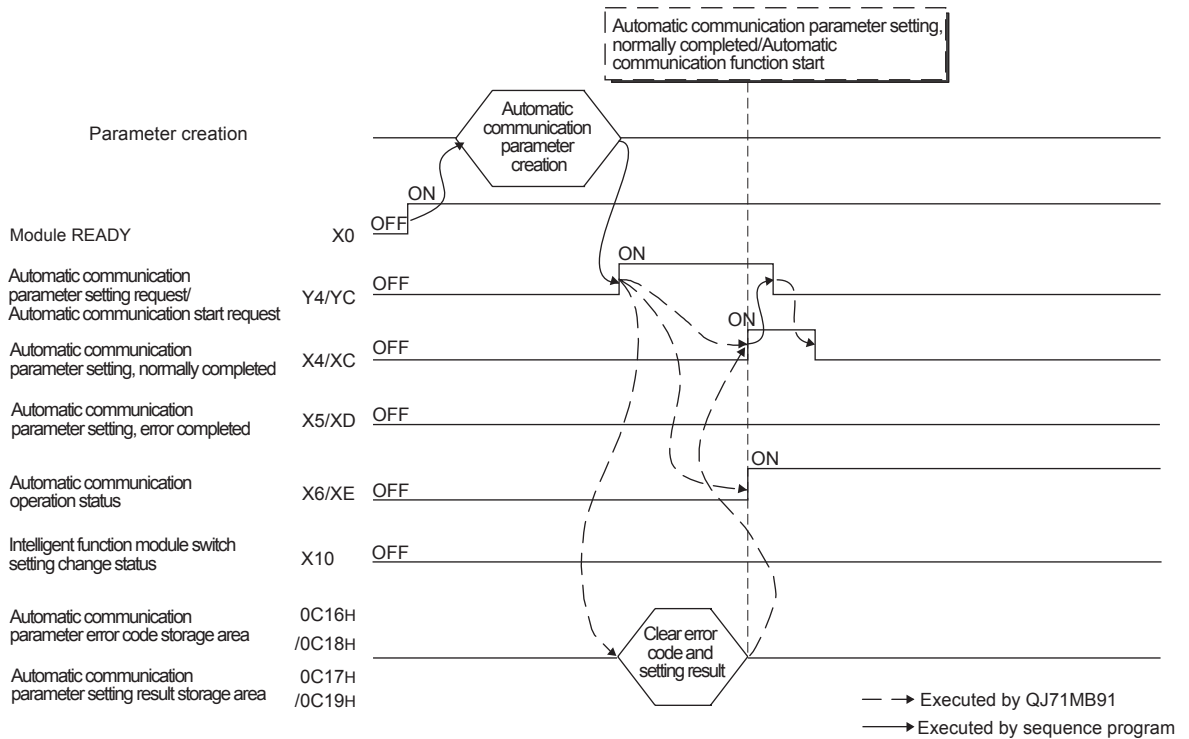

Figure 9.1 Timing chart for automatic communication parameter setting (Normal completion)

(b) When completed with an error

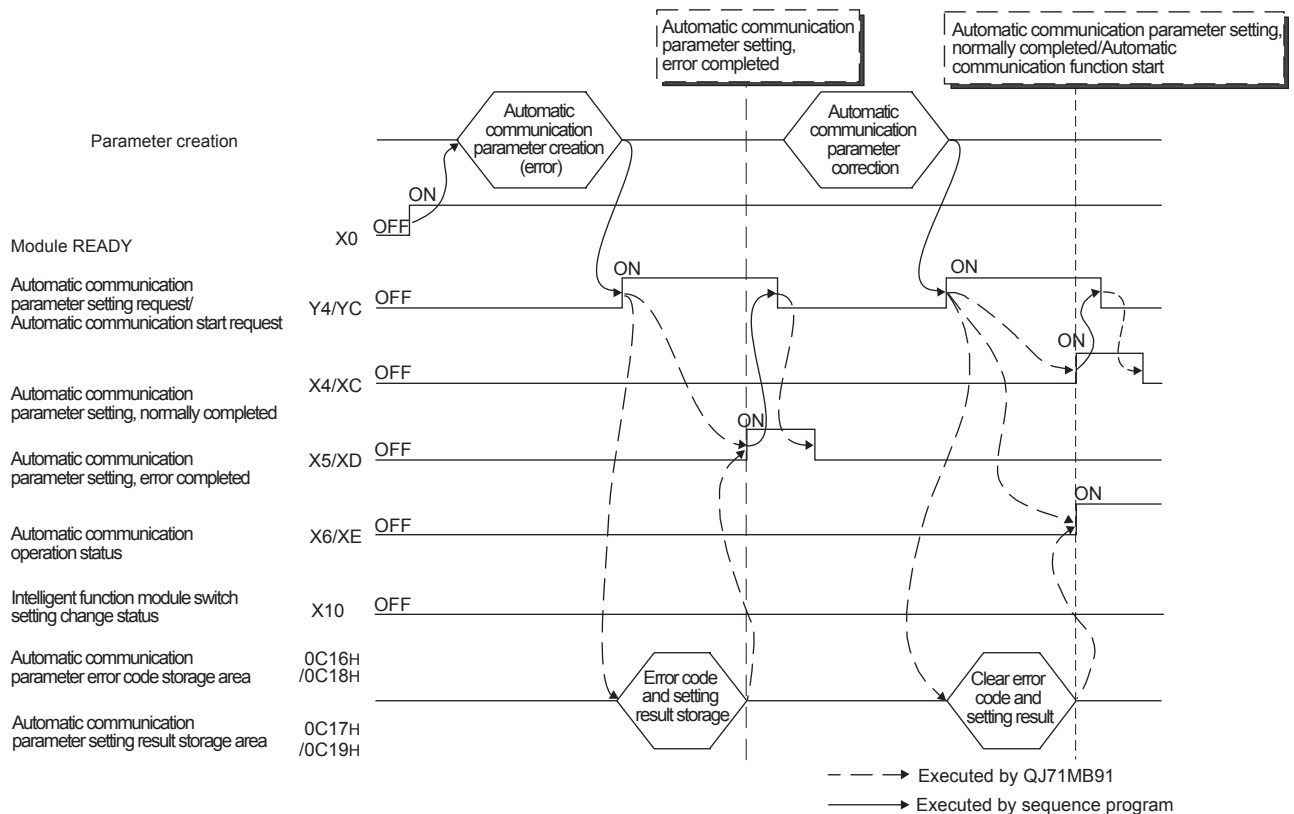

Figure 9.2 Timing chart for automatic communication parameter setting (Error completion)

(4) Precautions for automatic communication parameter setting

- (a) When turning ON the Automatic communication parameter setting request/
Automatic communication start request (Y4/YC)

Make sure both of the following input signal conditions are satisfied.

- Condition 1: Module READY (X0) is ON.
- Condition 2: Intelligent function module switch setting change status (X10) is OFF.

- (b) When automatic communication parameter setting completes with an error
The erroneous automatic communication parameter is stored in the Automatic communication parameter setting result storage area of the buffer memory (address: 0C17_H/0C19_H), and an error code is stored in the Automatic communication parameter error code storage area (address: 0C16_H/0C18_H). Identify the stored parameter, check the error code and take corrective actions. Then make the parameter setting request again. (→ Section 11.4)

- (c) Clearing the automatic communication function buffer
The Automatic communication function buffer input area (address: 1000_H to 1FFF_H/2000_H to 2FFF_H) and the Automatic communication function buffer output area (address: 3000_H to 3FFF_H/4000_H to 4FFF_H) used for the buffer memory read/write setting are not cleared when the automatic communication function is started.
If necessary, clear these areas by a sequence program.

9.1.2 MODBUS(R) device assignment parameters

(1) MODBUS® device assignment parameter setting method

Set the MODBUS® device assignment parameters with sequence program as follows.

- 1) Store MODBUS® device assignment parameters in the following buffer memories.

Table9.2 MODBUS® device assignment parameter storage location

Address	Name	Reference
000AH to 000BH (10 to 11)	Setting error status read device	Section 7.3.4
000DH (13)	CPU response monitoring timer value	Section 7.3.6
000EH (14)	Access target (when mounted to MELSECNET/H remote I/O station)	Section 7.3.5
0900H to 09FFH (2304 to 2559)	MODBUS® device assignment parameter	Section 7.3.1

- 2) Turn ON the MODBUS® device assignment parameter setting request (Y8).

(2) I/O signals used for MODBUS® device assignment parameter setting

Use the following I/O signals for MODBUS® device assignment parameter setting.

Table9.3 I/O signals used for MODBUS® device assignment parameter setting

Signal	Signal name
X0	Module READY ON : Accessible OFF : Not accessible
X8	MODBUS® device assignment parameter setting, normally completed ON : Normally completed OFF : -
X9	MODBUS® device assignment parameter setting, error completed ON : Error completed OFF : -
XA	MODBUS® device assignment parameter setting existence ON : Parameters set OFF : No parameters set
X10	Intelligent function module switch setting change status ON : Setting being changed OFF : Setting not changed
Y8	MODBUS® device assignment parameter setting request ON : Being requested OFF : Not requested

(3) Timing charts for MODBUS® device assignment parameter setting

(a) When completed normally

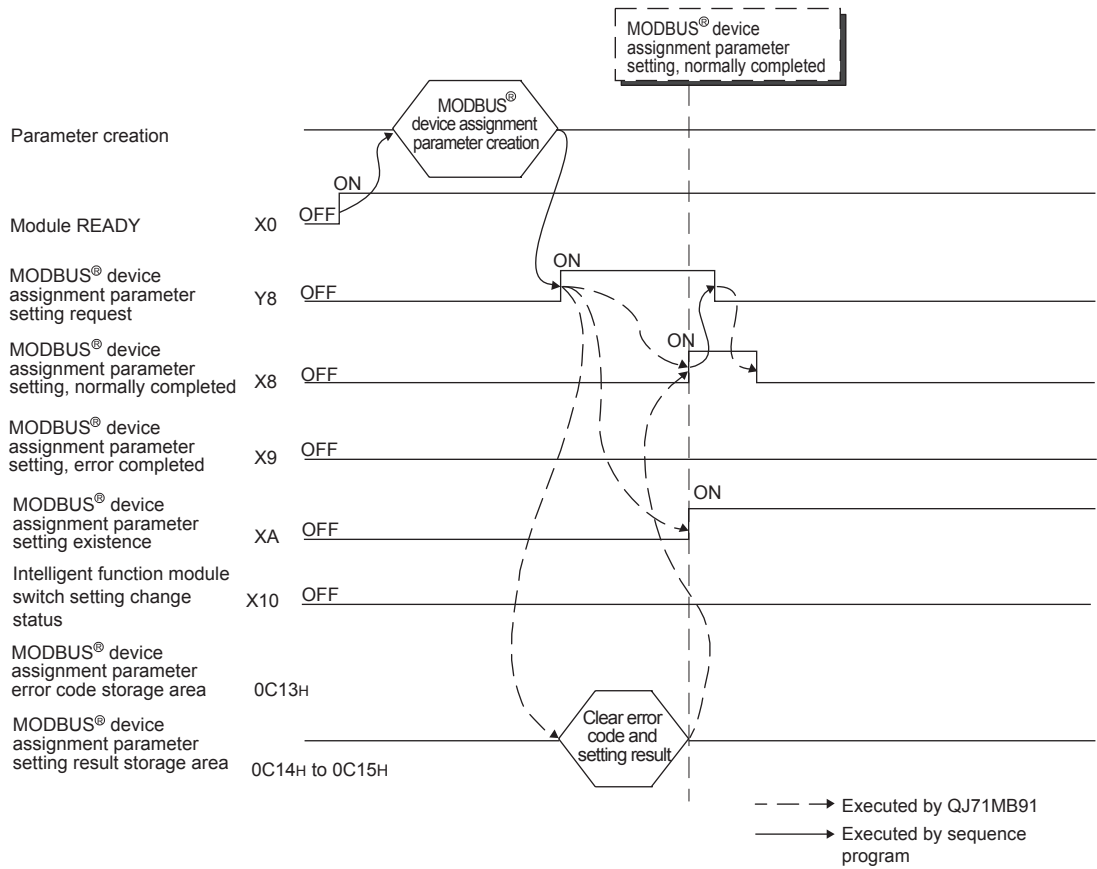

Figure 9.3 Timing chart for MODBUS® device assignment parameter setting (Normal completion)

(b) When completed with an error

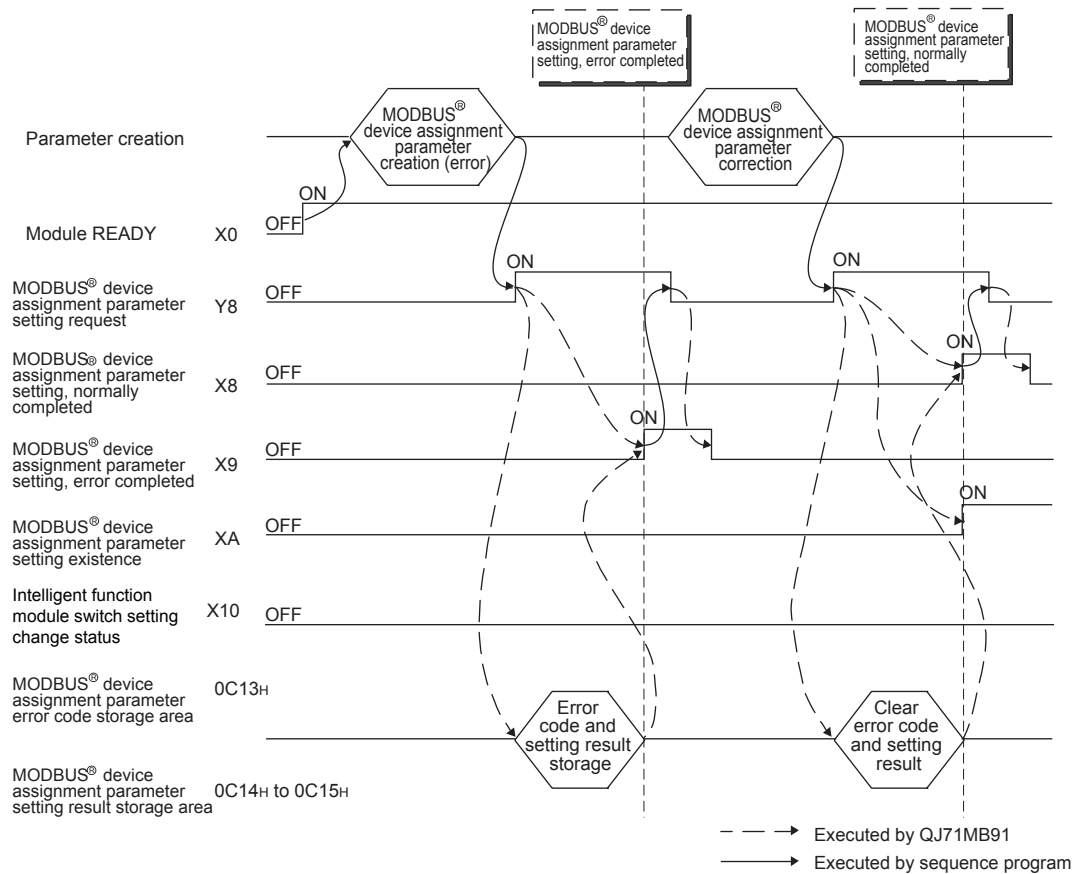

Figure 9.4 Timing chart for MODBUS[®] device assignment parameter setting (Error completion)

(4) Precautions for MODBUS[®] device assignment parameter setting

(a) Before setting MODBUS[®] device assignment parameters

When using a sequence program to set MODBUS[®] device assignment parameters, perform the following in the intelligent function module switch setting.

( Section 6.6)

1) Set the MODBUS[®] device assignment parameter starting method to "User setting parameter".

2) Set the slave function to either channel 1 or 2 in the mode setting.

If the MODBUS[®] device assignment parameter setting request (Y8) is turned ON with both channels 1 and 2 set to the master function, the operation mode error (error code: 7353H) will occur.

(b) When turning ON the MODBUS[®] device assignment parameter setting request (Y8)

Make sure both of the following input signal conditions are satisfied.

- Condition 1: Module READY (X0) is ON.
- Condition 2: Intelligent function module switch setting change status (X10) is OFF.

(c) When the MODBUS[®] device assignment parameter setting, error completed (X9) is turned ON

Correct the parameters by the following procedure.

1) Refer to the MODBUS[®] device assignment parameter setting result storage area (address: 0C14_H to 0C15_H) to identify the erroneous parameter. ( Section 11.4.1)

2) Refer to the MODBUS[®] device assignment parameter error code storage area (address: 0C13_H) to check the error details, and correct the relevant parameter. ( Section 11.4.1)

3) Execute the MODBUS[®] device assignment parameter setting request again.

(d) MODBUS[®] device assignment parameter setting existence

The MODBUS[®] device assignment parameter setting existence (XA) turns ON even if some default parameters exist.

(e) When a request message has been received before normal setting completion

The QJ71MB91 sends an error response (exception code: 04_H) to the master if it received from the master the read/write request message to a MODBUS[®] device before normal completion of the MODBUS[®] device assignment parameter setting.

(f) Resetting MODBUS[®] device assignment parameters

MODBUS[®] device assignment parameters in sequence programs can be reset at any timing after the QJ71MB91 is powered on.

9.2 Program Example for Normal System Configuration

9.2.1 Automatic communication parameters

(1) System configuration

The following system configuration is used to explain a program example for setting the automatic communication parameters.

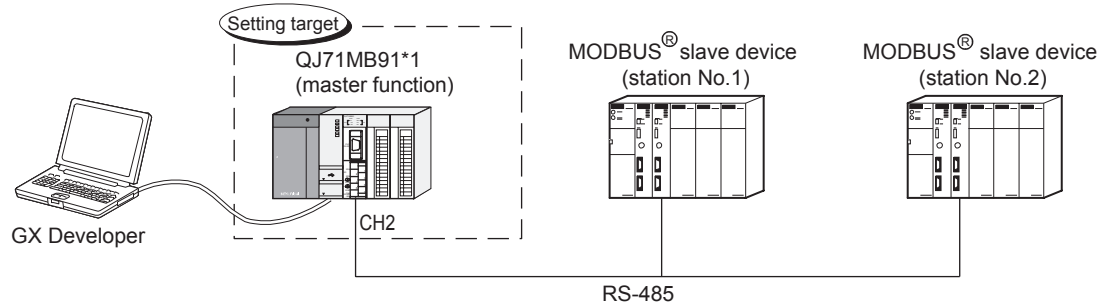

Figure 9.5 System configuration example for the automatic communication parameter setting

* 1 The QJ71MB91 is to be mounted in slot 0 of the base unit with the head I/O number set to "00H".

(2) Communications

Data are exchanged between the QJ71MB91 and MODBUS® slave devices (station No.1 and No.2) using the automatic communication function.

(a) Automatic communication parameter setting diagram

Set automatic communication parameters to the QJ71MB91.

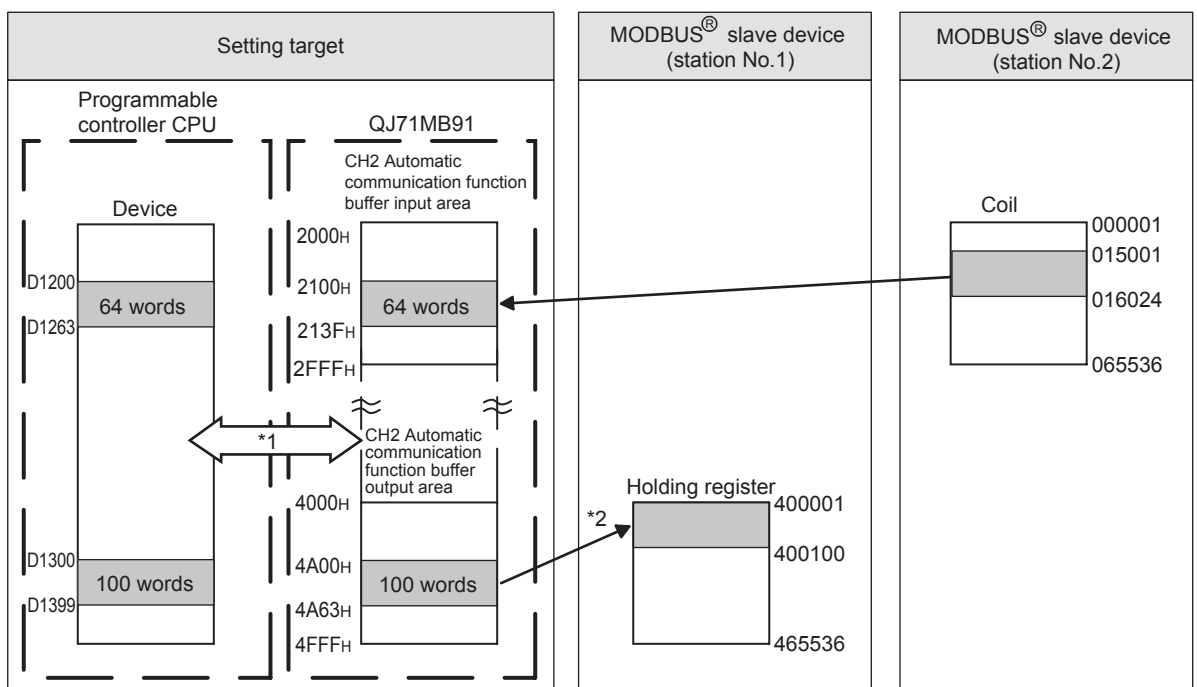

Figure 9.6 Communications with the automatic communication parameters set

* 1 Data can be transferred between the automatic communication function buffer and the programmable controller CPU devices by either of the following methods:

- Transfer by the auto refresh setting (☞ This section (3) (c))
- Transfer by using intelligent function module devices (Un\G□) (☞ This section (4) (b))

* 2 Automatic communication parameters are set from GX Configurator-MB or a sequence program.

(b) Settings

The following automatic communication parameters are set for the program example.

Table9.4 Automatic communication parameter settings

Setting item		Buffer memory address	Setting value	
CH2 automatic communication parameter 1	Setting parameter existence	0380 _H to 0381 _H (896 to 897)	1 _H	
	Target station No.	0382 _H (898)	2	
	Request interval timer value	0383 _H (899)	600 (6s)	
	Response monitoring timer value	0384 _H (900)	500 (5s)	
	Type specification of the target MODBUS [®] device	0385 _H (901)	0100 _H (Read coils)	
	Read setting	Head buffer memory address	0386 _H (902)	2100 _H
		Target MODBUS [®] device head number	0387 _H (903)	15000
Access points		0388 _H (904)	1024	
CH2 automatic communication parameter 2	Setting parameter existence	038C _H to 038D _H (908 to 909)	1 _H	
	Target station No.	038E _H (910)	1	
	Request interval timer value	038F _H (911)	0 (Issue request immediately after receiving response from slave.)	
	Response monitoring timer value	0390 _H (912)	500 (5s)	
	Type specification of the target MODBUS [®] device	0391 _H (913)	0005 _H (Write holding registers)	
	Write setting	Head buffer memory address	0395 _H (917)	4A00 _H
		Target MODBUS [®] device head number	0396 _H (918)	0
Access points		0397 _H (919)	100	

(3) Parameter settings

The following setting is required to perform the communication shown in (2).

(a) Intelligent function module switch setting

Set the intelligent function module switches for the setting target, QJ71MB91, as shown below. (☞ Section 6.6)

1) When using GX Configurator-MB

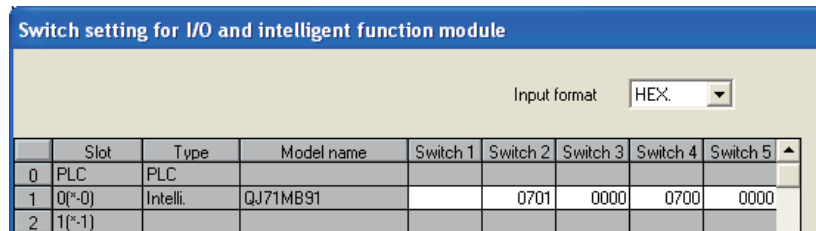

Figure 9.7 Intelligent function module switch setting (When using GX Configurator-MB)

2) When not using GX Configurator-MB

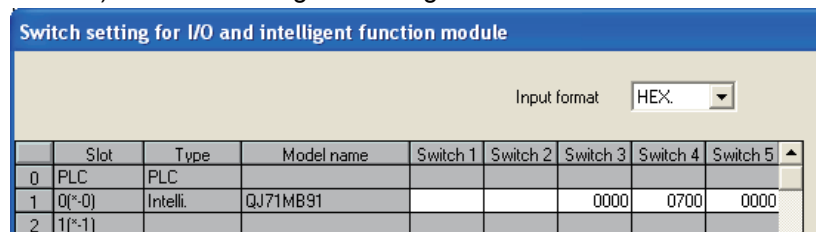

Figure 9.8 Intelligent function module switch setting (When not using GX Configurator-MB)

(b) Automatic communication parameter

1) When using GX Configurator-MB

Set CH2 Automatic communication parameters in the Initial setting of GX Configurator-MB. (☞ Section 8.4.1)

Set the values shown in the settings. (☞ This section (2) (b))

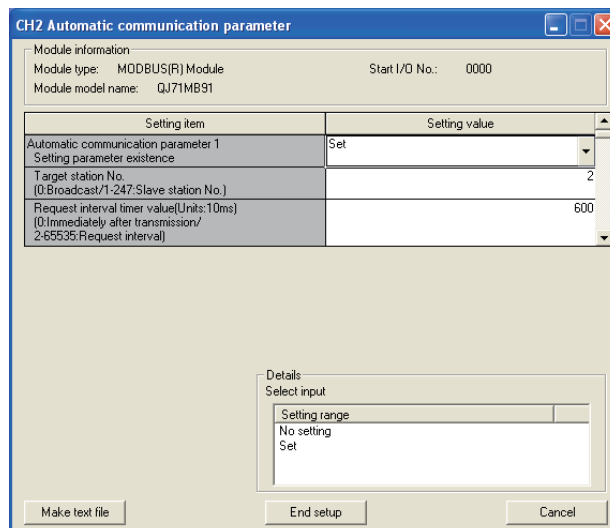

Figure 9.9 Automatic communication parameter

2) When not using GX Configurator-MB

Set automatic communication parameters from the sequence program.

(☞ This section (4) (a))

(c) Auto refresh setting

Configure the following auto refresh setting on GX Configurator-MB.

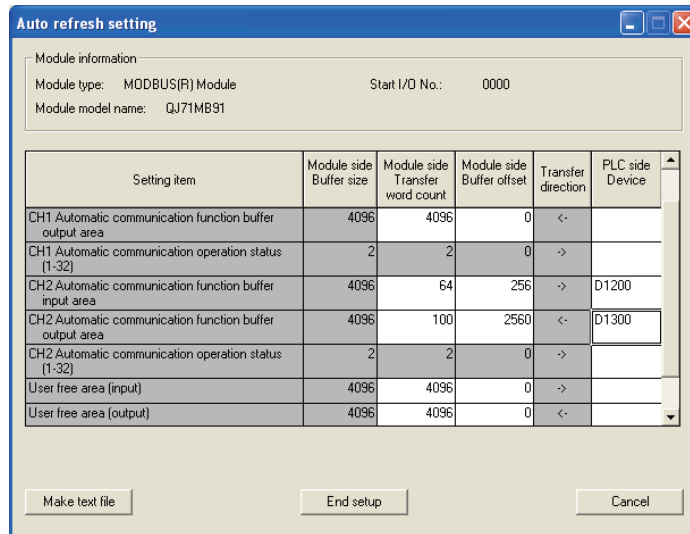

Figure 9.10 Auto refresh setting

Remark

When not using GX Configurator-MB, program the processing equivalent to the auto refresh setting using intelligent function module devices.

(☞ This section (4) (b))

(4) Program example

The following is an example of the sequence program required to perform the communication shown in (2).

(a) Program example for automatic communication parameter setting

The program example is shown below.

When automatic communication parameters are set from GX Configurator-MB, this program is not required.

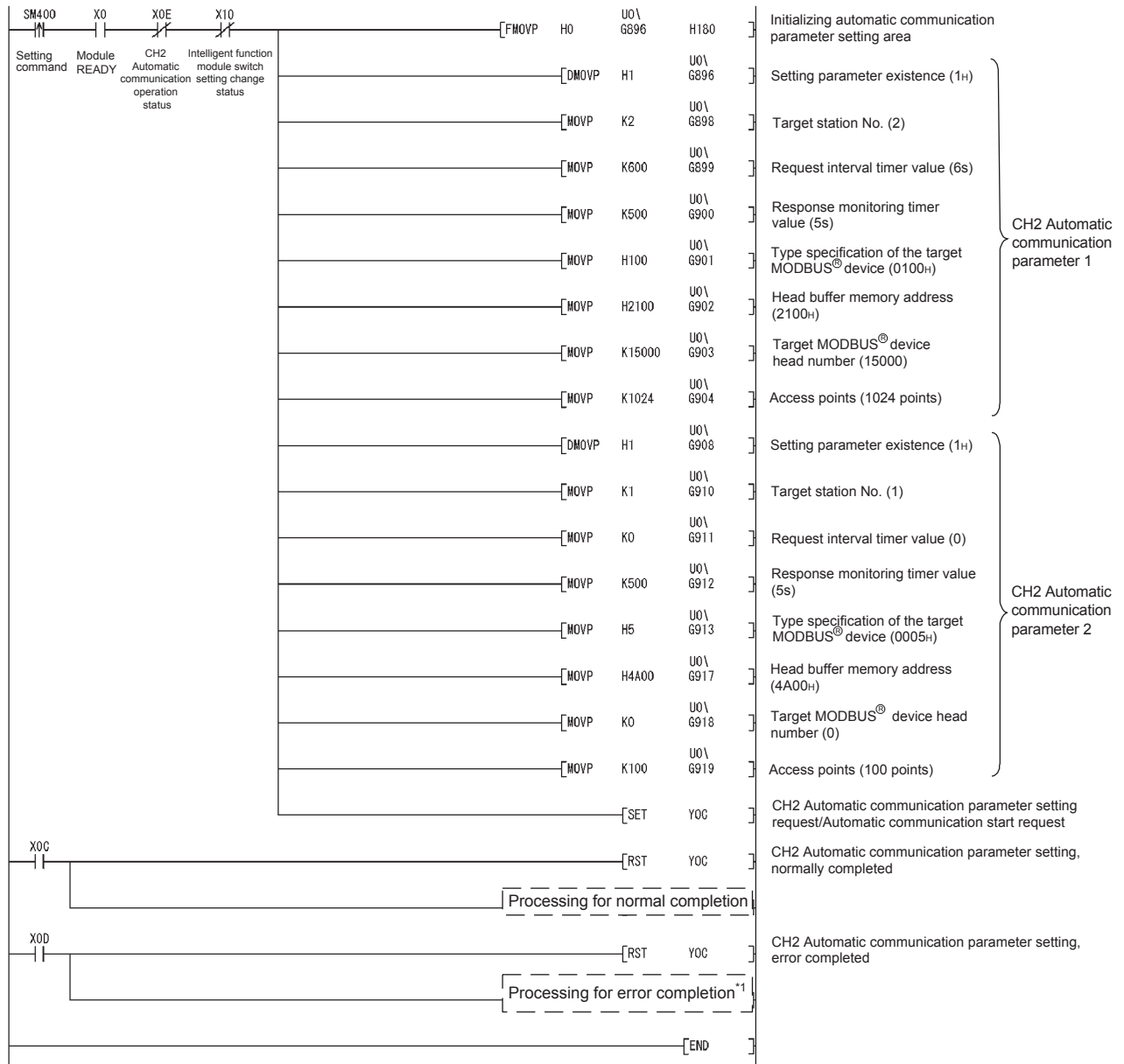
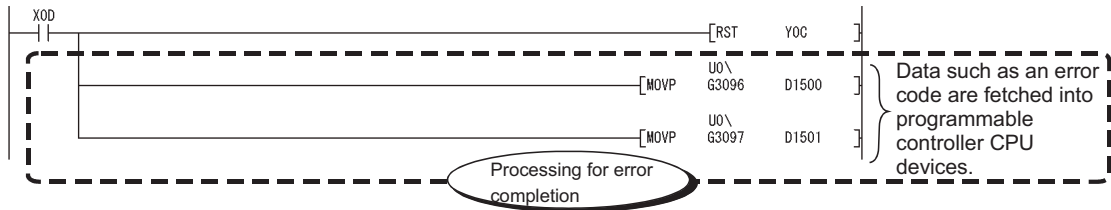

Figure 9.11 Automatic communication parameter setting program example

* 1 The following is a processing example for error completion.

From the QJ71MB91 buffer memory (address: 0C18H to 0C19H), the programmable controller CPU obtains data such as an error code identified at the time of automatic communication parameter setting.



Data to be stored in the programmable controller CPU are as follows:

- D1500: CH2 Automatic communication parameter error code
- D1501: CH2 Automatic communication parameter setting result

Figure 9.12 Program example for error completion of automatic communication parameters

(b) Program example for data transfer between QJ71MB91 and programmable controller CPU

The program example is shown below.

When data transfer between the QJ71MB91 and programmable controller CPU is set in the Auto refresh setting of GX Configurator-MB, this program is not required.

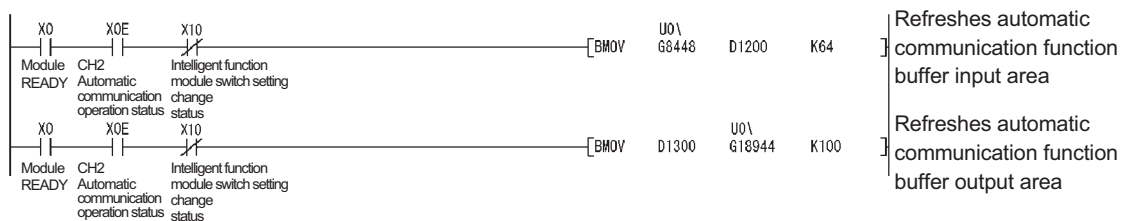

Figure 9.13 Program example for data transfer between QJ71MB91 and programmable controller CPU

9.2.2 MODBUS(R) device assignment parameters

(1) System configuration

The following system configuration is used to explain a program example for setting the MODBUS® device assignment parameters to the QJ71MB91.

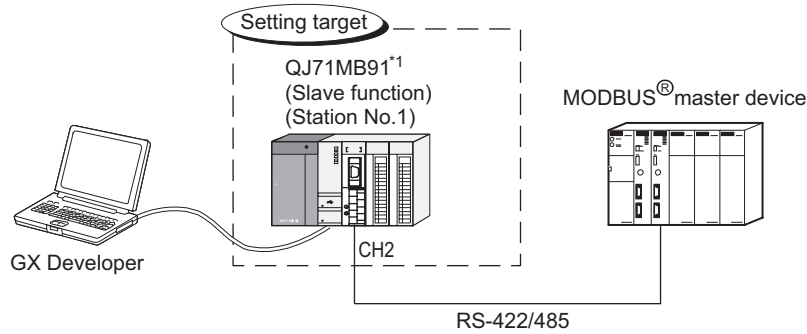

Figure 9.14 System configuration example for the MODBUS® device assignment parameter setting

* 1 The QJ71MB91 is to be mounted in slot 0 of the base unit with the head I/O number set to "00H".

(2) Communications

In the program example shown in this section, the following MODBUS® device assignment parameters are set for the setting target, QJ71MB91.

(a) MODBUS® device assignment parameter assignment diagram

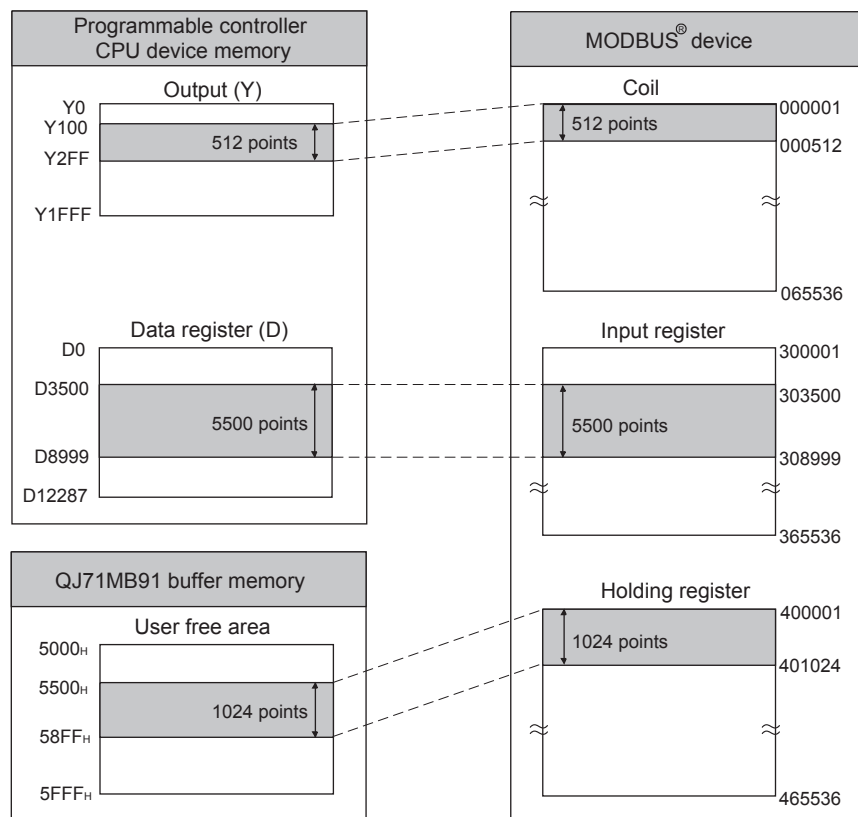

Figure 9.15 MODBUS® device assignment diagram

(b) Settings

Table9.5 MODBUS® device assignment parameter settings

Setting item		Buffer memory address	Setting value
Coil assignment 1	Device code	0900 _H (2304)	009D _H (Y: Output)
	Head device number	0901 _H (2305)	0100 _H
	Head coil number	0902 _H (2306)	0 (000001)
	Assignment points	0903 _H (2307)	512 (points)
Input register assignment 1	Device code	0980 _H (2432)	00A8 _H (D: Data register)
	Head device number	0981 _H (2433)	3500
	Head input register number	0982 _H (2434)	3499 (303500)
	Assignment points	0983 _H (2435)	5500 (points)
Holding register assignment 1	Device code	09C0 _H (2496)	F000 _H (User free area)
	Head device number	09C1 _H (2497)	5500 _H
	Head holding register number	09C2 _H (2498)	0 (400001)
	Assignment points	09C3 _H (2499)	1024 (points)

(3) Parameter settings

The following setting is required to perform the communication shown in (2).

(a) Intelligent function module switch setting

Set the intelligent function module switches for the setting target, QJ71MB91, as shown below. (☞ Section 6.6)

	Slot	Type	Model name	Switch 1	Switch 2	Switch 3	Switch 4	Switch 5
0	PLC	PLC						
1	0[*-0]	Intelli	QJ71MB91		0701	0001	0740	0100
2	1[*-1]							

Figure 9.16 Intelligent function module switch setting

(b) MODBUS® device assignment parameter

1) When using GX Configurator-MB

Set MODBUS® device assignment parameter in the Initial setting of GX Configurator-MB. (☞ Section 8.4.2)

Set the values shown in the settings. (☞ This section (2) (b))

Setting item	Setting value
Coil assignment 1 Device	Y100
Head coil number (Specify "Actual device No. -1".)	0
Assignment points	512
Coil assignment 2 Device	
Head coil number (Specify "Actual device No. -1".)	0
Assignment points	0
Coil assignment 3 Device	

Details
Device input
Setting range
SM
X
Y
M

Figure 9.17 MODBUS® device assignment parameter

2) When not using GX Configurator-MB

Set MODBUS® device assignment parameter from the sequence program.

(☞ This section (4))

(4) Program example

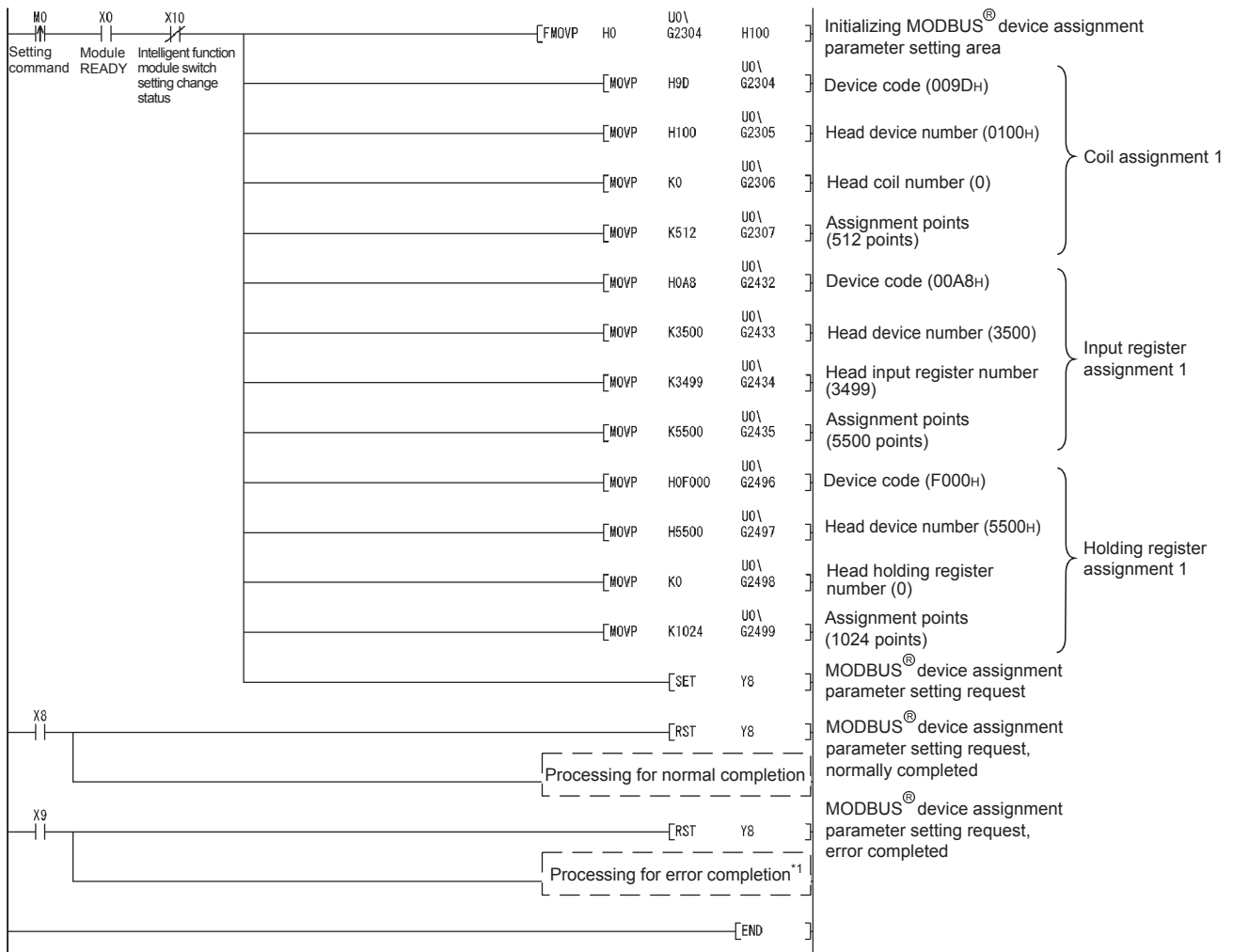
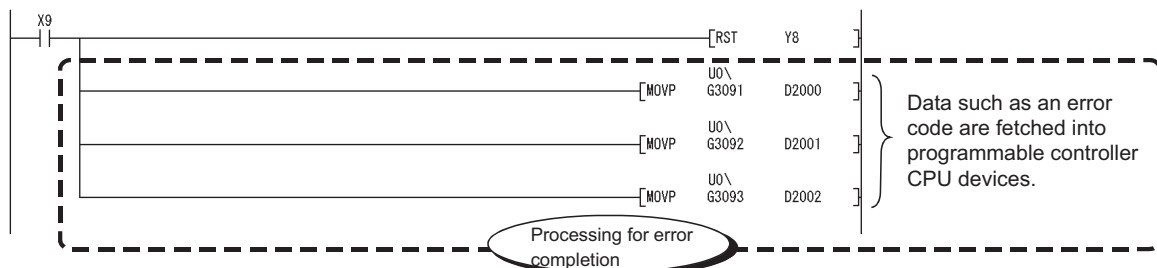

Figure 9.18 MODBUS® device assignment parameter setting program example

* 1 The following is a processing example for error completion.

From the QJ71MB91 buffer memory (address: 0C13H to 0C15H), the programmable controller CPU obtains data such as an error code identified at the time of MODBUS® device assignment parameter setting.



Data to be stored in the programmable controller CPU are as follows:

- D2000: MODBUS® device assignment parameter error code
- D2001: Error, device type
- D2002: Error, assigned group No.

Figure 9.19 Program example for error completion of MODBUS® device assignment parameters

9.2.3 When using the automatic communication function and the communication by dedicated instructions on the same channel

This section explains the setting and programming for using the automatic communication function and the communication by dedicated instructions (MBRW and MBREQ instructions) on the same channel.

(1) System configuration

In the following system configuration, the automatic communication parameter and dedicated instructions shall be used on the same channel.

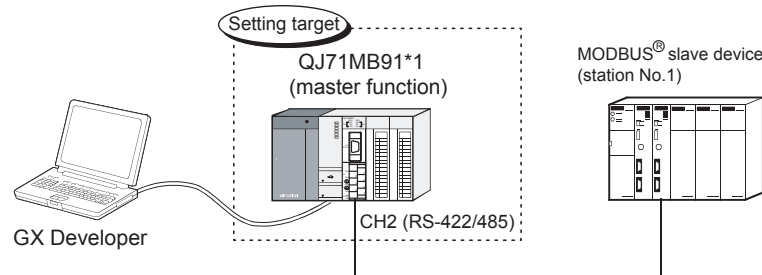

Communicated by automatic communication function + dedicated instructions

Figure 9.20 System configuration example for use of the automatic communication function and dedicated instructions on the same channel

* 1 The QJ71MB91 is to be mounted in slot 0 of the base unit with the head I/O No. set to "0".

(2) Dedicated instruction execution timing

Dedicated instructions can be executed at the timing shown below.

When using the automatic communication function and dedicated instructions on the same channel, set an appropriate request interval timer value and create a proper program so that dedicated instructions can be executed in the right timing. (☞ This section (3))

Example: When automatic communication parameters 1 to 3 are set

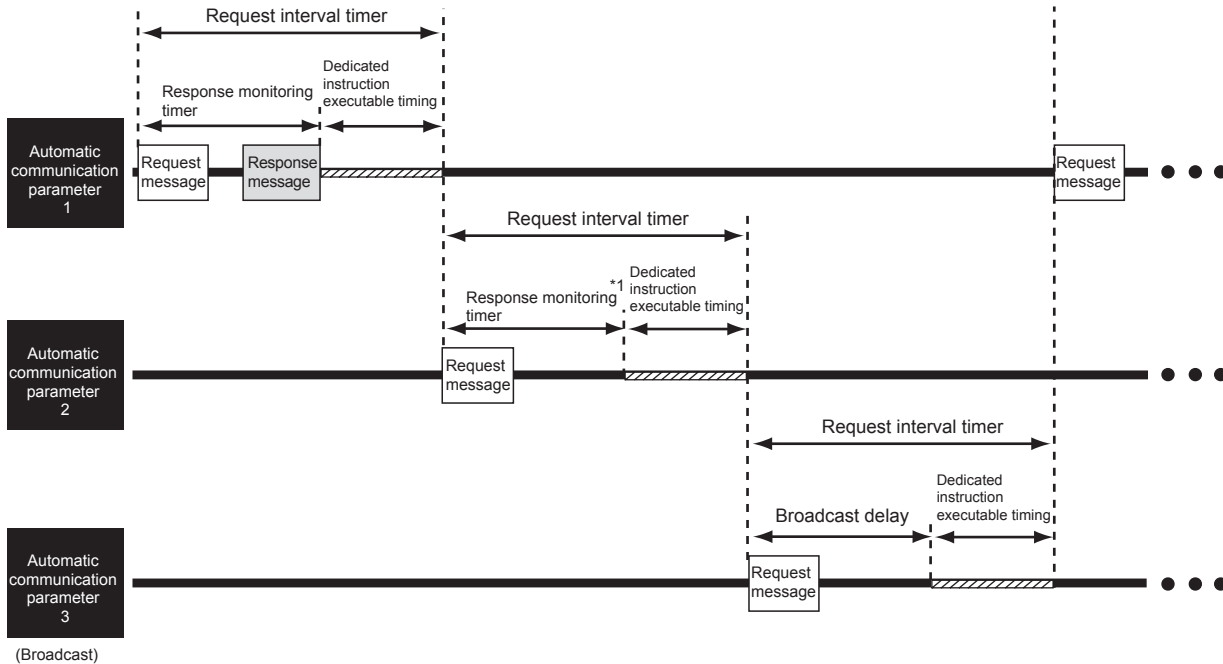

Figure 9.21 Dedicated instruction execution timing

* 1 Shows the case that the response monitoring timer has timed out due to no response from the target slave

(3) Method for normally executing dedicated instructions

(Step 1)

Make setting in at least one of the automatic communication parameters so that the time for dedicated instruction execution can be ensured. (☞ This section

(4) (a))

(Step 2)

Design the program so that dedicated instructions will be executed in the standby status of the automatic communications set in the above (Step 1). (☞ This section (4) (b))

(4) Setting and programming for normal execution of dedicated instructions

- (a) Setting the request interval timer of the automatic communication parameter
Set the request interval timer to ensure the timing for dedicated instruction execution.

When setting the request interval timer, the following condition must be satisfied:

$$\text{Request interval timer[ms]} \geq \text{Tarb} + \text{Tdrb} + \text{St} + 10\text{ms}^{*1}$$

Table9.6 Calculation items for the request interval timer

Setting item	Description	Unit
Tarb	Response monitoring timer value/Broadcast delay value for the automatic communication function ^{*2}	ms
Tdrb	Response monitoring timer value/Broadcast delay value for dedicated instructions ^{*3*4}	ms
St	Local station scan time	ms

* 1 The result of Tarb+Tdrb+St is rounded up in 10ms units.

* 2 Set a value greater than the automatic communication function communication time (Tac). (Appendix 3)

* 3 Set a value greater than the dedicated instruction processing time (Trc). (Appendix 3)

* 4 To execute multiple dedicated instructions consecutively within the reserved time, totalize the response monitoring timer values/broadcast delay values for the number of the dedicated instructions to be executed.

POINT

The request interval timer is set only for the automatic communication parameters by which dedicated instructions are to be executed at appropriate timing.
All the request interval timers in the automatic communication parameters need not to satisfy the (4) (a) condition.

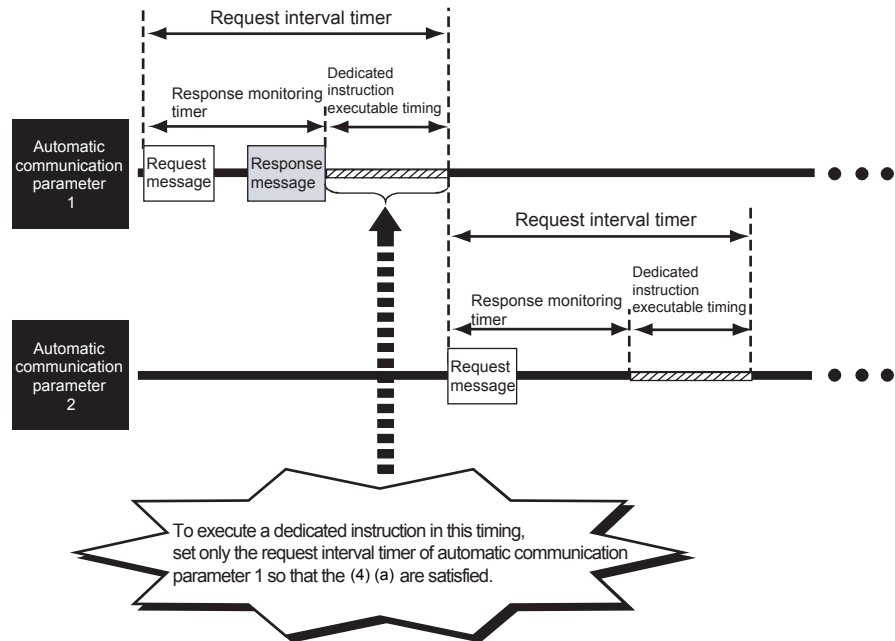

(b) Executing a dedicated instruction during automatic communication function ready status

Use the Automatic communication ready status storage area of buffer memory (address: 0CB0H/0CB2H to 0CB1H/0CB3H) to program so that the dedicated instruction is executed at the rise of the corresponding bit.

1) Automatic communication ready status storage area

The automatic communication ready status can be confirmed.

(CH1 Automatic communication ready status storage area)

	b15	b14	b13	b12	b11	b10	...	b5	b4	b3	b2	b1	b0
0CB0H	16	15	14	13	12	11	...	6	5	4	3	2	1
0CB1H	32	31	30	29	28	27	...	22	21	20	19	18	17

(CH2 Automatic communication ready status storage area)

	b15	b14	b13	b12	b11	b10	...	b5	b4	b3	b2	b1	b0
0CB2H	16	15	14	13	12	11	...	6	5	4	3	2	1
0CB3H	32	31	30	29	28	27	...	22	21	20	19	18	17

Number indicates that of automatic communication parameter.

0: Communicating by automatic communication function, or automatic communication function stopped
 1: Ready for automatic communication *1

Figure 9.22 Configuration of automatic communication ready status storage area

* 1 "Ready" represents "the time during which dedicated instructions are executable" that is shown in the figure in (2).

2) Program example for dedicated instruction

This section provides an program example in which a dedicated instruction (MBRW) is executed while automatic communication of Automatic communication parameter 1 on channel 2 is in ready status.

In the program example on the next page, the following device read/write is executed to the holding register on the slave (Station No. 1) on channel 2.

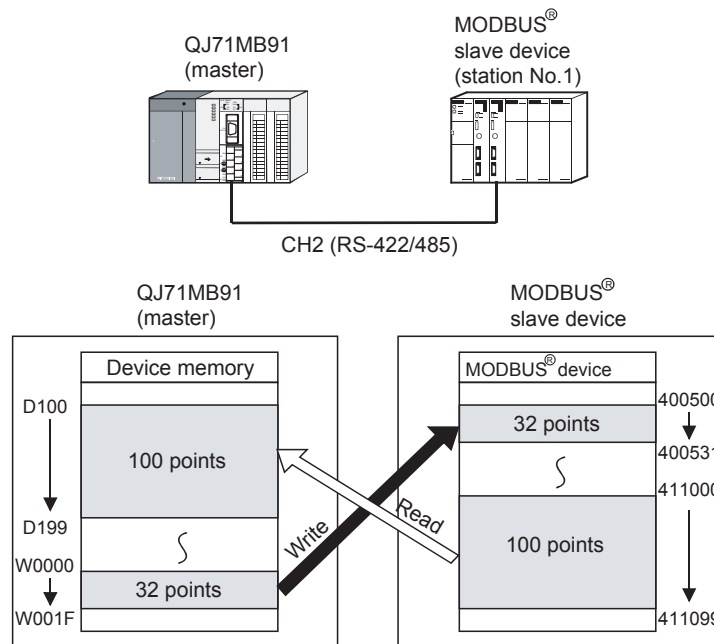

Figure 9.23 Processing of program example

(Continued on next page)

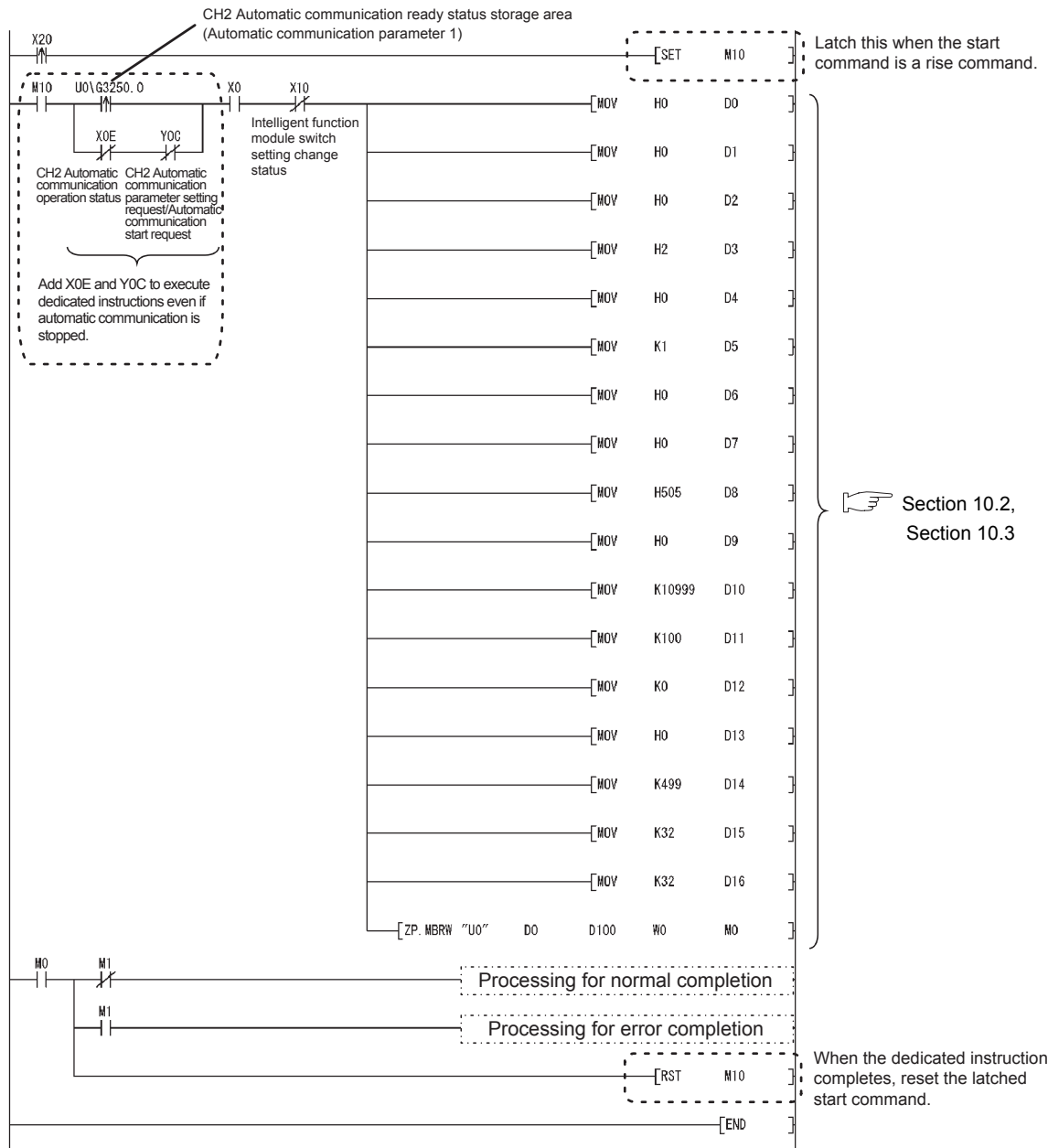

Figure 9.24 Program example for executing dedicated instruction during ready status of automatic communication parameter 1 on channel 2

POINT

When using the automatic communication function and dedicated instructions on the same channel, add the above section to the sequence program. (Perform the same in the case of the MBREQ instruction)

9.3 Program Examples for Use in MELSECNET/H Remote I/O Network

9.3.1 Automatic communication parameters

(1) System configuration

This section provides a program example for setting the automatic communication parameters to the QJ71MB91 on a MELSECNET/H remote I/O station in the following system configuration.

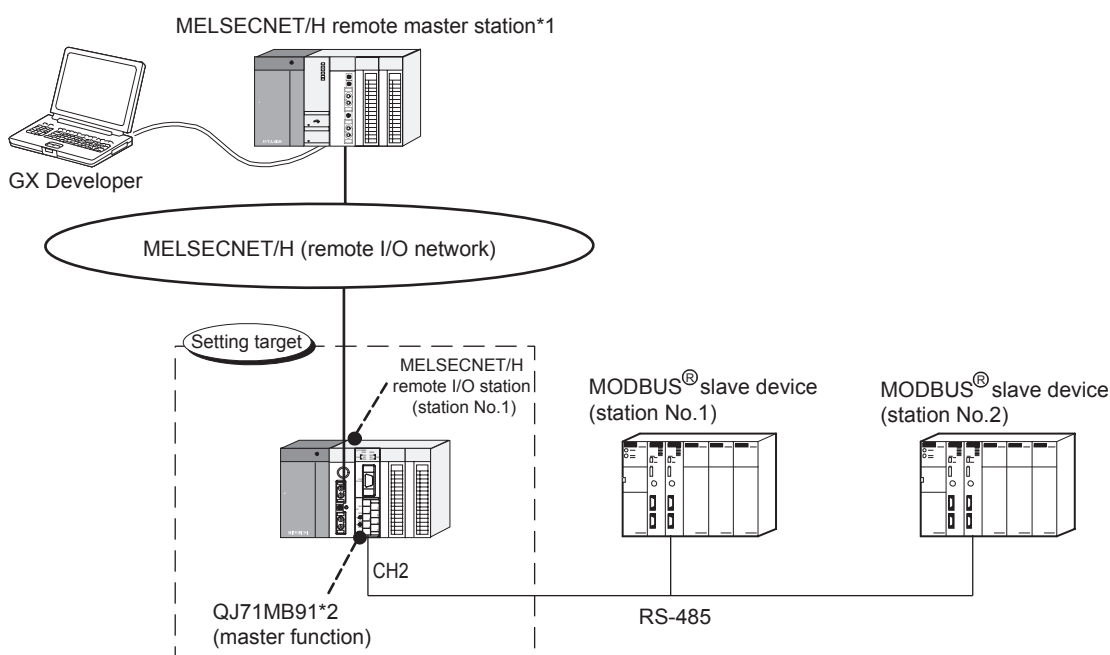

Figure 9.25 System configuration example for the automatic communication parameter setting

* 1 The MELSECNET/H remote master station is installed in slot 0 of the base unit with the start I/O No. set as "00H".

* 2 The QJ71MB91 is to be mounted in slot 0 of the base unit with the head I/O No. set to "40H".

Remark

For details on construction and parameter setting of the MELSECNET/H remote I/O network, refer to the following manual.

☞ Q Corresponding MELSECNET/H Network System Reference Manual (Remote I/O network)

(2) Communications

Data are exchanged between the QJ71MB91 and MODBUS® slave devices (station No. 1 and No. 2) using the automatic communication function.

The following shows communications performed when using and not using GX Configurator-MB.

(a) Automatic communication parameter setting diagram

1) When using GX Configurator-MB

Communication data in the QJ71MB91 are transferred to the programmable controller CPU on the MELSECNET/H remote master station as shown below.

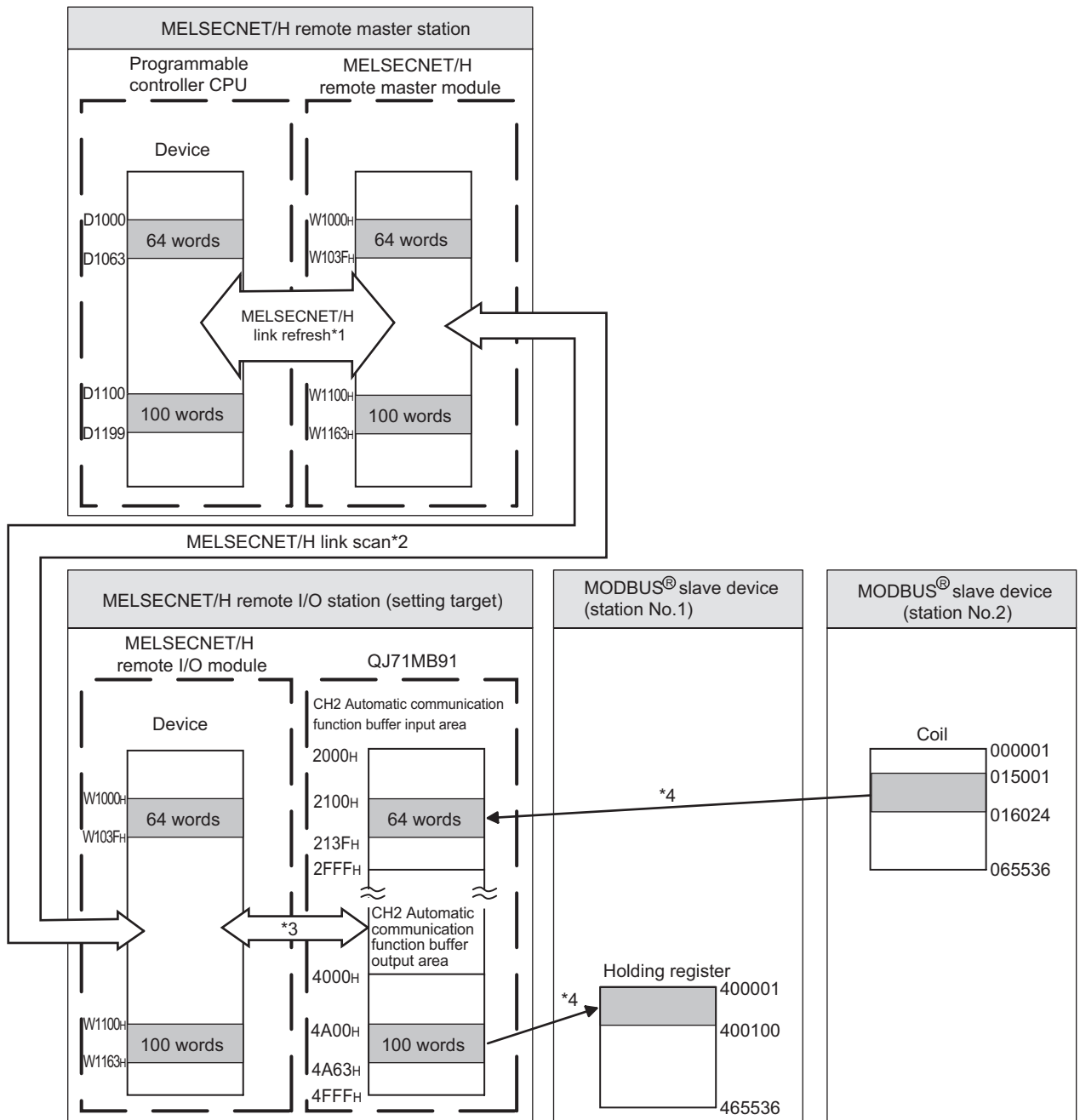





Figure 9.26 Communications (When using GX Configurator-MB)

- * 1 Set the MELSECNET/H link refresh by refresh parameters in the network parameters.
( This section (3) (b))
- * 2 Set the MELSECNET/H link scan by the network range assignment in the network parameters.
( This section (3) (b))
- * 3 By the auto refresh setting of GX Configurator-MB, transfer the automatic communication function buffer area data to the MELSECNET/H remote I/O module. ( This section (3) (d))
- * 4 Automatic communication parameters are set from GX Configurator-MB.
( This section (3) (c))

2) When not using GX Configurator-MB

The automatic communication function buffer area data in the QJ71MB91 are transferred to the programmable controller CPU on the MELSECNET/H remote master station with the REMTO/REMFR instruction.

I/O signals are transferred by MELSECNET/H link refresh and MELSECNET/H link scan.

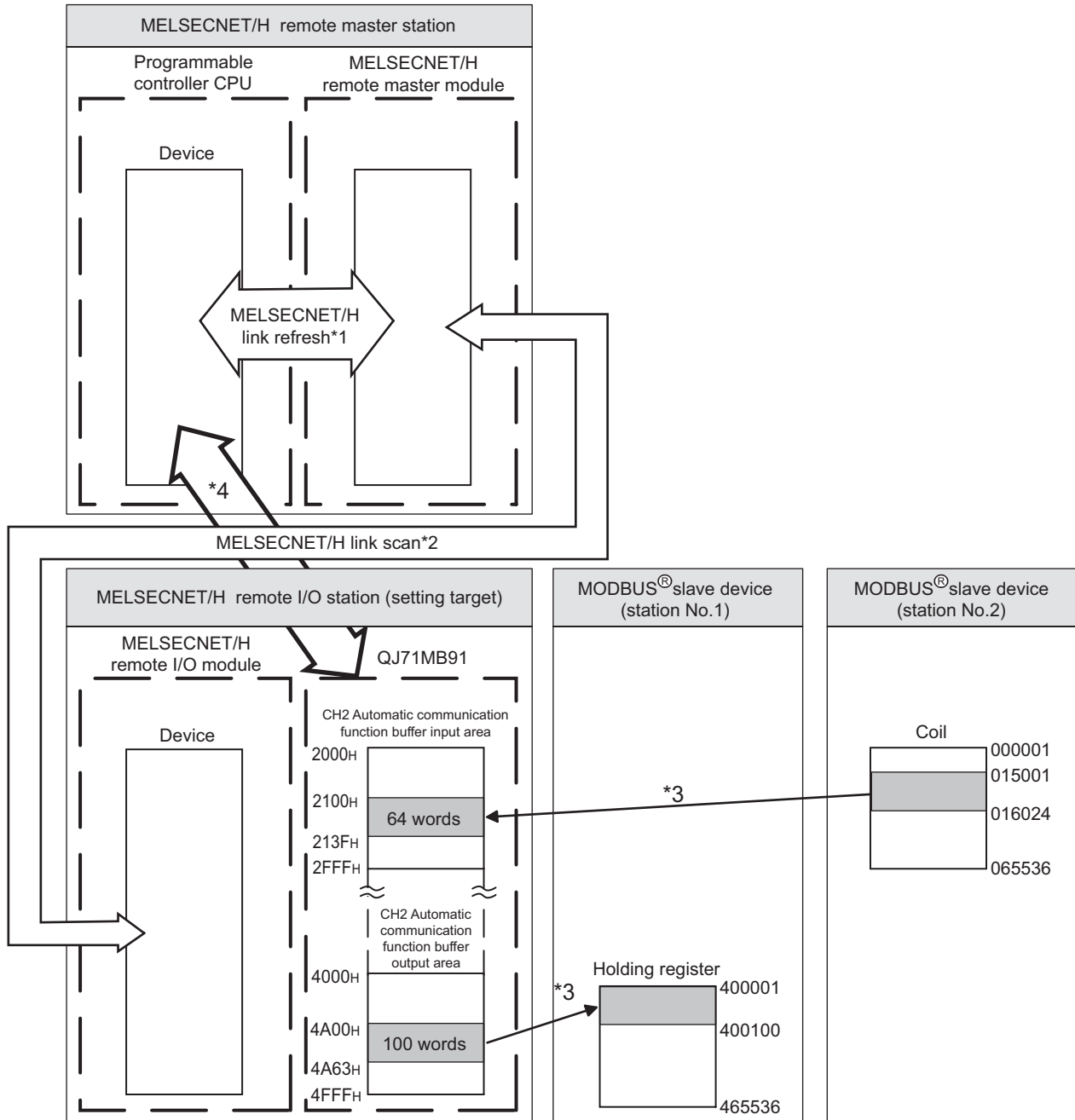

Figure 9.27 Communications (When not using GX Configurator-MB)

- * 1 Set the MELSECNET/H link refresh by refresh parameters in the network parameters. (☞ This section (3) (b))
- * 2 Set the MELSECNET/H link scan by the network range assignment in the network parameters. (☞ This section (3) (b))
- * 3 Automatic communication parameters are set from sequence program. (☞ This section (4))
- * 4 The automatic communication function buffer area data in the QJ71MB91 are transferred to the programmable controller CPU on the MELSECNET/H remote master station with the REMTO/REMFR instruction. (☞ This section (4))

(b) Settings

Table9.7 Automatic communication parameter settings

Setting item		Buffer memory address	Setting value	
CH2 automatic communication parameter 1	Setting parameter existence	0380 _H to 0381 _H (896 to 897)	1 _H	
	Target station No.	0382 _H (898)	2	
	Request interval timer value	0383 _H (899)	600 (6 s)	
	Response monitoring timer value	0384 _H (900)	500 (5 s)	
	Type specification of the target MODBUS [®] device	0385 _H (901)	0100 _H (Read coils)	
	Read setting	Head buffer memory address	0386 _H (902)	2100 _H
		Target MODBUS [®] device head number	0387 _H (903)	15000
Access points		0388 _H (904)	1024	
CH2 automatic communication parameter 2	Setting parameter existence	038C _H to 038D _H (908 to 909)	1 _H	
	Target station No.	038E _H (910)	1	
	Request interval timer value	038F _H (911)	0 (Issue request immediately after receiving response from slave.)	
	Response monitoring timer value	0390 _H (912)	500 (5 s)	
	Type specification of the target MODBUS [®] device	0391 _H (913)	0005 _H (Write holding registers)	
	Write setting	Head buffer memory address	0395 _H (917)	4A00 _H
		Target MODBUS [®] device head number	0396 _H (918)	0
Access points		0397 _H (919)	100	

(3) Parameter settings

The following setting is required to perform the communication shown in (2).

(a) Intelligent function module switch setting

Set the intelligent function module switches for the setting target, QJ71MB91, as shown below. (☞ Section 6.6)

1) When using GX Configurator-MB

Switch setting for I/O and intelligent function module								
Input format: HEX.								
Slot	Type	Model name	Switch 1	Switch 2	Switch 3	Switch 4	Switch 5	
0	Remote I/O	Remote I/O						
1	0(*-0)	Intelli.	QJ71MB91		0701	0000	0740	0000
2	1(*-1)							

Figure 9.28 Intelligent function module switch setting (When using GX Configurator-MB)

2) When not using GX Configurator-MB

Switch setting for I/O and intelligent function module								
Input format: HEX.								
Slot	Type	Model name	Switch 1	Switch 2	Switch 3	Switch 4	Switch 5	
0	Remote I/O	Remote I/O						
1	0(*-0)	Intelli.	QJ71MB91			0000	0740	0000
2	1(*-1)							

Figure 9.29 Intelligent function module switch setting (When not using GX Configurator-MB)

(b) Network parameter

Set the following network parameters for the MELSECNET/H remote master station by GX Developer.

- 1) Network type : MNET/H (Remote master)
- 2) Starting I/O No. : 0000H
- 3) Network No. : 1
- 4) Total stations : 1
- 5) Mode : On line
- 6) Network range assignment

• When using GX Configurator-MB

StationNo.	M station -> R station			M station <- R station			M station -> R station			M station <- R station		
	Points	Start	End	Points	Start	End	Points	Start	End	Points	Start	End
1							100	1100	1163	64	1000	103F

StationNo.	M station -> R station			M station <- R station			M station -> R station			M station <- R station		
	Points	Start	End	Points	Start	End	Points	Start	End	Points	Start	End
1	256	1000	10FF	256	0000	00FF	256	1000	10FF	256	0000	00FF

Figure 9.30 Network range assignment (When using GX Configurator-MB)

- When not using GX Configurator-MB

Start/End		Total slave stations	1	Switch screens	XY setting							
StationNo.	M station -> R station						M station <- R station					
	Y			Y			X			X		
	Points	Start	End	Points	Start	End	Points	Start	End	Points	Start	End
1	256	1000	10FF	256	0000	00FF	256	1000	10FF	256	0000	00FF

Figure 9.31 Network range assignment (When not using GX Configurator-MB)

7) Refresh parameters

- When using GX Configurator-MB

	Link side					PLC side			
	Dev. name	Points	Start	End		Dev. name	Points	Start	End
Transfer SB	SB	512	0000	01FF	↔	SB	512	0000	01FF
Transfer S'W	S'W	512	0000	01FF	↔	S'W	512	0000	01FF
Random cyclic	LB				↔				
Random cyclic	LW				↔				
Transfer1	LW	64	1000	103F	↔	D	64	1000	1063
Transfer2	LW	100	1100	1163	↔	D	100	1100	1199
Transfer3	LX	256	1000	10FF	↔	X	256	1000	10FF
Transfer4	LY	256	1000	10FF	↔	Y	256	1000	10FF
Transfer5					↔				

Figure 9.32 Refresh parameters (When using GX Configurator-MB)

- When not using GX Configurator-MB

	Link side					PLC side			
	Dev. name	Points	Start	End		Dev. name	Points	Start	End
Transfer SB	SB	512	0000	01FF	↔	SB	512	0000	01FF
Transfer S'W	S'W	512	0000	01FF	↔	S'W	512	0000	01FF
Random cyclic	LB				↔				
Random cyclic	LW				↔				
Transfer1	LX	256	1000	10FF	↔	X	256	1000	10FF
Transfer2	LY	256	1000	10FF	↔	Y	256	1000	10FF
Transfer3					↔				
Transfer4					↔				
Transfer5					↔				

Figure 9.33 Refresh parameters (When not using GX Configurator-MB)

- (c) Automatic communication parameter
 - 1) When using GX Configurator-MB
 - Set CH2 Automatic communication parameters in the Initial setting of GX Configurator-MB. (☞ Section 8.4.1)
 - Set the values shown in the settings. (☞ This section (2) (b))

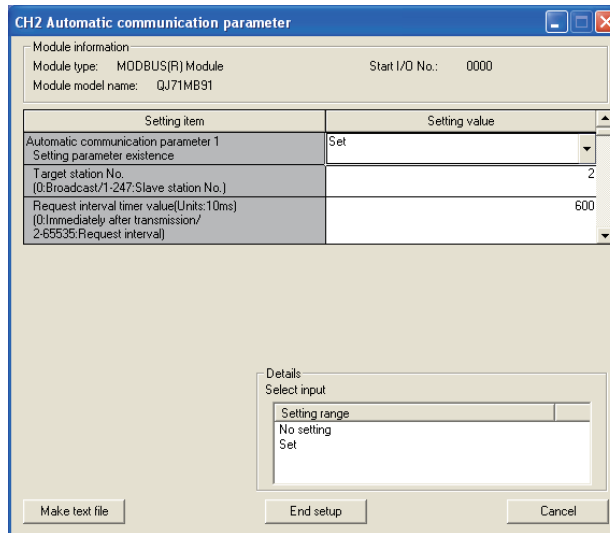

Figure 9.34 CH2 Automatic communication parameter

- 2) When not using GX Configurator-MB
 - Set automatic communication parameters from the sequence program. (☞ This section (4) (b))
- (d) Auto refresh setting
 - Configure the following auto refresh setting on GX Configurator-MB.

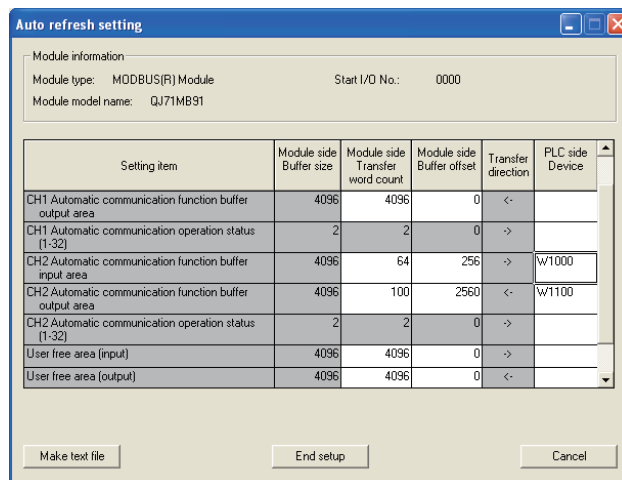

Figure 9.35 Auto refresh setting

Remark

When not using GX Configurator-MB, program the processing equivalent to the auto refresh setting using REMTO/REMFR instructions.

(☞ This section (4) (c))

(4) Program example

The following is an example of the sequence program required to perform the communication shown in (2).

(a) Interlock program example for MELSECNET/H

Provide interlocks using the link status of the MELSECNET/H remote master station (host) and MELSECNET/H remote I/O station (other station).

The example below shows an interlock for a communication program, which uses the link status (SB47, SB49) of the MELSECNET/H remote master station and the link status (SW70, SW74, SW78) of the MELSECNET/H remote I/O station (Station No. 1).

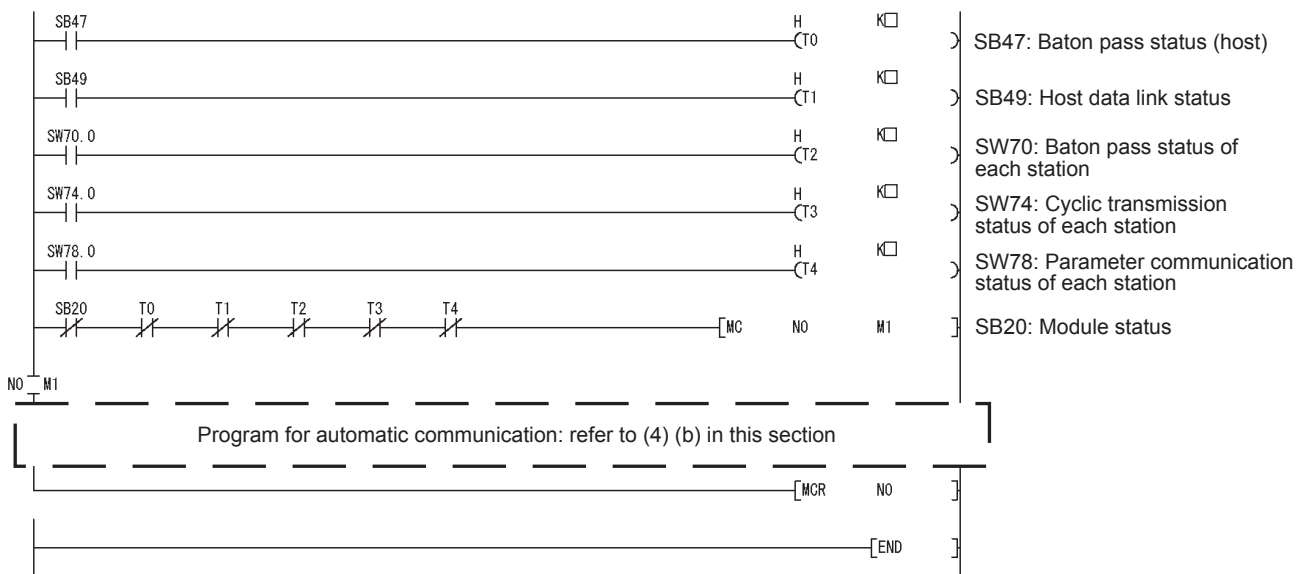

Figure 9.36 Interlock program example for MELSECNET/H

Set the following value as timer constant K□.

Table 9.8 Value of timer constant K

Baton pass status (T0, T2)	(Sequence scan time × 4) or more
Cyclic transmission status Parameter communication status (T1, T3, T4)	(Sequence scan time × 3) or more

Reason: To prevent the control from stopping even if the network detects an instantaneous error due to a cable problem, noise or any other condition

Note that the above "4" and "3" represent standard values.

POINT

For details on interlock programs for the MELSECNET/H remote master station and MELSECNET/H remote I/O station, refer to the following manual.

☞ Q Corresponding MELSECNET/H Network System Reference Manual (Remote I/O network)

(b) Program example for automatic communication parameter setting

The program example is shown below.

When automatic communication parameters are set from GX Configurator-MB, this program is not required.

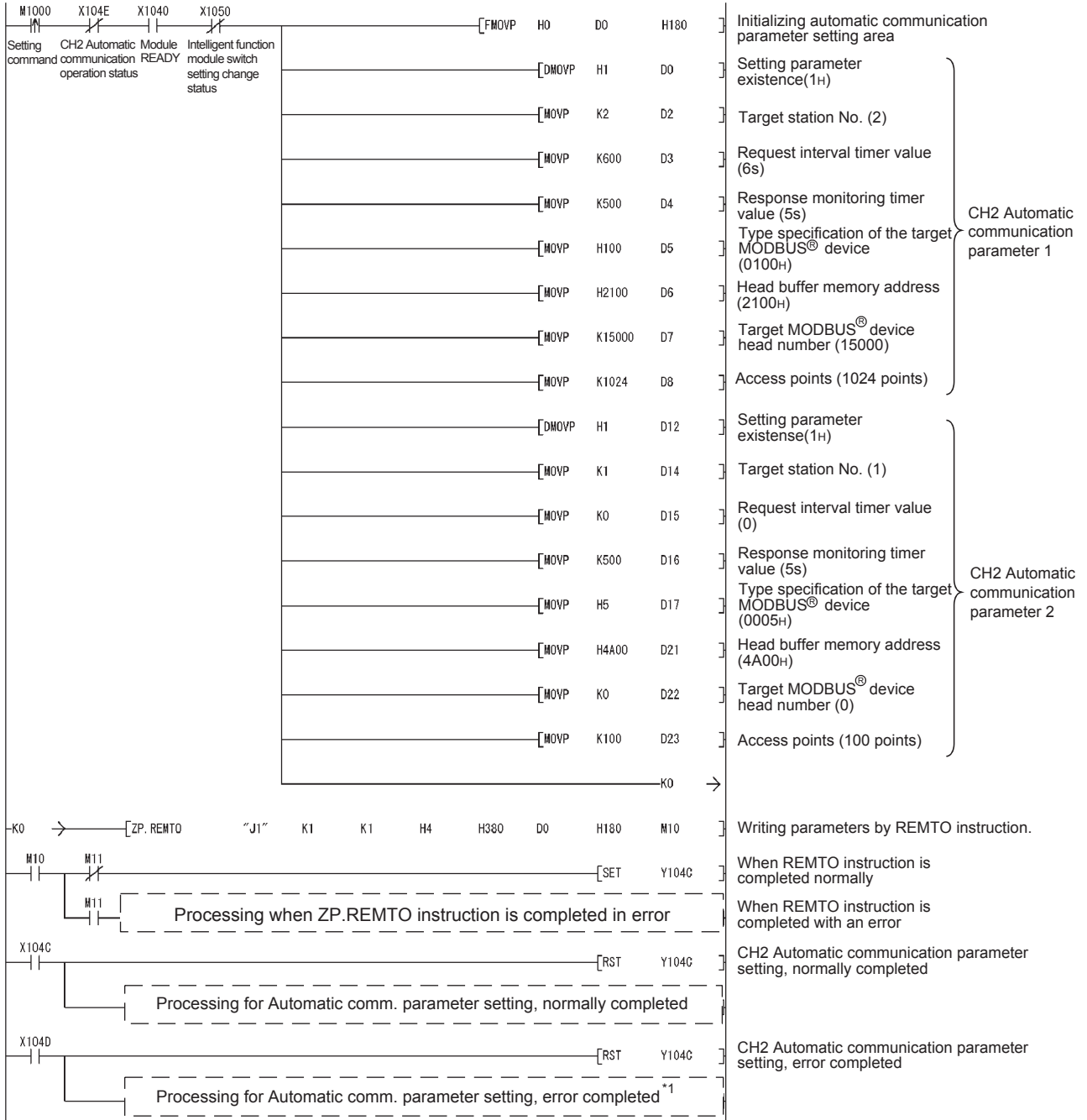
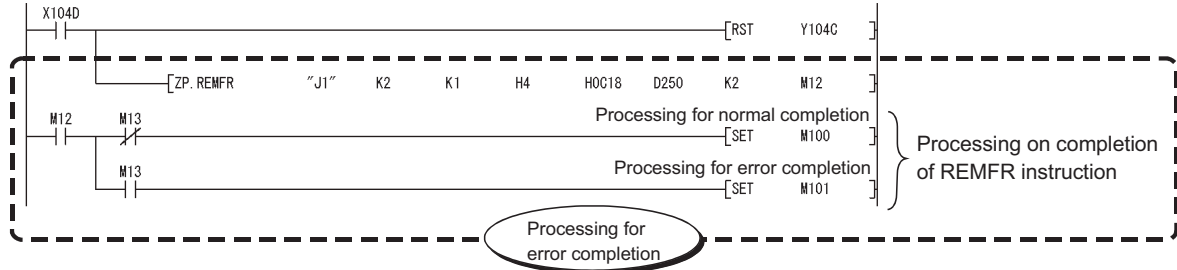

Figure 9.37 Program example when mounted to MELSECNET/H remote I/O station

* 1 The following is a processing example for error completion.

The following is a processing example in which, from the QJ71MB91 buffer memory (address: 0C18H to 0C19H), the programmable controller CPU on the MELSECNET/H remote master station obtains data such as an error code identified in the automatic communication parameter setting.

Figure 9.38 Program example for error completion of automatic communication parameters



The following data are stored in the programmable controller CPU on the MELSECNET/H remote master station:

- D250: CH2 Automatic communication parameter error code
- D251: CH2 Automatic communication parameter setting result

(c) Program example for data transfer between QJ71MB91 and programmable controller CPU

The program example is shown below.

When data transfer between the QJ71MB91 and programmable controller CPU is set in the Auto refresh setting of GX Configurator-MB and network parameter, this program is not required.

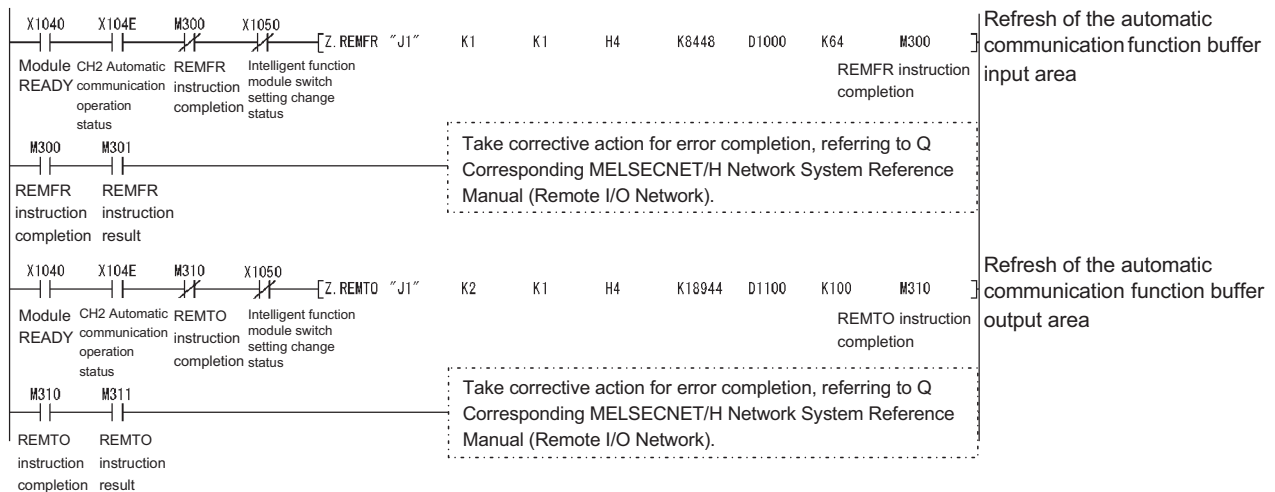

Figure 9.39 Data transfer program example when mounted to MELSECNET/H remote I/O station

POINT

1. After execution of the REMTO/REMFR instruction, several scans are required until the read/write of actual data is completed.
Completion of the REMTO/REMFR instruction can be confirmed by the completion device of the instruction.
2. To set parameters, write the set values to the buffer memory by the REMTO instruction, and then execute the parameter setting request after the completion device of the REMTO instruction turns ON.

Remark

For details of the REMTO instruction and the troubleshooting for error completion of the instruction, refer to the following manual:

- ☞ Q Corresponding MELSECNET/H Network System Reference Manual (Remote I/O network)

9.3.2 MODBUS(R) device assignment parameters

(1) System configuration

The following system configuration is used for the program example in which MODBUS® device assignment parameters are set to the QJ71MB91 on a MELSECNET/H remote I/O station.

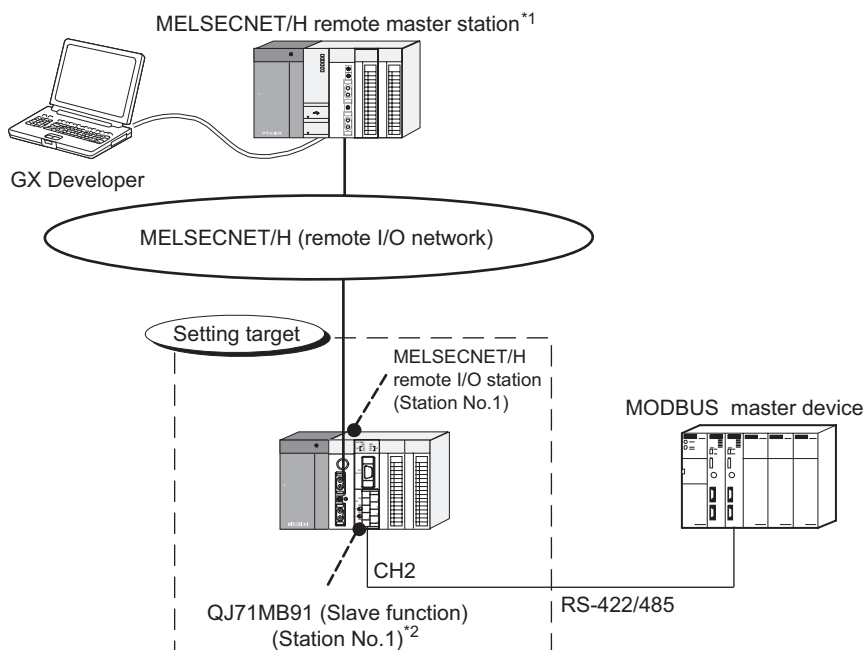

Figure 9.40 System configuration example for the MODBUS® device assignment parameter setting

* 1 The MELSECNET/H remote master station is installed in slot 0 of the base unit with the Start I/O No. set as "00H".

* 2 The QJ71MB91 is to be mounted in slot 0 of the base unit with the head I/O number set to "00H".

Remark

For details on construction and parameter setting of the MELSECNET/H remote I/O network, refer to the following manual.

☞ Q Corresponding MELSECNET/H Network System Reference Manual (Remote I/O network)

(2) Communications

In the program example shown in this section, the following MODBUS® device assignment parameters are set for the setting target, QJ71MB91.

(a) MODBUS® device assignment parameter assignment diagram

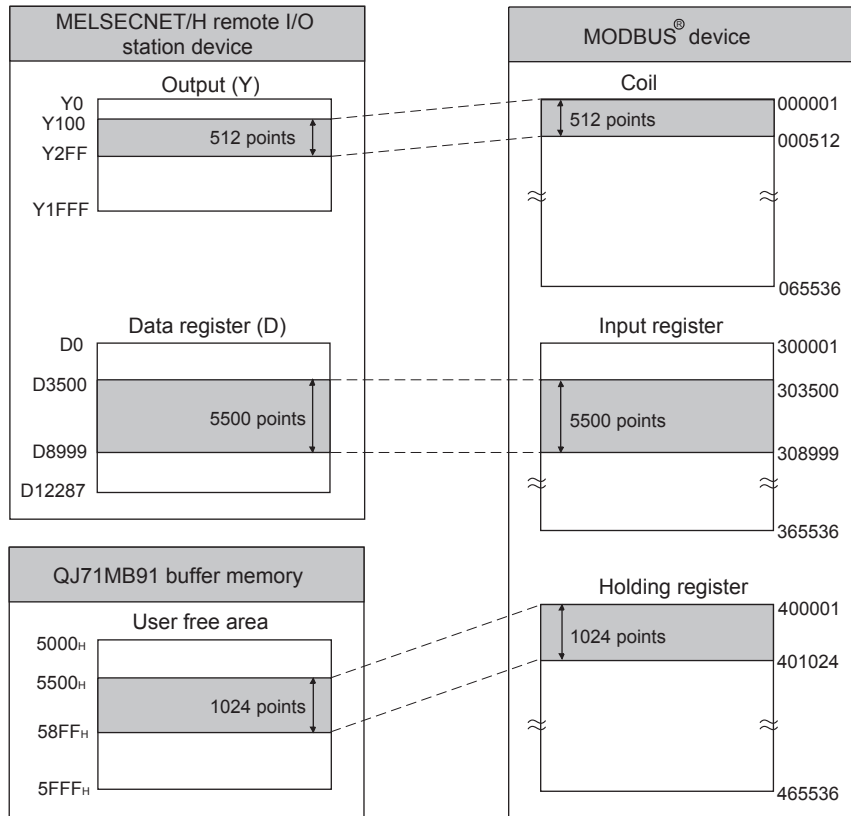

Figure 9.41 MODBUS® device assignment parameter settings

(b) Settings

Table9.9 MODBUS[®] device assignment parameter settings

Setting item		Buffer memory address	Setting value
Coil assignment 1	Device code	0900 _H (2304)	009D _H (Y: Output)
	Head device number	0901 _H (2305)	0100 _H
	Head coil number	0902 _H (2306)	0 (000001)
	Assignment points	0903 _H (2307)	512 (points)
Input register assignment 1	Device code	0980 _H (2432)	00A8 _H (D: Data register)
	Head device number	0981 _H (2433)	3500
	Head input register number	0982 _H (2434)	3499 (303500)
	Assignment points	0983 _H (2435)	5500 (points)
Holding register assignment 1	Device code	09C0 _H (2496)	F000 _H (User free area)
	Head device number	09C1 _H (2497)	5500 _H
	Head holding register number	09C2 _H (2498)	0 (400001)
	Assignment points	09C3 _H (2499)	1024 (points)

(3) Parameter settings

The following setting is required to perform the communication shown in (2).

(a) Intelligent function module switch setting

Set the intelligent function module switches for the setting target, QJ71MB91, as shown below. (☞ Section 6.6)

Slot	Type	Model name	Switch 1	Switch 2	Switch 3	Switch 4	Switch 5
0	Remote I/O	Remote I/O					
1	0(*0)	Intelli.	QJ71MB91	0701	0001	0740	0100
2	1(*1)						

Figure 9.42 Intelligent function module switch setting

(b) Network parameter

Set the following network parameters for the MELSECNET/H remote master station by GX Developer.

- 1) Network type : MNET/H (Remote master)
- 2) Starting I/O No. : 0000H
- 3) Network No. : 1
- 4) Total stations : 1
- 5) Mode : On line
- 6) Network range assignment

StationNo.	M station -> R station						M station <- R station					
	Points	Y	Start	End	Points	Y	Start	End	Points	X	Start	End
1	32	1000	101F	32	0000	001F	32	1000	101F	32	0000	001F

Figure 9.43 Network range assignment

7) Refresh parameters

	Link side					PLC side			
	Dev. name	Points	Start	End		Dev. name	Points	Start	End
Transfer SB	SB	512	0000	01FF	↔	SB	512	0000	01FF
Transfer SW	SW	512	0000	01FF	↔	SW	512	0000	01FF
Random cyclic	LB				↔				
Random cyclic	LW				↔				
Transfer1	LX	32	1000	101F	↔	X	32	1000	101F
Transfer2	LY	32	1000	101F	↔	Y	32	1000	101F
Transfer3					↔				
Transfer4					↔				
Transfer5					↔				

Figure 9.44 Refresh parameters

(c) MODBUS[®] device assignment parameter

1) When using GX Configurator-MB

Set MODBUS[®] device assignment parameter in the Initial setting of GX Configurator-MB. (☞ Section 8.4.2)

Set the values shown in the settings. (☞ This section (2) (b))

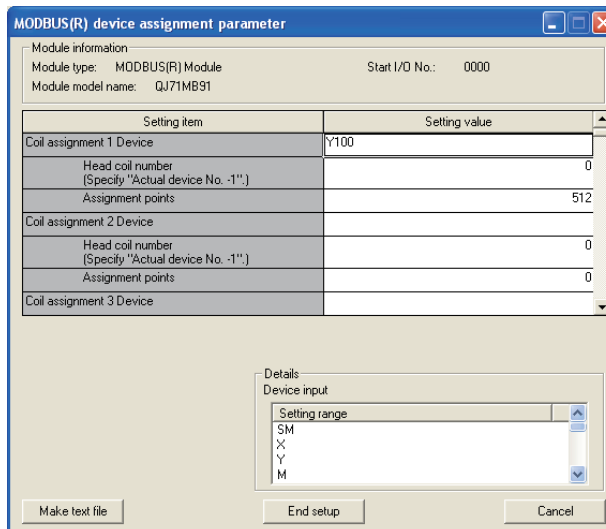

Figure 9.45 MODBUS[®] device assignment parameter

2) When not using GX Configurator-MB

Set MODBUS[®] device assignment parameter from the sequence program.

(☞ This section (4))

(4) Program example

The following is an example of the sequence program required to perform the communication shown in (2).

(a) Interlock program example for MELSECNET/H

Provide interlocks using the link status of the MELSECNET/H remote master station (host) and MELSECNET/H remote I/O station (other station).

The example below shows an interlock for a communication program, which uses the link status (SB47, SB49) of the MELSECNET/H remote master station and the link status (SW70, SW74, SW78) of the MELSECNET/H remote I/O station (Station No. 1).

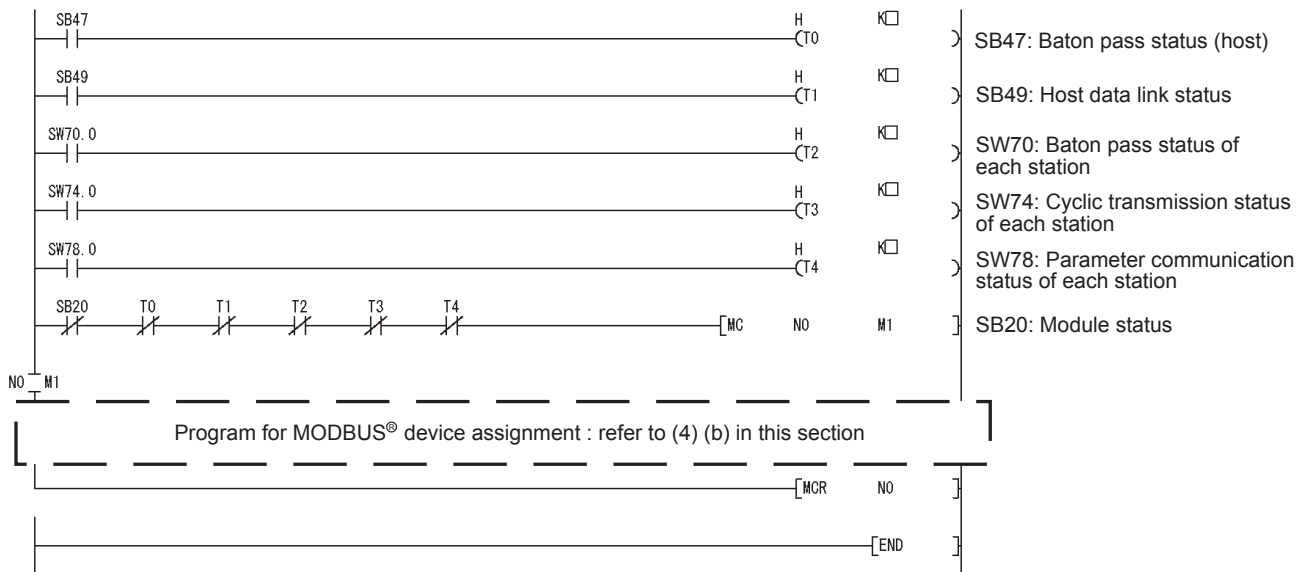

Figure 9.46 Interlock program example for MELSECNET/H

Set the following value as timer constant K□.

Table9.10 Value of timer constant K

Baton pass status (T0, T2)	(Sequence scan time × 4) or more
Cyclic transmission status Parameter communication status (T1, T3, T4)	(Sequence scan time × 3) or more

Reason: To prevent the control from stopping even if the network detects an instantaneous error due to a cable problem, noise or any other condition

Note that the above "4" and "3" represent standard values.

POINT

For details on interlock programs for the MELSECNET/H remote master station and MELSECNET/H remote I/O station, refer to the following manual.

☞ Q Corresponding MELSECNET/H Network System Reference Manual (Remote I/O network)

(b) Program example for MODBUS[®] device assignment parameter setting
The program example is shown below.

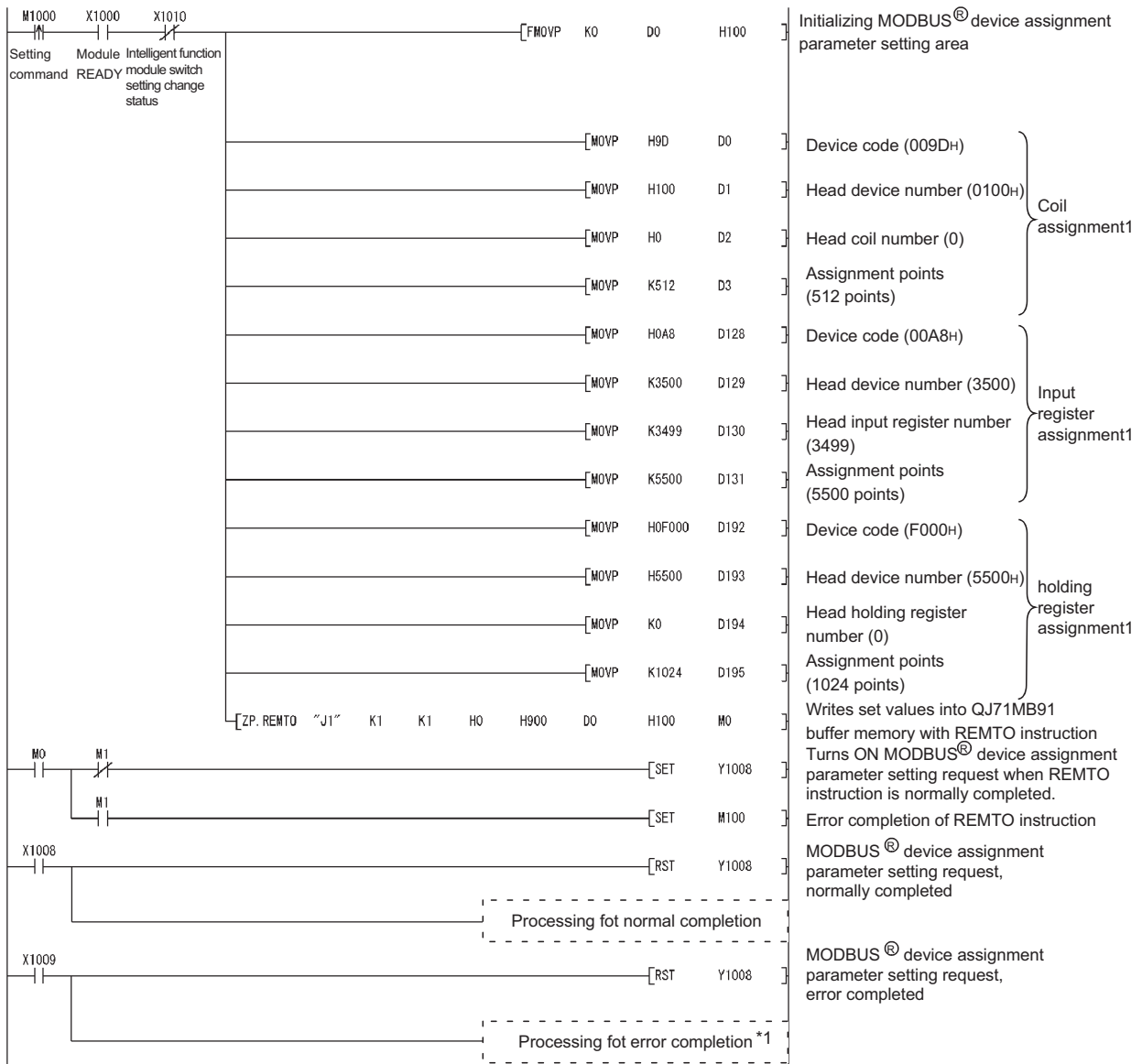
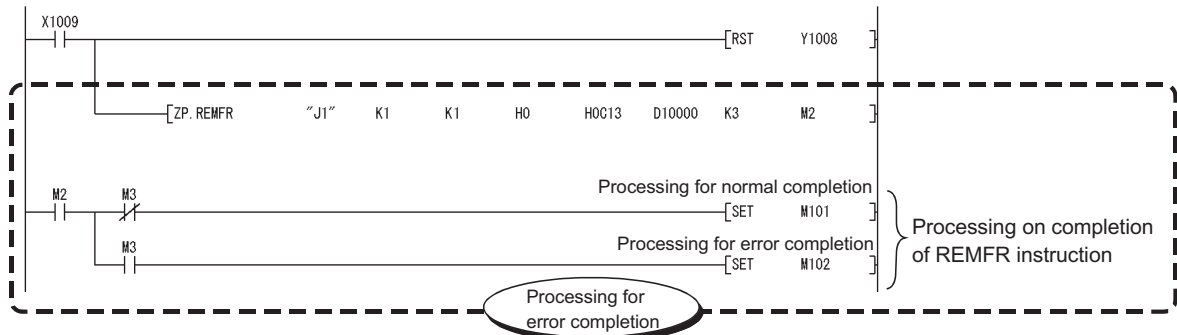

Figure 9.47 MODBUS[®] device assignment parameter setting program example when mounted to MELSECNET/H remote I/O station

* 1 The following is a processing example for error completion.
 The following is a processing example in which, from the QJ71MB91 buffer memory (address: 0C13H to 0C15H), the programmable controller CPU on the MELSECNET/H remote master station obtains data such as an error code identified in the MODBUS® device assignment parameter setting.



The following data are stored in the programmable controller CPU on the MELSECNET/H remote master station:

- D10000: MODBUS® device assignment parameter error code
- D10001: Error, device type
- D10002: Error, assigned group No.

Figure 9.48 Program example for error completion of MODBUS® device assignment parameters

POINT

1. After execution of the REMFR/REMTO instruction, several scans are required until the read/write of actual data is completed.
 Completion of the REMFR/REMTO instruction can be confirmed by the completion device of the instruction.
2. To set parameters, write the set values to the buffer memory by the REMTO instruction, and then execute the parameter setting request after the completion device of the REMTO instruction turns ON.

Remark

For details of the REMTO instruction and the troubleshooting for error completion of the instruction, refer to the following manual:

☞ Q Corresponding MELSECNET/H Network System Reference Manual (Remote I/O network)

CHAPTER10 DEDICATED INSTRUCTIONS

The dedicated instructions make programming easy for use of the intelligent function module functions.

10.1 Dedicated Instruction List and Available Devices

(1) Dedicated instruction list

The following are the dedicated instructions supported by the QJ71MB91.

Table10.1 Dedicated instruction list

Dedicated instruction	Description	Reference
MBRW	Reads or write MODBUS [®] device data from or a slave.	Section 10.2
MBREQ	Communications with a slave in the request message format containing any given protocol data unit.	Section 10.3
UINI	Changes the intelligent function module switch setting of the QJ71MB91 (the mode, communication speed, transmission details, and/or station No.)	Section 10.4

(2) Available devices

The following devices are available for the dedicated instructions:

Table10.2 Available devices

Internal devices		File register	Constant
Bit ^{*1}	Word		
X, Y, M, L, F, V, B	T, ST, C, D, W	R, ZR	-

* 1 Word device bit designation can be used as bit data.

Word device bit designation is done by designating . .

(Designation of bit numbers is done in hexadecimal.)

For example, bit 10 of D0 is designated as .

However, there can be no bit designation for timers (T), retentive timers (ST) and counters (C).

10.2 Z(P).MBRW

This instruction allows reading or writing of MODBUS® device data to a slave.

Table 10.3 Devices available for the MBRW instruction

Setting data	Available device									
	Internal device (System, user)		File register	Link direct device J□\□		Intelligent function module device U□\G□	Index register Zn	Constant		Others
	Bit	Word		Bit	Word			K,H	\$	
(S1)	-	○								
(D1)	-	○								
(S2)	-	○								
(D2)		○								

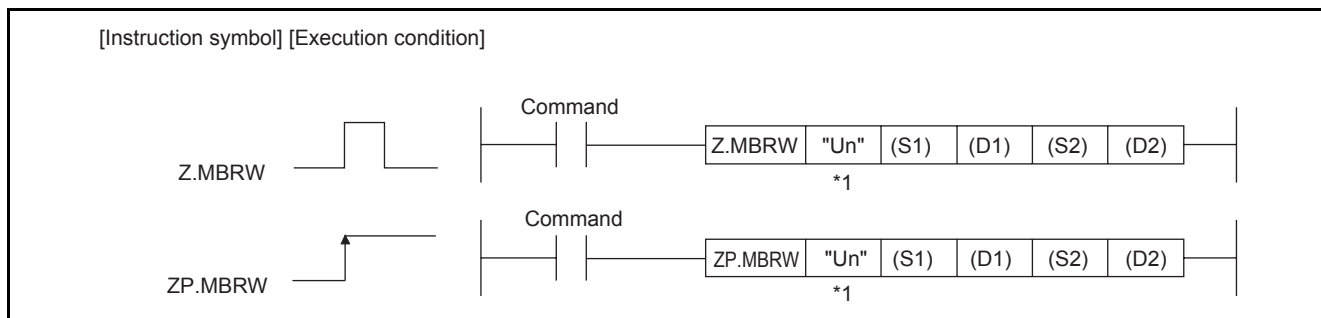

Figure 10.1 Configuration of MBRW instruction

* 1 If the originating station is a Basic model QCPU (function version B or later), or Universal model QCPU, "" (double quotation) of the first argument can be omitted.

(1) Setting data

Table 10.4 Setting data of MBRW instruction

Setting data	Setting details	Setting side ^{*1}	Data type
"Un"/Un	Head I/O number of the module (00 _H to FE _H : Upper 2 digits of the I/O number in 3-digit notation)	User	String/ BIN 16 bits
(S1)	Head number of the device where control data is stored	User, system	BIN 16 bits
(D1) ^{*2*3}	Read data storage device	System	
(S2) ^{*2*3}	Write data storage device	User	
(D2)	The device that is turned ON for one scan on completion of the instruction (D2)+1 also turns ON when the instruction completes in error.	System	Bit

* 1 The setting side is as described below.

- User : Data are set by the user before dedicated instruction execution.
- System: The programmable controller CPU stores the result of dedicated instruction execution.

* 2 Specify a dummy device if "00_H: No specification" is selected in the Type specification of the target MODBUS[®] device ((S1)+8).

* 3 Data are stored in RTU format (binary) regardless of the frame mode (RTU mode/ASCII mode).

Local devices and program-based file registers are not available as the devices used for setting data.

(2) Control data

Table10.5 Control data of the MBRW instruction

Device	Item	Setting data	Setting range	Setting side*1																				
(S1)+0	-	Specify 0.	0	User																				
(S1)+1	Completion status	The status of the instruction completion is stored. 0 : Normal completion Other than 0: Error completion (error code) (☞ Section 11.4.3)	-	System																				
(S1)+2	MODBUS [®] exception code	An exception code from a slave is stored. 0 : Slave processing normally completed Other than 0: Slave processing completed in error (exception code) (☞ Section 11.4.2)	-	System																				
(S1)+3	Channel	Specify the target channel. 1: RS-232 2: RS-422/485	1, 2	User																				
(S1)+4	-	Specify 0.	0	User																				
(S1)+5	Target station No.	Specify the station number of the target slave. 0 : Broadcast 1 to 247 : Target slave station number	0 to 247	User																				
(S1)+6	-	Specify 0.	0	User																				
(S1)+7	Response monitoring timer value/Broadcast delay value	[Response monitoring timer value (Target station No. is 1 to 247)] Specify the time for monitoring a response from the target device (slave). (Unit: 10ms) 0 :30 seconds 2 to 65535: Set value (Response monitoring timer value = set value x 10ms) [Broadcast delay value (Target station No. is 0)] Specify the wait time after broadcast transmission. (unit: 10 ms) 0 :400 ms 2 to 65535: Set value (Broadcast delay value = set value x 10ms) For details on the Response monitoring timer value/Broadcast delay value, refer to the following. (☞ Section 7.2.1 (4))	0 2 to 65535 ²	User																				
(S1)+8	Type specification of the target MODBUS [®] device	Specify the type of the read/write target MODBUS [®] device. (☞ This section (2) (a)) <table border="1" style="margin-left: auto; margin-right: auto;"> <tr> <td style="text-align: center;">b15</td> <td style="text-align: center;">b8 b7</td> <td style="text-align: center;">b0</td> </tr> <tr> <td style="text-align: center;">Read target</td> <td style="text-align: center;">Write target</td> <td></td> </tr> </table> <table border="1" style="margin-left: auto; margin-right: auto;"> <thead> <tr> <th>Setting value</th> <th>Target MODBUS[®] device type</th> </tr> </thead> <tbody> <tr> <td style="text-align: center;">00_H</td> <td>No specification</td> </tr> <tr> <td style="text-align: center;">01_H</td> <td>Coil</td> </tr> <tr> <td style="text-align: center;">02_H</td> <td>Input</td> </tr> <tr> <td style="text-align: center;">04_H</td> <td>Input register</td> </tr> <tr> <td style="text-align: center;">05_H</td> <td>Holding register</td> </tr> <tr> <td style="text-align: center;">07_H</td> <td>Extended file register</td> </tr> </tbody> </table>	b15	b8 b7	b0	Read target	Write target		Setting value	Target MODBUS [®] device type	00 _H	No specification	01 _H	Coil	02 _H	Input	04 _H	Input register	05 _H	Holding register	07 _H	Extended file register	0001 _H 0005 _H 0007 _H 0100 _H 0200 _H 0400 _H 0500 _H 0505 _H 0700 _H	User
b15	b8 b7	b0																						
Read target	Write target																							
Setting value	Target MODBUS [®] device type																							
00 _H	No specification																							
01 _H	Coil																							
02 _H	Input																							
04 _H	Input register																							
05 _H	Holding register																							
07 _H	Extended file register																							

(Continued on next page)

Table10.5 Control data of the MBRW instruction (Continued)

Device	Item	Setting data	Setting range	Setting side ^{*1}								
(S1)+9	Target file number	Specify a file number when the target MODBUS [®] device is the extended file register.	0 to 65535 ^{*2*3}	User								
(S1)+10	Target MODBUS [®] device head number	Specify the head number of the read target MODBUS [®] device. Specify the lower 5 digits of the device head number. The device head number is specified as "(Actual device number) - 1". (Except for the file number and device number of the extended file register) (Example) Specify "31" when accessing Input 100032.	0 to 65535 ^{*2*3}	User								
(S1)+11	Read setting Access points	<p>Set the read points of the MODBUS[®] device. The units used for the setting of access points are as follows:</p> <table border="1"> <thead> <tr> <th>Target MODBUS[®] device type specification</th> <th>Unit</th> <th>Allowable access points</th> </tr> </thead> <tbody> <tr> <td>01H: Coil 02H: Input</td> <td>Bit</td> <td rowspan="2"> This section (2) (a) </td> </tr> <tr> <td>04H: Input register 05H: Holding register 07H: Extended file register</td> <td>Word</td> </tr> </tbody> </table>	Target MODBUS [®] device type specification	Unit	Allowable access points	01H: Coil 02H: Input	Bit	This section (2) (a)	04H: Input register 05H: Holding register 07H: Extended file register	Word	0 to 2000 ^{*3}	User
Target MODBUS [®] device type specification	Unit	Allowable access points										
01H: Coil 02H: Input	Bit	This section (2) (a)										
04H: Input register 05H: Holding register 07H: Extended file register	Word											
(S1)+12	Read data storage size	Set the word size of the read data stored in the argument (D1) and later fields.	-	System								
(S1)+13	Target file number	Specify a file number when the target MODBUS [®] device is the extended file register.	0 to 65535 ^{*2*4}	User								
(S1)+14	Target MODBUS [®] device head number	Specify the head number of the write target MODBUS [®] device. Specify the lower 5 digits of the device head number. The device head number is specified as "(Actual device number) - 1". (Except for the file number and device number of the extended file register) (Example) Specify "31" when accessing Holding register 400032.	0 to 65535 ^{*2*4}	User								
(S1)+15	Write setting Access points	<p>Set the write points of the MODBUS[®] device. The units used for the setting of access points are as follows:</p> <table border="1"> <thead> <tr> <th>Target MODBUS[®] device type specification</th> <th>Unit</th> <th>Allowable access points</th> </tr> </thead> <tbody> <tr> <td>01H: Coil 02H: Input</td> <td>Bit</td> <td rowspan="2"> This section (2) (a) </td> </tr> <tr> <td>04H: Input register 05H: Holding register 07H: Extended file register</td> <td>Word</td> </tr> </tbody> </table>	Target MODBUS [®] device type specification	Unit	Allowable access points	01H: Coil 02H: Input	Bit	This section (2) (a)	04H: Input register 05H: Holding register 07H: Extended file register	Word	0 to 1968 ^{*4}	User
Target MODBUS [®] device type specification	Unit	Allowable access points										
01H: Coil 02H: Input	Bit	This section (2) (a)										
04H: Input register 05H: Holding register 07H: Extended file register	Word											
(S1)+16	Write data storage size	<p>Set the word size of the write data stored in the argument (S2) and later fields. Set "1" for the case of read only.</p> <p>When the access target MODBUS[®] device (Type specification of the target MODBUS[®] device) is "01H: Coil" or "02H: Input", pay attention to the following.</p> <ul style="list-style-type: none"> • Set the "Number of access points/16 (rounded up to the nearest integer)" as the write data storage size. • When the number of write points is a number with a fraction, the excess area is ignored. (Refer to Point.) 	1 to 125	User								

- * 1 The setting side is as described below.
 - User : Data are set by the user before dedicated instruction execution.
 - System: The programmable controller CPU stores the result of dedicated instruction execution.
- * 2 When specifying a value of 32768 (8000H) or more in a sequence program, set the value in hexadecimal.
- * 3 Set "0" for the case of write only.
- * 4 Set "0" for the case of read only.

POINT

When accessing a bit device (coil, input) of a slave, the fraction bit is handled as described below.

[Read]

When the read access points is 35

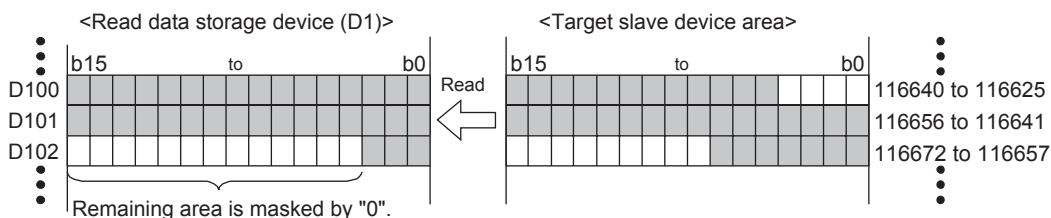

[Write]

When the write access points is 5



(a) Type specification of the target MODBUS[®] device

The table below shows the possible combinations in the target MODBUS[®] device type specification ((S1)+8) and the valid ranges of the access points.

Any other combinations are not applicable to the Type specification of the target MODBUS[®] device type ((S1)+8).

Table10.6 Possible combinations of target MODBUS[®] device type specification

Target MODBUS [®] device type specification			Function code		Valid access point range	
Setting value	Read target	Write target			Read points	Write points
0100 _H	Coil	No specification	01	Read coils	1 to 2000 points	-
0200 _H	Input		02	Read discrete inputs	1 to 2000 points	-
0400 _H	Input register		04	Read input registers	1 to 125 points	-
0500 _H	Holding register		03	Read holding registers	1 to 125 points	-
0700 _H	Extended file register ^{*1}		20	Read file record	1 to 124 points	-
0001 _H ^{*2}	No specification	Coil	15	Write multiple coils	-	1 to 1968 points
0005 _H ^{*2}		Holding register	16	Write multiple registers	-	1 to 123 points
0007 _H ^{*2}		Extended file register ^{*1}	21	Write file record	-	1 to 122 points
0505 _H ^{*3}	Holding register	Holding register	23	Read/Write multiple registers	1 to 125 points	1 to 121 points

* 1 Read File Record (FC: 20) and Write File Record (FC: 21) allows access to multiple areas in one transmission, however, only one area is accessible in one transmission when using this dedicated instruction.

* 2 In the case of broadcast, only 0001_H (Write multiple coils), 0005_H (Write multiple registers) and 0007_H (Write file record) can be set.

* 3 Simultaneous execution of read and write with a single instruction is allowed only for 0505_H (Read/Write multiple registers).

(3) Function

The following explains the functions of the MBRW instruction.

(a) Processing details

MODBUS[®] device data are read from or written to the slave specified by the target station number of the control data.

Processing by the automatic communication function can be performed from a sequence program at any given timing.

(b) Number of simultaneously executable instructions

The number of simultaneously executable dedicated instructions is one instruction per channel.

Create a sequence program so that the number of dedicated instructions to be simultaneously executed will not exceed the limit.

Failure to do so may cause the following:

1) When execution of two or more MBRW instructions are attempted:
The executed instructions are ignored.

2) When the MBRW instruction execution is attempted during execution of the MBREQ or UINI instruction:
An error occurs when the MBRW instruction is executed.

(c) Frame mode setting

The frame mode (RTU mode/ASCII mode) is set with the intelligent function module switch. (☞ Section 6.6)

(d) Start, Address, Error check and END fields of the protocol data unit

The QJ71MB91 automatically enters values in Start, Address, Error check and END fields of the protocol data unit. (☞ Section 4.2.1)

(e) Data to be stored in read/write data storage devices

Data are stored in RTU format (binary) regardless of the frame mode (RTU mode/ASCII mode).

- (f) When using the automatic communication function and the MBRW instruction on the same channel

The MBRW instruction is not executed while the Response monitoring timer/ Broadcast delay of the automatic communication function is active.

When the automatic communication function and the MBRW instruction are used on the same channel, set appropriate automatic communication parameters and create a proper sequence program so that the MBRW instruction can be executed in the right timing. (See Section 9.2.3)

- (g) Confirmation of execution status

Whether the MBRW instruction is being executed, or completed normally or not can be checked by the MODBUS[®] exception code ((S1)+2), the completion device (D2) specified as set data, and the error completion device ((D2)+1).

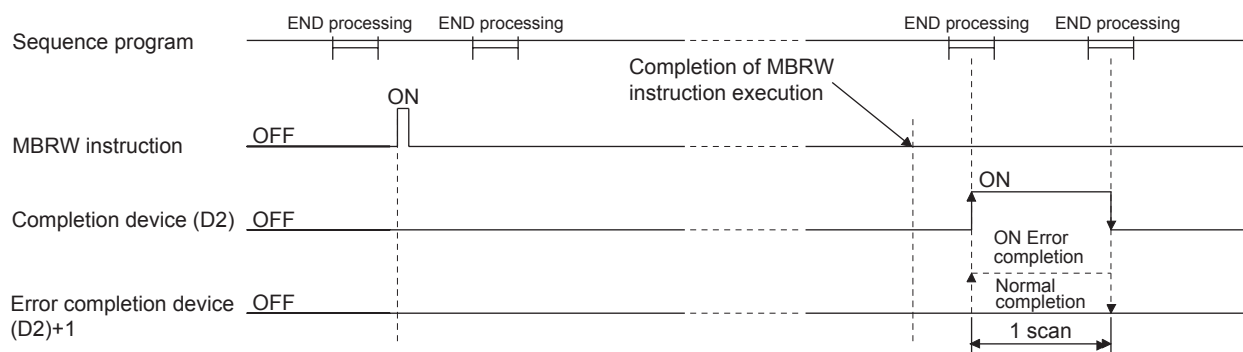

Figure 10.2 MBRW instruction timing chart

The completion device (D2) turns ON in the END processing of the scan after completion of the MBRW instruction, and turns OFF in the next END processing. The error completion device ((D2)+1) turns ON in the END processing of the scan after error completion of the MBRW instruction, and turns OFF in the next END processing. (The device remains OFF in the case of normal completion.)

(4) Error

- (a) When a dedicated instruction completes in error
When the dedicated instruction completes in error, the error completion device (D2)+1 turns ON and an error code is stored in the completion status (S1)+1.
- (b) When processing on a slave completes in error
When the processing on a slave completes in error, an exception code is stored in (S1)+2.
- (c) Confirmation of error details
Check the error code and exception code referring to the following, and take corrective actions.

Table 10.7 Error code and exception code for the MBRW instruction execution

Item		Reference
Error code	03E8 _H to 4FFF _H	QCPU User's Manual (Hardware Design, Maintenance and Inspection)
	7300 _H or later	Section 11.4.3
Exception code		Section 11.4.2

(5) Program example

This section provides an example program in which device data are read from and written to the holding register of the slave (Station No. 1) on channel 1 as shown below.

This frame made shall be the RTU mode.

The I/O signals of the QJ71MB91 are X/Y00 to X/Y1F.

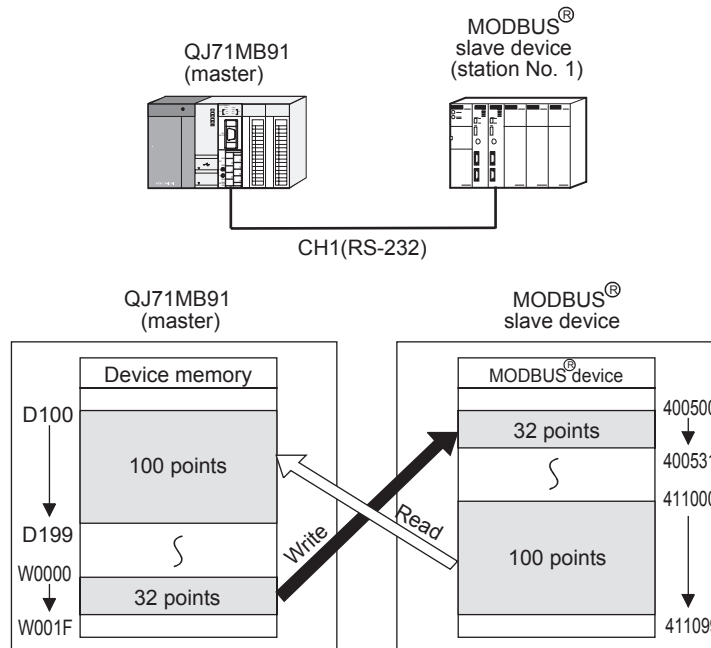

Figure 10.3 Configuration example for MBRW instruction execution

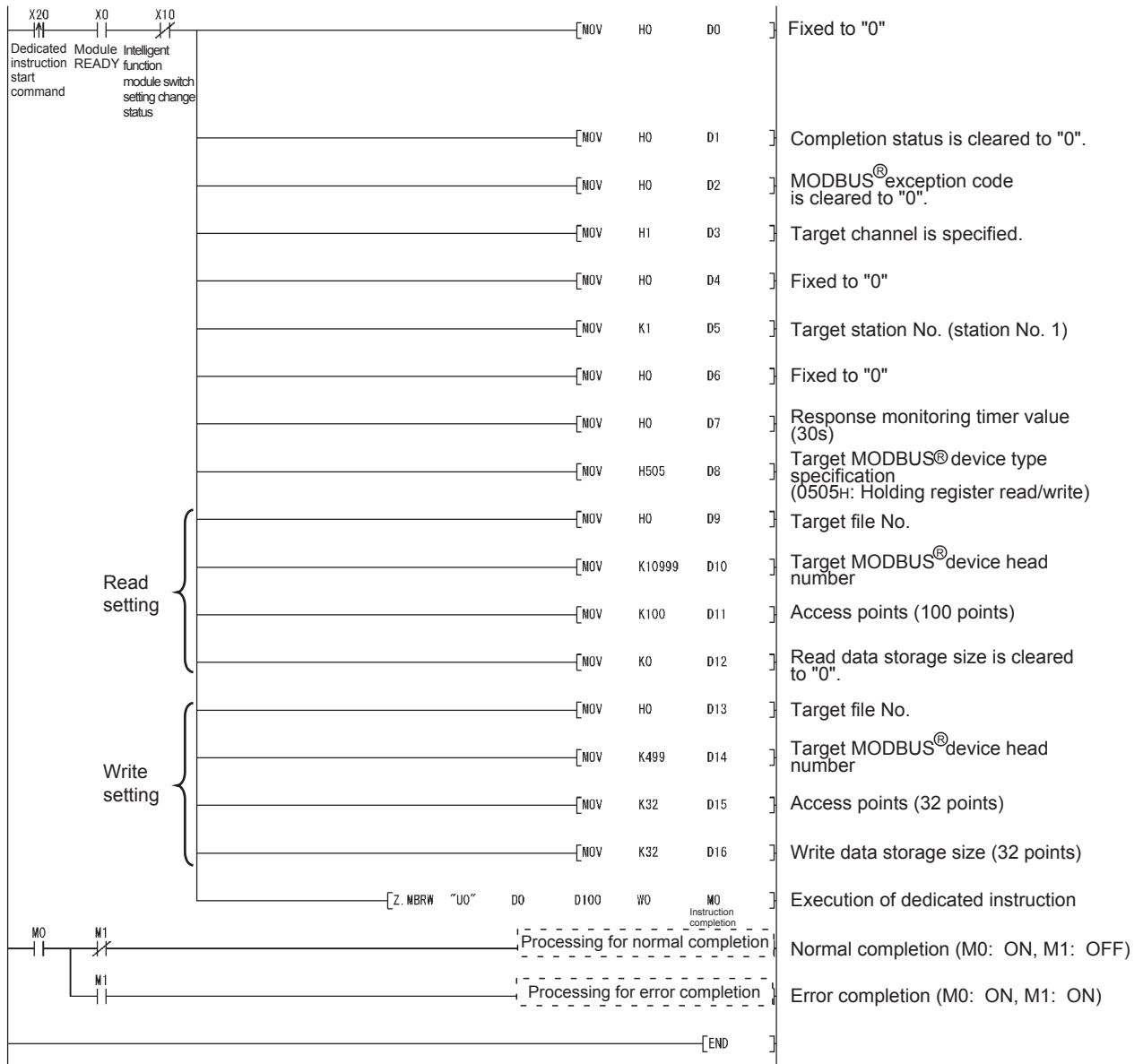
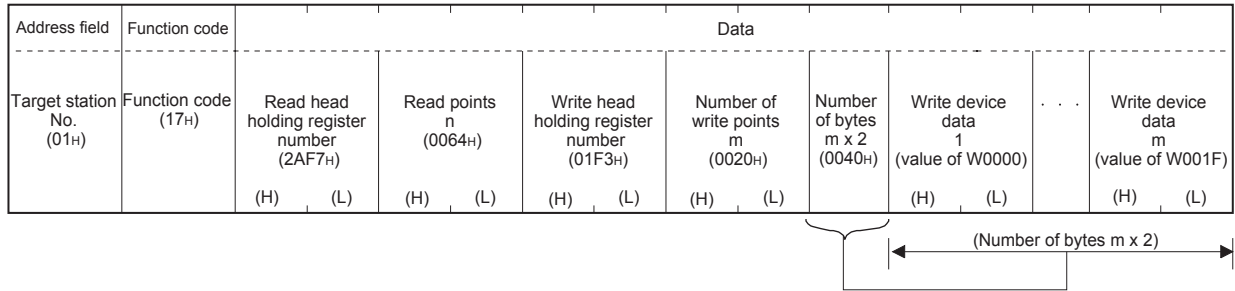

Figure 10.4 MBRW instruction program example

Remark

In this sample program, the following MODBUS® frames are used for the communication with the slave.

Request message format (Master (QJ71MB91) → Slave)



Response message format (Slave → Master (QJ71MB91))

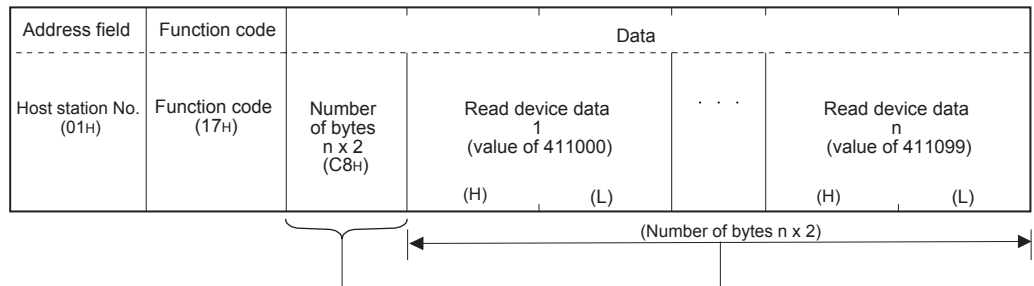

10.3 Z(P).MBREQ

This instruction allows communications with a slave in the request message format containing any given protocol data unit.

Table 10.8 Devices available for the MBREQ instruction

Setting data	Available device									
	Internal device (System, user)		File register	Link direct device J□\□		Intelligent function module device U□\G□	Index register Zn	Constant		Others
	Bit	Word		Bit	Word			K,H	\$	
(S1)	-	○								
(S2)	-	○								
(D1)	-	○								
(D2)		○								

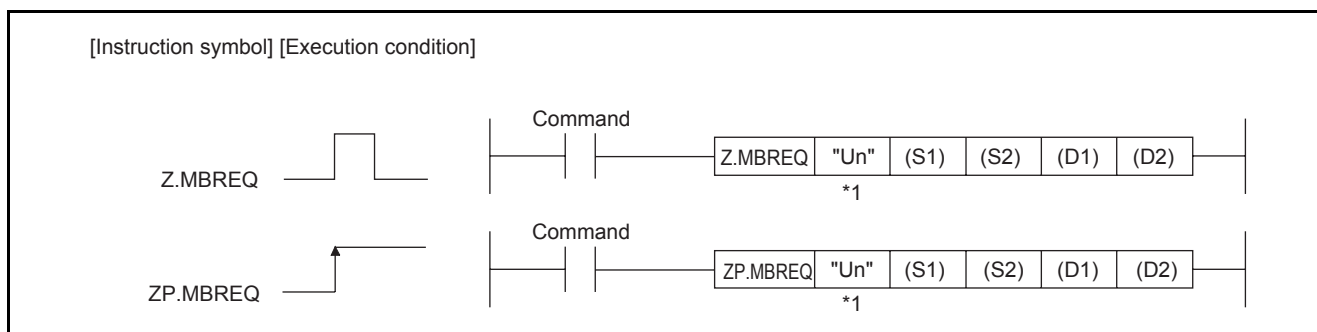

Figure 10.5 Configuration of MBREQ instruction

* 1 If the originating station is a Basic model QCPU (function version B or later), or Universal model QCPU, "" (double quotation) of the first argument can be omitted.

(1) Setting data

Table10.9 Setting data of MBREQ instruction

Setting data	Setting details	Setting side ^{*1}	Data type
"Un"/Un	Head I/O number of the module (00 _H to FE _H : Upper 2 digits of the I/O number in 3-digit notation)	User	String/ BIN 16 bits
(S1)	Head number of the device where control data is stored	User, system	BIN 16 bits
(S2)	Request message storage head device ^{*2}	User	
(D1)	Response message storage head device ^{*2}	System	
(D2)	The device that is turned ON for one scan on completion of the instruction (D2)+1 also turns ON when the instruction completes in error.	System	Bit

* 1 The setting side is as described below.

- User : Data are set by the user before dedicated instruction execution.
- System: The programmable controller CPU stores the result of dedicated instruction execution.

* 2 Data is stored in RTU format (binary) regardless of the frame mode (RTU mode/ASCII mode).

Local devices and program-based file registers are not available as the devices used for setting data.

Remark

For details on the protocol data unit, refer to the following:

Section 4.2

(2) Control data

Table10.10 Control data of the MBREQ instruction

Device	Item	Setting data	Setting range	Setting side*1
(S1)+0	-	Specify 0.	0	User
(S1)+1	Completion status	The status of the instruction completion is stored. 0 : Normal completion Other than 0: Error completion (error code) (☞ Section 11.4.3)	-	System
(S1)+2	-	Specify 0.	0	User
(S1)+3	Channel	Specify the target channel. 1: RS-232 2: RS-422/485	1, 2	User
(S1)+4	-	Specify 0.	0	User
(S1)+5	Target station No.	Specify the station number of the target slave. 0 : Broadcast*2 1 to 247: Slave station No.	0 to 247	User
(S1)+6	-	Specify 0.	0	User
(S1)+7	Response monitoring timer value/ Broadcast delay value	[Response monitoring timer value (Target station No. is 1 to 247)] Specify the time for monitoring a response from the target device (slave). (Unit: 10ms) 0 : 30 seconds 2 to 65535: Set value (Response monitoring timer value = set value x 10ms) [Broadcast delay value (Target station No. is 0)] Specify the wait time after broadcast transmission. (Unit: 10ms) 0 : 400ms 2 to 65535: Set value (Broadcast delay value = set value x 10ms) For details on the Response monitoring timer value/Broadcast delay value, refer to the following. ☞ Section 7.2.1 (4)	0 2 to 65535 *3	User

* 1 The setting side is as described below.

- User : Data are set by the user before dedicated instruction execution.
- System: The programmable controller CPU stores the result of dedicated instruction execution.

* 2 For function codes that can be broadcast, refer to the following:

☞ Section 4.1

* 3 When specifying a value of 32768 (8000H) or more in a sequence program, set the value in hexadecimal.

(3) Request message storage devices

Table 10.11 Request message storage devices

Device	Item	Setting data	Setting range	Setting side ^{*1}
(S2)+0	Request message size	Set the size (function code + data) of the request message to be sent in byte units. Set the size for transmission in the RTU mode regardless of the frame mode (RTU mode/ASCII mode).	1 to 253	User
(S2)+1 to (S2)+n	Request message	<p>Set the contents (function code + data) of the request message to be sent. Data must be stored in RTU format (binary) regardless of the frame mode (RTU mode/ASCII mode).</p> <p>(Example) When sending a request message to read the data of holding registers 440001 and 440002 with Read Holding Registers (FC: 03)</p> <p><Frame of request message to be sent (in ASCII mode)></p> <div style="text-align: center;"> <p>Figure 10.6 Request message example</p> </div> <p><Contents in request message storage devices and their order></p> <div style="text-align: center;"> <p>Figure 10.7 Contents in request message storage devices and their order</p> </div>	As shown on left	User

* 1 The setting side is as described below.

- User : Data are set by the user before dedicated instruction execution.
- System: The programmable controller CPU stores the result of dedicated instruction execution.

☒ POINT

1. The request message data stored in request message storage devices "(S2)+1 to (S2)+n" are sent in order of L (lower) to H (upper) bytes, starting with the lowest device number.
 2. When the request message size is an odd number, the last upper byte of the request message storage device is ignored. (The data are not sent.)
-

(4) Response message storage devices

Table 10.12 Response message storage devices

Device	Item	Setting data	Setting range	Setting side ^{*1}
(D1)+0	Response message size	Set the size (function code + data) of the received response message in byte units. The size for the RTU mode is stored regardless of the frame mode (RTU mode/ASCII mode).	-	System
(D1)+1 to (D1)+m	Response message	<p>Set the contents (function code + data) of the received response message. Data are stored in RTU format (binary) regardless of the frame mode (RTU mode/ASCII mode).</p> <p>(Example) When a response message of Read Holding Registers (FC: 03) is received</p> <p><Received response message frame (in ASCII mode)></p> <div style="text-align: center;"> <p>Figure 10.8 Response message example</p> </div> <p><Contents in response message storage devices and their order></p> <div style="text-align: center;"> <p>Figure 10.9 Contents in response message storage devices and their order</p> </div>	As shown on left	System

* 1 The setting side is as described below.

- User : Data are set by the user before dedicated instruction execution.
- System: The programmable controller CPU stores the result of dedicated instruction execution.

* 2 The number of read bytes is 4 from "2 (Read points) × 2 = 4".

☒ POINT

1. The received response message is stored in response message storage devices "(D1)+1 to (D1)+n" in order of L (lower) to H (upper) bytes, starting with the lowest device number.
2. When the response message size is an odd number, the last upper byte of the response message storage device is overwritten with "0".

(5) Function

(a) Processing details

This instruction allows communication with a slave specified by the target station number in the control data, using the request message format containing any given protocol data unit.

(b) Number of simultaneously executable instructions

The number of simultaneously executable dedicated instructions is one instruction per channel.

Create a sequence program so that the number of dedicated instructions to be simultaneously executed will not exceed the limit.

Failure to do so may cause the following:

1) When execution of two or more MBREQ instructions are attempted:

The executed instructions are ignored.

2) When the MBREQ instruction execution is attempted during execution of the MBRW or UINI instruction:

An error occurs when the MBREQ instruction is executed.

(c) Frame mode setting

The frame mode (RTU mode/ASCII mode) is set with the intelligent function module switch. (☞ Section 6.6)

(d) Start, Address, Error check and END fields of the protocol data unit

The QJ71MB91 automatically enters values in Start, Address, Error check and END fields of the protocol data unit. (☞ Section 4.2.1)

(e) Data to be stored in request/response message storage devices

Data are stored in RTU format (binary) regardless of the frame mode (RTU mode/ASCII mode).

- (f) When using the automatic communication function and the MBREQ instruction on the same channel

The MBREQ instruction is not executed while the Response monitoring timer/ Broadcast delay of the automatic communication function is active.

When the automatic communication function and the MBREQ instruction are used on the same channel, set appropriate automatic communication parameters and create a proper sequence program so that the MBREQ instruction can be executed in the right timing. (See Section 9.2.3)

- (g) Confirmation of execution status

Whether the MBREQ instruction is being executed, or completed normally or not can be checked by the completion device (D2) specified as set data, and the error completion device ((D2)+1).

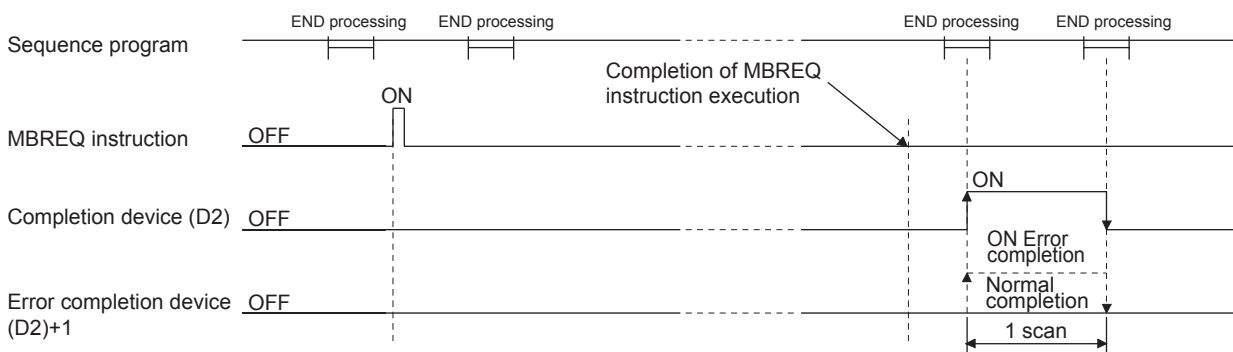

Figure 10.10 MBREQ instruction timing chart

The completion device (D2) turns ON in END processing of the scan after completion of the MBREQ instruction, and turns OFF in the next END processing. The error completion device ((D2)+1) turns ON in the END processing of the scan after error completion of the MBREQ instruction, and turns OFF in the next END processing. (The device remains OFF in the case of normal completion.)

(6) Error

- (a) When a dedicated instruction completes in error

When the dedicated instruction completes in error, the error completion device (D2)+1 turns ON and an error code is stored in the completion status (S1)+1.

- (b) Confirmation of error details

Check the error code referring to the following, and take corrective actions.

Table 10.13 Error codes for the MBREQ instruction

Item	Reference
Error code	03E8H to 4FFFH QCPU User's Manual (Hardware Design, Maintenance and Inspection)
	7300H or later Section 11.4.3

POINT

1. In the case of the MBREQ instruction, exception codes and function codes are not stored in the Error log (address: 0CFEH to 0DFFH) of the buffer memory.
Check the exception and function codes by the response message that is stored in the response message storage device. (☞ This section (4))
2. This instruction completes normally even if the target slave device returns an exception response.
When the instruction completes normally, check the most significant bit of the function code in the response message to determine whether the response is normal or not. (For an error response, the most significant bit in the first byte of the receive data turns ON.)
In the case of an error response, check the exception code (the second byte of the receive data) in the response message and take corrective actions. (☞ Section 11.4.2)
3. For the MBREQ instruction, the ACK. and NAK states of the detailed LED status do not change.
Check whether communication processing completes normally or not by the response message stored in the response message storage device. (☞ This section (4))
4. Pay attention to the following when sending a request message to a slave with no response message*¹ expected. (Excluding the case of broadcast)
 - Specify sufficient time in the Response monitoring timer value (S1)+7 for the slave to process the request message.
 - A response monitoring timeout error (error code: 7379H) occurs even if the instruction is completed normally.
Regard the response monitoring timer timeout error (error code: 7379H) as normal completion.

* 1 Request messages for which no response message is returned are as follows. (in the case of MODBUS[®] standard function)

- Switching to the Listen only mode (☞ Section 4.11.5)
- Restart communications option sent to a slave in the Listen only mode (☞ Section 4.11.2)

(7) Program example

This section provides a program example for sending a request message (Mask Write Register (FC: 22)) and writing a value OR-masked with 0008_H to holding register 400003 of the slave (Station No. 1) on channel 2.

(a) Operation of the program example

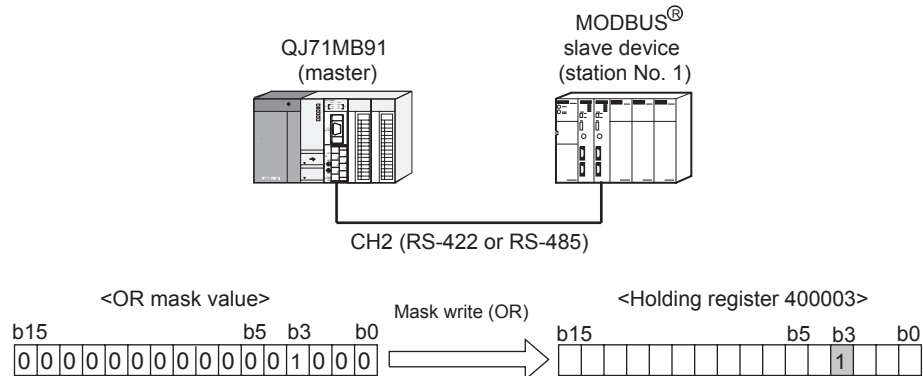

Figure 10.11 Configuration example for MBREQ instruction execution

(b) Frames to be sent/received with MBREQ instruction (in RTU mode)

1) Request message format (Master (QJ71MB91) → Slave)

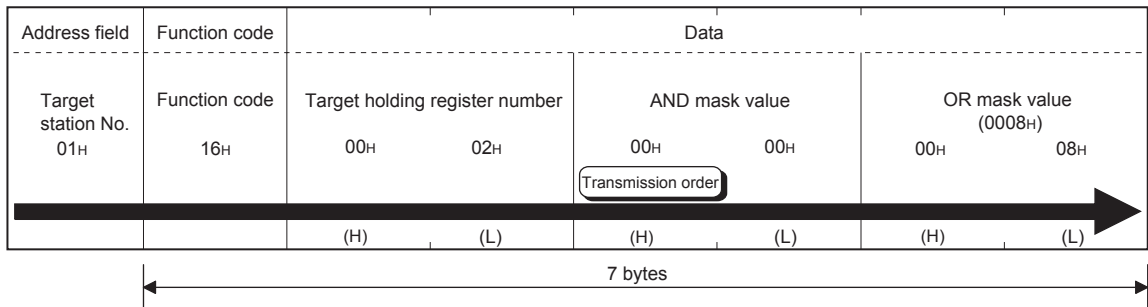

Figure 10.12 Example of request message format to be sent

2) Response message format
<Normal completion>

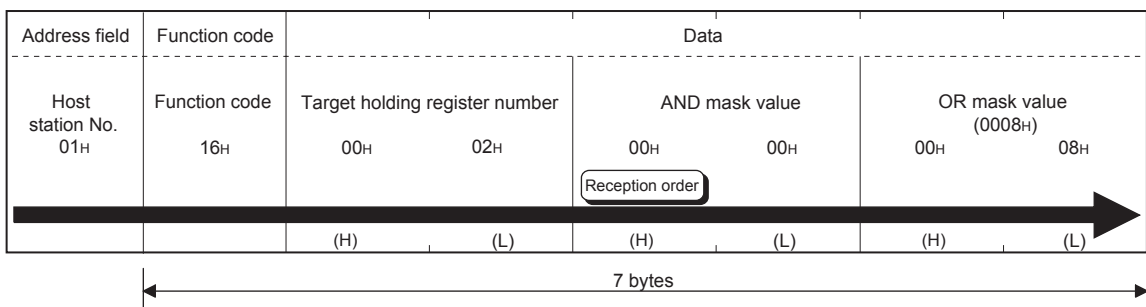

Figure 10.13 Response message format to be received (Normal completion)

<Error completion>

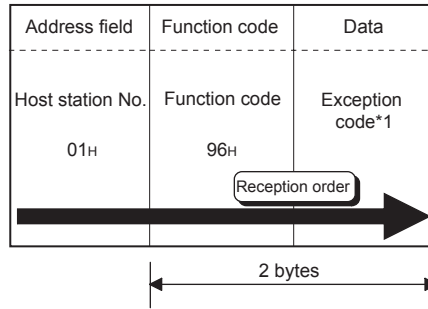

Figure 10.14 Response message format to be received (Error completion)

* 1 For details on exception codes, refer to the following:

☞ Section 11.4.2

(c) Sequence program

In this program example, the I/O signals of QJ71MB91 are X/Y00 to X/Y1F.

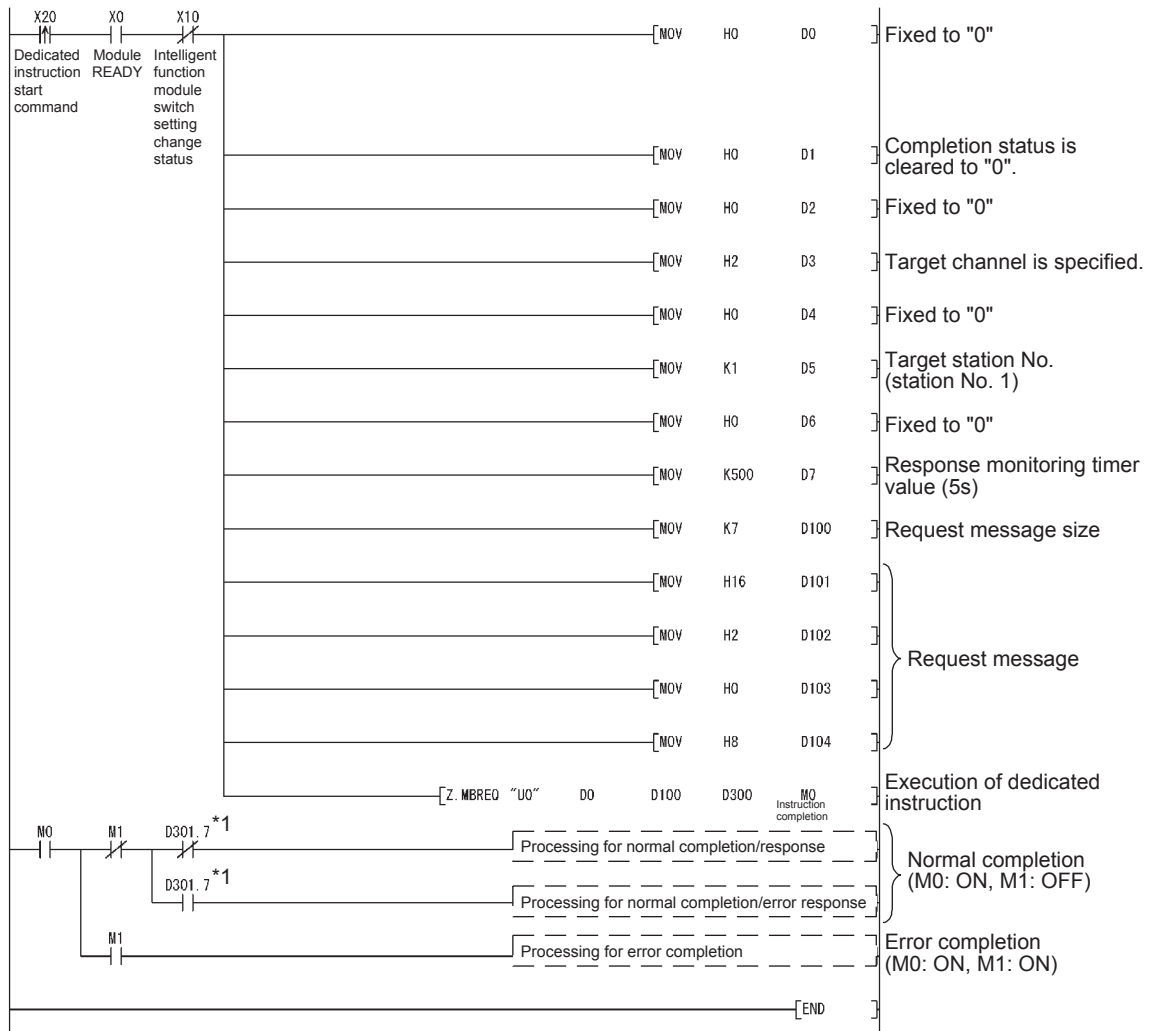

* 1 D301.7 is the most significant bit of the function code to be stored in the response message. The most significant bit of the function code turns ON at the time of error completion.

Figure 10.15 MBREQ instruction program example

10.4 ZP.UINI

This instruction can change the intelligent function module switch setting of the QJ71MB91 (the mode, communication speed, transmission details, and/or station No.)

Table10.14 Devices available for the UINI instruction

Setting data	Available device									
	Internal device (System, user)		File resister	Link direct device J□\□		Intelligent function module device U□\G□	Index register Zn	Constant		Others
	Bit	Word		Bit	Word			K,H	\$	
(S1)	-	○								
(D1)		○								

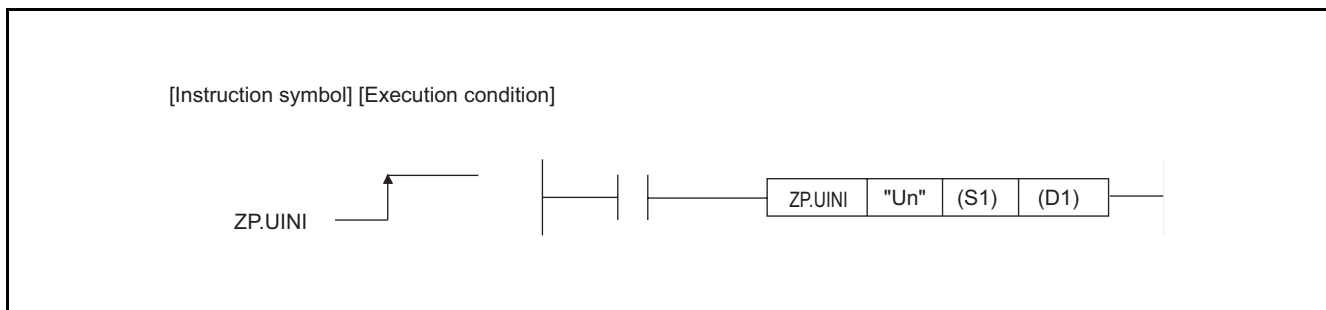

Figure 10.16 Configuration of UINI instruction

* 1 If the originating station is a Basic model QCPU (function version B or later), or Universal model QCPU, "" (double quotation) of the first argument can be omitted.

(1) Setting data

Table10.15 Setting data of UINI instruction

Setting data	Setting details	Setting side ^{*1}	Data type
"Un"/Un	Head I/O number of the module (00H to FEH: Upper 2 digits of the I/O number in 3-digit notation)	User	String/ BIN 16 bits
(S1)	Head number of the device where control data is stored	User, system	BIN 16 bits
(D1)	The device that is turned ON for one scan on completion of the instruction (D1)+1 also turns ON when the instruction completes in error.	System	Bit

* 1 The setting side is as described below.

- User : Data are set by the user before dedicated instruction execution.
- System: The programmable controller CPU stores the result of dedicated instruction execution.

Local devices and program-based file registers are not available as the devices used for setting data.

(2) Control data

Table10.16 Control data of the UINI instruction

Device	Item	Setting Data	Setting range	Setting side ^{*1}
(S1)+0	-	Specify 0.	0	User
(S1)+1	Completion status	The status of the instruction completion is stored. 0 : Normal completion Other than 0: Error completion (error code) (☞ Section 11.4.3)	-	System
(S1)+2	Execution type	Specify an execution type. 0: Change the settings to the values set in (S1)+3 to (S1)+7. 1: Restore the intelligent function module switch settings set in GX Developer. ^{*2}	0, 1	User
(S1)+3	CH1 mode setting (switch 1)	Specify a mode for CH1. (☞ (2) (a))	0 to 2	User
(S1)+4	CH1 communication speed setting/ transmission setting (switch 2)	Specify a communication speed and transmission details for CH1. (☞ (2) (b))	0 to 0B7EH	User
(S1)+5	CH2 mode setting (switch 3)	Specify a mode for CH2. (☞ (2) (a))	0 to 2	User
(S1)+6	CH2 communication speed setting/ transmission setting (switch 4)	Specify a communication speed and transmission details for CH2. (☞ (2) (b))	0 to 0B7EH	User
(S1)+7	CH1/CH2 station No. setting (switch 5)	Specify its own station No. (☞ (2) (c))	0 to F7H	User
(S1)+8 to (S1)+12	-	Specify 0.	0	User

* 1 The setting side is as described below.

- User : Data are set by the user before dedicated instruction execution.
- System: The programmable controller CPU stores the result of dedicated instruction execution.

* 2 When 1 is specified for the execution type, values set for (S1)+3 to (S1)+7 are ignored.

(a) Mode setting

Set the operation mode of the QJ71MB91.

Table10.17 CH1/CH2 mode setting

Set value	Operation mode	Description
0000H	Master function	Performs communication as master station.
0001H	Slave function	Performs communication as slave station.
0002H	Link operation (Slave function)	Relays data between CH1 and CH2 with the link operation function. (☞ Section 5.3.3)

POINT

The UINI instruction cannot change the mode to Hardware test or Self-loopback test.

To change the mode to either of these, modify the intelligent function module switch settings in GX Developer.

(b) Communication speed/transmission setting

Set a speed of communication with the target device and transmission details.

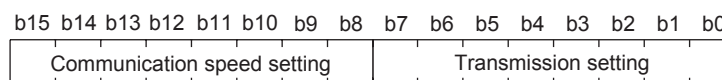

Figure 10.17 Structure of communication speed and transmission settings

1) Transmission setting

Table 10.18 Transmission setting

Bit	Item	OFF(0)	ON(1)	Description
b0	Not used	Fixed to OFF(0)		-
b1	Data bit *1	8	7	Set data bits.
b2	Parity bit presence	Present	Not present	Specify whether parity bit is present or not. In the case of "Present", vertical parity check is performed.
b3	Even/odd parity	Even	Odd	Set even or odd parity. This setting is valid only when "Parity bit presence" is set to "Present".
b4	Stop bit	1	2	Set the stop bit.
b5	Frame mode	RTU mode	ASCII mode	Set the frame mode. (☞ Section 4.2.1)
b6	Online change	Disable	Enable	Set whether to enable or disable data writing to the RUN-status programmable controller CPU by a request message from the master. If this is set to "Disable", when a message requesting the device write is received from the master, the QJ71MB91 returns an error response. This setting is valid only when the slave function is set for the channel.
b7	Not used	Fixed to OFF(0)		-

* 1 Set it to OFF (8 bits) in RTU mode.

2) Communication speed setting *1 *2

Table10.19 Communication speed setting

Communication speed	Bit position	Communication speed	Bit position
	b15 to b8		b15 to b8
300 bps	00H	14400 bps	06H
600 bps	01H	19200 bps	07H
1200 bps	02H	28800 bps	08H
2400 bps	03H	38400 bps	09H
4800 bps	04H	57600 bps	0AH
9600 bps	05H	115200 bps	0BH

* 1 Total communication speed for 2 channels can be set within 115200bps.

* 2 Do not set any value or set "07H" (Initial value) in the communication speed setting for an unused channel.

(c) CH1, 2 station No. setting

Set station No. of the QJ71MB91.

For the master function, set 00H.

For a slave station number, specify a value within the range shown below.

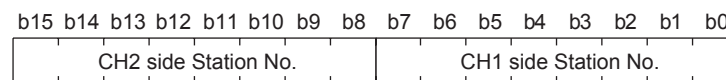

Figure 10.18 CH1, 2 station No. setting structure

Table10.20 Station No. setting

Set value *1	Description
1H to F7H	Sets a slave station No. (1 to 247).

* 1 Setting a value outside the range shown in the table results in a switch error.

(3) Function

(a) Processing details

The intelligent function module switch setting is changed during operation of the QJ71MB91.

(b) Checking in the buffer memory

Changes in the intelligent function module settings can be confirmed in the following buffer memory areas.

Table 10.21 Checking in the buffer memory

Address	Application	Description
0C06H	CH1 operation mode status	Current CH1 operation mode is stored.
0C07H	CH1 transmission status	Current CH1 communication speed and transmission details are stored.
0C08H	CH2 operation mode status	Current CH2 operation mode is stored.
0C09H	CH2 transmission status	Current CH2 communication speed and transmission details are stored.
0C0AH	CH1/CH2 Station No. status	Current CH1 and CH2 station No. status is stored.

(c) Confirmation of execution status

Whether the UINI instruction is being executed, normally completed or failed can be checked with the completion status ((S1)+1), completion device (D1), and error completion device ((D1)+1).

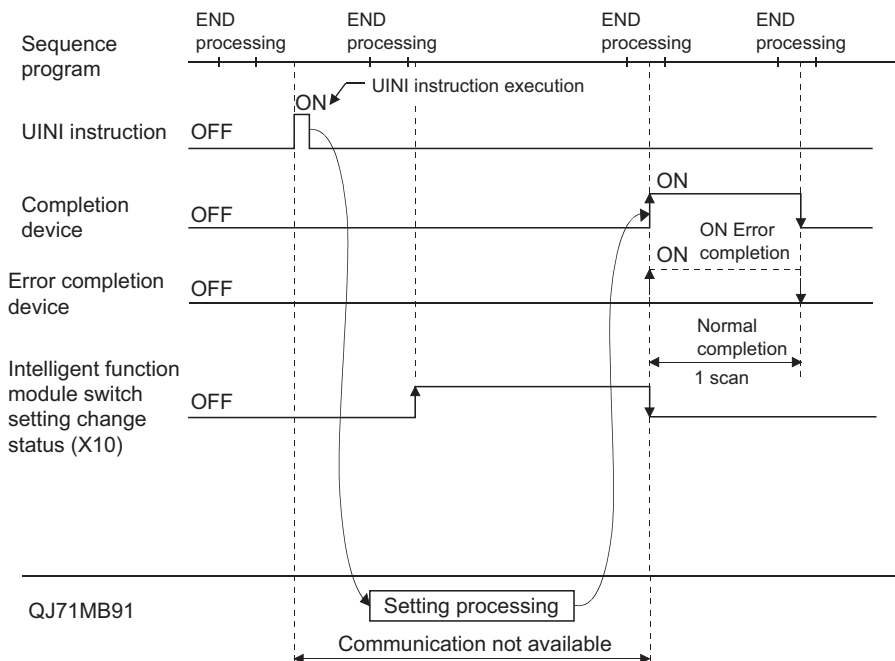

Figure 10.19 UINI instruction timing chart

The completion device (D1) turns ON in the END processing of the scan after completion of the UINI instruction, and turns OFF in the next END processing. The error completion device ((D1)+1) turns ON in the END processing of the scan after error completion of the UINI instruction, and turns OFF in the next END processing. (The device remains OFF in the case of normal completion.)

(4) Error

When the dedicated instruction completes in error, the error completion device (D2)+1 turns ON and an error code is stored in the completion status (S1)+1.

(5) Precautions

- (a) Before executing the UINI instruction
Stop the communication before executing the UINI instruction.
A UINI instruction execution during communication may cause the communication to fail.
- (b) When having changed the communication speed and/or transmission details
Change the current communication speed and/or transmission details of the target device to the same settings.
If the settings are different from those of the target device, communication is not available.
- (c) When having changed the CH1/CH2 station No. setting
Change the station No. in the request message issued from the other device to a new station No. of the QJ71MB91.
If these station numbers differ, communication is not available.
- (d) Automatic communication function after UINI instruction execution
A UINI instruction execution stops the automatic communication function, restoring initial automatic communication parameter values.
To use the automatic communication function after execution of the UINI instruction, set the automatic communication parameters again.
- (e) Simultaneous execution with any other dedicated instruction
Any other dedicated instruction cannot be executed during UINI instruction execution.
Create a program so that another dedicated instruction will be executed after the completion device (D1) is turned ON.
- (f) When the QJ71MB91 is mounted on a MELSECNET/H remote I/O station
No dedicated instructions are executable.

(6) Program example

The program introduced in this section changes the intelligent function module switch settings to the following.

The I/O signals of the QJ71MB91 are X/Y00 to X/Y1F.

Switch No.	Description	Default	Reference
Switch 1	CH1 Mode Setting	0000H	Master function
Switch 2	CH1 Communication speed/transmission setting	0740H	Communication speed: 19200bps Data bit: 8 Parity bit presence: Present Even/odd parity: Even Stop bit: 1 Frame mode: RTU mode Online change: Enable
Switch 3	CH2 Mode setting	0001H	Slave function
Switch 4	CH2 Communication speed/transmission setting	0560H	Communication speed: 9600bps Data bit: 8 Parity bit presence: Present Even/odd parity: Even Stop bit: 1 Frame mode: ASCII mode Online change: Enable
Switch 5	CH1/CH2 Station No. setting	0200H	CH1: Station No. 0, CH2: Station No. 2

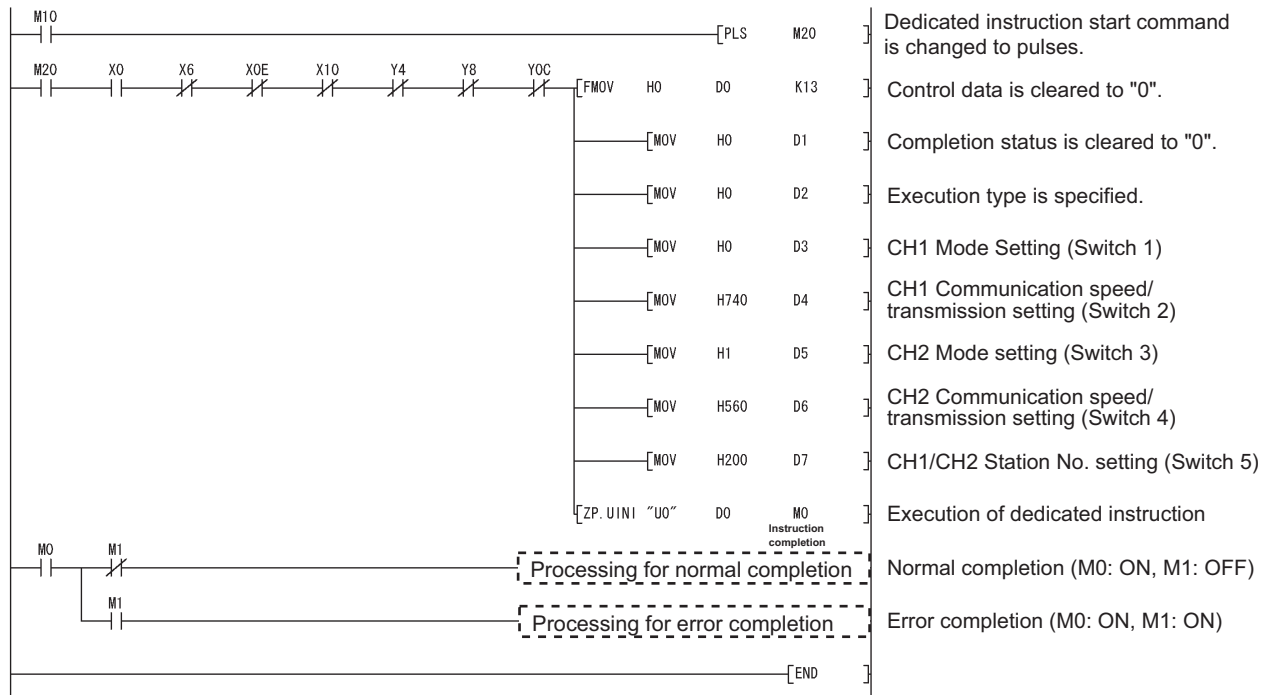

Figure 10.20 UINI instruction program example

CHAPTER 11 TROUBLESHOOTING

This chapter explains the details of errors and corrective actions.

11.1 Troubleshooting

(1) Troubleshooting of errors indicated by LEDs

Table 11.1 Troubleshooting list of errors indicated by LEDs

No.	Symptom	Check point	Corrective action	Reference	
1	The RUN LED turned off.	Check the mounting status of the QJ71MB91.	Switch OFF the power and remount the QJ71MB91.	Section 6.1	
		Check the power supply capacity.	Replace the power supply module.	Section 3.1	
		Check the programmable controller CPU for an error.	If the programmable controller CPU is faulty, take corrective actions according to the QCPU User's Manual (Hardware Design, Maintenance and Inspection).	-	
		Check for a watch dog timer error (X1F).	<ul style="list-style-type: none"> Reset the programmable controller CPU or reapply the power. If the problem persists even after the reset, a possible cause is a hardware fault. Perform a hardware test, and replace the QJ71MB91. 	Section 6.4.1	
2	The ERR.LED turned on.	Check the operation mode setting value of the intelligent function module switch.	Check the setting range of each intelligent function module switch, and correct the value.	Section 6.6	
		Check the transmission setting status value of the intelligent function module switch.			
		Check the station number setting value of the intelligent function module switch.			
		Check that the QJ71MB91 is not mounted with an A-mode QCPU.	Mount the QJ71MB91 on a Q-mode QCPU.	Section 2.1	
		Check if the module is in the hardware or self-loopback test mode.	<ul style="list-style-type: none"> Perform the test again after checking the mounting status of the QJ71MB91. If the ERR.LED turns on again, a possible cause is a hardware fault. Replace the QJ71MB91. 	Section 6.4.1 Section 6.4.2	
		Refer to "The RUN LED turned off."			This section (1)-1
		Check if the automatic communication parameter setting, error completed (X5/XD) is ON.	Refer to "Automatic communication parameter setting, error completed (X5/XD) turned on."	This section (2)-3	
Check if the MODBUS [®] device assignment parameter setting, error completed (X9) is ON.	Refer to "MODBUS [®] device assignment parameter setting, error completed (X9) turned on."	This section (2)-4			

(Continued on next page)

Table 11.1 Troubleshooting list of errors indicated by LEDs (Continued)

No.	Symptom	Check point	Corrective action	Reference
2	The ERR.LED turned on.	Check if the automatic communication error status (X7/XF) is ON.	Refer to "Automatic communication error status (X7/XF) turned on." Turn off the ERR. LED.	This section (2)-7
		When the dedicated instruction is used, check it for an error.	Refer to "Dedicated instruction failed." Turn off the ERR. LED.	This section (3)-2
		Check the error code in the error log.	Take corrective actions for the error code. Turn off the ERR. LED.	Section 11.4.1 Section 11.5
		Refer to "Communication with target device is not available even if parameter setting has been completed normally."		This section (3)-7
3	The NEU. LED does not flash.	When using the automatic communication function	Refer to "Automatic communication operation status (X6/XE) does not turn on." or "Automatic communication error status (X7/XF) turned on."	This section (2)-5,(2)-7
		When using a dedicated instruction	Refer to "Dedicated instruction is not executed."	This section (3)-1
		When using the slave function	Refer to "The QJ71MB91 slave function does not return a response message to the request message."	This section (3)-3
		In use of the slave function, check the station number in the request message that is sent to the QJ71MB91.	Correct the station number.	CHAPTER 4 Section 6.6
4	The SD LED does not flash during data transmission. The RD LED does not flash during data reception.	When using the automatic communication function	Refer to "Automatic communication operation status (X6/XE) does not turn on." or "Automatic communication error status (X7/XF) turned on."	This section (2)-5,(2)-7
		When using a dedicated instruction	Refer to "Dedicated instruction is not executed."	This section (3)-1
		When using the slave function	Refer to "The QJ71MB91 slave function does not return a response message to the request message."	This section (3)-3

(2) Troubleshooting of errors indicated by X signals

Table 11.2 Troubleshooting of errors indicated by X signals

No.	Symptom	Check point	Corrective action	Reference
1	The Module READY (X0) turned off.	Refer to "The RUN LED turned off."		This section (1)-1
2	The Watch dog timer error (X1F) turned on.			
3	The Automatic communication parameter setting, error completed (X5/XD) turned on.	Check the Automatic communication parameter error code storage area (address: 0C16 _H /0C18 _H) in the buffer memory and identify the error code.	Take corrective actions for the error code and retry.	Section 11.4
4	The MODBUS [®] device assignment parameter setting, error completed (X9) turned on.	Check the MODBUS [®] device assignment parameter error code storage area (address: 0C13 _H) in the buffer memory and identify the error code.	Take corrective actions for the error code and retry.	Section 11.4
5	The Automatic communication operation status (X6/XE) does not turn on.	Check if the automatic communication function is activated.	Set the automatic communication parameters by GX Configurator-MB and activate them. Or, set the automatic communication parameters by a sequence program and activate them.	Section 7.2 Section 9.1.1
		Check if the Automatic communication parameter setting, error completed (X5/XD) is on.	Refer to "The Automatic communication parameter setting, error completed (X5/XD) turned on."	This section (2)-3
6	The Automatic communication operation status (X6/XE) turned off.	Check if the Automatic communication stop request (Y6/YE) has been issued.	Restart the automatic communication function.	Section 5.2.1
		Was the UINI instruction executed?	After execution of the UINI instruction, set the automatic communication parameters again, and start the automatic communication function.	Section 7.2
7	The Automatic communication error status (X7/XF) turned on.	Check if the communication with the target device is possible.	Check the Automatic communication operation status storage area (0C20 _H to 0C21 _H /0C22 _H to 0C23 _H) in the buffer memory and identify the parameter number of the error cause. Take corrective actions according to the error code currently stored in the Automatic communication error code storage area (0C28 _H to 0C47 _H /0C48 _H to 0C67 _H) or the exception code sent from the target slave.	Section 11.4

(Continued on next page)

Table 11.2 Troubleshooting of errors indicated by X signals (Continued)

No.	Symptom	Check point	Corrective action	Reference
7	The Automatic communication error status (X7/XF) turned on.	Check if the timer settings in the automatic communication parameters are appropriate.	<ul style="list-style-type: none"> • Check the processing time of the target device. • Check if, because of a small request interval timer value, another request is transmitted before receiving a response from the target device. • Check if, because of a small response monitoring timer value, the timer has timed out with an error before the target device returns a response. For the error, set a larger response monitoring timer value. • Check if the next request was sent before completion of the processing of the target device because of a small broadcast delay value. For the error, set a larger broadcast delay value. 	Section 7.2.1
		Were the automatic communication function and the MBRW or MBREQ instruction used on the same channel?	Set automatic communication parameters and create a sequence program appropriately so that each of the MBRW and MBREQ instructions can be executed in the right timing.	Section 9.2.3
8	The CH common/CH1 error (X1B) or CH2 error (X1C) turned on.	Refer to "The ERR. LED turned on."		This section (1)-2
9	The MODBUS® device assignment parameter setting existence (XA) does not turn on.	Is the slave function used?	When the slave function is not used, the MODBUS® device assignment parameter setting existence (XA) is off.	-
		Is the MODBUS® device assignment parameter setting completed?	Set the MODBUS® device assignment parameters by GX Configurator-MB. Or, set the MODBUS® device assignment parameters by a sequence program.	Section 7.3 Section 9.1.2
			In the setting for the MODBUS® device assignment parameter starting method on the intelligent function module switch, select "OFF: Start with the default parameters".	Section 6.6
		Check if the MODBUS® device assignment parameter setting, error completed (X9) is on.	Refer to "MODBUS® device assignment parameter setting, error completed (X9) turned on."	This section (2)-4

(3) Troubleshooting for other symptoms

Table11.3 Troubleshooting for other symptoms

No.	Symptom	Check point	Corrective action	Reference
1	Dedicated instruction is not executed. (The completion device does not turn on.)	Check if the dedicated instruction is started.	Start the dedicated instruction.	-
		Is the programmable controller CPU in the RUN status?	Set the programmable controller CPU to RUN.	-
		Check if more than the maximum number of simultaneously executable dedicated instructions (one per channel) are started.	Complete the dedicated instruction currently executed, and then retry.	CHAPTER 10
		Check if the dedicated instruction is completed in error.	Refer to "Dedicated instruction failed."	This section (3)-2
		Check if a dedicated instruction is already being executed and the module is waiting for a response from the target device.	<ul style="list-style-type: none"> • Wait until the response monitoring timer for the dedicated instruction times out. • Check the status of the target device. • For the error, refer to "Dedicated instruction failed." 	This section (3)-2
2	Dedicated instruction failed.	Check the error code and/or exception code stored in the control data of the dedicated instruction.	Take corrective actions according to the error and exception codes, and retry.	CHAPTER 10 Section 11.4
		Does the target device support the function code?	<MBRW instruction> Modify the device type setting in the control data so that a function code supported by the target device will be issued.	Section 10.2
			<MBREQ instruction> Modify the send data so that a function code supported by the target device will be issued.	Section 10.3
		In the case of the MBREQ instruction, check if the contents of the request message is correct.	Correct the request message and retry.	CHAPTER 4 Section 10.3
		Check if the Response monitoring timer/ Broadcast delay of the dedicated instruction is appropriate.	<ul style="list-style-type: none"> • Check the processing time of the target device. • Check if, because of a small response monitoring timer value, the timer has timed out with an error before the target device returns a response. For the error, set a larger response monitoring timer value. • Check if the next request was sent before completion of the processing of the target device because of a small broadcast delay value. For the error, set a larger broadcast delay value. 	Section 7.2.1

(Continued on next page)

Table 11.3 Troubleshooting for other symptoms (Continued)

No.	Symptom	Check point	Corrective action	Reference
2	Dedicated instruction failed.	A request message, for which no response is expected, was sent to a slave by the MBREQ instruction. (Except for broadcast)	The response monitoring timer timeout error (error code: 7379 _H) may be regarded as normal completion.	Section 10.3 (6)
		Were the automatic communication function and the MBRW or MBREQ instruction used on the same channel?	Set automatic communication parameters and create a sequence program appropriately so that each of the MBRW and MBREQ instructions can be executed in the right timing.	Section 9.2.3
		Refer to "Communication with the target device is not available even if parameter setting has been completed normally."		This section (3)-7
3	The QJ71MB91's slave function does not return a response message to the request message.	Check if the MODBUS [®] device assignment parameter setting existence (XA) is on.	Refer to "MODBUS [®] device assignment parameter setting existence (XA) does not turn on."	This section (2)-9
		Has the QJ71MB91 returned any exception code?	Confirm the exception code and take corrective actions.	Section 11.4.2
		Check the Error log (address: 0CFE _H to 0DFF _H) in the buffer memory and identify the error code.	Take corrective actions for the error code.	Section 11.4.1
		Are the contents of the request message sent from the master to the QJ71MB91 correct?	Correct the request message to be issued from the master.	CHAPTER 4
		Is the station number in the request message sent from the master to the QJ71MB91 correct?	Specify the station number of the QJ71MB91 in the request message to be sent from the master.	CHAPTER 4
		Refer to "Communication with the target device is not available even if parameter setting has been completed normally."		This section (3)-7
4	An error is found in the error log.	Check the Error log (address: 0CFE _H to 0DFF _H) in the buffer memory and identify the error code.	Take corrective actions for the error code.	Section 11.4.3
		Refer to "Communication with the target device is not available even if parameter setting has been completed normally."		This section (3)-7

(Continued on next page)

Table 11.3 Troubleshooting for other symptoms (Continued)

No.	Symptom	Check point		Corrective action	Reference
5	The diagnostic counter has counted up.	Master	Received exception error count	Check the exception code returned from the slave by the Error log (address: 0CFE _H to 0DFF _H) in the buffer memory, and examine the slave to solve the problem.	Section 11.3 Section 11.4.1
			No-response count	Refer to the corrective actions for the response monitoring timer timeout error (error code: 7378 _H to 7379 _H).	Section 11.3 Section 11.4.3
			Received NAK count	Examine the slave that returned the error, and solve the problem.	-
			Received busy count		
		Message discard count	<ul style="list-style-type: none"> When there is another master on the same network, disconnect the master. When a response is returned after occurrence of the response monitoring timer timeout error, refer to the corrective actions for the error (error code: 7378_H to 7379_H). When any of the other stations has sent a message without receiving a request, examine the station. 	Section 11.3 Section 11.4.3	
		Slave	Message discard count	There is no problem as messages addressed to other stations are discarded.	Section 11.3
Exception error count	Check the Error log (address: 0CFE _H to 0DFF _H) in the buffer memory and take corrective actions for the error code.	Section 11.4.1			

(Continued on next page)

Table 11.3 Troubleshooting for other symptoms (Continued)

No.	Symptom	Check point	Corrective action	Reference	
5	The diagnostic counter has counted up.	Master/ Slave	Bus communication error count	Check the Error log (address: 0CFE _H to 0DFF _H) in the buffer memory and take corrective actions for the error code.	Section 11.4.1
			Character overrun error count	Refer to the corrective actions for the character overrun error (error code: 7399 _H)	Section 11.3 Section 11.4.3
			Data discard count	<ul style="list-style-type: none"> If it is caused by connecting the module to the online network, powering it on and accessing the network, do not perform such kind of operation. No specific action is necessary if there is no problem. If it is caused by turning off, resetting or disconnecting the device in transmission from the line, reset, do not perform such kind of operation during transmission. No specific action is necessary if there is no problem. If the message is erroneous, refer to "Communication with the target device is not available even if parameter setting has been completed normally." 	This section (3)-7
			Failed transmission count	Refer to the corrective actions for the CS signal OFF error (error code: 7403 _H)	Section 11.4.3
6	An error is found in the communications event log.	Communication error occurred.	Check the Error log (address: 0CFE _H to 0DFF _H) in the buffer memory and take corrective actions for the error code.	Section 11.4.1	
		Character overrun error occurred.	Refer to the corrective actions for the character overrun error (error code: 7399 _H)	Section 11.4.3	
		Message error occurred.	Check the Error log (address: 0CFE _H to 0DFF _H) in the buffer memory and take corrective actions for the error code.	Section 11.4.1	
		Processing interrupt occurred.			
7	Communication with the target device is not available even if parameter setting has been completed normally.	Is the station number setting correct?	If there is a problem with the setting, correct the intelligent function module switch setting and reset the module.	Section 6.6	
		Check if the transmission settings of the QJ71MB91 are consistent with those of the target device.	Check the settings again and if there is a problem with the setting, correct the intelligent function module switch setting and reset the module.	Section 6.6	
		Is the frame mode setting (RTU mode/ ASCII mode) correct?	If there is a problem with the setting, correct the intelligent function module switch setting and reset the module.	Section 6.6	

(Continued on next page)

Table11.3 Troubleshooting for other symptoms (Continued)

No.	Symptom	Check point	Corrective action	Reference
7	Communication with the target device is not available even if parameter setting has been completed normally.	Is the communication cable between the QJ71MB91 and the target device securely connected?	Securely connect the communication cable.	Section 6.5
		Is the communication cable wiring correct?	Check the specifications of the communication cable used.	Section 3.2 Section 3.3
		Are the specifications of the communication cable in use correct?	Confirm the specifications of the communication cable used.	Section 3.2 Section 3.3
		When both of 2-wire and 4-wire devices are used with RS-422/485, is the wiring correct?	Check the specifications of each device, and examine the wiring.	Section 6.5.2
		Check the communication target device. <ul style="list-style-type: none"> • Check for errors. • Check if the device is ready for operation. • Check if it attempts to communicate with the QJ71MB91. 	If a problem is identified on the communication target device, take corrective actions.	-
		Check for any other masters if the QJ71MB91 is the master.	Only one master is allowed on the MODBUS [®] system. Disconnect the other master.	-
		When the QJ71MB91 is the master, check if the communication target device is a MODBUS [®] slave device.	Set a MODBUS [®] slave device as the communication target.	-
When the QJ71MB91 is a slave, check if the communication target device is a MODBUS [®] master device.	Set a MODBUS [®] master device as the communication target device.	-		
8	The interval of the communications with the slave in the automatic communication function is longer than the time set by the automatic communication parameter, Request interval timer value. The time to complete the dedicated instruction is too long.	Check the communication target device. <ul style="list-style-type: none"> • Check for errors. • Check if the device is ready for operation. 	If a problem is identified on the communication target device, take corrective actions.	-
		Check if some send requests by the automatic communication function and dedicated instruction were concurrently issued on the QJ71MB91 side.	<ul style="list-style-type: none"> • It takes time to send concurrently issued requests as they are processed in sequence. Reduce the load on the QJ71MB91. • Set appropriate automatic communication parameters and create a proper sequence program so that each of dedicated instructions can be executed in the right timing. 	Section 9.2.3
		Check if it takes time for the target device to respond.	<ul style="list-style-type: none"> • Check the processing performance of the communication target device. • If a problem is identified on the communication target device, take corrective actions. 	-

(Continued on next page)

Table11.3 Troubleshooting for other symptoms (Continued)

No.	Symptom	Check point	Corrective action	Reference
9	The QJ71MB91 responds slowly.	Check the specifications using the processing time performance expression of the QJ71MB91 slave function.	The processing time must be within the range indicated by the result of the performance expression. The processing time may be slower than the result of the performance expression if two channels are used simultaneously.	Appendix 3
		When accessing the programmable controller CPU device in the slave function, check if too many accesses to the programmable controller CPU are made from other modules or the sequence program.	Reduce the load of the programmable controller CPU.	-

11.2 Checking QJ71MB91 Status

This section explains how to check the QJ71MB91 status.

Table 11.4 Status checking method

Method	Reference
LEDs on QJ71MB91	This section (1)
Monitor/Test screen of GX Configurator-MB	This section (2)
System monitor screen of GX Developer	This section (3)
Input signals (X)	This section (4)
Buffer memory	This section (5)

(1) LEDs on QJ71MB91

Whether an error is occurring or not can be checked by the LEDs on the QJ71MB91.

(☞ Section 6.3)

Detailed error check is performed as shown in (2) and subsequent sections.

The LED status on the QJ71MB91 can also be confirmed by the LED status area in the buffer memory. (address: 0C05H)

LED status area (address: 0C05H)

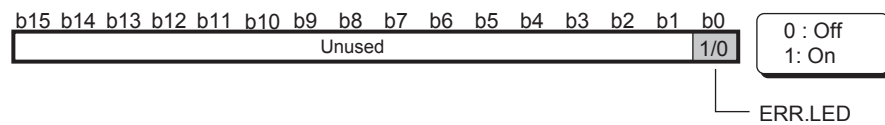

Figure 11.1 Configuration of LED status area

(2) Monitor/Test screen of GX Configurator-MB

GX Configurator-MB has a monitor/test screen for the status display and testing of the QJ71MB91.

Check the status of the QJ71MB91 on the Monitor/test screen. (☞ Section 8.6)

(3) System monitor screen of GX Developer

The module status of the QJ71MB91 can be confirmed on the System monitor screen.

(a) Confirming the status on Module's Detailed Information of GX Developer

1) Starting procedure

GX Developer → [Diagnostics] → [System monitor] →

Module's Detailed Information

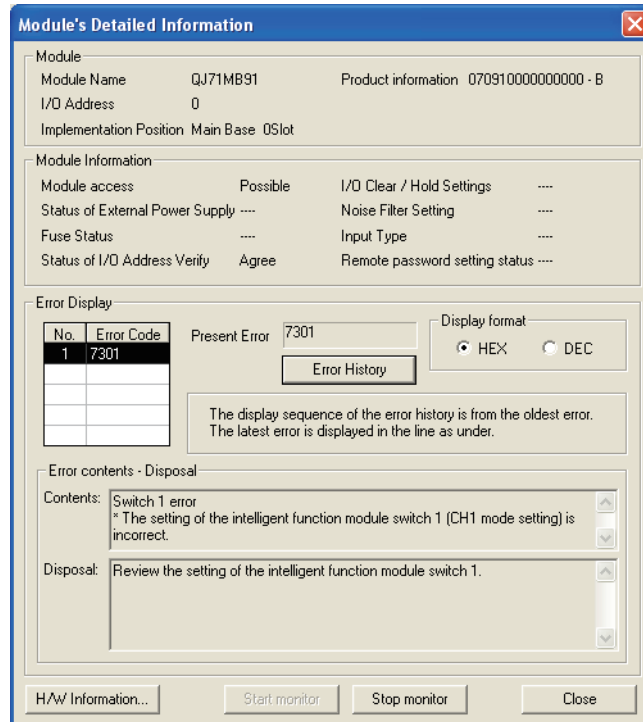

Figure 11.2 Module's Detailed Information

2) Display data

Table11.5 Displayed data of Module's Detailed Information

Item		Description
Module	Module Name	Displays the model name of the target module.
	I/O Address	Displays the head I/O number of the target module.
	Implementation Position	Displays the slot position where the module is mounted.
	Product information	Displays the serial No. and function version of the target module.* ¹
Module information	Module access	Displays Enable when the Module READY (X0) is on and the Watch dog timer error (X1F) is off.
	Status of I/O Address Verify	Displays whether or not the module parameterized by the user matches the mounted module.
Error Display	Present Error	Displays the error code of the latest error. (☞ Section 11.4)
	Error display	Displays the latest 16 error codes that are stored in the Error log (address: 0CFE _H to 0DFF _H) of the buffer memory.
Error contents - Disposal	Contents	Displays the error contents and disposal for the error code selected in Error Display.* ²
	Disposal	

* 1 The alphabet at the end of the Product information indicates the function version of the module. The function version of the QJ71MB91 is available from B.

Example: The end character of "B" indicates that the module is of function version B.

* 2 Display of the contents and disposal is available on GX Developer Version 8.29F or later.

- (b) Confirming the status on H/W Information of GX Developer
The H/W Information can be confirmed on GX Developer 8.29F or later.

1) Starting procedure

GX Developer → [Diagnostics] → [System monitor]

→ [Module's Detailed Information] → [H/W Information]

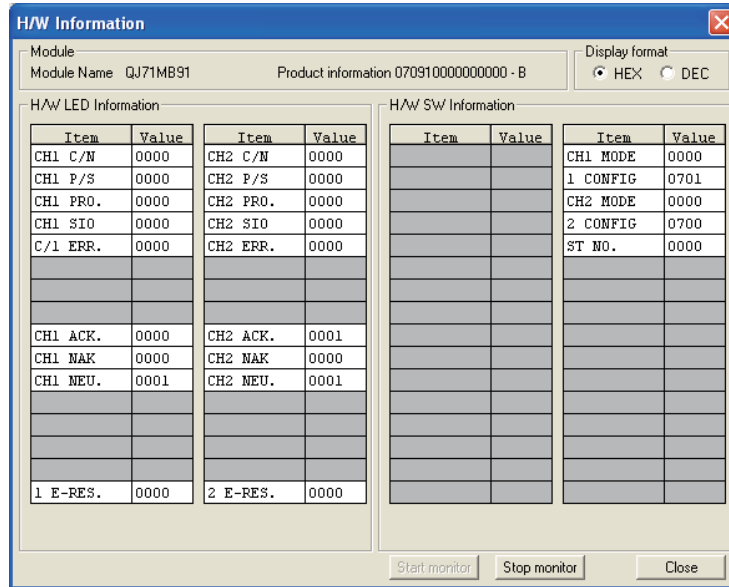

Figure 11.3 H/W information

2) Display data

(H/W LED Information)

The detailed LED status of the QJ71MB91 is displayed.

The displayed values correspond to those in the Detailed LED status storage area (address: 0006H /0007H) of the buffer memory.

CH1 side Detailed LED status storage area (address: 0006H)

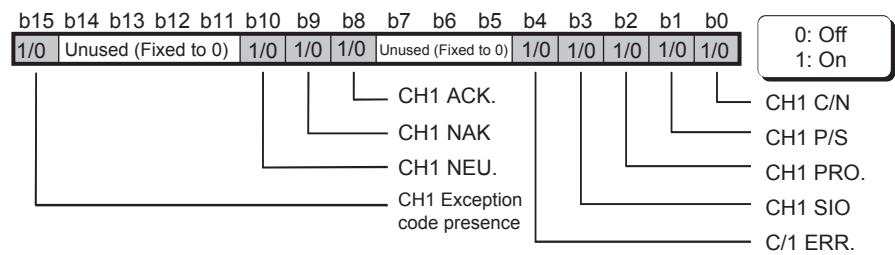

CH2 side Detailed LED status storage area (address: 0007H)

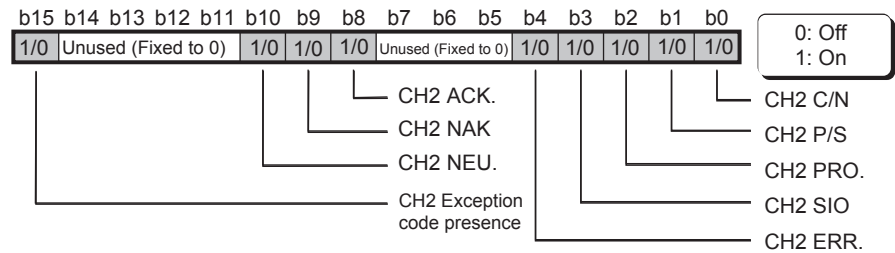

Figure 11.4 Detailed LED status storage area

Table11.6 Display data of H/W information

No.	Status signal name	Description	Lit When it is ON (1)	Unlit When it is OFF (0)
0	C/N ^{*2}	Status of access with programmable controller CPU	(*1)	Normal
1	P/S ^{*2}	Parity error or sum check error status	Error occurred	Normal
2	PRO. ^{*2}	Communication protocol error status	Request message analysis error	Normal
3	SIO ^{*2}	SIO error status	Framing error or overrun error occurred	Normal
4	C/1 ERR. ^{*2}	CH common or CH1 side error occurred	Intelligent function module switch setting error, parameter error, etc.	Normal
	CH2 ERR. ^{*2}	CH2 side error occurred		
5	(Unused)			
6				
7				
8	ACK.	Normal completion	Master : Communication processing normally completed Slave : Request message processing normally completed	Master : Communication not processed/Communication processing completed in error Slave : Request message not processed/Request message processing completed in error
9	NAK	Error completion	Master : Communication processing completed in error Slave : Request message processing completed in error	Master : Communication not processed/Communication processing normally completed Slave : Request message not processed/Request message normally completed
A	NEU.	Neutral status	Master : Communication not processed Slave : Wait for request message	Master : Communication in processing Slave : Request message in processing
B	(Unused)			
C				
D				
E				
F	n E-RES.	Presence of error response	Error response occurred	Normal

* 1 This status signal turns on if data write is requested to the programmable controller CPU while online change is disabled in the intelligent function module switch setting (☞ Section 6.6) of GX Developer. It also turns on when an error occurs in access between the QJ71MB91 and the programmable controller CPU.

* 2 This status signal does not automatically turn off even if the cause of the error is removed. To turn this off, perform the processing for turning off the LED after removing the error cause.

(☞ Section 11.5)

(H/W SW Information)

The intelligent function module switch status of the QJ71MB91 is displayed.

The displayed values correspond to those in the intelligent function module switch setting status (address:0C00H to 0C04H) of the buffer memory.

Table11.7 Display of H/W SW information

No.	Status signal name	Description	Reference
1	CH1 MODE	Switch 1: CH1 operation mode setting status	Section 6.6
2	1 CONFIG	Switch 2: CH1 transmission setting status	
3	CH2 MODE	Switch 3: CH2 operation mode setting status	
4	2 CONFIG	Switch 4: CH2 transmission setting status	
5	ST NO.	Switch 5: CH1/CH2 Station No. setting status	

(4) Input signals (X)

The status of the QJ71MB91 can be confirmed by the input signals shown below.

Table11.8 Input signals for status check

Input signal	Description	Error type	Reference
X1B	CH common/CH1 error	General	Section 11.1
X1C	CH2 error		
X1F	Watch dog timer error	H / W error	
X5	CH1 Automatic communication parameter setting, error completed	Automatic communication function	
XD	CH2 Automatic communication parameter setting, error completed		
X7	CH1 Automatic communication error status		
XF	CH2 Automatic communication error status		
X9	MODBUS [®] device assignment parameter setting, error completed	MODBUS [®] device assignment function	

(5) Buffer memory

The QJ71MB91 status can be confirmed with the buffer memory.

- Detailed LED status (☞ This section(3)(b))
- Error confirmation (☞ Section 11.4)

11.3 Checking the Communication Status of QJ71MB91

The QJ71MB91 counts the number of times that errors occur during communication. The communication status of QJ71MB91 can be checked by this counter (diagnostic counter).

(1) Diagnostic counter

(a) Master function

Table11.9 List of diagnostic counters (Master function)

Item	Description	Buffer memory	
		CH1	CH2
Bus message count	Counts the number of messages sensed on the line. The bus message count is in an exclusive relationship with the bus communication error count.	0F00H (3840)	0F40H (3904)
Bus communication error count	Counts the number of error messages sensed on the line. "Error messages" include the following: <ul style="list-style-type: none"> • CRC/LRC error message • Overrun/parity error • Short frame (less than 3 bytes) • Character overrun (256 bytes or more) Messages other than the above are counted by the bus message count. (The bus communication error count is in an exclusive relationship with the bus message count.)	0F01H (3841)	0F41H (3905)
Received exception error count	Counts the number of times that exception errors are received. (excluding the case of broadcast)	0F0EH (3854)	0F4EH (3918)
Received NAK count*1*2	Counts the number of times that NAK responses were received from slaves.	0F11H (3857)	0F51H (3921)
Received busy count*2	Counts the number of times that busy responses were received from slaves.	0F12H (3858)	0F52H (3922)
Character overrun error count	Counts the number of times that the request message size exceeded the upper limit.	0F02H (3842)	0F42H (3906)
Message discard count	Counts the number of times that a response message was discarded, for example, when a message from an unexpected station number was received.	0F03H (3843)	0F43H (3907)
Data discard count	Counts the number of times that illegal data (e.g. frames not configured in the stipulated response message format) was discarded.	0F04H (3844)	0F44H (3908)
Failed transmission count	Counts the number of times that transmission of request messages failed. (e.g. when no cable is connected)	0F05H (3845)	0F45H (3909)
No-response count	Counts the number of times that there was no response from a slave after request message transmission. (Number of response monitoring timer timeouts) It does not count for broadcast request messages.	0F0FH (3855)	0F4FH (3919)
Broadcast count	Counts the number of times that request messages were broadcast.	0F10H (3856)	0F50H (3920)

- * 1 The NAK count defined by the MODBUS[®] protocol is stored in the Received NAK count. Note that this count is different from the NAK LED on the QJ71MB91.
- * 2 It does not count when the request message is sent by the MBREQ instruction.

(b) Slave function

Table 11.10 List of diagnostic counters (Slave function)

Item	Description	Sub-function *1	Buffer memory	
			CH1	CH2
Bus message count	Counts the number of messages sensed on the line. The bus message count is in an exclusive relationship with the bus communication error count.	0011	0F00H (3840)	0F40H (3904)
Bus communication error count	Counts the number of error messages sensed on the line. "Error messages" include the following: <ul style="list-style-type: none"> • CRC/LRC error message • Overrun/parity error • Short frame (less than 3 bytes) • Character overrun (256 bytes or more) Messages other than the above are counted by the bus message count. (The bus communication error count is in an exclusive relationship with the bus message count.)	0012	0F01H (3841)	0F41H (3905)
Exception error count	Counts the number of times that exception errors are occurred. (excluding broadcast communication messages)	0013	0F0AH (3850)	0F4AH (3914)
Slave message count	Counts the number of times that messages addressed to the host were processed. (Including when reception of broadcast request messages)	0014	0F06H (3846)	0F46H (3910)
Slave no-response count	Counts the number of times that broadcast request messages were received.	0015	0F07H (3847)	0F47H (3911)
Slave NAK count*2	Counts the number of times that the slave returned the NAK response to the master. The QJ71MB91 always stores "0".	0016	0F08H (3848)	0F48H (3912)
Slave busy count	Counts the number of times that the slave returned a busy response to the master. The QJ71MB91 always stores "0".	0017	0F09H (3849)	0F49H (3913)
Character overrun error count	Counts the number of times that the request message size exceeded the upper limit.	0018	0F02H (3842)	0F42H (3906)
Message discard count	Counts the number of times that request messages are discarded, for example, due to reasons such as processing of another request message on a slave or reception of a request message addressed to another station.	-	0F03H (3843)	0F43H (3907)
Data discard count	Counts the number of times that illegal data (e.g. frames not configured in the stipulated request message format) was discarded.	-	0F04H (3844)	0F44H (3908)
Failed transmission count	Counts the number of times that transmission of response messages failed. (e.g. when no cable is connected)	-	0F05H (3845)	0F45H (3909)

* 1 Sub-functions in the table show sub-function codes of function code 8. (Section 4.11)

* 2 The NAK count defined by the MODBUS® protocol is stored in the Slave NAK count.
Note that this count is different from the NAK LED on the QJ71MB91.

(2) Count range

Counting is performed up to FFFF_H.

Counting is stopped when the count reaches FFFF_H.

To continue counting, clear the diagnostic counter.

(☞ This section (3))

(3) Clearing the diagnostic counters

The diagnostic counters can be cleared by any of the following methods:

(a) Diagnostic counters for Master function (☞ ThisSection (1)(a))

- Power OFF → ON
- Resetting the programmable controller CPU

(b) Diagnostic counters for Slave function (☞ ThisSection (1)(b))

- When receiving the Clear Counters and Diagnostic Register ^{*1} (☞ Section 4.11.6)
- When receiving the Restart communications option ^{*1} (☞ Section 4.11.2)
- When receiving the Clear Overrun Counter and Flag ^{*2} (☞ Section 4.11.6)
- Clearing the buffer memory to "0" by sequence program
- Power OFF → ON
- By resetting the programmable controller CPU

* 1 The Message discard count, Data discard count and Failed transmission count are not cleared.

* 2 Only the Character overrun error count is cleared.

(4) Cautions

Diagnostic counters are not cleared while the QJ71MB91 is sending data.

Use the values of the diagnostic counters for checking the communication status.

11.4 Error Codes

11.4.1 Error code storage area

Each error code is stored in any of the following buffer memory areas.

Table 11.11 Error code storage area

Error type		Area name		Buffer memory		Reference
				CH1	CH2	
Parameter error information	Automatic communication parameter	Automatic communication parameter error code storage area		0C16H (3094)	0C18H (3096)	This section (1)
		Automatic communication parameter setting result storage area		0C17H (3095)	0C19H (3097)	This section (2)
	MODBUS® device assignment parameter	MODBUS® device assignment parameter error code storage area		0C13H (3091)		This section (3)
		MODBUS® device assignment parameter setting result storage area	Error, device type	0C14H (3092)		This section (4)
			Error, assigned group No.	0C15H (3093)		
Master function	Automatic communication function	Automatic communication operation status storage area (parameters 1 to 32)		0C20H to 0C21H (3104 to 3105)	0C22H to 0C23H (3106 to 3107)	This section (5)
		Automatic communication error code storage area (parameters 1 to 32)		0C28H to 0C47H (3112 to 3143)	0C48H to 0C67H (3144 to 3175)	This section (6)
		Automatic communication setting status storage area (parameters 1 to 32)		0CA8H to 0CA9H (3240 to 3241)	0CAAH to 0CABH (3242 to 3243)	This section (7)
		Error log		0CFEH to 0DFFH (3326 to 3583)		This section (8)
	Dedicated instruction	Error log		0CFEH to 0DFFH (3326 to 3583)		This section (8)
Slave function	Error response code storage area		0002H (2)	0004H (4)	Section 11.4.2	
	Error log		0CFEH to 0DFFH (3326 to 3583)		This section (8)	

(1) Automatic communication parameter error code storage area

When an error occurs with the Automatic communication parameter setting request/Automatic communication start request (Y4/YC) ON, the corresponding error code is stored in this area.

(a) Storage timing

The error code is stored when the Automatic communication parameter setting, error completed (X5/XD) turns ON.

(b) Clear timing

The error code is cleared when the Automatic communication parameter setting, normally completed (X4/XC) signal turns ON.

(2) Automatic communication parameter setting result storage area

When an automatic communication parameter error occurs with the Automatic communication parameter setting request/Automatic communication start request (Y4/YC) ON, the automatic communication parameter number corresponding to the error is stored in this area.

(a) Storage timing

The automatic communication parameter number is stored when the Automatic communication parameter setting, error completed (X5/XD) turns ON.

(b) Clear timing

The automatic communication parameter number is cleared when the Automatic communication parameter setting, normally completed (X4/XC) turns ON.

(3) MODBUS[®] device assignment parameter error code storage area

When an error occurs with the MODBUS[®] device assignment parameter setting request (Y8) ON, the corresponding error code is stored in this area.

(a) Storage timing

The error code is stored when the MODBUS[®] device assignment parameter setting, error completed (X9) turns ON.

(b) Clear timing

The error code is cleared when the MODBUS[®] device assignment parameter setting, normally completed (X8) turns ON.

(4) MODBUS[®] device assignment parameter setting result storage area

When a MODBUS[®] device assignment parameter error occurs with the MODBUS[®] device assignment parameter setting request (Y8) ON, the device type and assigned group No. of the error device are stored in this area.

(a) Storage timing

The device type and assigned group No. are stored when the MODBUS[®] device assignment parameter setting, error completed (X9) turns ON.

(b) Clear timing

The device type and assigned group No. are cleared when the MODBUS[®] device assignment parameter setting, normally completed (X8) turns ON.

(c) Error device type to be stored

The following values are stored to show the error device type when the MODBUS[®] device assignment parameter setting, error completed (X9) turns ON.

Table 11.12 Device type to be stored

Error, device type	Value to be stored
Coil	0001H (1)
Input	0002H (2)
Input register	0004H (4)
Holding register	0005H (5)

(5) Automatic communication operation status storage area

The operation statuses of the automatic communication function are stored in bit format in correspondence with automatic communication parameters 1 to 32.

The operation statuses are stored in the relevant bit positions, from low-order to high-order bits, in order of automatic communication parameters 1 to 32.

(CH1 Automatic communication operation status storage area)

	b15	b14	b13	b12	b11	b10	. . .	b5	b4	b3	b2	b1	b0
0C20H	16	15	14	13	12	11	. . .	6	5	4	3	2	1
0C21H	32	31	30	29	28	27	. . .	22	21	20	19	18	17

(CH2 Automatic communication operation status storage area)

	b15	b14	b13	b12	b11	b10	. . .	b5	b4	b3	b2	b1	b0
0C22H	16	15	14	13	12	11	. . .	6	5	4	3	2	1
0C23H	32	31	30	29	28	27	. . .	22	21	20	19	18	17

Number indicates number of automatic communication parameter.

0: Operating normally/automatic communication parameter not set/automatic communication function stopped
 1: Automatic communication error occurred

Figure 11.5 Configuration of automatic communication function operation status storage area

- (a) Storage timing

The operation status is set at the following timing.

 - 1) When a response message (error completion) is received from a slave (Only the corresponding bit turns ON.)
 - 2) When a communication error occurs (Only the corresponding bit turns ON.)
- (b) Clear timing

The operation status is cleared at the following timing.

 - 1) When a response message (normal completion) is received from a slave (Only the corresponding bit turns ON)
 - 2) When the automatic communication function stops (All bits turn OFF.)
 - 3) When the power is turned off and then on again, or when the programmable controller CPU is reset (All bits turn OFF)
- (c) Interlock with a communication target device

The automatic communication operation status storage area can be utilized as an area of an interlock signal for errors at a communication target device. The following shows a program example.

 - 1) Program conditions

The QJ71MB91 is mounted in slot 0 of the base unit with the head I/O No. set to "0" and automatic communication parameter 1 used.
 - 2) Program example

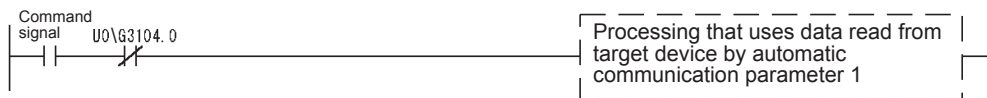

Figure 11.6 Interlock with communication target device

(6) Automatic communication error code storage area

When an error occurs in the automatic communication function, the error code corresponding to automatic communication parameters 1 to 32 is stored in this area.

- (a) Storage timing

When the automatic communication operation status bit turns ON, an error code is stored in the corresponding area.
- (b) Clear timing

The automatic communication error code storage area is not cleared. The error code is overwritten when a new error occurs.

(7) Automatic communication setting status storage area

Whether automatic communication parameter settings are present or not is stored in this area.

(CH1 Automatic communication setting status storage area)

	b15	b14	b13	b12	b11	b10	. . .	b5	b4	b3	b2	b1	b0
0CA8H	16	15	14	13	12	11	. . .	6	5	4	3	2	1
0CA9H	32	31	30	29	28	27	. . .	22	21	20	19	18	17

(CH2 Automatic communication setting status storage area)

	b15	b14	b13	b12	b11	b10	. . .	b5	b4	b3	b2	b1	b0
0CAAH	16	15	14	13	12	11	. . .	6	5	4	3	2	1
0CABH	32	31	30	29	28	27	. . .	22	21	20	19	18	17

Number indicates that of automatic communication parameter.

0: Automatic communication parameter not set
1: Automatic communication parameter set

Figure 11.7 Configuration of automatic communication setting status storage area

(a) Storage timing

Data are stored when the automatic communication function is started. (Only the corresponding bit turns ON.)

(b) Clear timing

The setting status is cleared at the following timing.

- 1) When the automatic communication function stops (All bits turn OFF.)
- 2) When the power is turned off and then on again, or when the programmable controller CPU is reset (All bits turn OFF.)

(8) Error log

Up to 32 latest errors are stored in the Error log area as an error history.

Table 11.13 Configuration of the Error log area

Error log area name		Address
Number of errors occurred		0CFE _H (3326)
Error log write pointer		0CFF _H (3327)
Error log 1	Detailed error code	0D00 _H (3328)
	Exception code	0D01 _H (3329)
	Function code	0D02 _H (3330)
	CH	0D03 _H (3331)
	Station No.	0D04 _H (3332)
	Function	0D07 _H (3335)
Error logs 2 to 32 (same as Error log 1)		0D08 _H to 0DFF _H (3336 to 3583)

(a) Number of errors occurred

The number of errors entered to the error log is stored.

If 65536 or more errors have occurred, the count stops at FFFF_H (65535).

(b) Error log write pointer

The number of the latest error log is stored.

0 : No error (No error log entry)

1 to 32 : Error log number where the latest error log was entered

(c) Error log (Error logs 1 to 32)

The error log area stores 32 latest errors.

The errors are stored in the chronological order, starting from Error log 1.

If 33 or more errors have occurred, the old error logs are overwritten, starting from Error log 1 area.

Table 11.14 Contents of error log

Item	Function			
	Automatic communication function	Dedicated instruction	Slave function	Others
Detailed error code	Stores an error code corresponding to the error that occurred at any timing, such as during processing of a request from the master, at power-on or when changing a MODBUS [®] device assignment parameter. (→ Section 11.4.3)			
Exception code	Stores the exception code that was returned from a slave in reply to a request message sent by the automatic communication function or dedicated instruction. (→ Section 11.4.2)		Stores the exception code returned to the master when an error occurs for a request message from the master. (→ Section 11.4.2)	Stores "0".
Function code	Stores the function code from which the error was originated.			Stores "0".
CH	Stores the channel number (1/2) where the error occurred. Stores "0" is if the channel is not identified.			
Station No.	Stores the station No. of the target station when an error occurred. Stores "0" is if the station No. is not identified.			
Function	Stores the function in which the error occurred: 0: No error 1: Automatic communication function 2: Dedicated instruction 3: Slave function 4: Other			

(9) Exception code storage area

When processing requested from the master is completed in error, an exception code that was returned to the master is stored. (→ Section 11.4.2)

11.4.2 Exception code list

"Exception code" is an error code common to the MODBUS[®] protocol, which is embedded in a response message when a slave returns an error response in reply to a request message sent from the master.

(1) When the QJ71MB91 is a master

When the QJ71MB91 (master) has received an exception code from the target device (slave), take corrective actions referring to the manual for the target device (slave).

(2) When the QJ71MB91 is a slave

When the target device (master) has received an exception code from the QJ71MB91 (slave), take corrective actions referring to the following.

(a) Exception code storage location

When processing on a slave (QJ71MB91) has completed in error, the exception code can be confirmed by the Error log area (address: 0CFE_H to 0DFF_H) in the buffer memory.

(b) Exception code list

The following is a list of exception codes used when the QJ71MB91 is a slave

Table 11.15 Exception code list

Exception code	Error name	Description	Corrective action	
			Target device (Master side)	QJ71MB91 (Slave side)
01 _H (1)	Illegal Function	The slave (QJ71MB91) received an unsupported function code.	Check function codes supported by the QJ71MB91, and modify the request message to be sent.	-
02 _H (2)	Illegal Data Address	The specified address of the MODBUS [®] device is erroneous.	Check the MODBUS [®] device type and size supported by the QJ71MB91, and correct the specified address in the request message to be sent.	-
03 _H (3)	Illegal Data Value	A value contained in the data unit of the request message is incorrect.	Review the data unit of the request message.	-
04 _H (4)	Slave Device Failure	An unrecoverable error occurred while the slave (QJ71MB91) was attempting to perform the requested action.	Review the data unit of the request message.	Remove the cause of the error occurred on the QJ71MB91 side. If the QJ71MB91 issued this code, check the error code in the Error log area and take corrective actions. (☞ Section 11.4.1 (8))

(Continued on next page)

Table 11.15 Exception code list (Continued)

Exception code	Error name	Description	Corrective action	
			Target device (Master side)	QJ71MB91 (Slave side)
05 _H (5)	Acknowledge	As the slave is executing another processing, a long duration of time is required to complete the requested processing.		
06 _H (6)	Slave Device Busy	As the slave is executing another processing, the requested processing cannot be executed.		
07 _H (7)	NAK Error	The requested program function cannot be executed on a slave.		
08 _H (8)	Memory Parity Error	A parity error was detected on a slave during access to the extension file register.	Not issued by the slave function of the QJ71MB91.	
0A _H (10)	Gateway Path Unavailable	The gateway device (MODBUS [®] /TCP → MODBUS [®] protocol) is not available for use.		
0B _H (11)	Gateway Target Device Failed To Respond	There is no response from the slave devices connected ahead of the gateway device.		

- (c) Error code issued when processing on the slave (QJ71MB91) was completed in error
- If processing on the slave (QJ71MB91) was completed in error, an exception code is stored in the buffer memory. On the QJ71MB91, an error code is also stored in the buffer memory to identify the detailed cause. (➤ Section 11.4.3)
- The error code can be checked by the Error log (address: 0CFE_H to 0DFF_H) in the buffer memory. (➤ Section 11.4.1 (8))

11.4.3 Error code list

When an error occurs in each processing on the QJ71MB91, the ERR.LED on the QJ71MB91 lights up, and an error code is stored to the buffer memory of the QJ71MB91. This section explains respective error details and corrective actions to be taken when an error occurred.

The "Occurrence" field of the following error code table indicates that an error may occur:

- 1) When powering on the programmable controller or writing parameters, which is common to the master and slave functions or not included in 2) to 5) below
- 2) When using the master function (Automatic communication function)
- 3) When executing a dedicated instruction
- 4) When using the slave functions (including entry of MODBUS® device assignment parameters)
- 5) When performing unit tests (Hardware test/Self-loopback test)

Table 11.16 Error code list

Error Code	Error Name	Description	Corrective Action	Occurrence				
				1)	2)	3)	4)	5)
3E8H to 4FFFH (1000 to 20479)	-	Error code issued by the programmable controller CPU	Refer to the following manual.  QCPU User's Manual (Hardware Design, Maintenance and Inspection)	○	○	○	○	○
7301H (29441)	Switch 1 error	The setting of the intelligent function module switch 1 (CH1 mode setting) is incorrect.	Review the setting of the intelligent function module switch 1.	○				
7302H (29442)	Switch 2 error	The setting of the intelligent function module switch 2 (CH1 Communication speed setting / transmission setting) is incorrect.	Review the setting of the intelligent function module switch 2.	○				
7303H (29443)	Switch 3 error	The setting of the intelligent function module switch 3 (CH2 mode setting) is incorrect.	Review the setting of the intelligent function module switch 3.	○				
7304H (29444)	Switch 4 error	The setting of the intelligent function module switch 4 (CH2 communication speed / transmission setting) is incorrect.	Review the setting of the intelligent function module switch 4.	○				
7305H (29445)	Switch 5 error	The setting of the intelligent function module switch 5 (CH1, 2 station No. setting) is incorrect.	Review the setting of the intelligent function module switch 5.	○				
7307H (29447)	RAM check error	An error was detected by the RAM check made at power-on.	Any of the QJ71MB91, programmable controller CPU or base unit may be faulty. Perform unit tests.	○				

(Continued on next page)

Table 11.16 Error code list (Continued)

Error Code	Error Name	Description	Corrective Action	Occurrence				
				1)	2)	3)	4)	5)
730AH (29450)	Parameter starting method error	Parameter setting using GX Configurator-MB was applied to the programmable controller CPU while the MODBUS [®] device assignment parameter starting method specified by the intelligent function module switch was set to "Start with the default parameters".	<ul style="list-style-type: none"> When using the default parameter setting, delete the QJ71MB91 parameters entered to the programmable controller CPU. When starting the QJ71MB91 with parameters set from GX Configurator-MB or the sequence program, turn ON the MODBUS[®] device assignment parameter starting method of the intelligent function module switch. 	○				
7327H (29479)	CPU response monitoring timer setting error	The CPU response monitoring timer value in the buffer memory (address: 000DH) is incorrect.	Review the CPU response monitoring timer value.				○	
7330H (29488)	Device code error	The device code value specified as a MODBUS [®] device assignment parameter is incorrect.	Review the device code value.				○	
7331H (29489)	MODBUS [®] device upper limit value over error	The head MODBUS [®] device number + assigned points in the MODBUS [®] device assignment parameter exceeds the maximum value (65535) allowed for the MODBUS [®] device.	Review the head MODBUS [®] device number and the number of assigned points.				○	
7332H (29490)	MODBUS [®] device assigned range overlap error	MODBUS [®] device ranges set with the MODBUS [®] device assignment parameters are overlapped.	Review the head MODBUS [®] device number and the number of assigned points.				○	
7333H (29491)	Buffer memory assigned range error	The assigned range of the QJ71MB91 buffer memory set with the MODBUS [®] device assignment parameter exceeds the range of the user free area.	Review the head device number and the number of assigned points.				○	
7334H (29492)	Device upper limit value over error	The head device number + assigned points in the MODBUS [®] device assignment parameter exceeds the maximum value (65535) allowed for the CPU device.	Review the head device number and the number of assigned points.				○	
7335H (29493)	Error status read device setting error	The specification of the error status read device is incorrect.	Review the setting of the error status read device.				○	
7336H (29494)	MELSECNET/H remote access target value error	The access target specification value is other than 0 and 1 when the QJ71MB91 is mounted on the MELSECNET/H remote I/O station.	Set the access target specification value to 0 or 1 when the QJ71MB91 is mounted on the MELSECNET/H remote I/O station.				○	
7337H (29495)	MELSECNET/H remote access target error	The access target (when mounted to MELSECNET/H remote I/O station) (address: 000EH) was set when the QJ71MB91 is not mounted on the MELSECNET/H remote I/O station.	Review the access target station or the specified access target value (when mounted to MELSECNET/H remote I/O station).				○	
7338H (29496)	Buffer memory setting error	Data were written to the system area (use prohibited) in the buffer memory.	Check whether or not writing to the system area (use prohibited) in the buffer memory was executed by the sequence program.	○			○	

(Continued on next page)

Table 11.16 Error code list (Continued)

Error Code	Error Name	Description	Corrective Action	Occurrence				
				1)	2)	3)	4)	5)
7340H (29504)	Target MODBUS [®] device type specification error	The set value of the target MODBUS [®] device type specification in the automatic communication parameter is incorrect.	Review the target MODBUS [®] device type specification value.		○			
7342H (29506)	Request interval timer value setting error	The set value of the request interval timer in the automatic communication parameter is incorrect.	Review the request interval timer value.		○			
7343H (29507)	Response monitoring timer setting error	The set value of the response monitoring timer in the automatic communication parameter is outside the allowable range.	Correct the response monitoring timer value so that it falls within the allowable range.		○			
7345H (29509)	Buffer memory address overlap error	The buffer memory setting ranges overlap between several automatic communication parameters.	Review the overlapping buffer memory settings and correct them.		○			
7346H (29510)	Buffer memory address range error	The buffer memory setting range in the automatic communication parameter is outside the range for the automatic communication function buffer input/output area.	Correct the invalid buffer memory setting.		○			
7347H (29511)	Automatic communication setting range error	Other than 0 and 1 is set in the automatic communication parameter setting existence.	Review the setting of the automatic communication parameter setting existence.		○			
7348H (29512)	MODBUS [®] device number setting range error	The MODBUS [®] device range for the read/write target set in the automatic communication parameter or dedicated instruction's control data exceeds the maximum value (65536).	Review the setting range of the MODBUS [®] device.		○	○		
7349H (29513)	MODBUS [®] device points setting error	The MODBUS [®] device range of the read/write target set as an automatic communication parameter or in dedicated instruction's control data exceeds the allowable range.	Review the setting range of the MODBUS [®] device.		○	○		
734AH (29514)	Target station number setting error	The target station number set as an automatic communication parameter or in dedicated instruction's control data is incorrect.	Review the target station number.		○	○		
734CH (29516)	Response monitoring timer setting error	The set value of the response monitoring timer in the dedicated instruction's control data is outside the allowable range.	Correct the response monitoring timer setting so that it falls within the allowable range.			○		
734EH (29518)	Write data storage size setting error	The set value of the write data storage size in the dedicated instruction's control data is incorrect.	Review the write data storage size value.			○		
734FH (29519)	Request message size setting error	The request message size specified as an argument ((S2)+0) of the MBREQ instruction is incorrect.	Review the request message size value.			○		

(Continued on next page)

Table 11.16 Error code list (Continued)

Error code	Error Name	Error definition	Corrective Action	Occurrence				
				1)	2)	3)	4)	5)
7350H (29520)	Automatic communication function start interruption	Failed to activate the automatic communication function because the GX Configurator-MB parameters were being entered at power-on.	<ul style="list-style-type: none"> Wait for the automatic communication parameters to be activated by GX Configurator-MB, and start the automatic communication function after stopping automatic communication. Wait for MODBUS® device assignment parameter setting existence (XA) to turn ON, and start the automatic communication function. Retry after a little while. 		○			
7353H (29523)	Operation mode error	Any slave function was attempted during master operation. Or, any master function was attempted during slave operation.	Check the mode or the operation.		○			
7355H (29525)	Channel No. error	The channel No. specification is wrong.	Review the channel No. specification.			○		
7360H (29536)	Exception message reception	When the automatic communication function or dedicated instruction was used, the target slave device returned an exception code in reply to the request message sent by the QJ71MB91.	Refer to the exception code returned from the target slave device, and solve the problem.		○	○		
7361H (29537)	Byte count error	In the automatic communication function or dedicated instruction, the number of bytes in the received response message is too small or large.	On the target slave device, check if the contents of the returned response message are correct or not.		○	○		
7362H (29538)	Reference number error	The reference number value in the response message received by the dedicated instruction is incorrect.				○		
7365H (29541)	Station No. mismatch error	In the automatic communication function or dedicated instruction, the station number in the received response message does not match the one in the corresponding request message.			○	○		
7366H (29542)	Function code mismatch error	In the automatic communication function or dedicated instruction, the function code in the received response message does not match the one in the corresponding request message.			○	○		
7367H (29543)	Response message contents mismatch error	In the automatic communication or dedicated instruction, the contents of the received response message are not consistent with those of the corresponding request message. (FC: 15, FC: 16, FC: 21)			○	○		

(Continued on next page)

Table 11.16 Error code list (Continued)

Error code	Error Name	Error definition	Corrective Action	Occurrence					
				1)	2)	3)	4)	5)	
7370H (29552)	Automatic communication function stop request error	The automatic communication stop request (Y6, YE) was made with the automatic communication function stopped.	Prevent the automatic communication stop request (Y6, YE) from being issued with the automatic communication function stopped.		○				
7371H (29553)	Automatic communication parameter setting request error	The automatic communication parameter setting request/automatic communication parameter start request (Y4, YC) was made with the automatic communication function active.	Stop the automatic communication function before making the automatic communication parameter setting request/automatic communication parameter start request (Y4, YC).		○				
7372H (29554)	Switch change error	In the control data of the UINI instruction, an out-of-range or invalid value is set.	Review the control data of the UINI instruction.	○	○	○	○		
7373H (29555)	Automatic communication parameters set during switch setting change	Automatic communication parameters were set during execution of the UINI instruction. Or, the UINI instruction was executed while automatic communication parameters were being set.	Prevent concurrent execution of the UINI instruction and auto communication parameter setting.		○	○			
7374H (29556)	MODBUS [®] device assignment parameters set during switch setting change	MODBUS [®] device assignment parameters were set during execution of the UINI instruction. Or, the UINI instruction was executed while MODBUS [®] device assignment parameters were being set.	Prevent concurrent execution of the UINI instruction and MODBUS [®] device assignment parameter setting.			○	○		
7378H (29560)	Response monitoring timer timeout error	The response monitoring timer timed out in the automatic communication function. In the case of broadcast, the broadcast delay has expired before completion of the request message transmission. When broadcast was performed beforehand, response is not possible because the slave is currently executing the processing requested by the broadcast.	<ul style="list-style-type: none"> • Check if the target device is operating normally. • If an error has occurred in the target device, remove the error. • Confirm the line connections (cables, wiring, etc.) with the target device. • Check the processing time of the target device. (Is the set value too small? Does the timeout error occur before response of the target device or before completion of the request message transmission?) • Set a larger value. • When the automatic communication function and the MBRW or MBREQ instruction are used on the same channel, set appropriate automatic communication parameters and create a proper sequence program so that the MBRW or MBREQ instruction can be executed in the right timing. (Section 9.2.3) • When broadcast delay was performed beforehand, check if the broadcast delay value is sufficient. • If this error occurs when a request message, for which no response is expected, is sent to a slave by the MBREQ instruction, this error may be regarded as a normal completion. (Section 10.3 (6)) 		○				
7379H (29561)		The response monitoring timer timed out when using the dedicated instruction. In the case of broadcast, the broadcast delay has expired before completion of the request message transmission. When broadcast was performed beforehand, response is not possible because the slave is currently executing the processing requested by the broadcast. A request message, for which no response is expected, was sent to a slave by the MBREQ instruction. (excluding the case of broadcast)					○		
737BH (29563)		Request interval timer timeout error		The time for issuing the next request was reached before the current request is completed.			○		

(Continued on next page)

Table 11.16 Error code list (Continued)

Error code	Error Name	Error definition	Corrective Action	Occurrence				
				1)	2)	3)	4)	5)
737CH (29564)	Simultaneous execution error	Two kinds of dedicated instructions were executed simultaneously on the same channel.	Execute the next instruction after completion of the currently executing instruction.			○		
7380H (29568)	CPU response monitoring timer timeout	The CPU response monitoring timer timed out in the slave function.	<ul style="list-style-type: none"> If an error has occurred in the programmable controller CPU, remove the error. Set a larger value for the CPU response monitoring timer. 				○	
7381H (29569)	Function code error	A request message with a function code that is not supported by the QJ71MB91 slave function was received.	Confirm the function codes supported by the QJ71MB91 slave function, and review the request message to be sent.				○	
7382H (29570)	Sub-code error	The request message with a sub-code that is not supported by the QJ71MB91 slave function was received.	Confirm the sub-codes supported by the QJ71MB91 slave function, and review the request message to be sent.				○	

(Continued on next page)

Table 11.16 Error code list (Continued)

Error code	Error Name	Error definition	Corrective Action	Occurrence				
				1)	2)	3)	4)	5)
7383H (29571)	MODBUS [®] device specification error	The MODBUS [®] device assignment parameters have not been set for the MODBUS [®] device specified in the received request message. The MODBUS [®] device assignment parameter setting is in process.	<ul style="list-style-type: none"> Set the MODBUS[®] device assignment parameters for the MODBUS[®] device specified in the request message. Adjust the timing for the request message transmission on the master side so that communication is started after the MODBUS[®] device assignment parameter setting existence (XA) turns ON. 				○	
7384H (29572)	MODBUS [®] device specification error	The range of the MODBUS [®] device specified in the received request message exceeds the valid range of the MODBUS [®] device assignment parameter.	Set an adequate MODBUS [®] device assignment parameter so that it will satisfy the MODBUS [®] device range specified in the received request message.				○	
7385H (29573)		The range of the MODBUS [®] device specified in the received request message exceeds the maximum value* for the MODBUS [®] device. * The maximum value for the extension file register is "10000", and that for any other MODBUS [®] device is "65536".	Check the specification of the MODBUS [®] device on the master side from which the request message was sent.				○	
7386H (29574)		The number of access points for the MODBUS [®] device specified in the received request message exceeds the maximum access points allowed for the relevant function.	Check the specification of the MODBUS [®] device on the master side from which the request message was sent.				○	
7388H (29576)	No setting for error status read device	No error status read device was set for Read exception status (FC: 07).	Set an error status read device.				○	
7390H (29584)	Byte count specification error	The number of write points in the received request message does not match the specified number of bytes.	Review the number of write points and the number of bytes on the master side from which the request message was sent.				○	
7391H (29585)	Received data size error	The write device data size in the received request message is not consistent with the specified number of bytes.	Review the specified contents of the write device data size and number of bytes on the master side that sent the request message.				○	
7392H (29586)	Reference type error	The reference number value specified in the received request message (FC: 20, FC: 21) is incorrect.	Review the specification of the reference number on the master side from which the request message was sent.				○	
7393H (29587)	Data unit error	<ul style="list-style-type: none"> The contents of the data unit in the received request message are incorrect. The size of the received request message is smaller than the minimum size or greater than the maximum size required for the relevant function code. 	Review the contents of the request message on the master side from which the request message was sent.				○	

(Continued on next page)

Table 11.16 Error code list (Continued)

Error code	Error Name	Error definition	Corrective Action	Occurrence				
				1)	2)	3)	4)	5)
7394H (29588)	Online change error	A write request message was received with online change disabled.	<ul style="list-style-type: none"> Do not issue a write request message while online change is disabled. Turn ON the online change with the intelligent function module switch to enable the online change. 				○	
7397H (29591)	Non-reception monitoring timeout	No reception for a 1.5 character time or 1 second or more was detected during message reception, and the message was discarded.	<ul style="list-style-type: none"> Review the setting of the device from which the relevant message was sent. Check the relevant device. Disconnect an erroneous device if any. 	○				
7398H (29592)	Short frame error	The received message size (excluding the start character in the ASCII mode) was less than 4 or 8 bytes.	<ul style="list-style-type: none"> Review the contents of the message issued by the station that sent the relevant message. Check the relevant device. Disconnect an erroneous device if any. 	○				
7399H (29593)	Character overrun error	The received message size (excluding the start character in the ASCII mode) exceeded 256 or 512 bytes.	<ul style="list-style-type: none"> Review the contents of the message issued by the station that sent the relevant message. Check the relevant device. Disconnect an erroneous device if any. 	○				
739AH (29594)	ASCII-binary conversion error	An ASCII code that cannot be converted to binary was received.		○				
739BH (29595)	End code error	An illegal character was received after the end code CR.		○				
739CH to 739EH (29596 to 29598)	System error	The OS of the QJ71MB91 detected a fault.	<p>Take the following steps:</p> <ul style="list-style-type: none"> Check that the power supply module, programmable controller CPU and QJ71MB91 are correctly mounted on the base unit. Confirm that the system is operated within the general specifications of the programmable controller CPU. Check if the power capacity is sufficient. It can be a hardware error. Check if the programmable controller CPU, base unit and QJ71MB91 are normal referring to the manual for each module. Or, replace a module or a unit to check the operation. If the above does not solve the problem, please consult your local Mitsubishi system service center or representative, explaining a detailed description of the error occurrence, the GX Developer project and/or the error code. 	○	○	○	○	○

(Continued on next page)

Table 11.16 Error code list (Continued)

Error code	Error Name	Error definition	Corrective Action	Occurrence				
				1)	2)	3)	4)	5)
73C0H (29632)	RAM error	An error was detected in the RAM test.	<p>Take the following steps:</p> <ul style="list-style-type: none"> • Check that the power supply module, programmable controller CPU and QJ71MB91 are correctly mounted on the base unit. • Confirm that the system is operated within the general specifications of the programmable controller CPU. • Check if the power capacity is sufficient. • Perform the test again. • If the above does not solve the problem, a probable cause is a hardware error. 					○
73C1H (29633)	ROM error	An error was detected in the ROM test.	<p>Check if the programmable controller CPU and base unit are normal referring to the manual for each module.</p> <p>Or, replace either of the modules to check the operation.</p> <p>In case of failure, please consult your local Mitsubishi system service center or representative, explaining a detailed description of the problem.</p>					○
73C2H (29634)	Self-loopback test error	An error was detected in the self-loopback test.	<p>Take the following steps:</p> <ul style="list-style-type: none"> • Check if the loopback connector is attached and if the wiring is correct. • Check that the power supply module, programmable controller CPU and QJ71MB91 are correctly mounted on the base unit. • Confirm that the system is operated within the general specifications of the programmable controller CPU. • Check if the power capacity is sufficient. • Perform the test again. • If the above does not solve the problem, a probable cause is a hardware error. <p>Check if the programmable controller CPU and base unit are normal referring to the manual for each module.</p> <p>Or, replace either of the modules to check the operation.</p> <p>In case of failure, please consult your local Mitsubishi system service center or representative, explaining a detailed description of the problem.</p>					○

(Continued on next page)

Table 11.16 Error code list (Continued)

Error code	Error Name	Error definition	Corrective Action	Occurrence				
				1)	2)	3)	4)	5)
7400H (29696)	Framing error	<ul style="list-style-type: none"> The stop bit position is incorrect. The stop bit setting is incorrect. The transmission setting is inconsistent. Turning ON/OFF the equipment produced a disturbance on the line. Electric noise was generated on the line. There are two or more masters. Data transmission occurred simultaneously. 	<ul style="list-style-type: none"> Match the stop bit setting on the QJ71MB91 with that on the target device. Match the transmission setting on the QJ71MB91 with that on the target device. Take preventive measures against noise. Use one master in the system. Adjust the transmission timing to prevent simultaneous data transmission. 	○				
7401H (29697)	Parity error	<ul style="list-style-type: none"> The parity bit check ended in error. The parity bit setting is incorrect. The transmission setting is inconsistent. There is fluctuation on the line caused by a device turning on and off. Electric noise was generated on the line. There are two or more masters. Data transmission occurred simultaneously. 	<ul style="list-style-type: none"> Match the parity bit setting on the QJ71MB91 with that on the target device. Match the transmission setting on the QJ71MB91 with that on the target device. Take preventive measures against noise. Use one master in the system. Adjust the transmission timing to prevent simultaneous data transmission. 	○				
7402H (29698)	Overrun error	<ul style="list-style-type: none"> The next data was received before completion of the current reception processing. The transmission speed exceeds the limit of the QJ71MB91. An instantaneous power failure occurred. 	<ul style="list-style-type: none"> Check if the transmission speed is within the limit of the QJ71MB91. Check if no instantaneous power failure is occurring on the station. (This can be checked with special register SD1005 of the programmable controller CPU.) Remove the cause of the instantaneous power failure if it is occurring. Reduce the transmission speed. 	○				
7403H (29699)	CS signal OFF	<ul style="list-style-type: none"> The CS signal was OFF at the time of request or response message transmission, resulting in failure of the transmission. A cable is disconnected. A cable is faulty. 	<ul style="list-style-type: none"> Confirm that the cables are not disconnected. Check the cable connection and correct the wiring so that the CS signal on the CH1 (RS-232) side will be always ON. 	○				
7404H (29700)	Buffer full error	The OS buffer (the buffer provided inside the module) is full.	<ul style="list-style-type: none"> If the programmable controller CPU has any problem, remove it. Check if the transmission speed is within the limit of the QJ71MB91. Check if no instantaneous power failure is occurring on the station. (This can be checked with special register SD1005 of the programmable controller CPU.) Remove the cause of the instantaneous power failure if it is occurring. Reduce the transmission speed. Reduce the frequency of requests from the target device. 	○				

(Continued on next page)

Table 11.16 Error code list (Continued)

Error code	Error Name	Description	Corrective Action	Occurrence				
				1)	2)	3)	4)	5)
7411 _H (29713)	CRC/LRC error	The CRC/LRC in the received message does not match the CRC/LRC calculated by the QJ71MB91.	<ul style="list-style-type: none"> Do not turn OFF or disconnect the device from the network while it is sending a message. (If this is the cause of the error, no action is required as long as there is no particular problem.) Review the contents of the message issued by the relevant station. Check the relevant device. Disconnect the erroneous device if any. Review the line status. Take preventive measures against noise. 	○				
7412 _H (29714)	Transmission monitoring timer timeout	The transmission monitoring timer timed out.	<ul style="list-style-type: none"> Confirm that the cables are not disconnected. Check the cable connection and correct the wiring so that the CS signal on the CH1 (RS-232) side will be always ON. 	○				
7480 _H to 75FF _H (29824 to 30207)	System error	The OS of the QJ71MB91 detected a fault.	<p>Take the following steps:</p> <ul style="list-style-type: none"> Check if the power supply module, programmable controller CPU and QJ71MB91 are correctly mounted on the base unit. Confirm that the system is operated within the general specifications of the programmable controller CPU. Check if the power capacity is sufficient. A probable cause is a hardware error. <p>Check if the programmable controller CPU, base unit and QJ71MB91 are normal referring to the manual for each module.</p> <p>Or, replace any of the modules to check the operation.</p> <ul style="list-style-type: none"> If the above does not solve the problem, please consult your local Mitsubishi system service center or representative, explaining a detailed description of the error occurrence, the GX Developer project and/or the error code. 	○	○	○	○	○
F000 _H to FFFF _H (61440 to 65535)	-	Errors detected by MELSECNET/H or MELSECNET/10 network module	Refer to the troubleshooting section in the MELSECNET/H or MELSECNET/10 Network System Reference Manual, and take the corrective actions.				○	

Remark

- For details of areas to which error codes are stored, refer to Section 11.4.1
- For details of parameter setting ranges and other information, refer to CHAPTER 7

11.5 Turning Off the ERR. LED

This section explains how to turn off the ERR.LED of the QJ71MB91 when it is lit.

POINT

1. Remove possible error cause before turning off the ERR. LED.
(☞ Section 11.1, Section 11.4)
If not, the following operation will not turn off the ERR. LED.
2. The ERR. LED turns on when an error occurs.
Once the ERR. LED has turned on, it does not turn off automatically even if the status returns to normal.
Perform the following to turn off the ERR. LED.

Table 11.17 List of methods for turning off the ERR. LED

Method	Reference
Turning off by GX Configurator-MB	Section 11.5.1
Turning off by sequence program	Section 11.5.2
Turning off by request message from master (when the QJ71MB91 is a slave)	Section 11.5.3

11.5.1 Turning off the ERR. LED by GX Configurator-MB

This section explains how to turn off the ERR. LED from GX Configurator-MB.

(1) Making the Monitor/test screen active

Make the Monitor/test screen active. (☞ Section 8.6)

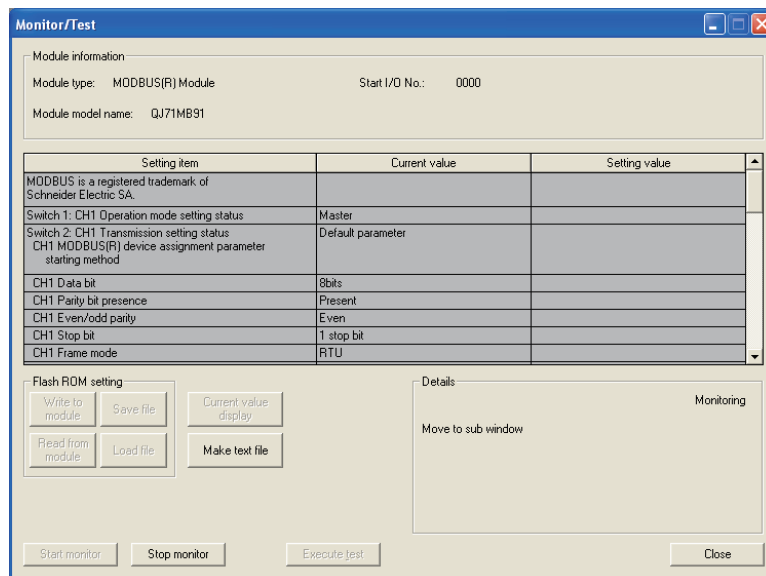

Figure 11.8 Monitor/test screen

(2) Turning off the ERR. LED

Select "Being requested" in the Setting value field of the "CH Common/CH1 Error clear request".

Click the **Execute test** button.

Perform the same operation for "CH2 Error clear request".

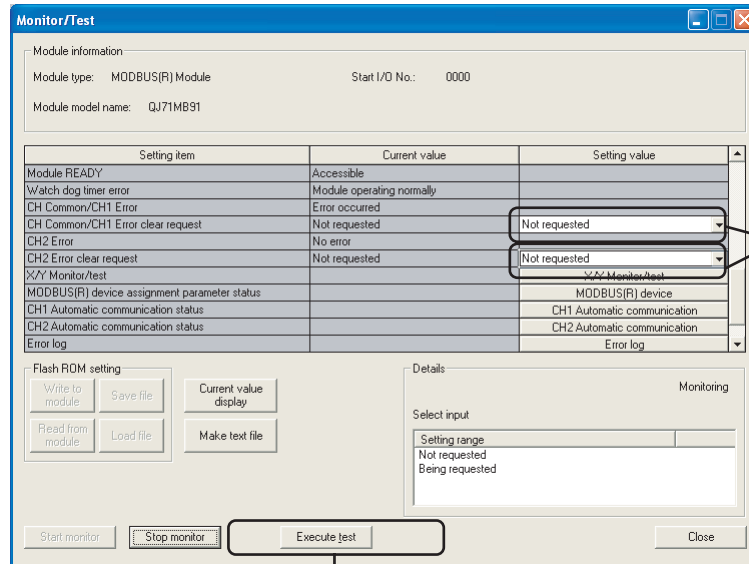

Click.

Figure 11.9 Turning off the ERR. LED on the Monitor/test screen

(a) LEDs that will be cleared

When error clear requests are made by "CH Common/CH1 Error clear request" and "CH2 Error clear request" on the Monitor/test screen (☞ Section 8.6), all the LEDs and the Exception code storage area (0002H/0004H) in the buffer memory are cleared.*1

* 1 For the execution of "Y1B: CH common/CH1 error clear request" and "Y1C: CH2 error clear request" on the X/Y monitor/test screen (☞ Section 8.6.1), only the LED, whose clear is requested in the Detailed LED clear request storage area (address: 0008H/0009H) in the buffer memory, is cleared.

When the LED was turned off by "Y1B: CH common/CH1 error clear request" and "Y1C: CH2 error clear request", turn on the corresponding bit in the Detailed LED clear request storage area by the device test on GX Developer.

CH1 side Detailed LED clear request storage area (address: 0008H)

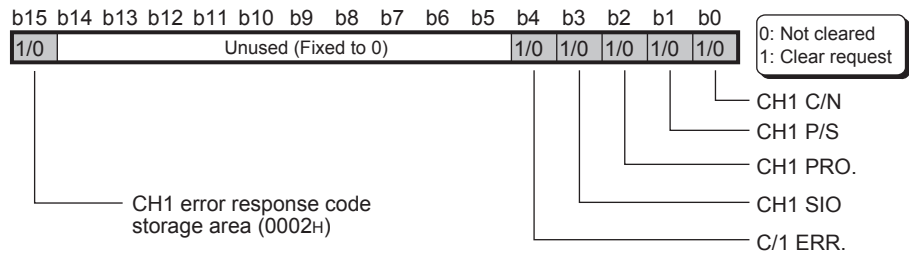

CH2 side Detailed LED clear request storage area (address: 0009H)

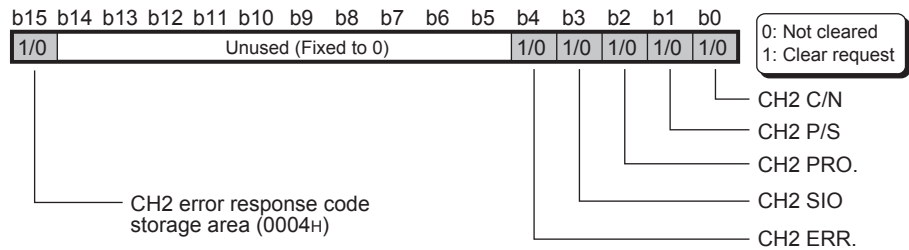

Figure 11.10 Configuration of the Detailed LED clear request storage area

(3) Confirming the ERR. LED turned off

When the processing is completed, the "Completed." message is displayed.

Check that the current value fields of "CH Common/CH1 Error" and "CH2 Error" have changed from "Error occurred" to "No error".

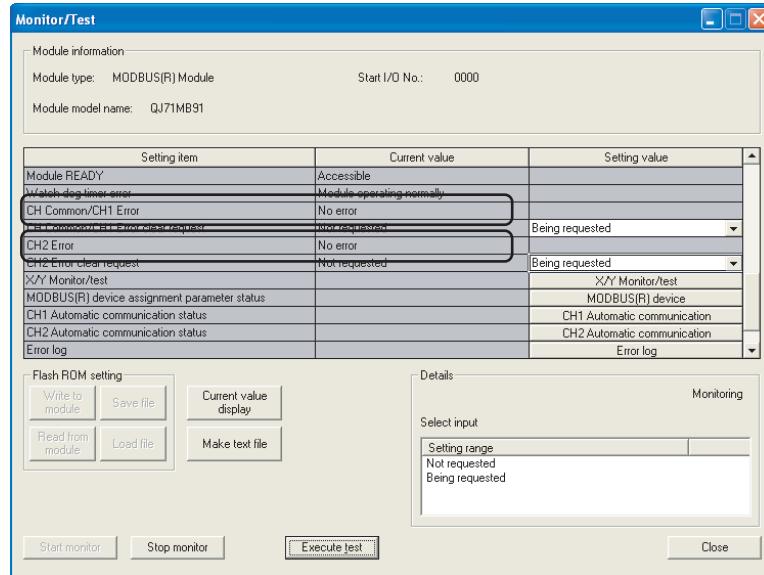

Figure 11.11 Monitor/test screen (after the ERR.LED turned off)

11.5.2 Turning off the ERR. LED by sequence program

This section explains how to turn off the ERR. LED from a sequence program.

(1) Procedure for turning off the ERR. LED

The following is the procedure for turning off the ERR. LED.

(a) I/O signals when the ERR.LED is lit

When an error occurs, the ERR. LED on the front of the QJ71MB91 module lights up, and the CH common/CHn error (X1B/X1C) turns on. ((1) in the figure)

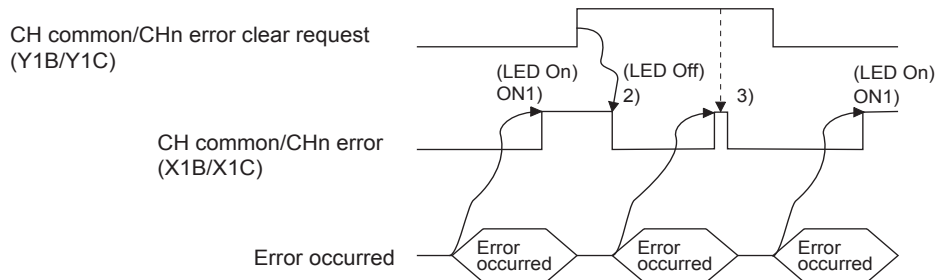
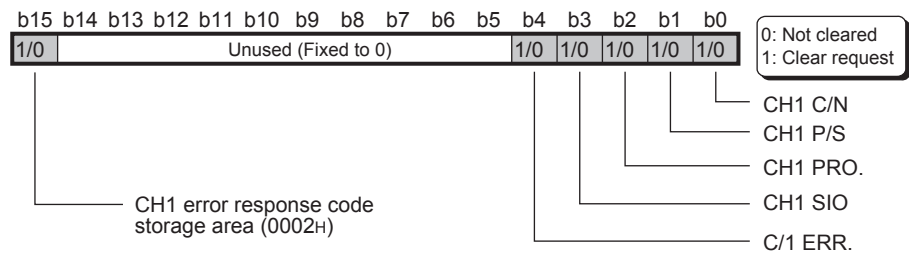

Figure 11.12 I/O signal behavior when the ERR. LED is lit

(b) Turning on the corresponding bit in the Detailed LED clear request storage area

Turn on all the relevant bits of the Detailed LED clear request storage area (0008H/0009H) in the buffer memory.

CH1 side Detailed LED clear request storage area (address: 0008H)



CH2 side Detailed LED clear request storage area (address: 0009H)

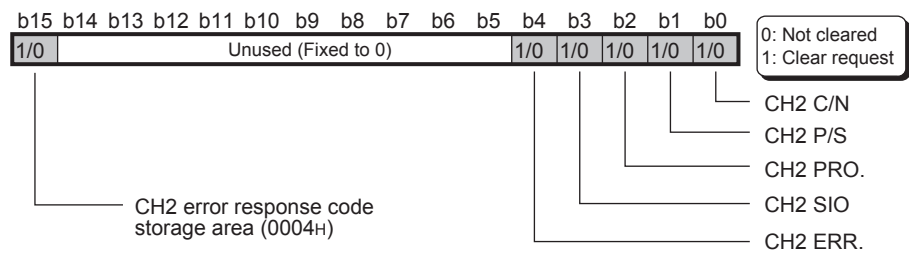

Figure 11.13 Configuration of the Detailed LED clear request storage area

The above area is cleared when an error clear request described in (1)(c) of this section is made after the clear request (turning on the corresponding bit). When the above exception code storage area is turned on, the Exception code storage error (address: 0002H/0004H) in the buffer memory is cleared.

(c) Turning on the CH common/CHn error clear request

Turning on the CH common/CHn error clear request (Y1B/Y1C) turns off the ERR. LED. ((2) in the figure)

Clear request will be processed all the time while the CH common/CHn error clear request (Y1B/Y1C) is on. ((3) in the figure)

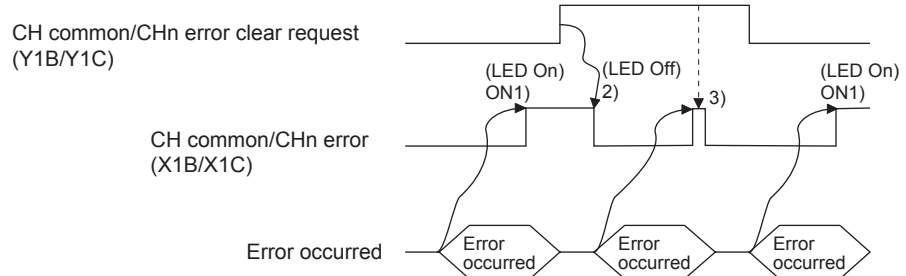

Figure 11.14 I/O signal behavior when turning off the ERR.LED is requested

(2) Program conditions

The following program executes turning off the ERR. LED when communications are performed on the CH2 side.

(a) Devices used

Table11.18 Devices used for turning off the ERR. LED

Device name	Device	Application
QJ71MB91 input/output	X0	Module READY
	Y1C	CH2 error clear request
External input (command)	X20	ERR.LED OFF command

(b) Buffer memory used

Table11.19 Buffer memory used for turning off the ERR. LED

Device name	Address	Application
QJ71MB91 buffer memory	0009H (9)	CH2 side Detailed LED clear request storage area

(3) Program example

(When the I/O signals of the QJ71MB91 are X/Y0 to X/Y1F)

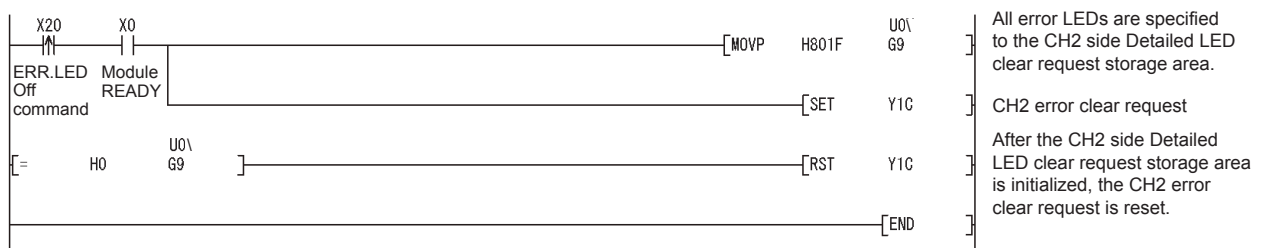

Figure 11.15 ERR. LED OFF program example

11.5.3 Turning off the ERR. LED by request message from the master

When the QJ71MB91 is a slave, the ERR.LED can be turned off by a request message from the master.

The following explains how to turn off the ERR. LED by issuing a request message from the master.

(1) Procedure for turning off the ERR. LED

Send a request message containing the following to the slave (QJ71MB91) from the master after removing possible error causes.

- Restart communications option (☞ Section 4.11.2)
- Clear Counters and Diagnostic Register (☞ Section 4.11.6)

APPENDICES

Appendix 1 Function Upgrade of the QJ71MB91

The QJ71MB91 version has been upgraded with a new function added and the specifications changed.

The new function and the utility package version are shown below.

TableApp.1 New function and utility package version

Function	First 5 digits of serial No.
Supporting the UINI instruction	"11042" or later

Remark

.....
For information on how to check the serial number, refer to Section 2.4.
.....

Appendix 2 A Series Modules

This section presents comparisons in performance and functions between the QJ71MB91 and A Series modules, and utilization of existing programs.

Appendix 2.1 Comparisons in performance specifications

TableApp.2 Comparisons in performance specifications

Item			Specifications		Compatibility	
			AJ71UC24-S2 A1SJ71UC24-R2-S2 A1SJ71UC24-R4-S2	QJ71MB91		
Transmission specifications	Interface	RS-232	RS-232 compliant (D-Sub 25-pin) or, RS-232 compliant (D-Sub 9-pin)	RS-232 compliant (D-Sub 9-pin)	△ *1	
		RS-422/485	RS-422/485 compliant	RS-422/485 compliant (Detachable terminal block)	○	
	Transmission speed		300 to 19200 bps	300 to 115200 bps	○	
	Transmission distance (Overall distance)	RS-232	Max. 15m (49.2 ft.)		○	
RS-422/485		Max. 500m (3936.9 ft.) (Overall distance)	Max. 1200m (3936.9 ft.) (Overall distance)	○		
Master function	Automatic communication function	Number of slaves	-	32 per channel	-	
		Function (for send)		7 functions		
		Input area size		4k words		
		Output area size		4k words		
	Dedicated instruction	No. of simultaneously executable instructions		(None)		1 instruction per channel
		Function (for send)				MBRW instruction: 9 functions MBREQ instruction: 19 functions
		Input area size				Max. 253 bytes per instruction
		Output area size				Max. 253 bytes per instruction
Slave function	Automatic response function	Function (for receive)	13 functions	17 functions	○	
	MODBUS [®] device size	Coil	10000 points	64k points	○	
		Input	0 points	64k points	○	
		Input register	0 points	64k points	○	
		Holding register	10000 points	64k points	○	
		Extended file register	8192 points (1 file)	Max. 1018k points (105 files)	○	
	No. of simultaneously acceptable request messages		1 request per channel		○	
	Max. access points per message		256 points	Max. points prescribed by MODBUS [®] protocol	○	
Station No.		1 to 99	1 to 247	○		
Number of occupied I/O points			32 points per slot (I/O assignment: Special 32 points)	32 points per slot (I/O assignment: Intelli. 32 points)	○	

○ : Compatible △ : Partially changed × : Incompatible

* 1 The connector of the cable must be changed.

Appendix 2.2 Functional comparisons

Table App.3 Functional comparisons

Function		AJ71UC24-S2 A1SJ71UC24-R2-S2 A1SJ71UC24-R4-S2	QJ71MB91
Master function	Automatic communication function	×	○
	Dedicated instruction	×	○
Slave function*2	Automatic response function	○	○
	MODBUS® device assignment function	○*1	○
	Link operation function	○	○
Various settings using utility package		×	○
Computer link function		○	×

○ : Available × : Not available

* 1 MODBUS® devices cannot be assigned to the buffer memory.

* 2 The following is a list of standard functions available in the slave function.

Function code (Sub code)	Function	AJ71UC24-S2 A1SJ71UC24-R2-S2 A1SJ71UC24-R4-S2	QJ71MB91
01	Read coils	○	○
02	Read discrete inputs	×	○
03	Read holding registers	○	○
04	Read input registers	×	○
05	Write single coil	○	○
06	Write single register	○	○
07	Read exception status	○	○
08	Diagnostics	○	○
11	Get communications event counter	○	○
12	Get communications event log	○	○
15	Write multiple coils	○	○
16	Write multiple registers	○	○
17	Report slave ID	○	○
20(6)	Read file record	○	○
21(6)	Write file record	○	○
22	Mask write register	×	○
23	Read/Write multiple registers	×	○
24	Read FIFO queue	×	×
43	Read device identification	×	×

○ : Supported × : Not supported

Appendix 2.3 Utilization of existing programs

TableApp.4 Comparisons of sequence programs

Item		Compatibility		Precautions for replacement
		Target device side program (Master)	Sequence program	
Slave function	Automatic response function	○	(Program not required)	-
	MODBUS® device assignment function	(Program not required)	△	There is no compatibility in sequence programs since the I/O signals and buffer memory assignments are different. Modify the sequence program, or make the setting again on GX Configurator-MB.
	Link operation function	(Program not required)	(Program not required)	Make the setting in the intelligent function module switch setting.
Computer link function		×	×	The computer link function is not available for the QJ71MB91.

○ : Compatible △ : Partially changed × : Incompatible

(1) Switch setting

The mode, station No. and transmission specifications are set in the intelligent function module switch setting of GX Developer on the QJ71MB91 while they are set with switches on A Series modules. (☞ Section 6.6)

(2) I/O signals

There is no compatibility in I/O signal assignment between the QJ71MB91 and A Series modules.

Create a new sequence program.

TableApp.5 Comparisons of I/O signals

Input signal	Signal name	Compatibility	Precautions for replacement
	AJ71UC24-S2, A1SJ71UC24-R2-S2, A1SJ71UC24-R4-S2		
X0	Error occurrence on CH1 side	△	X1B is used on the QJ71MB91.
X1	Error occurrence on CH2 side	△	X1C is used on the QJ71MB91.
X2 to X6	Use prohibited	-	
X7	Module ready	△	X0 is used on the QJ71MB91.
X8	MODBUS [®] device assignment parameter setting, error completed	△	X9 is used on the QJ71MB91.*1
X9 to XC	Use prohibited	-	
XD	Watch dog timer error (WDT error)	△	X1F is used on the QJ71MB91.
XE to X1F	Use prohibited	-	

○ : Compatible △ : Partially changed × : Incompatible

TableApp.6 Comparisons of output signals

Output signal	Signal name	Compatibility	Precautions for replacement
	AJ71UC24-S2, A1SJ71UC24-R2-S2, A1SJ71UC24-R4-S2		
Y0 to YF	Use prohibited	-	
Y10	CH1 side communication error cancel request	△	Y1B is used on the QJ71MB91.
Y11	CH2 side communication error cancel request	△	Y1C is used on the QJ71MB91.
Y12 to Y16	Use prohibited	-	
Y17	MODBUS [®] device assignment parameter setting request	△	Y8 is used on the QJ71MB91.*1
Y18 to Y1F	Use prohibited	-	

○ : Compatible △ : Partially changed × : Incompatible

* 1 Because the QJ71MB91 has the MODBUS[®] device assignment parameter setting, normally completed (X8) and MODBUS[®] device assignment parameter setting existence (XA) in addition to the signals provided for A Series modules, the MODBUS[®] device assignment parameter setting procedure is partially different.

For the MODBUS[®] device assignment parameter setting, refer to the following:

☞ Section 9.1.2

(3) Buffer memory

There is no compatibility in buffer memory assignment between the QJ71MB91 and A Series modules.

Create a new sequence program.

TableApp.7 Comparison of buffer memories

Buffer memory address	Buffer memory name	Compatibility	Precautions for replacement
	AJ71UC24-S2 A1SJ71UC24-R2-S2 A1SJ71UC24-R4-S2		
0000H (0)	Mode setting status storage area	△	On the QJ71MB91, 0C00H to 0C04H (3072 to 3076) are used.
0001H (1)	Station No. setting status storage area	△	
0002H (2)	CH1 side error response code storage area	○	-
0003H (3)	CH1 side detailed error code storage area	△	Check Error log 0CFEH to 0DFFH (3326 to 3583).
0004H (4)	CH2 side exception code storage area	○	-
0005H (5)	CH2 side detailed error code storage area	△	Check Error log 0CFEH to 0DFFH (3326 to 3583).
0006H (6)	CH1 side detailed LED status storage area	○	On the QJ71MB91, some data are partially added.
0007H (7)	CH2 side detailed LED status storage area	○	
0008H (8)	CH1 side detailed LED clear request storage area	○	
0009H (9)	CH2 side detailed LED clear request storage area	○	
000AH (10)	Error status read device code	△	Check the specified device code value.
000BH (11)	Head error status read device No.	○	-
000CH (12)	Computer link function FC value setting	△	Not used on the QJ71MB91.
000DH to 000FH (13 to 15)	System area (use prohibited)	-	-
0010H to 0023H (16 to 35)	MODBUS [®] device assignment parameter (Coil)	△	On the QJ71MB91, 900H to 9FFH (2304 to 2559) are used.*1
0024H to 002FH (36 to 47)	System area (use prohibited)	-	-
0030H to 0043H (48 to 67)	MODBUS [®] device assignment parameter (Holding register)	△	On the QJ71MB91, 900H to 9FFH (2304 to 2559) are used.*1
0044H to 0DEFH (68 to 3567)	User free area	△	On the QJ71MB91, 5000H to 5FFFH (20480 to 24575) are used.
0DF0H to 0DFFH (3568 to 3583)	System area (use prohibited)	-	-

○ : Compatible △ : Partially changed × : Incompatible

* 1 The MODBUS[®] device assignment parameter setting area and setting contents are different between the QJ71MB91 and A Series modules.

Modify the sequence program, or make the setting again on GX Configurator-MB.

Appendix 3 Processing Time

This section explains the QJ71MB91 processing time for each function. The processing times obtained by the expressions in this section can be regarded as the times showing performance in communication with a single device.

(1) Performance of master functions

(a) Performance of the automatic communication function

1) Automatic communication function communication time [unit: ms]

The automatic communication function communication time is the time from the start of request message processing to the end of response message processing.

$$T_{ac} = K_m + T_a + K_{tq} + K_{tr} + T_s + T_i \times 3 + G_t$$

2) Calculation items

TableApp.8 Processing time calculation items for the automatic communication function

Item	Description	Unit
Tac	Automatic communication function communication time	ms
Km	9 (Constant)	-
Ta	Message conversion time RTU mode : 0 ASCII mode: 1 to 2	ms
Ktq	Request message transmission time*1	ms
Ktr	Response message transmission time*2	ms
Ts	Target slave device processing time	ms
Ti	Message interval RTU mode: When the transmission speed is 19200 bps or less, "1 character time*3 × 3.5" When the transmission speed exceeds 19200 bps, "1.75ms" ASCII mode: 0	ms
Gt	Data transmission delay time RS-232 : 0 ms RS-422/485: 1 character time*3 × 2	ms

* 1 Request message transmission time [ms]:

$$K_{tq} = \text{Request message size [bytes]} \times \text{Bits of 1 character} / \text{Transmission speed [bps]} \times 1000$$

* 2 Response message transmission time [ms]:

$$K_{tr} = \text{Response message size [bytes]} \times \text{Bits of 1 character} / \text{Transmission speed [bps]} \times 1000$$

* 3 1 character time = Bits of 1 character / Transmission speed [bps] × 1000

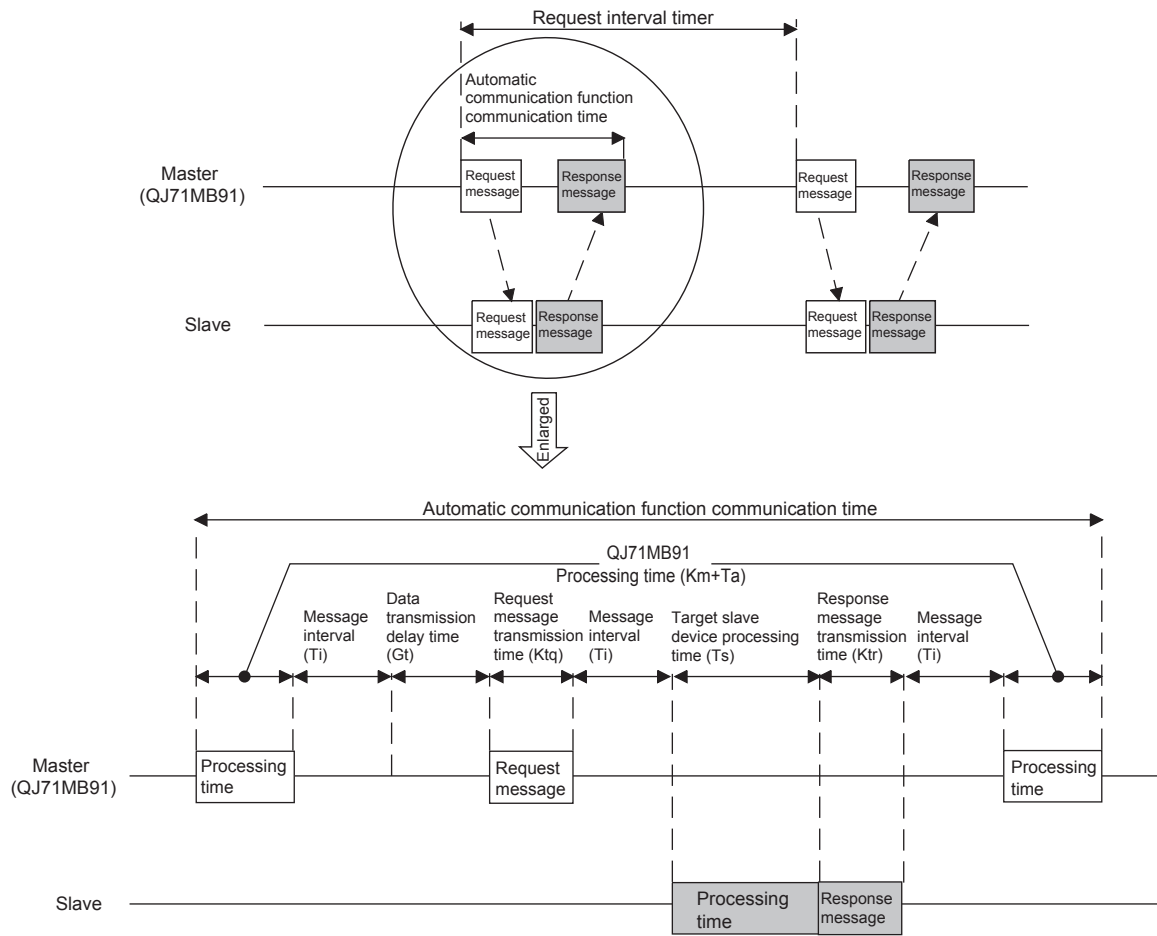

FigureApp.1 Processing time configuration of the automatic communication function

(b) Performance of dedicated instructions (MBRW/MBREQ instruction)

1) Dedicated instruction processing time [unit: ms]

The dedicated instruction processing time is the time from the start of a dedicated instruction until the completion device turns on.

$$Trc = Km + Ta + St + (Ttq + Ts + Ttr + Ti \times 3 + Gt \text{ or } St, \text{ whichever is greater})$$

2) Calculation items

TableApp.9 Calculation items for the dedicated instruction processing time

Item	Description	Unit
Trc	Dedicated instruction processing time	ms
St	Local station scan time	ms
Km	9 (Constant)	-
Ta	Message conversion time RTU mode : 0 ASCII mode: 1 to 2	ms
Ttq	Request message transmission time ^{*1}	ms
Ts	Message processing time of target slave device	ms
Ttr	Response message transmission time ^{*2}	ms
Ti	Message interval RTU mode : When the transmission speed is 19200 bps or less, "1 character time ^{*3} × 3.5" When the transmission speed exceeds 19200 bps, "1.75ms" ASCII mode: 0	ms
Gt	Data transmission delay time RS-232 : 0 ms RS-422/485: 1 character time ^{*3} × 2	ms

* 1 Request message transmission time [ms]:

$$Ttq = \text{Request message size [bytes]} \times \text{Bits of 1 character} / \text{Transmission speed [bps]} \times 1000$$

* 2 Response message transmission time [ms]:

$$Ttr = \text{Response message size [bytes]} \times \text{Bits of 1 character} / \text{Transmission speed [bps]} \times 1000$$

* 3 1 character time = Bits of 1 character / Transmission speed [bps] × 1000

(2) Performance of the slave function

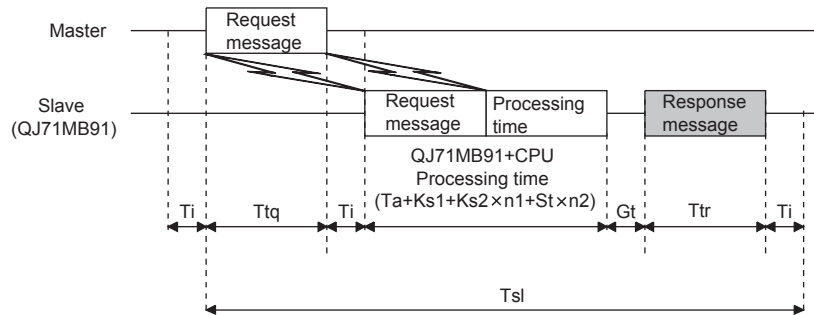

FigureApp.2 Processing time configuration of the slave function

(a) When mounted with a programmable controller CPU

1) Request message processing time [unit: ms]

The request message processing time is the time from when the QJ71MB91 receives a request message from the master until it sends a response message after completion of the requested processing.

$$Tsl = Ttq + Ta + Ks1 + Ks2 \times n1 + St \times n2 + Ttr + Ti \times 2 + Gt$$

2) Calculation items

TableApp.10 Processing time calculation items used when mounted with a programmable controller CPU

Item	Description	Unit
Tsl	Request message processing time	ms
St	Local station scan time	ms
Ks1	6 (Constant)	-
Ks2	8 (Constant)	-
Ta	Message conversion time RTU mode : 0 ASCII mode : 1 to 2	ms
Ttq	Request message transmission time*1	ms
Ttr	Response message transmission time*2	ms
Ti	Message interval RTU mode: When the transmission speed is 19200 bps or less, "1 character time *3 x 3.5" When the transmission speed exceeds 19200 bps, "1.75ms" ASCII mode: 0	ms
Gt	Data transmission delay time RS-232 : 0 ms RS-422/485: 1 character time *3 x 2	ms

(Continued on next page)

TableApp.10 Processing time calculation items used when mounted with a programmable controller CPU (Continued)

Item	Description			Unit	
n1	Any of the following values are applied depending on the function code and assignment status.			-	
	Function code	When programmable controller CPU device is assigned	When buffer memory is assigned		
	01	1	0		
	02	1	0		
	03	1	0		
	04	1	0		
	05	1	0		
	06	1	0		
	07	1	0		
	08	0	0		
	11	0	0		
	12	0	0		
	15	1	0		
	16	1	0		
	17	0	0		
n2	Any of the following values are applied depending on the function code and assignment status.			-	
	Function code	When programmable controller CPU device is assigned			When buffer memory is assigned
		Normal case	Worst case		
	01	1	2		0
	02	1	2		0
	03	1	2		0
	04	1	2		0
	05	1	2		0
	06	1	2		0
	07	1	2		0
	08	0	0		0
	11	0	0		0
	12	0	0		0
	15	1	2		0
	16	1	2		0
17	0	0	0		
20	1	2	0		
21	1	2	0		
22	2	4	0		
23	2	4	0		

* 1 Request message transmission time [ms]:
 $T_{tq} = \text{Request message size [bytes]} \times \text{Bits of 1 character} / \text{Transmission speed [bps]} \times 1000$

* 2 Response message transmission time [ms]:
 $T_{tr} = \text{Response message size [bytes]} \times \text{Bits of 1 character} / \text{Transmission speed [bps]} \times 1000$

* 3 1 character time = Bits of 1 character / Transmission speed [bps] × 1000

(b) When mounted on a MELSECNET/H remote I/O station

1) Request message processing time [unit: ms]

$$T_{sl} = T_{tq} + T_a + K_{s1} + K_{s2} \times n_1 + (S_m + LS \times 4 + T_{RIOR} + T_{RBF}) \times n_2 + T_{tr} + T_i \times 2 + G_t$$

2) Calculation items

TableApp.11 Processing time calculation time used when mounted on a MELSECNET/H remote I/O station

Item	Description	Unit
S _m	Remote master station scan time	ms
LS	Link scan time ^{*1}	ms
T _{RIOR}	I/O refresh time ^{*1}	ms
T _{RBF}	Time of refresh with buffer memory of intelligent function module ^{*1}	ms
Other than the above	Refer to(2) (a) in this appendix.	-

* 1 Refer to the Q Corresponding MELSECNET/H Network System Reference Manual (Remote I/O network).

Appendix 4 External Dimensions

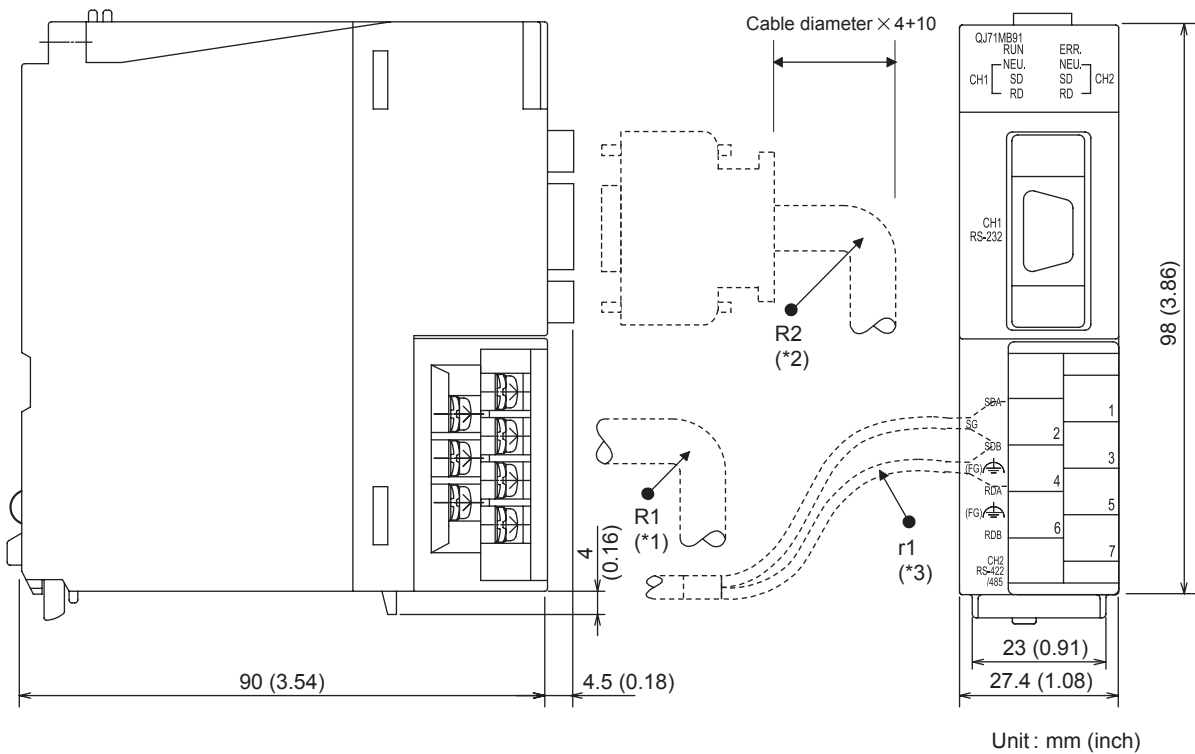

FigureApp.3 External dimensions

- * 1 R1 (Bending radius near terminal block) : Outer cable diameter \times 4
- * 2 R2 (Bending radius near connector) : Outer cable diameter \times 4
- * 3 r1 (Bending radius near crimp contact) : Connectable as long as not bended extremely

INDEX

[A]

- A Series Module App-2
- Auto refresh setting 8-22
- Automatic communication function 5-3
- Automatic communication parameter 7-4,8-17,9-1
- Automatic communication status 8-32
- Automatic response function 5-17

[B]

- Buffer memory list 3-13

[C]

- Change ASCII input delimiter
(sub-function code: 03) 4-30
- Checking QJ71MB91 status 11-11
- CH1, 2 station No. setting (Switch 5) 6-23
- Clear counters and diagnostic register
(sub-function code: 10) 4-33
- Clear overrun counter and flag
(sub-function code: 20) 4-44
- Communication speed/transmission setting
(Switch 2, 4) 6-22
- Communication status 8-35
- Communication status of QJ71MB91 11-17

[D]

- Dedicated instruction 5-16,10-1
- Default assignment parameters 7-19
- Diagnostics (FC: 08) 4-25

[E]

- Error code 11-21
- Error code list 11-30
- Error code storage area 11-21
- Error log 8-34,11-26
- Exception code list 11-28
- External dimensions App-13

[F]

- Force listen only mode (sub-function code: 04) .. 4-31
- Frame mode 4-11
- Frame Specifications 4-10
- Function version 2-9

[G]

- Get Communications Event Counter (FC: 11) 4-45
- Get Communications Event Log (FC: 12) 4-47

[H]

- Hardware test 6-6

[I]

- Initial Setting 8-15
- Intelligent Function Module Switch Setting 6-19
- I/O signal list 3-10

[L]

- Link operation function 5-21
- Listen only mode A-15,4-31

[M]

- Mask Write Register (FC: 22) 4-59
- Master function A-14,5-3
- MODBUS(R) device assignment function 5-18
- MODBUS(R) device assignment
parameter 7-11,8-19,9-4
- MODBUS(R) device assignment parameter
status 8-31
- MODBUS(R) Protocol A-14,A-15
- MODBUS(R) protocol data unit formats 4-15
- MODBUS(R) standard functions 4-1
- Mode setting (Switch 1, 3) 6-21
- Monitor/test 8-24

[P]

- Parameter setting 9-1
- Performance of master functions App-7
- Performance of the slave function App-10
- Processing time App-7
- Program Example
 - For Normal System Configuration 9-8
 - For use in MELSECNET/H remote I/O
network 9-25

[R]

- Read Coils (FC: 01) 4-18
- Read Discrete Inputs (FC: 02) 4-19
- Read Exception Status (FC: 07) 4-24
- Read File Record (FC: 20) (SC: 06) 4-55
- Read Holding Registers (FC: 03) 4-20
- Read input registers (FC: 04) 4-21
- Read/Write Multiple Registers (FC: 23) 4-60
- Report Slave ID (FC: 17) 4-53
- Restart communications option
(sub-function code: 01) 4-26
- Return bus character overrun count
(sub-function code: 18) 4-42
- Return bus communication error count
(sub-function code: 12) 4-36
- Return bus exception error count
(sub-function code: 13) 4-37
- Return bus message count
(sub-function code: 11) 4-35
- Return diagnostic register
(sub-function code: 02) 4-28

Return IOP overrun error count	
(sub-function code: 19).....	4-43
Return query data	
(sub-function code: 00).....	4-25
Return slave busy count	
(sub-function code: 17).....	4-41
Return slave message count	
(sub-function code: 14).....	4-38
Return slave NAK count	
(sub-function code: 16).....	4-40
Return slave no response count	
(sub-function code: 15).....	4-39

[S]

Self-loopback test	6-8
Slave function	A-14,5-17
Software Version	2-11

[T]

Troubleshooting.....	11-1
Turning off the ERR. LED.....	11-41

[U]

Unit test.....	6-6
Utility package.....	8-1

[W]

Write File Record (FC: 21) (SC: 06)	4-57
Write Multiple Coils (FC: 15)	4-50
Write Multiple Registers (FC: 16).....	4-52
Write Single Coil (FC: 05).....	4-22
Write Single Register (FC: 06)	4-23

[X]

X/Y Monitor/test	8-29
------------------------	------

[Z]

ZP.UINI	10-25
Z(P).MBREQ	10-14
Z(P).MBRW.....	10-2

Warranty

Please confirm the following product warranty details before using this product.

1. Gratis Warranty Term and Gratis Warranty Range

If any faults or defects (hereinafter "Failure") found to be the responsibility of Mitsubishi occurs during use of the product within the gratis warranty term, the product shall be repaired at no cost via the sales representative or Mitsubishi Service Company.

However, if repairs are required onsite at domestic or overseas location, expenses to send an engineer will be solely at the customer's discretion. Mitsubishi shall not be held responsible for any re-commissioning, maintenance, or testing on-site that involves replacement of the failed module.

[Gratis Warranty Term]

The gratis warranty term of the product shall be for one year after the date of purchase or delivery to a designated place.

Note that after manufacture and shipment from Mitsubishi, the maximum distribution period shall be six (6) months, and the longest gratis warranty term after manufacturing shall be eighteen (18) months. The gratis warranty term of repair parts shall not exceed the gratis warranty term before repairs.

[Gratis Warranty Range]

- (1) The range shall be limited to normal use within the usage state, usage methods and usage environment, etc., which follow the conditions and precautions, etc., given in the instruction manual, user's manual and caution labels on the product.
- (2) Even within the gratis warranty term, repairs shall be charged for in the following cases.
 1. Failure occurring from inappropriate storage or handling, carelessness or negligence by the user. Failure caused by the user's hardware or software design.
 2. Failure caused by unapproved modifications, etc., to the product by the user.
 3. When the Mitsubishi product is assembled into a user's device, Failure that could have been avoided if functions or structures, judged as necessary in the legal safety measures the user's device is subject to or as necessary by industry standards, had been provided.
 4. Failure that could have been avoided if consumable parts (battery, backlight, fuse, etc.) designated in the instruction manual had been correctly serviced or replaced.
 5. Failure caused by external irresistible forces such as fires or abnormal voltages, and Failure caused by force majeure such as earthquakes, lightning, wind and water damage.
 6. Failure caused by reasons unpredictable by scientific technology standards at time of shipment from Mitsubishi.
 7. Any other failure found not to be the responsibility of Mitsubishi or that admitted not to be so by the user.

2. Onerous repair term after discontinuation of production

- (1) Mitsubishi shall accept onerous product repairs for seven (7) years after production of the product is discontinued.

Discontinuation of production shall be notified with Mitsubishi Technical Bulletins, etc.

- (2) Product supply (including repair parts) is not available after production is discontinued.

3. Overseas service

Overseas, repairs shall be accepted by Mitsubishi's local overseas FA Center. Note that the repair conditions at each FA Center may differ.

4. Exclusion of loss in opportunity and secondary loss from warranty liability

Regardless of the gratis warranty term, Mitsubishi shall not be liable for compensation of damages caused by any cause found not to be the responsibility of Mitsubishi, loss in opportunity, lost profits incurred to the user by Failures of Mitsubishi products, special damages and secondary damages whether foreseeable or not, compensation for accidents, and compensation for damages to products other than Mitsubishi products, replacement by the user, maintenance of on-site equipment, start-up test run and other tasks.

5. Changes in product specifications

The specifications given in the catalogs, manuals or technical documents are subject to change without prior notice.

6. Product application

- (1) In using the Mitsubishi MELSEC programmable controller, the usage conditions shall be that the application will not lead to a major accident even if any problem or fault should occur in the programmable controller device, and that backup and fail-safe functions are systematically provided outside of the device for any problem or fault.

- (2) The Mitsubishi programmable controller has been designed and manufactured for applications in general industries, etc. Thus, applications in which the public could be affected such as in nuclear power plants and other power plants operated by respective power companies, and applications in which a special quality assurance system is required, such as for Railway companies or Public service purposes shall be excluded from the programmable controller applications.

In addition, applications in which human life or property that could be greatly affected, such as in aircraft, medical applications, incineration and fuel devices, manned transportation, equipment for recreation and amusement, and safety devices, shall also be excluded from the programmable controller range of applications.

However, in certain cases, some applications may be possible, providing the user consults their local Mitsubishi representative outlining the special requirements of the project, and providing that all parties concerned agree to the special circumstances, solely at the users discretion.

Microsoft, Windows, Windows NT, and Windows Vista are registered trademarks of Microsoft Corporation in the United States and other countries.

Pentium is trademark of Intel Corporation in the United States and other countries.

Ethernet is trademark of Xerox Corporation.

MODBUS is the registered trademark of Schneider Electric SA.

All other company names and product names used in this manual are trademarks or registered trademarks of their respective companies.

SPREAD

Copyright (c) 1996 FarPoint Technologies, Inc.

MODBUS[®] Interface Module

User's Manual

MODEL	QJ71MB91-U-SY-E
MODEL CODE	13JR86
SH(NA)-080578ENG-G(0904)MEE	



HEAD OFFICE : TOKYO BUILDING, 2-7-3 MARUNOUCHI, CHIYODA-KU, TOKYO 100-8310, JAPAN
NAGOYA WORKS : 1-14 , YADA-MINAMI 5-CHOME , HIGASHI-KU, NAGOYA , JAPAN

When exported from Japan, this manual does not require application to the Ministry of Economy, Trade and Industry for service transaction permission.

Specifications subject to change without notice.