

目 录

一、手册使用详解

1. 手册中的“器件型号”栏	1
2. 手册中的“厂名”栏	1
3. 手册中的“材料 用途 参数”栏	3
4. 手册中的“图号”栏	6
5. 手册中的“国内外相似替换器件型号”栏	6
6. 手册中的“外形参考图”栏	6









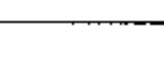

二、可控硅器件型号速查表

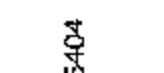
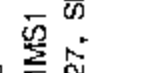
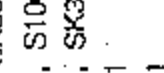
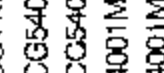
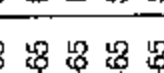
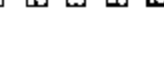
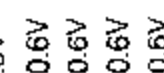
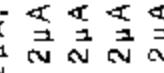
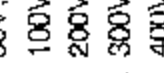
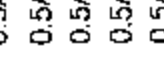
1. A类	1
2. B类	23
3. C类	106
4. D类	224
5. E类	257
6. F类	298
7. G类	337
8. H类	338
9. I类	343
10. K类	370
11. L类	390
12. M类	397
13. N类	448
14. P类	490
15. Q类	543
16. R类	552
17. S类	568
18. T类	704

19. U类.....	965
20. V类.....	968
21. W类.....	969
22. X类.....	972
23. Y类.....	976
24. Z类.....	981
25. 其他类.....	986

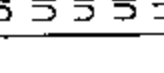
三、外形尺寸实物图

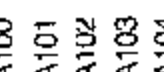
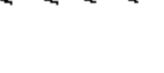
1. A.....	1187
2. B.....	1189
3. C.....	1203
4. D.....	1215
5. E.....	1220
6. F.....	1225
7. G.....	1238
8. H.....	1241

器件型号 Element type	厂名 Manufacturers	材料用途参数 Material Purpose Parameter	图号 Figure	国内外相似替换器件型号 Replace of similar type	备注 Notes	外形参考图 Reference shape
AA100	UNI	0.5A, 60V, 2 μ A, 0.6V	B-65	ECG116, SK3016		
AA101	UNI	0.5A, 100V, 2 μ A, 0.6V	B-65	ECG5402, S1001MS1		
AA102	UNI	0.5A, 200V, 2 μ A, 0.6V	B-65	ECG5404, SK3627, SK5404		
AA103	UNI	0.5A, 300V, 2 μ A, 0.6V	B-65	S4001MS1		
AA104	UNI	0.5A, 400V, 2 μ A, 0.6V	B-65	S4001MS1		
AA107	UNI	0.5A, 60V, 20 μ A, 0.6V	B-65	ECG5401, SK3638, SK5402		
AA108	UNI	0.5A, 100V, 20 μ A, 0.6V	B-65	ECG5402, S1001MS1, 2N887		
AA109	UNI	0.5A, 200V, 20 μ A, 0.6V	B-65	ECG5402, SK3638, SK5402		
AA110	UNI	0.5A, 300V, 20 μ A, 0.6V	B-65	S4001MS1, 2N890		
AA111	UNI	0.5A, 400V, 20 μ A, 0.6V	B-65	ECG109, S4001MS1, 2N891		
AA114	UNI	0.5A, 60V, 200 μ A, 0.6V	B-65	EC103A, ECG109, TAG06YY		
AA115	UNI	0.5A, 100V, 200 μ A, 0.6V	B-65	EC103A, ECG5482, TAG06A		
AA116	UNI	0.5A, 200V, 200 μ A, 0.6V	B-65	ECG109, SK3627, SK5404		
AA117	UNI	0.5A, 300V, 200 μ A, 0.6V	B-65	EC103D, ECG109, TAG06C		
AA118	UNI	0.5A, 400V, 200 μ A, 0.6V	B-65	SK3087		
AC0V8BGM	NEC	Triac 0.8A, 200V, 0.01A, 1.5V	B-36	MAC94A-4, MAC95A-4, MAC96A-4		
AC0V8DGM	NEC	Triac 0.8A, 400V, 0.01A, 1.5V	B-36	MAC94A-6, MAC95A-6, MAC96A-6		
AC01DJM, DGM		SCR-D 1A, 400V, 0.01A, 0.01A	G-5			
AC03BGM...FGM (L, R)		Triac 3A, 200-600V, 0.015A, 0.005A, B-69 L=10V/ μ s, R=4V/ μ s	B-69	TAG137...		
AC03DGM	NEC	SCR-D 3A, 400V, 0.015A, 2V	B-19	TAG137-D		
AC03DGML		SCR-D 3A, 400V, 0.015A, 0.005A	B-98	TAG137-D		
AC03DGMR		SCR-D 3A, 400V, 0.015A, 0.005A	B-98			
AC03DSM		SCR-D 3A, 400V, 0.015A	B-9			
AC03DSMA		3A, 400V, 0.015A	B-100			













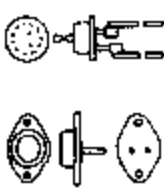
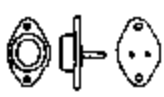
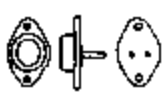
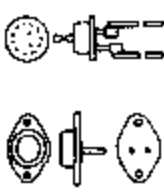
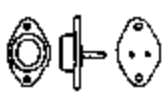
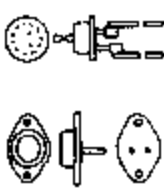
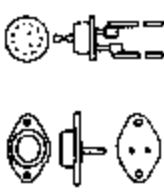
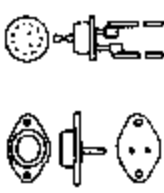
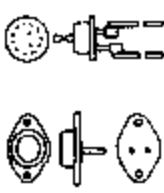
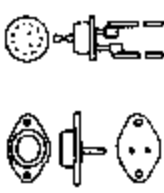
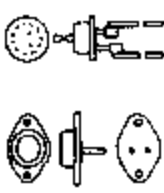
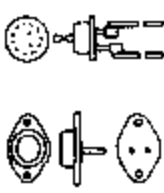
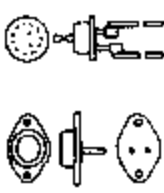
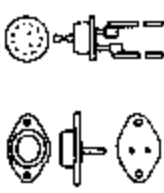
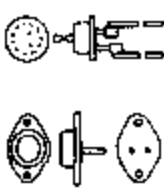
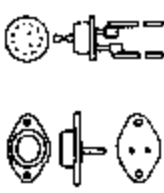
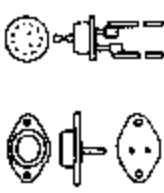
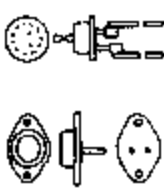
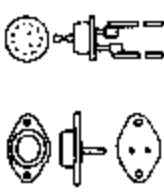
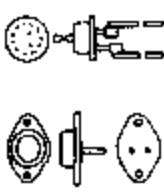

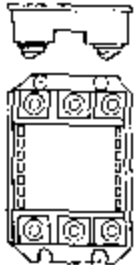
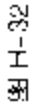
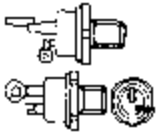
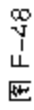
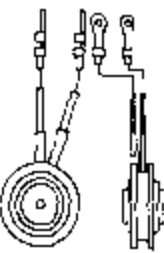

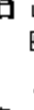

器件型号 Element type	厂名 Manufacturers	材料用途参数 Material Purpose Parameter	图号 Figure	国内外相似替换器件型号 Replace of similar type	备注 Notes	外形参考图 Reference shape
AC03DJM(Z)	Triac	3A, 400V, 0.012A	D-9			
AC03FJM(Z)	Triac	=AC03DJM: 600V	D-9			
AC04BGM...FGM (L, R)	Triac	4A, 200-600V, 0.015A L=10V/μs, R=4V/μs	B-69	TAG137...		
AC05DJM(Z)	Triac	5A, 400V, 0.01A, 0.01A	D-9			
AC05FJM(Z)	Triac	=AC05DJM: 600V	D-9			
AC08BGM...FGM(Z)	Triac	8A, 200-600V, 0.075A, 0.03A, 0.03A, L=10V/μs, R=4V/μs	B-11	BT158/..., MAC222-..., TIC225...		
AC08BIM...FIM(L, R)	Triac	=AC08BGM...FGM	B-11			
AC10BGM...FGM (L, R)	Triac	10A, 200-600V, 0.075A, 0.03A, 0.03A, L=10V/μs, R=4V/μs	B-11	BT162/..., SC146..., TIC236...		
AC10BIM...FIM(L, R)	Triac	=AC10BGM...FGM	B-11			
AC12BGM...FGM (L, R)	Triac	12A, 200-600V, 0.05A, 0.03A, 0.03A, L=10V/μs, R=1V/μs	B-11	BT162/..., SC149..., TIC236...		
AC12BIM...FIM(L, R)	Triac	=AC12BGM...FGM	B-11			
AC16BGM...FGM (L, R)	Triac	16A, 200-600V, 0.05A, 0.04A, 0.04A, L=10V/μs, R=1V/μs	B-11	MAC15..., SC151..., TIC246...		
AC16BIF...FIF(L, R)	Triac	=AC16BGM...FGM	F-21			
AC25BIF...FIF(L, R)	Triac	25A, 200-600V, 0.05A, 0.04A, 0.04A, L=10V/μs, R=1V/μs	F-21	MAC515(A)...		
ACR25U04	AEI	25A, 400V, 0.2A, 3V	F-48			
ACR25U06	AEI	25A, 600V, 0.2A, 3V	F-48			
ACR25U08	AEI	25A, 800V, 0.2A, 3V	F-48			
ACR25U10	AEI	25A, 1KV, 0.2A, 3V	F-48			
AD100	UNI	1.6A, 60V, 2μA, 0.6V	B-51	ECG116, SK3311		
AD102	UNI	1.6A, 200V, 2μA, 0.6V	B-51	S2001MS1		

图 D-9 图 B-69

图 B-11 图 F-21

图 F-48 图 B-51

器件型号 Element type	厂名 Manufacturers	材料用途参数 Material Purpose Parameter	图号 Figure	国内外相似替换器件型号 Replace of similar type	备注 Notes	外形参考图 Reference shape
AD103	UNI	1.6A, 300V, 2 μ A, 0.6V	B-51	ECG179, SK4001MS1		 B-51
AD104	UNI	1.6A, 400V, 2 μ A, 0.6V	B-51	ECG179, SK3009		
AD107	UNI	1.6A, 60V, 20 μ A, 0.6V	B-51	S1001MS1		
AD108	UNI	1.6A, 100V, 20 μ A, 0.6V	B-51	S1001MS1, 2N2324A		
AD109	UNI	1.6A, 200V, 20 μ A, 0.6V	B-51	S2001MS1, 2N2326A		
AD110	UNI	1.6A, 300V, 20 μ A, 0.6V	B-51	S4001MS1, 2N2326A		
AD111	UNI	1.6A, 400V, 20 μ A, 0.6V	B-51	S4001MS1, 2N2329A		
AD114	UNI	1.6A, 60V, 200 μ A, 0.6V	B-51	S1001MS2		
AD115	UNI	1.6A, 100V, 200 μ A, 0.6V	B-51	S1001MS2, 2N2324		
AD116	UNI	1.6A, 200V, 200 μ A, 0.6V	B-51	S2001MS2, 2N2326		
AD117	UNI	1.6A, 300V, 200 μ A, 0.6V	B-51	S4001MS2, 2N2328		
AD118	UNI	1.6A, 400V, 200 μ A, 0.6V	B-51	S4001MS2, 2N2329		
AK25GB-40		MOD, 2 \times SCR, 25A, 400V				
AK25GB-80		MOD, 2 \times SCR, 25A, 800V				
AK25GB-120		MOD, 2 \times SCR, 55A, 1.2KV				
AK25GB-160		MOD, 2 \times SCR, 25A, 1.6KV				
AK55GB-40		MOD, 2 \times SCR, 55A, 400V				
AK55GB-80		MOD, 2 \times SCR, 55A, 800V				
AK55GB-160		MOD, 2 \times SCR, 55A, 1.6KV				
AK90GB-40		MOD, 2 \times SCR, 90A, 400V				
AK90GB-80		MOD, 2 \times SCR, 90A, 800V				
AK90GB-120		MOD, 2 \times SCR, 90A, 1.2KV				
AK90GB-160		MOD, 2 \times SCR, 90A, 1.6KV				

器件型号 Element type	厂名 Manufacturers	材料用途参数 Material Purpose Parameter	图号 Figure	国内外相似替换器件型号 Replace of similar type	备注 Notes	外形参考图 Reference shape
AMB1093	AMR	SCB 90A, 300V, 0.1A, 3V	H-32			
AMTP600	AMR	25A, 600V, 0.15A, 3V	F-48			
AMTP700	AMR	25A, 700V, 0.15A, 3V	F-48			
AMY800	AMR	235A, 800V, 0.2A, 3V	C-39			
AMY1000	AMR	235A, 1kV, 0.15A, 3V	C-39			
APD4C2003M	APD	FLD 0.25A, 16V, 1.2V	F-1			
APD4C2008M	APD	FLD 0.25A, 16V, 1.2V	F-1			
APD4C2028M	APD	FLD 0.25A, 16V, 1.2V	F-1			
APD4C3003M	APD	FLD 0.25A, 26V, 1.2V	F-1			
APD4C3008M	APD	FLD 0.25A, 26V, 1.2V	F-1			
APD4C3028M	APD	FLD 0.25A, 26V, 1.2V	F-1			
APD4C4008M	APD	FLD 0.25A, 36V, 1.2V	F-1			
APD4C4028M	APD	FLD 0.25A, 36V, 1.2V	F-1			
APD4C5003M	APD	FLD 0.25A, 46V, 1.2V	F-1			
APD4C5008M	APD	FLD 0.25A, 46V, 1.2V	F-1			
APD4C5028M	APD	FLD 0.25A, 46V, 1.2V	F-1			
AS80C40	SEJ	80A, 400V, 0.07A, 2V	F-64			
AS100C40	SEJ	100A, 400V, 0.07A, 2V	F-64			
AS120C40	SEJ	120A, 400V, 0.07A, 2V	F-64			
AS250C40	SEJ	250A, 400V, 0.1A, 3V	E-22			
AT403P01	ASG	345A, 100V, 0.15A, 3.5V	C-10			
AT403P02	ASG	345A, 200V, 0.15A, 3.5V	C-10			
AT403P04	ASG	345A, 400V, 0.15A, 3.5V	C-10			
AT403P05	ASG	345A, 500V, 0.15A, 3.5V	C-10			
AT403P06	ASG	345A, 600V, 0.15A, 3.5V	C-10			

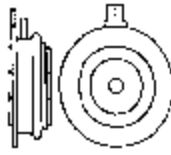
器件型号 Element type	厂名 Manufacturers	材料用途参数 Material Purpose Parameter	图号 Figure	国内外相似替换器件型号 Rep ace of sim' ar type	备注 Notes	外形参考图 Reference shape
AT403S01	ASG	345A, 100V, 0.15A, 3.5V	C-10			 图 C-10
AT403S02	ASG	345A, 200V, 0.15A, 3.5V	C-10			
AT403S03	ASG	345A, 300V, 0.15A, 3.5V	C-10			
AT403S04	ASG	345A, 400V, 0.15A, 3.5V	C-10			
AT403S05	ASG	345A, 500V, 0.15A, 3.5V	C-10			
AT403S06	ASG	345A, 600V, 0.15A, 3.5V	C-10			
AT405P01	ASG	250A, 100V, 0.15A, 3.5V	C-10			
AT405P02	ASG	250A, 200V, 0.15A, 3.5V	C-10			
AT405P03	ASG	250A, 300V, 0.15A, 3.5V	C-10			
AT405P04	ASG	250A, 400V, 0.15A, 3.5V	C-10			
AT405P05	ASG	250A, 500V, 0.15A, 3.5V	C-10			
AT405P06	ASG	250A, 600V, 0.15A, 3.5V	C-10			
AT405P07	ASG	250A, 700V, 0.15A, 3.5V	C-10			
AT405P08	ASG	250A, 800V, 0.15A, 3.5V	C-10			
AT405P09	ASG	250A, 900V, 0.15A, 3.5V	C-10			
AT405P10	ASG	250A, 1kV, 0.15A, 3.5V	C-10			
AT405P11	ASG	250A, 1.1kV, 0.15A, 3.5V	C-10			
AT405S01	ASG	250A, 100V, 0.15A, 3.5V	C-10			
AT405S02	ASG	250A, 200V, 0.15A, 3.5V	C-10			
AT405S03	ASG	250A, 300V, 0.15A, 3.5V	C-10			
AT405S04	ASG	250A, 400V, 0.15A, 3.5V	C-10			
AT405S05	ASG	250A, 500V, 0.15A, 3.5V	C-10			
AT405S06	ASG	250A, 600V, 0.15A, 3.5V	C-10			
AT405S07	ASG	250A, 700V, 0.15A, 3.5V	C-10			
AT405S08	ASG	250A, 800V, 0.15A, 3.5V	C-10			
AT405S09	ASG	250A, 900V, 0.15A, 3.5V	C-10			
AT505S01	ASG	375A, 100V, 0.15A, 3.5V	C-10			

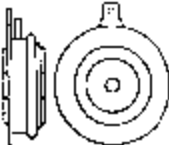
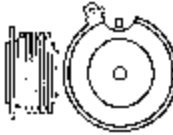

器件型号 Element type	厂名 Manufacturers	材料用途参数 Material Purpose Parameter	图号 Figure	国内外相似替换器件型号 Replace or similar type	备注 Notes	外形参考图 Reference shape	
AT505S02	ASG	375A, 200V, 0.15A, 3.5V	C-10			 图 C-10	
AT505S03	ASG	375A, 300V, 0.15A, 3.5V	C-10				
AT505S04	ASG	375A, 400V, 0.15A, 3.5V	C-10				
AT505S05	ASG	375A, 500V, 0.15A, 3.5V	C-10				
AT505S06	ASG	375A, 600V, 0.15A, 3.5V	C-10				
AT505S07	ASC	375A, 700V, 0.15A, 3.5V	C-10				
AT505S08	ASG	375A, 800V, 0.15A, 3.5V	C-10				
AT505S09	ASG	375A, 900V, 0.15A, 3.5V	C-10				
AT505S11	ASG	375A, 1.1kV, 0.15A, 3.5V	C-10				
AT505S14	ASG	375A, 1.4kV, 0.15A, 3.5V	C-10				
AT505S15	ASG	375A, 1.5kV, 0.15A, 3.5V	C-10				
AT704P01	ASG	600A, 100V, 0.15A, 3.5V	C-11				 图 C-11
AT704P02	ASG	600A, 200V, 0.15A, 3.5V	C-11				
AT704P03	ASG	600A, 300V, 0.15A, 3.5V	C-11				
AT704P04	ASG	600A, 400V, 0.15A, 3.5V	C-11				
AT704P05	ASC	600A, 500V, 0.15A, 3.5V	C-11				
AT704P06	ASG	600A, 600V, 0.15A, 3.5V	C-11				
AT704P07	ASG	600A, 700V, 0.15A, 3.5V	C-11				
AT704P08	ASG	600A, 800V, 0.15A, 3.5V	C-11				
AT704P09	ASG	600A, 900V, 0.15A, 3.5V	C-11				
AT704P10	ASG	600A, 1kV, 0.15A, 3.5V	C-11				
AT704P11	ASG	600A, 1.1kV, 0.15A, 3.5V	C-11				
AT704P13	ASG	600A, 1.3kV, 0.15A, 3.5V	C-11				
AT704P14	ASG	600A, 1.4kV, 0.15A, 3.5V	C-11				
AT704P15	ASG	600A, 1.5kV, 0.15A, 3.5V	C-11				
AT704P16	ASG	600A, 1.6kV, 0.15A, 3.5V	C-11				
AT704S01	ASG	600A, 100V, 0.15A, 3.5V	C-11				
AT704S02	ASG	600A, 200V, 0.15A, 3.5V	C-11				

器件型号 Element type	厂名 Manufacturers	材料用途参数 Material Purpose Parameter	图号 Figure	国内外相似替换器件型号 Replace of similar type	备注 Notes	外形参考图 Reference shape
AT704S03	ASG	600A, 300V, 0.15A, 3.5V	C-11			
AT704S04	ASG	600A, 400V, 0.15A, 3.5V	C-11			
AT704S05	ASG	600A, 500V, 0.15A, 3.5V	C-11			
AT704S06	ASG	600A, 600V, 0.15A, 3.5V	C-11			
AT704S07	ASG	600A, 700V, 0.15A, 3.5V	C-11			
AT704S08	ASG	600A, 800V, 0.15A, 3.5V	C-11			
AT704S09	ASG	600A, 900V, 0.15A, 3.5V	C-11			
AT704S11	ASG	600A, 1.1kV, 0.15A, 3.5V	C-11			
AT704S14	ASG	600A, 1.4kV, 0.15A, 3.5V	C-11			
AT704S15	ASG	600A, 1.5kV, 0.15A, 3.5V	C-11			
AT704S16	ASG	600A, 1.6kV, 0.15A, 3.5V	C-11			
AT804P01	ASG	880A, 100V, 0.15A, 3.5V	C-11			
AT804P02	ASG	880A, 200V, 0.15A, 3.5V	C-11			
AT804P03	ASG	880A, 300V, 0.15A, 3.5V	C-11			
AT804P04	ASG	880A, 400V, 0.15A, 3.5V	C-11			
AT804P05	ASI	880A, 500V, 0.15A, 3.5V	C-11			
AT804P06	ASI	880A, 600V, 0.15A, 3.5V	C-11			
AT804P07	ASI	880A, 700V, 0.15A, 3.5V	C-11			
AT804P08	ASI	880A, 800V, 0.15A, 3.5V	C-11			
AT804P09	ASI	880A, 900V, 0.15A, 3.5V	C-11			
AT804P10	ASI	880A, 1kV, 0.15A, 3.5V	C-11			
AT804P11	ASI	880A, 1.1kV, 0.15A, 3.5V	C-11			
AT804P12	ASI	880A, 1.2kV, 0.15A, 3.5V	C-11			
AT804P13	ASI	880A, 1.3kV, 0.15A, 3.5V	C-11			
AT804P14	ASI	880A, 1.4kV, 0.15A, 3.5V	C-11			
AT804P15	ASI	880A, 1.5kV, 0.15A, 3.5V	C-11			
AT804P16	ASI	880A, 1.6kV, 0.15A, 3.5V	C-11			
AT804S01	ASI	880A, 100V, 0.15A, 3.5V	C-11			



图 C 11



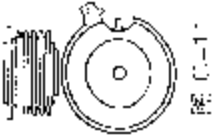

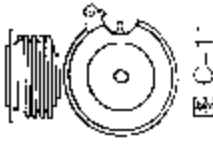
器件型号 Element type	厂名 Manufacturers	材料用途参数 Material Purpose Parameter	图号 Figure	国内外相似替换器型号 Replace of similar type	备注 Notes	外形参考图 Reference shape
AT804S02	ASI	880A, 200V, 0.15A, 3.5V	C-11			 图 C-11
AT804S03	ASI	880A, 300V, 0.15A, 3.5V	C-11			
AT804S04	ASI	880A, 400V, 0.15A, 3.5V	C-11			
AT804S05	ASI	880A, 500V, 0.15A, 3.5V	C-11			
AT804S06	ASI	880A, 600V, 0.15A, 3.5V	C-11			
AT804S07	ASI	880A, 700V, 0.15A, 3.5V	C-11			
AT804S08	ASI	880A, 800V, 0.15A, 3.5V	C-11			
AT804S09	ASI	880A, 900V, 0.15A, 3.5V	C-11			
AT804S10	ASI	880A, 1KV, 0.15A, 3.5V	C-11			
AT804S11	ASI	880A, 1.1KV, 0.15A, 3.5V	C-11			
AT804S12	ASI	880A, 1.2KV, 0.15A, 3.5V	C-11			
AT804S13	ASI	880A, 1.3KV, 0.15A, 3.5V	C-11			
AT804S14	ASI	880A, 1.4KV, 0.15A, 3.5V	C-11			
AT804S15	ASI	880A, 1.5KV, 0.15A, 3.5V	C-11			
AT804S16	ASI	880A, 1.6KV, 0.15A, 3.5V	C-11			
AT807P01	ASI	760A, 100V, 0.15A, 3.5V	C-11			
AT807P02	ASI	760A, 200V, 0.15A, 3.5V	C-11			
AT807P03	ASI	760A, 300V, 0.15A, 3.5V	C-11			
AT807P04	ASI	760A, 400V, 0.15A, 3.5V	C-11			
AT807P05	ASI	760A, 500V, 0.15A, 3.5V	C-11			
AT807P06	ASI	760A, 600V, 0.15A, 3.5V	C-11			
AT807P07	ASI	760A, 700V, 0.15A, 3.5V	C-11			
AT807P08	ASI	760A, 800V, 0.15A, 3.5V	C-11			
AT807P09	ASI	760A, 900V, 0.15A, 3.5V	C-11			
AT807P10	ASI	760A, 1KV, 0.15A, 3.5V	C-11			
AT807P11	ASI	760A, 1.1KV, 0.15A, 3.5V	C-11			
AT807P12	ASI	760A, 1.2KV, 0.15A, 3.5V	C-11			
AT807P14	ASI	760A, 1.4KV, 0.15A, 3.5V	C-11			

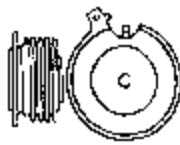
器件型号 Element type	厂名 Manufacturers	材料用途参数 Material Purpose Paramctor	图号 Figure	国内外相似替换器件型号 Replace of similar type	备注 Notes	外形参考图 Reference shape
AT807P15	ASI	760A, 1.5KV, 0.15A, 3.5V	C-11			 图 C-11
AT807P16	ASI	760A, 1.6KV, 0.15A, 3.5V	C-11			
AT807P17	ASI	760A, 1.7KV, 0.15A, 3.5V	C-11			
AT807P18	ASI	760A, 1.8KV, 0.15A, 3.5V	C-11			
AT807P19	ASI	760A, 1.9KV, 0.15A, 3.5V	C-11			
AT807P20	ASI	760A, 2KV, 0.15A, 3.5V	C-11			
AT807P21	ASI	760A, 2.1KV, 0.15A, 3.5V	C-11			
AT807P22	ASI	760A, 2.2KV, 0.15A, 3.5V	C-11			
AT807P23	ASI	760A, 2.3KV, 0.15A, 3.5V	C-11			
AT807P24	ASI	760A, 2.4KV, 0.15A, 3.5V	C-11			
AT807S01	ASI	760A, 100V, 0.15A, 3.5V	C-11			
AT807S02	ASI	760A, 200V, 0.15A, 3.5V	C-11			
AT807S03	ASI	760A, 300V, 0.15A, 3.5V	C-11			
AT807S04	ASI	760A, 400V, 0.15A, 3.5V	C-11			
AT807S05	ASI	760A, 500V, 0.15A, 3.5V	C-11			
AT807S06	ASI	760A, 600V, 0.15A, 3.5V	C-11			
AT807S07	ASI	760A, 700V, 0.15A, 3.5V	C-11			
AT807S08	ASI	760A, 800V, 0.15A, 3.5V	C-11			
AT807S09	ASI	760A, 900V, 0.15A, 3.5V	C-11			
AT807S10	ASI	760A, 1KV, 0.15A, 3.5V	C-11			
AT807S11	ASI	760A, 1.1KV, 0.15A, 3.5V	C-11			
AT807S12	ASI	760A, 1.2KV, 0.15A, 3.5V	C-11			
AT807S14	ASI	760A, 1.4KV, 0.15A, 3.5V	C-11			
AT807S15	ASI	760A, 1.5KV, 0.15A, 3.5V	C-11			
AT807S16	ASI	760A, 1.6KV, 0.15A, 3.5V	C-11			
AT807S17	ASI	760A, 1.7KV, 0.15A, 3.5V	C-11			
AT807S18	ASI	760A, 1.8KV, 0.15A, 3.5V	C-11			
AT807S19	ASI	760A, 1.9KV, 0.15A, 3.5V	C-11			

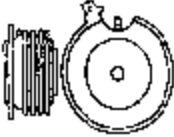

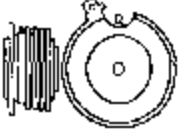
器件型号 Element type	厂名 Manufacturers	材料用途参数 Material Purpose Parameter	图号 Figure	国内外相似替换器件型号 Replace of similar type	备注 Notes	外形参考图 Reference snape
AT807S20	ASI	760A, 2kV, 0.15A, 3.5V	C-11			 图 C 11
AT807S21	ASI	760A, 2.1kV, 0.15A, 3.5V	C-11			
AT807S22	ASI	760A, 2.2kV, 0.15A, 3.5V	C-11			
AT807S23	ASI	760A, 2.3kV, 0.15A, 3.5V	C-11			
AT807S24	ASI	760A, 2.4kV, 0.15A, 3.5V	C-11			
AT1004P01	ASI	1.38kA, 100V, 0.15A, 3.5V	C-11			
AT1004P02	ASI	1.38kA, 200V, 0.15A, 3.5V	C-11			
AT1004P03	ASI	1.38kA, 300V, 0.15A, 3.5V	C-11			
AT1004P04	ASI	1.38kA, 400V, 0.15A, 3.5V	C-11			
AT1004P05	ASI	1.38kA, 500V, 0.15A, 3.5V	C-11			
AT1004P06	ASI	1.38kA, 600V, 0.15A, 3.5V	C-11			
AT1004P07	ASI	1.38kA, 700V, 0.15A, 3.5V	C-11			
AT1004P08	ASI	1.38kA, 800V, 0.15A, 3.5V	C-11			
AT1004P09	ASI	1.38kA, 900V, 0.15A, 3.5V	C-11			
AT1004P11	ASI	1.38kA, 1.1kV, 0.15A, 3.5V	C-11			
AT1004P12	ASI	1.38kA, 1.2kV, 0.15A, 3.5V	C-11			
AT1004P13	ASI	1.38kA, 1.3kV, 0.15A, 3.5V	C-11			
AT1004P14	ASI	1.38kA, 1.4kV, 0.15A, 3.5V	C-11			
AT1004P15	ASI	1.38kA, 1.5kV, 0.15A, 3.5V	C-11			
AT1004S01	ASI	1.38kA, 100V, 0.15A, 3.5V	C-11			
AT1004S02	ASI	1.38kA, 200V, 0.15A, 3.5V	C-11			
AT1004S03	ASI	1.38kA, 300V, 0.15A, 3.5V	C-11			
AT1004S04	ASI	1.38kA, 400V, 0.15A, 3.5V	C-11			
AT1004S05	ASI	1.38kA, 500V, 0.15A, 3.5V	C-11			
AT1004S06	ASI	1.38kA, 600V, 0.15A, 3.5V	C-11			
AT1004S07	ASI	1.38kA, 700V, 0.15A, 3.5V	C-11			
AT1004S08	ASI	1.38kA, 800V, 0.15A, 3.5V	C-11			
AT1004S09	ASI	1.38kA, 900V, 0.15A, 3.5V	C-11			

器件型号 Element type	厂名 Manufacturers	材料用途参数 Material Purpose Parameter	图号 Figure	国内外相似替换器件型号 Replace of similar type	备注 Notes	外形参考图 Reference shape
AT1004S11	ASI	1.38kA, 1.1kV, 0.15A, 3.5V	C-11			 <p>图 C-11</p>
AT1004S12	ASI	1.38kA, 1.2kV, 0.15A, 3.5V	C-11			
AT1004S13	ASI	1.38kA, 1.3kV, 0.15A, 3.5V	C-11			
AT1004S14	ASI	1.38kA, 1.4kV, 0.15A, 3.5V	C-11			
AT1004S15	ASI	1.38kA, 1.5kV, 0.15A, 3.5V	C-11			
AT1007P02	ASI	1.13kA, 200V, 0.15A, 3.5V	C-11			
AT1007P03	ASI	1.13kA, 300V, 0.15A, 3.5V	C-11			
AT1007P04	ASI	1.13kA, 400V, 0.15A, 3.5V	C-11			
AT1007P05	ASI	1.13kA, 500V, 0.15A, 3.5V	C-11			
AT1007P06	ASI	1.13kA, 600V, 0.15A, 3.5V	C-11			
AT1007P07	ASI	1.13kA, 700V, 0.15A, 3.5V	C-11			
AT1007P08	ASI	1.13kA, 800V, 0.15A, 3.5V	C-11			
AT1007P09	ASI	1.13kA, 900V, 0.15A, 3.5V	C-11			
AT1007P10	ASI	1.13kA, 1kV, 0.15A, 3.5V	C-11			
AT1007P11	ASI	1.13kA, 1.1kV, 0.15A, 3.5V	C-11			
AT1007P12	ASI	1.13kA, 1.2kV, 0.15A, 3.5V	C-11			
AT1007P13	ASI	1.13kA, 1.3kV, 0.15A, 3.5V	C-11			
AT1007P14	ASI	1.13kA, 1.4kV, 0.15A, 3.5V	C-11			
AT1007P15	ASI	1.13kA, 1.5kV, 0.15A, 3.5V	C-11			
AT1007P16	ASI	1.13kA, 1.6kV, 0.15A, 3.5V	C-11			
AT1007P17	ASI	1.13kA, 1.7kV, 0.15A, 3.5V	C-11			
AT1007P18	ASI	1.13kA, 1.8kV, 0.15A, 3.5V	C-11			
AT1007P19	ASI	1.13kA, 1.9kV, 0.15A, 3.5V	C-11			
AT1007P20	ASI	1.13kA, 2kV, 0.15A, 3.5V	C-11			
AT1007P21	ASI	1.13kA, 2.1kV, 0.15A, 3.5V	C-11			
AT1007P22	ASI	1.13kA, 2.2kV, 0.15A, 3.5V	C-11			
AT1007P23	ASI	1.13kA, 2.3kV, 0.15A, 3.5V	C-11			
AT1007P24	ASI	1.13kA, 2.4kV, 0.15A, 3.5V	C-11			

器件型号 Element type	厂名 Manufacturers	材料用途参数 Material Purpose Parameter	图号 Figure	国内外相似替换器件型号 Replace of similar type	备注 Notes	外形参考图 Reference shape
AT1007S01	ASI	1.13kA, 100V, 0.15A, 3.5V	C-11			 图 C-11
AT1007S02	ASI	1.13kA, 200V, 0.15A, 3.5V	C-11			
AT1007S03	ASI	1.13kA, 300V, 0.15A, 3.5V	C-11			
AT1007S04	ASI	1.13kA, 400V, 0.15A, 3.5V	C-11			
AT1007S05	ASI	1.13kA, 500V, 0.15A, 3.5V	C-11			
AT1007S06	ASI	1.13kA, 600V, 0.15A, 3.5V	C-11			
AT1007S07	ASI	1.13kA, 700V, 0.15A, 3.5V	C-11			
AT1007S08	ASI	1.13kA, 800V, 0.15A, 3.5V	C-11			
AT1007S09	ASI	1.13kA, 900V, 0.15A, 3.5V	C-11			
AT1007S10	ASI	1.13kA, 1kV, 0.15A, 3.5V	C-11			
AT1007S11	ASI	1.13kA, 1.1kV, 0.15A, 3.5V	C-11			
AT1007S12	ASI	1.13kA, 1.2kV, 0.15A, 3.5V	C-11			
AT1007S14	ASI	1.13kA, 1.4kV, 0.15A, 3.5V	C-11			
AT1007S15	ASI	1.13kA, 1.5kV, 0.15A, 3.5V	C-11			
AT1007S16	ASI	1.13kA, 1.6kV, 0.15A, 3.5V	C-11			
AT1007S17	ASI	1.13kA, 1.7kV, 0.15A, 3.5V	C-11			
AT1007S18	ASI	1.13kA, 1.8kV, 0.15A, 3.5V	C-11			
AT1007S19	ASI	1.13kA, 1.9kV, 0.15A, 3.5V	C-11			
AT1007S20	ASI	1.13kA, 2kV, 0.15A, 3.5V	C-11			
AT1007S21	ASI	1.13kA, 2.1kV, 0.15A, 3.5V	C-11			
AT1007S22	ASI	1.13kA, 2.2kV, 0.15A, 3.5V	C-11			
AT1007S23	ASI	1.13kA, 2.3kV, 0.15A, 3.5V	C-11			
AT1007S24	ASI	1.13kA, 2.4kV, 0.15A, 3.5V	C-11			
AT1018P20	ASI	780A, 2kV, 0.25A, 3.5V	C-11			
AT1018P21	ASI	780A, 2.1kV, 0.25A, 3.5V	C-11			
AT1018P22	ASI	780A, 2.2kV, 0.25A, 3.5V	C-11			
AT1018P24	ASI	780A, 2.4kV, 0.25A, 3.5V	C-11			
AT1018P25	ASI	780A, 2.5kV, 0.25A, 3.5V	C-11			

器件型号 Element type	厂名 Manufacturers	材料用途参数 Material Purpose Parameter	图号 Figure	国内外相似替换器件型号 Replace of similar type	备注 Notes	外形参考图 Reference shape		
AT1018P26	ASI	780A, 2.6kV, 0.25A, 3.5V	C-11			 图 C-11		
AT1018P27	ASI	780A, 2.7kV, 0.25A, 3.5V	C-11					
AT1018P28	ASI	780A, 2.8kV, 0.25A, 3.5V	C-11					
AT1018P29	ASI	780A, 2.9kV, 0.25A, 3.5V	C-11					
AT1018P30	ASI	780A, 3kV, 0.25A, 3.5V	C-11					
AT1018P31	ASI	780A, 3.1kV, 0.25A, 3.5V	C-11					
AT1018P32	ASI	780A, 3.2kV, 0.25A, 3.5V	C-11					
AT1018P34	ASI	780A, 3.4kV, 0.25A, 3.5V	C-11					
AT1018P35	ASI	780A, 3.5kV, 0.25A, 3.5V	C-11					
AT1018P36	ASI	780A, 3.6kV, 0.25A, 3.5V	C-11					
AT1018S20	ASI	780A, 2kV, 0.25A, 3.5V	C-11				 图 C-10	
AT1018S21	ASI	780A, 2.1kV, 0.25A, 3.5V	C-11					
AT1018S22	ASI	780A, 2.2kV, 0.25A, 3.5V	C-11					
AT1018S24	ASI	780A, 2.4kV, 0.25A, 3.5V	C-11					
AT1018S25	ASI	780A, 2.5kV, 0.25A, 3.5V	C-11					
AT1018S26	ASI	780A, 2.6kV, 0.25A, 3.5V	C-11					
AT1018S27	ASI	780A, 2.7kV, 0.25A, 3.5V	C-11					
AT1018S28	ASI	780A, 2.8kV, 0.25A, 3.5V	C-11					
AT1018S29	ASI	780A, 2.9kV, 0.25A, 3.5V	C-11					
AT1018S30	ASI	780A, 3kV, 0.25A, 3.5V	C-11					
AT1018S31	ASI	780A, 3.1kV, 0.25A, 3.5V	C-11					
AT1018S32	ASI	780A, 3.2kV, 0.25A, 3.5V	C-11					
AT1018S34	ASI	780A, 3.4kV, 0.25A, 3.5V	C-11					
AT1018S35	ASI	780A, 3.5kV, 0.25A, 3.5V	C-11					
AT1018S36	ASI	780A, 3.6kV, 0.25A, 3.5V	C-11					
ATF585P01B	ASI	400A, 100V, 0.35A, 3.5V	C-10					
ATF585P02B	ASI	400A, 200V, 0.35A, 3.5V	C-10					
ATF585P03B	ASI	400A, 300V, 0.35A, 3.5V	C-10					

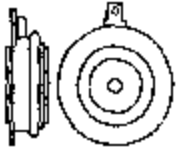

器件型号 Element type	厂名 Manufacturers	材料用途参数 Material Purpose Parameter	图号 Figure	国内外相似替换器件型号 Replace of similar type	备注 Notes	外形参考图 Reference shape
ATF585P04B	ASI	400A, 400V, 0.35A, 3.5V	C-10			 图 C-10
ATF585P05B	ASI	400A, 500V, 0.35A, 3.5V	C-10			
ATF585P06A	ASI	400A, 600V, 0.35A, 3.5V	B-94			
ATF585P06B	ASI	400A, 600V, 0.35A, 3.5V	C-10			
ATF585P06L	ASI	400A, 600V, 0.35A, 3.5V	B-94			
ATF585P06M	ASI	400A, 600V, 0.35A, 3.5V	B-94			
ATF585P07B	ASI	400A, 700V, 0.35A, 3.5V	C-10			
ATF585P08B	ASI	400A, 800V, 0.35A, 3.5V	C-10			
ATF585S01B	ASI	400A, 100V, 0.35A, 3.5V	C-10			
ATF585S02B	ASI	400A, 200V, 0.35A, 3.5V	C-10			
ATF585S03B	ASI	400A, 300V, 0.35A, 3.5V	C-10			
ATF585S04B	ASI	400A, 400V, 0.35A, 3.5V	C-10			
ATF585S05B	ASI	400A, 500V, 0.35A, 3.5V	C-10			
ATF585S06A, B, L, M	ASI	400A, 600V, 0.35A, 3.5V	B-94			
ATF585S07B	ASI	400A, 700V, 0.35A, 3.5V	C-10			
ATF585S08B	ASI	400A, 800V, 0.35A, 3.5V	C-10			
ATF587P01L	ASI	285A, 100V, 0.35A, 3.5V	C-10			 图 B-94
ATF587P02L	ASI	285A, 200V, 0.35A, 3.5V	C-10			
ATF587P03L	ASI	285A, 300V, 0.35A, 3.5V	C-10			
ATF587P04L	ASI	285A, 400V, 0.35A, 3.5V	C-10			
ATF587P05L	ASI	285A, 500V, 0.35A, 3.5V	C-10			
ATF587P06L	ASI	285A, 600V, 0.35A, 3.5V	C-10			
ATF587P07L	ASI	285A, 700V, 0.35A, 3.5V	C-10			
ATF587P08L	ASI	285A, 800V, 0.35A, 3.5V	C-10			
ATF587P09L	ASI	285A, 900V, 0.35A, 3.5V	C-10			
ATF587P10L	ASI	285A, 1kV, 0.35A, 3.5V	C-10			
ATF587P11L	ASI	285A, 1.1kV, 0.35A, 3.5V	C-10			

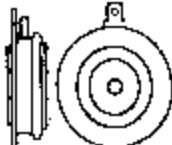
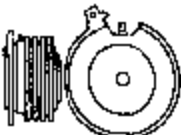
器件型号 Element type	厂名 Manufacturers	材料用途参数 Material Purpose Parameter	图号 Figure	国内外相似替换器件型号 Replace of similar type	备注 Notes	外形参考图 Reference shape	
ATF587P12L	ASI	285A, 1.2KV, 0.35A, 3.5V	C-10			 图 C-10	
ATF587S01L	ASI	285A, 100V, 0.35A, 3.5V	C-10				
ATF587S02L	ASI	285A, 200V, 0.35A, 3.5V	C-10				
ATF587S03L	ASI	285A, 300V, 0.35A, 3.5V	C-10				
ATF587S04L	ASI	285A, 400V, 0.35A, 3.5V	C-10				
ATF587S05L	ASI	285A, 500V, 0.35A, 3.5V	C-10				
ATF587S06L	ASI	285A, 600V, 0.35A, 3.5V	C-10				
ATF587S07L	ASI	285A, 700V, 0.35A, 3.5V	C-10				
ATF587S08L	ASI	285A, 800V, 0.35A, 3.5V	C-10				
ATF587S09L	ASI	285A, 900V, 0.35A, 3.5V	C-10				
ATF587S10L	ASI	285A, 1KV, 0.35A, 3.5V	C-10				
ATF587S11L	ASI	285A, 1.1KV, 0.35A, 3.5V	C-10				
ATF587S12L	ASI	285A, 1.2KV, 0.35A, 3.5V	C-10				
ATF827P01L	ASI	760A, 100V, 0.35A, 3.5V	C-11				 图 C-11
ATF827P02L	ASI	760A, 200V, 0.35A, 3.5V	C-11				
ATF827P03L	ASI	760A, 300V, 0.35A, 3.5V	C-11				
ATF827P04L	ASI	760A, 400V, 0.35A, 3.5V	C-11				
ATF827P05L	ASI	760A, 500V, 0.35A, 3.5V	C-11				
ATF827P06L	ASI	760A, 600V, 0.35A, 3.5V	C-11				
ATF827P07L	ASI	760A, 700V, 0.35A, 3.5V	C-11				
ATF827P08L, M, N, P	ASI	760A, 800V, 0.35A, 3.5V	C-11				
ATF827P10L	ASI	760A, 1KV, 0.35A, 3.5V	C-11				
ATF827P11L	ASI	760A, 1.1KV, 0.35A, 3.5V	C-11				
ATF827P12L	ASI	760A, 1.2KV, 0.35A, 3.5V	C-11				
ATF827P13L	ASI	760A, 1.3KV, 0.35A, 3.5V	C-11				
ATF827P14L	ASI	760A, 1.4KV, 0.35A, 3.5V	C-11				
ATF827S01L	ASI	760A, 100V, 0.35A, 3.5V	C-11				

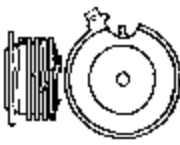

器件型号 Element type	厂名 Manufacturers	材料用途参数 Material Purpose Parameter	图号 Figure	国内外相似替换器件型号 Heplace of similar type	备注 Notes	外形参考图 Reference shape
ATF827S02L	ASI	760A, 200V, 0.35A, 3.5V	C-11			 图 C-11
ATF827S03L	ASI	760A, 300V, 0.35A, 3.5V	C-11			
ATF827S04L	ASI	760A, 400V, 0.35A, 3.5V	C-11			
ATF827S05L	ASI	760A, 500V, 0.35A, 3.5V	C-11			
ATF827S06L	ASI	760A, 600V, 0.35A, 3.5V	C-11			
ATF827S07L	ASI	760A, 700V, 0.35A, 3.5V	C-11			
ATF827S08L	ASI	760A, 800V, 0.35A, 3.5V	C-11			
ATF827S09L, M, N, P	ASI	760A, 900V, 0.35A, 3.5V	C-11			
ATF827S10L	ASI	760A, 1KV, 0.35A, 3.5V	C-11			
ATF827S11L	ASI	760A, 1.1KV, 0.35A, 3.5V	C-11			
ATF827S12L	ASI	760A, 1.2KV, 0.35A, 3.5V	C-11			
ATF827S14L	ASI	760A, 1.4KV, 0.35A, 3.5V	C-11			
ATF854P01N	ASI	685A, 100V, 0.35A, 3.5V	C-11			
ATF854P02N	ASI	685A, 200V, 0.35A, 3.5V	C-11			
ATF854P03N	ASI	685A, 300V, 0.35A, 3.5V	C-11			
ATF854P04N	ASI	685A, 400V, 0.35A, 3.5V	C-11			
ATF854P05N	ASI	685A, 500V, 0.35A, 3.5V	C-11			
ATF854P06N	ASI	685A, 600V, 0.35A, 3.5V	C-11			
ATF854P07N	ASI	685A, 700V, 0.35A, 3.5V	C-11			
ATF854P08N	ASI	685A, 800V, 0.35A, 3.5V	C-11			
ATF854P09N	ASI	685A, 900V, 0.35A, 3.5V	C-11			
ATF854P11N	ASI	685A, 1.1KV, 0.35A, 3.5V	C-11			
ATF854P12N	ASI	685A, 1.2KV, 0.35A, 3.5V	C-11			
ATF854S01N	ASI	685A, 100V, 0.35A, 3.5V	C-11			
ATF854S02N	ASI	685A, 200V, 0.35A, 3.5V	C-11			
ATF854S03N	ASI	685A, 300V, 0.35A, 3.5V	C-11			
ATF854S04N	ASI	685A, 400V, 0.35A, 3.5V	C-11			

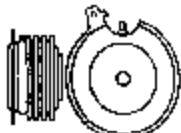
器件型号 Element type	厂名 Manufacturers	材料用途参数 Material Purpose Parameter	图号 Figure	国内外相似替换器件型号 Replace of similar type	备注 Notes	外形参考图 Reference shape
ATF854S05N	ASI	685A, 500V, 0.35A, 3.5V	C-11			 图 C-11
ATF854S06N	ASI	685A, 600V, 0.35A, 3.5V	C-11			
ATF854S07N	ASI	685A, 700V, 0.35A, 3.5V	C-11			
ATF854S08N	ASI	685A, 800V, 0.35A, 3.5V	C-11			
ATF854S09N	ASI	685A, 900V, 0.35A, 3.5V	C-11			
ATF854S12N	ASI	685A, 1.2kV, 0.35A, 3.5V	C-11			
ATF857P01L	ASI	620A, 100V, 0.35A, 3.5V	C-11			
ATF857P02L	ASI	620A, 200V, 0.35A, 3.5V	C-11			
ATF857P03L	ASI	620A, 300V, 0.35A, 3.5V	C-11			
ATF857P04L	ASI	620A, 400V, 0.35A, 3.5V	C-11			
ATF857P05L	ASI	620A, 500V, 0.35A, 3.5V	C-11			
ATF857P06L	ASI	620A, 600V, 0.35A, 3.5V	C-11			
ATF857P07L	ASI	620A, 700V, 0.35A, 3.5V	C-11			
ATF857P08L	ASI	620A, 800V, 0.35A, 3.5V	C-11			
ATF857P09L	ASI	620A, 900V, 0.35A, 3.5V	C-11			
ATF857P10L	ASI	620A, 1kV, 0.35A, 3.5V	C-11			
ATF857P12L	ASI	620A, 1.2kV, 0.35A, 3.5V	C-11			
ATF857S01L	ASI	620A, 100V, 0.35A, 3.5V	C-11			
ATF857S02L	ASI	620A, 200V, 0.35A, 3.5V	C-11			
ATF857S03L	ASI	620A, 300V, 0.35A, 3.5V	C-11			
ATF857S04L	ASI	620A, 400V, 0.35A, 3.5V	C-11			
ATF857S05L	ASI	620A, 500V, 0.35A, 3.5V	C-11			
A1F857S06L	ASI	620A, 600V, 0.35A, 3.5V	C-11			
ATF857S07L	ASI	620A, 700V, 0.35A, 3.5V	C-11			
ATF857S08L	ASI	620A, 800V, 0.35A, 3.5V	C-11			
ATF857S09L	ASI	620A, 900V, 0.35A, 3.5V	C-11			
ATF857S10L	ASI	620A, 1kV, 0.35A, 3.5V	C-11			
ATF857S12L	ASI	620A, 1.2kV, 0.35A, 3.5V	C-11			

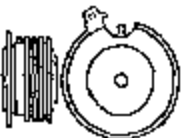

器件型号 Element type	厂名 Manufacturers	材料用途参数 Material Purpose Parameter	图号 Figure	国内外相似替换器件型号 Replace of similar type	备注 Notes	外形参考图 Reference shape
ATF860P01B	ASI	510A, 100V, 0.35A, 3.5V	C-11			 图 C-11
ATF860P02B	ASI	510A, 200V, 0.35A, 3.5V	C-11			
ATF860P03B	ASI	510A, 300V, 0.35A, 3.5V	C-11			
ATF860P04B	ASI	510A, 400V, 0.35A, 3.5V	C-11			
ATF860P05B	ASI	510A, 500V, 0.35A, 3.5V	C-11			
ATF860P06B	ASI	510A, 600V, 0.35A, 3.5V	C-11			
ATF860P07B	ASI	510A, 700V, 0.35A, 3.5V	C-11			
ATF860P08B	ASI	510A, 800V, 0.35A, 3.5V	C-11			
ATF860P09B	ASI	510A, 900V, 0.35A, 3.5V	C-11			
ATF860P10B	ASI	510A, 1kV, 0.35A, 3.5V	C-11			
ATF860P11B	ASI	510A, 1.1kV, 0.35A, 3.5V	C-11			
ATF860P12B	ASI	510A, 1.2kV, 0.35A, 3.5V	C-11			
ATF860S01B	ASI	510A, 100V, 0.35A, 3.5V	C-11			
ATF860S02B	ASI	510A, 200V, 0.35A, 3.5V	C-11			
ATF860S03B	ASI	510A, 300V, 0.35A, 3.5V	C-11			
ATF860S04B	ASI	510A, 400V, 0.35A, 3.5V	C-11			
ATF860S05B	ASI	510A, 500V, 0.35A, 3.5V	C-11			
ATF860S06B	ASI	510A, 600V, 0.35A, 3.5V	C-11			
ATF860S07B	ASI	510A, 700V, 0.35A, 3.5V	C-11			
ATF860S08B	ASI	510A, 800V, 0.35A, 3.5V	C-11			
ATF860S09B	ASI	510A, 900V, 0.35A, 3.5V	C-11			
ATF860S11B	ASI	510A, 1.1kV, 0.35A, 3.5V	C-11			
ATF860S12B	ASI	510A, 1.2kV, 0.35A, 3.5V	C-11			
ATF860P01P	ASI	540A, 100V, 0.35A, 3.5V	C-11			
ATF860P02P	ASI	540A, 200V, 0.35A, 3.5V	C-11			
ATF860P03P	ASI	540A, 300V, 0.35A, 3.5V	C-11			
ATF860P04P	ASI	540A, 400V, 0.35A, 3.5V	C-11			
ATF860P05P	ASI	540A, 500V, 0.35A, 3.5V	C-11			

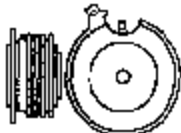
器件型号 Element type	厂名 Manufacturers	材料用途参数 Material Purpose Parameter	图号 Figure	国内外相似替换器件型号 Replace of similar type	备注 Notes	外形参考图 Reference shape
ATF880P06P	ASI	540A, 600V, 0.35A, 3.5V	C-11			 图 C-11
ATF880P07P	ASI	540A, 700V, 0.35A, 3.5V	C-11			
ATF880P08P	ASI	540A, 800V, 0.35A, 3.5V	C-11			
ATF880P09P	ASI	540A, 900V, 0.35A, 3.5V	C-11			
ATF880P10P	ASI	540A, 1kV, 0.35A, 3.5V	C-11			
ATF880P11P	ASI	540A, 1.1kV, 0.35A, 3.5V	C-11			
ATF880P12P	ASI	540A, 1.2kV, 0.35A, 3.5V	C-11			
ATF880P13P	ASI	540A, 1.3kV, 0.35A, 3.5V	C-11			
ATF880P14P	ASI	540A, 1.4kV, 0.35A, 3.5V	C-11			
ATF880P15P	ASI	540A, 1.5kV, 0.35A, 3.5V	C-11			
ATF880P16P	ASI	540A, 1.6kV, 0.35A, 3.5V	C-11			
ATF880P17P	ASI	540A, 1.7kV, 0.35A, 3.5V	C-11			
ATF880P18P	ASI	540A, 1.8kV, 0.35A, 3.5V	C-11			
ATF880P19P	ASI	540A, 1.9kV, 0.35A, 3.5V	C-11			
ATF880S01P	ASI	540A, 100V, 0.35A, 3.5V	C-11			
ATF880S02P	ASI	540A, 200V, 0.35A, 3.5V	C-11			
ATF880S03P	ASI	540A, 300V, 0.35A, 3.5V	C-11			
ATF880S04P	ASI	540A, 400V, 0.35A, 3.5V	C-11			
ATF880S05P	ASI	540A, 500V, 0.35A, 3.5V	C-11			
ATF880S06P	ASI	540A, 600V, 0.35A, 3.5V	C-11			
ATF880S07P	ASI	540A, 700V, 0.35A, 3.5V	C-11			
ATF880S08P	ASI	540A, 800V, 0.35A, 3.5V	C-11			
ATF880S09P	ASI	540A, 900V, 0.35A, 3.5V	C-11			
ATF880S11P	ASI	540A, 1.1kV, 0.35A, 3.5V	C-11			
ATF880S13P	ASI	540A, 1.3kV, 0.35A, 3.5V	C-11			
ATF880S15P	ASI	540A, 1.5kV, 0.35A, 3.5V	C-11			
ATF880S16P	ASI	540A, 1.6kV, 0.35A, 3.5V	C-11			
ATF880S17P	ASI	540A, 1.7kV, 0.35A, 3.5V	C-11			
ATF880S18P	ASI	540A, 1.8kV, 0.35A, 3.5V	C-11			



器件型号 Element type	厂名 Manufacturers	材料用途参数 Material Purpose Parameter	图号 Figure	国内外相似替换器件型号 Replace of similar type	备注 Notes	外形参考图 Reference shape
ATF880S19P	ASI	540A, 1.9kV, 0.35A, 3.5V	C-11			
ATF887P01L	ASI	670A, 100V, 0.35A, 3.5V	C-11			
ATF887P02L	ASI	670A, 200V, 0.35A, 3.5V	C-11			
ATF887P03L	ASI	670A, 300V, 0.35A, 3.5V	C-11			
ATF887P04L	ASI	670A, 400V, 0.35A, 3.5V	C-11			
ATF887P05L	ASI	670A, 500V, 0.35A, 3.5V	C-11			
ATF887P06L	ASI	670A, 600V, 0.35A, 3.5V	C-11			
ATF887P07L	ASI	670A, 700V, 0.35A, 3.5V	C-11			
ATF887P08L	ASI	670A, 800V, 0.35A, 3.5V	C-11			
ATF887P09L	ASI	670A, 900V, 0.35A, 3.5V	C-11			
ATF887P10L	ASI	670A, 1kV, 0.35A, 3.5V	C-11			
ATF887P11L	ASI	670A, 1.1kV, 0.35A, 3.5V	C-11			
ATF887P12L	ASI	670A, 1.2kV, 0.35A, 3.5V	C-11			
ATF887P13L	ASI	670A, 1.3kV, 0.35A, 3.5V	C-11			
ATF887P14L	ASI	670A, 1.4kV, 0.35A, 3.5V	C-11			
ATF887S01L	ASI	670A, 100V, 0.35A, 3.5V	C-11			
ATF887S02L	ASI	670A, 200V, 0.35A, 3.5V	C-11			
ATF887S03L	ASI	670A, 300V, 0.35A, 3.5V	C-11			
ATF887S04L	ASI	670A, 400V, 0.35A, 3.5V	C-11			
ATF887S05L	ASI	670A, 500V, 0.35A, 3.5V	C-11			
ATF887S06L	ASI	670A, 600V, 0.35A, 3.5V	C-11			
ATF887S07L	ASI	670A, 700V, 0.35A, 3.5V	C-11			
ATF887S08L	ASI	670A, 800V, 0.35A, 3.5V	C-11			
ATF887S09L	ASI	670A, 900V, 0.35A, 3.5V	C-11			
ATF887S10L	ASI	670A, 1kV, 0.35A, 3.5V	C-11			
ATF887S11L	ASI	670A, 1.1kV, 0.35A, 3.5V	C-11			
ATF887S12L	ASI	670A, 1.2kV, 0.35A, 3.5V	C-11			
ATF887S14L	ASI	670A, 1.4kV, 0.35A, 3.5V	C-11			



图 C-11

器件型号 Element type	厂名 Manufacturers	材料用途参数 Material Purpose Parameter	图号 Figure	国内外相似替换器件型号 Replace of similar type	备注 Notes	外形参考图 Reference shape
ATF1047P01M	ASI	1.07kA, 100V, 0.35A, 3.5V	C-11			 图 C-11
ATF1047P02M	ASI	1.07kA, 200V, 0.35A, 3.5V	C-11			
ATF1047P03M	ASI	1.07kA, 300V, 0.35A, 3.5V	C-11			
ATF1047P04M	ASI	1.07kA, 400V, 0.35A, 3.5V	C-11			
ATF1047P05M	ASI	1.07kA, 500V, 0.35A, 3.5V	C-11			
ATF1047P06M	ASI	1.07kA, 600V, 0.35A, 3.5V	C-11			
ATF1047P07M	ASI	1.07kA, 700V, 0.35A, 3.5V	C-11			
ATF1047P08M	ASI	1.07kA, 800V, 0.35A, 3.5V	C-11			
ATF1047P09M	ASI	1.07kA, 900V, 0.35A, 3.5V	C-11			
ATF1047P09N, P, R	ASI	1kA, 900V, 0.35A, 3.5V	C-11			
ATF1047S09R	ASG	1kA, 900V, 0.35A, 3.5V	C-11			



A 类外形参考图索引

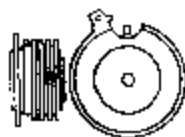
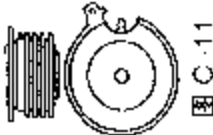

图 B-9



图 B-11

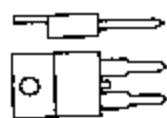

图 B-19

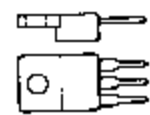

图 B-36

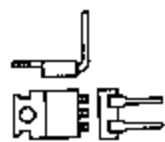

图 B-51

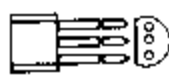

图 B-65



图 B-69



图 B-91



图 B-94

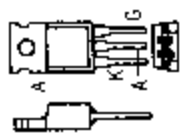

图 B-98

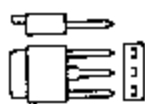

图 B-100

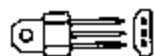

图 C-10

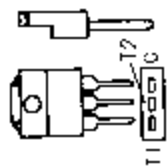

图 C-11

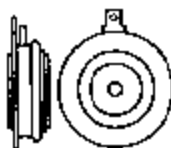

图 C-39

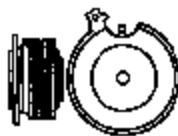

图 D-9

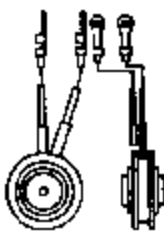

图 E-22

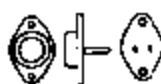

图 F-1



图 F-21



图 F-48



图 F-64

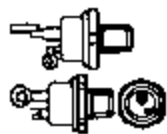

图 G-5



图 H-32

器件型号 Element type	厂名 Manufacturers	材料用途参数 Material Purpose Parameter	图号 Figure	国内外相似替换器件型号 Replace of similar type	备注 Notes	外形参考图 Reference shape
B25CS10		MOD, 25A, 100V				
B25CS20		MOD, 25A, 200V				
B25CS40		MOD, 25A, 400V				
B25CS60		MOD, 25A, 600V				
B25CS80		MOD, 25A, 800V				
B25CS100		MOD, 25A, 1kV				
B25CS120		MOD, 25A, 1.2kV				
B25DS10		MOD, 25A, 100V				
B25DS20		MOD, 25A, 200V				
B25DS40		MOD, 25A, 400V				
B25DS60		MOD, 25A, 600V				
B25DS80		MOD, 25A, 800V				
B25DS100		MOD, 25A, 1kV				
B25DS120		MOD, 25A, 1.2kV				
B25R1A10		MOD, 25A, 1kV				
B25R1A20		MOD, 25A, 1.2kV				
B25R1A40		MOD, 25A, 400V				
B25R1A60		MOD, 25A, 600V				
B25R1A80		MOD, 25A, 800V				
B40A10		40A, 100V				
B40A20		40A, 200V				
B40A40		40A, 400V				
B40A60		40A, 600V				
B40A80		40A, 800V				
B40A100		40A, 1kV				
B40A120		40A, 1.2kV				
B150	UNI	0.2A, 30V, 0.0002A, 0.8V	B-52	EC103Y		

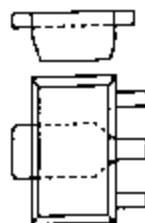

图 B-52



器件型号 Element type	厂名 Manufacturers	材料用途参数 Material Purpose Parameter	图号 Figure	国内外相似替换器件型号 Replace of similar type	备注 Notes	外形参考图 Reference shape
B151	UNI	0.2A, 60V, 0.0002A, 0.8V	B-52	EC103A		
B411-2	GTN	15A, 0.04A, 2.5V	H-25			
B411F	GTN	=B411-2	H-25			
B412-2	GTN	15A, 0.04A, 2.5V	H-25			
B412F	GTN	=B412-2	H-25			
B413-2	GTN	15A, 0.04A, 2.5V	H-25			
B413F, S	GTN	=B413-2	H-25			
B421-2	GTN	15A, 0.04A, 2.5V	H-25			
B421F, S	GTN	=B421-2	H-25			
B422-2	GTN	15A, 0.04A, 2.5V	H-25			
B422F, S	GTN	=B422-2	H-25			
B423-2	GTN	15A, 0.04A, 2.5V	H-25			
B423F, S	GTN	=B423-2	H-25			
B431-2	GTN	15A, 0.04A, 2.5V	H-25			
B431F, S	GTN	=B431-2	H-25			
B432-2	GTN	15A, 0.04A, 2.5V	H-25			
B432F, S	GTN	=B432-2	H-25			
B433-2	GTN	15A, 0.04A, 2.5V	H-25			
B433F, S	GTN	=B433-2	H-25			
B441-2	GTN	15A, 0.04A, 2.5V	H-25			
B441F, S	GTN	=B441-2	H-25			
B442-2	GTN	15A, 0.04A, 2.5V	H-25			
B442F, S	GTN	=B442-2	H-25			
B443-2	GTN	15A, 0.04A, 2.5V	H-25			
B443F, S	GTN	=B443-2	H-25			

B-52

H-25





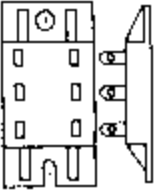

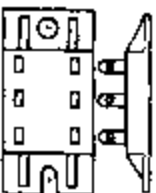



器件型号 Element type	厂名 Manufacturers	材料用途参数 Material Purpose Parameter	图号 Figure	国内外相似替换器件型号 Replace of similar type	备注 Notes	外形参考图 Reference shape
B451-2	GTN	15A, 0.04A, 2.5V	H-25			 <p>图 H-25</p>
B451F, S	GTN	=B451-2	H-25			
B452-2	GTN	15A, 0.04A, 2.5V	H-25			
B452F, S	GTN	=B452-2	H-25			
B453-2	GTN	15A, 0.04A, 2.5V	H-25			
B453F, S	GTN	=B453-2	H-25			
B461-2	GTN	15A, 0.04A, 2.5V	H-25			
B461F, S	GTN	=B461-2	H-25			
B462-2, S	GTN	15A, 0.04A, 2.5V	H-25			
B462F, S	GTN	=B462-2	H-25			
B463-2	GTN	15A, 0.04A, 2.5V	H-25			
B463F, S	GTN	=B463-2	H-25			
B471-2	GTN	15A, 0.04A, 2.5V	H-25			
B471F, S	GTN	=B471-2	H-25			
B472-2	GTN	15A, 0.04A, 2.5V	H-25			
B472F, S	GTN	=B472-2	H-25			
B473-2	GTN	15A, 0.04A, 2.5V	H-25			
B473F, S	GTN	=B473-2	H-25	ECG131		
B481-2	GTN	15A, 0.04A, 2.5V	H-25			
B481F, S	GTN	=B481-2	H-25	ECG131		
B482-2	GTN	15A, 0.04A, 2.5V	H-25			
B482F, S	GTN	=B482-2	H-25			
B483-2	GTN	15A, 0.04A, 2.5V	H-25			
B483F, S	GTN	=B483-2	H-25			
B483-C	GTN	15A, 0.04A, 2.5V	H-25			

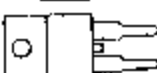

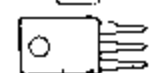

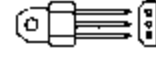

器件型号 Element type	厂名 Manufacturers	材料用途参数 Material Purpose Parameter	图号 Figure	国内外相似替换器件型号 Replace of similar type	备注 Notes	外形参考图 Reference shape
B491-2	GTN	15A, 0.04A, 2.5V	H-25			 <p>图 H-25</p>
B491F, S	GTN	=B491-2	H-25			
B492-2	GTN	15A, 0.04A, 2.5V	H-25			
B492F, S	GTN	=B492-2	H-25			
B493-2	GTN	15A, 0.04A, 2.5V	H-25			
B493F, S	GIN	=B493-2	H-25			
B511-2	GTN	25A, 0.04A, 2.5V	H-25			
B511F, S	GTN	=B511-2	H-25			
B512-2	GTN	25A, 0.04A, 2.5V	H-25			
B512F, S	GTN	=B512-2	H-25			
B513-2	GTN	25A, 0.04A, 2.5V	H-25			
B513F, S	GTN	=B513-2	H-25			
B521-2	GTN	25A, 0.04A, 2.5V	H-25			
B521F, S	GTN	=B521-2	H-25			
B522-2	GTN	25A, 0.04A, 2.5V	H-25			
B522F, S	GTN	=B522-2	H-25			
B523-2	GTN	25A, 0.04A, 2.5V	H-25			
B523F, S	GTN	=B523-2	H-25			
B531-2	GTN	25A, 0.04A, 2.5V	H-25			
B531F, S	GTN	=B531-2	H-25			
B532-2	GTN	25A, 0.04A, 2.5V	H-25			
B532F, S	GTN	=B532-2	H-25			
B533-1	GTN	25A, 0.04A, 2.5V	H-25			
B533-2	GTN	25A, 0.04A, 2.5V	H-25			
B533F, S	GTN	=B533-2	H-25			

器件型号 Element type	厂名 Manufacturers	材料用途参数 Material Purpose Parameter	图号 Figure	国内外相似替换器件型号 Replace of similar type	备注 Notes	外形参考图 Reference shape
B541-2	GTN	25A, 300V, 0.04A, 2.5V	H-25			 <p>图 H-25</p>
B541F, S	GTN	25A, 0.04A, 2.5V	H-25			
B542-2	GTN	25A, 500V, 0.04A, 2.5V	H-25			
B542F, S	GTN	25A, 0.04A, 2.5V	H-25			
B543-2	GTN	25A, 0.04A, 2.5V	H-25			
B543F, S	GTN	=B543-2	H-25			
B551-1	GTN	25A, 0.04A, 2.5V	H-25			
B551-2	GTN	25A, 0.04A, 2.5V	H-25			
B551-C, F, S	GTN	=B551-2	H-25			
B552-2	GTN	25A, 500V, 0.04A, 2.5V	H-25			
B552F, S	GTN	25A, 0.04A, 2.5V	H-25			
B553-2	GTN	25A, 0.04A, 2.5V	H-25			
B553F, S	GTN	=B553-2	H-25			
B1452F	GTN	15A, 0.04A, 2.5V				
B1481S	GTN	15A, 0.04A, 2.5V				
B1483-1	GTN	15A, 0.04A, 2.5V				
B1541F	GTN	25A, 0.04A, 2.5V				
B1562-C	GTN	25A, 0.04A, 2.5V				
B1571F	GTN	25A, 0.04A, 2.5V				
B1593S	GTN	25A, 0.04A, 2.5V				
B2423S	GTN	15A, 0.04A, 2.5V				
B2461...3	GTN	15A, 0.04A, 2.5V				
B2471...3	GTN	15A, 0.04A, 2.5V				
B2481...3	GTN	15A, 0.04A, 2.5V				
B2512	GTN	25A, 0.04A, 2.5V				

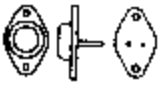
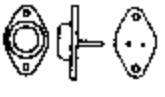

器件型号 Element type	厂名 Manufacturers	材料用途参数 Material Purpose Parameter	图号 Figure	国内外相似替换器件型号 Replace of similar type	备注 Notes	外形参考图 Reference shape
B2533	GTN	25A, 0.04A, 2.5V				
B2621	GTN	55A, 0.11A, 3V				
B2623	GTN	55A, 0.11A, 3V				
B2631...2	GTN	55A, 0.11A, 3V				
B2641...3	GTN	55A, 0.11A, 3V				
B2651...3	GTN	55A, 0.11A, 3V				
B2661...3	GTN	55A, 0.11A, 3V				
B2671...3	GTN	55A, 0.11A, 3V				
B2681...3	GTN	55A, 0.11A, 3V				
B2691...3	GTN	55A, 0.11A, 3V				
BA150	UNE	0.25A, 30V, 0.0002A, 0.8V	B-65	ECG103Y, TAG06Y		
BA151	UNE	0.25A, 60V, 0.0002A, 0.8V	B-65	ECG103A, TAG06YY		
BA152	UNE	0.25A, 100V, 0.0002A, 0.8V	B-65	ECG103A, TAG06A		
BAT212B-600		Triac	B-9			
BAT212B-700		Triac	B-9			
BAT212B-800		Triac	B-9			
BBCC106B		50Hz-Thy	B-11	MCR72, S4060, TIC106, TAG623, TAG628		
BBCC106B-1		50Hz-lhy	B-98	C106, C108, TAG106, TAG108, X0403		
BBCC106D		50Hz-Thy	B-11	MCR72, S4060, TAG623, TAG628, TIC106		
BBCC106D-1		50Hz-Thy	B-98	C106, C108, TAG106, TAG108, X0403		
BBCC106E		50Hz-Thy	B-11	MCR72, S4060, TIC106, TAG623, TAG628		
BBCC106E-1		50Hz-Thy	B-98	C106, C108, TAG106, TAG108, X0403		
BBCC106F		50Hz-Thy	B-11	MCR72, S4060, TIC106, TAG623		
BBCC106F-1		50Hz-Thy	B-98	C106, C108, TAG106, TAG108, X0403		
BCR1AM4		Triac	D-9	TAG204-200, TAG205-200, ZO101, ZO104		

器件型号 Element type	厂名 Manufacturers	材料用途参数 Material Purpose Parameter	图号 Figure	国内外相似替换器件型号 Replace of similar type	备注 Notes	外形参考图 Reference shape
BCR1AM6		Triac 1A, 300V, 0.01A	D-9	TAG204-300, TAG205-300, ZO101, ZO104		 图 D-9
BCR1AM8	MIT	Triac 1A, 400V, 0.01A, 2V	D-9	TAG204-400, TAG205-400, ZO101, ZO104		
BCR1AM10	MIT	Triac 1A, 500V, 0.01A, 2V	D-9	IAG204-500, TAG205-500, ZO101, ZO104		
BCR1AM12	MIT	Triac 1A, 600V, 0.01A, 2V	D-9	TAG204-600, TAG205-600, ZO101, ZO104		
BCR3AM4		Triac 3A, 200V, 0.03A	B-87	T2322, T2323, ZO409, ZO410		 图 D-9
BCR3AM8	MIT	Triac 3A, 400V, 0.03A, 2V	B-87	T2322, T2323, ZO409, ZO410		
BCR3AM10	MIT	Triac 3A, 500V, 0.03A, 2V	B-87	T2322, T2323, ZO409, ZO410		
BCR3AM12	MIT	SCR-D 3A, 600V, 0.03A, 2V	B-87	T2322, T2323, ZO409, ZO410		
BCR6AM4		SCR-D 6A, 200V, 0.03A	B-79	TAG220-200, TAG225-200, TAG252-200		 图 D-87
BCR6AM6		SCR-D 6A, 300V, 0.03A	B-79	TAG220-300, TAG225-300, TAG252-300		
BCR6AM8	MIT	SCR-D 6A, 400V, 0.03A, 1.5V	B-79	TAG220-400, TAG225-400, TAG252-400		
BCR6AM10	MIT	SCR-D 6A, 500V, 0.03A, 1.5V	B-79	TAG220-500, TAG225-500, TAG252-500		
BCR6AM12	MIT	SCR-D 6A, 600V, 0.03A, 1.5V	B-79	TAG220-600, TAG225-600, TAG252-600		
BCR8A4		Triac 8A, 200V, 0.05A	D-9	BS9-A, MAC222, TIC226, T2802		 图 B-79
BCR8A6		Triac 8A, 300V, 0.05A	D-9	BS9-A, MAC222, TIC226, T2802		
BCR8A8		Triac 8A, 400V, 0.05A	D-9	BS9-A, MAC222, TIC226, T2802		
BCR8A10		Triac 8A, 500V, 0.05A	D-9	BS9-A, MAC222, TIC226, T2802		
BCR8CM4		Triac 8A, 200V, 0.03A	B-79	BTA21, T2806		 图 B-79
BCR8CM6		Triac 8A, 300V, 0.03A	B-79	BTA21, T2806		
BCR8CM8		Triac 8A, 400V, 0.03A	B-79	BTA21, BT158-400, BT162, T2806		
BCR8CM10	MIT	SCR-D 8A, 500V, 0.03A, 3V	B-79	BTA21, BT158-500, BT162, T2806		
BCR8CM12	MIT	SCR D 8A, 600V, 0.03A, 1.5V	B-79	BTA21, BT158-600, BT162, T2806		
BCR8DM4		SCR-D 8A, 200V, 0.03A	B-79	BTA21, T2806		 图 B-79
BCR8DM6		SCR-D 8A, 300V, 0.03A	B-79	BTA21, T2806		
BCR8DM8	MIT	SCR-D 8A, 400V, 0.03A, 1.5V	B-79	BTA21, BT158, BT162, T2806		



器件型号 Element type	厂名 Manufacturers	材料用途参数 Material Purpose Parameter	图号 Figure	国内外相似替换器件型号 Replace of similar type	备注 Notes	外形参考图 Reference shape
BCR10A2		Triac 10A, 100V, 0.05A	D-35			
BCR10A4		Triac 10A, 200V, 0.05A	D-35			
BCR10A6		Triac 10A, 300V, 0.05A	D-35			
BCR10A8		Triac 10A, 400V, 0.05A	D-35			
BCR10AM4		Triac 10A, 200V, 0.03A	B-79	TAG252-200, TAG257-200		
BCR10AM6		Triac 10A, 300V, 0.03A	B-79	TAG252-300, TAG257-300		
BCR10AM8	MIT	SCR-D 10A, 400V, 0.03A, 1.5V	B-79	TAG252-400, TAG257-400		
BCR10AM10	MIT	SCR-D 10A, 500V, 0.03A, 1.5V	B-79	TAG252-500, TAG257-500		
BCR10AM12	MIT	SCR-D 10A, 600V, 0.03A, 1.5V	B-79	TAG252-600, TAG257-600		
BCR10B2...B		Triac =BCR10A2...8	D-9			
BCR10C2...B		Triac =BCR10A2...8	F-55	BS10...A, SC245, SC250, TXD99		
BCR10CM4...12		Triac =BCR12AM4...12; 10A	B-79	TAG252..., TAG257...		
BCR10DM4...12		Triac =BCR12AM4...12; 10A	B-79	TAG252..., TAG257...		
BCR10EM4...12		Triac =BCR12AM4...12; 10A	B-79	TAG252..., TAG257...		
BCR12AM4		Triac 12A, 200V, 0.03A	B-79	TAG257-200		
BCR12AM6		Triac 12A, 300V, 0.03A	B-79	TAG257-300		
BCR12AM8	MIT	Triac 12A, 400V, 0.03A, 1.5V	B-79	TAG257-400		
BCR12AM10	MIT	Triac 12A, 500V, 0.03A, 1.5V	B-79	TAG257-500		
BCR12AM12		Triac 12A, 600V, 0.03A	B-79	TAG257-600		
BCR12CM4...12		Triac =BCR12AM4...12; 12A	B-79	TAG257...		
BCR12DM4...12		Triac =BCR12AM4...12; 12A	B-79	TAG257...		
BCR12EM4...12		Triac =BCR12AM4...12; 12A	B-79	TAG257...		
BCR16A4	MIT	Triac 16A, 200V, 0.03A, 1.5V	C-86			
BCR16A6	MIT	Triac 16A, 300V, 0.03A, 1.5V	C-86			
BCR16A8	MIT	Triac 16A, 400V, 0.03A, 1.5V	C-86			
BCR16A10	MIT	Triac 16A, 500V, 0.03A, 1.5V	C-86			
BCR16B4	MIT	Triac 16A, 200V, 0.03A, 1.5V	D-28			









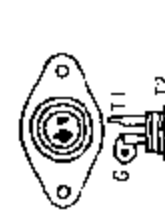

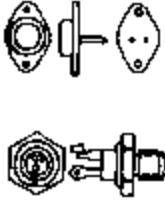

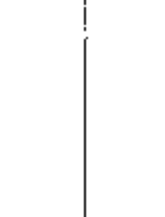

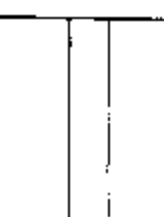

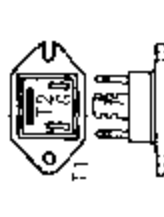
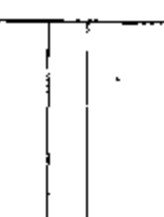
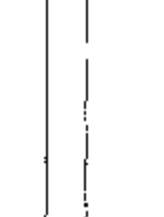
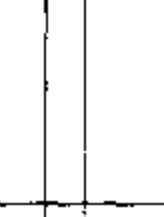
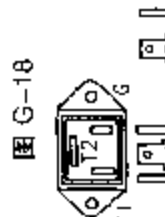
图 D-35

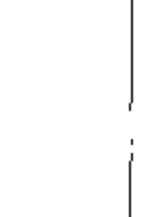
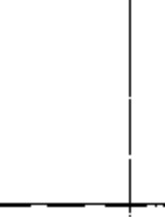
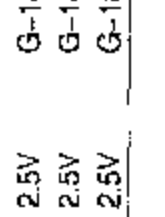
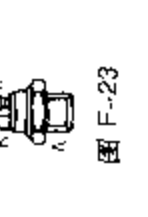
图 B-79 图 D-9

图 F-55 图 C-86

图 D-28

器件型号 Element type	厂名 Manufacturers	材料用途参数 Material Purpose Parameter	图号 Figure	国内外相似替换器件型号 Replace of similar type	备注 Notes	外形参考图 Reference shape
BCR16B6	MIT	SCR-D 16A, 300V, 0.03A, 1.5V	D-28			
BCR16B8	MIT	SCR-D 16A, 400V, 0.03A, 1.5V	D-28			
BCR16B10	MIT	SCR-D 16A, 500V, 0.03A, 1.5V	D-28			
BCR16C4	MIT	SCR-D 16A, 200V, 0.03A, 1.5V	F-11			
BCR16C6	MIT	SCR-D 16A, 300V, 0.03A, 1.5V	F-11			
BCR16C8	MIT	SCR-D 16A, 400V, 0.03A, 1.5V	F-11			
BCR16C10	MIT	SCR-D 16A, 500V, 0.03A, 1.5V	F-11			
BCR16CM4...10	MIT	SCR-D 16A, 200V, 0.03A	B-79			
BCR16CM12	MIT	SCR-D 16A, 600V, 0.03A, 1.5V	B-91			
BCR16DM4...10	MIT	SCR-D =BCR16A4...10	B-79			
BCR16DM12	MIT	SCR-D 16A, 600V, 0.03A, 1.5V	B-79			
BCR16E4...10	MIT	SCR-D =BCR16A4...10	D-29			
BCR16EM4...11	MIT	SCR-D =BCR16A4...10	B-102			
BCR16EM-12	MIT	SCR-D 16A, 600V, 0.03A	B-102			
BCR16FM-4...10	MIT	SCR-D =BCR16A4...10, Tc=73°C	B-101			
BCR16FM-12	MIT	SCR-D 16A, 600V, 0.03A	B-101			
BCR16GM4...10	MIT	SCR-D =BCR16A4...10, Tc=73°C	G-20			
BCR16GM12	MIT	SCR-D 16A, 600V, 0.03A, 1.5V	G-20			
BCR16HM4...10	MIT	SCR-D =BCR16A4...10, Tc=82°C	G-18			
BCR16HM12	MIT	SCR-D 16A, 600V, 0.03A	G-18			
BCR20A4	MIT	SCR-D 20A, 200V, 0.03A, 1.5V	C-86			
BCR20A6	MIT	SCR-D 20A, 300V, 0.03A, 1.5V	C-86			
BCR20A8	MIT	SCR-D 20A, 400V, 0.03A, 1.5V	C-86			
BCR20A10	MIT	SCR-D 20A, 500V, 0.03A, 1.5V	C-86			
BCR20A12	MIT	SCR-D 20A, 600V	C-86			
BCR20B4...10	MIT	SCR-D =BCR20A4...10	D-29			
BCR20B12	MIT	SCR-D 20A, 600V	D-29			
BCR20C4	MIT	SCR-D 20A, 200V, 0.03A, 1.5V	F-11			

器件型号 Element type	厂名 Manufacturers	材料用途参数 Material Purpose Parameter	图号 Figure	国内外相似替换器件型号 Replace of similar type	备注 Notes	外形参考图 Reference shape
BCR20C6	MIT	SCR-D 20A, 300V, 0.03A, 1.5V	F-11			
BCR20C8	MIT	SCR-D 20A, 400V, 0.03A, 1.5V	F-11			
BCR20C10	MIT	SCR-D 20A, 500V, 0.03A, 1.5V	F-11			
BCR20E4	MIT	SCR-D 20A, 200V, 0.03A, 1.5V	D-9			
BCR20E6	MIT	SCR-D 20A, 300V, 0.03A, 1.5V	D-9			
BCR20E8	MIT	SCR-D 20A, 400V, 0.03A, 1.5V	D-9			
BCR20E10	MIT	SCR-D 20A, 500V, 0.03A, 1.5V	D-9			
BCR25A4	MIT	SCR-D 25A, 200V, 0.05A, 3V	F-27			
BCR25A6	MIT	SCR-D 25A, 300V, 0.05A, 3V	F-27			
BCR25A8	MIT	SCR-D 25A, 400V, 0.05A, 3V	F-27			
BCR25A10	MIT	SCR-D 25A, 500V, 0.05A, 3V	F-27			
BCR25B4...10		SCR-D =BCR25A4...10	D-28			
BCR30G4		SCR-D 30A, 200V	G-18			
BCR30G6		SCR-D 30A, 300V	G-18			
BCR30G8		SCR-D 30A, 400V	G-18			
BCR30G10		SCR-D 30A, 500V	G-18			
BCR30G12		SCR-D 30A, 600V	G-18			
BCR30GM4		SCR-D 30A, 200V, 0.05A	G-12			
BCR30GM6		SCR-D 30A, 300V, 0.05A	G-12			
BCR30GM8	MIT	SCR-D 30A, 400V, 0.05A, 2.5V	G-18			
BCR30GM10	MIT	SCR-D 30A, 500V, 0.05A, 2.5V	G-18			
BCR30GM12	MIT	SCR-D 30A, 600V, 0.05A, 2.5V	G-18			
BCR50A4	MIT	SCR-D 50A, 200V, 0.1A, 2.5V	F-23			
BCR50A6	MIT	SCR-D 50A, 300V, 0.1A, 2.5V	F-23			
BCR50A8	MIT	SCR-D 50A, 400V, 0.1A, 2.5V	F-23			
BCR50A12	MIT	SCR-D 50A, 600V, 0.1A, 2.5V	F-23			



器件型号 Element type	厂名 Manufacturers	材料用途参数 Material Purpose Parameter	图号 Figure	国内外相似替换器件型号 Replace of similar type	备注 Notes	外形参考图 Reference shape
BCR60A16	MIT	SCR-D 50A, 800V, 0.1A, 2.5V	F-23			 图 F-23
BCR70B4	MIT	SCR-D 70A, 200V, 0.2A, 3V	F-71			
BCR70B6	MIT	SCR-D 70A, 300V, 0.2A, 3V	F-71			
BCR70B8	MIT	SCR-D 70A, 400V, 0.2A, 3V	F-71			
BCR70B12	MIT	SCR-D 70A, 600V, 0.2A, 3V	F-71			
BCR70B16	MIT	SCR-D 70A, 800V, 0.2A, 3V	F-71			
BCR70B20	MIT	SCR-D 70A, 1kV, 0.2A, 3V	F-71			
BCR70B24	MIT	SCR-D 70A, 1.2kV, 0.2A, 3V	F-71			
BCR150B4	MIT	SCR-D 150A, 200V, 0.3A, 3V	F-71			
BCR150B6	MIT	SCR-D 150A, 300V, 0.3A, 3V	F-71			
BCR150B8	MIT	SCR-D 150A, 400V, 0.3A, 3V	F-71			
BCR150B12	MIT	SCR-D 150A, 600V, 0.3A, 3V	F-71			
BCR150B16	MIT	SCR-D 150A, 800V, 0.3A, 3V	F-71			
BCR150B20	MIT	SCR-D 150A, 1kV, 0.3A, 3V	F-71			
BCR150B24	MIT	SCR-D 150A, 1.2kV, 0.3A, 3V	F-71			
BCR150BX12	SCR-N	150A, 480V				
BCR150BX16	SCR-N	150A, 640V				
BCR150BX20	SCR-N	150A, 800V				
BCR150BX24	SCR-N	150A, 960V				
BCR150BY4	SCR-N	150A, 160V	E-22			
BCR150BY6	SCR-N	150A, 240V	E-22			
BCR150BY8	SCR-N	150A, 320V	E-22			
BCR150BY10	SCR-N	150A, 400V	E-22			
BCR150BY12	SCR-N	150A, 480V	E-22			
BCR150BY16	SCR-N	150A, 640V	C-22			
BCR300B4	MIT	SCR-D 300A, 200V, 0.3A, 3V	F-71			

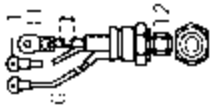
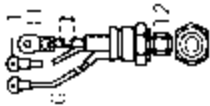
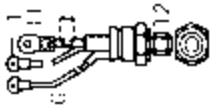
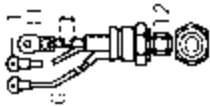

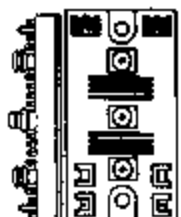
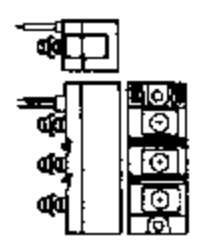

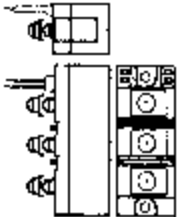
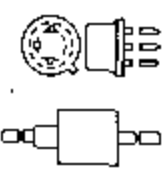
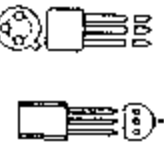
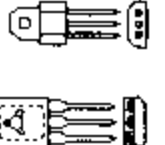

器件型号 Element type	厂名 Manufacturers	材料用途参数 Material Purpose Parameter	图号 Figure	国内外相似替换器件型号 Replace of similar type	备注 Notes	外形参考图 Reference shape
BCR300B6	MIT	SCR-D 300A, 300V, 0.3A, 3V	F-71			 图 F-71
BCR300B8	MIT	SCR-D 300A, 400V, 0.3A, 3V	F-71			
BCR300B12	MIT	SCR-D 300A, 600V, 0.3A, 3V	F-71			
BCR300B16	MIT	SCR-D 300A, 800V, 0.3A, 3V	F-71			
BCR300B20	MIT	SCR-D 300A, 1kV, 0.3A, 3V	F-71			
BCR300B24	MIT	SCR-D 300A, 1.2kV, 0.3A, 3V	F-71			
BD100	UNI	2A, 30V, 0.0002A, 0.8V				 图 F-71
BD101	UNI	2A, 60V, 0.0002A, 0.8V				
BD102	UNI	2A, 100V, 0.0002A, 0.8V				
BDF150S01L	ASG	SCA 150A, 100V, 0.35A, 3.5V	H-22			 图 H-22
BDF150S02L	ASG	SCA 150A, 200V, 0.35A, 3.5V	H-22			
BDF150S03L	ASG	SCA 150A, 300V, 0.35A, 3.5V	H-22			
BDF150S04L	ASG	SCA 150A, 400V, 0.35A, 3.5V	H-22			
BDF150S05L	ASG	SCA 150A, 500V, 0.35A, 3.5V	H-22			
BDF150S06L	ASG	SCA 150A, 600V, 0.35A, 3.5V	H-22			
BDF150S07L	ASG	SCA 150A, 700V, 0.35A, 3.5V	H-22			
BDF150S08L	ASG	SCA 150A, 800V, 0.35A, 3.5V	H-22			
BDF150S09L	ASG	SCA 150A, 900V, 0.35A, 3.5V	H-22			
BDF150S10L	ASG	SCA 150A, 1kV, 0.35A, 3.5V	H-22			
BDF150S11L	ASG	SCA 150A, 1.1kV, 0.35A, 3.5V	H-22			
BDF150S12L	ASG	SCA 150A, 1.2kV, 0.35A, 3.5V	H-22			
BFD150S01L	ASG	SCA 150A, 100V, 0.35A, 3.5V	H-22			 图 H-22
BFD150S02L	ASG	SCA 150A, 200V, 0.35A, 3.5V	H-22			
BFD150S03L	ASG	SCA 150A, 300V, 0.35A, 3.5V	H-22			
BFD150S04L	ASG	SCA 150A, 400V, 0.35A, 3.5V	H-22			
BFD150S05L	ASG	SCA 150A, 500V, 0.35A, 3.5V	H-22			

器件型号 Element type	厂名 Manufacturers	材料用途参数 Material Purpose Parameter	图号 Figure	国内外相似替换器型号 Replace of similar type	备注 Notes	外形参考图 Reference shape
BFD150S06L	ASG	SCA 150A, 600V, 0.35A, 3.5V	H-22			 <p>图 H-22</p>
BFD150S07L	ASG	SCA 150A, 700V, 0.35A, 3.5V	H-22			
BFD150S08L	ASG	SCA 150A, 800V, 0.35A, 3.5V	H-22			
BFD150S09L	ASG	SCA 150A, 900V, 0.35A, 3.5V	H-22			
BFD150S10L	ASG	SCA 150A, 1kV, 0.35A, 3.5V	H-22			
BFD150S11L	ASG	SCA 150A, 1.1kV, 0.35A, 3.5V	H-22			
BFD150S12L	ASG	SCA 150A, 1.2kV, 0.35A, 3.5V	H-22			
BFD170S01B	ASG	SCA 170A, 100V, 0.35A, 3.5V	H-22			
BFD170S02B	ASG	SCA 170A, 200V, 0.35A, 3.5V	H-22			
BFD170S03B	ASG	SCA 170A, 300V, 0.35A, 3.5V	H-22			
BFD170S04R	ASG	SCA 170A, 400V, 0.35A, 3.5V	H-22			
BFD170S05B	ASG	SCA 170A, 500V, 0.35A, 3.5V	H-22			
BFD170S07B	ASG	SCA 170A, 700V, 0.35A, 3.5V	H-22			
BFD170S08B	ASG	SCA 170A, 800V, 0.35A, 3.5V	H-22			
BGX11-600TT	APX, MUL	25A, 600V, 0.08A, 1.5V	H-29			 <p>图 H-29</p>
BGX11-800TT	APX, MUL	25A, 800V, 0.08A, 1.5V	H-29			
BGX11-1200C	PHI	25A, 1.2kV, 0.08A, 1.5V	H-29			
BGX11-1200(CTT, TT)	APX, MUL	25A, 1.2kV, 0.08A, 1.5V	H-29			
BGX11-1400CTT	APX, MUL	25A, 1.4kV, 0.08A, 1.5V	H-29			
BGX12-600	RTC	40A, 600V, 0.1A, 2V	H-14			
BGX12-800TT	APX, MUL	40A, 800V, 0.1A, 1.5V	H-29			
BGX12-1200CTT, TT	APX, MUL	40A, 1.2kV, 0.1A, 1.5V	H-29			
BGX12-1400CTT	APX, MUL	40A, 1.4kV, 0.1A, 1.5V	H-29			
BGX13-1200CTT	APX, MUL	50A, 1.2kV, 0.15A, 1.5V	H-29			
BGX13-1400CTT	APX, MUL	50A, 1.4kV, 0.15A, 0.5V	H-29			

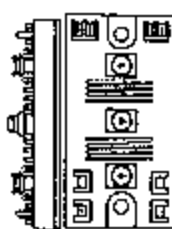
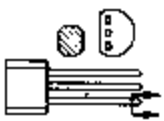

器件型号 Element type	厂名 Manufacturers	材料用途参数 Material Purpose Parameter	图号 Figure	国内外相似替换器件型号 Replace of similar type	备注 Notes	外形参考图 Reference shape
BGX13-600TT	APX, MUL	50A, 600V, 0.15A, 1.5V	H-29			 图 H-29
BGX13-800TT	APX, MUL	50A, 800V, 0.15A, 1.5V	H-29			
BGX14-1200CTT, TT	APX, MUL	55A, 1.2kV, 0.15A, 1.5V	H-29			
BGX14-1400CTT	APX, MUL	55A, 1.4kV, 0.15A, 1.5V	H-29			 图 H-29
BGX14-600TT	APX, MUL	55A, 600V, 0.15A, 1.5V	H-29			
BGX14-800TT	APX, MUL	55A, 800V, 0.15A, 1.5V	H-29			
BGX15-600TT	APX, MUL	65A, 600V, 0.15A, 1.5V	H-29			 图 H-29
BGX15-800TT	APX, MUL	65A, 800V, 0.15A, 1.5V	H-29			
BGX15-1200CTT, TT	APX, MUL	65A, 1.2kV, 0.15A, 1.5V	H-29			
BGX15-1400CTT	APX, PHI	65A, 1.4kV, 0.15A, 1.5V	H-29			 图 B-52
BGX17-600TT	APX, MUL	90A, 600V, 0.15A, 1.5V	H-29			
BGX17-800TT	APX, MUL	90A, 800V, 0.15A, 1.5V	H-29			
BGX17-1200CTT	APX, MUL	90A, 1.2kV, 0.15A, 1.5V	H-29			 图 B-62
BR100	NAS	DAC, 3V, 28V, 6V	A-3	ECC6408		
BR101	MEH, PHI	SCS 0.175A, 50V	B-52	BRY39, BRY62		
BR103(X)			B-35	DRX44...49, TAG60A...Y, TAG62A...Y		 图 B-98
BR203		SCR-H 0.8A, 30V, 0.0002A, 0.002A	B-62	TAG64A...Y, TAG103X		
BR303		SCR-H 1A, 30V, 0.002A, 0.005A	B-81	BR403, TAG66A...Y		
BR403		SCR-H 1A, 30V, 0.002A, 0.005A	B-98	BR303, TAG66A...Y		
BRT170S01...06	ASG	SCA 170A, 0.15A, 3.5V	H-22			 图 H-22
BRT170S07	ASG	SCA 170A, 700V, 0.15A, 3.5V	H-22			
BRT170S08	ASG	SCA 170A, 800V, 0.15A, 3.5V	H-22			
BRT170S09	ASG	SCA 170A, 600V, 0.15A, 3.5V	H-22			

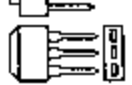
器件型号 Element type	厂名 Manufacturers	材料用途参数 Material Purpose Parameter	图号 Figure	国内外相似替换器件型号 Heplace of similar type	备注 Notes	外形参考图 Reference shape
BRT170S10	ASG	SCA 170A, 600V, 0.15A, 3.5V	H-22			 图 H-22
BRT170S11	ASG	SCA 170A, 1.1kV, 0.15A, 3.5V	H-22			
DRT170S12	ASG	SCA 170A, 600V, 0.15A, 3.5V	H-22			
BRT170S13	ASG	SCA 170A, 1.3kV, 0.15A, 3.5V	H-22			
BRT170S14	ASG	SCA 170A, 1.4kV, 0.15A, 3.5V	H-22			
BRT170S15	ASG	SCA 170A, 600V, 0.15A, 3.5V	H-22			
BRX44, PH	CEN, VAL	SCR-H 0.8A, 30V, 200 μ A, 0.9V	B-45	BRX50...56, BRY55S-30...800, ECG5400		 图 B-45
BRX45, PH	CEN, VAL	SCR-H 0.8A, 60V, 200 μ A, 0.9V	B-45	BRX51...56, BRY55S-60...800, ECG5401		
BRX46, PH	CEN, VAL	SCR-H 0.8A, 100V, 200 μ A, 0.9V	B-45	BRX51...56, BRY55S-100...800, ECG5402		
BRX47, PH	CEN, VAL	SCR-H 0.8A, 200V, 200 μ A, 0.9V	B-45	BRX52...56, BRY55S-200...800, ECG5404		
BRX48, PH	CEN, VAL	SCR-H 0.8A, 300V, 200 μ A, 0.9V	B-45	BRX53...56, BRY55S-300...800, ECG5405		
BRX49, PH	CEN, VAL	SCR-H 0.8A, 400V, 200 μ A, 0.9V	B-45	BRX54...56, BRY55S-400...800, ECG5405		
BRX50	SCR H	SCR H 0.6A, 50V, 0.0002A, 0.005A	B 35	BRX45...49, BRY55S 60...800		
BRX51	SCR-H	SCR-H 0.6A, 100V, 0.0002A, 0.005A	B-35	BRX46...49, BRY55S-100...800		
BRX52	SCR-H	SCR-H 0.6A, 200V, 0.0002A, 0.005A	B-35	BRX47...49, BRY55S-200...800		
BRX53	SCR-H	SCR-H 0.6A, 300V, 0.0002A, 0.005A	B-35	BRX48, BRX49, BRY55S-300...800		
BRX54	SCR-H	SCR-H 0.6A, 400V, 0.0002A, 0.005A	B-35	BRX49, BRY55S-400...800		
BRX55	SCR-H	SCR-H 0.6A, 500V, 0.0002A, 0.005A	B-35	BRY55S-500...800		
BRX56	SCR-H	SCR-H 0.6A, 600V, 0.0002A, 0.005A	B-35	BRY55S-600, BRY55S-700, BRY55S-800		
BRX60	SCR-H	SCR-H 2.6A, 50V, 0.0002A, 0.005A	B-81	BR303, TAG66A...F		
BRX61	SCR-H	SCR-H 2.6A, 100V, 0.0002A, 0.005A	B-81	TAG66A		
BRX62	SCR-H	SCR-H 2.6A, 200V, 0.0002A, 0.005A	B-81			
BRX63	SCR-H	SCR-H 2.6A, 300V, 0.0002A, 0.005A	B-81			
BRX64	SCR-H	SCR-H 2.6A, 400V, 0.0002A, 0.005A	B-81			
BRX65	SCR-H	SCR-H 2.6A, 500V, 0.0002A, 0.005A	B-81			
BRX66	SCR-H	SCR-H 2.6A, 600V, 0.0002A, 0.005A	B-81			

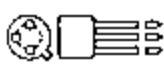
器件型号 Element type	厂名 Manufacturers	材料用途参数 Material Purpose Parameter	图号 Figure	国内外相似替换器件型号 Replace of similar type	备注 Notes	外形参考图 Reference shape
BRX70-03...-50		50Hz-Thy 0.5A, 30-500V, 0.0002A	B-35	BRX45...56, BRY55...		
BRX71-03...-50		50Hz-Thy 0.5A, 30-500V, 0.0002A	B-35	BRX45...56, BRY55...		
BRX72-03...-50		50Hz-Thy 0.6A, 30-500V, 0.0002A	B-97	BRX45...56, BRY55...		
BRX73-03...-50		50Hz-Thy 0.6A, 30-500V, 0.0002A	B-97	BRX45...56, BRY55...		
BRX78-03...-50		Triac 0.8A, 30-500V, 0.01A	B-35	MAC94... , MAC95... , Z106...		
BRX79-03...-50		Triac 0.8A, 30-500V, 0.01A	B-97	MAC94... , MAC95... , Z106...		
BRY20	SIE	SCS 0.3A, 40V, 300 μA, 0.7V	B-49			
BRY21		SCR-GC =BRY20; 80V	B-49			
BRY23		SCR-H 2.2A, 100V, 0.0002A, 0.0025A	B-62			
BRY24		SCR-H 2.2A, 200V, 0.0002A, 0.0025A	B-62			
BRY25		SCR-H 2.2A, 300V, 0.0002A, 0.0025A	B-62			
BRY26		SCR-H 2.2A, 400V, 0.0002A, 0.0025A	B-62			
BRY28		SCR H 2.2A, 100V, 0.015A, 0.025A	B-62	TAG2.5S-100		
BRY29		SCR-H 2.2A, 200V, 0.015A, 0.025A	B-62	TAG2.5S-200		
BRY30		SCR-H 2.2A, 300V, 0.015A, 0.025A	B-62	TAG2.5S-300		
BRY31		SCR-H 2.2A, 400V, 0.015A, 0.025A	B-62	TAG2.5S-400		
BRY32		SCR-H 1A, 50V, 0.0005A, 0.002A	B-62	BRX50...56		
BRY33		SCR-H 1A, 100V, 0.0005A, 0.002A	B-62	BRX51, BRX52, BRX53, BRX54, BRX55, BRX56		
BRY34		SCR-H 1A, 200V, 0.0005A, 0.002A	B-62	BRX52, BRX53, BRX54, BRX55, BRX56		
BRY35		SCR-H 1A, 100V, 0.0001A, 0.001A	B-62			
BRY36		SCR-H 1A, 200V, 0.0001A, 0.001A	B-62			
BRY37		SCR-H 1A, 300V, 0.0001A, 0.001A	B-62			
BRY39(P, S, T)		0.25A, 70V, 10 μs, 100V	B-49	BRY21		
BRY41-50...-600	Triac	1A, 50-600V, 0.025A, 0.025A	B-62	T2303A...M, T2306A...M		

器件型号 Element type	厂名 Manufacturers	材料用途参数 Material Purpose Parameter	图号 Figure	国内外相似替换器件型号 Replace of similar type	备注 Notes	外形参考图 Reference shape
BRY42		50Hz-Thy 3A, 250V, 0.025A, 0.025A				
BRY43		50Hz-Thy 3A, 400V, 0.025A, 0.025A				
BRY44		50Hz-Thy 3A, 500V, 0.025A, 0.025A				
BRY45-50...-600		Triac 3A, 50-600V, 0.05A, 0.05A	B-62			
BRY46		Tetrode 0.05A, 15-20V	B-109	BR101, BRY39, MAS32, MAS39		
BRY49		Tetrode 0.3A, 30V	B-49	BHY20, BHY21, BHY39		
BRY50		Tetrode 0.3A, 70V	B-49	BRY21, BRY30		
BRY51		Tetrode 0.3A, 120V	B-49			
BRY52-50...-600		Triac 6A, 50-600V, 0.05A, 0.05A	B-62	BT158-..., T2806B...M, T2586A...M		
BRY54-100T	THE	50Hz-Thy 1.6A, 100V, 0.02A, 1.5V	B-51	ECG5408, TAG2.5-100, TAG611-100		
BRY54-200T	THE	50Hz-Thy 1.6A, 200V, 0.02A, 1.5V	B-51	TAG2.5-200, TAG611-200		
BRY54-300T		50Hz THY 2.5A, 300V, 0.02A, 0.025A	B-62	TAG2.5-300, TAG611-300		
BRY54-400T	THE	50Hz-Thy 1.6A, 400V, 0.02A, 1.5V	B-51	TAG2.5-400, TAG611-400		
BRY54-600T	THE	50Hz-Thy 1.6A, 600V, 0.02A, 1.5V	B-51	TAG2.5-500, TAG611-500		
BRY55-30	THE	0.8A, 30V, 500μA, 0.8V	B-45	BRX44, ECG5400, SK3950, SK5400		
BRY55-60	THE	0.8A, 60V, 500μA, 0.8V	B-45	BRX45, ECG5401, SK3638, SK5402		
BRY55-100	THE	0.8A, 100V, 500μA, 0.8V	B-45	BRX46, ECG5402, SK3638, SK5402		
BRY55-200	THE	0.8A, 200V, 500μA, 0.8V	B-45	BRX47, ECG5404, SK3627, SK5404		
BRY55-300	THE	0.8A, 300V, 500μA, 0.8V	B-45	BRX48, ECG5405, SK3951, SK5405		
BRY55-400	THE	0.8A, 400V, 500μA, 0.8V	B-45	BRX49		
BRY55-600		0.8A, 600V	B-45			
BRY55-30...-800(M)		0.8A, 30-800V, 0.0002A, 0.005A	B-35	BRY58-..., TAG70D...S, TAG72D...S		
BRY55 30S...-800S	SCR-H	-BRY55/(...)(M): 6μs	B-35			
BRY56	MEH, MUL	PUT 2.5A, 70V, 10μA, 1kV	B-36			
BRY56A, B, C	VAL	PUT 0.175A, 70V	B-5			
BRY58-30...-800		=BRY55-...	B-62	BRY55-...		







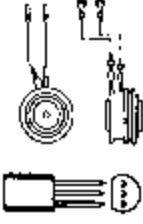

器件型号 Element type	厂名 Manufacturers	材料用途参数 Material Purpose Parameter	图号 Figure	国内外相似替换器件型号 Replace of similar type	备注 Notes	外形参考图 Reference shape
BRY59A...B		0.43A, 30-60V, 0.0001A	B-35	TAG06A...YY, TIC44...47, TIC60...64		
BRY61	VAL	PUT 0.25A, 70V	C-48			
BRY62		Tetrode Terode-SMD, 0.175A, 70V				
BRY70-200...-800		0.5A, 200-800V, 0.01A	B-47			
BRY71-200...-800		0.5A, 200-800V, 0.0002A	B-47	BRY55..., TAG70..., TAG72...		
BS3-04cm1	BBC	4A, 400V, 0.025A, 2V	B-89			
BS3-06cm1	BBC	4A, 600V, 0.025A, 2V	B-89			
BS5-04em1	BBC	5A, 400V, 0.025A, 2.5V	B-91			
BS5-06em1	BBC	5A, 600V, 0.025A, 2.5V	B-91			
BS5-08em1	BBC	5A, 800V, 0.025A, 2.5V	B-91			
BS5-08fm5	BBC	8A, 800V, 0.025A, 2.5V	B-91			
BS6-01A...07A		6A, 100A700V, 0.05A	F-55	BS8...A, BS10...A, TW6N...C, TW8N...C		
RS6-01B...07B		Triac =BS6...A	D-14	BS8...B, BS10...B, TW6N...H, TW8N...H		
BS7-02A...06A		6A, 200-600V, 0.06A	B-11	MAC216..., SC141..., T2801...		
BS7-08fm1	BBC	6A, 800V, 0.025A, 2.5V	B-91			
BS08A	MIT	SBS, 1A, 9V, 10μA, 1kV	B-36			
BS8-01A...07A		8A, 100-700V, 0.05A	F-55	BS10...A, TW8N...C, TW10M...C, TW12N...C		
BS8-01B...07B		8A, 100-700V, 0.05A	D-14	BS10...B, TW8N...H, TW10M...H, TW12N...H		
BS9-04hr1	BBC	8A, 400V, 0.05A, 2.5V	B-91			
BS9-06hr1	BBC	8A, 600V, 0.05A, 2.5V	B-91			
BS9-08fm5	BBC	8A, 800V, 0.025A, 2.5V	B-91			
BS9-08hr1	BBC	8A, 800V, 0.05A, 2.5V	B-91			
BS9-02A...06A		8A, 200-600V, 0.06A	B-11	MAC222..., T2802..., TIC226...		
BS10-01A...07A		10A, 100-700V, 0.05A	F-55	TW10N...C, TW12N...C, TW18N..., TW25N...		
BS10-01B...07B		10A, 100-700V, 0.05A	D-14	TW10N...H, TW12N...H, T6401...		

图 B-36

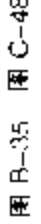
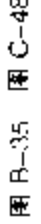
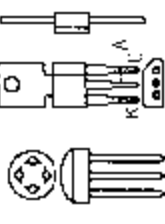
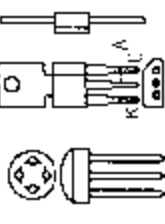
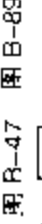
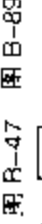
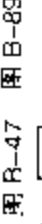
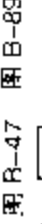
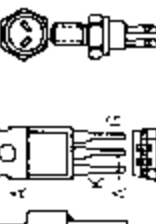
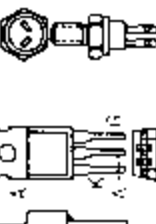
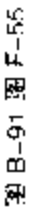
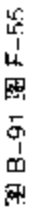
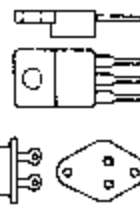
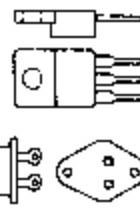
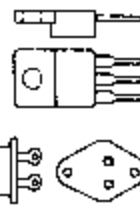
器件型号 Element type	厂名 Manufacturers	材料用途参数 Material Purpose Parameter	图号 Figure	国内外相似替换器件型号 Replace of similar type	备注 Notes	外形参考图 Reference shape
BS12-04hu1	BBC	12A, 400V, 75A, 2.5	B-91			 图 B-91
BS12-04hu5	BBC	12A, 400V, 75A, 2.5	B-91			
BS12-06hu1	BBC	12A, 600V, 75A, 2.5V	B-91			
BS12-06hu5	BBC	12A, 600V, 75A, 2.5V	B-91			
BS12-08hu1	BBC	12A, 800V, 0.075A, 2.5V	B-91			
BS12-08hu5	BBC	12A, 800V, 0.075A, 2.5V	B-91			
BS16-04hu1	BBC	16A, 400V, 0.075A, 2.5V	B-91			 图 B-108
BS16-06hu1	BBC	16A, 600V, 0.075A, 2.5V	B-91			
BS16-08hu1	BBC	16A, 800V, 0.075A, 2.5V	B-91			
BSIA3026		50Hz-Thy 0.6A, 400V, 0.01A, 0.04A	B-108	BSIA3026M, CS0.8-04, CS1.2-04		
BSIA3026M		50Hz-Thy 0.8A, 400V, 0.01A, 0.04A	B-108	CS08-04, CS1.2-04, TAG612-400, TAG606-400		
BSIA3033		50Hz Thy 0.6A, 500V, 0.01A, 0.04A	B-108	BSIA3033M, CS0.8-05, CS1.2-05		
BSIA3033M		50Hz-Thy 0.8A, 500V, 0.01A, 0.04A	B-108	CS08-05, CS1.2-05, TAG612-600, TAG606-600		
BSIA3040		50Hz-Thy 0.6A, 600V, 0.01A, 0.04A	B-108	BSIA3040M, CS0.8-06, CS1.2-06		
BSIA3040M		50Hz-Thy 0.8A, 600V, 0.01A, 0.04A	B-108	CS08-06, CS1.2-06, TAG612-600, TAG606-600		
BSIA3046		50Hz-Thy 0.6A, 700V, 0.01A, 0.04A	B-108	BSIA3046M, CS0.8-07, CS1.2-07		
BSIA3046M		50Hz-Thy 0.8A, 700V, 0.01A, 0.04A	B-108	CS08-07, CS1.2-07, TAG612-700, TAG606-700		
BSIA3053		50Hz-Thy 0.6A, 800V, 0.01A, 0.04A	B-108	BSIA3053M, TAG6123-800, TAG606-800		
BSIA3053M		50Hz-Thy 0.8A, 800V, 0.01A, 0.04A	B-108	TAG612-800, TAG606-800		
BSIB0106		50Hz-Thy 0.8A, 100V, 0.01A, 0.06A	B-108	BSIA3026M, CS0.8-02, CS1.2-02		
BSIB0113		50Hz-Thy 0.8A, 200V, 0.01A, 0.06A	B-108	BSIA3026M, CS0.8-02, CS1.2-02		
BSIB0126		50Hz-Thy 0.8A, 400V, 0.01A, 0.06A	B-108	BSIA3026M, CS0.8-04, CS1.2-04		
BSIB0133		50Hz-Thy 0.8A, 500V, 0.01A, 0.06A	B-108	BSIA3033M, CS0.8-05, CS1.2-05		
BSIB0140		50Hz-Thy 0.8A, 600V, 0.01A, 0.06A	B-108	BSIA3040M, CS0.8-06, CS1.2-06		
BSIB0146		50Hz-Thy 0.8A, 700V, 0.01A, 0.06A	B-108	BSIA3046M, CS0.8-07, CS1.2-07		



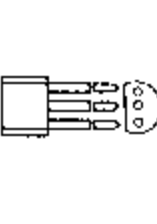
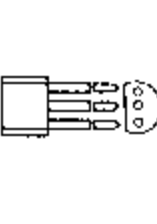
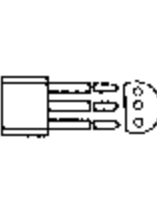
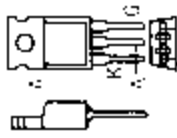









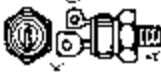













器件型号 Element type	厂名 Manufacturers	材料用途参数 Material Purpose Parameter	图号 Figure	国内外相似替换器件型号 Replace of similar type	备注 Notes	外形参考图 Reference shape
BSIB0206		50Hz-Thy 3A, 100V, 0.01A, 0.06A		TAG621-100, TAG626-100, T3.5N400		
BSIB0213		50Hz-Thy 3A, 200V, 0.01A, 0.06A		TAG621-200, TAG626-200, T3.5N400		
BSIB0226		50Hz-Thy 3A, 400V, 0.01A, 0.06A		TAG621-400, TAG626-400, T3.5N400		
BSIB0233		50Hz-Thy 3A, 500V, 0.01A, 0.06A		TAG621-500, TAG626-500, T3.5N600		
BSIB0240		50Hz-Thy 3A, 600V, 0.01A, 0.06A		TAG621-600, TAG626-600, T3.5N600		
BSIB0246		50Hz-Thy 3A, 700V, 0.01A, 0.06A		TAG621-700, TAG626-700, T3.5N800		
BSIC0106		50Hz-Thy 5A, 100V, 0.035A, 0.09A	F-55	BSIC0313, BSID0313, CS5-02, CS8-02		
BSIC0113		50Hz-Thy 5A, 200V, 0.035A, 0.09A	F-55	BSIC0313, BSID0313, CS5-02, CS8-02		
BSIC0126		50Hz-Thy 5A, 400V, 0.035A, 0.09A	F-55	BSIC0326, BSID0326, CS5-04, CS8-04		
BSIC0133		50Hz-Thy 5A, 500V, 0.035A, 0.09A	F-55	BSIC0340, BSID0340, CS5-06, CS8-06		
BSIC0140		50Hz-Thy 5A, 600V, 0.035A, 0.09A	F-55	BSIC0340, BSID0340, CS5-06, CS8-06		
BSIC0146		50Hz-Thy 5A, 700V, 0.035A, 0.09A	F-55	BSIC0353, BSID0353, CS5-08, CS8-08		
BSIC0206		50Hz-Thy 3.5A, 100V, 0.02A, 0.06A		BSIC1026, TAG620-100, TAG625-100		
BSIC0213		50Hz-Thy 3.5A, 200V, 0.02A, 0.06A		BSIC1026, TAG620-200, TAG625-200		
BSIC0226		50Hz-Thy 3.5A, 400V, 0.02A, 0.06A		BSIC1026, TAG620-400, TAG625-400		
BSIC0233		50Hz-Thy 3.5A, 500V, 0.02A, 0.06A		BSIC1033, TAG620-500, TAG625-500		
BSIC0240		50Hz-Thy 3.5A, 600V, 0.02A, 0.06A		BSIC1040, TAG620 600, TAG625 600		
BSIC0246	SIE	50Hz-Thy 3.5A, 700V, 0.02A, 2V	B-31	BSIC1046, TAG620-700, TAG625-700		
BSIC0313	SIE	50Hz-Thy 11.4A, 200V, 0.04A, 0.03A	F-55	BSID0313, CS5-02, CS8-02		
BSIC0313S6	SIE	11A, 200V, 0.03A, 2.5V	F-47			
BSIC0326	SIE	50Hz-Thy 11.4A, 400V, 0.04A, 0.03A	F-55	BSID0326, CS5-04, CS8-04		
BSIC0326S6	SIE	11.4A, 400V, 0.03A, 2.5V	F-47			
BSIC0340	SIF	50Hz-Thy 11.4A, 600V, 0.04A, 0.03A	F-55	BSID0340, CS5-06, CS8-06		
BSIC0340S6	SIF	11.4A, 600V, 0.03A, 2.5V	F-47			
BSIC0353	SIE	50Hz-Thy 11.4A, 800V, 0.04A, 0.03A	F-55	BSID0353, CS5-08, CS8-08		
BSIC0353S6	SIE	11.4A, 800V, 0.03A, 2.5V	F-47			
BSIC0366		50Hz-Thy 11.4A, 1kV, 0.04A, 0.03A	F-55	BSID0366, CS5-10, CS8-10		

图 F-55



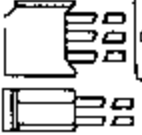
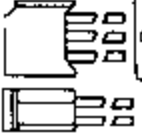
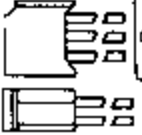

图 B-31



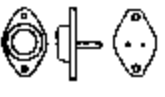
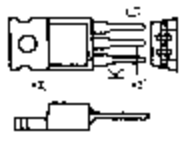
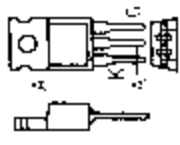
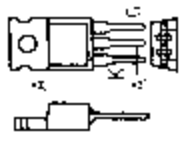
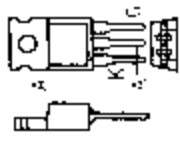
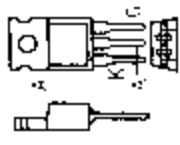
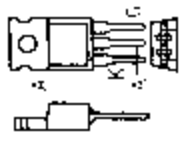
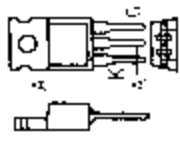
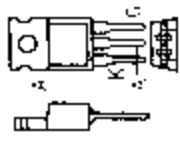
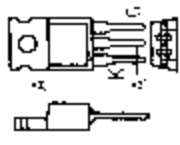
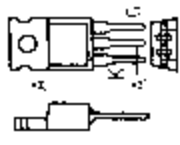
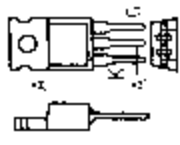

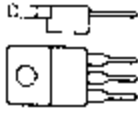

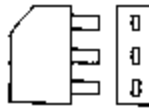
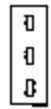
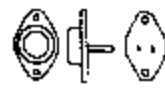



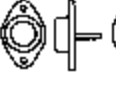





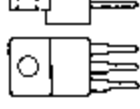
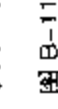
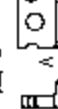
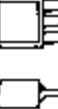
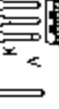
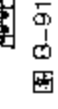

图 F-47



器件型号 Element type	厂名 Manufacturers	材料用途参数 Material Purpose Parameter	图号 Figure	国内外相似替换器件型号 Replace of similar type	备注 Notes	外形参考图 Reference shape
BSiC0366S6	SIF	11.4A, 1kV, 0.03A, 2.5V	F-47	BSiD0380, CS5-12, CS8-12		
BSiC0380		50Hz-Thy 11.4A, 1.2kV, 0.04A, 0.03A	F-55			
BSiC0380S6	SIE	11.4A, 1.2kV, 0.03A, 2.5V	F-47			
BSiC0506		50Hz-Thy 5A, 100V, 0.02A, 0.06A	D-9	TAG671-100, TAG676 100		
BSiC0513		50Hz-Thy 5A, 200V, 0.02A, 0.06A	D-9	TAG671-200, TAG676-200		
BSiC0526		50Hz-Thy 5A, 400V, 0.02A, 0.06A	D-9	TAG671-400, TAG676-400		
BSiC0533		50Hz-Thy 5A, 500V, 0.02A, 0.06A	D-9	TAG671-500, TAG676-500		
BSiC0540		50Hz-Thy 5A, 600V, 0.02A, 0.06A	D-9	TAG671-600, TAG676-600		
BSiC0546		50Hz-Thy 5A, 700V, 0.02A, 0.06A	D-9	TAG671-700, TAG676-700		
BSiC0606		SCR-H 3.2A, 100V, 0.05A, 0.1A	D-9	S3700B, T3S400, TAG670S-100, TAG675S-100		
BSiC0613		SCR-H 3.2A, 200V, 0.05A, 0.1A	D-9	S3700B, T3S400, TAG670S-200, TAG675S-200		
BSiC0626		SCR-H 3.2A, 400V, 0.05A, 0.1A	D-9	S3700D, T3S400, TAG670S-400, TAG675S-400		
BSiC0633		SCR-H 3.2A, 500V, 0.05A, 0.1A	D-9	S3700M, T3S500, TAG670S-500, TAG675S-500		
BSiC0640		SCR-H 3.2A, 600V, 0.05A, 0.1A	D-9	S3700M, T3S600, TAG670S-600, TAG675S-600		
BSiC0643		SCR-H 3.2A, 650V, 0.05A, 0.1A	D-9	T3S700, TAG670S-700, TAG675S-700		
BSiC0646		SCR-H 3.2A, 700V, 0.05A, 0.1A	D-9	T3S700, TAG670S-700, TAG675S-700		
BSiC0650		SCR-H 3.2A, 750V, 0.05A, 0.1A	D-9	TAG670S-800, TAG675S-800		
BSiC0653		SCR-H 3.2A, 800V, 0.05A, 0.1A	D-9	TAG670S-800, TAG675S-800		
BSiC0706		50Hz-Thy 0.9A, 100V, 0.02A, 0.06A	B-108	BSiC3026, TAG2.5-100, TAG611-100		
BSiC0713		50Hz-Thy 0.9A, 200V, 0.02A, 0.06A	B-108	BSiC3026, TAG2.5-200, TAG611-200		
BSiC0726		50Hz-Thy 0.9A, 400V, 0.02A, 0.06A	B-108	BSiC3026, TAG2.5-400, TAG611-400		
BSiC0726T	SIE	0.9A, 400V, 0.035A, 2V	B-30	BSiC3033, TAG2.5-500, TAG611-500		
BSiC0733		50Hz-Thy 0.9A, 400V, 0.02A, 2V	B-30	BSiC3033, TAG2.5-500, TAG611-500		
BSiC0733T	SIE	0.9A, 500V, 0.035A, 2V	B-30	BSiC3040, TAG2.5-600, TAG611-600		
BSiC0740		50Hz-Thy 0.9A, 600V, 0.02A, 0.06A	B-108	BSiC3040, TAG2.5-600, TAG611-600		
BSiC0746		50Hz-Thy 0.9A, 700V, 0.02A, 0.06A	B-108	BSiC3046, TAG2.5-700, TAG611-700		





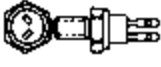

器件型号 Element type	厂名 Manufacturers	材料用途参数 Material Purpose Parameter	图号 Figure	国内外相似替换器件型号 Replace of similar type	备注 Notes	外形参考图 Reference shape
BSIC0926T92		SCR-H 400V, 0.05A	D-9			 图 D-9
BSIC0930T92		SCR-H 450V, 0.05A	D-9			
BSIC1026	SIE	50Hz-Thy 4A, 400V, 0.025A, 0.08A	B-91	C122D, CS6-04, TAG625-400, TIC116D		 图 B-11
BSIC1026M	SIE	50Hz-Thy 6A, 400V, 0.025A, 2V	B-91	CS6-04, CS3.5-04, S2800D, TAG660-400		
BSIC1033		50Hz-Thy 4A, 500V, 0.025A, 0.08A	B-11	C122E, CS6-06, TIC116E, TAG625-500		 图 B-11
BSIC1033M	SIE	50Hz-Thy 6A, 500V, 0.025A, 2V	B-91	CS6-06, CS3.5-04, S2800E, TAG660-500		
BSIC1040		50Hz-Thy 4A, 600V, 0.025A, 0.08A	B-11	C122M, CS6-06, TAG625-600, TIC116M		 图 B-11
BSIC1040B	SIE	4A, 600V, 0.005A, 2V	B-91			
BSIC1040C	SIE	4A, 600V, 0.01A, 2V	B-91			 图 B-11
BSIC1040M	SIE	6A, 600V, 0.025A, 0.08A	B-91	CS6-06, CS3.5-06, S2800M, TAG660-600		
BSIC1040MB	SIE	6A, 600V, 0.005A, 2V	B-91			 图 B-11
BSIC1040MC	SIE	6A, 600V, 0.01A, 2V	B-91			
BSIC1040MS1	SIE	6A, 600V, 0.003A, 2V	B-91			 图 B-11
BSIC1040S1	SIE	4A, 600V, 0.003A, 2V	B-91			
BSIC1046	SIE	50Hz-Thy 4A, 700V, 0.025A, 0.08A	B-91	BSIC1046M, CS6-07, TAG625-700, TIC116S		 图 B-11
BSIC1046B	SIE	4A, 700V, 0.005A, 2V	B-91			
BSIC1046C	SIE	4A, 700V, 0.01A, 2V	B-91			 图 B-11
BSIC1046M	SIE	6A, 700V, 0.025A, 0.08A	B-91	CS6-07, CS3.5-07, S2800S, TAG660-700		
BSIC1046MB	SIE	6A, 700V, 0.005A, 2V	B-91			 图 B-11
BSIC1046MC	SIF	6A, 700V, 0.01A, 2V	B-91			
BSIC1046MS1	SIE	6A, 700V, 0.003A, 2V	B-91			 图 B-11
BSIC1046S1	SIE	4A, 700V, 0.003A, 2V	B-91			
BSIC1053		50Hz-Thy 4A, 800V, 0.025A, 0.08A	B-91	BSC1053M, CS6-08, TAG625-800, TIC116N		 图 B-11
BSIC1053M		50Hz-Thy 6A, 800V, 0.025A, 0.08A	B-91	CS6-08, S2800N, TAG660-800, 2N6399		



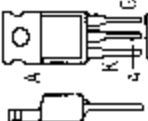
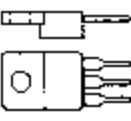

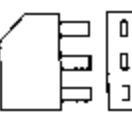
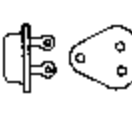



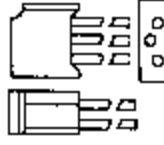

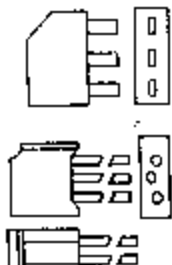

器件型号 Element type	厂名 Manufacturers	材料用途参数 Material Purpose Parameter	图号 Figure	国内外相似替换器件型号 Replace of similar type	备注 Notes	外形参考图 Reference shape
BSIC1226		SCR-H 2.5A, 400V, 0.05A, 0.1A	B-11	BSIC0233H, BT153, CSF11-04, CSF0.7-04, S5800D, S3900E, 17088		
BSIC1233		SCR-H 2.5A, 500V, 0.05A, 0.1A	B-11	BSIC0233H, RT153, CSF11-06, S3900E, S5800E, 17088		
BSIC1240	SIE	SCR-H 2.5A, 600V, 0.05A, 2V	B-91	BSIC0240H, CSF11-06, S3900MF, S5800M, 17088		
BSIC1246	SIE	SCR-H 2.5A, 700V, 0.05A, 2V	B-91	BSIC0246H, CSF11-08, S3900S, S5800S, 17088		
BSIC1250		SCR-H 2.5A, 750V, 0.05A, 0.1A	B-11	BSIC0253H, CSF11-08, S3900SF, S5800N, 17088		
BSIC1253		SCR-H 2.5A, 800V, 0.05A, 0.1A	B-11	BSIC0253H, CSF11-08, S5800N, 17088		
BSIC3026		50Hz-Thy 1A, 400V, 0.025A, 0.08A	B-108	TAG2.5-400, TAG605-400, TAG611-400		
BSIC3033		50Hz-Thy 1A, 500V, 0.025A, 0.08A	B-108	TAG2.5-500, TAG605-600, TAG611-600		
BSIC3040		50Hz-Thy 1A, 600V, 0.025A, 0.08A	B-108	TAG2.5-600, TAG605-600, TAG611-600		
BSIC3046		50Hz-Thy 1A, 700V, 0.025A, 0.08A	B-108	TAG2.5-700, TAG605-700, TAG611-700		
BSIC3053		50Hz-Thy 1A, 800V, 0.025A, 0.08A	B-108	TAG2.5-800, TAG605-800, TAG611-800		
BSIC3126		50Hz-Thy 1.5A, 400V, 0.025A, 0.08A		BSIC3126M, TAG620-400, TAG630-400		
BSIC3126M		50Hz-Thy 2.5A, 400V, 0.025A, 0.08A		BSIC1026, TAG620-400, TAG630-400		
BSIC3133		50Hz-Thy 1.5A, 500V, 0.025A, 0.08A		BSIC3133M, TAG620-500, TAG630-500		
BSIC3133M		50Hz-Thy 2.5A, 500V, 0.025A, 0.08A		BSIC1033, TAG620-500, TAG630-500		
BSIC3140		50Hz-Thy 1.5A, 600V, 0.025A, 0.08A		BSIC3140M, TAG620-600, TAG630-600		
BSIC3140M		50Hz-Thy 2.5A, 600V, 0.025A, 0.08A		BSIC1040, TAG620-600, TAG630-600		
BSIC3146		50Hz-Thy 1.5A, 700V, 0.025A, 0.08A		BSIC3146M, TAG620-700, TAG630-700		
BSIC3146M		50Hz-Thy 2.5A, 700V, 0.025A, 0.08A		BSIC1046, TAG620-700, TAG630-700		
BSIC3153		50Hz-Thy 1.5A, 800V, 0.025A, 0.08A		BSIC3153M, TAG620-800, TAG630-800		
BSIC3153M		50Hz-Thy 2.5A, 800V, 0.025A, 0.08A		BSIC1053, TAG620-800, TAG630-800		
BSIC00126H		TV-HA, 3.2A, 400V, 0.05A, 0.1A D-9		S6087B, TD3F400H, TD4F400H		
BSIC00126R		TV-HA, 3.2A, 400V, 0.05A, 0.1A D-9		S6087A, TD3F400R, TD4F400R		
BSIC00133H		TV HA, 3.2A, 500V, 0.05A, 0.1A D-9		S6087B, TD3F500H, TD4F500H		

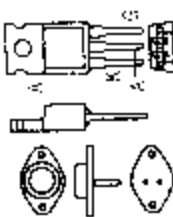
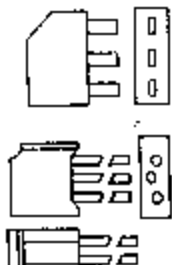
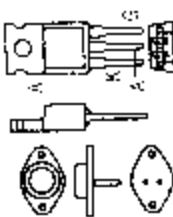
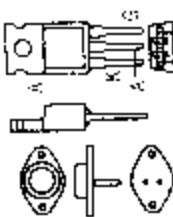
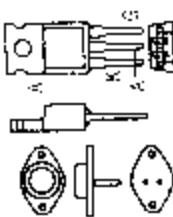
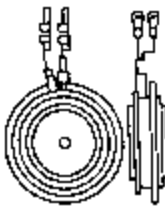
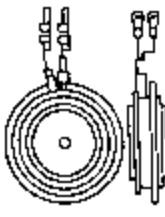
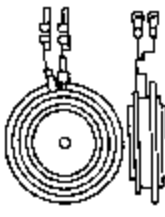
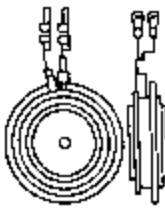
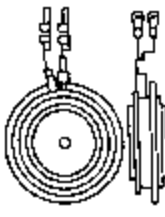
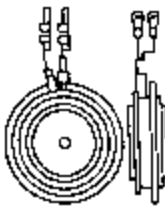
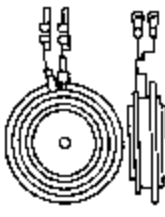
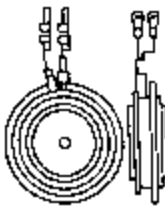
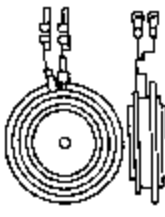
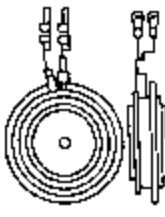









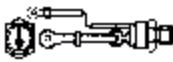

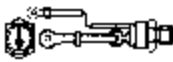

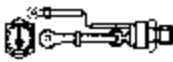











器件型号 Element type	厂名 Manufacturers	材料用途参数 Material Purpose Parameter	图号 Figure	国内外相似替换器件型号 Replace of similar type	备注 Notes	外形参考图 Reference shape
BS1CC0133R		TV-HA, 3.2A, 500V, 0.05A, 0.1A D-9	D-9	S6087A, TD3F500R, TD4F500R		
BS1CC0140H		TV-HA, 3.2A, 600V, 0.05A, 0.1A D-9	D-9	S6087B, TD3F600H, TD4F600H		
BS1CC0140R		TV-HA, 3.2A, 600V, 0.05A, 0.1A D-9	D-9	S6087A, TD3F600R, TD4F600R		
BS1CC0146H		TV-HA, 3.2A, 700V, 0.05A, 0.1A D-9	D-9	S6087B, TD3F700H, TD4F700H		
BS1CC0146R		TV-HA, 3.2A, 700V, 0.05A, 0.1A D-9	D-9	S6087A, TD3F700R, TD4F700R		
BS1CC0153H		TV-HA, 3.2A, 800V, 0.05A, 0.1A D-9	D-9	TD3F800H, TD4F800H		
BS1CC0153R		TV-HA, 3.2A, 800V, 0.05A, 0.1A D-9	D-9	TD3F800R, TD4F800R		
BS1CC0233H		TV-HA, 5A, 500V, 0.05A, 0.1A B-11	B-11	S3900E, 17088		
BS1CC0233R		TV-HA, 5A, 500V, 0.05A, 0.1A B-11	B-11	S3901E, 17089		
BS1CC0240H	SIE	RCT-TV/HA, 5A, 600V, 0.05A B-11	B-11	S3900M, 17088		
BS1CC0240R	SIE	RCT-TV/HA, 5A, 600V, 0.05A B-11	B-11	S3901M, 17089		
BS1CC0246H	SIE	RCT-TV/HA, 5A, 700V, 0.05A B-11	B-11	S3900S, 17088		
BS1CC0246R	SIE	RCT-TV/HA, 5A, 700V, 0.05A B-11	B-11	S3901S, 17089		
BS1CC0253	SIE	RCT-TV/HA, 5A, 800V, 0.05A, B-91 0.003V	B-91			
BS1CC0253H		TV-HA, 5A, 800V, 0.05A, 0.1A B-11	B-11	17088		
BS1CC0253R		TV-HA, 5A, 800V, 0.05A, 0.1A B-11	B-11	17089		
BS1CC0260H		TV-HA, 5A, 900V, 0.05A, 0.1A B-11	B-11	17088		
BS1CC0260R		TV-HA, 5A, 900V, 0.05A, 0.1A B-11	B-11	17089		
BS1D0220		50Hz-Thy 8.5A, 300V, 0.05A, 0.12A	F-55	BTW42-600R		
BS1D0240		50Hz-Thy 8.5A, 600V, 0.05A, 0.12A	F-55	BTW42-600R		
BS1D0260		50Hz-Thy 8.5A, 900V, 0.05A, 0.12A	F-55	BTW42-1000R		
BS1D0313		50Hz-Thy 16A, 200V, 0.03A, 0.08A	F-55	CS8-02		
BS1D0326		50Hz Thy 16A, 400V, 0.03A, 0.08A	F-55	CS8-04		
BS1D0326S6	SIE	16A, 400V, 0.03A, 2.5V	F-47			













器件型号 Element type	厂名 Manufacturers	材料用途参数 Material Purpose Parameter	图号 Figure	国内外相似替换器件型号 Replace of similar type	备注 Notes	外形参考图 Reference shape
BSID03340		50Hz-Thy 16A, 600V, 0.03A, 0.08A	F-55	CS8-06		 图 F-55
BSID03340S6	SIE	16A, 600V, 0.03A, 2.5V	F-47			
BSID03353		50Hz-Thy 16A, 800V, 0.03A, 0.08A	F-55	CS8-08		 图 F-47
BSID03353S6	SIE	16A, 800V, 0.03A, 2.5V	F-47			
BSID03366		50Hz-Thy 16A, 1kV, 0.03A, 0.08A	F-55	CS8-10		 图 B-91
BSID03366S6	SIE	16A, 1kV, 0.03A, 2.5V	F-47			
BSID03380		50Hz-Thy 16A, 1.2kV, 0.03A, 0.08A	F-55	CS8-12		
BSID0380S6	SIE	16A, 1.2kV, 0.03A, 2.5V	F-47			
BSID1026	SIE	50Hz-Thy 8A, 400V, 0.025A, 2V	B-91	BSID1026M, T7.5N500, TAG680-400, TIC126D		
BSID1026M	SIE	50Hz-Thy 10A, 400V, 0.025A, 2V	B-91	CS15-04, T9.5N400		
BSID1033	SIE	50Hz-Thy 8A, 500V, 0.025A	B-91	BSID1033M, T7.5N600, TAG680-500, TIC126E		
BSID1033M	SIE	50Hz-Thy 10A, 500V, 0.025A, 2V	B-91	CS15-06, T9.5N500		
BSID1040	SIE	50Hz-Thy 8A, 600V, 0.025A	B-91	BSID1040M, T7.5N500, TAG680-600, TIC126M		
BSID1040B	SIE	8A, 600V, 0.005A, 2V	B-91			
BSID1040C	SIE	8A, 600V, 0.01A, 2V	B-91			
BSID1040D	SIE	8A, 600V, 0.025A, 2V	B-91			
BSID1040M	SIC	50Hz-Thy 10A, 600V, 0.025A, 2V	B-91	CS15-06, T9.5N600		
BSID1040MB	SIE	10A, 600V, 0.005A, 2V	B-91			
BSID1040MC	SIE	10A, 600V, 0.01A, 2V	B-91			
BSID1040MD	SIE	10A, 600V, 0.025A, 2V	B-91			
BSID1040MS1	SIE	10A, 600V, 0.003A, 2V	B-91			
BSID1040MS2	SIE	10A, 600V, 0.0015A, 2V	B-91			
BSID1040S1	SIE	8A, 600V, 0.003A, 2V	B-91			
BSID1040S2	SIE	8A, 600V, 0.0015A, 2V	B-91			
BSID1046	SIE	50Hz-Thy 8A, 700V, 0.025A	B-91	BSID1046M, T7.5N700, TAG680-700, TIC126S		
BSID1046M	SIE	50Hz-Thy 10A, 700V, 0.3A, 2.5V	B-91	CS15-07, T9.5N700		
BSID1046MC	SIE	10A, 700V, 0.01A, 2V	B-91			

器件型号 Element type	厂名 Manufacturers	材料用途参数 Material Purpose Parameter	图号 Figure	国内外相似替换器件型号 Replace of similar type	备注 Notes	外形参考图 Reference shape
BS1D1046MD	SIE	10A, 700V, 0.025A, 2V	B-91			
BS1D1046S1	SIE	8A, 700V, 0.0015A, 2V	B-91			图 B-91
BS1D1046S2	SIE	8A, 700V, 0.003A, 2V	B-91			
BS1D1053	SIE	50Hz-Thy 8A, 800V, 0.025A, 2V, 0.08A	B-91	BS1D1052M, T7.5N800, TAG680-800, TIC126N		
BS1D1053M	SIE	50Hz-Thy 10A, 800V, 0.025A, 2V, 0.08A	B-91	CS15-08, T9.5N800		
BS1D1666M, N, P	SIE	50Hz-Thy 7.5A, 1kV, 0.01A, 2V	B-91			
BS1D1680M	SIE	50Hz-Thy 7.5A, 1.2kV, 0.01A, 2V	B-91			图 B-11
BS1D1680N	SIE	50Hz-Thy 7.5A, 1kV, 0.02A	B-11			
BS1D1680P	SIE	50Hz-Thy 7.5A, 1.2kV, 0.01A, 2V	B-91			图 B-30
BS1D3666	SIE	1A, 1kV, 0.3A, 12.5V	B-30			
BS1D3666M	SIE	50Hz-Thy 1A, 1kV, 0.01A, 0.05A	B-108	BS1D1666M		
BS1D3666N	SIE	50Hz-Thy 1A, 1kV, 0.02A, 0.08A	B-108	BS1D1666N		
BS1D3666P	SIE	50Hz-Thy 1A, 1kV, 0.05A, 0.15A	B-108	BS1D1666P		
BS1D3680	SIE	1A, 1.2kV, 0.3A, 2.5V	B-30			
BS1D3680M	SIE	50Hz-Thy 1A, 1.2kV, 0.01A, 0.05A	B-108	BS1D1680M		
BS1D3680N	SIE	50Hz-Thy 1A, 1kV, 0.02A, 0.08A	B-108	BS1D1680N		
BS1D3680P	SIE	50Hz-Thy 1A, 1kV, 0.05A, 0.15A	B-108	BS1D1680P		
BS1D4026	SIE	50Hz-Thy 12A, 400V, 0.01A	D-14	BS1D4026M, C232D, S6200D, T10N400H		
BS1D4026M	SIE	50Hz-Thy 15A, 400V, 0.01A	D-14	C232D		
BS1D4033	SIE	50Hz-Thy 12A, 500V, 0.01A	D-14	BS1D4033M, C232E, S6200M, T10N500H		
BS1D4033M	SIE	50Hz-Thy 15A, 500V, 0.01A	D-14	C232M		
BS1D4040	SIE	50Hz-Thy 12A, 600V, 0.01A	D-14	BS1D4040M, C232M, S6200M, T10N600H		
BS1D4040M	SIE	50Hz-Thy 15A, 600V, 0.01A	D-14	C232M		图 D-14

器件型号 Element type	厂名 Manufacturers	材料用途参数 Material Purpose Parameter	图号 Figure	国内外相似替换器件型号 Replace of similar type	备注 Notes	外形参考图 Reference shape
BSID4046		50Hz-Thy 12A, 700V, 0.01A	D-14	BSID4046M, T10N700H		 图 D-14
BSID4046M		50Hz-Thy 15A, 700V, 0.01A	D-14			
BSID4053		50Hz-Thy 12A, 800V, 0.01A	D-14	BSID4053M, T10N800H		
BSID4053M		50Hz-Thy 15A, 800V, 0.01A	D-14			
BSID4126		50Hz-Thy 12A, 400V, 0.01A	F-55	BSID4126M, BSIE4126, S6210D, T10N400C		 图 F-55
BSID4126M		50Hz-Thy 15A, 400V, 0.01A	F-55	BSIE4126, BSIE4126M, C230D		
BID4133		50Hz-Thy 12A, 500V, 0.01A	F-55	BSID4133M, BSIE4133, S6210M, T10N500C		
BSID4133M		50Hz-Thy 15A, 500V, 0.01A	F-55	BSIE4133, BSIE4133M, C230E		
BID4140		50Hz-Thy 12A, 600V, 0.01A	F-55	BSID4140M, BSIE4140, S6210M, T10N600C		
BSID4140M		50Hz-Thy 15A, 600V, 0.01A	F-55	BSIE4140, BSIE4140M, C230M		
BID4146		50Hz-Thy 12A, 700V, 0.01A	F-55	BSID4146M, BSIE4146, BSIE4146M, T10N700C		
BSID4146M		50Hz-Thy 15A, 700V, 0.01A	F-55	BSIE4146, BSIE4146M		
BID4153		50Hz-Thy 12A, 800V, 0.01A	F-55	BSID4153M, BSIE4153, BSIE4153M, T10N800C		
BSID4153M		50Hz-Thy 15A, 800V, 0.01A	F-55	BSIE4153, BSIE4153M		
BSIE0326	SIE	SCR-H 0.6A, 400V, 0.035A, 3V	B-30	BT153, S5800D, TAG650S-400, TAG655S-400		 图 B-30
BSIE0326T81	SIE	215A, 400V, 0.05A, 3V	B-30			
BSIE0326T82	SIE	240A, 400V, 0.05A, 3V	B-30	S5800M, TAG650S-600, TAG655S-600		
BSIE0326T83	SIE	300A, 400V, 0.05A, 3V	B-30	CSF11-08, S5800S		
BSIE0326T84	SIE	240A, 400V, 0.05A, 3V	B-30			
BSIE0326T85	SIE	300A, 400V, 0.05A, 3V	B-30			
BSIE0326T86	SIE	300A, 400V, 0.05A, 3V	B-30			
BSIF0330T81	SIF	215A, 450V, 0.05A, 3V	B-30			
BSIE0330T82	SIE	240A, 450V, 0.05A, 3V	B-30			
BSIE0330T83	SIE	300A, 450V, 0.05A, 3V	B-30			
BSIE0330T84	SIE	240A, 450V, 0.05A, 3V	B-30			
BSIE0330T85	SIE	450V, 0.05A	B-30			

器件型号 Element type	厂名 Manufacturers	材料用途参数 Material Purpose Parameter	图号 Figure	国内外相似替换器型号 Replace of similar type	备注 Notes	外形参考图 Reference shape
BSIE0330T86	SIE	300A, 450V, 0.05A, 3V	B-30	BT153, S5800E, TAG650S-500, TAG655S-500		
BSIE0333	SCR-H	0.6A, 500V, 0.035A, 0.05A	B-108	S5800M, TAG650S-600, TAG655S-600		
BSIE0340	SCR-H	0.6A, 600V, 0.035A, 0.05A	B-108	S5800S, CSF11-08		
BSIE0346	SCR-H	0.6A, 700V, 0.035A, 0.05A	B-108			
BSIE0426	SCR-H	4A, 400V, 0.05A, 0.1A	D-9	T3S400, TAG670S-400, TAG675S-400		
BSIE0430T94	SIE	300A, 450V, 0.05A, 3V	B-30			
BSIE0433	SCR-H	4A, 500V, 0.05A, 0.1A	D-9	T3S500, TAG670S-500, TAG675S-500		
BSIE0440	SCR-H	4A, 600V, 0.05A, 0.1A	D-9	T3S600, TAG670S-600, TAG675S-600		
BSIE0446	SCR-H	4A, 700V, 0.05A, 0.1A	D-9	T3S700, TAG670S-700, TAG675S-700		
BSIE1026	SIE	13A, 400V, 0.04A, 2V	B-91			
BSIE1026M	SIE	16A, 400V, 0.04A, 2V	B-91			
BSIE1040	SIE	13A, 600V, 0.04A, 2V	B-91			
BSIE1040M	SIE	16A, 600V, 0.04A, 2V	B-91			
BSIE1053	SIE	13A, 800V, 0.04A, 2V	B-91			
BSIE1053M	SIE	16A, 800V, 0.04A, 2V	B-91			
BSIE1666	SIE	10A, 1kV, 0.02A, 1.5V	B-91			
BSIE1666M	SIE	13A, 1kV, 0.02A, 1.5V	B-91			
BSIE1666P	SIE	10A, 1kV, 0.05A, 1.5V	B-91			
BSIE1680M	SIE	12A, 1.2kV, 0.02A, 1.5V	B-91			
BSIE1690	SIE	10A, 1.3kV, 0.02A, 1.5V	C-50			
BSIE1690M	SIE	13A, 1.3kV, 0.02A, 1.5V	C-50			
BSIE1690P	SIE	10A, 1.3kV, 0.05A, 1.5V	C-50			
BSIE3540#1	SIE	25A, 600V	F-23			
BSIE3540#2	SIE	25A, 600V	F-64			
BSIE3560#1	SIE	25A, 900V	F-23			
BSIE3560#1	SIE	25A, 900V	F-64			
BSIE3560#1	SIE	25A, 1.2kV	F-23			

器件型号 Element type	厂名 Manufacturers	材料用途参数 Material Purpose Parameter	图号 Figure	国内外相似替换器件型号 Replace of similar type	备注 Notes	外形参考图 Reference shape
BSIE3580#2	SIE	25A, 1.2kV	F-64			
BSIE3590#1	SIE	25A, 1.3kV	F-23			
BSIE3590#2	SIE	25A, 1.3kV	F-64			
BSIE35110#1	SIE	25A, 1.6kV	F-23			
BSIE35110#2	SIE	25A, 1.6kV	F-64			
BSIE4026		50Hz-Thy 18A, 400V, 0.05A	D-14	BSIE4026M		
BSIE4026M		50Hz-Thy 22A, 400V, 0.05A	D-14			
BSIE4033		50Hz-Thy 18A, 500V, 0.05A	D-14	BSIE4033M		
BSIE4033M		50Hz-Thy 22A, 500V, 0.05A	D-14			
BSIE4040		50Hz-Thy 18A, 600V, 0.05A	D-14	BSIE4040M		
BSIE4040M		50Hz-Thy 22A, 600V, 0.05A	D-14			
BSIE4046		50Hz-Thy 18A, 700V, 0.05A	D-14	BSIE4046M		
BSIE4046M		50Hz Thy 22A, 700V, 0.05A	D-14			
BSIE4053		50Hz-Thy 18A, 800V, 0.05A	D-14	BSIE4053M		
BSIE4053M		50Hz-Thy 22A, 800V, 0.05A	D-14			
BSIE4126		50Hz-Thy 18A, 400V, 0.05A	F-55	BTW40-400, CS13-04, T15.1N400, TAG16N400		
BSIE4126M		50Hz-Thy 22A, 400V, 0.05A	F-55	CS23-04, T17N400, T24N400, TAG24N400		
BSIE4133		50Hz-Thy 18A, 500V, 0.05A	F-55	BTW40-600, CS13-06, T15.1N600, TAG16N600		
BSIF4133M		50Hz-Thy 22A, 500V, 0.05A	F-55	CS23-06, T17N600, T24N600, TAG24N600		
BSIE4140		50Hz-Thy 18A, 600V, 0.05A	F-55	BTW40-800, CS13-06, T15.1N800, TAG16N800		
BSIE4140M		50Hz-Thy 22A, 600V, 0.05A	F-55	CS23-06, T17N800, T24N800, TAG24N800		
BSIE4146		50Hz-Thy 18A, 700V, 0.05A	F-55	BTW40-800, CS13-08, T15.1N800, TAG16N800		
BSIE4146M		50Hz Thy 22A, 700V, 0.05A	F-55	CS23-08, T17N800, T24N800, TAG24N800		
BSIE4153		50Hz-Thy 18A, 800V, 0.05A	F-55	BTW40-800, CS13-08, T15.1N800, TAG16N800		
BSIE4153M		50Hz-Thy 22A, 800V, 0.05A	F-55	CS23-08, T17N800, T24N800, TAG24N800		
BSIF2540S9	SIE	30A, 600V, 0.2A, 2V	E-22			

器件型号 Element type	厂名 Manufacturers	材料用途参数 Material Purpose Parameter	图号 Figure	国内外相似替换器件型号 Replace of similar type	备注 Notes	外形参考图 Reference shape
BSIF2566S9	SIE	30A, 1kV, 0.2A, 2V	E-22			
BSIF2580S9	SIE	30A, 1.2kV, 0.2A, 2V	E-22			
BSIF3540#1	SIE	32A, 600V, 0.2A, 1.5V	F-23			
BSIF3540#2	SIE	50A, 600V, 0.2A, 1.5V	F-64			
BSIF3560#1	SIE	32A, 900V, 0.2A, 1.5V	F-23			
BSIF3560#2	SIE	50A, 900V, 0.2A, 1.5V	F-64			
BSIF3580	SIE	50A, 1.2kV, 0.2A, 1.5V	F-23			
BSIF3590#2	SIE	50A, 1.3kV, 0.2A, 1.5V	F-64			
BSIF9440	SIE	37.5A, 600V	F-49			
BSIF9466	SIE	37.5A, 1V	F-49			
BSIF9740	SIE	37.5A, 600V	F-49			
BSIF9766	SIE	37.5A, 1V	F-49			
BSIF35110#1	SIE	50A, 1.6kV, 0.2A, 1.5V	F-23			
BSIF35110#2	SIE	50A, 1.6kV, 0.2A, 1.5V	F-64			
BSIG3540#1	SIE	63A, 600V, 0.2A, 1.5V	F-23			
BSIG3540#2	SIE	63A, 600V, 0.2A, 1.5V	F-64			
BSIG3560#1	SIE	63A, 900V, 0.2A, 1.5V	F-23			
BSIG3560#2	SIE	63A, 900V, 0.2A, 1.5V	F-64			
BSIG3580#2	SIE	40A, 1.2kV	F-64			
BSIG3590#1	SIE	63A, 1.3kV, 0.2A, 1.5V	F-23			
BSIG3590#2	SIE	63A, 1.3kV, 0.2A, 1.5V	F-64			
BSIG35110#1	SIE	63A, 1.6kV, 0.2A, 1.5V	F-23			
BSIG35110#2	SIE	63A, 1.6kV, 0.2A, 1.5V	F-64			
BSIH3440	SIE	135A, 600V	F-92			

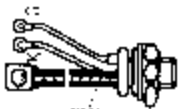
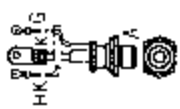
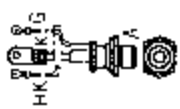
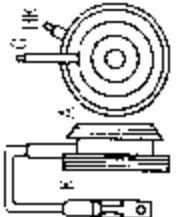
器件型号 Element type	厂名 Manufacturers	材料用途参数 Material Purpose Parameter	图号 Figure	国内外相似替换器件型号 Replace of similar type	备注 Notes	外形参考图 Reference shacc	
BSIH3440K	SIE	135A, 600V, 0.25A, 1.5V	E-30			 图 E-30	
BSIH3450	SIE	135A, 900V	F-92				
BSIH3460K	SIE	135A, 900V, 0.25A, 1.5V	E-30				
BSIH3480K	SIE	135A, 1.2kV, 0.25A, 1.5V	F-92				
BSIH3486	SIE	135A, 1.3kV	F-92				
BSIH3540	SIE	85A, 600V, 0.2A, 1.5V	F-92			 图 F-92	
BSIH3560	SIE	85A, 900V, 0.2A, 1.5V	F-92				
BSIH3580	SIE	85A, 1.2kV, 0.15A, 1.5V	F-92				
BSIH3590	SIE	85A, 1.3kV, 0.2A, 1.5V	F-92				
BSIH3733F	SIE	135A, 500V, 0.25A, 1.5V				 图 F-92	
BSIH3740	SIE	135A, 600V	F-92				
BSIH3740F	SIE	135A, 600V, 0.25A, 1.5V					
BSIH3753	SIE	135A, 800V	F-92				
BSIH3753F	SIE	135A, 800V, 0.25A, 1.5V					
BSIH3760	SIE	135A, 900V	F-92				
BSIH3760F	SIE	135A, 900V, 0.25A, 1.5V	F-92				
BSIH3766	SIE	135A, 1kV	F-92				
BSIH3766F	SIE	135A, 1kV, 0.25A					
BSIH4440	SIE	205A, 600V	C-75				 图 C-75
BSIH4440K	SIE	205A, 600V, 0.25A, 1.5V	C-35				
BSIH4453K	SIE	205A, 800V, 0.25A, 1.5V					
BSIH4460	SIE	205A, 900V	C-75				
BSIH4460K	SIE	205A, 900V, 0.25A, 1.5V	C-35				
BSIH4466K	SIE	205A, 1kV, 0.25A, 1.5V					
BSIH4480	SIE	205A, 1.2kV	C-75				
BSIH4480K	SIE	205A, 1.2kV, 0.25A, 1.5V	C-35				
BSIH4486	SIE	205A, 1.3kV					
BSIH4486K	SIE	205A, 1.3kV, 0.25A, 1.5V					

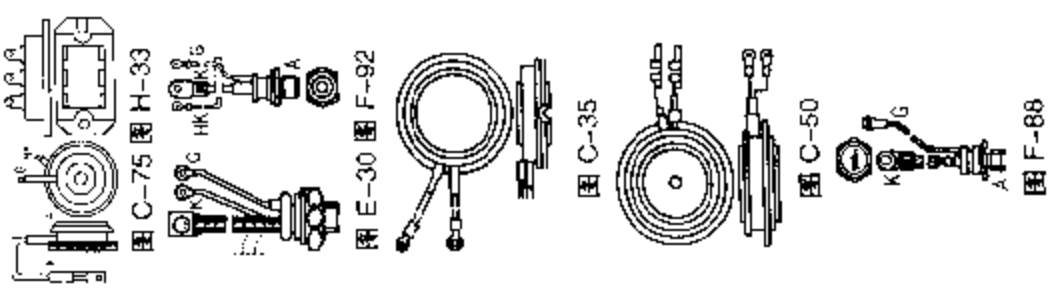
器件型号 Element type	厂名 Manufacturers	材料用途参数 Material Purpose Parameter	图号 Figure	国内外相似替换器件型号 Replace of similar type	备注 Notes	外形参考图 Reference shape
BSIH4740	SIE	205A, 600V	C-75			
BSIH4753	SIE	205A, 800V	C-75			
BSIH4760	SIE	205A, 900V	C-75			
BSIH4766	SIE	205A, 1kV	C-75			
BSIH6113F	SIE	140A, 200V, 0.2A, 1.5V	H-33			
BSIH6120	SIE	275A, 300V	H-33			
BSIH6120F	SIE	140A, 300V, 0.2A, 1.5V	H-33			
BSIH6126	SIE	275A, 400V	H-33			
BSIH6126F	SIE	140A, 400V, 0.2A, 1.5V	H-33			
BSIH6126GS9	SIE	250A, 400V, 0.25A, 1.5V	H-33			
BSIH6126Y	SIE	160A, 400V, 0.2A, 1.5V	H-33			
BSIH6133	SIE	275A, 500V	H-33			
BSIH6133F	SIE	140A, 500V, 0.2A, 1.5V	H-33			
BSIH6133Y	SIE	160A, 500V, 0.2A, 1.5V	H-33			
BSIH6140	SIE	275A, 600V	H-33			
BSIH35100S9	SIE	85A, 1.5kV, 0.2A, 1.5V	E-30			
BSIH35110	SIE	85A, 1.6kV, 0.2A, 1.5V	F-92			
BSIK4560	SIE	185A, 900V, 0.25A, 1.5V	C-35			
BSIK45110	SIE	185A, 1.6kV, 0.25A, 1.5V	C-35			
BSIL3440K	SIE	235A, 600V, 0.25A, 1.5V	F-92			
BSIL3480K	SIE	235A, 1.2kV, 0.25A, 1.5V	C-50			
BSIL3540	SIE	150A, 600V	F-92			
BSIL3553S10	SIE	150A, 800V, 0.25A, 1.5V	F-88			
BSIL3560	SIE	150A, 900V	F-92			

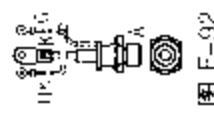
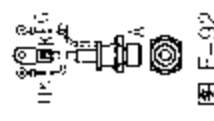
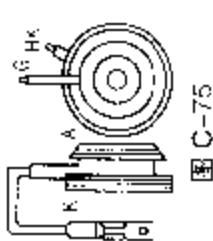
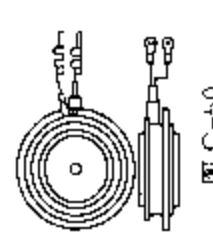
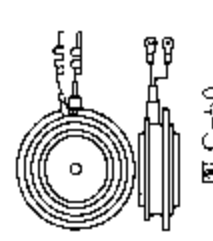
器件型号 Element type	厂名 Manufacturers	材料 Material	用途 Purpose	参数 Parameter	图号 Figure	国内外相似替换器件型号 Replace of similar type	备注 Notes	外形参考图 Reference shape
BSIL3580	SIE	150A,	1.2kV		F-92			
BSIL3590	SIE	150A,	1.3kV		F-92			
BSIL3740	SIE	235A,	600V		F-92			
BSIL3740F	SIE	235A,	600V,	0.25A,	1.5V			
BSIL3753	SIE	235A,	800V		F-92			
BSIL3753F	SIE	150A,	800V,	0.25A,	1.5V			
BSIL3760	SIE	235A,	900V		F-92			
BSIL3760F	SIE	235A,	900V,	0.25A,	1.5V			
BSIL3766	SIE	235A,	1kV		F-92			
BSIL3766F	SIE	150A,	1kV,	0.25A,	1.5V			
BSIL4440K	SIE	400A,	600V,	0.25A,	1.5V			
BSIL4460K	SIE	400A,	900V,	0.25A,	1.5V			
BSIL4480K	SIE	400A,	1.2kV,	0.25A,	1.5V			
BSIL4486K	SIE	400A,	1.3kV,	0.25A,	1.5V			
BSIL4540	SIE	240A,	600V,	0.25A,	1.5V	C-75		
BSIL4560	SIE	240A,	900V,	0.25A,	1.5V	C-75		
BSIL4590	SIE	375A,	1.3kV,	0.25A,	1.5V	C-75		
BSIL4740	SIE	400A,	600V		C-75			
BSIL4740F	SIE	240A,	600V,	0.25A,	1.5V	C-50		
BSIL4753	SIE	400A,	800V		C-75			
BSIL4753F	SIE	240A,	800V,	0.25A,	1.5V	C-50		
BSIL4760	SIE	400A,	900V		C-75			
BSIL4760F	SIE	240A,	900V,	0.25A,	1.5V	C-50		
BSIL4766	SIE	400A,	1kV		C-75			
BSIL4766F	SIE	240A,	1kV,	0.25A,	1.5V	C-50		

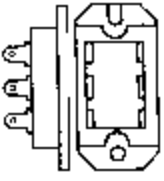
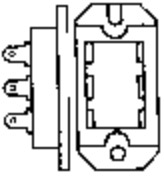
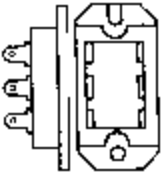
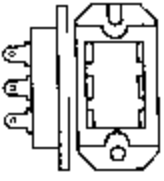
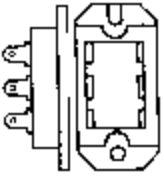
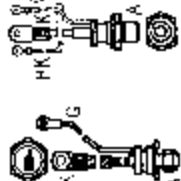
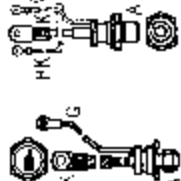
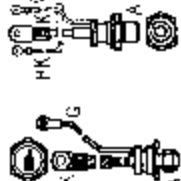
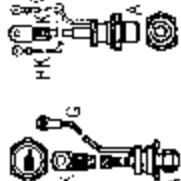
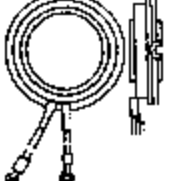
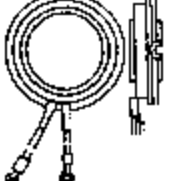
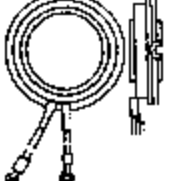
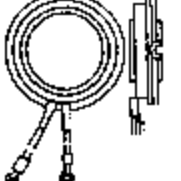
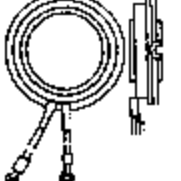
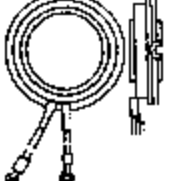
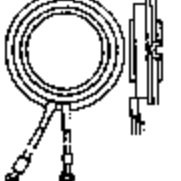
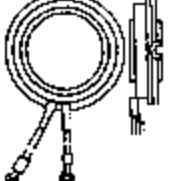
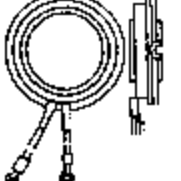
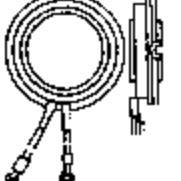
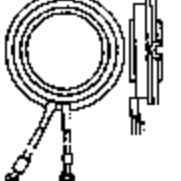
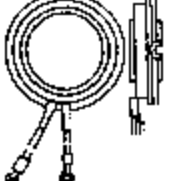

器件型号 Element type	厂名 Manufacturers	材料用途参数 Material Purpose Parameter	图号 Figure	国内外相似替换器件型号 Replace of similar type	备注 Notes	外形参考图 Reference shape
BSIL6120F	SIE	550A, 300V, 0.25A, 1.5V	H-33			
BSIL6126F	SIE	550A, 400V, 0.25A, 1.5V	H-33			
BSIL6133F	SIE	550A, 500V, 0.25A, 1.5V	H-33			
BSIL6140F	SIE	550A, 600V, 0.25A, 1.5V	H-33			
BSIL35100	SIE	150A, 1.5kV, 0.25A, 1.5V	F-88			
BSIL35100S9	SIE	150A, 1.5kV, 0.25A, 1.5V	F-88			
BSIL35100S10	SIE	150A, 1.5kV, 0.25A, 1.5V	F-88			
BSIL35110	SIE	235A, 1.6kV, 0.25A, 1.5V	F-92			
BSIL45110	SIE	240A, 1.6kV, 0.25A, 1.5V	C-35			
BSIL46133	SIE	145A, 2kV	C-75			
BSIL46146	SIE	145A, 2.2kV	C-75			
BSIL46166	SIE	145A, 2.5kV	C-75			
BSIM4560	SIE	350A, 900V, 0.25A, 1.5V	C-35			
BSIM4580	SIE	350A, 1.2kV, 0.25A, 1.5V	C-35			
BSIM4590	SIE	350A, 1.3kV, 0.25A, 1.5V	C-35			
BSIN45B60	SIE	710A, 900V, 0.25A, 1.5V	C-75			
BSIN45B80	SIE	710A, 1.2kV, 0.25A, 1.5V	C-75			
BSIN3440	SIE	440A, 600V	F-92			
BSIN3440K	SIE	390A, 600V, 0.25A, 2.5V	F-48			
BSIN3460	SIE	440A, 900V	F-92			
BSIN3460K	SIE	390A, 900V, 0.25A, 2.5V	F-48			
BSIN3486	SIE	440A, 1.3kV	F-92			
BSIN3486I	SIE	440A, 1.3kV, 0.25A, 2.5V	F-48			
BSIN3486K	SIE	390A, 1.3kV, 0.25A, 2.5V	F-48			

外形参考图

Reference shape



图 H-33



图 F-88 图 F-92

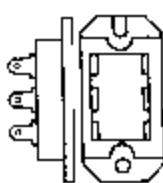

图 C-35

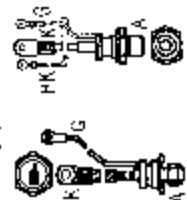

图 C-75



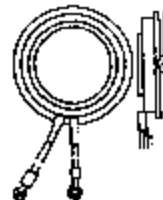



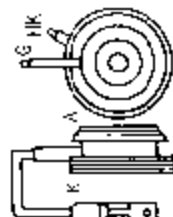



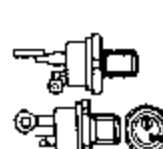
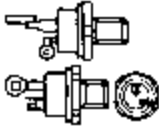



















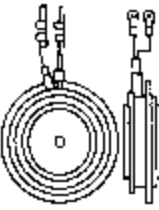
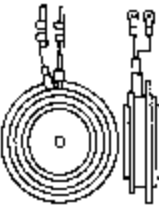
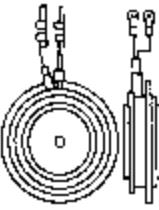

图 F-48

器件型号 Element type	厂名 Manufacturers	材料用途参数 Material Purpose Parameter	图号 Figure	国内外相似替换器件型号 Replace of similar type	备注 Notes	外形参考图 Reference shape
BSIN3540	SIE	440A, 600V, 0.25A, 1.5V	F-48			
BSIN3553S9	SIE	280A, 800V, 0.25A, 1.5V	F-88			
BSIN3560	SIE	280A, 900V, 0.25A, 1.5V	F-92			
BSIN3580	SIE	280A, 1.2KV, 0.25A, 1.5V	F-92			
BSIN3590	SIE	280A, 1.3KV, 0.25A, 1.5V	E-18			
BSIN3740	SIE	440A, 600V	F-92			
BSIN3740F	SIE	410A, 600V, 0.25A, 2.5V	F-92			
BSIN3753	SIE	440A, 800V	F-92			
BSIN3753F	SIE	410A, 800V, 0.25A, 2.5V	F-48			
BSIN3760	SIE	440A, 900V	F-92			
BSIN3766	SIE	440A, 1KV	F-92			
BSIN3766F	SIE	410A, 1KV, 0.25A, 2.5V	F-48			
BSIN4440	SIE	710A, 600V	C-50			
BSIN4440K	SIE	630A, 600V, 0.25A, 2.5V	C-50			
BSIN4460	SIE	710A, 900V	C-50			
BSIN4460K	SIE	630A, 900V, 0.25A, 2.5V	C-50			
BSIN4480	SIE	710A, 1.2KV	C-50			
BSIN4480K	SIE	710A, 1.2KV, 0.25A, 2.5V	C-50			
BSIN4486	SIE	710A, 1.3KV	C-50			
BSIN4486K	SIE	630A, 1.3KV, 0.25A, 2.5V	C-50			
BSIN4560	SIE	705A, 900V, 0.25A, 1.5V	C-50			
BSIN4590	SIE	705A, 1.3KV, 0.25A, 1.5V	C-50			
BSIN4740	SIE	710A, 600V	C-50			
BSIN4740F	SIE	710A, 600V, 0.25A, 2.5V	C-50			
BSIN4753F	SIE	710A, 800V, 0.25A, 2.5V	C-50			

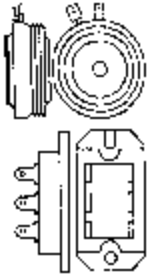
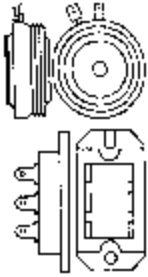
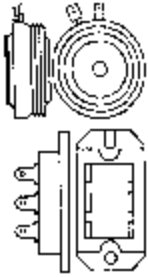
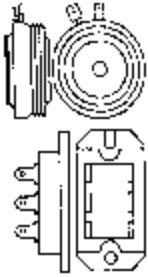
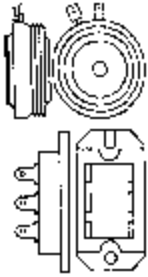
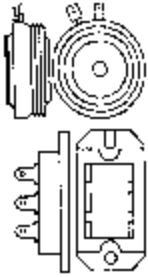
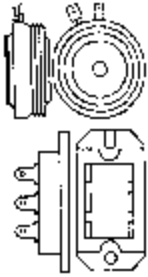
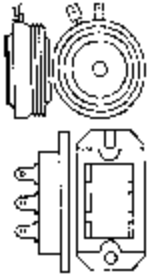
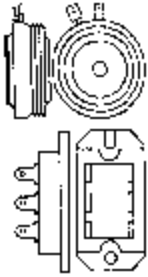
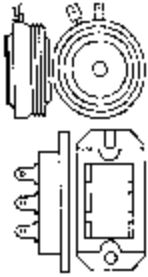
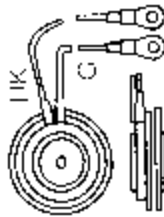
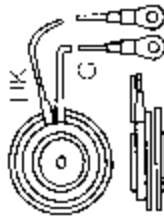
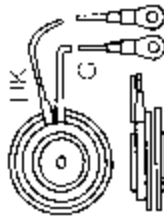
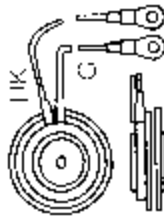
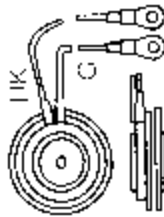
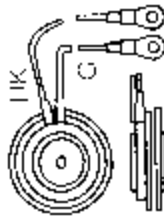
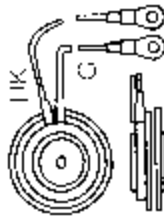
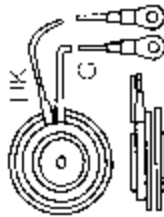
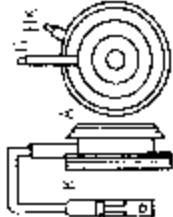
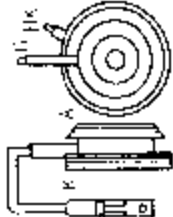
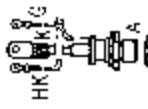
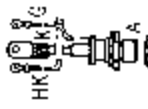
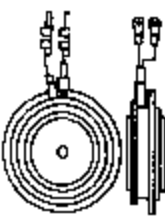
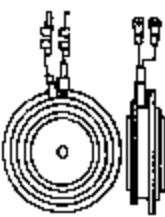
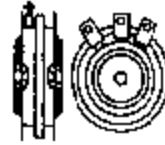
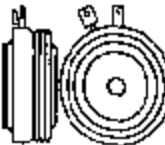
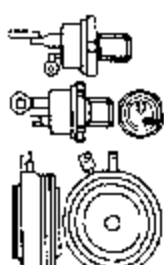
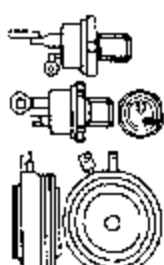
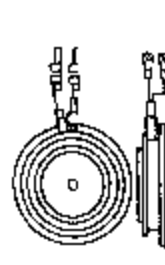
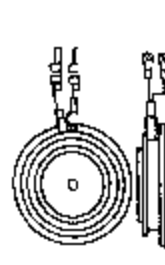
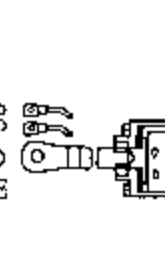
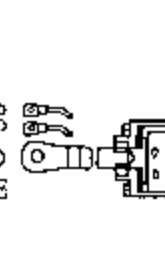
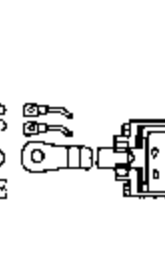
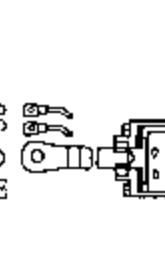
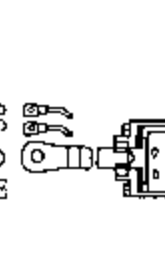
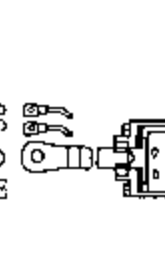
器件型号 Element type	厂名 Manufacturers	材料用途参数 Material Purpose Parameter	图号 Figure	国内外相似替换器件型号 Replace o' s.milar type	备注 Notes	外形参考图 Reference shape
BSIN4760	SIE	710A, 900V	C-50			
BSIN4760F	SIE	710A, 900V, 0.25A, 2.5V	C-50			
BSIN4766F	SIE	710A, 1kV, 0.25A, 2.5V	C-50			
BSIN5540S9	SIE	280A, 600V, 0.25A, 1.5V	E-11			
BSIN6113F	SIE	950A, 200V, 0.25A, 1.5V	H-33			
BSIN6113Y	SIE	600A, 200V, 0.25A, 1.5V	H-33			
BSIN6120F	SIE	950A, 300V, 0.25A, 1.5V	H-33			
BSIN6120Y	SIE	600A, 300V, 0.25A, 1.5V	H-33			
BSIN6126F	SIE	950A, 400V, 0.25A, 1.5V	H-33			
BSIN6126Y	SIE	600A, 400V, 0.25A, 1.5V	H-33			
BSIN6133F	SIE	950A, 500V, 0.25A, 1.5V	H-33			
BSIN6133Y	SIE	600A, 500V, 0.25A, 1.5V	H-33			
BSIN6140	SIE	950A, 600V	H-33			
BSIN6140F	SIE	950A, 600V, 0.25A, 1.5V	H-33			
BSIN6640	SIE	710A, 600V, 0.25A, 2.5V	C-8			
BSIN6646	SIE	710A, 700V, 0.25A, 2.5V	C-8			
BSIN6653	SIE	710A, 800V, 0.25A, 2.5V	C-8			
BSIN6660	SIE	710A, 900V, 0.25A, 2.5V	C-8			
BSIN6666	SIE	710A, 1kV, 0.25A, 2.5V	C-8			
BSIN6673	SIE	710A, 1.1kV, 0.25A, 2.5V	C-8			
BSIN6680	SIE	710A, 1.2kV, 0.25A, 2.5V	C-8			
BSIN6686	SIE	710A, 1.3kV, 0.25A, 2.5V	C-8			
BSIN46133	SIE	535A, 2kV, 0.25A, 1.5V	C-75			
BSIN46166	SIE	535A, 2.5kV, 0.25A, 1.5V	C-75			

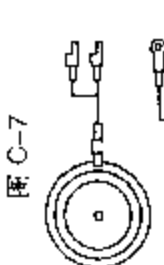
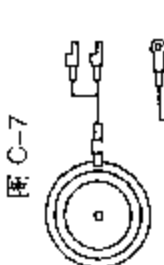
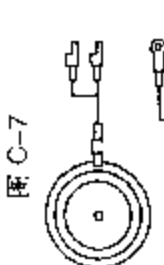
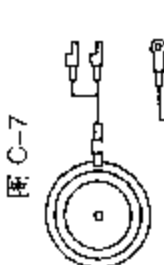
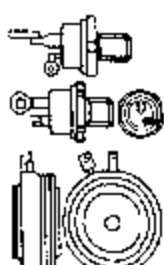
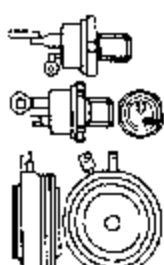
器件型号 Element type	厂名 Manufacturers	材料用途参数 Material Purpose Parameter	图号 Figure	国内外相似替换器件型号 Replace of similar type	备注 Notes	外形参考图 Reference shape
BSIP1580	SIE	800A, 1.2kV, 0.25A, 1.5V				
BSIP3580	SIE	550A, 1.2kV, 0.25A, 2.5V	F-92			
BSIP3590	SIE	350A, 1.3kV, 0.25A, 1.5V	F-92			
BSIP4480	SIE	1.3kA, 1.2kV	C-50			
BSIP4560	SIE	800A, 900V, 0.25A, 1.5V	C-50			
BSIP4566	SIE	800A, 1kV, 0.25A, 1.5V	C-50			
BSIP4580	SIE	800A, 1.2kV, 0.25A, 1.5V	C-50			
BSIP4940	SIF	1.2kA, 600V	C-14			
BSIP4960	SIE	1.2kA, 900V	C-14			
BSIP4960D	SIE	7.7kA, 900V, 0.35A, 2.5V	C-50			
BSIP4960E	SIE	1.1kA, 900V, 0.35A, 2.5V	C-50			
BSIP6113F	SIE	900A, 200V, 0.25A, 2.5V	C-50			
BSIP6113Y	SIE	1.1kA, 200V, 0.25A, 2.5V	C-50			
BSIP6120F	SIE	900A, 300V, 0.25A, 2.5V	C-50			
BSIP6120Y	SIE	1.7kA, 300V, 0.25A, 2.5V	C-50			
BSIP6126F	SIE	900A, 400V, 0.25A, 2.5V	C-50			
BSIP6440K	SIE	1.3kA, 600V, 0.25A, 2.5V	C-8			
BSIP6466KS9	SIE	1.3kA, 1kV, 0.25A, 2.5V	C-8			
BSIP6473KS9	SIE	1.3kA, 1.1kV, 0.25A, 2.5V	C-8			
BSIP6480	SIE	1.3kA, 1.2kV	C-7			
BSIP6486	SIE	1.3kA, 1.3kV	C-7			
BSIP6486K	SIE	1.3kA, 1.3kV, 0.25A, 2.5V	C-8			
BSIP6486KS9	SIE	1.3kA, 1.3kV, 0.25A, 2.5V	C-8			

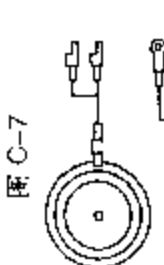
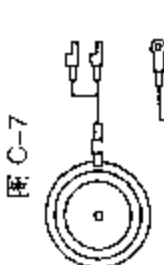
器件型号 Element type	厂名 Manufacturers	材料用途参数 Material Purpose Parameter	图号 Figure	国内外相似替换器型号 Replace of similar type	备注 Notes	外形参考图 Reference shape
BSIP6493KS9	SIE	1.3kA, 1.4kV, 0.25A, 2.5V	C-8			
BSIP15100	SIE	800A, 1.5kV, 0.25A, 1.5V				
BSIP35110	SIE	550A, 1.6kV, 0.25A, 1.5V	F-48			
BSIP35120	SIF	550A, 1.8kV, 0.25A, 1.5V	F-48			
BSIP45100	SIE	800A, 1.5kV, 0.25A, 1.5V	C-50			
BSIP45110	SIE	1.2kA, 1.6kV, 0.25A, 1.5V	C-50			
BSIP45120	SIE	1.2kA, 1.8kV, 0.25A, 1.5V	C-50			
BSIP45133	SIE	940A, 2kV, 0.25A, 1.5V	C-50			
BSIP46146	SIE	940A, 2.2kV, 0.25A, 1.5V	C-50			
BSIP46166	SIE	940A, 2.5kV, 0.25A, 1.5V	C-50			
BSIP56133	SIE	320A, 2kV, 0.25A, 1.5V	E-11			
BSIP56166	SIE	320A, 2.5kV, 0.25A, 1.5V	E-11			
BSIQ68H253	SIE	630A, 3.8kV, 0.3A, 2.5V	C-7			
BSIQ68H280	SIE	630A, 4.2kV, 0.3A, 2.5V	C-7			
BSIQ63120P	SIE	1.3kA, 1.8kV, 0.25A, 2V				
BSIR63L146	SIE	1.7kA, 2.2kV	C-7			
BSIR63L146T	SIE	1.7kA, 2.2kV, 0.3A, 2V	C-8			
BSIR63L166T	SIE	1.7kA, 2.5kV, 0.3A, 2V	C-8			
BSIR63L186	SIE	1kA, 2.8kV, 0.3A, 2.5V	C-47			
BSIR63L213	SIE	1kA, 3.2kV, 0.3A, 2.5V	C-47			
BSIR6460	SIE	1.7kA, 900V	C-7			
BSIR6460I	SIE	1.7kA, 900V, 0.3A, 2.5V				

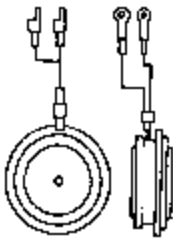
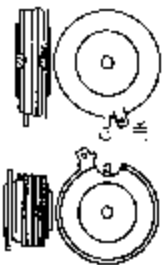
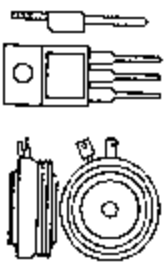
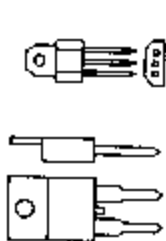
器件型号 Element type	厂名 Manufacturers	材料用途参数 Material Purpose Parameter	图号 Figure	国内外相似替换器件型号 Replace of similar type	备注 Notes	外形参考图 Reference shape
BSIR6480	SIE	1.7kA, 1.2kV				 图 C-47
BSIR6480I	SIE	1.7kA, 1.2kV, 0.3A, 2.5V				
BSIR6560	SIE	2.2kA, 900V, 0.3A, 2.5V	C-47			 图 C-11 图 C-7
BSIR6580	SIE	2.2kA, 1.2kV, 0.3A, 2.5V	C-47			
BSIR6590	SIE	1.4kA, 1.3kV, 0.35A, 2.5V	C-11			
BSIR63120	SIE	1.7kA, 1.8kV	C-7			 图 C-8 图 B-10
BSIR63120Q	SIE	1.7kA, 1.8kV, 0.3A, 2V	C-8			
BSIR63133	SIE	1.7kA, 2kV	C-7			
BSIR63133Q	SIE	1.7kA, 2kV, 0.3A, 2V	C-8			
BSIR65110	SIE	2.2kA, 1.6kV, 0.3A, 2.5V	C-47			 图 B-9 图 B-98
BSIR65120	SIE	1.4kA, 1.8kV, 0.3A, 2.5V	C-11			
BSIR66133	SIE	800A, 2kV, 0.3A, 2.5V	B-10			
BSIR66146	SIE	800A, 2.2kV, 0.3A, 2.5V	C-7			
BSIR66166	SIE	800A, 2.5kV, 0.3A, 2.5V	C-7			
BSIR66186	SIE	1.25kA, 2.8kV, 0.3A, 2.5V	C-47			
BSIT68H253	SIE	1.9kA, 3.8kV, 0.3A, 2.5V				
BSIT68H267	SIE	2.2kA, 4kV, 0.3A, 2.5V				
BSIT68H280	SIE	1.9kA, 4.2kV, 0.3A, 2.5V				
BSIT68L213	SIE	2.2kA, 3.2kV	C-7			
BSIT68L273	SIE	2.6kA, 3.2kV, 0.3A, 2.5V				
BT10-200B		10A, 200V	B-9	SC146B		
BT10-400B		10A, 400V	B-8	SC146D		
BT100A/...R		50Hz-Thy 4.5A, 300~500V, 0.01A, 0.015A	B-98	TAG621..., TAG631..., TAG632...		

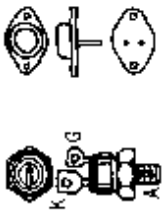
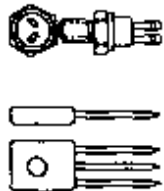
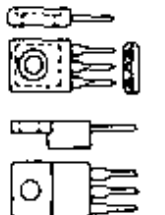

器件型号 Element type	厂名 Manufacturers	材料用途参数 Material Purpose Parameter	图号 Figure	国内外相似替换器件型号 Replace of similar type	备注 Notes	外形参考图 Reference shape
BT101/300...500R	NAS	50Hz-Thy 15A, 300-500V, 0.01A	F-47	BTW42-...		
BT102/...R	NAS	50Hz-Thy =BT101/...R: 0.05A	F-47			
BT103		GTO 2.6A, 1.1kV, 0.1A, 1μs	D-9			
BT104		GTO 3A, 1.2kV, 0.1A, 1μs	D-9			
BT105		GTO 2.7A, 600V, 0.1A, 1μs	D-9			
BT106	NAS	SCR-H 1A, 700V, 0.02A, 3V	F-47			
BT106A...D	NAS	50Hz-Thy 4A, 100-400V, 0.0002A, 0.8V	B-6	C106A, TIC106..., 2N6236...41		
BT107	NAS	Thy 6.5A, 500V, 0.01A, 2V	F-47	ECC5487, SK3944, SK5487		
BT108	NAS	Thy 6.5A, 500V, 0.05A, 3.5V	F-47	BTW42-600, ECG5487, SK3944, SK5487		
BT109		Thy 6.5A, 500V, 0.01A, 0.05A	F 55			
BT110		Thy 6A, 400V, 0.035A, 0.02A				
BT112-750R		F-Thy TV-HA, 5A, 750V, 0.05A	D-9	S3703SF, TD3F800H, TU3F800H		
BT113-700R		F-Thy TV-HA, 5A, 700V, 0.05A	D-9	S3702S, S6080C, TD3F800R		
BT114		F-Thy TV-HA, 3.2A, 750V, 0.05A		S3703SF, TD3F800H, TU3F800H		
BT115		F-Thy TV-HA, 3.2A, 700V, 0.05A		S3702S, S6080C, TD3F800R		
BT116		Thy 1A, 750V, 0.02A				
BT117		F-Thy TV-HA, 3.2A, 750V, 2.4μs	B-11	BS1C1250, 17088		
BT118		F-Thy TV-HA, 3.2A, 750V, 2.4μs	B-11	BS1CC0253R, BT154, 17089		
BT119		F-Thy TV-HA, 3A, 750V, 2.4μs	D-9	S3703, TD3F800H, TU3F800H		
BT120		F-Thy TV-HA, 700V, 0.04A, 0.1A	D-9	TD3F800R, TD4F800R		
BT121		F-Thy TV-HA, 2.8A, 500V, 2.4μs	D-9	S3705, S3703, TD3F500H, TU3F500H		
BT122		F-Thy 2.8A, 500V, 0.04A, 0.1A	D-9	BS1C0930T92, BS1E0433T, TD3F500H		
BT123		Triac 15A, 500V, 0.035A, 0.05A	B-82	TAG257-500		
BT124		SCR-H 4.5A, 500V, 0.015A, 0.025A	B-82			
BT125-700R		SCR-H TV-HA, 5A, 700V, 0.04A	D-9	S3702, S6080C, TD3F700R		
BT126-750R		SCR-H TV-HA, 5A, 750V, 0.04A	D-9	S3703, TD3F800H, TU3F800H		
BT127/...(R)		SCR-H 5A, 350-750V, 0.04A, 0.05A	D-9	TAG670S..., TAG675S...		
BT128-700R		F-Thy+Di TV-HA, 5A, 700V, 0.04A	D-9	BS1CC0146R, S6087A, TD3F800R		



图 F-47 图 D-9



图 B-6 图 F-55



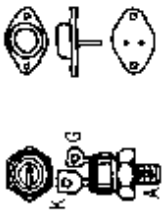



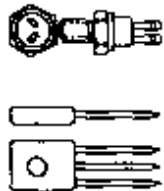



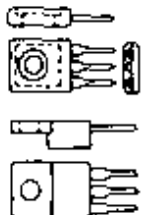
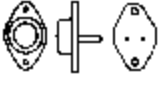
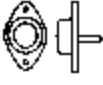

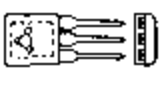
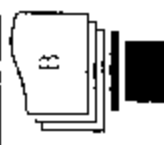
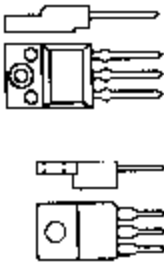
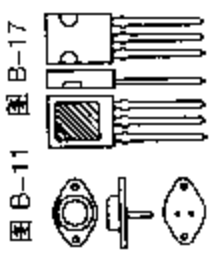
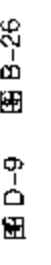

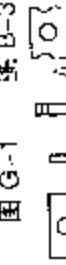



图 B-11 图 B-82

器件型号 Element type	厂名 Manufacturers	材料用途参数 Material Purpose Parameter	图号 Figure	国内外相似替换器件型号 Replace of similar type	备注 Notes	外形参考图 Reference shape
BT129/...R	F Thy+Di	TV-HA, 5A, 600-750V	D 9	BSIC00140-0153H, S6087B, TD3F...H		
BT132	Thy	1A, -700V, 400V, 0.05A	F-55			
BT133	Thy	1A, -100V, 400V, 0.05A	F-55			
BT134/... BT134/...B BT134/...E BT134/...F BT134/...G BT134W/...	Triac	4A, 500-800V, 0.07A, 0.015A =BT134/...: 0.01A, 0.01A =BT134/...: 0.025A =BT134/...: 0.07A =B134/...: 0.1A, 0.03A 1A, 500-800V, 0.035A	B-81 B-81 B-81 B-81 B-81 G-6			
BT136/... BT136/...D BT136/...E BT136/...F BT136/...G BT137/... BT137/...D BT137/...E BT137/...F BT137/...G BT138/... BT138/...E BT138/...F BT138/...G BT139/... BT139/...E BT139/...F	Triac	4A, 500-800V, 0.07A, 0.03A 4A, 500-800V, 0.01A, 0.015A 4A, 500-800V, 0.025A, 0.02A 4A, 500-800V, 0.07A, 0.03A 4A, 500-800V, 0.01A, 0.045A 8A, 500-800V, 0.07A, 0.045A 8A, 500-800V, 0.01A, 0.02A 8A, 500-800V, 0.025A, 0.035A 8A, 500-800V, 0.07A, 0.045A 8A, 500-800V, 0.1A, 0.06A 12A, 500-800V, 0.07A, 0.06A 12A, 500-800V, 0.025A, 0.04A 12A, 500-800V, 0.07A, 0.06A 12A, 500-800V, 0.1A, 0.09A 16A, 500-800V, 0.07A, 0.06A 16A, 500-800V, 0.025A, 0.04A 16A, 500-800V, 0.07A, 0.06A	B-11 B-11 B-11 B-11 B-11 B-11 B-11 B-11 B-11 B-11 B-11 B-11 B-11 B-11 B-11 B-11 B-11 B-11	TAG230-..., TAG231-..., TXC10H... TAG221-..., TAG232-..., TXC18G... TAG220-..., TAG225-..., TAG231-... TAG230-..., TAG231-..., IXC10H... TAG224-..., TAG230-..., TXC10H... MAC222A..., TAG224-..., TXD10H... MAC228A..., TAG226-... TAG225-..., TAG252-..., TAG255... MAC222A..., TAG224-..., TXD10H... MAC222A..., TAG224-..., TXD10H... TAG255-..., TAG256-..., TXD10H...P TAG257-... TAG255-..., TAG256-..., TXD10H...P TAG255-..., TAG256-..., TXD10H...P MAC15A..., TAG280-..., TAG281...		

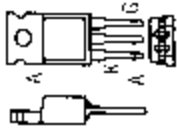
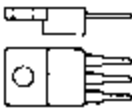



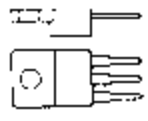
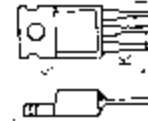



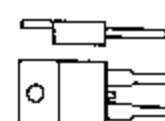
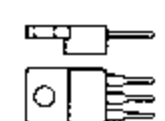
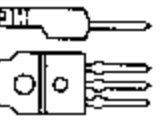

器件型号 Element type	厂名 Manufacturers	材料用途参数 Material Purpose Parameter	图号 Figure	国内外相似替换器件型号 Replace of similar type	备注 Notes	外形参考图 Reference shape
BT139/...G		Triac 16A, 500-800V, 0.1A, 0.09A	B-11	MAC15A..., TAG280-...A, TAC281-...		
BT139X		SCR-D 16A, 800V	B-17			
BT143-400R		F-Thy+Di 3.2A, 400V, 0.04A	D-9	BSICCO126T91...0153T91, BT127750R		
BT145/...R		16A, 500-800V, 0.035A, 0.06A	B-11	BSID10...M, CS15..., T9.5N..., 2N6400...05		
BT146		15A, 500V, 0.035A	D-9	BT152/..., T9.5N..., 2N6404, 2N6405		
BT148		6.5A, 500V, 0.035A	D-9	TIC122D...E, 2N6404, 2N6405		
BT148-400R		4A, 400V	B-26			
BT148-500R		4A, 500V	B-26			
BT148-600R		4A, 600V	B-26			
BT148W/...R		1A, 400-600V, 0.0003A, 0.006A	G-1			
BT149A...M		1A, 50-600V, 0.0002A, 0.005A	B-35	MCR606-2...8, IAG59..., 2N6681/...85		
BT150		4A, 500V, 0.0002A, 0.006A	B-9	S4060E, TIC106E, TAG623-500, TAG628-500		
BT151/...R		12A, 500-800V, 0.015A, 0.02A	B-11			
BT151F/...		F-Thy =BT151/...R: 9A	B-11			
BT152/...R		50Hz-Thy 70A, 400-800V, 0.032A, 0.06A, 0.06A, 1V	B-11			
BT152-800A		50Hz-Thy 13A, 800V, 0.032A, 1V	B 91			
BT153	APX, MUL	SCR-H 4A, 500V, 0.04A, 2.5V	B-91	2N6504...6509		
BT153#	APX, MUL	4A, 500V, 0.04A, 2.5V	C-50	2N6504, 2N6505, 2N6506, 2N6507, 2N6508, BT154		
BT154	VAL	4A, 750V, 0.04A, 2.5V	B-91			
BT154#	PTC, VAL	5A, 750V, 0.04A, 2.5V	B-91			
BT155 600R	VAL	9.5A, 600V, 0.1A, 2V	B-91			
BT155-600RK	APX, MUL	9.5A, 600V, 0.1A, 2V	B-91			
BT155-600RN	APX, MUL	9.5A, 600V, 0.1A, 2V	B-91			
BR155-600RP	APX, MUL	9.5A, 600V, 0.1A, 2V	B-91			
BT155-800RK	APX, MUL	9.5A, 800V, 0.1A, 2V	B-91			
BT155-800RN	APX, MUL	9.5A, 800V, 0.1A, 2V	B-91			

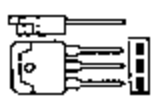
器件型号 Element type	厂名 Manufacturers	材料用途参数 Material Purpose Parameter	图号 Figure	国内外相似替换器件型号 Replace of similar type	备注 Notes	外形参考图 Reference shape
BT155-800RN#	VAL	SCR-H 9.5A, 800V, 0.1A, 2V	B-91			 图 B-91
BT155-800RP	APX, MJL	SCR-H 9.5A, 800V, 0.1A, 2V	B-91			
BT155-800RP#	VAI	SCR-H 9.5A, 800V, 0.1A, 2V	B-91			
BT157/...R	SCR-D	GTO, 2.2A, 1.3~1.5kV, 0.2A	B-11	BTW58-1300...1500		
BT158/...	Triac	8A, 400-800V, 0.04A, 0.03A	B-11	BT162/..., T2586..., T2806...		
BT162/...	Triac	12A, 400-800V, 0.04A, 0.03A	B-11	T6006..., TAG257...		
BT169B...G	F-thy	0.8A, 200-600V, 0.0002A, 0.005A	B-35	BRX47...49, BRY55S/200...800		
BTA04...A	Triac	4A, 200-800V, 0.025A, 0.025A	B-11	TAG220..., TAG231..., TAG421...		 图 B-11
BTA04...D	Triac	4A, 200-800V, 0.01A, 0.015A	B-11	TAG232..., TIC216..., TXC18H...		
BTA04...GP	Triac	4A, 200-800V, 0.075A, 0.013A	B-11	TAG232..., TIC216..., TXC18H...		
BTA04...S	Triac	4A, 200-800V, 0.01A, 0.025A	B-11	TAG231..., TAG232..., TXC18G...		
BTA04...T	Triac	4A, 200-800V, 0.005A, 0.015A	B-11	TAG222..., TAG233..., TXD18D...		
BTA06...A	Triac	6A, 200-800V, 0.025A, 0.025A	B-11	TAG220..., TAG225..., TAG421...		 图 B-35
BTA06...B	Triac	6A, 200-800V, 0.1A, 0.05A	B-11	TAG224..., TAG420..., TXC10H...M		
BTA06...C	Triac	6A, 200-800V, 0.05A, 0.025A	B-11	TAG224..., TAG420..., TXC10H...M		
BTA06...D	Triac	6A, 200-800V, 0.01A, 0.015A	B-11	TAG221..., IAG226..., TXC18G...M		
BTA06...GP	Triac	6A, 200-800V, 0.075A, 0.013A	B-11	BS7...A, MAC216..., SC141..., T2801...		
BTA06...S	Triac	6A, 200-800V, 0.01A, 0.025A	B-11	TAG221..., TAG227..., TXC18D...M		
BTA06...T	Triac	6A, 200-800V, 0.005A, 0.015A	B-11	TAG222..., TAG227..., TXC18D...M		
BTA06...AW, BW, CW	Triac	=BTA06...A, B, C	B-11			
BTA06...SW, TW	Triac	=BTA06...S: log	B-11			
BTA08...A	Triac	8A, 200-800V, 0.025A, 0.025A	B-11	TAG426..., TAG452..., TAG457...		
BTA08...B	Triac	8A, 200-800V, 0.1A, 0.05A	B-11	TAG425..., TAG451..., TAG456...		

器件型号 Element type	厂名 Manufacturers	材料用途参数 Material Purpose Parameter	图号 Figure	国内外相似替换器件型号 Replace of similar type	备注 Notes	外形参考图 Reference shape
BTA08...C	Triac	8A, 200-800V, 0.05A, 0.025A	B-11	TAG425..., TAG451..., TAG456...		 图 B-1*
BTA08...S	Triac	8A, 200-800V, 0.01A, 0.025A	B-11	MAC228A-..., TAG226...		
BTA08...AW, BW, CW	Triac	=BTA08...A, B, C				
BTA08...SW, TW	Triac	=BTA08...S: TW=0.005A	B-11			
BTA10...B	Triac	10A, 200-800V, 0.1A, 0.05A	B-11	TAG456..., TAG480..., TAG481...		 图 B-1*
BTA10...C	Triac	10A, 200-800V, 0.05A, 0.025A	B-11	TAG456..., TAG480..., TAG481...		
BTA10...AW, BW, CW	Triac	=BTA10...	B-11			
BTA12...B	Triac	12A, 200-800V, 0.1A, 0.05A	B-11	TAG480..., TAG481...		 图 B-1*
BTA12...C	Triac	12A, 200-800V, 0.05A, 0.025A	B-11	TAG480..., TAG481...		
BTA12...AW, BW, CW	Triac	=BTA12...	B-11			
BTA13...B	Triac	12A, 200-800V, 0.05A, 0.05A	B-11	TAG480..., TAG481...		
BTA16...B	Triac	16A, 200-800V, 0.1A, 0.05A	B-11	BT139/..., MAC15A..., TAG280...		 图 B-91
BTA16...C	Triac	16A, 200-800V, 0.05A, 0.025A	B-11	BT139/..., MAC15A..., TAG280...		
BTA16...AW, BW, CW	Triac	=BTA16...	B-11			
BTA20...AW	Triac	20A, 400-800V, 0.075A	B-11			ECG5635, TXC10L40M, TW7N400, TIC226D ECG5637, TXC10L50M, TW7N600, TIC226E TXC10I 60M, TW7N600, TIC226M TXC10L80M, TW7N800, TIC226N
BTA20...BW	Triac	=BTA20...AW: 0.05A, 0.075A	B-11			
BTA20...CW	Triac	=BTA20...AW: 0.035A, 0.05A	B-11			
BTA20D	RCA	6A, 400V, 0.08A, 4V	B-91			
BTA20E	RCA	6A, 500V, 0.08A, 4V	B-91			
BTA20M	SCR-D	6A, 600V, 0.08A, 0.1A	B-11			
BTA20N	SCR-D	6A, 800V, 0.08A, 0.1A	B-11			

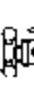
器件型号 Element type	厂名 Manufacturers	材料用途参数 Material Purpose Parameter	图号 Figure	国内外相似替换器件型号 Replaco of similar type	备注 Notes	外形参考图 Reference shape
BTA21		SCR-D 8A, 200V, 0.035A, 0.1A	B-9	T2802B		 图 B-9 图 B-91
BTA21C	RCA	SCR-D 8A, 300V, 0.035A, 2.5V	B-91	ECG5635, TAG225-300, TAG257-300		
BTA21D		SCR-D 8A, 400V, 0.035A, 0.1A	B-11	TAG225-400, TAG257-400		 图 B-11 图 B-2
BTA21E	RCA	SCR-D 8A, 500V, 0.035A, 2.5V	B-91	ECG5635, TAG225-500, TAG257-500		
BTA21M		SCR-D 8A, 600V, 0.035A, 0.1A	B-11	TAG225-600, TAG257-600		 图 B-14 图 B-84
BTA21N		SCR-D 8A, 800V, 0.035A, 0.1A	B-11	TAG225-800, TAG257-800		
BTA22		SCR D 6A, 600V	B 9	SC146		
BTA22B	RCA	SCR-D 10A, 200V, 0.025A, 2.5V	B-91	ECG5633, TAG250-200, TAG251-200, TXD10H40M		
BTA22C	RCA	SCR-D 10A, 300V, 0.025A, 2.5V	B-91	ECG5635, TAG250-300, TAG251-300, TXD10H40M		
BTA22D	RCA	SCR-D 10A, 400V, 0.025A, 2.5V	B-91	ECG5635, TAG250-400, TAG251-400, TXD10H40M		
BTA22E	HCA	SCR-D 10A, 500V, 0.025A, 2.5V	B-91	ECG5637, TAG250-500, TAG251-500, TXD10H50M		
BTA22M	RCA	SCR-D 10A, 600V, 0.025A, 2.5V	B-91	ECG5637, TAG250-600, TAG251-600, TXD10H60M		
BTA22N		SCR-D 10A, 800V, 0.06A, 0.03A	B-11	TAG250-800, TAG251-800, TXD10H80M		
BTA23		SCR-D 12A, 200V	B-9	2N6346		
BTA23B	RCA	SCR-D 12A, 200V, 0.025A, 2.5V	B-91	TAG255-200, TAG256-200		
BTA23C	RCA	SCR-D 12A, 300V, 0.025A, 2.5V	B-91	TAG255-300, TAG256-300		
BTA23D	RCA	SCR-D 12A, 400V, 0.025A, 2.5V	B-91	TAG255-400, TAG256-400		
BTA23E	RCA	SCR-D 12A, 500V, 0.025A, 2.5V	B-91	BT138-500, TAG255-500, TAG256-500		
BTA23M	RCA	SCR-D 12A, 600V, 0.025A, 2.5V	B-91	BT138-600, TAG255-600, TAG256-600		
BTA23N		SCR-D 12A, 800V, 0.06A, 0.03A	B-11	BT138-800, TAG255-800, TAG256-800		
BTA25-200	THE	SCR-D 30A, 200V, 0.05A, 3V	B-2	MAC625-4		
BTA25-400	THE	SCR-D 30A, 400V, 0.05A, 3V	B-2	MAC625-6		
BTA25-600	THE	SCR-D 30A, 600V, 0.05A, 3V	B-2	MAC625-8		
BTA25-700	THE	SCR-D 30A, 700V, 0.05A, 3V	B-14	MAC223-10FP		
BTA25-...A	Triac	25A, 200-800V, 0.15A, 0.1A		BTW41/...		
BTA25-...B	Triac	25A, 200-700V, 0.08A, 0.08A		MAC525A-..., TAG725-..., TAG726-...		
BTA26-...A	Triac	25A, 200-800V, 0.15A, 0.1A	B-84	BTA41-...		
BTA26-...B	Triac	25A, 200-800V, 0.1A, 0.08A	B-84	BTA41-...		

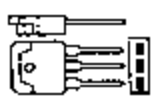
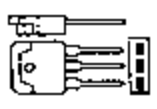
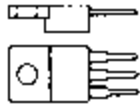
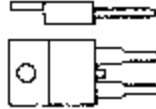
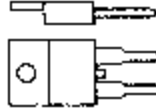
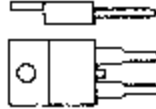
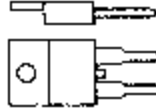
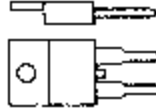
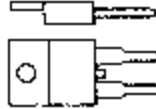
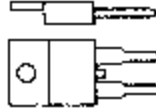
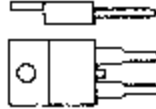
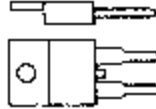
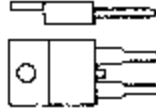
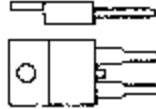

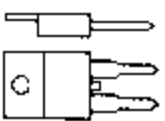
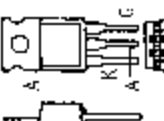

器件型号 Element type	厂名 Manufacturers	材料用途参数 Material Purpose Parameter	图号 Figure	国内外相似替换器件型号 Replace of similar type	备注 Notes	外形参考图 Reference shape
BTA26...AW, BW, CW	Triac	=BTA26...snubberless di/dt	B-84			
BTA40-200	THE	SCR-D 40A, 200V, 0.05A, 2.5V	F-57	T6420B		
BTA40-400	THE	SCR-D 40A, 400V, 0.05A, 2.5V	F-57	T6420D		
BTA40-600	THE	SCR-D 40A, 600V, 0.05A, 2.5V	F-57	T6420M		
BTA40-700	THE	SCR-D 40A, 700V, 0.05A, 2.5V	F-57	T6420N		
BTA40-...A	Triac	40A, 200-800V, 0.15A, 0.1A		BTW41/...		
BTA40-...B	Triac	40A, 200-800V, 0.08A, 0.08A		MAC50A-...		
BTA41-...A	Triac	40A, 200-800V, 0.15A, 0.1A	B-84			
BTA41-...B	Triac	40A, 200-800V, 0.08A, 0.08A	B-84			
BTA140/...	Triac	25A, 500-800V, 0.07A, 0.03A	B-11	MAC223-..., MAC223A-..., TXE10...		
BTA145-500	SCR-D	25A, 500V	B-9			
BTA145-600	SCR-D	25A, 600V	B-9			
BTA145-700	SCR-D	25A, 700V	B-9			
BTA145-800	SCR-D	25A, 800V	B-9			
BTA151-500	SCR-D	12A, 500V	B-26			
BTA151-600	SCR-D	12A, 600V	B-26			
BTA151-700	SCR-D	12A, 700V	B-26			
BTA151-800	SCR-D	12A, 800V	B-26			
BTA152-400	SCR-D	20A, 400V	B-9			
BTA152-600	SCR-D	20A, 600V	B-9			
BTA152-800	SCR-D	20A, 800V	B-9			
BTA216B-600	SCR-D	16A, 600V	B-9			
BTA216B-700	SCR-D	16A, 700V	B-9			

器件型号 Element type	厂名 Manufacturers	材料用途参数 Material Purpose Parameter	图号 Figure	国内外相似替换器件型号 Hcplace of similar type	备注 Notes	外形参考图 Reference shape
BTB04-200A	THE	SCR-D 4A, 200V, 0.01A, 2.5V	B-91	T2506B, T2806B, TAG220-200		 图 B-9
BTB04-200D	THE	SCR-D 4A, 200V, 0.005A, 2.5V	B-91	TIC216B		
BTB04-200S	THE	SCR D 4A, 200V, 0.01A, 2.5V	B-91	TAG221B, TAG232-200		 图 B-91
BTB04-200T	THE	SCR-D 4A, 200V, 0.005A, 2.5V	B-91	TAG222B, TAG233-200		
BTB04-400		LTH 60A, 400V	B-9			
BTB04-400A	THE	SCR-D 4A, 400V, 0.01A, 2.5V	B-91	T2506D, T2806D, TAG220-400		
BTB04-400D	THE	SCR-D 4A, 400V, 0.005A, 2.5V	B-91	TIC216D, TXC18H40, TXC18H40M		
BTB04-400S	THE	SCR-D 4A, 400V, 0.01A, 2.5V	B-91	TAG221-400, TAG232-400, TXC18G40		
BTB04-400T	THE	SCR-D 4A, 400V, 0.005A, 2.5V	B-91	TAG222-400, TAG233-400, TXC18D40		
BTB04-500		LTH 60A, 500V	B-9			
BTB04-600		LTH 60A, 600V	B-9			
BTB04-600A	THE	SCR-D 4A, 600V, 0.01A, 2.5V	B-91	T2506M, T2806M, TAG220-200		
BTB04-600D	THE	SCR-D 4A, 600V, 0.005A, 2.5V	B-91	TIC216M, TXC18H60, TXC18H60M		
BTB04-600S	THE	SCR-D 4A, 600V, 0.01A, 2.5V	B-91	TAG221-600, TAG232-600, TXC18G60		
BTB04-600T	THE	SCR-D 4A, 600V, 0.005A, 2.5V	B-91	TAG222-600, TAG233-600, TXC18D60		
BTB04-700		LTH 60A, 700V	B-9			
BTB04-700A	THE	SCR-D 4A, 700V, 0.01A, 2.5V	B-91	T2506S, T2806S, TAG220-700		
BTB04-700D	THE	SCR-D 4A, 700V, 0.005A, 2.5V	B-91	TIC216S, TXC18H70, TXC18H70M		
BTB04-700S	THE	SCR-D 4A, 700V, 0.01A, 2.5V	B-91	TAG221-700, TAG232-700, TXC18G70		
BTB04-700T	THE	SCR-D 4A, 700V, 0.005A, 2.5V	B-91	TAG222-700, TAG233-700, TXC18D70		
BTB06-200A	THE	SCR-D 6A, 200V, 0.01A, 2.5V	B-91	T2506B, T2806B, T6006B		
BTB06-200B	THE	SCR-D 6A, 200V, 0.05A	B-91	MAC222-4, SC141B, TW7N200FZ		
BTB06-200C	THE	SCR-D 6A, 200V, 0.025A	B-91	MAC222-4, TW7N200FZ		
BTB06-200D	THE	SCR-D 6A, 200V, 0.005A, 2.5V	B-91	TIC216B		
BTB06-200S	THE	SCR-D 6A, 200V, 0.01A, 2.5V	B-91	TAG221-200, TAG226-200		
BTB06-200T	THE	SCR D 6A, 200V, 0.005A, 2.5V	B-91	TAG222-200, TAG227-200		

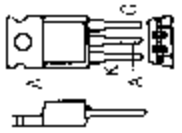
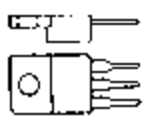

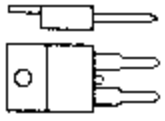
器件型号 Element type	厂名 Manufacturers	材料用途参数 Material Purpose Parameter	图号 Figure	国内外相似替换器件型号 Replace of similar type	备注 Notes	外形参考图 Reference shape
BTB06-400A	THE	SCR-D 6A, 400V, 0.01A, 2.5V	B-91	T2506D, T2806D, T6006D		 图 B-91
BTB06-400B	THE	SCR-D 6A, 400V, 0.05A	B-91	MAC222-6, SC141D, TXC10K/L40M, TW7N400FZ		
BTB06-400C	THE	SCR-D 6A, 400V, 0.025A	B-91	MAC222-6, TXC10K/L40M, TW7N400FZ		
BTB06-400D	THE	SCR-D 6A, 400V, 0.005A, 2.5V	B-91	TIC216D, TXC18H40M		
BTB06-400S	THE	SCR-D 6A, 400V, 0.01A, 2.5V	B-91	TAG221-400, TAG226-400, TXC18G40M		
BTB06-400T	THE	SCR-D 6A, 400V, 0.005A, 2.5V	B-91	TAG222-400, TAG227-400, TXC18D40M		
BTB06-600A	THE	SCR-D 6A, 600V, 0.01A, 2.5V	B-91	T2506M, T2806M, T6006M		
BTB06-600B	THE	SCR-D 6A, 600V, 0.005A, 2.5V	B-91	MAC222-8, TXC10K/L60M, TW7N600FZ		
BTB06-600C	THE	SCR-D 6A, 600V	B-11	MAC222-8, TXC10K/L60M, TW7N600FZ		
BTB06-600D	THE	SCR-D 6A, 600V, 0.005A, 2.5V	B-91	TIC216M, TXC18H60M		
BTB06-600S	THE	SCR-D 6A, 600V, 0.01A, 2.5V	B-91	TAG221-600, TAG22-600, TXC18G60M		
BTB06-600T	THE	SCR-D 6A, 600V, 0.005A, 2.5V	B-91	TAG222-600, TAG227-600, TXC18D60M		
BTB06-700A	THE	SCR-D 6A, 700V, 0.01A, 2.5V	B-91	T2506S, T2806S, T6006S		 图 B-11
BTB06-700B	THE	SCR-D 6A, 700V, 0.05A	B-91	SC141N, MAC222-7, TXC10K/L70M, TW7N700FZ		
BTB06-700C	THE	SCR-D 6A, 700V, 0.025A	B-91	MAC222-7, TXC10K/L70M, TW7N700FZ		
BTB06-700D	THE	SCR-D 6A, 700V, 0.005A, 2.5V	B-91	TIC216S, TXC18H70M		
BTB06-700S	THE	SCR-D 6A, 700V, 0.01A, 2.5V	B-91	TAG221-700, TAG226-700, TXC18G70M		
BTB06-700T	THE	SCR-D 6A, 700V, 0.005A, 2.5V	B-91	TAG222-700, TAG227-700, TXC18D70M		
BTB06-...AW, BW, CW		Triac =B1A06-...AW, BW, CW	B-11			
BTB06-...GP		Triac =BTA06-...GP	B-11	MAC222-..., TW7N..., TXC10K/L...M		
BTB06-...SW, TW		Triac =BTA06-...SW, TW	B-11			
BTB08-200A	THE	SCR-D 8A, 200V, 0.01A, 2.5V	B-91	T2806B, T6006B		
BTB08-200B	THE	SCR-D 8A, 200V, 0.05A, 2.5V	B-9	MAC222-2, TIC226B, T2802B		
BTB08-200C	THE	SCR-D 8A, 200V, 0.025A	B-91	MAC222-2, TIC226B, T2802B		
BTB08-200S	THE	SCR-D 8A, 200V, 0.01A	B-9	MAC228A-2, TAG226-200		
BTB08-400	THE	LTH 80A, 400V	B-9			
BTB08-400A	THE	SCR-D 8A, 400V, 0.01A, 2.5V	B-91	T2806D, T6006D		

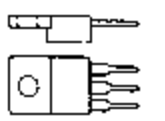
器件型号 Element type	厂名 Manufacturers	材料用途参数 Material Purpose Parameter	图号 Figure	国内外相似替换器件型号 Replace of similar type	备注 Notes	外形参考图 Reference shape
BTB08-400B	THE	SCR-D 8A, 400V, 0.05A, 2.5V	B-9	MCA218A6, MAC222-4, T2802D, TIC226D		 图 B-9
BTB08-400C	THE	SCR-D 8A, 400V, 0.025A	B-91	MAC222-4, T2802D, TIC226D		
BTB08-400S	THE	SCR-D 8A, 400V, 0.01A	B-9	MCA228A6, MAC228A-6, TAG226-400		
BTB08-500		LTH 80A, 500V	B-9			
BTB08-600		LTH 80A, 600V	B-9	T2806M, T6006M		
BTB08-600A	THE	SCR-D 8A, 600V, 0.01A, 2.5V	B-91	MAC222-8, TIC226M, T2802M		
BTB08-600B	THE	SCR-D 8A, 600V, 0.005A, 2.5V	B-91	T2806M, T6006M		
BTB08-600C		SCR-D 8A, 600V	B-11	MAC228A-8, TAG226-600		
BTB08-600S	THE	SCR-D 8A, 600V, 0.01A, 2.5V	B-91			
BTB08-700		LTH* 80A, 700V	B-9			
BTB08-700A	THE	SCR-D 8A, 700V, 0.01A, 2.5V	B-91	T2806S, T6006S		
BTB08-700B	THE	SCR-D 8A, 700V, 0.05A, 2.5V	B-9	MCA218A-9, MAC222-9, T2802S, TIC226S		
BTB08-700C	THE	SCR-D 8A, 700V, 0.025A	B-91	MAC222-9, T2802S, TIC226S		 图 B-91
BTB08-700S	THE	SCR-D 8A, 700V, 0.01A	B-9	MCA228A10, MAC228A-9, TAG226-700		
BTB08-800A		SCR-D 8A, 800V	B-11	T2806N, T6006N		
BTB08-800B		SCR-D 8A, 800V	B-11	MAC222-10, T2802N, TIC226N		
BTB08-800C		SCR-D 8A, 800V	B-11	MAC222-10, T2802N, TIC226N		
BTB08-800S		SCR D 8A, 800V	B-11	MAC228A-10, TAG226-800		
BTB08-...AW, BW, CW		Triac =BTA08-...AW, BW, CW	B-11			
BTB08-...SW, TW		Triac =BTA08-...SW, TW	B-11			
BTB08-...GP		Triac =BTA08-...GP	B-11	BT137/..., MAC222A-..., TAG224-...		 图 B-11
BTB10-...B		Triac =BTA10-...B	B-11	TW9N..., TIC236..., TXD10KL...M		
BTB10-...C		Triac =BTB10-...C	B-11	TAG250-..., TAG251-..., TXD10H...M		
BTB10-...AW, BW, CW		Triac =BTA10-...AW, BW, CW	B-11			
BTB12-...B		Triac =BTA10-...B	B-11	TW9N..., TIC236..., TXD10KL...M		













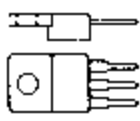



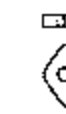
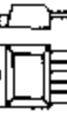
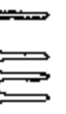
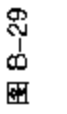

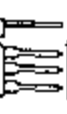
器件型号 Element type	厂名 Manufacturers	材料用途参数 Material Purpose Parameter	图号 Figure	国内外相似替换器件型号 Replace of similar type	备注 Notes	外形参考图 Reference shape
BTB12-...C		Triac =BTA10-...	B-11	TAG250-..., TAG251-..., TXD10H...M		
BTB12-...AW, BW, CW		Triac =BTA10-...AW, BW, CW	B-11			
BTB13-...B		SCR-D =BTA13-...B	B-11	TIC236-..., TW11N-..., 2N6342A, 2N6343A, 2N6344A, 2N6345A		
BTB15-...B		SCR-D 15A, 200-600V, 0.075A, 0.05A	B-11	MAC15-..., T6001...TIC246...		
BTB16-...B		Triac =BTA16-...B	B-11	MAC15-..., T6001..., TIC246...		
BTB16-...C		Triac =BTA16-...C	B-11	MAC15-..., T6001..., TIC246...		
BTB16-...AW, BW, CW		Triac =BTA16-...AW, BW, CW	B-11			
BTB19-200B	THE	SCR-D 20A, 200V, 0.05A, 2.5V	B-91	MAC223-4, MAC223A-4, TXE10L20		
BTB19-400B	THE	SCR-D 20A, 400V, 0.05A, 2.5V	B-91	MAC223-6, MAC223A-6, TXE10L40		
BTB19-600B	THF	SCR-D 20A, 600V, 0.05A, 2.5V	B-91	MAC223-8, MAC223A-8, TXE10L60		
BTB19-700B	THE	SCR-D 20A, 700V, 0.05A, 2.5V	B-91	MAC223-9, MAC223A-9, TXE10L70		
BTB20-...AW, BW, CW		Triac =BTA20-...AW, BW, CW	B-11			
BTB24-200B	THE	SCR-D 25A, 200V, 0.05A, 2.5V	B-91	MAC223-4, MAC223A-4, TXE10L20		
BTB24-400B	THE	SCR-D 25A, 400V, 0.05A, 2.5V	B-91	MAC223-6, MAC223A-6, TXE10L40		
BTB24-600B	THE	SCR-D 25A, 600V, 0.05A, 2.5V	B-91	MAC223-8, MAC223A-8, TXE10L60		
BTB24-700B	THE	SCR-D 25A, 700V, 0.05A, 2.5V	B-91	MAC223-9, MAC223A-9, TXE10L70		
BTB25-200	THE	SCR-D 30A, 200V, 0.05A, 3V	D-33			
BTB25-200A	THE	SCR-D 30A, 200V, 0.1A, 3V	D-33			
BTB25-400	THE	SCR-D 30A, 400V, 0.05A, 3V	D-33			
BTB25-400A	THE	SCR-D 30A, 400V, 0.1A, 3V	D-33			
BTB25-600	THE	SCR-D 30A, 600V, 0.05A, 3V	D-33			
BTB25-600A	THE	SCR-D 30A, 600V, 0.1A, 3V	D-33	BTW41-600		

图 B-11

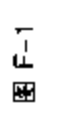
图 B-91

图 D-33

器件型号 Element type	厂名 Manufacturers	材料 Material	用途 Purpose	参数 Parameter	图号 Figure	国内外相似替换器件型号 Replace of similar type	备注 Notes	外形参考图 Reference shape
BTB25-700	THE	SCR-D	30A, 700V, 0.05A, 3V	D-33				
BTB25-700A	THE	SCR-D	30A, 700V, 0.1A, 3V	D-33		BTW41-700		
BTB25-...B		Triac	=BTA25-...B			MAC25-..., MAC50-..., MAC525-...		
BTB26-200A	THE	SCR-D	25A, 200V, 0.1A, 3V	B-29				
BTB26-200B	THE	SCR-D	25A, 200V, 0.05A, 3V	B-29		RTB41-200A		
BTB26-400A	THE	SCR-D	25A, 400V, 0.1A, 3V	B-29				
BTB26-400B	THE	SCR-D	25A, 400V, 0.05A, 3V	B-29		BTB41-400A		
BTB26-600A	THE	SCR-D	25A, 600V, 0.1A, 3V	B-29				
BTB26-600B	THE	SCR-D	25A, 600V, 0.05A, 3V	B-29		BTB41-600A		
BTB26-700A	THE	SCR-D	25A, 700V, 0.1A, 3V	B-29				
BTB26-700B	THE	SCR-D	25A, 700V, 0.05A, 3V	B-29		BTB41-600A		
BTB40-200	THE		40A, 200V, 0.05A,	D-33				
BTB40-200A	THE	SCR-D	40A, 200V, 0.1A,	D-33				
BTB40-400	THE	SCR-D	40A, 400V, 0.05A,	D-33				
BTB40-400A	THE	SCR-D	40A, 400V, 0.1A,	D-33				
BTB40-600	THE	SCR-D	40A, 600V, 0.05A,	D-33		BTW41-600		
BTB40-600A	THE	SCR-D	40A, 600V, 0.1A,	D-33				
BTB40-700	THE	SCR-D	40A, 700V, 0.05A,	D-33		BTW41-700		
BTB40-700A	THE	SCR-D	40A, 700V, 0.1A,	D-33		MAC50-..., TAG740-..., TAG741-...		
BTB40-...B		Triac	=BTA40-...B					
BTB41-200A	THE	SCR-D	40A, 200V, 0.1A, 2.5V	B-29				
BTB41-400A	THE	SCR-D	40A, 400V, 0.1A, 2.5V	B-29				
BTB41-600A	THE	SCR-D	40A, 600V, 0.1A, 2.5V	B-29				
BTB41-...B		Triac	=BTA41-...B	B-84				
BTM4L	TSA		DAC, 2A, 3V, 26V, 5V	F-1				
BTM4M	TSA		DAC, 2A, 3V, 29V, 5V	F-1				
BTM4N	TSA		DAC, 2A, 3V, 34V, 5V	F-1				

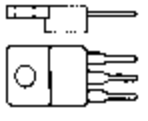

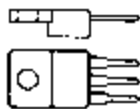
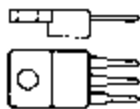
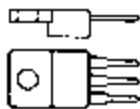
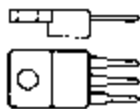



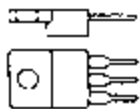
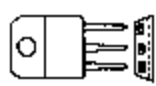
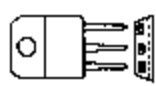
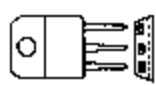
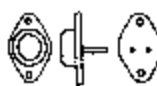
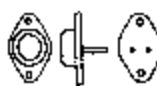



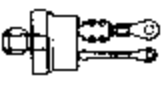

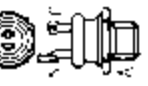



器件型号 Element type	厂名 Manufacturers	材料用途参数 Material Purpose Parameter	图号 Figure	国内外相似替换器件型号 Replace of similar type	备注 Notes	外形参考图 Reference shape
BTD0105	Triac	1A, 50V, 0.025A, 0.025A	B-62	T2303F, T2306F, TAG200-100		 图 B-62
BTD0110	Triac	1A, 100V, 0.025A, 0.025A	B-62	T2303A, T2306A, TAG200-100		
BTD0120	Triac	1A, 200V, 0.025A, 0.025A	B-62	T2303B, T2306B, TAG200-200		
BTD0140	Triac	1A, 400V, 0.025A, 0.025A	B-62	T2303D, T2306D, TAG200-400		
BTD0160	Triac	1A, 600V, 0.025A, 0.025A	B-62	T2303M, T2306M, TAG200-600		
BTD0205-1	Triac	1.6A, 50V, 0.01A, 0.01A	B-62	T2302F, TAG201-100, TAG202-100		
BTD0210-1	Triac	1.6A, 100V, 0.01A, 0.01A	B-62	T2302A, TAG201-100, TAG202-100		
BTD0220-1	Triac	1.6A, 200V, 0.01A, 0.01A	B-62	T2302B, TAG201-200, TAG202-200		
BTD0240-1	Triac	1.6A, 400V, 0.01A, 0.01A	B-62	T2302D, TAG201-400, TAG202-400		
BTD02...-2	Triac	=BTD02...-1: 0.006A, 0.01A	B-62	T2301..., TAG204..., TAG204A...		
BTD02...-3	Triac	=BTD02...-1: 0.003A, 0.01A	B-62	TAG206..., TAG207-...		
BTD0305	Triac	3A, 50V, 0.05A, 0.05A	B-62			 图 B-11
BTD0310	Triac	3A, 100V, 0.05A, 0.05A	B-62			
BTD0320	Triac	3A, 200V, 0.05A, 0.05A	B-62			
BTD0340	Triac	3A, 400V, 0.05A, 0.05A	B-62			
BTD0360	Triac	3A, 600V, 0.05A, 0.05A	B-62			
BTD03...-1	Triac	=BTD03...: 0.01A, 0.015A	B-62	TAG202..., TAG203..., TAG200-...		
BTD03...-2	Triac	=BTD03...: 0.004A, 0.01A	B-62	TAG20-..., TAG205-...		
BTD03...-3	Triac	=BTD03...: 0.003A, 0.005A	B-62	TAG206..., TAG207-...		
BTD0605	Triac	6A, 50V, 0.05A, 0.05A	B-62			
BTD0610	Triac	6A, 100V, 0.05A, 0.05A	B-62			
BTD0620	Triac	6A, 200V, 0.05A, 0.05A	B-62			
BTD0640	Triac	6A, 400V, 0.05A, 0.05A	B-62			
BTD0660	Triac	6A, 600V, 0.05A, 0.05A	B-62			
BTL0405	Triac	4A, 50V, 0.025A, 0.025A	B-11	T2506F, T2806F, TAG220-100		

器件型号 Element type	厂名 Manufacturers	材料用途参数 Material Purpose Parameter	图号 Figure	国内外相似替换器件型号 Replace of similar type	备注 Notes	外形参考图 Reference shape	
BTL0410	Triac	4A, 100V, 0.025A, 0.025A	B-11	T2506A, T2806A, TAG220-100			
BTL0420	Triac	4A, 200V, 0.025A, 0.025A	B-11	T2506B, T2806B, TAG220-200			
BTL0440	Triac	4A, 400V, 0.025A, 0.025A	B-11	T2506D, T2806D, TAG220-400			
BTL0460	Triac	4A, 600V, 0.025A, 0.025A	B-11	T2506M, T2806M, TAG220-600			
BTL0605	Triac	6A, 50V, 0.05A, 0.05A	B-11	MAC222-2, T2802F, TIC226F			
BTL0610	Triac	6A, 100V, 0.05A, 0.05A	B-11	MAC222-3, T2802A, TIC226A			
BTL0620	Triac	6A, 200V, 0.05A, 0.05A	B-11	MAC222-4, T2802B, TIC226B			
BTL0640	Triac	6A, 400V, 0.05A, 0.05A	B-11	MAC222-6, T2802D, TIC226D, TW7N400FZ			
BTL0660	Triac	6A, 600V, 0.05A, 0.05A	B-11	MAC222-8, T2802M, TIC226M, TW7N600FZ			
BTL0805	Triac	8A, 50V, 0.05A, 0.05A	B-11	T2802F, TIC226F			
BTL0810	Triac	8A, 100V, 0.05A, 0.05A	B-11	T2802A, TIC226A			
BTL0820	Triac	8A, 200V, 0.05A, 0.05A	B-11	T2802B, TIC226B			
BTL0840	Triac	8A, 400V, 0.05A, 0.05A	B-11	T2802D, TIC226D, TXD10K/L40			
BTL0860	Triac	8A, 600V, 0.05A, 0.05A	B-11	T2802M, TIC226M, TXD10K/L60			
BTL1005	Triac	10A, 50V, 0.1A, 0.1A	B-11	TIC236F			
BTL1010	Triac	10A, 100V, 0.1A, 0.1A	B-11	TIC236A			
BTL1020	Triac	10A, 200V, 0.1A, 0.1A	B-11	TIC236B			
BTL1040	Triac	10A, 400V, 0.1A, 0.1A	B-11	TW9N400FZ, TIC236D, TXD10K/L40			
BTL1060	Triac	10A, 600V, 0.1A, 0.1A	B-11	TW9N600FZ, TIC236M, TXD10K/L60			
BTL1605	Triac	16A, 50V, 0.1A, 0.1A	B-11	TIC246F			
BTL1610	Triac	16A, 100V, 0.1A, 0.1A	B-11	TIC246A			
BTL1620	Triac	16A, 200V, 0.1A, 0.1A	B-11	MAC15-4, SC151B, TIC246B			
BTL1640	Triac	16A, 400V, 0.1A, 0.1A	B-11	MAC15-6, SC151D, TIC246D			
BTL1660	Triac	16A, 600V, 0.1A, 0.1A	B-11	MAC15-8, SC151M, TIC246M			
BTL0405...0160	Triac	=BTL0405...60	B-11	BTL0405...0460			



器件型号 Element type	厂名 Manufacturers	材料用途参数 Material Purpose Parameter	图号 Figure	国内外相似替换器件型号 Replace of similar type	备注 Notes	外形参考图 Reference shape
BTM0605...0660	Triac	=BTL605...60	B-11	BTL0605...0660		 图 B-11
BTM1005...1060	Triac	=BL1005...1060	B-11	BTL1005...1060		
BTM1605...1660	Triac	=BL1605...1660	B-11	BTL1605...1660		
BTH59-800R		GTO, 10A, 800V, 0.0005A	B-27	BTS59-800R		 图 B-27
BTR59-1300R		GTO, 10A, 1.3kV, 0.0005A	B 27	BTS59-1200R		
BTR0205	Triac	3A, 50V, 0.05A, 0.025A	D-9	TAG260-100, TAG265-100		 图 B-27
BTR0210	Triac	3A, 100V, 0.05A, 0.025A	D-9	TAG260-100, TAG265-100		
BTR0220	Triac	3A, 200V, 0.05A, 0.025A	D-9	TAG260-200, TAG265-200, T4700B		
BTR0240	Triac	3A, 400V, 0.05A, 0.025A	D-9	TAG260-400, TAG265-400, T4700D		
BTR0260	Triac	3A, 600V, 0.05A, 0.025A	D-9	TAG260-600, TAG265-600, T4700M		
BTR0305	Triac	6A, 50V, 0.05A, 0.05A	D-9	TAG260-100, TAG265-100		 图 B-27
BTR0310	Triac	6A, 100V, 0.05A, 0.05A	D-9	TAG260-100, TAG265-100		
BTR0320	Triac	6A, 200V, 0.05A, 0.05A	D-9	TAG260-200, TAG265-200, T4700B		
BTR0340	Triac	6A, 400V, 0.05A, 0.05A	D-9	TAG260-400, TAG265-400, T4700D		
BTR0360	Triac	6A, 600V, 0.05A, 0.05A	D-9	TAG260-600, TAG265-600, T4700M		
BTR0405	Triac	10A, 50V, 0.1A, 0.05A	D-9	TAG265-100		 图 D-9
BTR0410	Triac	10A, 100V, 0.1A, 0.05A	D-9	TAG265-100		
BTR0420	Triac	10A, 200V, 0.1A, 0.05A	D-9	TAG265-200, T4700B		
BTR0440	Triac	10A, 400V, 0.1A, 0.05A	D-9	TAG265-400, T4700D		
BTR0460	Triac	10A, 600V, 0.1A, 0.05A	D-9	TAG265-600, T4700M		
BTR0505	Triac	15A, 50V, 0.08A, 0.05A	D-9			 图 D-9
BTR0510	Triac	15A, 100V, 0.08A, 0.05A	D-9	T4700B		
BTR0520	Triac	15A, 200V, 0.08A, 0.05A	D-9	T4700C		
BTR0530	Triac	15A, 300V, 0.08A, 0.05A	D-9			

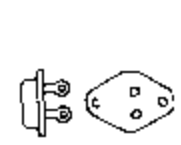
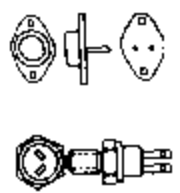
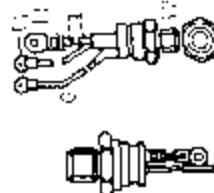

器件型号 Element type	厂名 Manufacturers	材料用途参数 Material Purpose Parameter	图号 Figure	国内外相似替换器件型号 Replace of similar type	备注 Notes	外形参考图 Reference shape
BTR0540	Triac	15A, 400V, 0.08A, 0.05A	D-9	T4700D		<p>图 D-9</p> <p>图 H-22</p> <p>图 B-84</p> <p>图 B-27</p>
BTR0550	Triac	15A, 500V, 0.08A, 0.05A	D-9	T4700E		
BTR0560	Triac	15A, 600V, 0.08A, 0.05A	D-9	T4700M		
BTR0605...0660	Triac	=BTL0605...60	D-9	TAG260 ..., TAG265 ..., T4700...		
BTR1005...1060	Triac	=BTL1005...60	D-9	TAG265..., T4700...		
BTR1605...1660	Triac	=BTL1605...60	D-9	T4700...		
BTR170S01	ASG	SCA 170A, 600V, 0.15A, 3.5V	H-22			
BTR170S02	ASG	SCA 170A, 600V, 0.15A, 3.5V	H-22			
BTR170S03	ASG	SCA 170A, 600V, 0.15A, 3.5V	H-22			
BTR170S04	ASG	SCA 170A, 400V, 0.15A, 3.5V	H-22			
BTR170S05	ASG	SCA 170A, 600V, 0.15A, 3.5V	H-22			
BTR170S06	ASG	SCA 170A, 600V, 0.15A, 3.5V	H-22			
BTR170S07	ASG	SCA 170A, 700V, 0.15A, 3.5V	H-22			
BTR170S08	ASG	SCA 170A, 800V, 0.15A, 3.5V	H-22			
BTR170S09	ASG	SCA 170A, 900V, 0.15A, 3.5V	H-22			
BTR170S10	ASG	SCA 170A, 1.2KV, 0.15A, 3.5V	H-22			
BTR170S11	ASG	SCA 170A, 1.1KV, 0.15A, 3.5V	H-22			
BTR170S13	ASG	SCA 170A, 1.3KV, 0.15A, 3.5V	H-22			
BTR170S14	ASG	SCA 170A, 1.4KV, 0.15A, 3.5V	H-22			
BTR170S15	ASG	SCA 170A, 1.5KV, 0.15A, 3.5V	H-22			
BTS59-850R		GTO, 15A, 850V, 0.3A	B-84			
BTS59-1000R		GTO, 15A, 1KV, 0.03A	B-27			
BTS59-1200R		GTO, 15A, 1.2KV, 0.03A	B-27			
BTV24-600R	APX, MUL	50Hz-Thy 45A, 600V, 0.1A, 2.5V	F-21	T45N600BD		
BTV24-800R	APX, MUL	50Hz Thy 45A, 800V, 0.1A, 2.5V	F 21	T45N800BD		

器件型号 Element type	厂名 Manufacturers	材料用途参数 Material Purpose Parameter	图号 Figure	国内外相似替换器件型号 Replace of similar type	备注 Notes	外形参考图 Reference shape
BTV24-1000R		50Hz-Thy 70A, 1kV, 0.1A, 0.2A	E-7	T35N1000BOC, T45N1000BD		
BTV24-1200R		50Hz-Thy 70A, 1.2kV, 0.1A, 0.2A	E-7	T35N1200BOC, T45N1200BD		
BTV24-1400R		50Hz-Thy 70A, 1.4kV, 0.1A, 0.2A	E-7	T35N1400BOC, T45N1400BD		
BTV34-600G	APX, MUL	SCR-D 55A, 600V, 0.2A, 2.5V	F-21			
BTV34 600H	APX, MUL	SCR-D 55A, 600V, 0.2A, 2.5V	F-21			
BTV34-1200G	APX, MUL	SCR-D 55A, 1.2kV, 0.2A, 2.5V	F-21			
BTV34-1200H	APX, MUL	SCR-D 55A, 1.2kV, 0.2A, 2.5V	F-21			
BTV34-1400G	APX, MUL	Triac 55A, 1.4kV, 0.2A, 2.5V	F-21			
BTV34-1400H	APX, MUL	Triac 55A, 1.4kV, 0.2A, 2.5V	F-21			
BTV58-600R	APX, MUL	10A, 600V, 0.2A, 1.5V	B-9			
BTV58-850R	APX, MUL	10A, 850V, 0.2A, 1.5V	B-9			
BTV58-1000R	APX, MUL	10A, 1kV, 0.2A, 1.5V	B-9			
BTV59-600R	APX, MUL	GTO, 15A, 600V, 0.2A, 1.5V	G-10	BTV70-600R	Thy+Di	
BTV59-850R	APX, MUL	GTO, 15A, 850V, 0.2A, 1.5V	G-10	BTV70-850R	Thy+Di	
BTV59 1000R	APX, MUL	GTO, 15A, 1kV, 0.2A, 1.5V	G-10	BTV70-1000R	Thy+Di	
BTV59-1200R		15A, 1.2kV				
BTV59D/...R		GTO-Thy =BTV59/...R: integr.Di	G-10	BTV70D/...R		
BTV60/...R		GTO-Thy 25A, 0.85~1.2kV, 0.5A	G-10			
BTV60D/...H		GTO-Thy =BTV60/...R: integr.Di	G-10			
BTV70/...R		GTO-Thy 15A, 0.85~1.2kV, 0.3A	G-10			
BTV70D/...R		GTO-Thy =BTV70/...H: integr.Di	G-10			
BTV159/...R		GTO-Thy 15A, 0.85~1.2kV, 0.3A	G-10			
BTV160/...R		GTO-Thy 75A, 0.85~1.2kV, 0.3A	G-10			
BTW10/...		Triac 3A, 50-600V, 0.05A, 0.025A	D-9	BS7-...A, MAC216-..., T4706-..., TXC01-...		
BTW11/...		Triac 6A, 50-600V, 0.05A, 0.05A	D-9	TAG262-..., TAG265-..., TXC01-...		

器件型号 Element type	厂名 Manufacturers	材料用途参数 Material Purpose Parameter	图号 Figure	国内外相似替换器件型号 Replace of similar type	备注 Notes	外形参考图 Reference shape
BTW12/...		Triac =BTW11/...	D-14	BS6...B, BS8...B, TW6N...H, TW10N...H		 图 D-14
BTW13/...		Triac =BTW11/...	F-55	BS6...A, BS8...A, TW6N...C, TW8N...C		
BTW14/...		Triac 10A, 50-600V, 0.1A, 0.05A	D-9	T4700..., T4706..., TAG265-...		
BTW15/...		Triac =BTW14/...	D-14	BS10...B, TW10N...H, SC246...		
BTW16/...		Triac =BTW14/...	F-55	BS10...A, TW10N...C, SC245...		
BTW17/...		Triac =BTW14/...	E-8	BS10...A, TW10N...C, SC245...		
BTW18/...		Triac 15A, 50-600V, 0.1A, 0.1A	D-14	SC251..., SC261..., 2N6157...6159		
BTW19/...		Triac =BTW18/...	F-55	SC250..., TXD98..., TXE99...		
BTW20/...		Triac 25A, 50-600V, 0.1A, 0.1A	F-55	SC260..., T6410..., TXE99...		
BTW21/...		Triac =BTW20/...	D-14	SC261..., T6405..., T6407...		
BTW23-600R	APX, MUL	50Hz-Thy 140A, 600V, 0.15A, 2.5V	F-71	T51N600B, T71N600B, T99N600B		 图 F-55 图 D-9
BTW23-600RM	APX, MUL	50Hz-Thy 140A, 600V, 0.15A, 2.5V	F-71	T51N600B, T71N600B, T99N600B		
BTW23-800R	APX, MUL	50Hz-Thy 140A, 800V, 0.15A, 2.5V	F-71	T51N800B, T71N800B, T99N800B		
BTW23-800RM	APX, MUL	50Hz-Thy 140A, 800V, 0.15A, 2.5V	F-71	T51N800B, T71N800B, T99N800B		
BTW23-1000R	APX, MUL	50Hz-Thy 140A, 1kV, 0.15A, 2.5V	F-71	T51N1000B, T71N1000B, T99N1000B		
BTW23-1000RM	VAL	50Hz-Thy 140A, 1kV, 0.15A, 2.5V	F-71	T51N1000B, T71N1000B, T99N1000B		
BTW23-1200R	APX, MUL	50Hz-Thy 140A, 1.2kV, 0.15A, 2.5V	F-71	T51N1200B, T71N1200B, T99N1200B		
BTW23-1200RM	VAL	50Hz-Thy 140A, 1.2kV, 0.15A, 2.5V	F-71	T51N1200B, T71N1200B, T99N1200B		
BTW23-1600R	APX, MUL	50Hz-Thy 140A, 1.6kV, 0.15A, 2.5V	F-71	T51N1600B, T71N1600B, T99N1600B		
BTW23-1600RM	VAL	50Hz-Thy 140A, 1.6kV, 0.15A, 2.5V	F-71	T51N1600B, T71N1600B, T99N1600B		
BTW23...(RU)		50Hz-Thy 140A, 0.6-1.6kV, 0.15A, 0.2A	E-7	T51N...B, T71N...B, T99N...B		 图 F-71
BTW24-600R	VAL	50Hz-Thy 55A, 600V, 0.1A, 2.5V	F-88	T35N600BOC, T45N600BD		
BTW24-600RM	VAL	50Hz-Thy 55A, 600V, 0.1A, 2.5V	F-88	T35N600BOC, T45N600BD		
BTW24-800R	VAL	50Hz-Thy 55A, 800V, 0.1A, 2.5V	F-88	T35N800BOC, T45N800BD		
BTW24-800RM	VAL	50Hz-Thy 55A, 800V, 0.1A, 2.5V	F-88	T35N800BOC, T45N800BD		
BTW24-1000R	VAL	50Hz-Thy 55A, 1kV, 0.1A, 2.5V	F-88	T35N1000BOC, T45N1000BD		
BTW24-1000RM	VAL	50Hz-Thy 55A, 1kV, 0.1A, 2.5V	F-88	T35N1000BOC, T45N1000BD		
BTW24-1200R	VAL	50Hz-Thy 55A, 1.2kV, 0.1A, 2.5V	F-88	T35N1200BOC, T45N1200BD		
BTW24-1200RM	VAL	50Hz-Thy 55A, 1.2kV, 0.1A, 2.5V	F-88	T35N1200BOC, T45N1200BD		
BTW24-1200R	VAL	50Hz-Thy 55A, 1.2kV, 0.1A, 2.5V	F-88	T35N1200BOC, T45N1200BD		

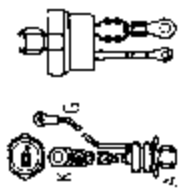
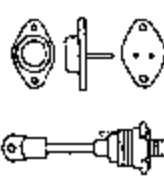
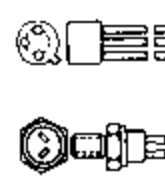
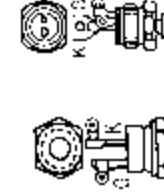

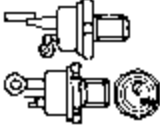
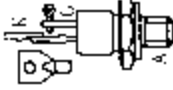
器件型号 Element type	厂名 Manufacturers	材料用途参数 Material Purpose Parameter	图号 Figure	国内外相似替换器件型号 Replace of similar type	备注 Notes	外形参考图 Reference shape
BTW24-1200RM	VAL	50Hz-Thy 55A, 1.2kV, 0.1A, 2.5V	F-88	T35N1200BOC, T45N1200BD		 图 F-88 图 E-7
BTW24-1400R	VAL	50Hz-Thy 55A, 1.4kV, 0.1A, 2.5V	F-88	T35N1400BOC, T45N1400BD		
BTW24-1400RM	VAL	50Hz-Thy 55A, 1.4kV, 0.1A, 2.5V	F-88	T35N1400BOC, T45N1400BD		
BTW24-1600R	VAI	50Hz-Thy 55A, 1.6kV, 0.1A, 2.5V	F-88	T35N1600BOC, T45N1600BD		
BTW24-1600RM	VAL	50Hz-Thy 55A, 1.6kV, 0.1A, 2.5V	F-88	T35N1600BOC, T45N1600BD		
BTW24/...(RU)		50Hz-Thy 55A, 0.6-1.6kV, 0.15A, 0.2A	E-7	T35N..., T45N...		
BTW26/...		Triac 14A, 150-600V, 0.035A, 0.02A	E-1	MAC25A..., MAC525A..., TAG725-...		
BTW27/...R		50Hz-Thy 10A, 100-600V, 0.05A, 0.05A	D-9	BSID10..., TAG675-..., TAG676-...		
BTW27S, SA/...		F-Thy 7A, 100-600V, 0.05A, 0.025A	D-9	T3S ..., TAG670S-..., TAG675S-...		 图 E-1 图 D-9
BTW28(A)/...R		F-Thy 35A, 300-800V, 0.15A, 0.045A	F-55	BTW63/..., CS15.9, TAG35S-...		
BTW30/...(RM, RU)		SCR-H 24A, 0.3-1.2kV, 0.2A, 0.2A	F-55	BTW31/...		
BTW30/...RS		SCR-H 24A, 0.3-1.2kV, 0.2A, 0.2A	F-55	BTW31/...		
BTW32/...(RM, RU)		SCR-H 55A, 300, 1.2kV, 0.15A, 0.2A	E-7	CSF34-..., T31F...		 图 F-55 图 B-62
BTW33/...(RM, RU)		SCR-H 110A, 300, 1.2kV, 0.15A, 0.2A	E-7	CS38-..., CS78-..., CS79-..., T71F300-...		
BTW34/...(M, G, H, U)		Triac 55A, 0.6-1.6kV, 0.2A, 0.2A	E-7			
BTW35		50Hz-Thy 15A, 500V, 0.01A	F-55			
BTW36/...RM		50Hz-Thy 31A, 200-600V, 0.06A				
BTW37(V)/...		Triac 12A, 0.4-1.2kV, 0.0001A	B-62	BTW43/...		
BTW38-600R	APX, MUL	50Hz-Thy 16A, 600V, 0.05A, 1.5V	F-50	BTW42-600R, BSIC0340, BSID0340, CS5-06		
BTW38-800R	APX, MUL	50Hz-Thy 16A, 800V, 0.05A, 1.5V	F-50	BTW42-800R, BSIC0353, BSID0353, CS5-08		
BTW38-1000R	APX, MUL	50Hz-Thy 16A, 1kV, 0.05A, 1.5V	F-50	BTW42-1000R, BSIC0366, BSID0366, CS5-10		
BTW38-1200R	APX, MUL	50Hz-Thy 16A, 1.2kV, 0.05A, 1.5V	F-50	BTW42-1200R, BSIC0380, BSID0380, CS5-12		
BTW39-50		25A, 50V, 0.08A, 0.02A	F-57	MCR230F, T15.1N100COB		 图 F-50 图 F-57
BTW39-100	THE	25A, 100V, 0.08A, 3V	F-57	ECG5522, MCR230A, T15.1N100COB		
BTW39-200	THE	25A, 200V, 0.08A, 3V	F-57	BTW47-200, ECG5524, MCR230B, T15.1N200COB		

器件型号 Element type	厂名 Manufacturers	材料用途参数 Material Purpose Parameter	图号 Figure	国内外相似替换器件型号 Replace of similar type	备注 Notes	外形参考图 Reference shape
BTW39-300	THE	25A, 300V, 0.08A, 3V	F-57	BTW45-400R, BTW47-400, ECG5527, MCR230D, T15.1N300COB		 图 F-57
BTW39-400	THE	25A, 400V, 0.08A, 3V	F-57	BTW45-400R, BTW47-400, ECG5527, MCR230D, TAG16N400DU, T15.1N400COB		
BTW39-500	THE	25A, 500V, 0.08A, 3V	F-57	BTW45-600R, BTW47-600, ECG5529, MCR230M, TAG16N500DU, T15.1N500COB		
BTW39-600	THE	25A, 600V, 0.08A, 3V	F-57	BTW45-600H, BTW47-600, ECG5529, MCR230M, TAG16N600DU, T15.1N600COB		
BTW39-700	THE	25A, 700V, 0.08A, 3V	F-48	ECG5531, BTW45-800R, BTW47-800, SK6631, SK5531, T15.1N700COB		
BTW39-800	THE	25A, 800V, 0.08A, 3V	F-48	BTW45-800R, BTW47-800, ECG5531, SK6631, SK5531, TAG16N800DU, T15.1N800COB		 图 F-48
BTW39-900	THE	25A, 900V, 0.08A, 3V	F-48	BTW45-900R, BTW47-900, SK6632, T15.1N900COB		
BTW39-1000	THE	25A, 1kV, 0.08A, 3V	F-48	BTW45-1000R, BTW47-1000, SK6632, TAG16N1000LU, T15.1N1000COB		
BTW39-1100	THE	25A, 1.1kV, 0.08A, 3V	F-48	BTW45-1100R, BTW47-1100, TAG16N1100LU, T15.1N1100COB		
BTW39-1200	THE	25A, 1.2kV, 0.08A, 3V	F-48	BTW45-1200R, BTW47-1200, TAG16N1200LU, T15.1N1200COB		
BTW40-400R	APX, MUL	50Hz-Thy 20A, 400V, 0.075A, 1.5V	E-4	BTW47-400R, T15.1N400COB, TAG16N400, TAG19N400DM		 图 E-4
BTW40-400RU		32A, 400V	E-4			
BTW40-600R	APX, MUL	50Hz-Thy 20A, 600V, 0.075A, 1.5V	E-4	BTW47-600R, T15.1N600COB, TAG16N600, TAG19N600DM		
BTW40-600RU		32A, 600V	E-4			
BTW40-800R	APX, MUL	50Hz-Thy 20A, 800V, 0.075A, 1.5V	E-4	BTW47-800R, T15.1N800COB, TAG16N800		
BTW40-800RU		32A, 800V	E-4			
BTW41/...(G, H)		Triac 40A, 400-800V, 0.15A, 0.05V				 图 E-4











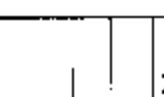

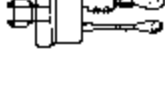

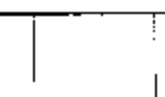

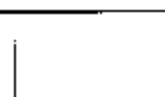
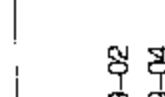



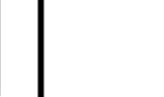
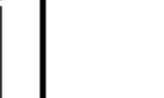

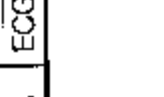
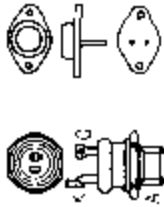





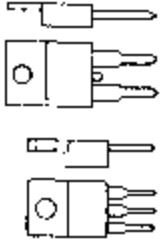
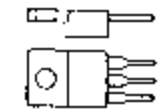
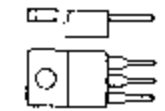
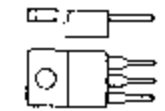
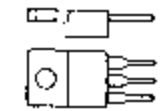
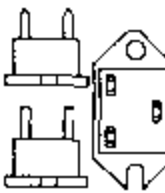

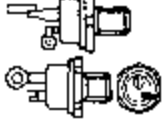
器件型号 Element type	厂名 Manufacturers	材料用途参数 Material Purpose Parameter	图号 Figure	国内外相似替换器件型号 Replace of similar type	备注 Notes	外形参考图 Reference shape
BTW42-600R	APX, MUL	50Hz-Thy 16A, 600V, 0.05A, 1.5V	E-3	TAG9N600DM		
BTW42-800R	APX, MUL	50Hz-Thy 16A, 800V, 0.05A, 1.5V	E-3	TAG9N800DM		
BTW42-1000R	APX, MUL	50Hz-Thy 16A, 1kV, 0.05A, 1.5V	E-3	TAG9N1000DM		
BTW42-1200R	APX, MUL	50Hz-Thy 16A, 1.2kV, 0.05A, 1.5V	F-50			
BTW43...(G, H)	APX, MUL	15A, 600V, 1.2kV, 0.2A, 0.1V	F-50			
BTW44...(M, U)		SCR-D 23A, 100-600V, 0.2A, 0.2A	E-7			
BTW45-400R	APX, MUL	50Hz-Thy 25A, 400V, 0.075A, 1.5V	F-21	BTW47-400, T15.1N400COB, TAG14N400DM		
BTW45-400RU		16A, 400V	F-22			
BTW45-600R	APX, MUL	50Hz-Thy 25A, 600V, 0.075A, 1.5V	F-21	BTW47-600, T15.1N600COB, TAG14N400DM		
BTW45-600RU		16A, 600V	F-22			
BTW45-800R	APX, MUL	50Hz-Thy 25A, 800V, 0.075A, 1.5V	F-21	BTW47-800, T15.1N800COB		
BTW45-800RU		16A, 800V	F-22			
BTW45-1000R	APX, MUL	50Hz-Thy 25A, 1kV, 0.075A, 1.5V	F-21	BTW47-1000, T15.1N1000COB		
BTW45-1000RU		16A, 1kV	F-22			
BTW45-1200R	APX, MUL	50Hz-Thy 25A, 1.2kV, 0.075A, 1.5V	E-4	BTW47-1200, T15.1N1200COB		
BTW45-1200RU		16A, 1.2kV	E-4			
BTW46-200R		50Hz-Thy 25A, 200V, 0.06A, 0.04A				
BTW46-400R		50Hz-Thy 25A, 400V, 0.06A, 0.04A				
BTW46-600R		50Hz-Thy 25A, 600V, 0.06A, 0.04A				
BTW47...(RM, RU)		50Hz-Thy 25A, 200, 1.6kV, 0.1A, 0.2A	F-55	BTW39..., BTW47..., C513..., TAG16N...		
BTW48...	THO	50Hz-Thy 50A, 0.2-1.2kV, 0.06A, 3V	F-55	CS23...		
BTW48...	PHI	SCR-D 25A, 0.2-1.2kV, 0.15A, 3V	F-55	BTX94...		
BTW49-50	THE	SCR-H 15A, 50V, 0.2A, 3V	F-48			
BTW49-100	THE	SCR-H 15A, 100V, 0.2A, 3V	F-48	BTW30-100, BTW31-100		
BTW49-200	THE	SCR-H 15A, 200V, 0.2A, 3V	F-48	BTW30-200, BTW31-200, CS15.9-02		
BTW49-400	THE	SCR-H 15A, 400V, 0.2A, 3V	F-48	BTW30-400, BTW31-400, CS15.9-04		
BTW49-600	THE	SCR-H 15A, 600V, 0.2A, 3V	F-48	BTW30-600, BTW31-600, CS15.9-06		
BTW49-800	THE	SCR-H 15A, 800V, 0.2A, 3V	F-48	BTW30-800, BTW31-800, CS15.9-08		
BTW50-100	THE	50Hz-Thy 63A, 100V, 0.15A, 3V	F-21	ECG5567		

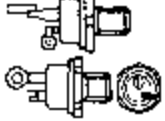
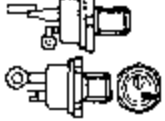
图 F-55 图 F-48









图 F-22 图 L-4



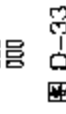
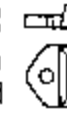
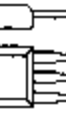
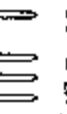
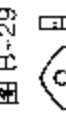
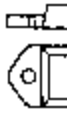
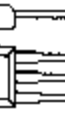
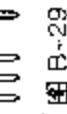
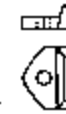

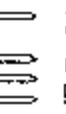

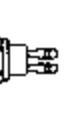
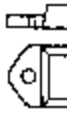
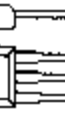
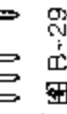
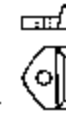
图 L-7 图 F-21

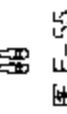
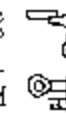
图 E-3 图 F-50

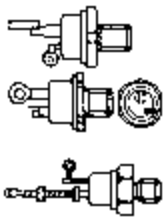
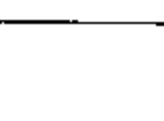

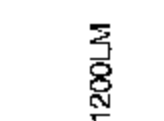
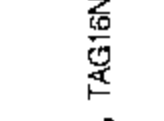

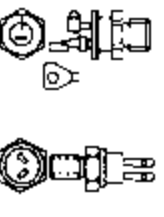
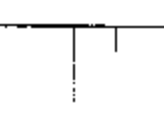
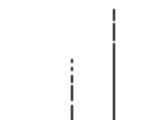
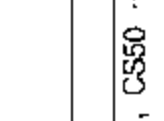
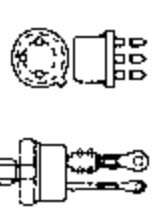
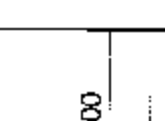
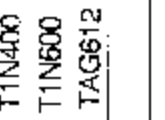
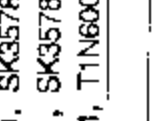
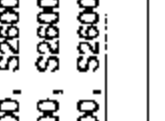

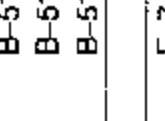
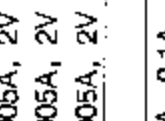
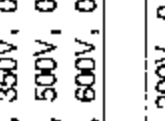
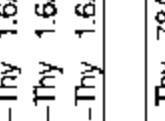



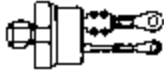

器件型号 Element type	厂名 Manufacturers	材料用途参数 Material Purpose Parameter	图号 Figure	国内外相似替换器件型号 Replace of similar type	备注 Notes	外形参考图 Reference shape
BTW50-200	THE	50Hz-Thy 63A, 200V, 0.15A, 3V	F-21	ECG5567		
BTW50-400	THE	50Hz-Thy 63A, 400V, 0.15A, 3V	F-21	ECG5568		
BTW50-600	THE	50Hz-Thy 63A, 600V, 0.15A, 3V	F-21	ECG5568		
BTW50-800	THE	50Hz-Thy 63A, 800V, 0.15A, 3V	F-21	ECG5569		
BTW50-1000	THE	50Hz-Thy 63A, 1kV, 0.15A, 3V	F-21	ECG5569		
BTW50-1200	THE	50Hz-Thy 63A, 1.2kV, 0.15A, 3V	F-21	ECG5569		
BTW52		8A, 60V, 0.02A, 0.025A	D-9	BSIC0506, TAG671-100, TAG676-100		
BTW53		8A, 120V, 0.02A, 0.025A	D-9	BSIC0513, TAG671-200, TAG676-200		
BTW54		8A, 240V, 0.02A, 0.025A	D-9	BSIC0526, TAG671-300, TAG676-300		
BTW55		8A, 480V, 0.02A, 0.025A	D-9	BSIC0533, TAG671-500, TAG676-500		
BTW56		8A, 600V, 0.02A, 0.025A	D-9	BSIC0540, TAG671-600, TAG676-600		
BTW58-1000		GTO, 7.5A, 1kV, 0.2A	B-11			
BTW58-1300		GTO, 7.5A, 1.3kV, 0.2A	B-11			
BTW58-1500		GTO, 7.5A, 1.5kV, 0.2A	B-11			
BTW58-1000R	APX, MJL	6.5A, 1kV, 0.2A, 1.5V	B-9			
BTW58-1300R	APX, MJL	6.5A, 1.3kV, 0.2A, 1.5V	B-9			
BTW58-1500R	APX, MJL	6.5A, 1.5kV, 0.2A, 1.5V	B-9			
BTW59-1300R	APX, MJL	GTO, 13A, 1.3kV, 0.3A, 1.5V	G-10			
BTW59-1500R	APX, MJL	GTO, 13A, 1.5kV, 0.3A, 1.5V	G-10			
BTW62/...RK	SCR-H	28A, 0.6-1kV, 0.25A, 0.4A	G-10			
BTW62/...RN	SCR-H	=BTW62/...RK; 9 μs	G-10			
BTW62D/...	F-Thy+Di	=BTW62/...RK; integr.Di	G 10			
BTW63-600R	APX, MJL	25A, 600V, 0.25A, 2V	F-48			
BTW63/...RK	SCR-H	25A, 600-800V, 0.25A, 0.4A	F-22	BTW28..., CS15.9..., TAG35S...		
BTW63/...RN	SCR-H	25A, 600-800V, 0.25A, 0.4A	F-22	BTW28..., CS15.9..., TAG35S...		
BTW63/...RP	SCR-H	25A, 600-800V, 0.25A, 0.4A	F-22	BTW28..., CS15.9..., TAG35S...		



器件型号 Element type	厂名 Manufacturers	材料用途参数 Material Purpose Parameter	图号 Figure	国内外相似替换器件型号 Replace of similar type	备注 Notes	外形参考图 Reference shape
BTW66-200	THE	50Hz-Thy 25A, 200V, 0.05A, 3V	D-33	BTW67-200		
BTW66-400	THE	50Hz-Thy 25A, 400V, 0.05A, 3V	D-33	BTW67-400		
BTW66-600	THE	50Hz-Thy 25A, 600V, 0.05A, 3V	D-33	BTW67-600		
BTW66-800	THE	50Hz-Thy 25A, 800V, 0.05A, 3V	D-33	BTW67-800		
BTW66-1000	THE	50Hz-Thy 25A, 1kV, 0.05A, 3V	D-33	BTW67-1000		
BTW66-1200		50Hz-Thy 25A, 1.2kV, 0.05A, 0.02A		BTW67-1200		
BTW66/...N		50Hz-Thy =BTW66/...		BTW67/...		
BTW67-200	THF	50Hz-Thy 25A, 200V, 0.08A, 3V	D-33			
BTW67-200N#	THE	50Hz-Thy 40A, 200V, 0.08A, 3V	D-33			
BTW67-400	THE	50Hz-Thy 25A, 400V, 0.08A, 3V	D-33			
BTW67-400N#	THE	50Hz-Thy 40A, 400V, 0.08A, 3V	D-33			
BTW67-600	THE	50Hz-Thy 25A, 600V, 0.08A, 3V	D-33			
BTW67-800	THE	50Hz-Thy 25A, 800V, 0.08A, 3V	D-33			
BTW67-1000	IHE	50Hz-Thy 25A, 1kV, 0.08A, 3V	D-33			
BTW67-1200		50Hz-Thy 25A, 1.2kV, 0.08A, 3V				
BTW67/...N		50Hz-Thy =BTW67/...				
BTW68/...	THE	50Hz-Thy 25A, 0.2~1.2kV, 0.05A, 0.02V	B-29	BTW69...		
BTW68/...N		50Hz-Thy =BTW68/...	B-84	BTW69/...N		
BTW69/...	THF	50Hz-Thy 40A, 0.2~1.2kV, 0.08A, 0.15V	B-29			
BTW69/...N		50Hz-Thy =BTW69/...	B-84			
BTW92-200R, RM, RU		31A, 200V, 0.1A, 0.2A	F-55	CS23-10		
BTW92-400R, RM, HU		31A, 400V, 0.1A, 0.2A	F-55	CS23-10		
BTW92-600R, RM, RU		31A, 600V, 0.1A, 0.2A	F-55	CS23-10		
BTW92-800R	APX, MJL	20A, 800V, 0.1A, 3.5V	F-48	CS23-10		

器件型号 Element type	厂名 Manufacturers	材料用途参数 Material Purpose Parameter	图号 Figure	国内外相似替换器件型号 Replace of similar type	备注 Notes	外形参考图 Reference shape
BTW92-800RM, RU	RTC, VAL	31A, 800V, 0.1A, 3.5V 50Hz-Thy	E-6	CS23 10, TAG16N-800LM, TAG16N 800LU		 图 E-6 图 F-48
BTW92-1000R	MUL, PHI	20A, 1kV, 0.1A, 3.5V	F-48	CS23-10		
BTW92-1000RM	RTC, VAL	31A, 1kV, 0.1A, 3.5V	E-6	CS23-10, TAG16N-1000LM		
BTW92-1000RU		31A, 1kV, 0.1A, 0.2A	F-55	CS23-10		
BTW92-1200R	MUL, PHI	20A, 1.2kV, 0.1A, 3.5V	F-48	CS23-12		
BTW92-1200RM	RTC, VAL	31A, 1.2kV, 0.1A, 3.5V	E-6	CS23-12, TAG16N-1200LM		
BTW92-1200RU		31A, 1.2kV, 0.1A, 0.2A	F-55			
BTW92-1400R	APX, MUL	20A, 1.4kV, 0.1A, 3.5V	F-8			
BTW92-1400RM		31A, 1.4kV, 0.1A, 0.2A	F-55			
BTW92-1400RU	MUL, PHI	31A, 1.4kV, 0.1A, 3.5V	E-6	TAG16N-1400LU		
BTW92-1600R	APX, MUL	20A, 1.6kV, 0.1A, 3.5V	F-48			
BTW92-1600RM, RU	RTC, VAL	31A, 1.6kV, 0.1A, 3.5V 50Hz-Thy	E-6			
BTX12/...R		20A, 100-700V, 0.05A, 0.04A	E-7	BIX13...R, CS42...*, CS50 ...		
BTX13/...R		48A, 100-700V, 0.05A, 0.04A	E-7	CS42...*, CS50...*		
BTX18-100	MUL, PHI	1.6A, 120V, 0.005A, 2V	B-51	BTX30-100, S2600B, SK3577, T1N200		
BTX18-200	MUL, PHI	1.6A, 240V, 0.005A, 2V	B-51	BTX30-200, S2600C, SK3577, T1N400		
BTX18-300	MUL, PHI	1.6A, 350V, 0.005A, 2V	B-51	BTX30-300, S2600D, SK3578, T1N400		
BTX18-400	MUL, PHI	1.6A, 500V, 0.005A, 2V	B-51	BTX30-400, S2600E, SK3578, T1N600		
BTX18-500	MUL, PHI	1.6A, 600V, 0.005A, 2V	B-51	BTX30-500, S2600M, T1N600, TAG612 600		
BTX20		78A, 200V, 0.1A, 0.1A	E-7			
BTX21		78A, 300V, 0.1A, 0.1	E-7			
BTX22		78A, 400V, 0.1A, 0.1A	E-7			
BTX23		78A, 500V, 0.1A, 0.1A	E-7			
BTX24		78A, 600V, 0.1A, 0.1A	E-7			



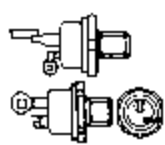
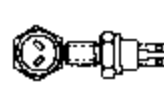

器件型号 Element type	厂名 Manufacturers	材料用途参数 Material Purpose Parameter	图号 Figure	国内外相似替换器件型号 Replace of similar type	备注 Notes	外形参考图 Reference shape
BTX25		50Hz-Thy 78A, 700V, 0.1A, 0.1A	E-7			
BTX26		50Hz-Thy 78A, 800V, 0.1A, 0.1A	E-7			
BTX29/...R		50Hz-Thy 78A, 200, 1.8kV, 0.1A	E-7	CS70-...		
BTX30/...		50Hz-Thy 1.6A, 50-600V, 0.01A, 0.025A	B-62	S2600..., T1N..., TAG612..., TAG613-...		
BTX31/...R		50Hz-Thy 7A, 0.05-1kV, 0.015A, 0.015A	F-55	T10N...C		
BTX31-100	TAG	7.5A, 100V, 0.015A, 3V	F-48			
BTX31-200	TAG	7.5A, 200V, 0.015A, 3V	F-48			
BTX31-400	TAG	7.5A, 400V, 0.015A, 3V	F-48			
BTX31-500	TAG	7.5A, 500V, 0.015A, 3V	F-48			
BTX31-600	TAG	7.5A, 600V, 0.015A, 3V	F-48			
BTX31-700	TAG	7.5A, 700V, 0.015A, 3V	F-48			
BTX31-800	TAG	7.5A, 800V, 0.015A, 3V	F-48			
BTX31-900	TAG	7.5A, 900V, 0.015A, 3V	F-48			
BTX31-1000	TAG	7.5A, 1kV, 0.015A, 3V	F-48			
BTX31S/...R		SCR-H =BTX33/...R: 2μs	F-55	TAG15S-..., T12F...		
BTX31S100	TAG	7.5A, 100V, 0.015A, 3V	F-48			
BTX31S200	TAG	7.5A, 200V, 0.015A, 3V	F-48			
BTX31S400	TAG	7.5A, 400V, 0.015A, 3V	F-48			
BTX31S500	TAG	7.5A, 500V, 0.015A, 3V	F-48			
BTX31S600	TAG	7.5A, 600V, 0.015A, 3V	F-48			
BTX31S700	TAG	7.5A, 700V, 0.015A, 3V	F-48			
BTX31S800	TAG	7.5A, 800V, 0.015A, 3V	F-48			
BTX31S900	TAG	7.5A, 900V, 0.015A, 3V	F-48			
BTX31S1000	TAG	7.5A, 1kV, 0.015A, 3V	F-48			
BTX32/...R		50Hz-Thy 10A, 0.05-1kV, 0.025A, 0.025A	F-55	T10N...C, T12N..., 2N5204, 2N5205, 2N5206		
BTX32/...S		SCR-H =BTX32/...: 12μs	F-55	TAG15S-..., T12F...		
BTX32-100	TAG	10A, 100V, 0.025A, 3V	F-48			
BTX32-200	TAG	10A, 200V, 0.025A, 3V	F-48			

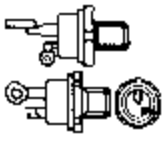
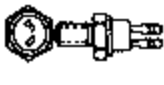

器件型号 Element type	厂名 Manufacturers	材料用途参数 Material Purpose Parameter	图号 Figure	国内外相似替换器件型号 Replace of similar type	备注 Notes	外形参考图 Reference shape
BTX32-400	TAG	10A, 400V, 0.025A, 3V	F-48			 图 F-48
BTX32-500	TAG	10A, 500V, 0.025A, 3V	F-48			
BTX32-600	TAG	10A, 600V, 0.025A, 3V	F-48			
BTX32-700	TAG	10A, 700V, 0.025A, 3V	F-48			
BTX32-800	TAG	10A, 800V, 0.025A, 3V	F-48			
BTX32-900	TAG	10A, 900V, 0.025A, 3V	F-48			
BTX32-1000	TAG	10A, 1kV, 0.025A, 3V	F-48			
BTX32S100	TAG	10A, 100V, 0.025A, 3V	F-48			
BTX32S200	TAG	10A, 200V, 0.025A, 3V	F-48			
BTX32S400	TAG	10A, 400V, 0.025A, 3V	F-48			
BTX32S500	TAG	10A, 500V, 0.025A, 3V	F-48			
BTX32S600	TAG	10A, 600V, 0.025A, 3V	F-48			
BTX32S700	TAG	10A, 700V, 0.025A, 3V	F-48			
BTX32S800	TAG	10A, 800V, 0.025A, 3V	F-48			
BTX32S900	TAG	10A, 900V, 0.025A, 3V	F-48			
BTX32S1000	TAG	10A, 1kV, 0.025A, 3V	F-48			
BTX33/...R		50Hz-Thy 20A, 0.05-1kV, 0.05A, 0.05A	F-55	BTW39/..., CS13..., TAG15..., TAG14N...		 图 F-55
BTX33/...S		SCR-H =BTX33/...; 12μs	F-55	T12F...		
BTX33-100	TAG	20A, 100V, 0.05A, 3V	F-48			
BTX33-200	TAG	20A, 200V, 0.05A, 3V	F-48			
BTX33-400	TAG	20A, 400V, 0.05A, 3V	F-48	S6210D, TAG14N400DM		
BTX33-500	TAG	20A, 500V, 0.05A, 3V	F-48	S6210M, TAG14N600SM		
BTX33-600	TAG	20A, 600V, 0.05A, 3V	F-48	TAG14N800DM		
BTX33-700	TAG	20A, 700V, 0.05A, 3V	F-48	TAG14N1000DM		
BTX33-800	TAG	20A, 800V, 0.05A, 3V	F-48			
BTX33-900	TAG	20A, 900V, 0.05A, 3V	F-48			
BTX33-1000	TAG	20A, 1kV, 0.05A, 3V	F-48			
BTX33S100	TAG	20A, 100V, 0.05A, 3V	F-48			
BTX33S200	TAG	20A, 200V, 0.05A, 3V	F-48			

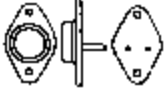

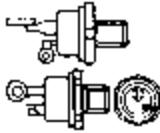

器件型号 Element type	厂名 Manufacturers	材料用途参数 Material Purpose Parameter	图号 Figure	国内外相似替换器件型号 Replace of similar type	备注 Notes	外形参考图 Reference shape
BTX33S400	TAG	20A, 400V, 0.05A, 3V	F-48	TAG12F400DUGC		 图 F-48
BTX33S500	TAG	20A, 500V, 0.05A, 3V	F-48	TAG12F500DUGC		
BTX33S600	TAG	20A, 600V, 0.05A, 3V	F-48	TAG12F600DUGC		
BTX33S700	TAG	20A, 700V, 0.05A, 3V	F-48	TAG12F700DUGC		
BTX33S800	TAG	20A, 800V, 0.05A, 3V	F-48	TAG12F800DUGC		
BTX33S900	TAG	20A, 900V, 0.05A, 3V	F-48			
BTX33S1000	TAG	20A, 1kV, 0.05A, 3V	F-48	TAG12F1000DUGC		
BTX35/...R BTX36/...R		50Hz-Thy 8.2A, 500-800V, 0.06A, 0.01A 50Hz-Thy 11A, 500-800V, 0.04A, 0.01A	F-55 F-55	BSIE41... BTW39... TAG14N... T12N... 2N681...692, 2N5204, 2N5205, 2N5206, 2N5207		
BTX37/...R BTX38/...R		50Hz-Thy 32A, 500-800V, 0.08A, 0.01A 50Hz-Thy 62A, 500-800V, 0.07A, 0.01A	E-7 E-7	CS42... CS50... CS70... CS42... CS50... CS70...		
BTX41/...R		50Hz-Thy 175A, 0.2-1.8kV, 0.3A, 0.3A	E-7	BSIN35/... BSIP35/... BSIP36/...		 图 F-55
BTX44/...R BTX45/...R BTX46/...R BTX47-1000R BTX47-1200R BTX47-1400R BTX48-1000R BTX48-1200R BTX48-1400R BTX49/...R BTX50/...R BTX51/...R BTX52		50Hz-Thy 55A, 0.2-1.8kV, 0.1A, 0.1A 50Hz-Thy 110A, 0.2-1.8kV, 0.1A, 0.1A 50Hz-Thy 150A, 0.2-1.8kV, 0.3A, 0.3A 50Hz-Thy 11A, 1kV, 0.065A, 0.01A 50Hz-Thy 11A, 1.2kV, 0.065A, 0.01A 50Hz-Thy 11A, 1.4kV, 0.065A, 0.01A 50Hz-Thy 16A, 1kV, 0.065A, 0.01A 50Hz-Thy 16A, 1.2kV, 0.065A, 0.01A 50Hz-Thy 16A, 1.4kV, 0.065A, 0.01A 50Hz-Thy 60A, 0.6-1.4kV, 0.1A 50Hz-Thy 70A, 0.6-1.4kV, 0.1A, 0.15A 50Hz-Thy 70A, 500-800V, 0.07A, 0.01A 50Hz-Thy 8A, 100V, 0.0002A, 0.0025A	E-7 E-7 E-7 F-55 F-55 F-55 F-55 F-55 F-55 E-7 E-7 E-7 D-10	CS50... CS70... CS50... CS70... BSIN35/... BSIP35/... RSIP36/... BTW47-1000, BTW92-1000, TAG16N1000BOC BTW47-1200, BTW92-1200, TAG16N1200BOC BTW47-1400, BTW92-1400, TAG16N1400BOC BTW47-1000, BTW92-1000, TAG16N1000BOC BTW47-1200, BTW92-1200, TAG16N1200BOC BTW47-1400, BTW92-1400, TAG16N1400BOC CS42... CS50... CS70... CS42... CS50... CS70...		

器件型号 Element type	厂名 Manufacturers	材料用途参数 Material Purpose Parameter	图号 Figure	国内外相似替换器件型号 Repace of similar type	备注 Notes	外形参考图 Reference shape
BTX53		50Hz-Thy 8A, 200V, 0.0002A, 0.0025A	D-10			 图 D-10
BTX54		50Hz-Thy 8A, 300V, 0.0002A, 0.0025A	D-10			
BTX55		50Hz-Thy 8A, 400V, 0.0002A, 0.0025A	D-10			
BTX57		50Hz-Thy 8A, 100V, 0.015A, 0.0025A	D-10			
BTX58		50Hz-Thy 8A, 200V, 0.015A, 0.0025A	D-10			
BTX59		50Hz-Thy 8A, 300V, 0.015A, 0.0025A	D-10			
BTX60		50Hz-Thy 8A, 400V, 0.015A, 0.0025A	D-10			
BTX64/...R		SCR H 8.5A, 100-600V, 0.065A, 0.01A	F-55	C234..., MCR1718-..., TAG12F...		
BTX66/...R		SCR-H 32A, 100-600V, 0.08A, 0.01A	E-7	BSIH34..., BSIH37..., BSIL37...		 图 F-55
BTX67/...R		SCR-H 62A, 100-600V, 0.08A, 0.01A	E-7	BSIH34..., BSIL34..., BSIL37...		
BTX68/...R		50Hz-Thy 6.4A, 0.5-1kV, 0.03A, 0.01A	F-55	BSIC03..., BSID03..., CS5-..., CS8-...		
BTX70/...R		50Hz-Thy 15A, 0.05-1kV, 0.05A, 0.05A	F-55	BTW39/..., BTW45/..., TAG9N..., TAG15-...		 图 E-7
BTX70/...S		SCR-H =BTX70/...; 12μs	F-55	T12F..., TAG15S...		
BTX70-100	TAG	15A, 100V, 0.05A, 3V	F-48			
BTX70-200	TAG	15A, 200V, 0.05A, 3V	F-48			
BTX70-400	TAG	15A, 400V, 0.05A, 3V	F-48	S6210D, TAG9N400DM		
BTX70-500	TAG	15A, 500V, 0.05A, 3V	F-48			
BTX70-600	TAG	15A, 600V, 0.05A, 3V	F-48	S6210M, TAG9N600DM		
BTX70-700	TAG	15A, 700V, 0.05A, 3V	F-48			
BTX70-800	TAG	15A, 800V, 0.05A, 3V	F-48	TAG9N800DM		
BTX70-900	TAG	15A, 900V, 0.05A, 3V	F-48			
BTX70-1000	TAG	15A, 1kV, 0.05A, 3V	F-48	TAG9N1000DM		
BTX70S100	TAG	15A, 100V, 0.05A, 3V	F-48			
BTX70S200	TAG	15A, 200V, 0.05A, 3V	F-48			
BTX70S400	TAG	15A, 400V, 0.05A, 3V	F-48			
BTX70S500	TAG	15A, 500V, 0.05A, 3V	F-48			

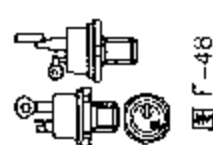

器件型号 Element type	厂名 Manufacturers	材料用途参数 Material Purpose Parameter	图号 Figure	国内外相似替换器件型号 Replace of similar type	备注 Notes	外形参考图 Reference shape
BTX70S600	TAG	15A, 600V, 0.05A, 3V	F-48			 图 F-48
BTX70S700	TAG	15A, 700V, 0.05A, 3V	F-48			
BTX70S800	IAG	15A, 800V, 0.05A, 3V	F-48			
BTX70S900	TAG	15A, 900V, 0.05A, 3V	F-48			
BTX70S1000	TAG	15A, 1kV, 0.05A, 3V	F-48			
BTX71/...R		50Hz-Thy SCR-H	F-55	T10N...C, T12N...		
BTX71/...S		=BTX71/...R; 12μs	F-55	TAG15S..., T12F...		
BTX71-100	TAG	7.5A, 100V, 0.04A, 3V	F-48			
BTX71-200	TAG	7.5A, 200V, 0.04A, 3V	F-48			
BTX71-400	TAG	7.5A, 400V, 0.04A, 3V	F-48			
BTX71-500	TAG	7.5A, 500V, 0.04A, 3V	F-48			
BTX71-600	TAG	7.5A, 600V, 0.04A, 3V	F-48			
BTX71-700	TAG	7.5A, 700V, 0.04A, 3V	F-48			
BTX71-800	TAG	7.5A, 800V, 0.04A, 3V	F-48			
BTX71-900	TAG	7.5A, 900V, 0.04A, 3V	F-48			
BTX71-1000	TAG	7.5A, 1kV, 0.04A, 3V	F-48			
BTX71S100	TAG	7.5A, 100V, 0.04A, 3V	F-48			 图 F-55
BTX71S200	TAG	7.5A, 200V, 0.04A, 3V	F-48			
BTX71S400	TAG	7.5A, 400V, 0.04A, 3V	F-48			
BTX71S500	TAG	7.5A, 500V, 0.04A, 3V	F-48			
BTX71S600	TAG	7.5A, 600V, 0.04A, 3V	F-48			
BTX71S700	TAG	7.5A, 700V, 0.04A, 3V	F-48			
BTX71S800	TAG	7.5A, 800V, 0.04A, 3V	F-48			
BTX71S900	TAG	7.5A, 900V, 0.04A, 3V	F-48			
BTX71S1000	TAG	7.5A, 1kV, 0.04A, 3V	F-48			
BTX72/...R		50Hz-Thy	F-55	T10N..., T12N...		
BTX72/...S		SCR-H	F-55	T12F..., TAG15S...		
BTX72-100	TAG	10A, 100V, 0.04A, 3V	F-48			
BTX72-200	TAG	10A, 200V, 0.04A, 3V	F-48			

器件型号 Element type	厂名 Manufacturers	材料 Material	用途 Purpose	参数 Parameter	图号 Figure	国内外相似替换器件型号 Replace of similar type	备注 Notes	外形参考图 Reference shape
BTX72-100	TAG	10A, 400V	0.04A, 3V	F-48				 图 F-48
BTX72-500	TAG	10A, 500V	0.04A, 3V	F-48				
BTX72-600	TAG	10A, 600V	0.04A, 3V	F-48				
BTX72-700	TAG	10A, 700V	0.04A, 3V	F-48				
BTX72-800	IAG	10A, 800V	0.04A, 3V	F-48				
BTX72-900	TAG	10A, 900V	0.04A, 3V	F-48				
BTX72-1000	TAG	10A, 1kV	0.04A, 3V	F-48				
BTX72S100	TAG	10A, 100V	0.04A, 3V	F-48				
BTX72S200	TAG	10A, 200V	0.04A, 3V	F-48				
BTX72S400	TAG	10A, 400V	0.04A, 3V	F-48				
BTX72S500	TAG	10A, 500V	0.04A, 3V	F-48				
BTX72S600	TAG	10A, 600V	0.04A, 3V	F-48				
BTX72S700	TAG	10A, 700V	0.04A, 3V	F-48				
BTX72S800	TAG	10A, 800V	0.04A, 3V	F-48				
BTX72S900	TAG	10A, 900V	0.04A, 3V	F-48				
BTX72S1000	TAG	10A, 1kV	0.04A, 3V	F-48				
BTX73-50A, B, R, S		50Hz Thy 25A	50V, 0.05A, 0.05A	F-55		T12F100CCB, T17N100BOB		 图 F-55
BTX73-100	TAG	25A	100V, 0.05A, 3V	F-48				
BTX73-100A, B, R, S		50Hz-Thy 25A	100V, 0.05A, 0.05A	F-55		T12F100CCB, T17N100BOB		
BTX73-200	TAG	25A	200V, 0.05A, 3V	F-48				
BTX73-200A, B, R, S		50Hz-Thy 25A	200V, 0.05A, 0.05A	F-55		BTW48-200, CS23-10, T12F200CCB, T17N200BOB		
BTX73-400	TAG	25A	400V, 0.05A, 3V	F-48		TAG14N400DM, 2N688		
BTX73-400A		50Hz-Thy 25A	400V, 0.05A, 0.05A	F-55		BTW48-400, CS23-10, T12F400CCB, T17N400BOB		
BTX73-500	TAG	25A	500V, 0.05A, 3V	F-48				
BTX73-600	TAG	25A	600V, 0.05A, 3V	F-48		TAG14N600DM, 2N690		







器件型号 Element type	厂名 Manufacturers	材料用途参数 Material Purpose Parameter	图号 Figure	国内外相似替换器件型号 Replace of similar type	备注 Notes	外形参考图 Reference shape
BTX73-600A, B, R, S		50Hz Thy 25A, 600V, 0.05A, 0.05A	F-55	BTW48-600, CS23-10, T12F600CCB, T17N600BOB		
BTX73-700	TAG	25A, 700V, 0.05A, 3V	F-48			
BTX73-800	TAG	25A, 800V, 0.05A, 3V	F-48	TAG14N800DM		
BTX73-800A, B, R, S		50Hz-Thy 25A, 800V, 0.05A, 0.05A	F-55	BTW48-800, CS23-10, T12F800CCB, T17N800BOB		
BTX73-900	TAG	25A, 900V, 0.05A, 3V	F-48			
BTX73-1000	TAG	25A, 1kV, 0.05A, 3V	F-48	TAG14N1000DM		
BTX73-1000A, B, R, S		50Hz-Thy 25A, 1kV, 0.05A, 0.05A	F-55	BTW48-100, CS23-10, T12F1000CCB, T17N1000BOB		
BTX73A800	TAG	25A, 800V, 0.05A, 3V	F-48	TAG14N800LM		
BTX73A900	TAG	25A, 900V, 0.05A, 3V	F-48			
BTX73A1000	TAG	25A, 1kV, 0.05A, 3V	F-48			
BTX73A1100	TAG	25A, 1.1kV, 0.05A, 3V	F-48	TAG14N1100LM		
BTX73A1200	TAG	25A, 1.2kV, 0.05A, 3V	F-48	TAG14N1200LM		
BTX73A1300	TAG	25A, 1.3kV, 0.05A, 3V	F-48	TAG14N1300LM		
BTX73AS800	TAG	25A, 800V, 0.05A, 3V	F-48			
BTX73AS900	TAG	25A, 900V, 0.05A, 3V	F-48			
BTX73AS1000	TAG	25A, 1kV, 0.05A, 3V	F-48			
BTX73AS1100	TAG	25A, 1.1kV, 0.05A, 3V	F-48			
BTX73AS1200	TAG	25A, 1.2kV, 0.05A, 3V	F-48			
BTX73AS1300	TAG	25A, 1.3kV, 0.05A, 3V	F-48			
BTX73B800	TAG	25A, 800V, 0.05A, 3V	F-48	TAG14N800LM		
BTX73B900	TAG	25A, 900V, 0.05A, 3V	F-48			
BTX73B1000	TAG	25A, 1kV, 0.05A, 3V	F-48			
BTX73B1100	TAG	25A, 1.1kV, 0.05A, 3V	F-48	TAG14N1100LM		
BTX73B1200	TAG	25A, 1.2kV, 0.05A, 3V	F-48	TAG14N1200LM		
BTX73B1300	TAG	25A, 1.3kV, 0.05A, 3V	F-48	TAG14N1300LM		
BTX73BS800	TAG	25A, 800V, 0.05A, 3V	F-48			





图 F-55

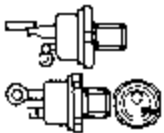
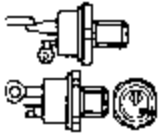
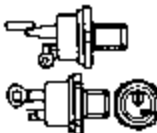

图 F-48





器件型号 Element type	厂名 Manufacturers	材料用途参数 Material Purpose Parameter	图号 Figure	国内外相似替换器件型号 Replace of similar type	备注 Notes	外形参考图 Reference shape
BTX73BS900	TAG	25A, 900V, 0.05A, 3V	F-48			 图 F-48
BTX73BS1000	TAG	25A, 1kV, 0.05A, 3V	F-48			
BTX73RS1100	TAG	25A, 1.1kV, 0.05A, 3V	F-48			
BTX73BS1200	TAG	25A, 1.2kV, 0.05A, 3V	F-48			
BTX73BS1300	TAG	25A, 1.3kV, 0.05A, 3V	F-48			
BTX73S100	TAG	25A, 100V, 0.05A, 3V	F-48			
BTX73S200	TAG	25A, 200V, 0.05A, 3V	F-48			
BTX73S400	TAG	25A, 400V, 0.05A, 3V	F-48			
BTX73S500	TAG	25A, 500V, 0.05A, 3V	F-48			
BTX73S600	TAG	25A, 600V, 0.05A, 3V	F-48			
BTX73S700	TAG	25A, 700V, 0.05A, 3V	F-48			
BTX73S800	TAG	25A, 800V, 0.05A, 3V	F-48			
BTX73S900	TAG	25A, 900V, 0.05A, 3V	F-48			
BTX73S1000	TAG	25A, 1kV, 0.05A, 3V	F-48			
BTX74/...R		50Hz-Thy	F-55	BTW39/..., TAG9N..., TAG15...		
BTX74/...S		SCR-H	F-55	TAG15S..., T12F...		
BTX74-100	TAG	15A, 100V, 0.05A, 3V	F-48			
BTX74-200	TAG	15A, 200V, 0.05A, 3V	F-48			
BTX74-400	TAG	15A, 400V, 0.05A, 3V	F-48			
BTX74-500	TAG	15A, 500V, 0.05A, 3V	F-48			
BTX74-600	TAG	15A, 600V, 0.05A, 3V	F-48	S6210D, TAG9N400DM		
BTX74-700	TAG	15A, 700V, 0.05A, 3V	F-48	S6210M, TAG9N600DM		
BTX74-800	TAG	15A, 800V, 0.05A, 3V	F-48	TAG9N800DM		
BTX74-900	TAG	15A, 900V, 0.05A, 3V	F-48			
BTX74-1000	TAG	15A, 1kV, 0.05A, 3V	F-48	TAG9N1000DM		
BTX74S100	TAG	15A, 100V, 0.05A, 3V	F-48			
BTX74S200	TAG	15A, 200V, 0.05A, 3V	F-48			
BTX74S400	TAG	15A, 400V, 0.05A, 3V	F-48			
BTX74S500	TAG	15A, 500V, 0.05A, 3V	F-48			

































器件型号 Element type	厂名 Manufacturers	材料用途参数 Material Purpose Parameter	图号 Figure	国内外相似替换器件型号 Replace of similar type	备注 Notes	外形参考图 Reference shape
BTX74S600	TAG	15A, 600V, 0.05A, 3V	F-48			 图 F-48
BTX74S700	TAG	15A, 700V, 0.05A, 3V	F-48			
BTX74S800	TAG	15A, 800V, 0.05A, 3V	F-48			
BTX74S900	TAG	15A, 900V, 0.05A, 3V	F-48			
BTX74S1000	TAG	15A, 1kV, 0.05A, 3V	F-48			
BTX75/...P		50Hz-Thy 8.5A, 100-400V, 0.065A, 0.01A	F-55	TAG9N..., TAG15..., 2N1842, 2N1843, 2N1844, 2N1845, 2N1846, 2N1847, 2N1848, 2N1849, 2N1850		
BTX76/...R		50Hz-Thy 12A, 100-400V, 0.04A, 0.01A	F-55	MCR3918..., T12N..., 2N5167, 2N5168, 2N5169, 2N5170, 2N5171		
BTX81-100R	NAS	20A, 100V, 0.08A, 3.5V	F-15	CS16-02, ECG5542, SK6624, SK5542,		 图 F-55
BTX81/...RM, RU		50Hz-Thy 20A, 100-800V, 0.08A, 0.1A	F-55	BSIE41...M, BTW40..., CS16-02, T17N...B		
BTX81-200R	NAS	20A, 200V, 0.08A, 3.5V	F-15	CS16-02, ECG5543, T17N200BOB		
BTX81-300R	NAS	20A, 300V, 0.08A, 3.5V	F-15	CS16-03, ECG5545, T17N300BOB		
BTX81-400R	NAS	20A, 400V, 0.08A, 3.5V	F-15	BSIE4126M, BTW40-400R, CS16-04, ECG5545, T17N400BOB		
BTX81-500R	NAS	20A, 500V, 0.08A, 3.5V	F-15	BSIE4133M, BTW40-600R, CS16-05, ECG5547		
BTX81-600R	NAS	20A, 600V, 0.08A, 3.5V	F-15	RSIF4140M, BTW40-600R, CS16-06, ECG5547, T17N600BOB		
BTX82-100R	NAS	50Hz-Thy 26A, 100V, 0.08A, 3.5V	F-48	BTW48-200, CS23-10		 图 F-15
BTX82/...RM, RU		50Hz-Thy 26A, 100-800V, 0.08A, 0.1A	F-55	BTW48..., CS23...		
BTX82-200R	NAS	50Hz-Thy 26A, 200V, 0.08A, 3.5V	F-48	BTW48-200, CS23-10		
BTX82-300R	NAS	50Hz-Thy 26A, 300V, 0.08A, 3.5V	F-48	BTW48-400, CS23-10		
BTX82-400R	NAS	50Hz-Thy 26A, 400V, 0.08A, 3.5V	F-48	BTW48-400, CS23-10		
BTX82-500R	NAS	50Hz-Thy 26A, 500V, 0.08A, 3.5V	F-48	BTW48-600, CS23-10		
BTX82-600R	NAS	50Hz-Thy 26A, 600V, 0.08A, 3.5V	F-48	BTW48-600, CS23-10		
BTX92/...R		50Hz-Thy 16A, 0.6-1.6kV, 0.15A, 0.2A	F-55	BTW47..., BTW92..., CS23...		

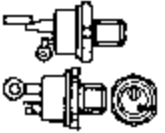

器件型号 Element type	厂名 Manufacturers	材料用途参数 Material Purpose Parameter	图号 Figure	国内外相似替换器件型号 Replace of similar type	备注 Notes	外形参考图 Reference shape
BTX94/...(H, J) BTX95/...R	Triac	25A, 0.1-1.2kV, 0.2A 50Hz Thy 10A, 500-800V, 0.05A, 0.03A	F-55 F-55	BTW39-..., TAG15-..., T15.1N...		
BTX0605 BTX0610 BTX0620 BTX0640 BTX0660	Triac	6A, 50V, 0.05A, 0.05A 6A, 100V, 0.05A, 0.05A 6A, 200V, 0.05A, 0.05A 6A, 400V, 0.05A, 0.05A 6A, 600V, 0.05A, 0.05A	E-8 E-8 E-8 E-8 E-8	SC245A3, SC250A3, T4120F, T4121F SC245B3, SC250B3, T4120E, T4121E SC245A3, SC250A3, T4120E, T4121E SC245D3, SC250D3, T4120E, T4121E SC245M3, SC250M3, T4120M, T4121M		
BTX1005 BTX1010 BTX1020 BTX1040 BTX1060	Triac	10A, 50V, 0.1A, 0.1A 10A, 100V, 0.1A, 0.1A 10A, 200V, 0.1A, 0.1A 10A, 400V, 0.1A, 0.1A 10A, 600V, 0.1A, 0.1A	E-8 E-8 E-8 E-8 E-8	SC245B3, SC250B3, T4120F, T4121F SC245B3, SC250B3, T4120E, T4121E SC245B3, SC250B3, T4120E, T4121E SC245D3, SC250D3, T4120E, T4121E SC245M3, SC250M3, T4120M, T4121M		
BTX1605 BTX1610 BTX1620 BTX1640 BTX1660	Triac	16A, 50V, 0.1A, 0.1A 16A, 100V, 0.1A, 0.1A 16A, 200V, 0.1A, 0.1A 16A, 400V, 0.1A, 0.1A 16A, 600V, 0.1A, 0.1A	E-8 E-8 E-8 E-8 E-8	SC260B3, T6421F, 2N6163, 2N6164, 2N6165 SC260B3, T6421B, 2N6163, 2N6164, 2N6165 SC260B3, T6421B, 2N6163, 2N6164, 2N6165 SC260D3, T6421D, 2N6164, 2N6165 SC260M3, T6421M, 2N6165		
BTX2505 BTX2510 BTX2520 BTX2540 BTX2560	Triac	25A, 50V, 0.1A, 0.1A 25A, 100V, 0.1A, 0.1A 25A, 200V, 0.1A, 0.1A 25A, 400V, 0.1A, 0.1A 25A, 600V, 0.1A, 0.1A	E-8 E-8 E-8 F-8 E-8	SC260B3, T6421F, 2N6163, 2N6164, 2N6165 SC260B3, T6421B, 2N6163, 2N6164, 2N6165 SC260B3, T6421B, 2N6163, 2N6164, 2N6165 SC260D3, T6421D, 2N6164, 2N6165 SC260M3, T6421M, 2N6165		图 E 8
BTY10 BTY11	50Hz-Thy 50Hz-Thy	200A, 50V, 0.2A, 0.2A 200A, 100V, 0.2A, 0.2A				

器件型号 Element type	厂名 Manufacturers	材料用途参数 Material Purpose Parameter	图号 Figure	国内外相似替换器件型号 Replace of similar type	备注 Notes	外形参考图 Reference shape
BTY13		50Hz-Thy 200A, 400V, 0.2A, 0.2A				
BTY15		50Hz-Thy 200A, 500V, 0.2A, 0.2A				
BTY16		50Hz-Thy 200A, 600V, 0.2A, 0.2A				
BTY20		50Hz-Thy 90A, 50V, 0.08A, 0.1A	D-35	T99N400E, T159N400E		 图 D-35
BTY21		50Hz-Thy 90A, 100V, 0.08A, 0.1A	D-35	T99N400E, T159N400E		
BTY22		50Hz-Thy 90A, 200V, 0.08A, 0.1A	D-35	T99N400E, T159N400E		
BTY23		50Hz-Thy 90A, 400V, 0.08A, 0.1A	D-35	T99N400E, T159N400E		
BTY24		50Hz-Thy 90A, 500V, 0.08A, 0.1A	D-35	T99N600E, T159N600E		
BTY25		50Hz-Thy 90A, 600V, 0.08A, 0.1A	D-35	T99N600E, T159N600E		
BTY28		50Hz-Thy 6A, 100V, 0.015A, 0.004A	F-55	BSiD4126, T6N100C, T8N100C, T10N100C		
BTY29		50Hz-Thy 6A, 150V, 0.015A, 0.004A	F-55	BSiD4126, T6N200C, T8N200C, T10N200C		
BTY30		50Hz-Thy 6A, 250V, 0.015A, 0.004A	F-55	BSiD4126, T6N300C, T8N300C, T10N300C		
BTY31		50Hz-Thy 6A, 300V, 0.015A, 0.004A	F-55	BSiD4126, T6N300C, T8N300C, T10N300C		
BTY34...R		50Hz-Thy 6.1A, 100-400V, 0.03A	F-55	MCR3918... , 2N5168, 2N5169, 2N5170, 2N5171, 2N681, 2N682, 2N683, 2N684, 2N685, 2N686, 2N687, 2N688, 2N689, 2N690, 2N691, 2N692		
BTY35		50Hz-Thy 6A, 150V, 0.015A, 0.002A	F-55	BSiD4126, T6N200C, T8N200C, T10N200C		 图 F-55
BTY36		50Hz-Thy 6A, 200V, 0.015A, 0.002A	F-55	BSiD4126, T6N200C, T8N200C, T10N200C		
BTY37		50Hz-Thy 6A, 250V, 0.015A, 0.002A	F-55	BSiD4126, T6N300C, T8N300C, T10N300C		
BTY38		50Hz-Thy 6A, 300V, 0.015A, 0.002A	F-55	BSiD4126, T6N300C, T8N300C, T10N300C		
BTY39		50Hz-Thy 6A, 400V, 0.015A, 0.002A	F-55	BSiD4126, T6N400C, T8N400C, T10N400C		
BTY41		50Hz-Thy 9.6A, 50V, 0.08A, 0.02A	F-55	TAG9N400, TAG15-100, 2N1843, 2N1844, 2N1845, 2N1846, 2N1847, 2N1848, 2N1849, 2N1850		
BTY43		50Hz-Thy 9.6A, 150V, 0.08A, 0.02A	F-55	TAG15-200, TAG9N400, 2N1843, 2N1844, 2N1845, 2N1846, 2N1847, 2N1848, 2N1849, 2N1850		

器件型号 Element type	厂名 Manufacturers	材料用途参数 Material Purpose Parameter	图号 Figure	国内外相似替换器件型号 Replace of similar type	备注 Notes	外形参考图 Reference shape
BTY44	50Hz-Thy	9.5A, 200V, 0.08A, 0.02A	F-55	TAG9N400, TAG15-200, 2N1843, 2N1844, 2N1845, 2N1846, 2N1847, 2N1848, 2N1849, 2N1850		 图 F-55
BTY46	50Hz-Thy	9.5A, 300V, 0.08A, 0.02A	F-55	TAG9N400, TAG15-300, 2N1843, 2N1844, 2N1845, 2N1846, 2N1847, 2N1848, 2N1849, 2N1850		
BTY47	50Hz-Thy	9.5A, 400V, 0.08A, 0.02A	F-55	LAG9N400, TAG15-400, 2N1850		
BTY50	50Hz-Thy	16A, 50V, 0.04A, 0.01A	F-55	C228A, C35A, T12N100, 2N682...692		
BTY51	50Hz-Thy	16A, 100V, 0.04A, 0.01A	F-55	C228A, C35A, T12N100, 2N682...693		
BTY52	50Hz-Thy	16A, 150V, 0.04A, 0.01A	F-55	C228B, C35B, T12N200, 2N682...694		
BTY53	50Hz-Thy	16A, 250V, 0.04A, 0.01A	F-55	C228C, C35C, T12N300, 2N682...696		
BTY54	50Hz-Thy	16A, 300V, 0.04A, 0.01A	F-55	C228C, C35C, T12N300, 2N682...697		
BTY57	50Hz-Thy	16A, 50V, 0.04A, 0.01A	F-55	C228A, C35A, T12N100, 2N682...696		
BTY58	50Hz-Thy	16A, 100V, 0.04A, 0.01A	F-55	C228A, C35A, T12N100, 2N683...696		
BTY59	50Hz-Thy	16A, 150V, 0.04A, 0.01A	F-55	C228B, C35B, T12N200, 2N684...696		
BTY60	50Hz-Thy	16A, 200V, 0.04A, 0.01A	F-55	C228B, C35B, T12N200, 2N685...696		
BTY61	50Hz-Thy	16A, 250V, 0.04A, 0.01A	F-55	C228C, C35C, T12N300, 2N686...696		
BTY62	50Hz-Thy	16A, 300V, 0.04A, 0.01A	F-55	C228C, C35C, T12N300, 2N687...696		 图 F-47
BTY64	50Hz-Thy	110A, 50V, 0.07A, 0.02A	F-55			
BTY65	50Hz-Thy	110A, 100V, 0.07A, 0.02A	F-55			
BTY66	50Hz-Thy	110A, 150V, 0.07A, 0.02A	F-55			
BTY67	50Hz-Thy	110A, 200V, 0.07A, 0.02A	F-55			
BTY68	50Hz-Thy	110A, 250V, 0.07A, 0.02A	F-55			
BTY69	50Hz-Thy	110A, 300V, 0.07A, 0.02A	F-55			
BTY70	50Hz-Thy	110A, 400V, 0.07A, 0.02A	F-55			 图 F-15
BTY79-100R	MUL, NAS	6.4A, 100V, 0.03A, 3V	F-47	BSIC0313, BSID0313, CS5-02		
BTY79-150R	NAS	6A, 150V, 0.025A, 2V	F-15	BSIC0313, BSID0313, CS5-02		

器件型号 Element type	厂名 Manufacturers	材料用途参数 Material Purpose Parameter	图号 Figure	国内外相似替换器件型号 Replace of similar type	备注 Notes	外形参考图 Reference shape
BTY79-200R	MUL, NAS	50Hz-Thy 6.4A, 200V, 0.03A, 3V	F-47	BSIC0313, BSID0313, CS5-02		
BTY79-250R	NAS	50Hz-Thy 6A, 250V, 0.025A, 2V	F-15	BSIC0326, BSID0326, CS5-04		
BTY79-300R	NAS	50Hz-Thy 6.4A, 300V, 0.03A, 3V	F-47	BSIC0326, BSID0326, CS5-04		
BTY79-400R	MUL, NAS	50Hz-Thy 10A, 400V, 0.03A, 1.5V	B-52	BSIC0326, BSID0326, BTW38-600R, BTW42-600R, CS5-04		
BTY79-600R	MUL, NAS	50Hz-Thy 16A, 600V, 0.03A, 1.5V	F-47	BTW38-600R, BTW42-600R, BSID0334, CS5-06		
BTY79-800R	MUL, PHI	50Hz-Thy 16A, 800V, 0.03A, 1.5V	F-47	BSIC0353, BSID0353, BTW38-800R, BTW42-800R, BTW42-800R, CS5-08		
BTY79-1000R	MUL, PHI	50Hz-Thy 10A, 1kV, 0.03A, 1.5V	F-47	BTW38-1000R, BTW42-1000R, BTW42-1000R, BSIC0366		
BTY79A-05		50Hz-Thy 10A, 50V, 0.02A, 0.025A	F-55	BSID4126, S6210A, T10N100C		
BTY79A-10		50Hz-Thy 10A, 100V, 0.02A, 0.025A	F-55	BSID4126, S6210A, T10N100C		
BTY79A-20		50Hz-Thy 10A, 200V, 0.02A, 0.025A	F-55	BSID4126, S6210B, T10N200C		
BTY79A-30		50Hz-Thy 10A, 300V, 0.02A, 0.025A	F-55	BSID4126, S6210D, T10N300C		
BTY79A-40		50Hz-Thy 10A, 400V, 0.02A, 0.025A	F-55	BSID4126, S6210D, T10N400C		
BTY79A-50		50Hz-Thy 10A, 500V, 0.02A, 0.025A	F-55	BSID4133, S6210M, T10N500C		
BTY80		50Hz-Thy 6.4A, 200V, 0.03A, 3V	F-55	BSIC0313, BSID0313, BTY79-100R, CS5-02		
BTY81		50Hz-Thy 10A, 400V, 0.03A, 1.5V	F-55	BSIC0326, BSID0326, BTY79-400R, CS5 04		
BTY84		50Hz-Thy 6.4A, 100V, 0.03A, 3V	F-55	BSIC0313, BSID0313, BTY79-100R, CS5-02		
BTY85		50Hz-Thy 6.4A, 200V, 0.03A, 3V	F-55	BSIC0313, BSID0313, BTY79-200R, CS5-02		
BTY86		50Hz-Thy 6.4A, 300V, 0.03A, 3V	F-55	BSIC0313, BSID0313, BTY79-200R, CS5-02		
BTY87-100R	MUL, NAS	12A, 100V, 0.065A, 3.5V	F-48	BTW39/..., CS13-..., TAG15-..., TAG16N...		
BTY87/...(RM, RU)	NAS	10A, 100-800V, 0.065A, 0.01A	F-55			
BTY87-150R		10A, 150V, 0.065A, 3.5V	F-48	ECG5504		
BTY87-200R	MUL, NAS	12A, 200V, 0.065A, 3.5V	F-48			
BTY87-250R	NAS	10A, 250V, 0.065A, 3.5V	F-48			
BTY87-300R	NAS	10A, 300V, 0.065A, 3.5V	F-48			
BTY87-400R	MUL, NAS	25A, 400V, 0.065A, 3.5V	F-48	ECG5507		
BTY87-600R				BTW38-600R, BTW45-400R, ECG5507		

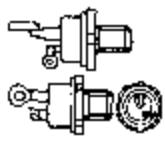
器件型号 Element type	厂名 Manufacturers	材料用途参数 Material Purpose Parameter	图号 Figure	国内外相似替换器件型号 Replace of similar type	备注 Notes	外形参考图 Reference shape
BTY87-500R	MUL, NAS	25A, 500V, 0.065A, 3.5V	F-48	BTW38-600R, BTW45-600R, ECG5509		 图 F-48
BTY87-600H	MUL, NAS	25A, 600V, 0.065A, 3.5V	F-48	BTE38-600R, BTW45-600R, ECG5529		
BTY87-800R	MUL, RTC	25A, 800V, 0.065A, 3.5V	F-48	BTW38-800R, BTW45-800R, ECG5531		
BTY88		50Hz-Thy 16A, 100V, 0.04A, 3V	F-55	BTY91-100R, T12N100COB, 2N5204, 2N5205, 2N5206, 2N5207		 图 F-55
BTY89		50Hz-Thy 16A, 150V, 0.04A, 3V	F-55	BTY91-150R, T12N200COB, 2N5204, 2N5205, 2N5206, 2N5207		
BTY90		50Hz-Thy 16A, 200V, 0.04A, 3V	F-55	BTY91-200R, T12N200COB, 2N5204, 2N5205, 2N5206, 2N5207		
BTY91-100R	MUL, NAS	16A, 100V, 0.04A, 3V	F-48	ECG5522		 图 E-7
BTY91/...(RM, RU)		50Hz-Thy 14A, 0.1-1.2KV, 0.04A, 0.025A	F-55	T12N..., 2N5204...2N5207		
BTY91-150R	NAS	14A, 150V, 0.04A, 3V	F-48	ECG5524		
BTY91-200R	MUL, NAS	16A, 200V, 0.04A, 3V	F-48	ECG5527		
BTY91-250R	NAS	14A, 250V, 0.04A, 3V	F-48	BTW45-400R, ECG5527		
BTY91-300R	NAS	18A, 300V, 0.04A, 3V	F-48	BTW45-600R, ECG5529		
BTY91-400R	MUL, NAS	25A, 400V, 0.04A, 3V	F-48	RTW45-600R, ECG5529		
BTY91-500R	MUL, NAS	25A, 500V, 0.04A, 3V	F-48	BTW45-800R, ECG5531		
BTY91-600R	MUL, NAS	25A, 600V, 0.04A, 3V	F-48	BTY95 100R		
BTY91-800R	MUL, NAS	25A, 800V, 0.04A, 3V	F-48	BTY95 200R		
BTY92		50Hz-Thy 32A, 100V, 0.08A, 0.01A	E 7	BTY95-300R		
BTY93		50Hz-Thy 32A, 200V, 0.08A, 0.01A	E-7	CS42-..., CS50-..., CS70-...		
BTY94		50Hz-Thy 32A, 300V, 0.08A, 0.01A	E-7	BIY99-100R		
BTY95/...R		50Hz-Thy 32A, 100-800V, 0.08A, 0.01A	E-7	BTY99-200R		
BTY96		50Hz-Thy 62A, 100V	E-7	BTY99-300R		
BTY97		50Hz-Thy 62A, 200V	E-7	CS70-...		
BTY98		50Hz-Thy 62A, 300V	E-7			
BTY99/...R		50Hz-Thy 62A, 100-800V, 0.07A	E-7			
BTZ10		50Hz-Thy 24A, 50V	F-48			 B

器件型号 Element type	厂名 Manufacturers	材料用途参数 Material Purpose Parameter	图号 Figure	国内外相似替换器件型号 Replace of similar type	备注 Notes	外形参考图 Reference shape
BTZ11		50Hz-Thy 24A, 100V	F-48			 图 F-48
BTZ12		50Hz-Thy 24A, 200V	F-48			
BTZ13		50Hz-Thy 24A, 400V	F-48			
BTZ15		50Hz-Thy 24A, 500V	F-48			
BTZ16		50Hz-Thy 24A, 600V	F-48			
BTZ18		50Hz-Thy 6A, 200V, 0.015A	F-55	BS1D4126, T6N200C, T8N200C		
BTZ19		50Hz-Thy 6A, 400V, 0.015A	F-55	BS1D4126, T6N400C, T8N400C		
BTZ21		50Hz-Thy 16A, 400V, 0.04A	F-55	C35D, MCR64-6, T12N400, 2N688...692		 图 F-55
BTZ35		50Hz-Thy 3.5A, 50V, 0.04A	F-55	AG9N400, TAG15-100, 2N1843...1850		
BTZ36		50Hz-Thy 3.5A, 100V, 0.04A	F-55	AG9N400, TAG15-100, 2N1844...1850		
BTZ37		50Hz-Thy 3.5A, 200V, 0.04A	F-55	AG9N400, TAG15-200, 2N1846...1850		
BTZ38		50Hz-Thy 3.5A, 350V, 0.04A	F-55	AG9N400, TAG15-400, TAG16N400, 2N1850		
BTZ39		50Hz-Thy 3.5A, 450V, 0.04A	F-55	AG9N600, TAG15-500, TAG16N600, 2N1850		
BW411-413	GTN	15A, 0.04A, 2.5V				
BW421-423	GTN	15A, 0.04A, 2.5V				
BW431-433	GTN	15A, 0.04A, 2.5V				
BW441-443	GTN	15A, 0.04A, 2.5V				
BW451-453	GTN	15A, 0.04A, 2.5V				
BW461-463	GTN	15A, 0.04A, 2.5V				
BW471-473	GTN	15A, 0.04A, 2.5V				
BW481-483	GTN	15A, 0.04A, 2.5V				
BW491-493	GTN	15A, 0.04A, 2.5V				
BW511-513	GTN	25A, 0.04A, 2.5V				
BW521-523	GTN	25A, 0.04A, 2.5V				

器件型号 Element type	厂名 Manufacturers	材料用途参数 Material Purpose Parameter	图号 Figure	国内外相似替换器件型号 Replace of similar type	备注 Notes	外形参考图 Reference shape
BW531-533	GTN	25A, 0.04A, 2.5V				
BW541-543	GTN	25A, 0.04A, 2.5V				
BW551-553	GTN	25A, 0.04A, 2.5V				
BW561-563	GTN	25A, 0.04A, 2.5V				
BW571-573	GTN	25A, 0.04A, 2.5V				
BW581-583	GTN	25A, 0.04A, 2.5V				
BW591-593	GTN	25A, 0.04A, 2.5V				
BW-C411-413	GTN	15A, 0.04A, 2.5V				
BW-C421-423	GTN	15A, 0.04A, 2.5V				
BW-C431-433	GTN	15A, 0.04A, 2.5V				
BW-C441-443	GTN	15A, 0.04A, 2.5V				
BW-C451-453	GTN	15A, 0.04A, 2.5V				
BW-C461-463	GTN	15A, 0.04A, 2.5V				
BW-C471-473	GTN	15A, 0.04A, 2.5V				
BW-C481-483	GTN	15A, 0.04A, 2.5V				
BW-C491-493	GTN	15A, 0.04A, 2.5V				
BW-C511-513	GTN	25A, 0.04A, 2.5V				
BW-C521-523	GTN	25A, 0.04A, 2.5V				
BW-C531-533	GTN	25A, 0.04A, 2.5V				
BW-C541-543	GTN	25A, 0.04A, 2.5V				
BW-C551-553	GTN	25A, 0.04A, 2.5V				
BW-C561-563	GTN	25A, 0.04A, 2.5V				
BW-C571-573	GTN	25A, 0.04A, 2.5V				
BW-C581-583	GTN	25A, 0.04A, 2.5V				
BW-C591-593	GTN	25A, 0.04A, 2.5V				



B类外形参考图索引



图 A-3



图 B-2

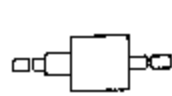

图 B-5

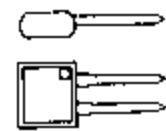

图 B-6



图 B-9

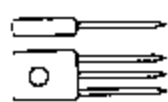

图 B-10

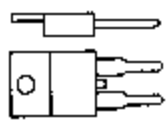

图 B-11

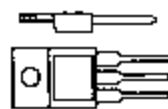

图 B-14

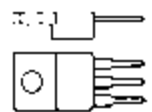

图 B-17

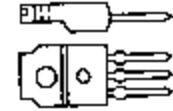

图 B-26

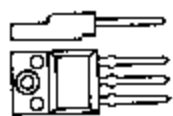

图 B-27

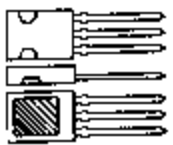

图 B-29

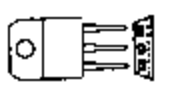

图 B-30



图 B-31

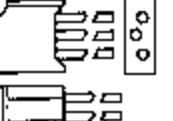

图 B-35



图 B-36



图 B-45

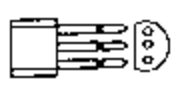

图 B-49



图 B-51



图 B-52



图 B-62

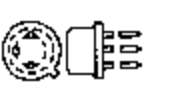

图 B-65



图 B-79



图 B-81

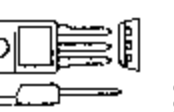

图 B-82

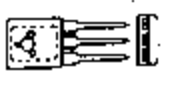

图 B-84

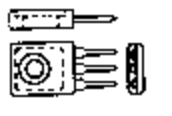

图 B-87

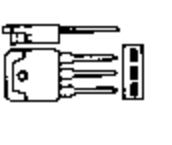

图 B-89



图 B-91

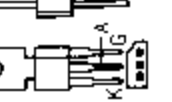

图 B-97

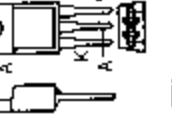

图 B-98

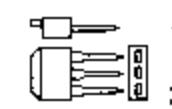

图 B-101

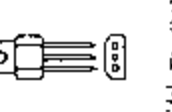

图 B-102

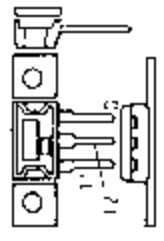

图 B-108

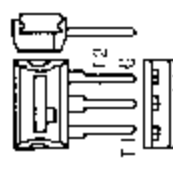

图 B-109

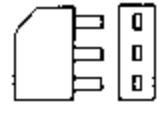

图 C-7

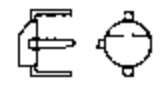

图 C-8

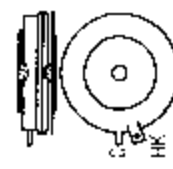

图 C-14

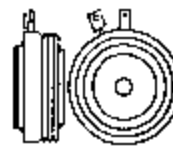

图 C-35

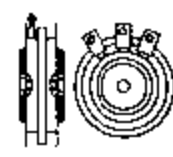

图 C-47



图 C-48

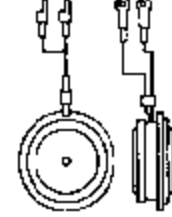

图 C-50

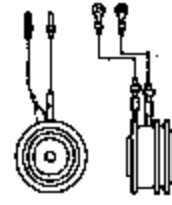

图 C-67

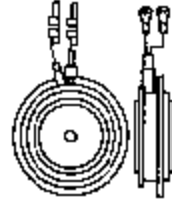

图 C-75

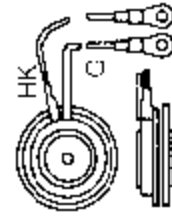

图 C-86

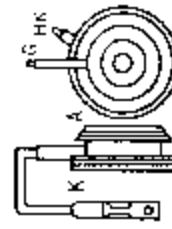

图 D-9

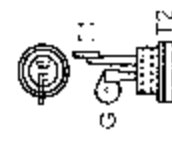

图 D-10

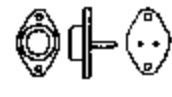

图 D-14

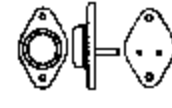

图 D-28

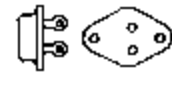

图 D-29

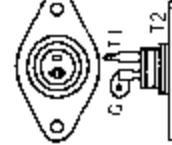

图 D-33



图 D-35

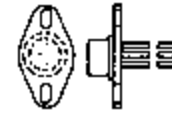

图 E-1

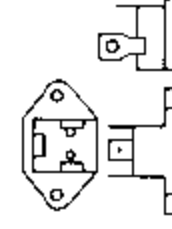

图 E-3

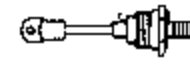

图 E-4

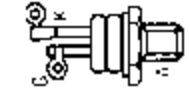

图 E-6

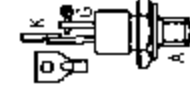

图 E-7

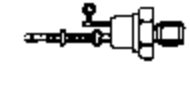

图 E-8

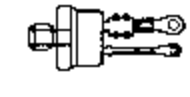

图 E-11



图 E-18



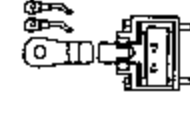

图 E-22

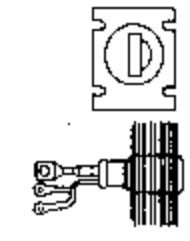
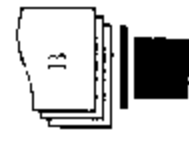

图 E-30

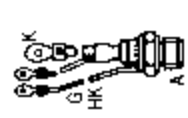

图 F-8

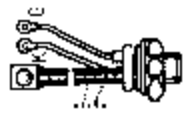

图 F-11



图 F-15



图 F-21



图 F-22

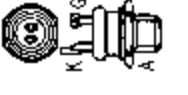

图 F-23

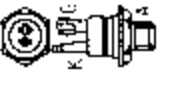

图 F-27

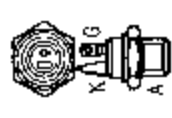

图 F-48



图 F-49



图 F-50



图 F-55



图 F-57

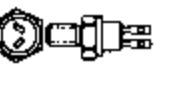

图 F-64



图 F-71

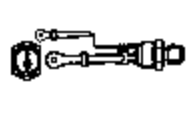

图 F-92

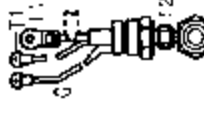

图 G-1

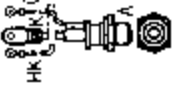

图 G-6



图 G-10

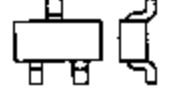

图 G-29



图 G-12



图 G-18



图 G-20

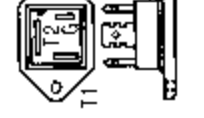

图 H-14

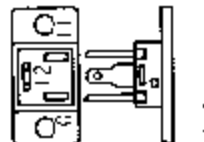

图 H-22

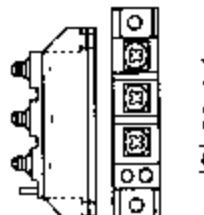

图 H-25

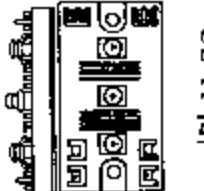

图 H-29



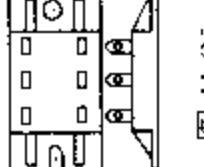



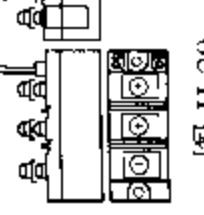

图 H-33

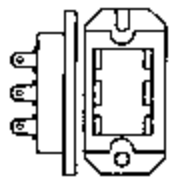

器件型号 Element type	厂名 Manufacturers	材料用途参数 Material Purpose Parameter	图号 Figure	国内外相似替换器件型号 Replace of similar type	备注 Notes	外形参考图 Reference shape
C5A	GES	1.6A, 100V, 200 μ A, 0.8V	B-55	S1001MS2, 2N2324		 图 B-55
C5B	GES	1.6A, 200V, 200 μ A, 0.8V	B-55	S2001MS2, 2N2326		
C5C	GES	1.6A, 300V, 200 μ A, 0.8V	B-51	S4001MS2, 2N2328		
C5D	GES	1.6A, 400V, 200 μ A, 0.8V	B-51	S4001MS2, 2N2329		
C5E	GES	1.6A, 50V, 200 μ A, 0.8V	B-55	S0501MS2, 2N2323		
C5F	GES	1.6A, 150V, 200 μ A, 0.8V	B-55	S2001MS2, 2N2325, 2N2326		
C5G	GES	1.6A, 25V, 200 μ A, 0.8V	B-51	S0301MS2, 2N2322		
C5U	GES	1.6A, 25V, 200 μ A, 0.8V	B-51	S0301MS2, 2N2322		
C6A	AMR, ELT	1.6A, 100V, 0.001A, 0.8V	B-55	MCR1906-2, MCR1906-3, S1001MS3, TAG2-100		
C6B	AMR, ELT	1.6A, 200V, 0.001A, 0.8V	B-55	MCR1906-4, S2001MS3, TAG2-200		
C6C	AMR, GES	1.6A, 300V, 0.001A, 0.8V	B-51	S4001MS3, TAG2-300		
C6D	AMR, GES	1.6A, 400V, 0.001A, 0.8V	B-51	S4001MS3, TAG2-400		
C6F	AMR, ELT	1.6A, 50V, 0.001A, 0.8V	B-55	MCR1906-2, S1001MS3, TAG2-50		
C6G	AMR, ELT	1.6A, 150V, 0.001A, 0.8V	B-55	MCR1906-4, S2001MS3		
C6U	AMR, ELT	1.6A, 25V, 0.001A, 0.8V	B-55	S0301MS3		
C7A		1.6A, 100V	B-55	MCR1906-3		 图 B-51
C7B, G		1.6A, 200V	B-55	MCR1906-4		
C7U		1.6A, 50V	B-55	MCR1906-2		
C10A	GES	7.4A, 100V, 0.015A, 2V	F-47	S1015B, 2N4169		 图 F-47
C10B	GES	7.4A, 200V, 0.015A, 2V	F-47	S2015B, 2N4170		
C10C	GES	7.4A, 300V, 0.015A, 2V	F-47	SK3943, SK5485		
C10D	GES	7.4A, 400V, 0.015A, 2V	F-47	S4015B		
C10F	GES	7.4A, 50V, 0.015A, 2V	F-47	S0515B, 2N4168		
C10G	GES	7.4A, 150V, 0.015A, 2V	F-47	S2015B, 2N4170		
C10U	GES	7.4A, 25V, 0.015A, 2V	F-47	S0315B		
C10V	GES	8A, 50V		2N4168		
C11A	GES	7.4A, 100V, 0.015A, 2V	F-47	S1015B, 2N4169, 2N4196		
C11B	GES	7.4A, 200V, 0.015A, 2V	F-47	S2015B, SK3942, SK5483, 2N4170		
C11C	GES	7.4A, 300V, 0.015A, 2V	F-47	S4015B, SK3943, SK5485, 2N4171, 2N4172		

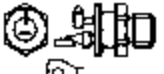
器件型号 Element type	厂名 Manufacturers	材料用途参数 Material Purpose Parameter	图号 Figure	国内外相似替换器型号 Replace of similar type	备注 Notes	外形参考图 Reference shape	
C11D	GES	7.4A, 400V, 0.015A, 2V	F-47	S4015B, SK3943, SK5485, 2N4172		 图 F-47	
C11E	GES	7.4A, 500V, 0.015A, 2V	F-47	SK3944, SK5487, S6015B, 2N4173, 2N4174			
C11F	GES	7.4A, 50V, 0.015A, 2V	F-47	S0515B, 2N4168			
C11G	GES	7.4A, 150V, 0.015A, 2V	F-47	S2015B, SK3942, SK5483, 2N4170			
C11H	GES	7.4A, 250V, 0.015A, 2V	F-47	S4015B, SK3943, SK5485, 2N4168, 2N4171, 2N4172			
C11M	GES	7.4A, 600V, 0.015A, 2V	F-47	S6015B, 2N4174, 2N4168			
C11U	GES	7.4A, 25V, 0.015A, 2V	F-47	S0315B, 2N4167			
C12C	NEC	7A, 300V, 0.015A, 2V	F-8				 图 F-8
C12D	NEC	7A, 400V, 0.015A, 2V	F-8				
C13F	GES, NJS	3A, 50V, 20μA, 0.40V	B-34				 图 B-34
C13Y	GES, NJS	3A, 30V, 20μA, 0.40V	B-34				
C15A	AMR, GES	3A, 100V, 0.025A, 2.5V	F-47	S1015B, 2N4170, 2N4196		 图 F-4	
C15B	AMR, GES	3A, 200V, 0.025A, 2.5V	F-47	SK3942, SK5483, 2N4170, 2N4172			
C15C	AMR, GES	3A, 300V, 0.025A, 2.5V	F-47	S4015B, 2N4172			
C15D	AMR, GES	3A, 400V, 0.025A, 2.5V	F-47	SK3943, SK5485, 2N4168, 2N4172			
C15E	AMR, GES	3A, 500V, 0.025A, 2.5V	F-47	S0515B			
C15F	AMR, GES	3A, 50V, 0.025A, 2.5V	F-47	2N4168, 2N4170			
C15G	AMR, GES	3A, 150V, 0.025A, 2.5V	F-47	SK3942, SK5483, 2N4170, 2N4172			
C15H	AMR, GES	8A, 600V, 0.025A, 2.5V	F-47	2N4174			
C15M	AMR, GES	3A, 600V, 0.025A, 2.5V	F-47	SK3944, SK5482, 2N4174			
C15U	AMR, GES	3A, 25V, 0.025A, 2.5V	F-47	S0315B			
C20A	AMR, HTN	7.4A, 100V, 0.025A, 1.5V	F-4	S6210A, S1025G, SK5491, SK6791, 2N4169			
C20B	AMR, HTN	7.4A, 200V, 0.025A, 1.5V	F-21	S6210B, S2025G, SK5492, SK6792, 2N4170			
C20C	AMR, HTN	7.4A, 300V, 0.025A, 1.5V	F-21	S6210C, S4025G, 2N4171, 2N4172			
C20D	AMR, HTN	7.4A, 400V, 0.025A, 1.5V	F-21	S6210D, S4025G, 2N4172			
C20F	AMR, HTN	7.4A, 50V, 0.025A, 1.5V	F-21	S6210A, S0525G, SK6791, SK5491, 2N4168			
C20U	AMR, HTN	7.4A, 25V, 0.025A, 1.5V	F-21	S6210A, S0325G, SK6791, SK5491, 2N4167, 2N4168			

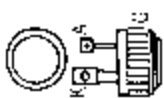
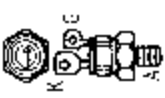

器件型号 Element type	厂名 Manufacturers	材料用途参数 Material Purpose Parameter	图号 Figure	国内外相似替换器件型号 Replacc of similar type	备注 Notes	外形参考图 Reference shape
C22A	AMR, HTN	7.4A, 100V, 0.025A, 1.5V	C-85	S6200A, S1025H, SK3589		 图 C-85
C22B	AMR, HTN	7.4A, 200V, 0.025A, 1.5V	C-85	S6200B, S2025H, SK3589		
C22C	AMR, HTN	7.4A, 300V, 0.025A, 1.5V	C-85	S6200C, S4025H, SK3580, SK5507		
C22D	AMR, HTN	7.4A, 400V, 0.025A, 1.5V	C-85	S6200D, S4025H, SK3580, SK5507		
C22F	AMR, HTN	7.4A, 50V, 0.025A, 1.5V	C-85	S6200A, S0525H, SK3589		
C22U	AMR, HTN	7.4A, 25V, 0.025A, 1.5V	C-85	S6200A, S0355H, SK3589		
C30A	AMR, HTN	25A, 100V, 0.025A, 1.5V	F-47	S1025H, SK5522, SK6622, 2N683, 2N3896		 图 F-47
C30B	AMR, HTN	25A, 200V, 0.025A, 1.5V	F-47	S2025H, SK5524, SK6624, 2N685, 2N3897		
C30C	AMR, HTN	25A, 300V, 0.025A, 1.5V	F-47	S4025H, SK5527, SK6627, 2N687, 2N688, 2N3898		
C30D	AMR, HTN	25A, 400V, 0.025A, 1.5V	F-47	S4025H, SK5527, SK6627, 2N688, 2N3898		
C30F, U	AMR, HTN	25A, 50V, 0.025A, 1.5V	F-47	S0525H, SK5521, SK6621, 2N682		
C31A	AMR, HTN	25A, 100V, 0.009A, 1.5V	F-47	S1025H, SK3581, SK5543, 2N683, 2N3896		
C31B	AMR, HTN	25A, 200V, 0.009A, 1.5V	F-47	S2025H, SK3581, SK5543, 2N685, 2N3897		
C31C	AMR, HTN	25A, 300V, 0.009A, 1.5V	F-47	ECG1048, S4025H, SK3582, SK5545, 2N687, 2N688, 2N3898		
C31D	AMR, HTN	25A, 400V, 0.009A, 1.5V	F-47	S4025H, SK3582, SK5545, 2N688, 2N3898		
C31F	AMR, HTN	25A, 50V, 0.009A, 1.5V	F-47	S0525H, SK3581, SK5543, 2N682		
C31U	AMR, HTN	25A, 25V, 0.009A, 1.5V	F-47	S0325H, SK3581, SK5543, 2N681, 2N682, 2N3896		
C32A	AMR, HTN	25A, 100V, 0.025A, 1.5V	F-47	ECG128, S1025G, SK3024, SK128, 2N683, 2N3870		
C32B	AMR, HTN	25A, 200V, 0.025A, 1.5V	F-47	S2025G, 2N685, 2N3871		
C32C	AMR, HTN	25A, 300V, 0.025A, 1.5V	F-47	S4025G, 2N687, 2N688, 2N3872		
C32D	AMR, HTN	25A, 400V, 0.025A, 1.5V	F-47	S4025G, 2N688, 2N3872		
C32F	AMR, HTN	25A, 50V, 0.025A, 1.5V	F-47	S0525G, 2N682, 2N3870		
C32U	AMR, HTN	25A, 25V, 0.025A, 1.5V	F-47	S0325G, 2N681, 2N682, 2N3870		
C33A	AMR, HTN	25A, 100V, 0.009A, 1.5V	C-85	MCR3818-3, S1025G, 2N3870		
C33B	AMR, HTN	25A, 200V, 0.009A, 1.5V	C-85	MCR5165, S2025G, 2N5165, 2N3871		
C33C	AMR, HTN	25A, 300V, 0.009A, 1.5V	C-85	MCR3818-5, MCR3818-6, S4025G, 2N3872		
C33D	AMR, HTN	25A, 400V, 0.009A, 1.5V	C-85	MCR5166, 2N5166, 2N3872		

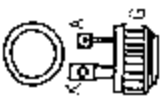
器件型号 Element type	厂名 Manufacturers	材料用途参数 Material Purpose Parameter	图号 Figure	国内外相似替换器件型号 Replace of similar type	备注 Notes	外形参考图 Reference shape
C33F	AMR, HTN	25A, 50V, 0.009A, 1.5V	C-85	MCR5164, S0525G, 2N5164, 2N3870		 图 C-85
C33U	AMR, HTN	25A, 25V, 0.009A, 1.5V	C-85	MCR3818-1, MCR3818-2, S0325G, 2N3870		
C34A1, 2	AMR, HTN	25A, 100V, 0.025A, 1.5V	C-85			
C34B1, 2	AMR, HTN	25A, 200V, 0.025A, 1.5V	C-85			
C34C1, 2	AMR, HTN	25A, 300V, 0.025A, 1.5V	C-85			
C34D1, 2	AMR, HTN	25A, 400V, 0.025A, 1.5V	C-85			
C34E1, 2	AMR, HTN	25A, 500V, 0.025A, 1.5V	C-85			
C34F1, 2	AMR, HTN	25A, 50V, 0.025A, 1.5V	C-85			
C35A	ASI, GES	35A, 100V, 0.04A, 3V	F-47	S1035H, SK6642, SK5542, T400012208, 2N6883, 2N3896		
C35B	ASI, GES	35A, 200V, 0.04A, 3V	F-47			
C35C	ASI, GES	35A, 300V, 0.04A, 3V	F-47	C35D, S4035H		
C35D	ASI, GES	35A, 400V, 0.04A, 3V	F-47	S4035H, TAG16N400DU, T400032208, 2N6886, 2N3898		
C35E	ASI, GES	35A, 500V, 0.04A, 3V	F-47	C35M, S6035H, T400052208, TAG16N500DU, 2N6889, 2N3899		
C35F	ASI, GES	35A, 50V, 0.04A, 3V	F-47	S0535H, SK5542, SK6642, T400002208, 2N6882, 2N3896		
C35G	ASI, GES	35A, 150V, 0.04A, 3V	F-47	C35B, S2035H		
C35H	ASI, GES	35A, 250V, 0.04A, 3V	F-47	C35D, S4035H		
C35M	ASI, GES	35A, 600V, 0.04A, 3V	F-47	S6035H, T400062208, TAG16N600DU, 2N6990.		
C35N	ASI, GES	35A, 800V, 0.04A, 3V	F-47			
C35P	ASI	35A, 1kV, 0.04A, 2.5V	F-47			
C35S	ASI, GES	35A, 700V, 0.04A, 3V	F-47	C35N, T400072208, TAG16N700DU		
C35T	ASI	35A, 900V, 0.04A, 2.5V	F-47			
C35U	ASI, MOT	35A, 25V, 0.04A, 3V	F-47	C35F, S0335H, SK5542, SK6642, 2N681, 2N3896.		
C36A	GES	16A, 100V, 0.08A, 3V	F-47	S1015H, 2N1844		
C36B	GES	16A, 200V, 0.08A, 3V	F-47	S2015H, 2N1846		
C36C	GES	16A, 300V, 0.08A, 3V	F-47	S4015H, 2N1848, 2N1849		



器件型号 Element type	厂名 Manufacturers	材料用途参数 Material Purpose Parameter	图号 Figure	国内外相似替换器件型号 Replace of similar type	备注 Notes	外形参考图 Reference snape
C36D	GES	16A, 400V, 0.08A, 3V	F-47	S4015H, T400041008, TAG9N400DU, 2N1849, 2N1849A		 图 F-47
C36E	GES	16A, 500V, 0.08A, 3V	F-47	S5015H, T400051008, TAG9N500DU, 2N1850, 2N1850A, 2N5171		
C36F	GES	16A, 50V, 0.08A, 3V	F-47	S0515H, 2N1843		
C36G	GES	16A, 150V, 0.08A, 3V	F-47	S2015H, 2N1845, 2N1846		
C36H	GES	16A, 250V, 0.08A, 3V	F-47	S4015H, 2N1847, 2N1849		
C36M	GES	16A, 600V, 0.08A, 3V	F-48	S6015H, T400061008, TAG9N600DU		
C36S	GES	16A, 700V, 0.08A, 3V	F-48	SK6632, T400071008		
C36U	GES	16A, 50V, 0.08A, 3V	F-47	2N1843		
C37A	AMR, ASI	25A, 100V, 0.08A, 3V	F-48	MCR3918-3, MCR3918-3A, S1025H, SK5522,		
C37B	AMR, ASI	25A, 200V, 0.08A, 3V	F-48	S2025H, 2N5169, SK6624, SK5524		
C37C	AMR, ASI	25A, 300V, 0.08A, 3V	F-48	MCR3918-5, MCR3918-6A, S4025H, SK5527,		
C37D	AMR, ASI	25A, 400V, 0.08A, 3V	F-48	S4025H, SK5527, SK6627, 2N5170, TAG9N400DU		
C37E	AMR, ASI	25A, 500V, 0.08A, 3V	F-48	MCR3918-7, MCR3918-8A, TAG9N500DU, SK5529, SK6629		
C37F	AMR, ASI	25A, 50V, 0.08A, 3.5V	F-48	S0525H, SK5521, SK6621, 2N5168		
C37G		20A, 200V	F-48	2N5169		
C37H		25A, 400V	F-48	MCR3918-6A		
C37M	AMR, ASI	25A, 600V, 0.08A, 3V	F-48	S6025H, SK5529, SK6629, 2N5171		
C37N	AMR, ASI	25A, 800V, 0.08A, 3V	F-48	TAG9N800DU		
C37S	AMR, ASI	25A, 700V, 0.08A, 3.5V	F-48	SK6632, T400071608		
C37U	AMR, ASI	25A, 25V, 0.08A, 3.5V	F-48	MCH3918-1, MCH3918-2A, S0325H		
C38A	AMR, ASI	35A, 100V, 0.04A, 3V	F-48	MCR3896, S1035H, SK6642, SK5542, 2N683, 2N3896		
C38B	AMR, ASI	35A, 200V, 0.04A, 3V	F-48	MCR3897, 2N3897, 2N685		
C38C	AMR, ASI	35A, 300V, 0.04A, 3V	F-48	MCR3935-5, MCR3935-6A, S4035H, 2N687		
C38D	AMR, ASI	35A, 400V, 0.04A, 3V	F-48	MCR3898, S4035H, 2N3896, 2N688		
C38E	AMR, ASI	35A, 500V, 0.04A, 3V	F-48	MCR3935-7, MCR3935-8A, S6035H, 2N689		









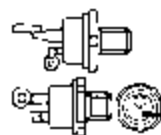
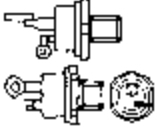

图 F-48

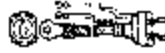

器件型号 Element type	厂名 Manufacturers	材料用途参数 Material Purpose Parameter	图号 Figure	国内外相似替换器件型号 Replace of similar type	备注 Notes	外形参考图 Reference space
C38F	AMR, ASI	35A, 50V, 0.04A, 3V	F-48	MCR3935-2, MCR3935-2A, S0535H, SK6642, SK5542, 2N682		 图 F-48
C38G	AMR, ASI	35A, 150V, 0.04A, 3V	F-48	MCR3897, S2025H, 2N3897, 2N684		
C38H	AMR, ASI	35A, 250V, 0.04A, 3V	F-48	MCR3935-5, MCR3935-8A, S4035H		
C38U	AMR, ASI	35A, 250V, 0.04A, 3V	F-18	MCR3935 1, MCR3935-2A, S0335H, SK6621, SK5521, 2N681		
C40A	AMR, ASI	35A, 100V, 0.04A, 2.5V	F-48			
C40B	ASI, HTN	35A, 200V, 0.04A, 2.5V	F-48			
C40C	ASI, HTN	35A, 300V, 0.04A, 2.5V	F-48			
C40D	ASI, HTN	35A, 400V, 0.04A, 2.5V	F-48			
C40E	ASI, HTN	35A, 500V, 0.04A, 2.5V	F-48			
C40F	ASI, HTN	35A, 50V, 0.04A, 2.5V	F-48			
C40G	ASI, HTN	35A, 150V, 0.04A, 2.5V	F-48			
C40H	ASI, HTN	35A, 250V, 0.04A, 2.5V	F-48			 图 D-74
C40U	ASI, HTN	35A, 25V, 0.04A, 2.5V	F-48			
C45A	ASI, HTN	80A, 100V, 0.075A, 3V	D-74			
C45A#	GES	80A, 100V, 0.075A, 3V	F-76			
C45B	AMR, ASI	80A, 200V, 0.075A, 3V	B-74			
C45B#	GES	80A, 200V, 0.075A, 3V	F-76			
C45C	AMR, ASI	80A, 300V, 0.075A, 3V	B-74			 图 F-70
C45C#	GES	80A, 300V, 0.075A, 3V	F-76			
C45D	AMR, ASI	80A, 400V, 0.075A, 3V	B-74			
C45D#	GES	80A, 400V, 0.075A, 3V	F-76			
C45E	AMR, ASI	80A, 500V, 0.075A, 3V	B-74			
C45E#	GES	80A, 500V, 0.075A, 3V	F-76			
C45F	AMR, ASI	80A, 50V, 0.075A, 3V	B-74			
C45F#	GES	80A, 50V, 0.075A, 3V	F-76			

器件型号 Element type	厂名 Manufacturers	材料用途参数 Material Purpose Parameter	图号 Figure	国内外相似替换器件型号 Replace of similar type	备注 Notes	外形参考图 Reference shape
C45G	AMR, ASI	80A, 150V, 0.075A, 3V	B-74			 B-74
C45G#	GES	80A, 150V, 0.075A, 3V	F-76			
C45H	AMR, ASI	80A, 250V, 0.075A, 3V	B-74			 F-76
C45H#	GFS	80A, 250V, 0.075A, 3V	F-76			
C45M	AMR, ASI	80A, 600V, 0.075A, 3V	B-74			
C45M#	GES	80A, 600V, 0.075A, 3V	F-76			
C45N	AMR, ASI	80A, 800V, 0.07A, 3V	B-74			
C45N#	GES	80A, 800V, 0.075A, 3V	F-76			
C45P	AMR, ASI	55A, 1kV, 0.07A, 2.5V	B-74			
C45P#	GES	80A, 1kV, 0.075A, 3V	F-76			
C45PA	AMR, ASI	80A, 1.1kV, 0.075A, 3V	B-74			
C45PA#	GES	80A, 1.1kV, 0.075A, 3V	F-76			
C45PB	AMR, ASI	80A, 1.2kV, 0.075A, 3V	B-74			
C45PB#	GES	80A, 1.2kV, 0.075A, 3V	F-76			
C45S	AMR, HTA	80A, 700V, 0.075A, 3V	B-74			
C45S#	GES	80A, 700V, 0.075A, 3V	F-76			
C45T	AMR, ASI	80A, 900V, 0.075A, 3V	B-74			
C45T#	GES	80A, 900V, 0.075A, 3V	F-76			
C45U	AMR, ASI	55A, 25V, 0.075A, 3V	B-74			
C45U#	GES	80A, 25V, 0.075A, 3V	F-76			
C46A	AMR, ASI	80A, 100V, 0.075A, 3V	B-74			
C46A#	GES	80A, 100V, 0.075A, 3V	F-76			
C46B	AMR, ASI	80A, 200V, 0.075A, 3V	B-74			
C46B#	GES	80A, 200V, 0.075A, 3V	F-76			
C46C	AMR, ASI	80A, 300V, 0.075A, 3V	B-74			
C46C#	GES	80A, 300V, 0.075A, 2V	F-76			
C46D	AMR, ASI	80A, 400V, 0.075A, 3V	B-74			
C46D#	GES	80A, 400V, 0.075A, 3V	F-76			
C46E	AMR, ASI	80A, 500V, 0.075A, 3V	B-74			

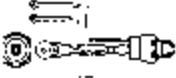

器件型号 Element type	厂名 Manufacturers	材料用途参数 Material Purpose Parameter	图号 Figure	国内外相似替换器件型号 Replace of similar type	备注 Notes	外形参考图 Reference shape
C46E#	GES	80A, 500V, 0.075A, 3V	F-76			
C46F	AMR, ASI	80A, 50V, 0.075A, 3V	B-74			
C46F#	GES	80A, 50V, 0.075A, 3V	F-76			
C46G	AMR, ASI	80A, 150V, 0.075A, 3V	B-74			
C46G#	GES	80A, 150V, 0.075A, 3V	F-76			
C46H	AMR, ASI	80A, 250V, 0.075A, 3V	B-74			
C46H#	GES	80A, 250V, 0.075A, 3V	F-76			
C46M	AMR, ASI	80A, 600V, 0.075A, 3V	B-74			
C46M#	GES	80A, 600V, 0.075A, 3V	F-76			
C46N	AMR, ASI	80A, 800V, 0.07A, 3V	B-74			
C46N#	GES	80A, 800V, 0.075A, 3V	F-76			
C46P	AMR, ASI	55A, 1kV, 0.07A, 2.5V	B-74			
C46P#	GES	80A, 1kV, 0.075A, 3V	F-76			
C46PA	AMR, ASI	80A, 1.1kV, 0.075A, 3V	B-74			
C46PA#	GES	80A, 1.1kV, 0.075A, 3V	F-76			
C46PB	AMR, ASI	80A, 1.2kV, 0.075A, 3V	B-74			
C46PB#	GES	80A, 1.2kV, 0.075A, 3V	F-76			
C46S	AMR, ASI	80A, 700V, 0.075A, 3V	B-74			
C46S#	GES	80A, 700V, 0.075A, 3V	F-76			
C46T	AMR, ASI	80A, 900V, 0.075A, 3V	B-74			
C46T#	GES	80A, 900V, 0.075A, 3V	F-76			
C46U	AMR, ASI	55A, 25V, 0.075A, 3V	B-74			
C46U#	GES	80A, 25V, 0.075A, 3V	F-76			
C49A10, 20	GES	110A, 100V, 0.15A, 3V	F-91	ECG5371		
C49B10, 20	GES	110A, 200V, 0.15A, 3V	F-91	ECG5371		
C49C10, 20	GES	110A, 300V, 0.15A, 3V	F-91	ECG5371		
C49D10, 20	GES	110A, 400V, 0.15A, 3V	F-91	ECG5371		
C49E10, 20	GES	110A, 500V, 0.15A, 3V	F-91	ECG5371		
C49M10, 20	GES	110A, 600V, 0.15A, 3V	F-91	ECG5371		

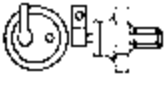
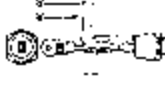



器件型号 Element type	厂名 Manufacturers	材料用途 参数 Material Purpose Parameter	图号 Figure	国内外相似替换器件型号 Replace of similar type	备注 Notes	外形参考图 Reference shape
C50A	AMR, ASI	110A, 100V, 0.075A, 3V	F-91	ECG101		 图 F-91
C50AX500	ASI, GES	70A, 100V, 0.15A, 3.5V	F-91			
C50B	AMR, ASI	110A, 200V, 0.075A, 3V	F-91			 图 B-74
C50BX500	ASI, GES	70A, 200V, 0.15A, 3.5V	F-91			
C50C	AMR, ASI	110A, 300V, 0.075A, 3V	F-91			
C50CX500	ASI, GES	70A, 300V, 0.15A, 3.5V	F-91			
C50D	AMR, ASI	110A, 400V, 0.075A, 3V	F-91			
C50DX500	ASI, GES	70A, 400V, 0.15A, 3.5V	F-91			
C50E	AMR, ASI	110A, 500V, 0.075A, 3V	F-91			
C50EX500	ASI, GES	70A, 500V, 0.15A, 3.5V	F-91	ECG5572		
C50F	AMR, ASI	110A, 50V, 0.075A, 3V	F-91			
C50G	AMR, ASI	110A, 150V, 0.075A, 3V	F-91			
C50H	AMR, ASI	110A, 250V, 0.075A, 3V	F-91			
C50M	AMR, ASI	110A, 600V, 0.075A, 3V	F-91			
C50MX500	ASI, GES	70A, 600V, 0.15A, 3.5V	F-91			
C50N	AMR, ASI	110A, 800V, 0.075A, 3V	F-91			
C50P	AMR, ASI	110A, 1kV, 0.075A, 3V	F-91			
C50PA	ASI, GES	110A, 1.1kV, 0.075A, 3V	F-91			
C50PB	ASI, GES	110A, 1.2kV, 0.075A, 3V	F-91			
C50S	AMR, ASI	110A, 700V, 0.075A, 3V	F-91			
C50SX500	ASI, GES	70A, 700V, 0.15A, 3.5V	F-91			
C50T	AMR, ASI	110A, 900V, 0.075A, 3V	F-91			
C50U	AMR, ASI	110A, 25V, 0.075A, 3V	F-91			
C52A	AMR, ASI	110A, 100V, 0.075A, 3V	B-74			
C52B	AMR, ASI	110A, 200V, 0.075A, 3V	B-74			
C52C	AMR, ASI	110A, 300V, 0.075A, 3V	B 74			
C52D	AMR, ASI	110A, 400V, 0.075A, 3V	B-74			
C52E	AMR, ASI	110A, 500V, 0.075A, 3V	B-74			
C52F	AMR, ASI	110A, 50V, 0.075A, 3V	B-74			



器件型号 Element type	厂名 Manufacturers	材料用途参数 Material Purpose Parameter	图号 Figure	国内外相似替换器件型号 Replace of similar type	备注 Notes	外形参考图 Reference shape
C52G	AMR, ASI	110A, 150V, 0.075A, 3V	B-74			 图 B-74
C52H	AMR, ASI	110A, 250V, 0.075A, 3V	B-74			
C52M	AMR, ASI	110A, 600V, 0.075A, 3V	B-74			
C52N	AMR, ASI	110A, 800V, 0.075A, 3V	B-74			
C52P	AMR, ASI	110A, 1kV, 0.075A, 3V	B-74			
C52PA	AMR, ASI	110A, 1.1kV, 0.075A, 3V	B-74			
C52PB	AMR, ASI	110A, 1.2kV, 0.075A, 3V	B-74			
C52S	AMR, ASI	110A, 700V, 0.075A, 3V	B-74			
C52T	AMR, ASI	110A, 900V, 0.075A, 3V	B-74			
C52U	AMR, ASI	110A, 25V, 0.075A, 3V	B-74			
C55A	AMR, ASI	110A, 100V, 0.07A, 3V	F-91			 图 F-91
C55B	AMR, ASI	110A, 200V, 0.07A, 3V	F-91			
C55C	AMR, ASI	110A, 300V, 0.07A, 3V	F-91			
C55D	AMR, ASI	110A, 400V, 0.07A, 3V	F-91			
C55E	AMR, ASI	110A, 500V, 0.07A, 3V	F-91			
C55F	AMR, ASI	110A, 50V, 0.075, 3V	F-75			
C55G	AMR, ASI	110A, 150V, 0.07A, 3V	F-91			
C55H	AMR, ASI	110A, 250V, 0.07A, 3V	F-91			
C55M	AMR, ASI	110A, 600V, 0.07A, 3V	F-91			
C55U	AMR, ASI	110A, 25V, 0.075A, 3V	F-75			
C56A	AMR, ASI	110A, 100V, 0.07A, 3V	B-74			 图 F-51
C56B	AMR, ASI	110A, 200V, 0.07A, 3V	B-74			
C56C	AMR, ASI	110A, 300V, 0.07A, 3V	B-74			
C56D	AMR, ASI	110A, 400V, 0.07A, 3V	B-74			
C56E	AMR, ASI	110A, 500V, 0.07A, 3V	B-74			
C56F	AMR, ASI	110A, 50V, 0.075A, 3V	F-51			
C56G	AMR, ASI	110A, 150V, 0.07A, 3V	B-74			
C56H	AMR, ASI	110A, 250V, 0.07A, 3V	B-74			

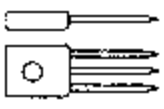
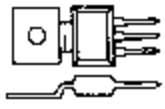
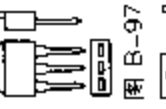
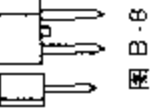

器件型号 Element type	厂名 Manufacturers	材料用途参数 Material Purpose Parameter	图号 Figure	国内外相似替换器件型号 Replace of similar type	备注 Notes	外形参考图 Reference shape
C55M	AMR, ASI	110A, 600V, 0.07A, 3V	B-74			
C56U	AMR, ASI	110A, 25V, 0.075A, 3V	F-51			图 B-74
C60A	AMH, ASI	110A, 100V, 0.07A, 2.5V	F-91			
C60B	AMR, ASI	110A, 200V, 0.07A, 2.5V	F-91			图 F-51
C60C	AMR, ASI	110A, 300V, 0.07A, 2.5V	F-91			
C60D	AMR, ASI	110A, 400V, 0.07A, 2.5V	F-91			图 F-91
C60E	AMR, ASI	110A, 500V, 0.07A, 2.5V	F-91			
C60F	AMR, ASI	110A, 50V, 0.07A, 2.5V	F-91			
C60G	AMR, ASI	110A, 150V, 0.07A, 2.5V	F-91			
C60H	AMR, ASI	110A, 250V, 0.07A, 2.5V	F-91			
C60U	AMR, ASI	110A, 25V, 0.07A, 2.5V	F-91	BTW23-600R		
C62A	AMR, ASI	110A, 100V, 0.07A, 2.5V	B-74			
C62B	AMR, ASI	110A, 200V, 0.07A, 2.5V	R-74			
C62C	AMR, ASI	110A, 300V, 0.07A, 2.5V	B-74			
C62D	AMR, ASI	110A, 400V, 0.07A, 2.5V	B-74			
C62E	AMR, ASI	110A, 500V, 0.07A, 2.5V	B-74			
C62F	AMR, ASI	110A, 50V, 0.07A, 2.5V	B-74			
C62G	AMR, ASI	110A, 150V, 0.07A, 2.5V	B-74			
C62H	AMR, ASI	110A, 250V, 0.07A, 2.5V	B-74			
C62U	AMR, ASI	110A, 25V, 0.07A, 2.5V	B-74			
C103A	AMR, ASI	0.8A, 100V, 200 μ A, 0.8V	B-36	BTX46, EC103A, SK3122, 2N5062		
C103B	AMR, ASI	0.8A, 200V, 200 μ A, 0.8V	B-36	BTX47, EC103B, SK3627, SK5404, 2N5064		
C103Q	AMR, ASI	0.8A, 15V, 200 μ A, 0.8V	R-36			
C103Y	AMR, GES	0.8A, 30V, 200 μ A, 0.8V	B-36	BTX44, EC103Y, SK3950, SK5400, 2N5060		图 B-36
C103YY		0.8A, 60V		2N5061		

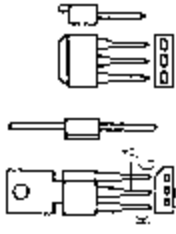
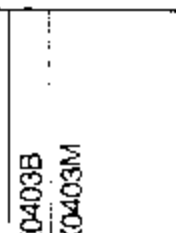
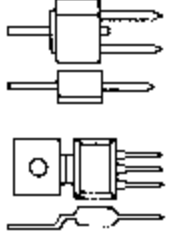
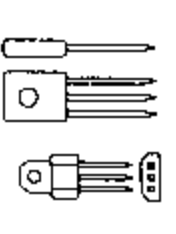
器件型号 Element type	厂名 Manufacturers	材料用途参数 Material Purpose Parameter	图号 Figure	国内外相似替换器件型号 Replace of similar type	备注 Notes	外形参考图 Reference shape
C106A	AMR, GTC	50Hz-Thy 4A, 100V, 200 μ A, 0.8V	B-6	C108A, T106A, TAG106A, TAG108A, X0403B		 图 B-6
C106A1	AMR, CEN	4A, 100V, 200 μ A, 0.8V	B-21	ECG5454		
C106A2	AMR, CEN	2.2A, 100V, 200 μ A, 0.8V	B-97	ECG5454		
C106A3	AMR, ASI	4A, 100V, 200 μ A, 0.8V	B-6	ECG5454		
C106A4	AMR, ASI	2.2A, 100V, 200 μ A, 0.8V	B-97	ECG5454		 图 B-6
C106B	AMR, GTC	50Hz-Thy 4A, 200V, 200 μ A, 0.8V	B-6	C108B, T106B, TAG106B, TAG108B, X0403B		
C106B1	AMR, CEN	4A, 200V, 200 μ A, 0.8V	B-89	ECG5455		
C106B2	AMR, CEN	2.4A, 200V, 200 μ A, 0.8V	B-97	ECG5455		
C106B3	AMR, CEN	4A, 200V, 200 μ A, 0.8V	B-21	ECG5455		 图 B-21
C106B4	AMR, CEN	2.4A, 200V, 200 μ A, 0.8V	B-8	ECG5455		
C106B12, 21, 32, 41		4A, 200V				
C106C	ASJ, GTC	50Hz-Thy 4A, 300V, 200 μ A, 0.8V	B-6	C106D, C106C, T106C, TAG106C, TAG108C, X0403D		
C106C1	AMR, CEN	4A, 300V, 200 μ A, 0.8V	B-89	ECG5457		
C106C2	AMR, CEN	2.4A, 300V, 200 μ A, 0.8V	B-97	ECG5457		
C106C3	AMR, CEN	4A, 300V, 200 μ A, 0.8V	B-21	ECG5457		
C106C4	AMR, CEN	2.4A, 300V, 200 μ A, 0.8V	B-8	ECG5457		 图 B-89
C106D	AMR, GTC	50Hz-Thy 4A, 400V, 200 μ A, 0.8V	B-6	C108D, T106D, TAG106D, TAG108D, X0403D		
C106D1	AMR, CEN	4A, 400V, 200 μ A, 0.8V	B-89	ECG5457		
C106D2	AMR, CEN	2.4A, 400V, 200 μ A, 0.8V	B-97	ECG5457		
C106D3	AMR, CEN	4A, 400V, 200 μ A, 0.8V	B-21	ECG5457		 图 B-89
C106D4	AMR, CEN	2.4A, 400V, 200 μ A, 0.8V	B-8	ECG5457		
C106E	GTC, MOI	50Hz-Thy 4A, 500V, 200 μ A, 0.8V	B-6	C108E, TAG106E, TAG108E, X0403M		
C106E1	GES	4A, 500V, 200 μ A, 0.8V	B-89			
C106E2	GES	2.4A, 500V, 200 μ A, 0.8V	B-97			 图 B-8
C106E3	GES	4A, 500V, 200 μ A, 0.8V	B-21			
C106E4	GES	2.4A, 500V, 200 μ A, 0.8V	B-8			
C106F	ASJ, GTC	50Hz-Thy 4A, 50V, 200 μ A, 0.8V	B-6	C108F, T106F, TAG106F, TAG108F, X0403B		

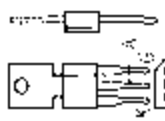
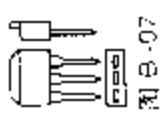
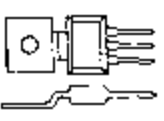
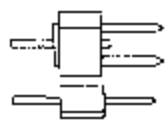



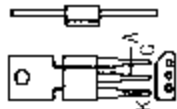
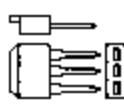
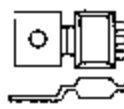
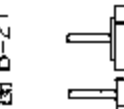
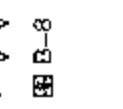

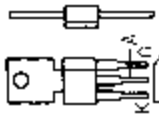
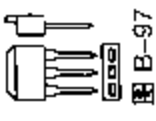
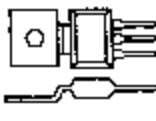
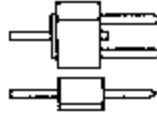
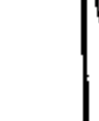
器件型号 Element type	厂名 Manufacturers	材料用途参数 Material Purpose Parameter	图号 Figure	国内外相似替换器件型号 Replace of similar type	备注 Notes	外形参考图 Reference shape
C106F1	AMR, CEN	4A, 50V, 200 μ A, 0.8V	B-89	ECG5453		 图 B-89 图 B-97
C106F2	AMR, CEN	2.4A, 50V, 200 μ A, 0.8V	B-97	ECG5453		
C106F3	AMR, CEN	4A, 50V, 200 μ A, 0.8V	B-21	ECG5453		
C106F4	AMR, CEN	2.4A, 50V, 200 μ A, 0.8V	B-8	ECG5453		
C106G		50Hz-Thy 2.2A, 150V	B-98	C108G, TAG106G, TAG108G, X0403B		 图 B-89 图 B-97
C106M	GTC, MOT	50Hz-Thy 4A, 600V, 200 μ A, 0.8V	B-6	C108M, TAG106M, TAG108M, X0403M		
C106M1	GES	4A, 600V, 200 μ A, 0.8V	B-89			
C106M2	GES	2.4A, 600V, 200 μ A, 0.8V	B-97			
C106M3	GES	4A, 600V, 200 μ A, 0.8V	B-97			
C106M4	GES	2.4A, 600V, 200 μ A, 0.8V	B-8			
C106N		4A, 600V		C106M		
C106Q	GTC, MOT	50Hz-Thy 4A, 15V, 200 μ A, 0.8V	B-6	C106M, C108Q, T106Q, TAG106Q, TAG108Q, X0403B		 图 D-21 图 B-8
C106Q1	AMR, CEN	4A, 15V, 200 μ A, 0.8V	B-89	ECG5452		
C106Q2	AMR, CEN	2.4A, 15V, 200 μ A, 0.8V	B-97	ECG5452		
C106Q3	AMR, CEN	4A, 15V, 200 μ A, 0.8V	B-21	ECG5452		
C106Q4	AMR, CEN	2.4A, 15V, 200 μ A, 0.8V	B-8	ECG5452		
C106Y		50Hz-Thy 4A, 30V, 0.0002A		C106F, C108Y, TAG106Y, TAG108Y, X0403B		
C106Y1	AMR, CEN	4A, 30V, 200 μ A, 0.8V	B-89	ECG5452		
C106Y2	AMR, CEN	2.4A, 30V, 200 μ A, 0.8V	B-97	ECG5452		
C106Y3	AMR, CEN	4A, 30V, 200 μ A, 0.8V	B-21	ECG5452		
C106Y4	AMR, CEN	2.4A, 30V, 200 μ A, 0.8V	B-8	ECG5452		
C107A	GTC, NJS	50Hz-Thy 2.4A, 100V, 500 μ A, 0.8V	B-89	C106A, C108A, SK5454, SK6754, T107A, TAG107A, TAG108A, X0403B, 2N6238		 图 B-96 图 B-6
C107A1	AMR, CEN	3.7A, 100V, 500 μ A, 0.8V	B-89	ECG5454		
C107A2, 4	AMR, CEN	2.2A, 100V, 500 μ A, 0.8V	B-97	ECG5454		
C107B	GTC, NJS	50Hz-Thy 2.4A, 200V, 500 μ A, 0.8V	B-89	C106B, C108B, SK3597, SK5455, T107B, TAG107B, TAG108B, X0403B, 2N6239		

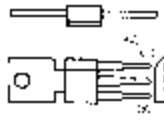
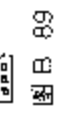

器件型号 Element type	厂名 Manufacturers	材料用途参数 Material Purpose Parameter	图号 Figure	国内外相似替换器件型号 Replace of similar type	备注 Notes	外形参考图 Reference shape
C107B1	AMR, CEN	3.7A, 200V, 500 μ A, 0.8V	B-89	ECG5455		 图 B-89
C107B2	AMR, CEN	2.2A, 200V, 500 μ A, 0.8V	B-97	ECG5455		
C107B3	AMR, CEN	3.7A, 200V, 500 μ A, 0.8V	B-21	ECG5455		
C107B4	AMR, CEN	2.2A, 200V, 500 μ A, 0.8V	B-8	ECG5455		
C107C	GTC	50Hz-Thy 2.4A, 300V, 500 μ A, 0.8V	B-89	C106C, C106D, C108C, SK3598, SK5457, T107C, TAG107C, TAG108C, X0403D, 2N6240		 图 B-89
C107C1	AMR, CEN	3.7A, 300V, 500 μ A, 0.8V	B-89	ECG5457		
C107C2	AMR, CEN	2.2A, 300V, 500 μ A, 0.8V	B-97	ECG5457		
C107C3	AMR, CEN	3.7A, 300V, 500 μ A, 0.8V	B-21	ECG5457		
C107C4	AMR, CEN	2.2A, 300V, 500 μ A, 0.8V	B-8	ECG5457		 图 B-21
C107D	GTC	50Hz-Thy 2.4A, 400V, 500 μ A, 0.8V	B-89	C106D, C108D, SK3598, SK5457, T107D, TAG107D, TAG108D, X0403D, 2N6240		
C107D1	AMR, CEN	3.7A, 400V, 500 μ A, 0.8V	B-89	ECG5457		
C107D2	AMR, CEN	2.2A, 400V, 500 μ A, 0.8V	B-97	ECG5457		
C107D3	AMR, CEN	3.7A, 400V, 500 μ A, 0.8V	B-21	ECG5457		 图 B-8
C107D4	AMR, CEN	2.2A, 400V, 500 μ A, 0.8V	B-8	ECG5457		
C107E	GTC	50Hz-Thy 2.4A, 500V, 500 μ A, 0.8V	B-89	C106E, C106M, C108E, TAG107E, TAG108F, X0403M, 2N6241		
C107E1	GES	3.7A, 500V, 500 μ A, 0.8V	B-89			
C107E2	GES	2.2A, 500V, 500 μ A, 0.8V	B-97			 图 B-8
C107E3	GES	3.7A, 500V, 500 μ A, 0.8V	B-21			
C107E4	GES	2.2A, 500V, 500 μ A, 0.8V	B-8			
C107F	GTC, NJS	50Hz-Thy 2.4A, 50V, 500 μ A, 0.8V	B-89	C106F, T107F, C108F, TAG107F, TAG108F, X0403B, 2N6237		
C107F1	AMR, CEN	3.7A, 50V, 500 μ A, 0.8V	B-89	ECG5453		 图 B-8
C107F2	AMR, CEN	2.2A, 50V, 500 μ A, 0.8V	B-97	ECG5453		
C107F3	AMR, CEN	3.7A, 50V, 500 μ A, 0.8V	B-21	ECG5453		
C107F4	AMR, CEN	2.2A, 50V, 500 μ A, 0.8V	B-8	ECG5453		
C107G		50Hz-Thy 2A, 150V, 0.0005A	B-98	C108G, TAG107G, TAG108G, X0403B		

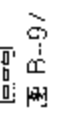
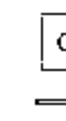
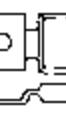
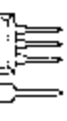
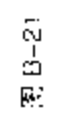
器件型号 Element type	厂名 Manufacturers	材料用途参数 Material Purpose Parameter	图号 Figure	国内外相似替换器件型号 Replace of similar type	备注 Notes	外形参考图 Reference shape
C107M	GTC	50Hz-Thy 2.4A, 600V, 500 μ A, 0.8V	B-89	C106M, C108M, TAG107M, TAG018M, X0403M, 2N6241		 图 B-89
C107M1	GES	3.7A, 600V, 500 μ A, 0.8V	B-89			
C107M2	GES	2.2A, 600V, 500 μ A, 0.8V	B-97			
C107M3	GES	3.7A, 600V, 500 μ A, 0.8V	B-21			
C107M4	GES	2.2A, 600V, 500 μ A, 0.8V	B-8			
C107Q	GTC, NJS	50Hz-Thy 2.4A, 15V, 500 μ A, 0.8V	B-89	C106B, C106Q, C108Q, SK5452, SK6752, T107Q, TAG107Q, TAG108Q, X0403B, 2N6236		 图 B-89
C107Q1	AMR, CEN	3.7A, 15V, 500 μ A, 0.8V	B-89	ECG5452		
C107Q2	AMR, CEN	2.2A, 15V, 500 μ A, 0.8V	B-97	ECG5452		
C107Q3	AMR, CEN	3.7A, 15V, 500 μ A, 0.8V	B-21	ECG5452		
C107Q4	AMR, CEN	2.2A, 15V, 500 μ A, 0.8V	B-8	ECG5452		
C107Y	GTC, NJS	50Hz-Thy 2.4A, 30V, 500 μ A, 0.8V	B-89	C106F, C106Y, C108Y, SK5452, SK6752, T107Y, TAG107Y, TAG108Y, X0403B, 2N6236		 图 B-97
C107Y1	AMR, CEN	3.7A, 30V, 500 μ A, 0.8V	B-89	ECG5452		
C107Y2	AMR, CEN	2.2A, 30V, 500 μ A, 0.8V	B-97	ECG5452		
C107Y3	AMR, CEN	3.7A, 30V, 500 μ A, 0.8V	B-21	ECG5452		
C107Y4	AMR, CEN	2.2A, 30V, 500 μ A, 0.8V	B-8	ECG5452		
C108A	GTC, NJS	50Hz-Thy 4A, 100V, 200 μ A, 0.8V	B-89	S1006F1, SK5454, SK6754, TAG108A, TIC106A		 图 B-21
C108A1	GTC, NJS	5A, 100V, 200 μ A, 0.8V	B-89	MCR106-2		
C108A2	GES	3A, 100V, 200 μ A, 0.8V	B-97			
C108A3	GES	5A, 100V, 200 μ A, 0.8V	B-21			
C108A4	GES	3A, 100V, 200 μ A, 0.8V	B-8			
C108B	GTC, NJS	50Hz-Thy 4A, 200V, 200 μ A, 0.8V	B-89	S2006F1, TAG108B, TAG623-200, TIC106B		 图 B-8
C108B1	GES, NJS	5A, 200V, 200 μ A, 0.8V	B-89	MCR106-4		
C108B2	GES	3A, 200V, 200 μ A, 0.8V	B-97			
C108B3	GES	5A, 200V, 200 μ A, 0.8V	B-21			
C108B4	GES	3A, 200V, 200 μ A, 0.8V	B-8			

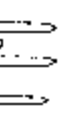
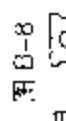
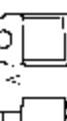
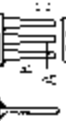
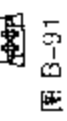
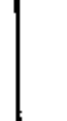
器件型号 Element type	厂名 Manufacturers	材料用途参数 Material Purpose Parameter	图号 Figure	国内外相似替换器件型号 Replace of similar type	备注 Notes	外形参考图 Reference shape
C108C	GTC	50Hz-Thy 4A, 300V, 200 μ A, 0.8V	B-89	TAG108C, TAG623-300, TIC106C		 图 B-89
C108C1	GES	5A, 300V, 200 μ A, 0.8V	B-89	MCR106-6		
C108C2	GES	3A, 300V, 200 μ A, 0.8V	B-97			
C108C3	GES	5A, 300V, 200 μ A, 0.8V	B-21			
C108C4	GES	3A, 300V, 200 μ A, 0.8V	B-8			
C108D	GTC	50Hz-Thy 4A, 400V, 200 μ A, 0.8V	B-89	S4006F1, TAG108D, TAG623-400, TIC106D		 图 B-89
C108D1	GES	5A, 400V, 200 μ A, 0.8V	B-89	MCR106-6		
C108D2	GES	3A, 400V, 200 μ A, 0.8V	B-97	MCR106-6		
C108D3	GES	5A, 400V, 200 μ A, 0.8V	B-21			
C108D4	GES	3A, 400V, 200 μ A, 0.8V	B-8			
C108E	GTC	50Hz-Thy 4A, 500V, 200 μ A, 0.8V	B-89	S6006F1, TAG108E, TAG623-500, TIC106E		 图 B-97
C108E1	GES	5A, 500V, 200 μ A, 0.8V	B-89	MCR106-8		
C108E2	GES	3A, 500V, 200 μ A, 0.8V	B-97			
C108E3	GES	5A, 500V, 200 μ A, 0.8V	B-21			
C108E4	GES	3A, 500V, 200 μ A, 0.8V	B-8			
C108F	GTC, NJS	50Hz-Thy 4A, 50V, 200 μ A, 0.8V	B-89	S6006F1, SK5453, SK6753, TAG108F, TIC106F		 图 B-21
C108F1	GES, NJS	5A, 50V, 200 μ A, 0.8V	B-89	MCR106-2		
C108F2	GES	3A, 50V, 200 μ A, 0.8V	B-97			
C108F3	GES	5A, 50V, 200 μ A, 0.8V	B-21			
C108F4	GES	3A, 50V, 200 μ A, 0.8V	B-8			
C108G		50Hz-Thy 3.3A, 150V, 0.0002A	B-98	TAG108G, TAG623-200, TIC106B		 图 B-8
C108M	GTC	50Hz-Thy 4A, 600V, 200 μ A, 0.8V	B-89	S6006F1, TAG108M, TAG623-600, TIC106M		
C108M1	GES	5A, 600V, 200 μ A, 0.8V	B-89			
C108M2	GES	3A, 600V, 200 μ A, 0.8V	B-97			
C108M3	GES	5A, 600V, 200 μ A, 0.8V	B-21			
C108M4	GES	3A, 600V, 200 μ A, 0.8V	B-8			
C108Q	GTC, NJS	50Hz-Thy 4A, 15V, 200 μ A, 0.8V	B-89	S0306F1, SK6752, SK5452, TAG108Q, TAG623 100, TIC106Y		

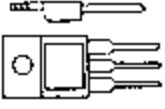
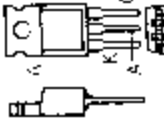
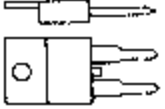

器件型号 Element type	厂名 Manufacturers	材料用途参数 Material: Purpose Parameter	图号 Figure	国内外相似替换器件型号 Replace of similar type	备注 Notes	外形参考图 Reference shape
C108Q1	GES, NJS	5A, 15V, 200 μ A, 0.8V	B-89			
C108Q2	GES	3A, 15V, 200 μ A, 0.8V	B-97			
C108Q3	GES	5A, 15V, 200 μ A, 0.8V	B-21			
C108Q4	GES	3A, 15V, 200 μ A, 0.8V	B-8			
C108Y	GTC	50Hz-Thy 4A, 30V, 200 μ A, 0.8V	B-89	S0306F1, SK6752, SK5452, TAG108Y, TAG623-100, TIC106Y		
C108Y1	GES, NJS	5A, 30V, 200 μ A, 0.8V	B-89			
C108Y2	GES	3A, 30V, 200 μ A, 0.8V	B-97			
C108Y3	GES	5A, 30V, 200 μ A, 0.8V	B-21			
C108Y4	GES	3A, 30V, 200 μ A, 0.8V	B-8			
C116A		50Hz-Thy 8A, 100V, 0.025A, 0.03A	B-98	C122A, CS6-02, TAG625-100, TIC116A		
C116B		50Hz-Thy 8A, 200V, 0.025A, 0.03A	B-98	C122B, CS6-02, TAG625-200, TIC116B		
C116C		50Hz-Thy 8A, 300V, 0.025A, 0.03A	B-98	C122C, CS6-04, TAG625-300, TIC116C		
C116D		50Hz-Thy 8A, 400V, 0.025A, 0.03A	B-98	C122D, CS6-04, TAG625-400, TIC116D		
C116E		50Hz-Thy 8A, 500V, 0.025A, 0.03A	B-98	C122E, CS6-06, TAG625-500, TIC116E		
C116F		50Hz-Thy 8A, 50V, 0.025A, 0.03A	B-98	C122F, CS6-02, TAG625-100, TIC116F		
C116M		50Hz-Thy 8A, 600V, 0.025A, 0.03A	B-98	C122M, CS6-06, TAG625-600, TIC116M		
C118A	GES	50Hz-Thy 8A, 100V, 200 μ A, 1.5V	B-89	TAG628-100, S4060A		
C118B	GES	50Hz-Thy 8A, 200V, 200 μ A, 1.5V	B-89	MCR72-4, S4060B, TAG628-200		
C118C	GES	50Hz-Thy 8A, 300V, 200 μ A, 1.5V	B-89	MCR72-5, S4060C, TAG628-300		
C118D	GES	50Hz-Thy 8A, 400V, 200 μ A, 1.5V	B-89	MCR72-6, S4060D, TAG628-400		
C118E	GES	50Hz-Thy 8A, 500V, 200 μ A, 1.5V	B-89	MCR72-7, S4060E, TAG628-500		
C118F	GES	50Hz-Thy 8A, 50V, 200 μ A, 1.5V	B-89	MCR72-2, S4060F, TAG628-100		
C118M	GES	50Hz-Thy 8A, 600V, 200 μ A, 1.5V	B-89	MCR72-8, S4060M, TAG628-600		
C122A, A1	GES, GTC	50Hz-Thy 8A, 100V, 0.025A, 1.5V	B-91	BSIC1026M, CS6-02, S1008L, TAG122-100, TAG660-100, TIC116A		

器件型号 Element type	厂名 Manufacturers	材料用途参数 Material Purpose Parameter	图号 Figure	国内外相似替换器件型号 Replace of similar type	备注 Notes	外形参考图 Reference shape
C122B, B1	GES, GTC	50Hz-Thy 8A, 200V, 0.025A, 1.5V	B-10	BS1C1026M, CS6-02, S2008L, TAG122-200, TAG660-200, TIC116B		 图 B-10
C122C, C1	GES, GTC	50Hz-Thy 8A, 300V, 0.025A, 1.5V	B-91	BS1C1026M, C122C1, CS6-04, S4008L, SK3558, TAG660-400, TIC116C		
C122D, D1	GES, GTC	50Hz-Thy 8A, 400V, 0.025A, 1.5V	B-10	BS1C1026M, C122D1, CS6-04, S4008L, SK3558, TAG122-400, TAG660-400, TIC116D		
C122E, E1	GES, GTC	50Hz-Thy 6A, 500V, 0.025A, 1.5V	B-91	BS1C1033M, C122E1, CS6-06, S5008L, SK3573, SK5466, TAG122-500, TAG660-500, TIC116E		
C122F, F1	GES, GTC	50Hz-Thy 8A, 50V, 0.025A, 1.5V	B-10	BS1C1026M, CS6-02, C122F1, S0508L, SK3685, SK5461, TAG660-100, TIC116F		 图 B-91
C122M, M1	GES, GTC	50Hz-Thy 8A, 600V, 0.025A, 1.5V	B-10	BS1C1040M, CS6-02, S6008L, TAG122-600, TAG660-600, TIC116M		 图 B-9
C122N1, S1		8A, 600V	B-9			
C124A	GES	8A, 100V, 0.025A, 1.5V	B-10			
C124B	GES	8A, 200V, 0.025A, 1.5V	B-10			
C124C	GES	8A, 300V, 0.025A, 1.5V	B-10			
C124D	GES	8A, 400V, 0.025A, 1.5V	B-10			
C124E	GES	8A, 500V, 0.025A, 1.5V	B-10			
C124F	GES	8A, 50V, 0.025A, 1.5V	B-10			
C124M	GES	8A, 600V, 0.025A, 1.5V	B-10			
C126A	GES, NJS	12A, 100V, 0.025A, 1.5V	B-9	S1010L, TAG666-100, 2N6395		
C126B	GES, NJS	12A, 200V, 0.025A, 1.5V	B-9	S2010L, TAG666-200, 2N6396		
C126C	GES, NJS	12A, 300V, 0.025A, 1.5V	B-9	S4010L, 2N6397		
C126D	GES, NJS	12A, 400V, 0.025A, 1.5V	B-9	S4010L, TAG666-400, 2N6397		
C126E	GES, NJS	12A, 500V, 0.025A, 1.5V	B-9	S5010L, TAG666-500, 2N6396		
C126F	GES, NJS	12A, 50V, 0.025A, 1.5V	B-9	S0510L, N6394		
C126M	GES, NJS	12A, 600V, 0.025A, 1.5V	B-9	S6010L, TAG666-600, 2N6398		

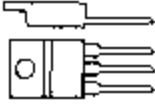
器件型号 Element type	厂名 Manufacturers	材料用途参数 Material Purpose Parameter	图号 Figure	国内外相似替换器件型号 Replace of similar type	备注 Notes	外形参考图 Reference photo
C127A		16A, 100V	B-22	2N6401		 图 B-22
C127B		16A, 200V	B-22	2N6402		
C127C		16A, 400V	B-22	2N6403		
C127D		16A, 400V	B-22	2N6403		
C127E		16A, 600V	B-22	2N6404		
C127F		16A, 50V	B-22	2N6400		
C127M		16A, 600V	B-22	2N6404		
C135A	ASI	35A, 100V, 0.04A, 2.5V	F-48	MCR3896, SK6642, SK5542, 2N3896		
C135B	ASI	35A, 200V, 0.04A, 2.5V	F-48	MCR3897, 2N3897		
C135C	ASI	35A, 300V, 0.04A, 2.5V	F-48	MCR3898, MCR3935-5		
C135D	ASI	35A, 400V, 0.04A, 2.5V	F-48	MCR3898, 2N3898		
C135E	ASI, HTN	35A, 500V, 0.04A, 2.5V	F-48	MCR3935-7, MCR3935-8A		
C135F		35A, 50V, 0.04A, 2.5V		MCR3935-2A		
C135M		35A, 600V, 0.04A, 2.5V		MCR3899		
C135N	ASI	35A, 800V, 0.04A, 2.5V	F-48	SK6648, SK5548		
C135S	ASI	35A, 700V, 0.04A, 2.5V	F-48	SK6648-5548		
C136D	GES	35A, 400V, 0.08A, 2.5V	F-48			
C136E	GES	35A, 500V, 0.08A, 2.5V	F-48			
C136M	GES	35A, 600V, 0.08A, 2.5V	F-48			
C137E	ASI, DIT	35A, 500V, 0.08A, 2.5V	F-48	MCR3935-8A, S6035H, TAG16N500DU,		
C137M	ASI, DIT	35A, 600V, 0.08A, 2.5V	F-48	MCR3899, S6035H, TAG16N500DU, T400062208		
C137N	ASI, DIT	35A, 800V, 0.08A, 2.5V	F-48	MCR3935-10A, SK5548, SK6648, TAG16N800LU, T400082208		
C137P	ASI, GES	35A, 1kV, 0.08A, 2.5V	F-48	SK6649, T400102208, TAG16N1000LU		
C137PA	ASI, GES	35A, 1.1kV, 0.08A, 2.5V	F-48	TAG16N1100LU		
C137PB	ASI, GES	35A, 1.2kV, 0.08A, 2.5V	F-48	T400122208, TAG16N1200LU		
C137S	ASI, GES	35A, 700V, 0.08A, 2.5V	F-48	MCR3935-10A, SK5548, SK6648, TAG16N700LU, T400722208		

器件型号 Element type	厂名 Manufacturers	材料用途参数 Material Purpose Parameter	图号 Figure	国内外相似替换器件型号 Replace of similar type	备注 Notes	外形参考图 Reference shape
C137T	ASL, GES	35A, 900V, 0.08A, 2.5V	F-48	SK6649, T400092208, TAG16N900LU		
C138E	GES, NJS	20A, 500V, 0.18A, 3V	F-48			
C138M	GES, NJS	20A, 600V, 0.18A, 3V	F-48			
C138N	GES, NJS	20A, 800V, 0.18A, 3V	F-48			
C138S	GES, NJS	20A, 700V, 0.18A, 3V	F-48			
C139E	GES, NJS	20A, 500V, 0.18A, 3V	F-48			
C139M	GES, NJS	20A, 600V, 0.18A, 3V	F-48			
C139N	GES, NJS	20A, 500V, 0.18A, 3V	F-48			
C139S	GES, NJS	20A, 700V, 0.18A, 3V	F-48			
C140A	GES, NJS	35A, 100V, 0.18A, 3V	F-48	ECG5360		
C140B	GES, NJS	35A, 200V, 0.18A, 3V	F-48	ECG5360		
C140C	GES, NJS	35A, 300V, 0.18A, 3V	F-48	ECG5360, TAG19F300DUFC, 2N3652		
C140D	GES, NJS	35A, 400V, 0.18A, 3V	F-48	ECG5360, TAG19F400DUFC, 2N3653		
C140F	GES, NJS	35A, 50V, 0.18A, 3V	F-48	ECG5360		
C141A	GES, NJS	35A, 100V, 0.18A, 3V	F-48	ECG5360		
C141B	GES, NJS	35A, 200V, 0.18A, 3V	F-48	ECG5360		
C141C	GES, NJS	35A, 300V, 0.18A, 3V	F-48	ECG5360, TAG19F300DUGC, 2N3657		
C141D	GES, NJS	35A, 400V, 0.18A, 3V	F-48	ECG5360, TAG19F400DUGC, 2N3658		
C141E	GES, NJS	35A, 500V, 0.15A, 3V	F-48	ECG5360		
C141F	GES, NJS	35A, 50V, 0.18A, 3V	F-48	ECG5360		
C144M	GES, NJS	35A, 600V, 0.15A, 3V	F-48			
C144N	GES, NJS	35A, 800V, 0.15A, 3V	F-48			
C144S	GES, NJS	35A, 700V, 0.15A, 3V	F-48			
C145E	AMR, HTN	55A, 500V, 0.15A, 3V	F-23			
C145M	AMR, HTN	55A, 600V, 0.15A, 3V	F-23			
C145N	AMR, HTN	55A, 800V, 0.15A, 3V	F-23			
C145P	AMR, HTN	55A, 1KV, 0.15A, 3V	F-23			
C145PA	AMR, HTN	55A, 1.1KV, 0.15A, 3V	F-23			



图 F-48



图 F-23



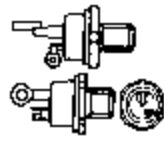



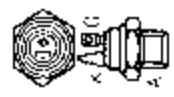



器件型号 Element type	厂名 Manufacturers	材料用途参数 Material Purpose Parameter	图号 Figure	国内外相似替换器件型号 Replace of similar type	备注 Notes	外形参考图 Reference shape
C145PB	AMR, HTN	55A, 1.2kV, 0.15A, 3V	F-23			
C145S	AMR, HTN	55A, 700V, 0.15A, 3V	F-23			
C147A	AMR, ASI	63A, 100V, 0.15A, 3V	F-21			
C147B	AMR, ASI	63A, 200V, 0.15A, 3V	F-21			
C147C	AMR, ASI	63A, 300V, 0.15A, 3V	F-21			
C147D	AMR, ASI	63A, 400V, 0.15A, 3V	F-21			
C147E	AMR, ASI	63A, 500V, 0.15A, 3V	F-21			
C147F	AMR, ASI	55A, 50V, 0.1A, 3V	F-21			
C147M	AMR, ASI	63A, 600V, 0.15A, 3V	F-21			
C147N	AMR, ASI	63A, 800V, 0.15A, 3V	F-21	ECG5569		
C147P	AMR, ASI	63A, 1kV, 0.15A, 3V	F-21	ECG5569		
C147PA	ASI, GES	63A, 1.1kV, 0.15A, 3V	F-21			
C147PB	ASI, GES	63A, 1.2kV, 0.15A, 3V	F-21			
C147S	ASI, GES	63A, 700V, 0.15A, 3V	F-21			
C147T	ASI, GES	63A, 900V, 0.15A, 3V	F-21	ECG5569		
C148M	GES	63A, 600V, 0.15A, 3V	F-21			
C148N	GES	63A, 800V, 0.15A, 3V	F-21			
C148P	GES	63A, 1kV, 0.15A, 3V	F-21			
C148PA	GES	63A, 1.1kV, 0.15A, 3V	F-21			
C148PB	GES	63A, 1.2kV, 0.15A, 3V	F-21			
C148S	GES	63A, 700V, 0.15A, 3V	F-21			
C148T	GES	63A, 900V, 0.15A, 3V	F-21			
C149A	GES, SST	63A, 100V, 0.15A, 3V	F-21			
C149B	GES, SST	63A, 200V, 0.15A, 3V	F-21			
C149C	GES, SST	63A, 300V, 0.15A, 3V	F-21			
C149D	GES, SST	63A, 400V, 0.15A, 3V	F-21			
C149E	GES, SST	63A, 500V, 0.15A, 3V	F-21			
C149M	GES, SST	63A, 600V, 0.15A, 3V	F-21			

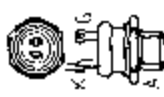

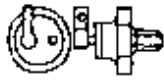
图 F-23

图 F-21

器件型号 Element type	厂名 Manufacturers	材料用途参数 Material Purpose Parameter	图号 Figure	国内外相似替换器件型号 Replace of similar type	备注 Notes	外形参考图 Reference shape	
C150E	AMR, ASI	110A, 500V, 0.15A, 3V	F-91			 图 F-91	
C150M	AMR, ASI	110A, 600V, 0.15A, 3V	F-91				
C150N	AMR, ASI	110A, 800V, 0.15A, 3V	F-91				
C150P	AMR, ASI	110A, 1kV, 0.15A, 3V	F-91				
C150PA	AMR, ASI	110A, 1.1kV, 0.15A, 3V	F-91	ECG5574			
C150PB	AMR, ASI	110A, 1.2kV, 0.15A, 3V	F-91	ECG5574			
C150PC	AMR, ASI	110A, 1.3kV, 0.15A, 3V	F-91				
C150S	AMR, ASI	110A, 700V, 0.15A, 3V	F-91				
C150T	AMR, ASI	110A, 900V, 0.15A, 3V	F-91	ECG128			
C151E	AMR, ASI	110A, 500V, 0.15A, 2.5V	F-91				
C151M	AMR, ASI	110A, 600V, 0.15A, 2.5V	F-91				
C151N	AMR, ASI	110A, 800V, 0.15A, 2.5V	F-91				
C151P	AMR, ASI	110A, 1kV, 0.15A, 2.5V	F-91				
C151PA	AMR, ASI	110A, 1.1kV, 0.15A, 3V	F-75				
C151PB	AMR, ASI	110A, 1.2kV, 0.15A, 3V	E-6				
C151PC	AMR, ASI	110A, 1.3kV, 0.15A, 3V	E-6				
C151S	AMR, ASI	110A, 700V, 0.15A, 2.5V	F-91				
C151T	AMR, ASI	110A, 900V, 0.15A, 2.5V	F-91				
C152E	AMR, ASI	110A, 500V, 0.15A, 3V	B-74			 图 F-75	
C152M	AMR, ASI	110A, 600V, 0.15A, 3V	B-74				
C152N	AMR, ASI	110A, 800V, 0.15A, 3V	B-74				
C152P	AMR, ASI	110A, 1kV, 0.15A, 3V	B-74				
C152PA	AMR, ASI	110A, 1.1kV, 0.15A, 3V	B-74				
C152PB	AMR, ASI	110A, 1.2kV, 0.15A, 3V	B-74				
C152PC	AMR, ASI	110A, 1.3kV, 0.15A, 3V	B-74				
C152T	AMR, ASI	110A, 900V, 0.15A, 3V	B-74	FCG5579 ECG5579			
C153E	AMR, ASI	110A, 500V, 0.15A, 2.5V	B-74	ECG5579			
C153M	AMR, ASI	110A, 600V, 0.15A, 2.5V	B-74				
C153N	AMR, ASI	110A, 800V, 0.15A, 2.5V	B-74				



器件型号 Element type	厂名 Manufacturers	材料 用途 参数 Material Purpose Parameter	图号 Figure	国内外相似替换器件型号 Replace of similar type	备注 Notes	外形参考图 Reference shape
C153P	AMR, ASI	110A, 1kV, 0.15A, 2.5V	B-74			
C153PA	AMR, ASI	110A, 1.1kV, 0.15A, 3V	F-51			
C153PB	AMR, ASI	110A, 1.2kV, 0.15A, 3V	B-74			
C153PC	AMR, ASI	110A, 1.3kV, 0.15A, 3V	B-74			
C153S	AMR, ASI	110A, 700V, 0.15A, 2.5V	B-74			
C153T	AMR, ASI	110A, 900V, 0.15A, 2.5V	B-74			
C154A	AMR, ASI	110A, 100V, 0.15A, 3V	F-91			
C154B	AMR, ASI	110A, 200V, 0.15A, 3V	F-91	SK3040, T507028084AQ		
C154C	AMR, ASI	110A, 300V, 0.15A, 3V	F-91	SK3040, T507038084AQ		
C154D	AMR, ASI	110A, 400V, 0.15A, 3V	F-91			
C154E	AMR, ASI	110A, 500V, 0.15A, 3V	F-91			
C154M	AMR, ASI	110A, 600V, 0.15A, 3V	F-91			
C155A	AMR, ASI	110A, 100V, 0.15A, 3V	F-91			
C155B	AMR, ASI	110A, 200V, 0.15A, 3V	F-91			
C155C	AMR, ASI	110A, 300V, 0.15A, 3V	F-91			
C155D	AMR, ASI	110A, 400V, 0.15A, 3V	F-91			
C155E	AMR, ASI	110A, 500V, 0.15A, 3V	F-91			
C155M	AMR, ASI	110A, 600V, 0.15A, 3V	F-91			
C156A	AMR, ASI	110A, 100V, 0.15A, 3V	F-50			
C156B	AMR, ASI	110A, 200V, 0.15A, 3V	F-47			
C156C	AMR, ASI	110A, 300V, 0.15A, 3V	F-47			
C156D	AMR, ASI	110A, 400V, 0.15A, 3V	F-50			
C156E	AMR, ASI	110A, 500V, 0.15A, 3V	F-50			
C156M	AMR, ASI	110A, 600V, 0.15A, 3V	F-50			
C157A	AMR, ASI	110A, 100V, 0.15A, 3V	F-50			
C157B	AMR, ASI	110A, 200V, 0.15A, 3V	F-47			
C157C	AMR, ASI	110A, 300V, 0.15A, 3V	F-47			
C157D	AMR, ASI	110A, 400V, 0.15A, 3V	F-50			
C157E	AMR, ASI	110A, 500V, 0.15A, 3V	F-50			

器件型号 Element type	厂名 Manufacturers	材料用途参数 Material Purpose Parameter	图号 Figure	国内外相似替换器件型号 Replace of similar type	备注 Notes	外形参考图 Reference shape
C157M	AMR, ASI	110A, 600V, 0.5A, 4V	F-50			 图 F-50
C158E	AMR, GES	110A, 500V, 0.15A, 3V	F-91			
C158M	AMR, GES	110A, 600V, 0.15A, 3V	F-91			
C158N	AMR, GES	110A, 800V, 0.15A, 3V	F-91			
C158P	AMR, GES	110A, 1kV, 0.15A, 3V	F-91			
C158PA	AMR, GES	110A, 1.1kV, 0.15A, 3V	F-91			
C158PB	AMR, GES	110A, 1.2kV, 0.15A, 3V	F-91			
C158S	AMR, GES	110A, 700V, 0.15A, 3V	F-91			
C158T	AMR, GES	110A, 900V, 0.15A, 3V	F-91			
C159E	AMR, GES	110A, 500V, 0.15A, 3V	F-50			
C159M	AMR, GES	110A, 600V, 0.15A, 3V	F-50			
C159N	AMR, GES	110A, 800V, 0.15A, 3V	F-50			
C159P	AMR, GES	110A, 1kV, 0.15A, 3V	F-50			
C159PA	AMR, GES	110A, 1.1kV, 0.15A, 3V	F-50			
C159PB	AMR, GES	110A, 1.2kV, 0.15A, 3V	F-91			
C159S	AMR, GES	110A, 700V, 0.15A, 3V	F-50			
C159T	AMR, GES	110A, 900V, 0.15A, 3V	F-50			 图 F-91
C164A	GES	110A, 100V, 0.25A, 5V	F-76			
C164B	GES	110A, 200V, 0.25A, 5V	F-76			
C164C	GES	110A, 300V, 0.25A, 5V	F-76			
C164D	GES	110A, 400V, 0.25A, 5V	F-76			
C164E	GES	110A, 500V, 0.25A, 5V	F-76			
C164M	GES	110A, 600V, 0.25A, 5V	F-76			
C165A	GES	110A, 100V, 0.25A, 5V	F-76			
C165B	GES	110A, 200V, 0.25A, 5V	F-76			
C165C	GES	110A, 300V, 0.25A, 5V	F-76			
C165D	GES	110A, 400V, 0.25A, 5V	F-76			
C165E	GES	110A, 500V, 0.25A, 5V	F-76			 图 F-76

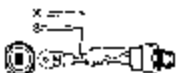

器件型号 Element type	厂名 Manufacturers	材料用途参数 Material Purpose Parameter	图号 Figure	国内外相似替换器件型号 Replace of similar type	备注 Notes	外形参考图 Reference shape
C165M	GES	110A, 600V, 0.25A, 5V	F-76			 图 F-76
C165N	GES	110A, 800V, 0.25A, 5V	F-76			
C178A	ASI, VAN	200A, 100V, 0.3A, 2.5V	F-91	ECG123A		 图 F-91
C178B	ASI, VAN	200A, 200V, 0.3A, 2.5V	F-91	ECG123A		
C178C	ASI, VAN	200A, 300V, 0.3A, 2.5V	F-91	ECG123A		
C178D	ASI, VAN	200A, 400V, 0.3A, 2.5V	F-91			
C178E	ASI, VAN	200A, 500V, 0.3A, 2.5V	F-91			
C178M	ASI, VAN	200A, 600V, 0.3A, 2.5V	F-91			
C178N	ASI, VAN	200A, 800V, 0.3A, 2.5V	F-91			
C178P	ASI, VAN	200A, 1kV, 0.3A, 2.5V	F-91			
C178PA	ASI, VAN	200A, 1.1kV, 0.3A, 2.5V	F-91			
C178PB	ASI, VAN	200A, 1.2kV, 0.3A, 2.5V	F-91			
C178S	ASI, VAN	200A, 700V, 0.3A, 2.5V	F-91			
C178T	ASI, VAN	200A, 1kV, 0.3A, 2.5V	F-91			
C180A	AMR, ASI	235A, 100V, 0.15A, 3V	F-91			
C180AX500	GES	300A, 100V, 0.2A, 3V	F-91			
C180BX500	GES	300A, 200V, 0.2A, 3V	F-91			
C180C	AMR, ASI	235A, 300V, 0.15A, 3V	F-91			
C180CX500	GES	300A, 300V, 0.2A, 3V	F-91			
C180D	AMR, ASI	235A, 400V, 0.15A, 3V	F-91			
C180DX500	GES	300A, 400V, 0.2A, 3V	F-91			
C180M	AMR, ASI	235A, 600V, 0.15A, 3V	F-91			
C180MX500	GES	300A, 600V, 0.2A, 3V	F-91			
C180N	AMR, ASI	235A, 800V, 0.15A, 3V	F-91			
C180NX500	GES	300A, 800V, 0.2A, 3V	F-91			
C180P	AMR, ASI	235A, 1kV, 0.15A, 3V	F-91			
C180PA	AMR, ASI	235A, 1.1kV, 0.15A, 3V	F-91			









器件型号 Element type	厂名 Manufacturers	材料用途参数 Material Purpose Parameter	图号 Figure	国内外相似替换器件型号 Replace of similar type	备注 Notes	外形参考图 Reference shape
C180PC	AMR, ASI	235A, 1.3kV, 0.15A, 3V	F-91			 图 F-91
C180S	AMR, ASI	235A, 700V, 0.15A, 3V	F-91			
C180SX500	GES	300A, 700V, 0.2A, 3V	F-91			
C180T	AMR, ASI	235A, 900V, 0.15A, 3V	F-91			
C181A	ASI, VAN	235A, 100V, 0.3A, 2.5V	F-91			
C181B	ASI, VAN	235A, 200V, 0.3A, 2.5V	F-91			
C181C	ASI, VAN	235A, 300V, 0.3A, 2.5V	F-91			
C181D	ASI, VAN	235A, 400V, 0.3A, 2.5V	F-91			
C181E	ASI, VAN	235A, 500V, 0.3A, 2.5V	F-91			
C181M	ASI, VAN	235A, 600V, 0.3A, 2.5V	F-91			
C181N	ASI, VAN	235A, 800V, 0.3A, 2.5V	F-91			
C181P	ASI, VAN	235A, 1kV, 0.3A, 2.5V	F-91			
C181S	ASI, VAN	235A, 700V, 0.3A, 2.5V	F-91			
C181T	ASI, VAN	235A, 900V, 0.3A, 2.5V	F-91			
C184A	GES	300A, 100V, 0.3A, 3V	F-91			
C184B	GES	300A, 200V, 0.3A, 3V	F-91			
C184C	GES	300A, 300V, 0.3A, 3V	F-91			
C184D	GES	300A, 400V, 0.3A, 3V	F-91			
C184E	GES	300A, 500V, 0.3A, 3V	F-91			
C184M	GES	300A, 600V, 0.3A, 3V	F-91			
C185A	GES	235A, 100V, 0.3A, 3V	F-91	ECG313, SK3039/316, T6070111864BT		
C185A#	GES	300A, 100V, 0.3A, 3V	C-10			
C185B	AMR, ASI	235A, 200V, 0.3A, 3V	F-91			
C185B#	GES	300A, 200V, 0.3A, 3V	F-91			
C185C	AMR, ASI	235A, 300V, 0.3A, 3V	F-91			
C185C#	GES	300A, 300V, 0.3A, 3V	F-91			
C185D	AMR, ASI	235A, 400V, 0.3A, 3V	F-91			
C185D#	GES	300A, 400V, 0.3A, 3V	F-91			

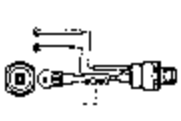
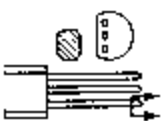
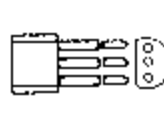
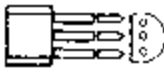

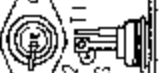
图 C-10

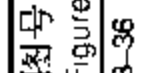
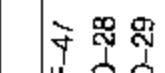
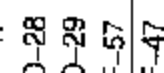
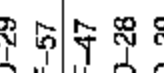
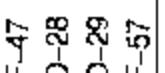
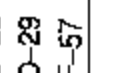
器件型号 Element type	厂名 Manufacturers	材料用途参数 Material Purpose Parameter	图号 Figure	国内外相似替换器件型号 Replace of similar type	备注 Notes	外形参考图 Reference shape
C185E	AMR, ASI	235A, 500V, 0.3A, 3V	F-91			 图 F-91
C185E#	GES	300A, 500V, 0.3A, 3V	F-91	ECG313, SK3039/316, T6070611864BT		
C185M	AMR, ASI	235A, 600V, 0.3A, 3V	F-91			
C185M#	GES	300A, 600V, 0.3A, 3V	F-91			
C185N	GES	300A, 800V, 0.3A, 3V	F-91			
C185S	GES	300A, 700V, 0.3A, 3V	F-91			
C203A	GES, NEC	SCR-H 0.8A, 100V, 200 μA, 0.8V	B-45	EC103A, BRX46, BRX47, BRX48, BRX49, BRX51, BRX52, BRX53, BRX54, BRX55, BRX56, BRY55-100S, MCR102, SK3638, SK5402		 图 B-45
C203B	GES, NEC	SCR-H 0.8A, 200V, 200 μA, 0.8V	B-36	BRX47, BRX48, BRX49, BRX52, BRX53, BRX54, BRX55, BRX56, BRY55-200S, EC103B, MCR100-4, 2N5064		
C203C	GES, NEC	SCR-H 0.8A, 300V, 200 μA, 0.8V	B-36	BRX48, BRX49, BRX53, BRX54, BRX55, BRX56, BRY55-300S, EC103C, MCR100-6, 2N6564		
C203D	GES, NEC	SCR-H 0.8A, 400V, 200 μA, 0.8V	B-36	BRX49, BRX54, BRX55, BRX56, BRY55-100S, MCR100-6, 2N6565		
C203Q	GES, NEC	SCR-H 0.8A, 100V	B-45	MCR100-3		
C203Y	GES, NEC	SCR-H 0.8A, 30V, 200 μA, 0.8V	B-45	BRX44, BRX45, BRX46, BRX47, BRX48, BRX49, BRX50, BRX51, BRX52, BRX53, BRX54, BRX55, BRX56, BRY55-30S, EC103Y, MCR102, 2N5060		
C203YY	GES, NEC	SCR-H 0.8A, 60V, 200 μA, 0.8V	B-36	BRX45, BRX46, BRX47, BRX48, BRX49, BRX51, BRX52, BRX53, BRX54, BRX55, BRX56, BRY55-60S, EC103A, 2N5061		 图 B-36
C205A	GES	SCR-H 1.2A, 100V, 200 μA, 0.8V	B-36	BTX61, BTX62, BTX63, BTX64, BTX65, BTX66		
C205B	GES	SCR-H 1.2A, 200V, 200 μA, 0.8V	B-36	BTX62, BTX63, BTX64, BTX65, BTX66		
C205C	GES	SCR-H 1.2A, 300V, 200 μA, 0.8V	B-36	BTX63, BTX64, BTX65, BTX66		
C205D	GES	SCR-H 1.2A, 400V, 200 μA, 0.8V	B-36	BTX64, BTX65, BTX66		

器件型号 Element type	厂名 Manufacturers	材料用途参数 Material Purpose Parameter	图号 Figure	国内外相似替换器件型号 Replace of similar type	备注 Notes	外形参考图 Reference shape
C205Y	GES	SCR-H 1.2A, 30V, 200 μ A, 0.8V	B-36	BTX60, BTX61, BTX62, BTX63, BTX64, BTX65, BTX66		 图 B-36
C206YY	GES	SCR-H 1.2A, 60V, 200 μ A, 0.8V	B-36	BTX61, BTX62, BTX63, BTX64, BTX65, BTX66		 图 B-36
C220A, 2, 3	GES, SST	10A, 100V, 0.025A, 1.5V	F-47	S1015B, S6210A, T400011008		 图 F-47
C220A4, 5	GES	10A, 100V, 0.025A, 1.5V	D-28	ECG5534		 图 D-28
C220A6, 7	GES	10A, 100V, 0.025A, 1.5V	D-29			 图 D-29
C220A8, 9	GES	10A, 100V, 0.025A, 1.5V	F-57			 图 F-57
C220B, 2, 3	GES, SPE	10A, 200V, 0.025A, 1.5V	F-47	S2015B, S6210B, T400021008		 图 F-47
C220B4, 5	GES	10A, 200V, 0.025A, 1.5V	D-28	ECG5534		 图 D-28
C220B6, 7	GES	10A, 200V, 0.025A, 1.5V	D-29			 图 D-29
C220B8, 9	GES	10A, 200V, 0.025A, 1.5V	F-57			 图 F-57
C220C, 2, 3	GES, SST	10A, 300V, 0.025A, 1.5V	F-47	S4015B, S6210C, T400031008		 图 F-47
C220C4, 5	GES	10A, 300V, 0.025A, 1.5V	D-28	ECG5534		 图 D-28
C220C6, 7	GES	10A, 300V, 0.025A, 1.5V	D-29			 图 D-29
C220C8, 9	GES	10A, 300V, 0.025A, 1.5V	F-57			 图 F-57
C220D, 2, 3	GES, SST	10A, 400V, 0.025A, 1.5V	F-47	S4015B, S6210D, T400041008		 图 F-47
C220D4, 5	GES	10A, 400V, 0.025A, 1.5V	D-28	ECG5534		 图 D-28
C220D6, 7	GES	10A, 400V, 0.025A, 1.5V	D-29			 图 D-29
C220D8, 9	GES	10A, 400V, 0.025A, 1.5V	F-57			 图 F-57
C220F, 2, 3,	GES, SST	10A, 500V, 0.025A, 1.5V	F-47	S6015B, S6210M, T400051008		 图 F-47
C220E4, 5	GES	10A, 500V, 0.025A, 1.5V	D-28	ECG5534		 图 D-28
C220E6, 7	GES	10A, 500V, 0.025A, 1.5V	D-29			 图 D-29
C220E8, 9	GES	10A, 500V, 0.025A, 1.5V	F-57			 图 F-57
C220F, 2, 3,	GES, SST	10A, 50V, 0.025A, 1.5V	F-47	SK3589		 图 F-47
C220F4, 5	GES	10A, 50V, 0.025A, 1.5V	D-28	ECG5534		 图 D-28
C220F6, 7	GES	10A, 50V, 0.025A, 1.5V	D-29			 图 D-29
C220F8, 9	GES	10A, 50V, 0.025A, 1.5V	F-57			 图 F-57

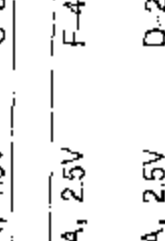
器件型号 Element type	厂名 Manufacturers	材料用途参数 Material Purpose Parameter	图号 Figure	国内外相似替换器件型号 Replacc of similar type	备注 Notes	外形参考图 Reference shape
C220M, 2, 3	GES, SST	10A, 600V, 0.025A, 1.5V	F-21			 图 F-21
C220M4, 5	GES	10A, 600V, 0.025A, 1.5V	D-28	ECG5534		
C220M6, 7	GES	10A, 600V, 0.025A, 1.5V	D-29	ECG5534		
C220M8, 9	GES	10A, 600V, 0.025A, 1.5V	F-57			
C220U, 2, 3	GES, SST	10A, 25V, 0.025A, 1.5V	F-47	SK3589		 图 D-28
C220U4, 5	GES	10A, 25V, 0.025A, 1.5V	D-28	ECG5534		
C220U6, 7	GES	10A, 25V, 0.025A, 1.5V	D-29			
C220U8, 9	GES	10A, 25V, 0.025A, 1.5V	F-57			
C222A	GES, NJS	10A, 100V, 0.025A, 1.5V	C-85	SK3613, SK5514		 图 D-29
C222B	GES, NJS	10A, 200V, 0.025A, 1.5V	C-85	S2010, S6200D		
C222C	GES, NJS	10A, 300V, 0.025A, 1.5V	C-85	S4010, S6200D		
C222D	GES, NJS	10A, 400V, 0.025A, 1.5V	C-85	S4010, S6200D		
C222E	GES, NJS	10A, 500V, 0.025A, 1.5V	C-85	S6010, S6200M		
C222F	GES, NJS	10A, 50V, 0.025A, 1.5V	C-85	S0510, S6200A		
C222M	GES, NJS	10A, 600V, 0.025A, 1.5V	C-85			
C222U	GES, NJS	10A, 25V, 0.025A, 1.5V	C-85	SK3613, SK5514		
C228A, A2, A3	GES, MOT	50Hz-Thy 35A, 100V, 0.04A, 2.5V	F-47	C35A, ECG5562, MCR3935-3, S1035H, 2N3896, 2N3897, 2N3878, 2N3899 ECG5562		
C228A4, A5	GES	35A, 100V, 0.04A, 2.5V	D-28			
C228A6, A7	GES	35A, 100V, 0.04A, 2.5V	D-29			
C228A8, A9	GES	35A, 100V, 0.04A, 2.5V	F-57			
C228B, B2, B3	GES, MOT	50Hz-Thy 35A, 200V, 0.04A, 2.5V	F-47	C35B, ECG5562, MCR3935-4, S2035H, 2N3897, 2N3878, 2N3899 ECG5534		
C228B4, B5	GES	35A, 200V, 0.04A, 2.5V	D-28			
C228B6, B7	GES	35A, 200V, 0.04A, 2.5V	D-29			
C228B8, B9	GES	35A, 200V, 0.04A, 2.5V	F-57			











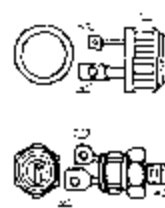

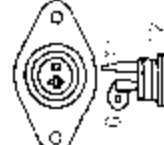
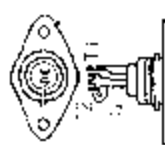

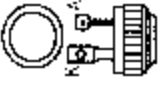

图 F-47

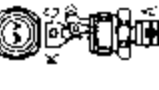
图 C 形

器件型号 Element type	厂名 Manufacturers	材料用途参数 Material Purpose Parameter	图号 Figure	国内外相似替换器作型号 Repace of s.milar type	备注 Notes	外形参考图 Reference shape
C228C, C2, C3	GES, MOT	50Hz-Thy 35A, 300V, 0.04A, 2.5V	F-47	C35C, ECG5564, MCR3935-4, S4035H, TAG35-300, 2N3898, 2N3899 ECG5534		 图 F-47
C228C4, C5	GES	35A, 300V, 0.04A, 2.5V	D-28			
C228C6, C7	GES	35A, 300V, 0.04A, 2.5V	D-29			
C228C8, C9	GES	35A, 300V, 0.04A, 2.5V	F-57			
C228D, D2, D3	GES, MOT	50Hz-Thy 35A, 400V, 0.04A, 2.5V	F-47	C35D, ECG5564, MCR3935-6, S4035H, TAG35-400, 2N3898, 2N3899 ECG5534		 图 D-28
C228D4, D5	GES	35A, 400V, 0.04A, 2.5V	D-28			
C228D6, D7	GES	35A, 400V, 0.04A, 2.5V	D-29			
C228D8, D9	GES	35A, 400V, 0.04A, 2.5V	F-57			
C228E, E2, E3	GES, MOT	50Hz-Thy 35A, 500V, 0.04A, 2.5V	F-47	C35E, ECG5566, MCR3935-7, S6035H, 2N3899 ECG5534		 图 D-29
C228E4, E5	GES	35A, 100V, 0.04A, 2.5V	D-28			
C228E6, E7	GES	35A, 100V, 0.04A, 2.5V	D-29			
C228E8, E9	GES	35A, 100V, 0.04A, 2.5V	F-57			
C228F, F2, F3	GES, MOT	50Hz-Thy 35A, 50V, 0.04A, 2.5V	F-47	C35F, ECG5534, MCR3935-2, S0535H, TAG35-100, 2N3896, 2N3897, 2N3898, 2N3899		
C228F4, F5	GES	35A, 50V, 0.04A, 2.5V	D-28			
C228F6, F7	GES	35A, 50V, 0.04A, 2.5V	D-29			
C228F8, F9	GES	35A, 50V, 0.04A, 2.5V	F-57			
C228M, M2, M3	GES, MOT	50Hz-Thy 35A, 600V, 0.04A, 2.5V	F-47	C35M, ECG5566, S6035H, TAG35-600, 2N3899 ECG5534		
C228M4, M5	GES	35A, 600V, 0.04A, 2.5V	D-28			
C228M6, M7	GES	35A, 600V, 0.04A, 2.5V	D-29			
C228M8, M9	GES	35A, 600V, 0.04A, 2.5V	F-57			
C228U, U3	GES, MOT	50Hz-Thy 35A, 25V, 0.04A, 2.5V	F-47	C35U, ECG5562, MCR3935-1, S0335D, 2N3896, 2N3897, 2N3898, 2N3899 ECG5534		 图 F-57
C228U4, U5	GES	35A, 25V, 0.04A, 2.5V	D-28			
C228U6, U7	GES	35A, 25V, 0.04A, 2.5V	D-29			
C228U8, U9	GES	35A, 25V, 0.04A, 2.5V	F-57			

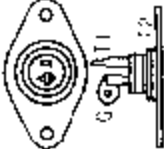
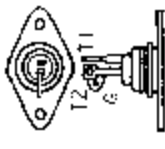

器件型号 Element type	厂名 Manufacturers	材料用途参数 Material Purpose Parameter	图号 Figure	国内外相似替换器件型号 Replace of similar type	备注 Notes	外形参考图 Reference shape
C229A	GES, MOT	50Hz-Thy 35A, 100V, 0.04A, 2.5V	C-85	MCR229A, MCR63-3, MCR3835-3, S1035G, 2N3870, 2N3871, 2N3872, 2N3873		 图 C-85
C229A3		35A, 100V				
C229B	GES, MOT	50Hz-Thy 35A, 200V, 0.04A, 2.5V	C-85	MCR229B, MCR63-4, MCR3835-4, S2035G, 2N3870, 2N3871, 2N3872, 2N3873		 图 C-85
C229B3		35A, 200V				
C229C	GES, MOT	50Hz-Thy 35A, 300V, 0.04A, 2.5V	C-85	MCR229D, MCR63-5, MCR3835-5, S4035G, 2N3870, 2N3871, 2N3872, 2N3873		 图 F-47
C229C3		35A, 400V				
C229D	GES, MOT	50Hz Thy 35A, 400V, 0.04A, 2.5V	C-85	MCR229D, MCR63-6, MCR3835-6, S4035G, 2N3870, 2N3871, 2N3872, 2N3873		 图 D-28
C229D3		35A, 400V				
C229E	GES, MOT	50Hz-Thy 35A, 500V, 0.04A, 2.5V	C-85	MCR229M, MCR63-7, MCR3835-7, S6035G, 2N3870, 2N3871, 2N3872, 2N3873		 图 D-28
C229E3		35A, 500V				
C229F	GES, MOT	50Hz-Thy 35A, 50V, 0.04A, 2.5V	C-85	MCR229A, MCR63-2, MCR3835-2, S0535G, 2N3871, 2N3872, 2N3873		 图 D-28
C229F3		35A, 100V				
C229M	GES, MOT	50Hz-Thy 35A, 600V, 0.04A, 2.5V	C-85	MCR229M, MCR63-8, MCR3835-8, S6035G, 2N3870, 2N3871, 2N3872, 2N3873		 图 D-29
C229M3		35A, 600V				
C229U	GES, MOT	50Hz-Thy 35A, 25V, 0.04A, 2.5V	C-85	MCR63-1, MCR3835-1, 2N3870, 2N3871, 2N3872, 2N3873		 图 F-57
C230A, A2, A3	GES, MOT	50Hz-Thy 25A, 100V, 0.025A, 1.5V	F-47	BSIE4126N, BSIE4126MN, MCR230A, MCR230A3, S1025H		 图 F-57
C230A4, A5	GES	25A, 100V, 0.025A, 1.5V	D-28	ECG5534		
C230A6, A7	GES	25A, 100V, 0.025A, 1.5V	D-29			
C230A8, A9	GES	25A, 100V, 0.025A, 1.5V	F-57			

器件型号 Element type	厂名 Manufacturers	材料用途参数 Material Purpose Parameter	图号 Figure	国内外相似替换器件型号 Replace of similar type	备注 Notes	外形参考图 Reference shape
C230B, B2, B3	GES, MOT	50Hz-Thy 25A, 200V, 0.025A, 1.5V	F-47	BSIE4126N, BSIE4126MN, MCR230B, MCR230B3, S2025H		 图 F-47
C230B4, B5	GES	25A, 200V, 0.025A, 1.5V	D-28			
C230B6, B7	GES	25A, 200V, 0.025A, 1.5V	D-29			
C230B6, B9	GES	25A, 200V, 0.025A, 1.5V	F-57			
C230C, C2, C3	GES, MOT	50Hz-Thy 25A, 300V, 0.025A, 1.5V	F-47	BSIE4126N, BSIE4126MN, MCR230D, MCR230D3, S4025H		 图 D-28
C230C4, C5	GES	25A, 300V, 0.025A, 1.5V	D-28			
C230C6, C7	GES	25A, 300V, 0.025A, 1.5V	D-29			
C230C8, C9	GES	25A, 300V, 0.025A, 1.5V	F-57			
C230D, D2, D3	GES, MOT	50Hz-Thy 25A, 400V, 0.025A, 1.5V	F-47	BSIE4126N, BSIE4126MN, ECG5534, MCR230D3, S4025H		 图 D-29
C230D4, D5	GES	25A, 400V, 0.025A, 1.5V	D-28			
C230D6, D7	GES	25A, 400V, 0.025A, 1.5V	D-29			
C230D8, D9	GES	25A, 400V, 0.025A, 1.5V	F-57			
C230E, E2, E3	GES, MOT	50Hz-Thy 25A, 500V, 0.025A, 1.5V	F-47	BSIE4133N, BSIE4133MN, MCR230M, MCR230M3, S6025H		 图 D-29
C230E4, E5	GES	25A, 500V, 0.025A, 1.5V	D-28	ECG5534		
C230E6, E7	GES	25A, 500V, 0.025A, 1.5V	D-29			
C230E8, E9	GES	25A, 500V, 0.025A, 1.5V	F-57			
C230F, F2, F3	GES, MOT	50Hz-Thy 25A, 50V, 0.025A, 1.5V	F-47	BSIE4126N, BSIE4126MN, MCR230F, MCR230F3, S0525H		 图 F-57
C230F4, F5	GES	25A, 50V, 0.025A, 1.5V	D-28	ECG5534		
C230F6, F7	GES	25A, 50V, 0.025A, 1.5V	D-29			
C230F8, F9	GES	25A, 50V, 0.025A, 1.5V	F-57			
C230M, M2, M3	GES, MOT	50Hz-Thy 25A, 600V, 0.025A, 1.5V	F-47	BSIE4140N, BSIE4140MN, MCR230M, MCR230M3, S6025H		
C230M4, M5	GES	25A, 600V, 0.025A, 1.5V	D-28			
C230M6, M7	GES	25A, 600V, 0.025A, 1.5V	D-29			

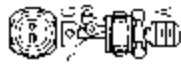
器件型号 Element: type	厂名 Manufacturers	材料用途参数 Material Purpose Parameter	图号 Figure	国内外相似替换器型号 Replace of similar type	备注 Notes	外形参考图 Reference shape
C230M8, M9	GES	25A, 600V, 0.025A, 1.5V	F-57			 图 F-57
C230U, U2, U3	GES, MOT	50Hz-Thy 25A, 25V, 0.025A, 1.5V	F-47	BSIE4126N, BSIE4126MN, S0325H		
C230U4, U5	GES	25A, 25V, 0.025A, 1.5V	D-28			
C230U6, U7	GES	25A, 25V, 0.025A, 1.5V	D-29			
C230U8, U9	GES	25A, 25V, 0.025A, 1.5V	F-57			
C231A, A2, A3	GES, MOT	50Hz-Thy 25A, 100V, 0.009A, 1.5V	F-47	MCR231A, MCR231A3		
C231A4, A5	GES	25A, 100V, 0.009A, 1.5V	D-28			
C231A6, A7	GES	25A, 100V, 0.009A, 1.5V	D-29			
C231A8, A9	GES	25A, 100V, 0.009A, 1.5V	F-57			
C231B, B2, B3	GES, MOI	50Hz-Thy 25A, 200V, 0.009A, 1.5V	F-47	MCR231B, MCR231B3		
C231B4, B5	GES	25A, 200V, 0.009A, 1.5V	D-28			
C231B6, B7	GES	25A, 200V, 0.009A, 1.5V	D-29			
C231B8, B9	GES	25A, 200V, 0.009A, 1.5V	F-57			
C231C, C2, C3	GES, MOT	50Hz-Thy 25A, 300V, 0.009A, 1.5V	F-47	MCR231D, MCR231D3		
C231C4, C5	GFS	25A, 300V, 0.009A, 1.5V	D-28			
C231C6, C7	GES	25A, 300V, 0.009A, 1.5V	D-29			
C231C8, C9	GES	25A, 300V, 0.009A, 1.5V	F-57			
C231D, D2, D3	GES, MOT	50Hz-Thy 25A, 400V, 0.009A, 1.5V	F-47	MCR231D, MCR231D3		
C231D4, D5	GES	25A, 400V, 0.009A, 1.5V	D-28			
C231D6, D7	GES	25A, 400V, 0.009A, 1.5V	D-29			
C231D8, D9	GES	25A, 400V, 0.009A, 1.5V	F-57			
C231E, E2, E3	GES, MOT	50Hz-Thy 25A, 500V, 0.009A, 1.5V	F-47	MCR231M, MCR231M3		
C231E4, E5	GES	25A, 500V, 0.009A, 1.5V	D-28			
C231E6, E7	GES	25A, 500V, 0.009A, 1.5V	D-29			
C231E8, E9	GES	25A, 500V, 0.009A, 1.5V	F-57			
C231F, F2, F3	GES, MOT	50Hz-Thy 25A, 50V, 0.009A, 1.5V	F-47	MCR231F, MCR231F3		
C231F4, F5	GES	25A, 50V, 0.009A, 1.5V	D-28			
C231F6, F7	GES	25A, 50V, 0.009A, 1.5V	D-29			
C231F8, F9	GES	25A, 50V, 0.009A, 1.5V	F-57			



图 F-57



图 F-47

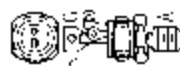

图 D-28







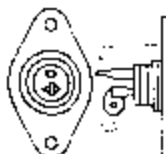



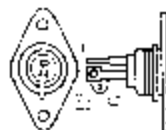
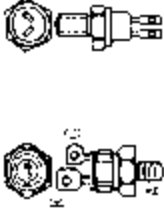
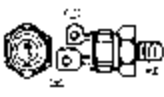
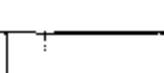





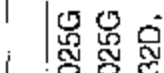
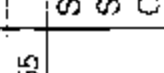

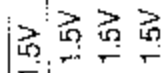
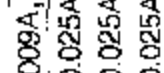
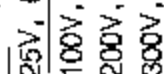
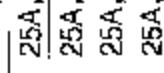
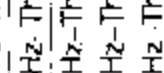
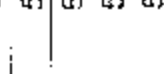
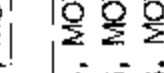
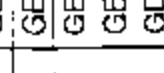
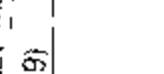
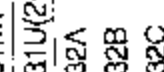
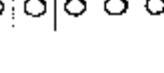













图 D-29



器件型号 Element type	厂名 Manufacturers	材料用途参数 Material Purpose Parameter	图号 Figure	国内外相似替换器件型号 Replace of similar type	备注 Notes	外形参考图 Reference shape
C231M, M2, M3	GES, MOT	50Hz-Thy 25A, 600V, 0.009A, 1.5V	F-47	MCR231M, MCR231M3		
C231U(2...9)	GES	50Hz-Thy 25A, 25V, 0.009A, 1.5V	F-55			
C232A	GES, MOT	50Hz-Thy 25A, 100V, 0.025A, 1.5V		S1025G		
C232B	GES, MOT	50Hz-Thy 25A, 200V, 0.025A, 1.5V		S2025G		
C232C	GES, MOT	50Hz-Thy 25A, 300V, 0.025A, 1.5V		C232D, S4025G		
C232D	GES, MOT	50Hz-Thy 25A, 400V, 0.025A, 1.5V		S4025G		
C232E	GES, MOT	50Hz-Thy 25A, 500V, 0.025A, 1.5V		C232M, S6025G		
C232F	GES, MOT	50Hz-Thy 25A, 50V, 0.025A, 1.5V		S0525G		
C232M	GES, MOT	50Hz-Thy 25A, 600V, 0.025A, 1.5V	C-85	S6025G		
C232U	GES, MOT	50Hz-Thy 25A, 25V, 0.025A, 1.5V	D-14	S0325G		
C233A	GES, MOT	50Hz-Thy 25A, 100V, 0.009A, 1.5V				
C233B	GES, MOT	50Hz-Thy 25A, 200V, 0.009A, 1.5V				
C233C	GES, MOT	50Hz-Thy 25A, 300V, 0.009A, 1.5V				
C233D	GES, MOT	50Hz-Thy 25A, 400V, 0.009A, 1.5V				
C233E	GES, MOT	50Hz-Thy 25A, 500V, 0.009A, 1.5V				
C233F	GES, MOT	50Hz-Thy 25A, 50V, 0.009A, 1.5V				
C233M	GES, MOT	50Hz-Thy 25A, 600V, 0.009A, 1.5V	C-85			
C233U	GES, MOT	50Hz-Thy 25A, 25V, 0.009A, 1.5V	D-14			
C234A, A2, A3	GES	25A, 100V, 0.025A, 1.5V	F-47	ECG5562		
C234A4, A5	GES	25A, 100V, 0.025A, 1.5V	D-26	ECG5534		
C234A6, A7	GES	25A, 100V, 0.025A, 1.5V	D-29			
C234A8, A9	GES	25A, 100V, 0.025A, 1.5V	F-57			
C234B, B2, B3	GES	25A, 200V, 0.025A, 1.5V	F-47	ECG5562		
C234B4, B5	GES	25A, 200V, 0.025A, 1.5V	D 26	ECG5534		
C234B6, B7	GFS	25A, 200V, 0.025A, 1.5V	D-29			
C234B8, B9	GES	25A, 200V, 0.025A, 1.5V	F-57			
C234C, C2, C3	GES	25A, 300V, 0.025A, 1.5V	F-47	ECG5564		
C234C4, C5	GES	25A, 300V, 0.025A, 1.5V	D-26	ECG5534		
C234C6, C7	GES	25A, 300V, 0.025A, 1.5V	D-29			

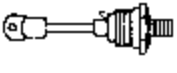
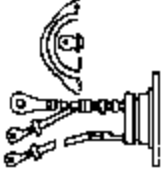
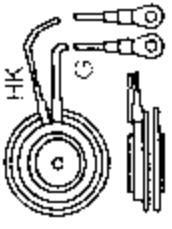

器件型号 Element type	厂名 Manufacturers	材料用途参数 Material Purpose Parameter	图号 Figure	国内外相似替换器件型号 Replace of similar type	备注 Notes	外形参考图 Reference shape
C234C8, C9	GES	25A, 300V, 0.025A, 1.5V	F-57			
C234D, D2, D3	GES	25A, 400V, 0.025A, 1.5V	F-47	TAG12F400DUJEB		
C234D4, D5	GES	25A, 400V, 0.025A, 1.5V	D-28	ECG5534		
C234D6, D7	GES	25A, 400V, 0.025A, 1.5V	D-29			
C234D8, D9	GES	25A, 400V, 0.025A, 1.5V	F-57			
C234E, E2, E3	GES	25A, 500V, 0.025A, 1.5V	F-17	ECG5566		
C234E4, E5	GES	25A, 500V, 0.025A, 1.5V	D-28	ECG5534		
C234E6, E7	GES	25A, 500V, 0.025A, 1.5V	D-29			
C234E8, E9	GES	25A, 500V, 0.025A, 1.5V	F-57			
C234F, F2, F3	GES	25A, 50V, 0.025A, 1.5V	F-47	ECG5562		
C234F4, F5	GES	25A, 50V, 0.025A, 1.5V	D-28	ECG5534		
C234F6, F7	GES	25A, 50V, 0.025A, 1.5V	D-29			
C234F8, F9	GES	25A, 50V, 0.025A, 1.5V	F-57			
C234M, M2, M3	GES	25A, 600V, 0.025A, 1.5V	F-47	TAG12F600DUJEB		
C234M4, M5	GES	25A, 600V, 0.025A, 1.5V	D-28	ECG5534		
C234M6, M7	GES	25A, 600V, 0.025A, 1.5V	D-29			
C234M8, M9	GES	25A, 600V, 0.025A, 1.5V	F-57			
C234U, U2, U3	GES	25A, 25V, 0.025A, 1.5V	F-47	ECG5562		
C234U4, U5	GES	25A, 25V, 0.025A, 1.5V	D-28	ECG5534		
C234U6, U7	GES	25A, 25V, 0.025A, 1.5V	D-29			
C234U8, U9	GES	25A, 25V, 0.025A, 1.5V	F-57			
C235A	GES, NJS	25A, 100V, 0.025A, 1.5V	C-85			
C235B	GES, NJS	25A, 200V, 0.025A, 1.5V	C-85			
C235C	GES, NJS	25A, 300V, 0.025A, 1.5V	C-85			
C235D	GES, NJS	25A, 400V, 0.025A, 1.5V	C-85			
C235E	GES, NJS	25A, 500V, 0.025A, 1.5V	C-85			
C235F	GES, NJS	25A, 50V, 0.025A, 1.5V	C-85			
C235M	GES, NJS	25A, 600V, 0.025A, 1.5V	C-85			
C235U	GES, NJS	25A, 25V, 0.025A, 1.5V	C-85			

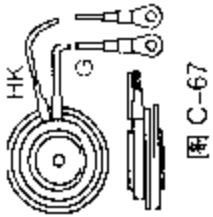
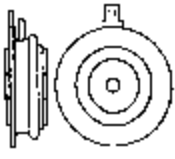
器件型号 Element type	厂名 Manufacturers	材料用途参数 Material Purpose Parameter	图号 Figure	国内外相似替换器件型号 Replace of similar type	备注 Notes	外形参考图 Reference shape	
C290A	ASI, VAN	470A, 100V, 0.15A, 3.5V	E-1			 <p>图 E-1</p>	
C290B	ASI, VAN	470A, 200V, 0.15A, 3.5V	E-1				
C290C	ASI, VAN	470A, 300V, 0.15A, 3.5V	E-1				
C290D	ASI, VAN	470A, 400V, 0.15A, 3.5V	E-1				
C290E	ASI, VAN	470A, 500V, 0.15A, 3.5V	F-1				
C290M	ASI, VAN	470A, 600V, 0.15A, 3.5V	E-1				
C290N	ASI, VAN	470A, 800V, 0.15A, 3.5V	E-1				
C290P	ASI, VAN	470A, 1KV, 0.15A, 3.5V	E-1				
C290PA	ASI, VAN	470A, 1.1KV, 0.15A, 3.5V	E-1				
C290PB	ASI, VAN	470A, 1.2KV, 0.15A, 3.5V	E-1				
C290S	ASI, VAN	470A, 700V, 0.15A, 3.5V	E-1				
C290T	ASI, VAN	470A, 900V, 0.15A, 3.5V	E-1				
C291A	ASI, VAN	470A, 100V, 0.15A, 3.5V	E-9				 <p>图 E-9</p>
C291B	ASI, VAN	470A, 200V, 0.15A, 3.5V	E-9				
C291C	ASI, VAN	470A, 300V, 0.15A, 3.5V	E-9				
C291D	ASI, VAN	470A, 400V, 0.15A, 3.5V	E-9				
C291E	ASI, VAN	470A, 500V, 0.15A, 3.5V	E-9				
C291M	ASI, VAN	470A, 600V, 0.15A, 3.5V	E-9				
C291N	ASI, VAN	470A, 800V, 0.15A, 3.5V	E-9				
C291P	ASI, VAN	470A, 1KV, 0.15A, 3.5V	E-9				
C291PA	ASI, VAN	470A, 1.1KV, 0.15A, 3.5V	E-9				
C291S	ASI, VAN	470A, 700V, 0.15A, 3.5V	E-9				
C291T	ASI, VAN	470A, 900V, 0.15A, 3.5V	E-9			 <p>图 C-67</p>	
C350A	ASI, VAN	175A, 100V, 0.15A, 2.5V	C-67				
C350B	ASI, VAN	175A, 200V, 0.15A, 2.5V	C-67				
C350C	ASI, VAN	175A, 300V, 0.15A, 2.5V	C-67				
C350D	ASI, VAN	175A, 400V, 0.15A, 2.5V	C-67				
C350E	ASI, VAN	175A, 500V, 0.15A, 3.0V	C-67			 <p>图 C</p>	

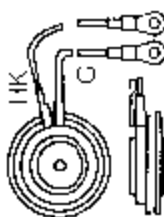
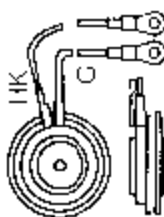
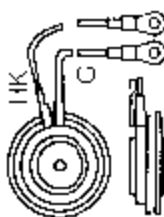
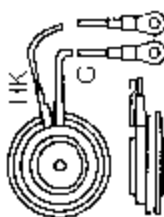
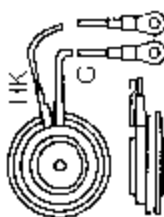
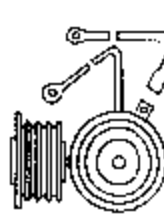
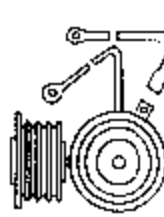
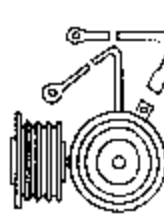
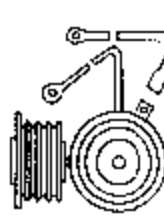
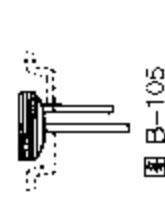
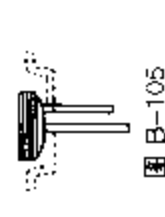
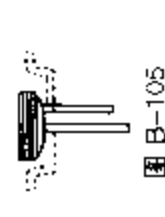
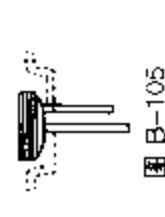
器件型号 Element type	厂名 Manufacturers	材料用途参数 Material Purpose Parameter	图号 Figure	国内外相似替换器件型号 Replace of similar type	备注 Notes	外形参考图 Reference shape	
C350M	ASI, VAN	175A, 600V, 0.15A, 3.0V	C-67			 图 C-67	
C350N	ASI, VAN	175A, 800V, 0.15A, 3.0V	C-67				
C350P	ASI, VAN	175A, 1kV, 0.15A, 1.5V	C-67				
C350PA	ASI, VAN	175A, 1.1kV, 0.15A, 3.0V	C-67				
C350PB	ASI, VAN	175A, 1.2kV, 0.15A, 3.0V	C-67				
C350PC	ASI, VAN	175A, 1.3kV, 0.15A, 3.0V	C-67				
C350S	ASI, VAN	175A, 700V, 0.15A, 3.0V	C-67				
C350T	ASI, VAN	175A, 900V, 0.15A, 3.0V	C-67				
C354A	ASI, VAN	275A, 100V, 0.2A, 3V	C-67				 图 C-10
C354B	ASI, VAN	275A, 200V, 0.2A, 3V	C-67				
C354C	ASI, VAN	275A, 300V, 0.2A, 3V	C-67				
C354D	ASI, VAN	275A, 400V, 0.2A, 3V	C-67				
C354E	ASI, VAN	275A, 500V, 0.2A, 3V	C-67				
C354M	ASI, VAN	275A, 600V, 0.2A, 3V	C-67				
C355A	ASI, VAN	275A, 100V, 0.2A, 3V	C-67				
C355B	ASI, VAN	275A, 200V, 0.2A, 3V	C-67				
C355C	ASI, VAN	275A, 300V, 0.2A, 3V	C-67				
C355D	ASI, VAN	275A, 400V, 0.2A, 3V	C-67				
C355E	ASI, VAN	275A, 500V, 0.2A, 3V	C-67				
C355M	ASI, VAN	275A, 600V, 0.2A, 3V	C-67				
C358E	GES	225A, 500V, 0.15A, 3V	C-67				
C358M	GES	225A, 600V, 0.15A, 3V	C-67				
C358N	GES	225A, 800V, 0.15A, 3V	C-67				
C358P	GES	225A, 1kV, 0.15A, 3V	C-67				
C358PA	GES	225A, 1.1kV, 0.15A, 3V	C-67				
C358PB	GES	225A, 1.2kV, 0.15A, 3V	C-10				
C358S	GES	225A, 700V, 0.15A, 3V	C-67				

器件型号 Element type	厂名 Manufacturers	材料用途参数 Material Purpose Parameter	图号 Figure	国内外相似替换器件型号 Replace of similar type	备注 Notes	外形参考图 Reference shape
C358T	GES	225A, 900V, 0.15A, 3V	C-67			
C364A	GES	275A, 100V, 0.25A, 3V	C-67			
C364B	GES	275A, 200V, 0.25A, 3V	C-67			
C364C	GES	275A, 300V, 0.25A, 3V	C-67			
C364D	GES	275A, 400V, 0.25A, 3V	C-67			
C364E	GES	275A, 500V, 0.25A, 3V	C-67			
C364M	GES	275A, 600V, 0.25A, 3V	C-67			
C364N	GES	275A, 800V, 0.25A, 3V	C-67			
C364S	GES	275A, 700V, 0.25A, 3V	C-67			
C365A	GES	275A, 100V, 0.25A, 3V	C-67			
C365B	GES	275A, 200V, 0.25A, 3V	C-67			
C365C	GES	275A, 300V, 0.25A, 3V	C-67			
C365D	GES	275A, 400V, 0.25A, 3V	C-67			
C365E	GES	275A, 500V, 0.25A, 3V	C-67			
C365M	GES	275A, 600V, 0.25A, 3V	C-67			
C365N	GES	275A, 800V, 0.25A, 3V	C-67			
C365S	GES	275A, 700V, 0.25A, 3V	C-67			
C376E	GES	600A, 500V, 0.25A, 5V	C-74			
C376M	GES	600A, 600V, 0.25A, 5V	C-74			
C376PA	GES	600A, 1.1KV, 0.25A, 5V	C-74			
C376PB	GES	600A, 1.2KV, 0.25A, 5V	C-74			
C376PC	GES	600A, 1.3KV, 0.25A, 5V	B-105			
C376PD	GES	600A, 1.4KV, 0.25A, 5V	C-74			
C376S	GES	600A, 700V, 0.25A, 5V	C-74			
C376T	GES	600A, 900V, 0.25A, 5V	C-74			
C377E	GES	700A, 500V, 0.25A, 5V	C-74			
C377M	GFS	700A, 600V, 0.25A, 5V	C-74			

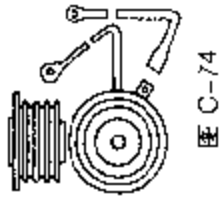
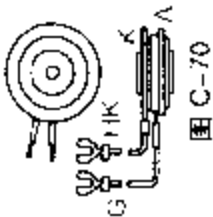
器件型号 Element type	厂名 Manufacturers	材料用途参数 Material Purpose Parameter	图号 Figure	国内外相似替换器件型号 Replace of similar type	备注 Notes	外形参考图 Reference shape
C377N	GES	700A, 800V, 0.25A, 5V	C-74			
C377P	GES	700A, 1kV, 0.25A, 5V	C-74			
C377PA	GES	700A, 1.1kV, 0.25A, 5V	C-74			
C377PB	GES	700A, 1.2kV, 0.25A, 5V	C-74			
C377PC	GES	700A, 1.3kV, 0.25A, 5V	C-74			
C377PD	GES	700A, 1.4kV, 0.25A, 5V	C-74			
C377S	GES	700A, 700V, 0.25A, 5V	C-74			
C377T	GES	700A, 900V, 0.25A, 5V	C-74			
C378E	GES	650A, 500V, 0.25A, 5V	C-74			
C378M	GES	650A, 600V, 0.25A, 5V	C-74			
C378N	GES	650A, 800V, 0.25A, 5V	C-74			
C378P	GES	650A, 1kV, 0.325A, 5V	C-74			
C378PA	GES	650A, 1.1kV, 0.25A, 5V	C-74			
C378PB	GES	650A, 1.2kV, 0.25A, 5V	C-70			
C378PD	GES	650A, 1.4kV, 0.25A, 5V	C-74			
C378S	GES	650A, 700V, 0.25A, 5V	C-74			
C378T	GES	650A, 900V, 0.25A, 5V	C-74			
C380A	ASI, GES	400A, 100V, 0.2A, 3V	C-67	ECG85		
C380AX500	GES	500A, 100V, 0.2A, 3V	C-67			
C380AX555	GES	450A, 100V, 0.15A, 3V	C-57			
C380B	ASI, GES	400A, 200V, 0.2A, 3V	C-67			
C380BX500	GES	500A, 200V, 0.2A, 3V	C-67			
C380BX555	GES	450A, 200V, 0.15A, 3V	C-57			
C380D	ASI, GES	400A, 400V, 0.2A, 3V	C-67	ECG85		
C380DX500	GFS	500A, 400V, 0.2A, 3V	C-67			
C380DX555	GES	450A, 400V, 0.15A, 3V	C-57			
C380E	ASI, GES	400A, 500V, 0.2A, 3V	C-67			
C380EX500	GES	500A, 500V, 0.2A, 3V	C-67			



图 C-74



图 C-70

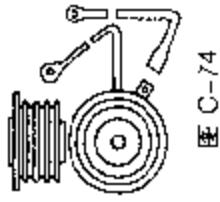

图 C-67



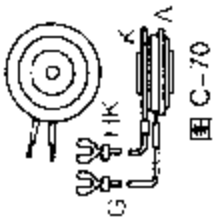

图 C-57

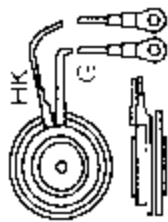
器件型号 Element type	厂名 Manufacturers	材料用途参数 Material Purpose Parameter	图号 Figure	国内外相似替换器件型号 Replace of similar type	备注 Notes	外形参考图 Reference shape
C380EX555	GES	450A, 500V, 0.15A, 3V	C-57			
C380M	ASI, GES	400A, 600V, 0.2A, 3V	C-67			
C380MX500	GES	500A, 600V, 0.2A, 3V	C-67			
C380MX555	GES	450A, 600V, 0.15A, 3V	C-57			
C380N	ASI, GES	400A, 800V, 0.2A, 3V	C-67			
C380NX500	GES	500A, 800V, 0.2A, 3V	C-67			
C380NX555	GFS	450A, 800V, 0.15A, 3V	C-57			
C380P	ASI, GES	400A, 1KV, 0.2A, 3V	C-67			
C380PAX555	GES	450A, 1.1KV, 0.15A, 3V	C-57			
C380PBX555	GES	450A, 1.2KV, 0.15A, 3V	F-71			
C380PC	ASI, GES	400A, 1.3KV, 0.2A, 3V	C-67			
C380PX555	GES	450A, 1KV, 0.15A, 3V				
C380S	ASI, GES	400A, 700V, 0.2A, 3V	C-67			
C380TX555	GES	450A, 900V, 0.15A, 3V	C-57			
C384A	GES	400A, 100V, 0.3A, 3V	C-67			
C384B	GES	400A, 200V, 0.3A, 3V	C-67			
C384C	GES	400A, 300V, 0.3A, 3V	C-67			
C384D	GES	400A, 400V, 0.3A, 3V	C-67			
C384E	GES	400A, 500V, 0.3A, 3V	C-67			
C384M	GES	400A, 600V, 0.3A, 3V	C-67			
C385A	ASI, VAN	400A, 100V, 0.3A, 3V	C-67			
C385B	ASI, VAN	400A, 200V, 0.3A, 3V	C-67	SK3293/107, T627012564DN		
C385C	ASI, VAN	400A, 300V, 0.3A, 3V	C-67			
C385D	ASI, VAN	400A, 400V, 0.3A, 3V	C-67			
C385E	ASI, VAN	400A, 500V, 0.3A, 3V	C-67			
C385M	ASI, VAN	400A, 600V, 0.3A, 3V	C-67			
C385N	GES	400A, 800V, 0.3A, 3V	C-67			
C385S	GES	400A, 700V, 0.3A, 3V	C-67			

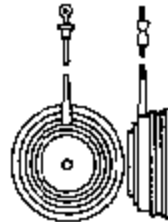
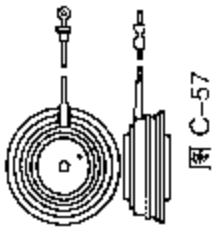
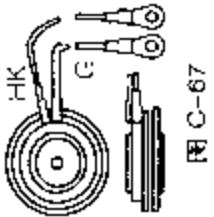

器件型号 Element type	厂名 Manufacturers	材料用途参数 Material Purpose Parameter	图号 Figure	国内外相似替换器件型号 Replace of similar type	备注 Notes	外形参考图 Reference shape
C387E	GES	550A, 500V, 0.15A, 3V	C-3			 <p>图 C-3</p>
C387M	GES	550A, 600V, 0.15A, 3V	C-3			
C387N	GES	550A, 800V, 0.15A, 3V	C-3			
C387P	GES	550A, 1kV, 0.15A, 3V	C-3			
C387PA	GES	550A, 1.1kV, 0.15A, 3V	C-3			
C387PB	GES	550A, 1.2kV, 0.15A, 3V	C-3			
C387S	GES	550A, 700V, 0.15A, 3V	C-3			
C387T	GES	550A, 900V, 0.15A, 3V	C-3			
C388E	GES	550A, 500V, 0.15A, 3V	C-3			
C388M	GES	550A, 600V, 0.15A, 3V	C-3			
C388N	GES	550A, 800V, 0.15A, 3V	C-3			
C388P	GES	550A, 1kV, 0.15A, 3V	C-3			
C388PA	GES	550A, 1.1kV, 0.15A, 3V	C-3			
C388PB	GES	550A, 1.2kV, 0.15A, 3V	C-3			
C388S	GES	550A, 700V, 0.15A, 3V	C-3			
C388T	GES	550A, 900V, 0.15A, 3V	C-3			
C390AX500	GES	910A, 100V, 0.2A, 5V	C-74			 <p>图 C-74</p>
C390AX550	GES	890A, 100V, 0.2A, 5V	C-74			
C390RX500	GES	910A, 200V, 0.2A, 5V	C-74			
C390BX550	GES	890A, 200V, 0.2A, 5V	C-74			
C390CX500	GES	910A, 300V, 0.2A, 5V	C-74			
C390CX550	GES	890A, 300V, 0.2A, 5V	C-74			
C390DX500	GES	910A, 400V, 0.2A, 5V	C-74			
C390DX550	GES	890A, 400V, 0.2A, 5V	C-74			
C390E	GES	800A, 500V, 0.15A, 5V	C-3			
C390EX500	GES	910A, 500V, 0.2A, 5V	C-74			
C390EX555	GES	480A, 500V, 0.15A, 5V	C-74			
C390M	GES	800A, 600V, 0.15A, 5V	C-3			

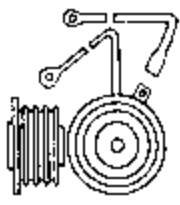

器件型号 Element type	厂名 Manufacturers	材料用途参数 Material Purpose Parameter	图号 Figure	国内外相似替换器型号 Replace of similar type	备注 Notes	外形参考图 Reference shape
C390MX500	GES	910A, 600V, 0.2A, 5V	C-74			 <p>图 C-14</p>
C390MX555	GES	480A, 600V, 0.15A, 5V	C-74			
C390N	GES	800A, 800V, 0.15A, 5V	C-74			
C390NX555	GES	480A, 800V, 0.15A, 5V	C-74			
C390P	GES	800A, 1kV, 0.15A, 5V	C-3			
C390PA	GES	800A, 1.1kV, 0.15A, 5V	C-3			
C390PAX555	GES	480A, 1.1kV, 0.15A, 5V	C-74	ECG5596		
C390PB	GES	800A, 1.2kV, 0.15A, 5V	C-3			
C390PBX555	GES	480A, 1.2kV, 0.15A, 5V	C-74	ECG5596		
C390PC	GES	800A, 1.3kV, 0.15A, 5V	C-3			
C390PX555	GES	480A, 1kV, 0.15A, 5V	C-74			
C390S	GES	800A, 700V, 0.15A, 5V	C-3			
C390SX555	GES	480A, 700V, 0.15A, 5V	C-3			
C390T	GES	800A, 900V, 0.15A, 5V	C-3			
C390TX555	GES	480A, 900V, 0.15A, 5V	C-3			
C391PC	GES	800A, 1.3kV, 0.15A, 5V	C-3			
C391PD	GES	800A, 1.4kV, 0.15A, 5V	C-3			
C391PE	GES	800A, 1.5kV, 0.15A, 5V	C-3			
C391PM	GES	800A, 1.6kV, 0.15A, 5V	C-3			
C391PS	GES	800A, 1.7kV, 0.15A, 5V	C-3			
C392A	GES	550A, 100V, 0.2A, 3V	C-3			
C392B	GES	550A, 200V, 0.2A, 3V	C-3			
C392C	GES	550A, 300V, 0.2A, 3V	C-3			
C392D	GES	550A, 400V, 0.2A, 3V	C-3			
C392E	GES	550A, 500V, 0.2A, 3V	C-3			
C392M	GES	550A, 600V, 0.2A, 3V	C-3			
C393A	GES	550A, 100V, 0.2A, 3V	C-3			
C393B	GES	550A, 200V, 0.2A, 3V	C-3			
C393C	GES	550A, 300V, 0.2A, 3V	C-3			



图 C-3

器件型号 Element type	厂名 Manufacturers	材料用途参数 Material Purpose Parameter	图号 Figure	国内外相似替换器件型号 Replace of similar type	备注 Notes	外形参考图 Reference shape	
C393D	GES	550A, 400V, 0.2A, 3V	C-3			 图 C-3	
C393E	GES	550A, 500V, 0.2A, 3V	C-3				
C393M	GES	550A, 600V, 0.2A, 3V	C-3				
C394A	GES	700A, 100V, 0.2A, 3V	C-3				
C394B	GES	700A, 200V, 0.2A, 3V	C-3				
C394C	GES	700A, 300V, 0.2A, 3V	C-3				
C394D	GES	700A, 400V, 0.2A, 3V	C-3				
C394E	GES	700A, 500V, 0.2A, 3V	C-3				
C394M	GES	700A, 600V, 0.2A, 3V	C-3				
C395A	GES	700A, 100V, 0.2A, 3V	C-3	ECG123A			
C395B	GES	700A, 200V, 0.2A, 3V	C-3				
C395C	GES	700A, 300V, 0.2A, 3V	C-3				
C395D	GES	700A, 400V, 0.2A, 3V	C-3				
C395E	GES	700A, 500V, 0.2A, 3V	C-3				
C395M	GES	700A, 600V, 0.2A, 3V	C-3				
C397E	GES	700A, 500V, 0.15A, 3V	C-3				 图 C-44
C397M	GES	700A, 600V, 0.15A, 3V	C-3				
C397N	GES	700A, 800V, 0.15A, 3V	C-3				
C397P	GES	700A, 1kV, 0.15A, 3V	C-3				
C397PA	GES	700A, 1.1kV, 0.15A, 3V	C-44				
C397PB	GES	700A, 1.2kV, 0.15A, 3V	C-3				
C397S	GES	700A, 700V, 0.15A, 3V	C-3				
C397T	GES	700A, 900V, 0.15A, 3V	C-3				
C398E	GES	700A, 500V, 0.15A, 3V	C-3				
C398M	GES	700A, 600V, 0.15A, 3V	C-3				
C398N	GES	700A, 800V, 0.15A, 3V	C-3				
C398P	GES	700A, 1kV, 0.15A, 3V	C-3				
C398PA	GES	700A, 1.1kV, 0.15A, 3V	C-44				

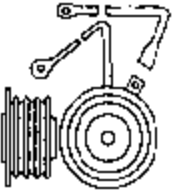

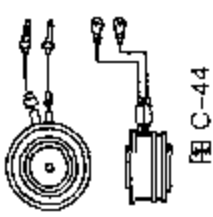
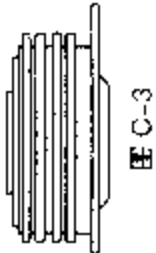
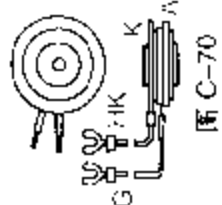
器件型号 Element type	厂名 Manufacturers	材料用途参数 Material Purpose Parameter	图号 Figure	国内外相似替换器件型号 Replace of similar type	备注 Notes	外形参考图 Reference shape
C398PB	GES	700A, 1.2kV, 0.15A, 3V	C-3			 
C398S	GES	700A, 700V, 0.15A, 3V	C-3			
C398T	GES	700A, 900V, 0.15A, 3V	C-3			
C430AX500	GES	4kA, 100V, 0.15A, 5V	C-70			
C430AX550	GES	4kA, 100V, 0.2A, 5V	C-70			
C430BX500	GES	4kA, 200V, 0.15A, 5V	C-70			
C430BX550	GES	4kA, 200V, 0.2A, 5V	C-70			
C430CX500	GES	4kA, 300V, 0.15A, 5V	C-70			
C430CX550	GES	4kA, 300V, 0.2A, 5V	C-70			
C430DX500	GES	4kA, 400V, 0.15A, 5V	C-70			
C430DX550	GES	4kA, 400V, 0.2A, 5V	C-70			
C430E	GES	550A, 500V, 0.15A, 5V	C-70			
C430EX500	GES	4kA, 500V, 0.15A, 5V	C-70			
C430M	GES	550A, 600V, 0.15A, 5V	C-70			
C430MX500	GES	4kA, 600V, 0.15A, 5V	C-70			
C430N	GES	550A, 800V, 0.15A, 5V	C-70			
C430P	GES	550A, 1kV, 0.15A, 5V	C-70			
C430PA	GES	550A, 1.1kV, 0.15A, 5V	C-70			
C430PB	GES	550A, 1.2kV, 0.15A, 5V	C-70			
C430PBX555	GES	1.2kA, 1.2kV, 0.2A, 5V	C-70			
C430PC	GES	550A, 1.3kV, 0.15A, 5V	C-70			
C430S	GES	550A, 700V, 0.15A, 5V	C-70			
C430T	GES	550A, 900V, 0.15A, 5V	C-70			
C431E1	GES	550A, 500V, 0.15A, 5V	C-70			
C431E2	GES	450A, 500V, 0.15A, 5V	C-70			
C431M1	GES	550A, 600V, 0.15A, 5V	C-70			
C431M2	GES	450A, 600V, 0.15A, 5V	C-70			
C431N1	GES	550A, 800V, 0.15A, 5V	C-70			

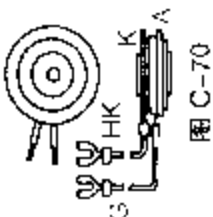

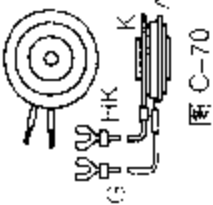

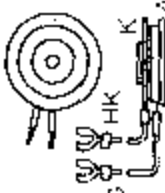

器件型号 Element type	厂名 Manufacturers	材料用途参数 Material Purpose Parameter	图号 Figure	国内外相似替换器件型号 Replace of similar type	备注 Notes	外形参考图 Reference shape
C431N2	GES	450A, 800V, 0.15A, 5V	C-70			
C431P1	GES	550A, 1kV, 0.15A, 5V	C-70			
C431P2	GES	450A, 1kV, 0.15A, 5V	C-70			
C431PA1	GES	550A, 1.1kV, 0.15A, 5V	C-70			
C431PA2	GES	450A, 1.1kV, 0.15A, 5V	C-70			
C431PB1	GES	550A, 1.2kV, 0.15A, 5V	C-70			
C431PB2	GES	450A, 1.2kV, 0.15A, 5V	C-70			
C431PC1	GES	550A, 1.3kV, 0.15A, 5V	C-70			
C431PC2	GES	450A, 1.3kV, 0.15A, 5V	C-70			
C431PD1	GES	550A, 1.4kV, 0.15A, 3V	C-70			
C431PE1	GES	550A, 1.5kV, 0.15A, 5V	C-70			
C431PE2	GES	450A, 1.5kV, 0.15A, 5V	C-70			
C431PM1	GES	550A, 1.6kV, 0.15A, 5V	C-70			
C431PM2	GES	450A, 1.6kV, 0.15A, 5V	C-70			
C431PN1	GES	550A, 1.8kV, 0.15A, 5V	C-70			
C431PN2	GES	450A, 1.8kV, 0.15A, 5V	C-70			
C431PS1	GES	550A, 1.7kV, 0.15A, 5V	C-70			
C431PS2	GES	450A, 1.7kV, 0.15A, 5V	C-70			
C431S1	GES	550A, 700V, 0.15A, 5V	C-70			
C431S2	GES	450A, 700V, 0.15A, 5V	C-70			
C431T1	GES	550A, 900V, 0.15A, 5V	C-70			
C431T2	GES	450A, 900V, 0.15A, 5V	C-70			
C434A	GES	650A, 100V, 0.2A, 5V	C-70			
C434B	GES	650A, 200V, 0.2A, 5V	C-70			
C434C	GES	650A, 300V, 0.2A, 5V	C-70			
C434D	GES	650A, 400V, 0.2A, 5V	C-70			
C434E	GES	650A, 500V, 0.2A, 5V	C-70			
C434M	GES	650A, 600V, 0.2A, 5V	C-70			

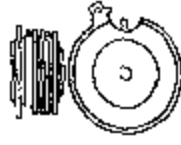
器件型号 Element type	厂名 Manufacturers	材料用途参数 Material Purpose Parameter	图号 Figure	国内外相似替换器件型号 Replace of similar type	备注 Notes	外形参考图 Reference shape
C434S	GES	650A, 700V, 0.2A, 5V	C-70			 <p>图 C-70</p>
C435A	GES	650A, 100V, 0.2A, 5V	C-70			
C435B	GES	650A, 200V, 0.2A, 5V	C-70			
C435C	GES	650A, 300V, 0.2A, 5V	C-70			
C435D	GES	650A, 400V, 0.2A, 5V	C-70			
C435E	GES	650A, 500V, 0.2A, 5V	C-70			
C435M	GES	650A, 600V, 0.2A, 5V	C-70			
C435S	GES	650A, 700V, 0.2A, 5V	C-70			
C436E	GES	500V, 0.15A, 5V	C-70			
C436M	GES	600V, 0.15A, 5V	C-70			
C436N	GES	800V, 0.15A, 5V	C-70			
C436P	GES	1kV, 0.15A, 5V	C-70			
C436PA	GES	1.1kV, 0.15A, 5V	C-70			
C436PB	GES	1.2kV, 0.15A, 5V	C-70			
C436S	GES	700V, 0.15A, 5V	C-70			
C436T	GES	900V, 0.15A, 5V	C-70			
C437E	GES	600A, 500V, 0.15A, 5V	C-70			
C437M	GES	600A, 600V, 0.15A, 5V	C-70			
C437N	GES	600A, 800V, 0.15A, 5V	C-70			
C437P	GES	600A, 1kV, 0.15A, 5V	C-70			
C437PA	GES	600A, 1.1kV, 0.15A, 5V	C-70			
C437PB	GES	600A, 1.2kV, 0.15A, 5V	C-70			
C437S	GES	600A, 700V, 0.15A, 5V	C-70			
C437T	GES	600A, 900V, 0.15A, 5V	C-70			
C438E	GES	600A, 500V, 0.15A, 5V	C-70			
C438M	GES	600A, 600V, 0.15A, 5V	C-70			
C438N	GES	600A, 800V, 0.15A, 5V	C-70			
C438P	GES	600A, 1kV, 0.15A, 5V	C-70			
C438PA	GES	600A, 1.1kV, 0.15A, 5V	C-70			

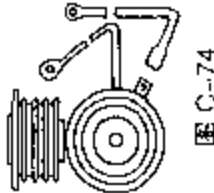

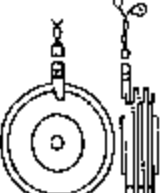
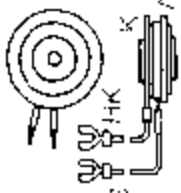
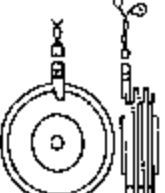
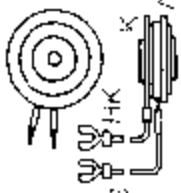
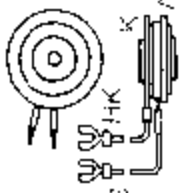
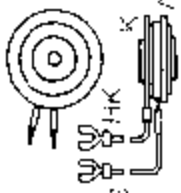
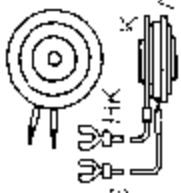
器件型号 Element type	厂名 Manufacturers	材料用途参数 Material Purpose Parameter	图号 Figure	国内外相似替换器型号 Replace of similar type	备注 Notes	外形参考图 Reference shape
C438PB	GES	600A, 1.2kV, 0.15A, 5V	C-70			 图 C-70
C438S	GES	600A, 700V, 0.15A, 5V	C-70			
C438T	GES	600A, 900V, 0.15A, 5V	C-70			
C440E	GES	1.4kA, 500V, 0.15A, 5V	C-3	ECG5598		 图 C-3
C440M	GES	1.4kA, 600V, 0.15A, 5V	C-3	ECG5598		
C440N	GES	1.4kA, 800V, 0.15A, 5V	C-3	ECG5599		
C440P	GES	1.4kA, 1kV, 0.15A, 5V	C-3	ECC5599		
C440PA	GES	1.4kA, 1.1kV, 0.15A, 5V	C-3	ECG5599		
C440PB	GES	1.4kA, 1.2kV, 0.15A, 5V	C-3	ECG5599		
C440PC	GFS	1.38kA, 1.3kV, 0.15A, 5V	C-11			
C440S	GES	1.4kA, 700V, 0.15A, 5V	C-3	ECG5599		
C440T	GES	1.4kA, 900V, 0.15A, 5V	C-3	ECG5599		
C441PC	GES	1.1kA, 1.3kV, 0.15A, 5V	C-3			
C441PD	GES	1.1kA, 1.4kV, 0.15A, 5V	C-3			
C441PE	GES	1.1kA, 1.5kV, 0.15A, 5V	C-3			
C441PM	GES	1.1kA, 1.6kV, 0.15A, 5V	C-3			
C441PN	GES	1.1kA, 1.8kV, 0.15A, 5V	C-3			
C441PS	GES	1.1kA, 1.7kV, 0.15A, 5V	C-3			
C444A	GES	1.1kA, 100V, 0.2A, 5V	C-74			 图 C-11
C444B	GES	1.1kA, 200V, 0.2A, 5V	C-74			
C444C	GES	1.1kA, 300V, 0.2A, 5V	C-74			
C444D	GES	1.1kA, 400V, 0.2A, 5V	C-74			
C444E	GES	1.1kA, 500V, 0.2A, 5V	C-74			
C444M	GES	1.1kA, 600V, 0.2A, 5V	C-74			
C445A	GES	1.1kA, 100V, 0.2A, 5V	C-74			
C445B	GES	1.1kA, 200V, 0.2A, 5V	C-74			
C445C	GES	1.1kA, 300V, 0.2A, 5V	C-74			

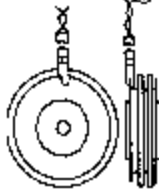
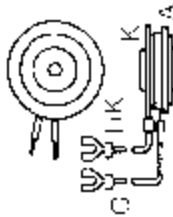

器件型号 Element type	厂名 Manufacturers	材料用途参数 Material Purpose Parameter	图号 Figure	国内外相似替换器件型号 Replace of similar type	备注 Notes	外形参考图 Reference shape
C445D	GES	1.1kA, 400V, 0.2A, 5V	C-74			 图 C-74
C445E	GES	1.1kA, 500V, 0.2A, 5V	C-74			
C445M	GES	1.1kA, 600V, 0.2A, 5V	C-74			
C447E	GES	1kA, 500V, 0.2A, 5V	C-74			 图 C-3
C447M	GES	1kA, 600V, 0.2A, 5V	C-74			
C447N	GES	1kA, 800V, 0.2A, 5V	C-74			
C447P	GES	1kA, 1kV, 0.2A, 5V	C-74			 图 C-25
C447PA	GES	1kA, 1.1kV, 0.2A, 5V	C-74			
C447PB	GES	1kA, 1.2kV, 0.2A, 5V	C-74			
C447S	GES	1kA, 700V, 0.2A, 5V	C-74			 图 C-70
C447T	GES	1kA, 900V, 0.2A, 5V	C-74			
C448E	GES	1kA, 500V, 0.2A, 5V	C-74			
C448M	GES	1kA, 600V, 0.2A, 5V	C-74			 图 C-25
C448N	GES	1kA, 800V, 0.2A, 5V	C-74			
C448P	GES	1kA, 1kV, 0.2A, 5V	C-74			
C448PA	GES	1kA, 1.1kV, 0.2A, 5V	C-74			 图 C-70
C448PB	GES	1kA, 1.2kV, 0.2A, 5V	C-74			
C448S	GES	1kA, 700V, 0.2A, 5V	C-74			
C448T	GES	1kA, 900V, 0.2A, 5V	C-74			 图 C-70
C449PE	GES	850A, 1.5kV, 0.2A, 5V	C-3			
C450E	GES	1.4kA, 500V, 0.15A, 5V	C-25			
C450E1, 2	GFS	2kA, 500V, 0.2A, 5V	C-70			 图 C-70
C450M	GES	1.4kA, 600V, 0.15A, 5V	C-25			
C450M1, 2	GES	2kA, 600V, 0.2A, 5V	C-70			
C450N	GES	1.4kA, 800V, 0.15A, 5V	C-25			 图 C-70
C450N1, 2	GES	2kA, 800V, 0.2A, 5V	C 70			
C450P	GES	1.4kA, 1kV, 0.15A, 5V	C-25			
C450P1, 2	GES	2kA, 1kV, 0.2A, 5V	C-70			 图 C

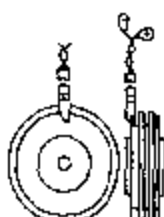
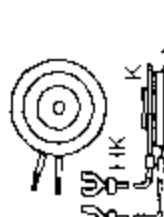

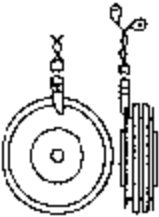

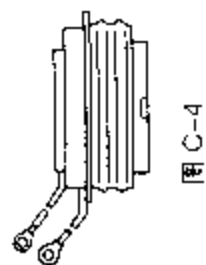
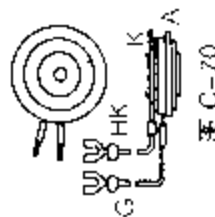
器件型号 Element type	厂名 Manufacturers	材料用途参数 Material Purpose Parameter	图号 Figure	国内外相似替换器件型号 Replace of similar type	备注 Notes	外形参考图 Reference shape	
C450PA	GES	1.4kA, 1.1kV, 0.15A, 5V	C-25			 <p>图 C-25</p>	
C450PA1, 2	GES	2kA, 1.1kV, 0.2A, 5V	C-70				
C450PB	GES	2kA, 1.2kV, 0.2A, 5V	C-25				
C450PC	GES	1.4kA, 1.3kV, 0.15A, 5V	C-25				
C450PD	GES	1.4kA, 1.4kV, 0.15A, 5V	C-25				
C450PD1, 2	GES	2kA, 1.4kV, 0.2A, 5V	C-70				
C450S	GES	1.4kA, 700V, 0.15A, 5V	C-25				
C450S1, 2	GES	2kA, 700V, 0.2A, 5V	C-70				
C450T	GES	1.4kA, 900V, 0.15A, 5V	C-25				
C450T1, 2	GES	2kA, 900V, 0.2A, 5V	C-70				
C451E-1	GES	1.4kA, 500V, 0.15A, 5V	C-25				 <p>图 C-70</p>
C451E-2	GES	1.3kA, 500V, 0.15A, 5V	C-25				
C451M-1	GES	1.4kA, 600V, 0.15A, 5V	C-25				
C451M-2	GES	1.3kA, 600V, 0.15A, 5V	C-25				
C451N-1	GES	1.4kA, 800V, 0.15A, 5V	C-25				
C451N-2	GES	1.3kA, 800V, 0.15A, 5V	C-25				
C451P-1	GES	1.4kA, 1kV, 0.15A, 5V	C-25				
C451P-2	GES	1.3kA, 1kV, 0.15A, 5V	C-25				
C451PA-1	GES	1.4kA, 1.1kV, 0.15A, 5V	C-25				
C451PA-2	GES	1.3kA, 1.1kV, 0.15A, 5V	C-25				
C451PB-1	GES	1.4kA, 1.2kV, 0.15A, 5V	C-25				
C451PB-2	GES	1.3kA, 1.2kV, 0.15A, 5V	C-25				
C451PC-1	GES	1.4kA, 1.3kV, 0.15A, 5V	C-25				
C451PC-2	GES	1.3kA, 1.3kV, 0.15A, 5V	C-25				
C451PD-1	GES	1.4kA, 1.4kV, 0.15A, 5V	C-25				
C451PD-2	GES	1.3kA, 1.4kV, 0.15A, 5V	C-25				
C451PE-1	GES	1.4kA, 1.5kV, 0.15A, 5V	C-25				
C451PE-2	GFS	1.3kA, 1.5kV, 0.15A, 5V	C-25				
C451PM-1	GES	1.4kA, 1.6kV, 0.15A, 5V	C-25				

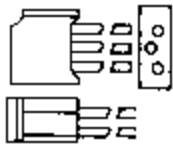
器件型号 Element type	厂名 Manufacturers	材料用途参数 Material Purpose Parameter	图号 Figure	国内外相似替换器件型号 Replace of similar type	备注 Notes	外形参考图 Reference shape	
C451PM-2	GES	1.3kA, 1.6kV, 0.15A, 5V	C-25			 <p>图 C-25</p>	
C451PN-1	GES	1.4kA, 1.7kV, 0.15A, 5V	C-25				
C451PN-2	GES	1.3kA, 1.7kV, 0.15A, 5V	C-25				
C451PS-1	GES	1.4kA, 1.8kV, 0.15A, 5V	C-25				
C451PS-2	GES	1.3kA, 1.8kV, 0.15A, 5V	C-25				
C451S-1	GES	1.4kA, 700V, 0.15A, 5V	C-25				
C451S-2	GES	1.3kA, 700V, 0.15A, 5V	C-25				
C451T-1	GES	1.4kA, 900V, 0.15A, 5V	C-25				
C451T-2	GES	1.3kA, 900V, 0.15A, 5V	C-25				
C457E	GES	2kA, 500V, 0.2A, 5V	C-25				 <p>图 C-70</p>
C457M	GES	2kA, 600V, 0.2A, 5V	C-25				
C457N	GES	2kA, 800V, 0.2A, 5V	C-25				
C457P	GES	2kA, 1kV, 0.2A, 5V	C-25				
C457PA	GES	2kA, 1.1kV, 0.2A, 5V	C-25				
C457PB	GES	2kA, 1.2kV, 0.2A, 5V	C-25				
C457PC	GES	2kA, 1.3kV, 0.2A, 5V	C-25				
C457PD	GES	2kA, 1.4kV, 0.2A, 5V	C-25				
C457S	GES	2kA, 700V, 0.2A, 5V	C-25				
C457T	GES	2kA, 900V, 0.2A, 5V	C-25				
C458E	GES	1.5kA, 500V, 0.15A, 5V	C-25				
C458M	GES	2kA, 600V, 0.15A, 5V	C-25	EGG85			
C458N	GES	1.5kA, 800V, 0.15A, 5V	C-25				
C458P	GES	2kA, 1kV, 0.15A, 5V	C-25	EGG85			
C458PA	GES	1.5kA, 1.1kV, 0.15A, 5V	C-25				
C458PB	GES	2kA, 1.2kV, 0.15A, 5V	C-25				
C458PC	GES	2kA, 1.3kV, 0.15A, 5V	C-70				
C458PD	GES	2kA, 1.4kV, 0.15A, 5V	C-25				
C458S	GES	2kA, 700V, 0.15A, 5V	C-25				

器件型号 Element type	厂名 Manufacturers	材料用途参数 Material Purpose Parameter	图号 Figure	国内外相似替换器件型号 Replace of similar type	备注 Notes	外形参考图 Reference shape
C458T	GES	1.5kA, 900V, 0.15A, 5V	C-25			 图 C-25
C477E	GES	500V, 0.25A, 5V	C-70			
C477M	GES	500V, 0.25A, 5V	C-70			
C477N	GES	800V, 0.25A, 5V	C-70			
C477P	GES	1kV, 0.25A, 5V	C-70			
C477PA	GES	1.1kV, 0.25A, 5V	C-70			
C477PB	GES	1.2kV, 0.25A, 5V	C-70			
C477PC	GES	1.3kV, 0.25A, 5V	C-70			
C477PD	GES	1.4kV, 0.25A, 5V	C-70			
C477S	GES	700V, 0.25A, 5V	C-70			
C477T	GES	900V, 0.25A, 5V	C-70			
C478E	GES	500V, 0.25A, 5V	C-70			
C478M	GES	600V, 0.25A, 5V	C-70			
C478N	GES	800V, 0.25A, 5V	C-70			
C478P	GES	1kV, 0.25A, 5V	C-70			
C478PA	GES	1.1kV, 0.25A, 5V	C-70			
C478PB	GES	1.2kV, 0.25A, 5V	C-70			
C478PC	GES	1.3kV, 0.25A, 5V	C-70			
C478PD	GES	1.4kV, 0.25A, 5V	C-70			
C478S	GES	700V, 0.25A, 5V	C-70			
C478T	GES	900V, 0.25A, 5V	C-70			
C501A	ASI, VAN	550A, 100V, 0.15A, 6.5V	C-4			
C501B	ASI, VAN	550A, 200V, 0.15A, 6.5V	C-4			
C501C	ASI, VAN	550A, 300V, 0.15A, 6.5V	C-4			
C501D	ASI, VAN	550A, 400V, 0.15A, 6.5V	C-4			
C501E	ASI, VAN	550A, 500V, 0.15A, 6.5V	C-4			
C501M	ASI, VAN	550A, 600V, 0.15A, 6.5V	C-4			

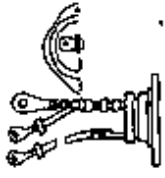





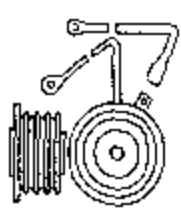
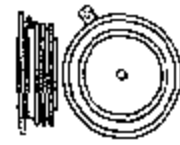

器件型号 Element type	厂名 Manufacturers	材料用途参数 Material Purpose Parameter	图号 Figure	国内外相似替换器件型号 Replace of similar type	备注 Notes	外形参考图 Reference shape	
C501N	ASI, VAN	700A, 800V, 0.15A, 6.5V	B-30			 图 B-30	
C501P	ASI, VAN	700A, 1.1kV, 0.15A, 6.5V	B-30				
C501PA	ASI, VAN	700A, 1.2kV, 0.15A, 6.5V	B-30				
C501PB	ASI, VAN	700A, 1.2kV, 0.15A, 6.5V	B-30				
C501PC	ASI, VAN	700A, 1.3kV, 0.15A, 6.5V	B-30				
C501PD	ASI, VAN	700A, 1.4kV, 0.15A, 3.5V	B-30				
C501PE	ASI, VAN	700A, 1.5kV, 0.15A, 6.5V	B-30				
C501PM	ASI, GES	700A, 1.6kV, 0.15A, 6.5V	B-30				
C501PN	VAN	700A, 1.6kV, 0.15A, 6.5V	B-30				
C501PS	ASI, GES	700A, 1.7kV, 0.15A, 6.5V	B-30				
C501S	ASI, GES	700A, 700V, 0.15A, 6.5V	B-30				
C501T	ASI, GES	700A, 900V, 0.15A, 6.5V	B-30				
C502L	GES	850A, 2kV, 0.15A, 4.5V	C-3				 图 C-3
C502LA	GES	850A, 2.1kV, 0.15A, 4.5V	C-3				
C502PE	GES	850A, 1.5kV, 0.15A, 4.5V	C-3				
C502PN	GES	850A, 1.8kV, 0.15A, 4.5V	C-3				
C502PS	GES	850A, 1.7kV, 0.15A, 4.5V	C-3				
C502PT	GES	850A, 1.9kV, 0.15A, 4.5V	C-3				
C601N	ASI, VAN	1.2kA, 800V, 0.15A, 4V	C-3				
C601P	ASI, VAN	1.2kA, 1kV, 0.15A, 4V	C-3				
C601PA	ASI, VAN	1.1kA, 1.1kV, 0.15A, 4.5V	C-3				
C601PB	ASI, VAN	1.1kA, 1.2kV, 0.15A, 4.5V	C-3				
C601PC	ASI, VAN	1.1kA, 1.3kV, 0.15A, 4.5V	C-3				
C601PD	ASI, VAN	1.1kA, 1.4kV, 0.15A, 4.5V	C-3				
C601PE	ASI, VAN	1.1kA, 1.5kV, 0.15A, 4.5V	C-3				
C601PM	ASI, VAN	1.1kA, 1.6kV, 0.15A, 4.5V	C-3				
C601PS	ASI, VAN	1.1kA, 1.7kV, 0.15A, 4.5V	C-3				
C601T	ASI, VAN	1.2kA, 900V, 0.15A, 4V	C-3				

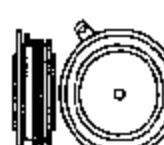
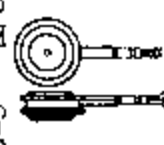
器件型号 Element type	厂名 Manufacturers	材料用途参数 Material Purpose Parameter	图号 Figure	国内外相似替换器件型号 Replace of similar type	备注 Notes	外形参考图 Reference shape
C602L	GES	900A, 2kV, 0.15A, 4.5V	E-9			
C602LA	GES	900A, 2.1kV, 0.15A, 4.5V	C-3			
C602LB	GES	900A, 2.2kV, 0.15A, 4.5V	C-3			
C602LC	GES	900A, 2.3kV, 0.15A, 4.5V	C-3			
C602LD	GES	900A, 2.4kV, 0.15A, 4.5V	C-3			
C602LE	GES	900A, 2.5kV, 0.15A, 4.5V	C-3			
C602LM	GES	900A, 2.6kV, 0.15A, 4.5V	C-3			
C602PN	GES	900A, 1.8kV, 0.15A, 4.5V	C-3			
C602PS	GES	900A, 1.7kV, 0.15A, 4.5V	C-3			
C602PT	GES	900A, 1.9kV, 0.15A, 4.5V	C-3			
C611A	GES	1.6A, 100V, 0.001A, 0.8V	D-34			
C611B	GES	1.6A, 200V, 0.001A, 0.8V	D-34			
C611F	GES	1.6A, 50V, 0.001A, 0.8V	D-34			
C611G	GES	1.6A, 150V, 0.001A, 0.8V	B-51			
C611U	GES	1.6A, 25V, 0.001A, 0.8V	D-34			
C612L	GES	1kA, 2kV, 0.15A, 4.5V	C-3			
C612PE	GES	1kA, 1.5kV, 0.15A, 4.5V	C-3			
C612PM	GES	1kA, 1.6kV, 0.15A, 4.5V	C-3			
C612PN	GES	1kA, 1.8kV, 0.15A, 4.5V	C-3			
C612PS	GES	1kA, 1.7kV, 0.15A, 4.5V	C-3			
C612PT	GES	1kA, 1.9kV, 0.15A, 4.5V	C-3			
C613L	GES	750A, 2kV, 0.18A, 5V	C-3			
C613PE	GES	750A, 1.5kV, 0.18A, 5V	C-3			
C613PM	GES	750A, 1.6kV, 0.18A, 5V	C-3			
C613PN	GES	750A, 1.8kV, 0.18A, 5V	C-3			
C613PS	GES	750A, 1.7kV, 0.18A, 5V	C-3			
C613PT	GES	750A, 1.9kV, 0.18A, 5V	C-3			

器件型号 Element type	厂名 Manufacturers	材料用途参数 Material Purpose Parameter	图号 Figure	国内外相似替换器件型号 Replace of similar type	备注 Notes	外形参考图 Reference shape
C648E	GES	1.1kA, 500V, 0.35A, 3V	C-74			 图 C-74
C648M	GES	1.1kA, 600V, 0.35A, 3V	C-3			
C648N	GES	1.1kA, 800V, 0.35A, 3V	C-3			
C648P	GES	1.1kA, 1kV, 0.35A, 3V	C-3			
C648PA	GES	1.1kA, 1.1kV, 0.35A, 3V	C-3			
C648PB	GES	1.1kA, 1.2kV, 0.35A, 3V	C-3			
C648S	GES	1.1kA, 700V, 0.35A, 3V	C-3			
C648T	GES	1.1kA, 900V, 0.35A, 3V	C-3			
C701L	GFS	1.5kA, 2kV, 0.15A, 4.5V				
C701PA	GES	1.5kA, 1.1kV, 0.15A, 4.5V				
C701PB	GES	1.5kA, 1.2kV, 0.15A, 4.5V				
C701PD	GES	1.5kA, 1.4kV, 0.15A, 4.5V				
C701PE	GES	1.5kA, 1.5kV, 0.15A, 4.5V				
C701PM	GES	1.5kA, 1.6kV, 0.15A, 4.5V				
C701PN	GES	1.5kA, 1.8kV, 0.15A, 4.5V				
C701PS	GES	1.5kA, 1.7kV, 0.15A, 4.5V				
C701PT	GES	1.5kA, 1.9kV, 0.15A, 4.5V				
C702L	GES	1.6kA, 2kV, 0.2A, 4.5V	C-3			 图 C-5
C702LA	GES	1.6kA, 2.1kV, 0.2A, 4.5V	C-3			
C702LB	GES	1.6kA, 2.2kV, 0.2A, 4.5V	C-3			
C702LC	GES	1.6kA, 2.3kV, 0.2A, 4.5V	C-3			
C702LD	GES	1.6kA, 2.4kV, 0.2A, 4.5V	C-3			
C712L	GES	1.5kA, 2kV, 0.12A, 3V	C-3			
C782L	GES	1.7kA, 2kV, 0.2A, 3.5V	C-5			
C782LA	GES	1.7kA, 2.1kV, 0.2A, 3.5V	C-5			
C782LB	GES	1.7kA, 2.2kV, 0.2A, 3.5V	C-5			





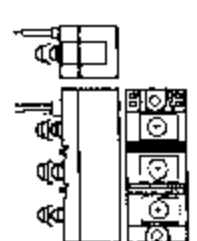

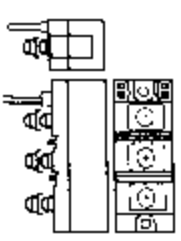

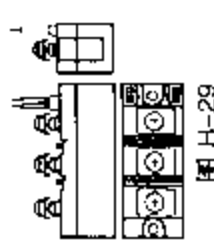
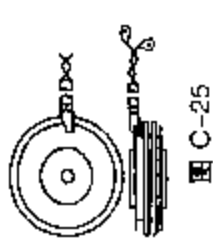
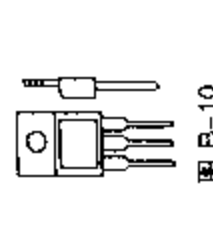
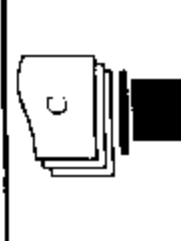

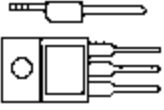
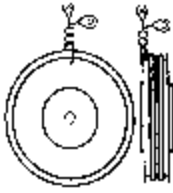
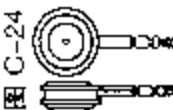



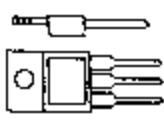
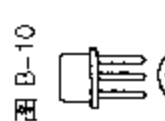

器件型号 Element type	厂名 Manufacturers	材料用途参数 Material Purpose Parameter	图号 Figure	国内外相似替换器件型号 Replace of similar type	备注 Notes	外形参考图 Reference shape
C782LC	GES	1.7kA, 2.3kV, 0.2A, 3.5V	C-5			 图 C-5
C782LD	GES	1.7kA, 2.4kV, 0.2A, 3V	B-31			
C783CB	GES	1.8kA, 3.1kV, 0.3A, 4.5V	C-5			
C783CC	GES	1.8kA, 3.2kV, 0.3A, 4.5V	C-5			
C783CD	GES	1.8kA, 3.3kV, 0.3A, 4.5V	C-5			
C783CE	GES	1.8kA, 3.4kV, 0.3A, 4.5V	C-5			
CA11CA		1kA, 2kV	C-64			 图 C-64
CA11CD		1kA, 2.3kV	C-64			
CA11CF		1kA, 2.5kV	C-64			
CA12DA		800A, 3kV	C-25			 图 C-25
CA12DF		800A, 3.5kV	C-25			
CA12EA		800A, 4kV	C-25			
CB200	UNI	0.25A, 30V, 400 μ A, 0.8V	B-65	SK3311		 图 B-65
CB201	UNI	0.25A, 60V, 400 μ A, 0.8V	B-65	EC103A, TAG06YY		
CB202	UNI	0.25A, 100V, 400 μ A, 0.8V	B-65	EC103A, TAG06A		
CB203	UNI	0.25A, 200V, 400 μ A, 0.8V	B-65	EC103B, TAG06B		
CB5020	UNI	GTO 0.25A, 30V, 500 μ A, 1V	B-65			 图 B-65
CB5021	UNI	GTO 0.25A, 60V, 500 μ A, 1V	B-65			
CB5022	UNI	GTO 0.25A, 100V, 500 μ A, 1V	B-65			
CB5023	UNI	GTO 0.25A, 200V, 500 μ A, 1V	B-65			
CC11VCA		SCR-N 600A, 2kV	C-25			 图 B-51
CC11VCD		SCR-N 600A, 2.3kV	C-25			
CD200	UNI	0.45A, 30V, 400 μ A, 0.8V	B-51	S0301MS2, 2N2323		 图 B-51
CD201	UNI	0.45A, 60V, 400 μ A, 0.8V	B-51	S1001MS2, 2N2323		

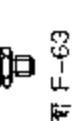

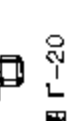

器件型号 Element type	厂名 Manufacturers	材料用途参数 Material Purpose Parameter	图号 Figure	国内外相似替换器件型号 Replace of similar type	备注 Notes	外形参考图 Reference shape
CD202	UNI	0.45A, 100V, 400 μ A, 0.6V	B-51	S1001MS2, 2N2324		 图 B-51
CD203	UNI	0.45A, 200V, 400 μ A, 0.6V	B-51	S2001MS2, 2N2326		
CD420140	WES	63A, 100V, 0.1A, 3V	H-29			 图 H-29
CD420160	WES	125A, 100V, 0.1A, 3V	H-29			
CD420190	WES	145A, 100V, 0.1A, 3V	H-29			
CD420240	WES	63A, 200V, 0.1A, 3V	H-29			
CD420260	WES	125A, 200V, 0.1A, 3V	H-29			
CD420290	WES	145A, 200V, 0.1A, 3V	H-29			
CD420440	WES	63A, 400V, 0.1A, 3V	H-29			
CD420460	WES	125A, 400V, 0.1A, 3V	H-29			
CD420490	WES	145A, 400V, 0.1A, 3V	H-29			
CD420640	WES	63A, 600V, 0.1A, 3V	H-29			
CD420660	WES	125A, 600V, 0.1A, 3V	H-29			
CD420690	WES	145A, 600V, 0.1A, 3V	H-29			
CD420840	WES	63A, 800V, 0.1A, 3V	H-29			
CD420860	WES	125A, 800V, 0.1A, 3V	H-29			
CD420890	WES	145A, 800V, 0.1A, 3V	H-29			
CD421040	WES	63A, 1kV, 0.1A, 3V	H-29			
CD421060	WES	125A, 1kV, 0.1A, 3V	H-29			
CD421090	WES	145A, 1kV, 0.1A, 3V	H-29			
CD421240	WES	63A, 1.2kV, 0.1A, 3V	H-29			
CD421260	WES	125A, 1.2kV, 0.1A, 3V	H-29			
CD421290	WES	145A, 1.2kV, 0.1A, 3V	H-29			
CD421440	WES	63A, 1.4kV, 0.1A, 3V	H-29			
CD421540	WES	63A, 1.5kV, 0.1A, 3V	H-29			
CD421560	WES	125A, 1.5kV, 0.1A, 3V	H-29			
CD421590	WES	145A, 1.5kV, 0.1A, 3V	H-29			



器件型号 Element type	厂名 Manufacturers	材料用途参数 Material Purpose Parameter	图号 Figure	国内外相似替换器件型号 Replace of similar type	备注 Notes	外形参考图 Reference shape
CD430140	WES	63A, 100V, 0.1A, 3V	H-29			 图 H-29
CD430160	WES	125A, 100V, 0.1A, 3V	H-29			
CD430190	WES	145A, 100V, 0.1A, 3V	H-29			
CD430240	WES	63A, 200V, 0.1A, 3V	H-29			
CD430260	WES	125A, 200V, 0.1A, 3V	H-29			
CD430290	WES	145A, 200V, 0.1A, 3V	H-29			
CD430440	WES	63A, 400V, 0.1A, 3V	H-29			
CD430460	WFS	125A, 400V, 0.1A, 3V	H-29			
CD430490	WES	145A, 400V, 0.1A, 3V	H-29			
CD430640	WES	63A, 600V, 0.1A, 3V	H-29			
CD430660	WES	125A, 600V, 0.1A, 3V	H-29			
CD430690	WES	145A, 600V, 0.1A, 3V	H-29			
CD430840	WES	63A, 800V, 0.1A, 3V	H-29			
CD430860	WES	125A, 800V, 0.1A, 3V	H-29			
CD430890	WES	145A, 800V, 0.1A, 3V	H-29			
CD431040	WES	63A, 1kV, 0.1A, 3V	H-29			
CD431060	WES	125A, 1kV, 0.1A, 3V	H-29			
CD431090	WES	145A, 1kV, 0.1A, 3V	H-29			
CD431240	WES	63A, 1.2kV, 0.1A, 3V	H-29			
CD431290	WES	145A, 1.2kV, 0.1A, 3V	H-29			
CD431440	WES	63A, 1.4kV, 0.1A, 3V	H-29			
CD431540	WES	63A, 1.5kV, 0.1A, 3V	H-29			
CD431560	WES	125A, 1.5kV, 0.1A, 3V	H-29			
CD431590	WES	145A, 1.5kV, 0.1A, 3V	H-29			
CD470140	WES	63A, 100V, 0.1A, 3V	H-29			
CD470160	WES	125A, 100V, 0.1A, 3V	H-29			
CD470190	WES	145A, 100V, 0.1A, 3V	H-29			

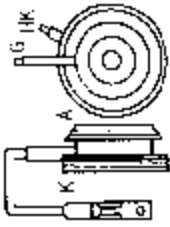
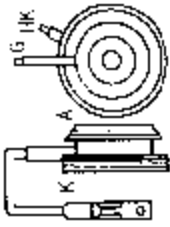

器件型号 Element type	厂名 Manufacturers	材料用途参数 Material Purpose Parameter	图号 Figure	国内外相似替换器件型号 Replace of similar type	备注 Notes	外形参考图 Reference shape
CD470240	WES	63A, 200V, 0.1A, 3V	H-29			 图 H-29
CD470260	WES	125A, 200V, 0.1A, 3V	H-29			
CD470290	WES	145A, 200V, 0.1A, 3V	H-29			
CD470440	WES	63A, 400V, 0.1A, 3V	H-29			 图 C-25
CD470460	WES	125A, 400V, 0.1A, 3V	H-29			
CD470490	WES	145A, 400V, 0.1A, 3V	H-29			
CD470640	WES	63A, 600V, 0.1A, 3V	H-29			 图 B-10
CD470660	WES	125A, 600V, 0.1A, 3V	H-29			
CD470690	WES	145A, 600V, 0.1A, 3V	H-29			
CD470840	WES	63A, 800V, 0.1A, 3V	H-29			 图 C
CD470860	WES	125A, 800V, 0.1A, 3V	H-29			
CD470890	WES	145A, 800V, 0.1A, 3V	H-29			
CD471040	WES	63A, 1kV, 0.1A, 3V	H-29			
CD471060	WES	125A, 1kV, 0.1A, 3V	H-29			
CD471090	WES	145A, 1kV, 0.1A, 3V	H-29			
CD471240	WES	63A, 1.2kV, 0.1A, 3V	H-29			
CD471260	WES	125A, 1.2kV, 0.1A, 3V	H-29			
CD471290	WES	145A, 1.2kV, 0.1A, 3V	H-29			
CD471440	WES	63A, 1.4kV, 0.1A, 3V	H-29			
CD471540	WES	63A, 1.5kV, 0.1A, 3V	H-29			
CD471660	WES	125A, 1.5kV, 0.1A, 3V	H-29			
CD471590	WES	145A, 1.5kV, 0.1A, 3V	H-29			
CF11VCA	SCR-N	400A, 2kV	C-25			
CF11VCD	SCR-N	400A, 2.3kV	C-25			
CF16C		500A, 200V	B-10			
CF16E		500A, 400V	B-10			
CF16G		500A, 600V	B-10			

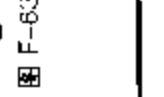

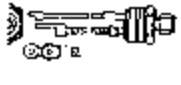
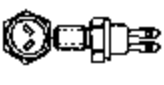



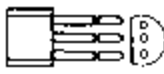



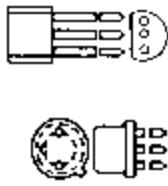











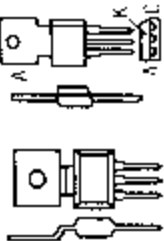

器件型号 Element type	厂名 Manufacturers	材料用途参数 Material Purpose Parameter	图号 Figure	国内外相似替换器件型号 Replace of similar type	备注 Notes	外形参考图 Reference shape
CF16J		500A, 800V	B-10			
CG11DA		1.5A, 3kV	C-24			
CG11DF		1.5A, 3.5kV	C-24			
CG11EA		1.5A, 4kV	C-24			
CH13CA		400A, 2kV	C-64			
CH13CD		400A, 2.3kV	C-64			
CH13CF		400A, 2.5kV	C-64			
CH13R		400A, 1.8kV	C-64			
CH16C		400A, 200V	B-10			
CH16E		400A, 400V	B-10			
CH16G		400A, 600V	B-10			
CH16J		400A, 800V	B-10			
CJ16C		250A, 200V	F-75			
CJ16E		250A, 400V	F-75			
CJ16G		250A, 600V	F-75			
CJ16J		250A, 800V	F-75			
CJ16VC		SCR-H 250A, 200V	F-75			
CJ16VE		SCR-H 250A, 400V	F-75			
CJ16VG		SCR-H 250A, 600V	F-75			
CJ16VJ		SCR-H 250A, 800V	F-75			
CJ18L		250A, 1kV	B-10			
CJ18VL		SCR-H 250A, 1kV	B-89			
CJ18VX		SCR-H 250A, 1.2kV	B-89			
CJ18VY		SCR-H 250A, 1.4kV	B-89			

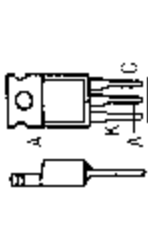
器件型号 Element type	厂名 Manufacturers	材料用途参数 Material Purpose Parameter	图号 Figure	国内外相似替换器件型号 Replace of similar type	备注 Notes	外形参考图 Reference shape
CJ18X		250A, 1.2kV	B-10			
CJ18Y		250A, 1.4kV	B-10			
CL1, 2, 3	UNI	SCS 0.45A, 200V, 200μA, 0.8V	B-55	ECG116, SK3016		
CL16C		100A, 200V	F-63			
CL16D		100A, 300V	F-63			
CL16E		100A, 400V	F-63			
CL16F		100A, 500V	F-63			
CL16G		100A, 600V	F-63			
CL16J		100A, 800V	F-63			
CL16VC		100A, 200V	F-63			
CL16VE		100A, 400V	F-63			
CL16VG		100A, 600V	F-63			
CL16VJ		100A, 800V	F-63			
CL18L		100A, 1kV	F-75			
CL18VL		100A, 1kV	F-20			
CL18VX		100A, 1.2kV	F-20			
CL18VY		100A, 1.4kV	F-20			
CL18X		100A, 1.2kV	F-75			
CL18Y		100A, 1.4kV	F-75			
CM16C		150A, 200V	F-75			
CM16E		150A, 400V	F-75			
CM16G		150A, 600V	F-75			
CM16J		150A, 800V	F-75			
CM16VC		150A, 200V	F-75			
CM16VE		150A, 400V	F-75			

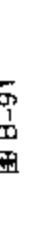
器件型号 Element type	厂名 Manufacturers	材料用途参数 Material Purpose Parameter	图号 Figure	国内外相似替换器件型号 Replace of similar type	备注 Notes	外形参考图 Reference shape
CM16VG CM16VJ	SCR-H SCR-H	150A, 600V 150A, 800V	F-75 F-75			
CM18I CM18VL CM18VX CM18VY CM18X CM18Y	SCR-H SCR-H SCR-H	150A, 1kV 150A, 1kV 150A, 1.2kV 150A, 1.4kV 150A, 1.2kV 150A, 1.4kV	F-75 F-75 F-75 F-75 F-75 F-75			
CN08C CN08D CN08E CN08F CN08G		50A, 200V 50A, 300V 50A, 400V 50A, 500V 50A, 600V	F-15 F-15 F-15 F-15 F-15			
CN16C CN16F CN16G CN16J		70A, 200V 70A, 400V 70A, 600V 70A, 800V	C-64			
CN16VC CN16VE CN16VG CN16VJ	SCR-H SCR-H SCR-H SCR-H	70A, 200V 70A, 400V 70A, 600V 70A, 800V	F-63 F-63 F-63 F-63			
CN18L CN18VL CN18VX CN18VY	SCR-H SCR-H SCR-H	70A, 1kV 70A, 1kV 70A, 1.2kV 70A, 1.4kV	F-63 F-63 F-63 F-63			

器件型号 Element type	厂名 Manufacturers	材料用途参数 Material Purpose Parameter	图号 Figure	国内外相似替换器件型号 Replace of similar type	备注 Notes	外形参考图 Reference snapo
CN16X		70A, 1.2kV	F-63			 图 F-63
CN16Y		70A, 1.4kV	F-63			
CP8C...G		30A, 200...600V, 0.05A	F-55	BTW48..., CS23..., MCR64..., TAG35....		 图 F 55
CP9C...G		30A, 200...600V, 0.05A	F-55			
CQ08C		16A, 200V	D-21			 图 D-21
CQ08D		16A, 300V	D-21			
CQ08E		16A, 400V	D-21			
CQ08F		16A, 500V	D-21			
CQ08G		16A, 600V	D-21			
CQ08C		16A, 200V	D-21			
CQ08D		16A, 300V	D-21			
CQ08E		16A, 400V	D-21			
CQ08F		16A, 500V	D-21			
CQ08G		16A, 600V	D-21			
CQ08C		16A, 200V	D-21			
CQ08D		16A, 300V	D-21			
CQ08E		16A, 400V	D-21			
CQ08F		16A, 500V	D-21			
CQ08G		16A, 600V	D-21			
CR08C		16A, 200V	D-21			 图 B-51
CR08D		16A, 300V	D-21			
CR08E		16A, 400V	D-21			
CR08F		16A, 500V	D-21			
CR08G		16A, 600V	D-21			
CR09C		16A, 200V	D-21			
CR09D		16A, 300V	D-21			
CR09E		16A, 400V	D-21			
CR09F		16A, 500V	D-21			
CR09G		16A, 600V	D-21			
CR1T01HY1	AEI	1.5A, 100V, 0.001A, 3V	B-51			

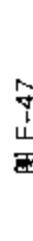
器件型号 Element type	厂名 Manufacturers	材料用途参数 Material Purpose Parameter	图号 Figure	国内外相似替换器件型号 Replace of similar type	备注 Notes	外形参考图 Reference shape	
CR1T01HY2	AEI	1.5A, 100V, 200 μ A, 3V	B-51			 图 B-51	
CR1T02HY	AEI	1.5A, 200V, 0.01A, 3V	B-51				
CR1T02HY1	AEI	1.5A, 200V, 0.001A, 3V	B-51				
CR1T02HY2	AEI	1.5A, 200V, 200 μ A, 3V	B-51				
CR1T03HY	AEI	1.5A, 300V, 0.01A, 3V	B-51				
CR1T03HY1	AEI	1.5A, 300V, 0.001A, 3V	B-51				
CR1T03HY2	AEI	1.5A, 300V, 200 μ A, 3V	B-51				
CR1T04HY	AEI	1.5A, 400V, 0.01A, 3V	B-51				
CR1T04HY1	AEI	1.5A, 400V, 0.001A, 3V	B-51				
CR1T04HY2	AEI	1.5A, 400V, 200 μ A, 3V	B-51				
CR1T05HY	AEI	1.5A, 500V, 0.01A, 3V	B-51				
CR1T05HY1	AEI	1.5A, 500V, 0.001A, 3V	B-51				
CR1T05HY2	AEI	1.5A, 500V, 200 μ A, 3V	B-51				
CR1T06HY	AEI	1.5A, 600V, 0.01A, 3V	B-51				
CR1T06HY1	AEI	1.5A, 600V, 0.001A, 3V	B-51				
CR1T06HY2	AEI	1.5A, 600V, 200 μ A, 3V	B-51				
CR1TX5HY	AEI	1.5A, 50V, 0.01A, 3V	B-51				 图 B-36
CR1TX5HY1	AEI	1.5A, 50V, 0.001A, 3V	B-51				
CR1TX5HY2	AEI	1.5A, 50V, 200 μ A, 3V	B-51				
CR02AM...		Thy =BRX48	B-36	BRX49		 图 F-21	
CR2AM1		2A, 50V	F-21				
CR2AM2		2A, 100V	F-21				
CR2AM4		2A, 200V	F-21				
CR2AM6		2A, 300V	F-21				
CR2AM8	MIT	2A, 400V, 250 μ A, 0.8V	F-21				
CR2AM10	MIT	2A, 500V, 250 μ A, 0.8V	F-21				
CR2AM12	MIT	2A, 600V, 250 μ A, 0.8V	F-21				
CR2T01HY	AEI	2.8A, 100V, 0.01A, 3V	B-51				

器件型号 Element type	厂名 Manufacturers	材料用途参数 Material Purpose Parameter	图号 Figure	国内外相似替换器件型号 Replace of similar type	备注 Notes	外形参考图 Reference shape
CR2T01HY1	AEI	2.8A, 100V, 0.001A, 3V	B-51			
CR2T02HY	AEI	2.8A, 200V, 0.01A, 3V	B-51			
CR2T02HY1	AEI	2.8A, 200V, 0.001A, 3V	B-51			
CR2T03HY	AEI	2.8A, 300V, 0.01A, 3V	B-51			
CR2T03HY1	AEI	2.8A, 300V, 0.001A, 3V	B-51			
CR2T04HY	AEI	2.8A, 400V, 0.01A, 3V	B-51			
CR2T04HY1	AEI	2.8A, 400V, 0.001A, 3V	B-51			
CR2T05HY	AEI	2.8A, 500V, 0.01A, 3V	B-51			
CR2T05HY1	AEI	2.8A, 500V, 0.001A, 3V	B-51			
CR2T06HY	AEI	2.8A, 600V, 0.01A, 3V	B-51			
CR2T06HY1	AEI	2.8A, 600V, 0.001A, 3V	B-51			
CR2TX5HY	AEI	2.8A, 50V, 0.01A, 3V	B-51			
CR2TX5HY1	AEI	2.8A, 50V, 0.001A, 3V	B-51			
CR03AM...		0.3A, 50-600V, 250 μA, 0.8V	B-36			
CR3AMZB	MIT	SCR-H 0.785A, 400V, 0.03A, 2V	C-3			
CR3CM...	MIT	3A, 50-600V, 250 μA, 0.8V	B-21			
CR3EM...		3A, 50-600V, 0.03A, 1.5V	B-87			
CR3JM8	MIT	SCR-H 1.2A, 400V, 0.05A, 2V	B-91			
CR3KZ8		SCR-H 160V, 400V	B-87			
CR3PZ8		SCR-H 0.8A, 400V	B-91			
CR4U01FY	AEI	6.5A, 100V, 0.025A, 2.5V	F-47	SK3942, SK5483		
CR4U01FY1	AEI	6.5A, 100V, 0.01A, 2.5V	F-47			
CR4U02FY	AEI	6.5A, 200V, 0.025A, 2.5V	F-47			
CR4U02FY1	AEI	6.5A, 200V, 0.01A, 2.5V	F-47			
CR4U03FY	AEI	6.5A, 300V, 0.025A, 2.5V	F-47	SK3943, SK5485		
CR4U03FY1	AEI	6.5A, 300V, 0.01A, 2.5V	F-47			
CR4U04FY	AEI	6.5A, 400V, 0.025A, 2.5V	F-47	SK3945, SK5485		

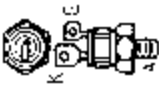
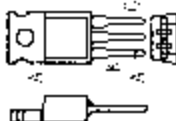

器件型号 Element type	厂名 Manufacturers	材料用途参数 Material Purpose Parameter	图号 Figure	国内外相似替换器件型号 Replace of similar type	备注 Notes	外形参考图 Reference shape	
CR4U04FY1	AEI	6.5A, 400V, 0.01A, 2.5V	F-47			 图 F-47	
CR4U05FY	AEI	6.5A, 500V, 0.025A, 2.5V	F-47	SK3944, SK5487			
CR4U05FY1	AEI	6.5A, 500V, 0.01A, 2.5V	F-47				
CR4U06FY	AEI	6.5A, 600V, 0.025A, 2.5V	F-47	SK3944, SK5487			
CR4U06FY1	AEI	6.5A, 600V, 0.01A, 2.5V	F-47				
CR4U08FY	AEI	6.5A, 800V, 0.025A, 2.5V	F-47				
CR4U08FY1	AEI	6.5A, 800V, 0.01A, 2.5V	F-47				
CR4U10FY	AEI	6.5A, 1kV, 0.025A, 2.5V	F-47				
CR4U10FY1	AEI	6.5A, 1kV, 0.01A, 2.5V	F-47				
CR4UX5FY	AEI	6.5A, 50V, 0.025A, 2.5V	F-47				
CR4UX5FY1	AEI	6.5A, 50V, 0.01A, 2.5V	F-47				
CR6AM2		6A, 100V	B-91				 图 B-91
CR6AM4		6A, 200V	B-91				
CR6AM6		6A, 300V	B-91				
CR6AM8	MIT	6A, 400V, 0.03A, 1.5V	B-91				
CR6AM10	MIT	6A, 500V, 0.03A, 1.5V	B-91				
CR6AM12	MIT	6A, 600V, 0.03A, 1.5V	B-91				
CR8U01FY	AEI	9.5A, 100V, 0.025A, 2.5V	F-47				
CR8U01FY1	AEI	9.5A, 100V, 0.01A, 2.5V	F-47				
CR8U02FY	AEI	9.5A, 200V, 0.025A, 2.5V	F-47				
CR8U02FY1	AEI	9.5A, 200V, 0.01A, 2.5V	F-47				
CR8U03FY	AEI	9.5A, 300V, 0.025A, 2.5V	F-47				
CR8U03FY1	AEI	9.5A, 300V, 0.01A, 2.5V	F-47				
CR8U04FY	AEI	9.5A, 400V, 0.025A, 2.5V	F-47				
CR8U04FY1	AEI	9.5A, 400V, 0.01A, 2.5V	F-47				
CR8U05FY	AEI	9.5A, 500V, 0.025A, 2.5V	F-47				
CR8U05FY1	AEI	9.5A, 500V, 0.01A, 2.5V	F-47				

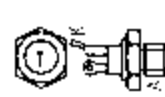
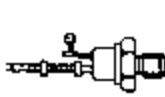

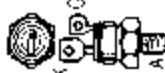
器件型号 Element type	厂名 Manufacturers	材料用途参数 Material Purpose Parameter	图号 Figure	国内外相似替换器件型号 Replace of similar type	备注 Notes	外形参考图 Reference shape	
CR8U06FY	AEI	9.5A, 600V, 0.025A, 2.5V	F-47			 图 F-47	
CR8U06FY1	AEI	9.5A, 600V, 0.01A, 2.5V	F-47				
CR8U08FY	AEI	9.5A, 800V, 0.025A, 2.5V	F-47				
CR8U08FY1	AEI	9.5A, 800V, 0.01A, 2.5V	F-47				
CR8U10FY	AEI	9.5A, 1kV, 0.025A, 2.5V	F-47				
CR8U10FY1	AEI	9.5A, 1kV, 0.01A, 2.5V	F-47				
CR8RX5FY	AEI	9.5A, 50V, 0.025A, 2.5V	F-47				
CR8RX5FY1	AEI	9.5A, 50V, 0.01A, 2.5V	F-47				
CR10C2	MIT	10A, 100V, 0.03A, 2.5V	F-30	SK5522, SK6622			 图 F-30
CR10C4	MIT	10A, 200V, 0.03A, 2.5V	F-30	SK5524, SK6624			
CR10C6	MIT	10A, 300V, 0.03A, 2.5V	F-30	SK5527, SK6627			
CR10C8	MIT	10A, 400V, 0.03A, 2.5V	F-30	SK5527, SK6627			
CR10C10	MIT	10A, 500V, 0.03A, 2.5V	F-30	SK5529, SK6629			
CR10C12	MIT	10A, 600V, 0.03A, 2.5V	F-30	SK5529, SK6629			
CR10C16	MIT	10A, 800V, 0.03A, 2.5V	F-30	SK5531, SK6631			
CR10CY2	MIT	SCR-H 10A, 100V, 0.04A, 2.5V	F-30				
CR10CY4	MIT	SCR-H 10A, 200V, 0.04A, 2.5V	F-30				
CR10CY6	MIT	SCR-H 10A, 300V, 0.04A, 2.5V	F-30				
CR10CY8	MIT	SCR-H 10A, 400V, 0.04A, 2.5V	F-30				
CR10CY10	MIT	SCR-H 10A, 500V, 0.04A, 2.5V	F-30			 图 E-6	
CR10CY12	MIT	SCR-H 10A, 600V, 0.04A, 2.5V	F-30				
CR12M01JY	AEI	14A, 100V, 0.06A, 3V	E-6				
CR12M01JY1	AEI	14A, 100V, 0.04A, 3V	E-6				
CR12M02JY	AEI	14A, 200V, 0.06A, 3V	E-6				
CR12M02JY1	AEI	14A, 200V, 0.04A, 3V	E-6				
CR12M03JY	AEI	14A, 300V, 0.06A, 3V	E-6				
CR12M03JY1	AEI	14A, 300V, 0.04A, 3V	E-6				

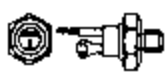
器件型号 Element type	厂名 Manufacturers	材料用途参数 Material Purpose Parameter	图号 Figure	国内外相似替换器件型号 Replace of similar type	备注 Notes	外形参考图 Reference shape
CR12M04JY	AEI	14A, 400V, 0.06A, 3V	E-6			 图 E-6
CR12M04JY1	AEI	14A, 400V, 0.04A, 3V	E-6			
CR12M05JY	AEI	14A, 500V, 0.06A, 3V	E-6			
CR12M05JY1	AEI	14A, 500V, 0.04A, 3V	E-6			
CR12M06JY	AEI	14A, 600V, 0.06A, 3V	E-6			
CR12M06JY1	AEI	14A, 600V, 0.04A, 3V	E-6			
CR12M08JY	AEI	14A, 800V, 0.06A, 3V	E-6			
CR12M08JY1	AEI	14A, 800V, 0.04A, 3V	E-6			
CR12M10JY	AEI	14A, 1KV, 0.06A, 3V	E-6			
CR12M10JY1	AEI	14A, 1KV, 0.04A, 3V	E-6			
CR12M11JY	AEI	14A, 1.1KV, 0.06A, 3V	E-6			
CR12M11JY1	AEI	14A, 1.1KV, 0.04A, 3V	E-6			
CR12M12JY	AEI	14A, 1.2KV, 0.06A, 3V	E-6			
CR12M12JY1	AEI	14A, 1.2KV, 0.04A, 3V	E-6			
CR12M13JY	AEI	14A, 1.3KV, 0.06A, 3V	E-6			
CR12M13JY1	AEI	14A, 1.3KV, 0.04A, 3V	E-6			
CR12M14JY	AEI	14A, 1.4KV, 0.06A, 3V	E-6			
CR12M14JY1	AEI	14A, 1.4KV, 0.04A, 3V	E-6			
CR12MX5JY	AEI	14A, 50V, 0.06A, 3V	E-6			
CR12MX5JY1	AEI	14A, 50V, 0.04A, 3V	E-6			
CR12U01JY	AEI	14A, 100V, 0.06A, 3V	F-47			 图 F-47
CR12U01JY1	AEI	14A, 100V, 0.04A, 3V	F-47			
CR12U02JY	AEI	14A, 200V, 0.06A, 3V	F-47			
CR12U02JY1	AEI	14A, 200V, 0.04A, 3V	F-47			
CR12U03JY	AEI	14A, 300V, 0.06A, 3V	F-47			
CR12U03JY1	AEI	14A, 300V, 0.04A, 3V	F-47			
CR12U04JY	AEI	14A, 400V, 0.06A, 3V	F-47			
CR12U04JY1	AEI	14A, 400V, 0.04A, 3V	F-47			
CR12U05JY	AEI	14A, 500V, 0.06A, 3V	F-47			

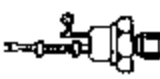

器件型号 Element type	厂名 Manufacturers	材料 Material	器件用途与参数 Purpose and parameter	图号 Figure	国内外相似替换器件型号 Replace of similar type	备注 Notes	外形参考图 Reference shape	
CR12U05JY1	AEI		14A, 500V, 0.04A, 3V	F-47			 图 F-47	
CR12U06JY	AEI		14A, 600V, 0.06A, 3V	F-47				
CR12U06JY1	AEI		14A, 600V, 0.04A, 3V	F-47				
CR12U08JY	AEI		14A, 800V, 0.06A, 3V	F-47				
CR12U08JY1	AEI		14A, 800V, 0.04A, 3V	F-47				
CR12U10JY	AEI		14A, 1kV, 0.06A, 3V	F-47				
CR12U10JY1	AEI		14A, 1kV, 0.04A, 3V	F-47				
CR12U11JY	AEI		14A, 1.1kV, 0.06A, 3V	F-47				
CR12U11JY1	AEI		14A, 1.1kV, 0.04A, 3V	F-47				
CR12U12JY	AEI		14A, 1.2kV, 0.06A, 3V	F-47				
CR12U12JY1	AEI		14A, 1.2kV, 0.04A, 3V	F-47				
CR12U13JY	AEI		14A, 1.3kV, 0.06A, 3V	F-47				
CR12U13JY1	AEI		14A, 1.3kV, 0.04A, 3V	F-47				
CR12UX5JY	AEI		14A, 50V, 0.06A, 3V	F-47				
CR12UX5JY1	AEI		14A, 50V, 0.04A, 3V	F-47				
CR20EY2	MIT	SCR-H	20A, 100V, 0.05A, 3V	F-27				 图 F-27
CR20EY4	MIT	SCR H	20A, 200V, 0.05A, 3V	F-27				
CR20EY6	MIT	SCR-H	20A, 300V, 0.05A, 3V	F-27				
CR20EY8	MIT	SCR-H	20A, 400V, 0.05A, 3V	F-27				
CR20EY10	MIT	SCR-H	20A, 500V, 0.05A, 3V	F-27				
CR20EY12	MIT	SCR-H	20A, 600V, 0.05A, 3V	F-27				
CR20EY14	MIT	SCR-H	20A, 700V	F-27				
CR20EY16	MIT	SCR-H	20A, 800V, 0.05A, 3V	F-27				
CR20F2	MIT		20A, 100V, 0.05A, 3V	F-30				
CR20F4	MIT		20A, 200V, 0.05A, 3V	F-30				
CR20F5	MIT		20A, 300V, 0.05A, 3V	F-30				
CR20F8	MIT		20A, 400V, 0.05A, 3V	F-30				
CR20F10	MIT		20A, 500V, 0.05A, 3V	F-30				





器件型号 Element type	厂名 Manufacturers	材料用途参数 Material Purpose Parameter	图号 Figure	国内外相似替换器件型号 Replace of similar type	备注 Notes	外形参考图 Reference shape
CR20F12	MIT	20A, 600V, 0.05A, 3V	F-30			 图 F-30
CR20F16	MIT	20A, 800V, 0.05A, 3V	F-30			
CR20F20	MIT	20A, 1kV, 0.05A, 3V	F-30			
CR20F24	MIT	20A, 1.2kV, 0.05A, 3V	F-30			
CR20M01JY	AEI	25A, 100V, 0.06A, 3V	E-6			 图 E-6
CR20M01JY1	AEI	25A, 100V, 0.04A, 3V	E-6			
CR20M02JY	AEI	25A, 200V, 0.06A, 3V	E-6			
CR20M02JY1	AEI	25A, 200V, 0.04A, 3V	E-6			
CR20M03JY	AEI	25A, 300V, 0.06A, 3V	E-6			
CR20M03JY1	AEI	25A, 300V, 0.04A, 3V	E-6			
CR20M04JY	AEI	25A, 400V, 0.06A, 3V	E-6			
CR20M04JY1	AEI	25A, 400V, 0.04A, 3V	E-6			
CR20M05JY	AEI	25A, 500V, 0.06A, 3V	E-6			
CR20M05JY1	AEI	25A, 500V, 0.04A, 3V	E-6			
CR20M06JY	AEI	25A, 600V, 0.06A, 3V	E-6			
CR20M06JY1	AEI	25A, 600V, 0.04A, 3V	E-6			
CR20M08JY	AEI	25A, 800V, 0.06A, 3V	E-6			
CR20M08JY1	AEI	25A, 800V, 0.04A, 3V	E-6			
CR20M10JY	AEI	25A, 1kV, 0.06A, 3V	E-6			
CR20M10JY1	AEI	25A, 1kV, 0.04A, 3V	E-6			
CR20M11JY	AEI	25A, 1.1kV, 0.06A, 3V	E-6			
CR20M11JY1	AEI	25A, 1.1kV, 0.04A, 3V	E-6			
CR20M12JY	AEI	25A, 1.2kV, 0.06A, 3V	E-6			
CR20M12JY1	AEI	25A, 1.2kV, 0.04A, 3V	E-6			
CR20M13JY	AEI	25A, 1.3kV, 0.06A, 3V	E-6			
CR20M13JY1	AEI	25A, 1.3kV, 0.04A, 3V	E-6			
CR20M14JY	AEI	25A, 1.4kV, 0.06A, 3V	E-6			
CR20M14JY1	AEI	25A, 1.4kV, 0.04A, 3V	E-6			
CR20MX5JY	AEI	25A, 50V, 0.06A, 3V	E-6			



器件型号 Element type	厂名 Manufacturers	材料用途参数 Material Purpose Parameter	图号 Figure	国内外相似替换器件型号 Replace of similar type	备注 Notes	外形参考图 Reference shape
CR20MX5JY1	AEI	25A, 50V, 0.04A, 3V	E-6			 图 E-6
CR20U01JY	AEI	25A, 100V, 0.06A, 3V	F-47			
CR20U01JY1	AEI	25A, 100V, 0.04A, 3V	F-47			 图 F-47
CR20U02JY	AEI	25A, 200V, 0.06A, 3V	F-47			
CR20U02JY1	AEI	25A, 200V, 0.04A, 3V	F-47			
CR20U03JY	AEI	25A, 300V, 0.06A, 3V	F-47			
CR20U03JY1	AEI	25A, 300V, 0.04A, 3V	F-47			
CR20U04JY	AEI	25A, 400V, 0.06A, 3V	F-47			
CR20U04JY1	AEI	25A, 400V, 0.04A, 3V	F-47			
CR20U05JY	AEI	25A, 500V, 0.06A, 3V	F-47			
CR20U05JY1	AEI	25A, 500V, 0.04A, 3V	F-47			
CR20U06JY	AEI	25A, 600V, 0.06A, 3V	F-47			
CR20U06JY1	AEI	25A, 600V, 0.04A, 3V	F-47			
CR20U08JY	AEI	25A, 800V, 0.06A, 3V	F-47			
CR20U08JY1	AEI	25A, 800V, 0.04A, 3V	F-47			
CR20U10JY	AEI	25A, 1kV, 0.06A, 3V	F-47			
CR20U10JY1	AEI	25A, 1kV, 0.04A, 3V	F-47			
CR20U11JY	AEI	25A, 1.1kV, 0.06A, 3V	F-47			
CR20U11JY1	AEI	25A, 1.1kV, 0.04A, 3V	F-47			
CR20U12JY	AEI	25A, 1.2kV, 0.06A, 3V	F-47			
CR20U12JY1	AEI	25A, 1.2kV, 0.04A, 3V	F-47			
CR20U13JY	AEI	25A, 1.3kV, 0.06A, 3V	F-47			
CR20U13JY1	AEI	25A, 1.3kV, 0.04A, 3V	F-47			
CR20UX5JY	AEI	25A, 50V, 0.06A, 3V	F-47			
CR20UX5JY1	AEI	25A, 50V, 0.04A, 3V	F-47			
CR24M01JY	AEI	35A, 100V, 0.06A, 3V	E-6			
CR24M01JY1	AEI	35A, 100V, 0.04A, 3V	E-6			
CR24M02JY	AEI	36A, 200V, 0.06A, 3V	E-6			





器件型号 Element type	厂名 Manufacturers	材料用途参数 Material Purpose Parameter	图号 Figure	国内外相似替换器件型号 Replace of similar type	备注 Notes	外形参考图 Reference shape	
CR24M02JY1	AEI	36A, 200V, 0.04A, 3V	E-6			 图 E-6	
CR24M03JY	AEI	36A, 300V, 0.06A, 3V	E-6				
CR24M03JY1	AEI	36A, 300V, 0.04A, 3V	E-6				
CR24M04JY	AEI	36A, 400V, 0.06A, 3V	E-6	TAG24N400DM			
CR24M04JY1	AEI	36A, 400V, 0.04A, 3V	E-6	TAG24N500DM			
CR24M05JY	AEI	36A, 500V, 0.06A, 3V	E-6				
CR24M05JY1	AEI	36A, 500V, 0.04A, 3V	E-6	TAG24N600DM			
CR24M06JY	AEI	36A, 600V, 0.06A, 3V	E-6				
CR24M06JY1	AEI	36A, 600V, 0.04A, 3V	E-6	TAG24N800DM			
CR24M08JY	AEI	36A, 800V, 0.06A, 3V	E-6				
CR24M08JY1	AEI	36A, 800V, 0.04A, 3V	E-6				
CR24M10JY	AEI	36A, 1kV, 0.06A, 3V	E-6				
CR24M10JY1	AEI	36A, 1kV, 0.04A, 3V	E-6	TAG24N1100LM			
CR24M11JY	AEI	36A, 1.1kV, 0.06A, 3V	E-6				
CR24M11JY1	AEI	36A, 1.1kV, 0.04A, 3V	E-6				
CR24M12JY	AEI	36A, 1.2kV, 0.06A, 3V	E-6				
CR24M12JY1	AEI	36A, 1.2kV, 0.04A, 3V	E-6	TAG24N1300LM			
CR24M13JY	AEI	36A, 1.3kV, 0.06A, 3V	E-6				
CR24M13JY1	AEI	36A, 1.3kV, 0.04A, 3V	E-6				
CR24MX5JY	AEI	36A, 50V, 0.06A, 3V	E-6				
CR24MX5JY1	AEI	36A, 50V, 0.04A, 3V	E-6				
CR24U01JY	AEI	35A, 100V, 0.06A, 3V	F-47				 图 F-47
CR24U01JY1	AEI	35A, 100V, 0.04A, 3V	F-47				
CR24U02JY	AEI	36A, 200V, 0.06A, 3V	F-47				
CR24U02JY1	AEI	36A, 200V, 0.04A, 3V	F-47				
CR24U03JY	AEI	36A, 300V, 0.06A, 3V	F-47				
CR24U03JY1	AEI	36A, 300V, 0.04A, 3V	F-47				
CR24U04JY	AEI	36A, 400V, 0.06A, 3V	F-47				
CR24U04JY1	AEI	36A, 400V, 0.04A, 3V	F-47				

器件型号 Element type	厂名 Manufacturers	材料用途参数 Material Purpose Parameter	图号 Figure	国内外相似替换器件型号 Replace of similar type	备注 Notes	外形参考图 Reference shape
CR24U05JY	AEI	36A, 500V, 0.06A, 3V	F-47			 图 F-47
CR24U05JY1	AEI	36A, 500V, 0.04A, 3V	F-47			
CR24U06JY	AEI	36A, 600V, 0.06A, 3V	F-47			
CR24U06JY1	AEI	36A, 600V, 0.04A, 3V	F-47			
CR24U08JY	AEI	36A, 800V, 0.06A, 3V	F-47			
CR24U08JY1	AEI	36A, 800V, 0.04A, 3V	F-47			
CR24U10JY1	AEI	36A, 1kV, 0.04A, 3V	F-47			
CR24U11JY	AEI	36A, 1.1kV, 0.06A, 3V	F-47			
CR24U11JY1	AEI	36A, 1.1kV, 0.04A, 3V	F-47			
CR24U12JY	AEI	36A, 1.2kV, 0.06A, 3V	F-47			
CR24U12JY1	AEI	36A, 1.2kV, 0.04A, 3V	F-47			
CR24U13JY	AEI	36A, 1.3kV, 0.06A, 3V	F-47			
CR24U13JY1	AEI	36A, 1.3kV, 0.04A, 3V	F-47			
CR24UX5JY	AEI	36A, 50V, 0.06A, 3V	F-47			
CR24UX5JY1	AEI	35A, 50V, 0.04A, 3V	F-47			
CR30-01	CRi	30A, 100V, 0.06A, 3V				
CR30-02	CRi	30A, 200V, 0.06A, 3V				
CR30-04	CRi	30A, 400V, 0.06A, 3V				
CR30-08	CRi	30A, 800V, 0.06A, 3V				
CR30-10	CRi	30A, 1kV, 0.06A, 3V				
CR30FT01	CRi	30A, 100V, 0.06A, 3V				
CR30FT02	CRi	30A, 200V, 0.06A, 3V				
CR30FT04	CRi	30A, 400V, 0.06A, 3V				
CR30FT06	CRi	30A, 600V, 0.06A, 3V				
CR30FT08	CRi	30A, 800V, 0.06A, 3V				
CR30FT10	CRi	30A, 1kV, 0.06A, 3V				
CR32M01JY	AEI	35A, 100V, 0.06A, 3V	E-6			

器件型号 Element type	厂名 Manufacturers	材料用途参数 Material Purpose Parameter	图号 Figure	国内外相似替换器件型号 Replace of similar type	备注 Notes	外形参考图 Reference shape	
CR32M01JY1	AEI	35A, 100V, 0.04A, 3V	E-6			 图 E-6	
CR32M02JY	AEI	46A, 200V, 0.06A, 3V	E-6				
CR32M02JY1	AEI	46A, 200V, 0.04A, 3V	E-6				
CR32M03JY	AEI	46A, 300V, 0.06A, 3V	E-6				
CR32M03JY1	AEI	46A, 300V, 0.04A, 3V	E-6				
CR32M04JY	AEI	46A, 400V, 0.06A, 3V	E-6				
CR32M04JY1	AEI	46A, 400V, 0.04A, 3V	E-6				
CR32M05JY	AEI	46A, 500V, 0.06A, 3V	E-6				
CR32M05JY1	AEI	46A, 500V, 0.04A, 3V	E-6				
CR32M06JY	AEI	46A, 600V, 0.06A, 3V	E-6				
CR32M06JY1	AEI	46A, 600V, 0.04A, 3V	E-6				
CR32M08JY	AEI	46A, 800V, 0.06A, 3V	E-6				
CR32M08JY1	AEI	46A, 800V, 0.04A, 3V	E-6				
CR32M10JY	AEI	46A, 1KV, 0.06A, 3V	E-6				
CR32M10JY1	AEI	46A, 1KV, 0.04A, 3V	E-6				
CR32M11JY	AEI	46A, 1.1KV, 0.06A, 3V	E-6				
CR32M11JY1	AEI	46A, 1.1KV, 0.04A, 3V	E-6				
CR32M12JY	AEI	46A, 1.2KV, 0.06A, 3V	E-6				
CR32M12JY1	AEI	46A, 1.2KV, 0.04A, 3V	E-6				
CR32M13JY	AEI	46A, 1.3KV, 0.06A, 3V	E-6				
CR32M13JY1	AEI	46A, 1.3KV, 0.04A, 3V	E-6				
CR32M14JY	AEI	46A, 1.4KV, 0.06A, 3V	E-6				
CR32M14JY1	AEI	46A, 1.4KV, 0.04A, 3V	E-6				
CR32MX5JY	AEI	46A, 50V, 0.06A, 3V	E-6				
CR32U01JY	AEI	35A, 100V, 0.04A, 3V	F-47				 图 F-47
CR32U02JY	AEI	46A, 200V, 0.06A, 3V	F-47				
CR32U02JY1	AEI	46A, 200V, 0.04A, 3V	F-47				
CR32U03JY	AEI	46A, 300V, 0.06A, 3V	F-47				
CR32U03JY1	AEI	46A, 300V, 0.04A, 3V	F-47				
CR32U03JY1	AEI	46A, 300V, 0.04A, 3V	F-47				

器件型号 Element type	厂名 Manufacturers	材料用途参数 Material Purpose Parameter	图号 Figure	国内外相似替换器件型号 Replace of similar type	备注 Notes	外形参考图 Reference shape	
CR32U04JY	AEI	46A, 400V, 0.06A, 3V	F-47			 图 F-47	
CR32U04JY1	AEI	46A, 400V, 0.04A, 3V	F-47				
CR32U05JY	AEI	46A, 500V, 0.06A, 3V	F-47				
CR32U05JY1	AEI	46A, 500V, 0.04A, 3V	F-47				
CR32U06JY	AEI	46A, 600V, 0.06A, 3V	F-47				
CR32U06JY1	AEI	46A, 600V, 0.04A, 3V	F-47				
CR32U08JY	AEI	46A, 800V, 0.06A, 3V	F-47				
CR32U08JY1	AEI	46A, 800V, 0.04A, 3V	F-47				
CR32U10JY	AEI	46A, 1kV, 0.06A, 3V	F-47				
CR32U10JY1	AEI	46A, 1kV, 0.04A, 3V	F-47				
CR32U11JY	AEI	46A, 1.1kV, 0.06A, 3V	F-47				
CR32U11JY1	AEI	46A, 1.1kV, 0.04A, 3V	F-47				
CR32U12JY	AEI	46A, 1.2kV, 0.06A, 3V	F-47				
CR32U12JY1	AEI	46A, 1.2kV, 0.04A, 3V	F-47				
CR32U13JY	AEI	46A, 1.3kV, 0.06A, 3V	F-47				
CR32U13JY1	AEI	46A, 1.3kV, 0.04A, 3V	F-47				
CR32UX5JY	AEI	46A, 50V, 0.06A, 3V	F-47				
CR32UX5JY1	AEI	46A, 50V, 0.04A, 3V	F-47				
CR33M01JY	AEI	50A, 100V, 0.06A, 3V	E-6				 图 E-6
CR33M01JY1	AEI	50A, 100V, 0.04A, 3V	E-6				
CR33M02JY	AEI	50A, 200V, 0.06A, 3V	E-6				
CR33M02JY1	AEI	50A, 200V, 0.04A, 3V	E-6				
CR33M03JY	AEI	50A, 300V, 0.06A, 3V	E-6				
CR33M03JY1	AEI	50A, 300V, 0.04A, 3V	E-6				
CR33M04JY	AEI	50A, 400V, 0.06A, 3V	E-6				
CR33M04JY1	AEI	50A, 400V, 0.04A, 3V	E-6				
CR33M05JY	AEI	50A, 500V, 0.06A, 3V	E-6				
CR33M05JY1	AEI	50A, 500V, 0.04A, 3V	E-6				

器件型号 Element type	厂名 Manufacturers	材料用途参数 Material Purpose Parameter	图号 Figure	国内外相似替换器件型号 Replace of similar type	备注 Notes	外形参考图 Reference shape
CR33M06JY	AEI	50A, 600V, 0.06A, 3V	E-6			 图 E-6
CR33M06JY1	AEI	50A, 600V, 0.04A, 3V	E-6			
CR33M08JY	AEI	50A, 800V, 0.06A, 3V	E-6			
CR33M08JY1	AEI	50A, 800V, 0.04A, 3V	E-6			
CR33M10JY	AEI	50A, 1kV, 0.06A, 3V	E-6			
CR33M10JY1	AEI	50A, 1kV, 0.04A, 3V	E-6			
CR33M11JY	AEI	50A, 1.1kV, 0.06A, 3V	E-6			
CR33M11JY1	AEI	50A, 1.1kV, 0.04A, 3V	E-6			
CR33M12JY	AEI	50A, 1.2kV, 0.06A, 3V	E-6			
CR33M12JY1	AEI	50A, 1.2kV, 0.04A, 3V	E-6			
CR33M13JY	AEI	50A, 1.3kV, 0.06A, 3V	E-6			
CR33M13JY1	AEI	50A, 1.3kV, 0.04A, 3V	E-6			
CR33M14JY	AEI	50A, 1.4kV, 0.04A, 3V	E-6			
CR33M14JY1	AEI	50A, 1.4kV, 0.04A, 3V	E-6			
CR33MX5JY	AEI	50A, 50V, 0.06A, 3V	E-6			
CR33MX5JY1	AEI	50A, 50V, 0.04A, 3V	E-6			
CR33U01JY	AEI	50A, 100V, 0.06A, 3V	F-47			 图 F-47
CR33U01JY1	AEI	50A, 100V, 0.04A, 3V	F-47			
CR33U02JY	AEI	50A, 200V, 0.06A, 3V	F-47			
CR33U02JY1	AEI	50A, 200V, 0.04A, 3V	F-47			
CR33U03JY	AEI	50A, 300V, 0.06A, 3V	F-47			
CR33U03JY1	AEI	50A, 300V, 0.04A, 3V	F-47			
CR33U04JY	AEI	50A, 400V, 0.06A, 3V	F-47			
CR33U04JY1	AEI	50A, 400V, 0.04A, 3V	F-47			
CR33U05JY	AEI	50A, 500V, 0.06A, 3V	F-47			
CR33U05JY1	AEI	50A, 500V, 0.04A, 3V	F-47			
CR33U06JY	AEI	50A, 600V, 0.06A, 3V	F-47			
CR33U06JY1	AEI	50A, 600V, 0.04A, 3V	F-47			
CR33U08JY	AEI	50A, 800V, 0.06A, 3V	F-47			

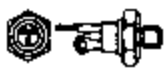
器件型号 Element type	厂名 Manufacturers	材料用途参数 Material Purpose Parameter	图号 Figure	国内外相似替换器作型号 Replace of similar type	备注 Notes	外形参考图 Reference shape
CR33U08JY1	AEI	50A, 800V, 0.04A, 3V	F-47			 图 F-47
CR33U10JY1	AEI	50A, 1kV, 0.04A, 3V	F-47			
CR33U11JY	AEI	50A, 1.1kV, 0.06A, 3V	F-47			
CR33U11JY1	AEI	50A, 1.1kV, 0.04A, 3V	F-47			
CR33U12JY	AEI	50A, 1.2kV, 0.06A, 3V	F-47			
CR33U12JY1	AEI	50A, 1.2kV, 0.04A, 3V	F-47			
CR33U13JY	AEI	50A, 1.3kV, 0.06A, 3V	F-47			
CR33U13JY1	AEI	50A, 1.3kV, 0.04A, 3V	F-47			
CR33UX5JY	AEI	50A, 50V, 0.06A, 3V	F-47			
CR33UX5JY1	AEI	50A, 50V, 0.04A, 3V	F-47			
CR40B4	MIT	40A, 200V, 0.08A, 1.5V	F-27			 图 F-27
CR40B6	MIT	40A, 300V, 0.08A, 1.5V	F-27			
CR40B8	MIT	40A, 400V, 0.08A, 1.5V	F-27			
CR40B10	MIT	40A, 500V, 0.08A, 1.5V	F-27			
CR40B12	MIT	40A, 600V, 0.08A, 1.5V	F-27			
CR40B16	MIT	40A, 800V, 0.08A, 1.5V	F-27			
CR40B20	MIT	40A, 1kV, 0.08A, 1.5V	F-27			
CR45U01JY	AEI	65A, 100V, 0.15A, 3V	F-21			
CR45U01JY1	AEI	65A, 100V, 0.075A, 3V	F-21			
CR45U02JY	AEI	65A, 200V, 0.15A, 3V	F-21			
CR45U02JY1	AEI	65A, 200V, 0.075A, 3V	F-21			
CR45U03JY	AEI	65A, 300V, 0.15A, 3V	F-21			
CR45U03JY1	AEI	65A, 300V, 0.075A, 3V	F-21			
CR45U04JY	AEI	65A, 400V, 0.15A, 3V	F-21			
CR45U04JY1	AEI	65A, 400V, 0.075A, 3V	F-21			
CR45U05JY	AEI	65A, 500V, 0.15A, 3V	F-21			
CR45U05JY1	AEI	65A, 500V, 0.075A, 3V	F-21			



器件型号 Element type	厂名 Manufacturers	材料用途参数 Material Purpose Parameter	图号 Figure	国内外相似替换器件型号 Replace of similar type	备注 Notes	外形参考图 Reference shape
CR45U06JY	AEI	65A, 600V, 0.15A, 3V	F-21			 图 F-21
CR45U06JY1	AEI	65A, 600V, 0.075A, 3V	F-21			
CR45U08JY	AEI	65A, 800V, 0.15A, 3V	F-21			
CR45U08JY1	AEI	65A, 800V, 0.075A, 3V	F-21			
CR45U10JY	AEI	65A, 1kV, 0.15A, 3V	F-21			
CR45U10JY1	AEI	65A, 1kV, 0.075A, 3V	F-21			
CR45U11JY	AEI	65A, 1.1kV, 0.15A, 3V	F-21			
CR45U11JY1	AEI	65A, 1.1kV, 0.075A, 3V	F-21			
CR45U12JY	AEI	65A, 1.2kV, 0.15A, 3V	F-21			
CR45U12JY1	AEI	65A, 1.2kV, 0.075A, 3V	F-21			
CR45U13JY	AEI	65A, 1.3kV, 0.15A, 3V	F-21			
CR45U13JY1	AEI	65A, 1.3kV, 0.075A, 3V	F-21			
CR45U14JY	AEI	65A, 1.4kV, 0.15A, 1.5V	F-21			
CR45U14JY1	AEI	65A, 1.4kV, 0.075A, 1.5V	F-21			
CR45UX5JY	AEI	65A, 50V, 0.15A, 3V	F-21			
CR45UX5JY1	AEI	65A, 50V, 0.075A, 3V	F-21			
CR46U01JY	AEI	80A, 100V, 0.15A, 3V	F-21			
CR46U01JY1	AEI	80A, 100V, 0.075A, 3V	F-21			
CR46U02JY	AEI	80A, 200V, 0.15A, 3V	F-21			
CR46U02JY1	AEI	80A, 200V, 0.075A, 3V	F-21			
CR46U03JY	AEI	80A, 300V, 0.15A, 3V	F-21			
CR46U03JY1	AEI	80A, 300V, 0.075A, 3V	F-21			
CR46U04JY	AEI	80A, 400V, 0.15A, 3V	F-21			
CR46U04JY1	AEI	80A, 400V, 0.075A, 3V	F-21			
CR46U05JY	AEI	80A, 500V, 0.15A, 3V	F-21			
CR46U05JY1	AEI	80A, 500V, 0.075A, 3V	F-21			
CR46U06JY	AEI	80A, 600V, 0.15A, 3V	F-21			
CR46U06JY1	AEI	80A, 600V, 0.075A, 3V	F-21			
CR46UX5JY	AEI	80A, 50V, 0.15A, 3V	F-21			

器件型号 Element type	厂名 Manufacturers	材料用途参数 Material Purpose Parameter	图号 Figure	国内外相似替换器件型号 Replace of similar type	备注 Notes	外形参考图 Reference shape
CR46UX5JY1	AEI	80A, 50V, 0.075A, 3V	F-21			 图 F-21
CR50-01	ORI	50A, 100V, 0.08A, 3V	F-71			
CR50-02	ORI	50A, 200V, 0.08A, 3V	F-71			
CR50-04	ORI	50A, 400V, 0.08A, 3V	F-71			
CR50-06	ORI	50A, 600V, 0.08A, 3V	F-71			
CR50-08	ORI	50A, 800V, 0.08A, 3V	F-71			
CR50-10	ORI	50A, 1kV, 0.08A, 3V	F-71			
CR51M01JY	AEI	110A, 100V, 0.15A, 3V	E-22			
CR51M01JY1	AEI	70A, 100V, 0.075A, 3V	E-22			
CR51M02JY	AEI	110A, 200V, 0.15A, 3V	E-22			
CR51M02JY1	AEI	70A, 200V, 0.075A, 3V	E-22			
CR51M03JY	AEI	110A, 300V, 0.15A, 3V	E-22			
CR51M03JY1	AEI	70A, 300V, 0.075A, 3V	E-22			
CR51M04JY	AEI	110A, 400V, 0.15A, 3V	E-22			
CR51M04JY1	AEI	70A, 400V, 0.075A, 3V	E-22			
CR51M05JY	AEI	110A, 500V, 0.15A, 3V	E-22			
CR51M05JY1	AEI	70A, 500V, 0.075A, 3V	E-22			
CR51M06JY	AEI	110A, 600V, 0.15A, 3V	E-22			
CR51M06JY1	AEI	70A, 600V, 0.075A, 3V	E-22			
CR51M08JY	AEI	110A, 800V, 0.15A, 3V	E-22			
CR51M08JY1	AEI	70A, 800V, 0.075A, 3V	E-22			
CR51M10JY	AEI	110A, 1kV, 0.15A, 3V	E-22			
CR51M10JY1	AEI	70A, 1kV, 0.075A, 3V	E-22			
CR51M11JY	AEI	110A, 1.1kV, 0.15A, 3V	E-22			
CR51M11JY1	AEI	70A, 1.1kV, 0.075A, 3V	E-22			
CR51M12JY	AEI	110A, 1.2kV, 0.15A, 3V	E-22			
CR51M12JY1	AEI	70A, 1.2kV, 0.075A, 3V	E-22			
CR51M13JY	AEI	110A, 1.3kV, 0.15A, 3V	E-22			



器件型号 Element type	厂名 Manufacturers	材料用途参数 Material Purpose Parameter	图号 Figure	国内外相似替换器件型号 Replace of similar type	备注 Notes	外形参考图 Reference shape
CR51M13JY1	AEI	70A, 1.3kV, 0.075A, 3V	E-22			 图 E-22
CR51M14JY1	AEI	70A, 1.4kV, 0.075A, 3V	E-22			
CR51U01JY	AEI	70A, 100V, 0.15A, 3V	E-22			
CR51U01JY1	AEI	70A, 100V, 0.075A, 3V	F-22			
CR51U02JY	AEI	70A, 200V, 0.15A, 3V	E-22			
CR51U02JY1	AEI	70A, 200V, 0.075A, 3V	E-22			
CR51U03JY	AEI	70A, 300V, 0.15A, 3V	E-22			
CR51U03JY1	AEI	70A, 300V, 0.075A, 3V	E-22			
CR51U04JY	AEI	70A, 400V, 0.15A, 3V	E-22			
CR51U04JY1	AEI	70A, 400V, 0.075A, 3V	E-22			
CR51U05JY	AEI	70A, 500V, 0.15A, 3V	E-22			
CR51U05JY1	AEI	70A, 500V, 0.075A, 3V	E-22			
CR51U06JY	AEI	70A, 600V, 0.15A, 3V	E-22			
CR51U06JY1	AEI	70A, 600V, 0.075A, 3V	E-22			
CR51U08JY	AEI	70A, 800V, 0.15A, 3V	E-22			
CR51U08JY1	AEI	70A, 800V, 0.075A, 3V	E-22			
CR51U10JY	AEI	70A, 1kV, 0.15A, 3V	E-22			
CR51U10JY1	AEI	70A, 1kV, 0.075A, 3V	E-22			
CR51U11JY	AEI	70A, 1.1kV, 0.15A, 3V	E-22			
CR51U11JY1	AEI	70A, 1.1kV, 0.075A, 3V	E-22			
CR51U12JY	AEI	70A, 1.2kV, 0.15A, 3V	E-22			
CR51U12JY1	AEI	70A, 1.2kV, 0.075A, 3V	E-22			
CR51U13JY	AEI	70A, 1.3kV, 0.15A, 3V	E-22			
CR51U13JY1	AEI	70A, 1.3kV, 0.075A, 3V	E-22			
CR51U14JY	AEI	70A, 1.4kV, 0.15A, 3V	E-22			
CR51U14JY1	AEI	70A, 1.4kV, 0.075A, 3V	E-22			
CR51UX5JY	AEI	70A, 50V, 0.15A, 3V	E-22			
CR51UX5JY1	AEI	70A, 50V, 0.075A, 3V	E-22			

器件型号 Element type	厂名 Manufacturers	材料用途参数 Material Purpose Parameter	图号 Figure	国内外相似替换器件型号 Replace o* similar type	备注 Notes	外形参考图 Reference shape
CR71M01JY	AEI	110A, 100V, 0.15A, 3V	E-22			 图 E-22
CR71M01JY1	AEI	92A, 100V, 0.075A, 3V	E-22			
CR71M02JY	AEI	110A, 200V, 0.15A, 3V	E-22			
CR71M02JY1	AEI	92A, 200V, 0.075A, 3V	E-22			
CR71M03JY	AEI	110A, 300V, 0.15A, 3V	E-22			
CR71M03JY1	AEI	92A, 300V, 0.075A, 3V	E-22			
CR71M04JY	AEI	110A, 400V, 0.15A, 3V	E-22			
CR71M04JY1	AEI	92A, 400V, 0.075A, 3V	E-22			
CR71M05JY	AEI	110A, 500V, 0.15A, 3V	E-22			
CR71M05JY1	AEI	92A, 500V, 0.075A, 3V	E-22			
CR71M06JY	AEI	110A, 600V, 0.15A, 3V	E-22			
CR71M06JY1	AEI	92A, 600V, 0.075A, 3V	E-22			
CR71M08JY	AEI	110A, 800V, 0.15A, 3V	E-22			
CR71M08JY1	AEI	92A, 800V, 0.075A, 3V	E-22			
CR71M10JY	AEI	110A, 1kV, 0.15A, 3V	E-22			
CR71M10JY1	AEI	92A, 1kV, 0.075A, 3V	E-22			
CR71M11JY	AEI	110A, 1.1kV, 0.15A, 3V	E-22			
CR71M11JY1	AEI	92A, 1.1kV, 0.075A, 3V	E-22			
CR71M12JY	AEI	110A, 1.2kV, 0.15A, 3V	E-22			
CR71M12JY1	AEI	92A, 1.2kV, 0.075A, 3V	E-22			
CR71M13JY	AEI	110A, 1.3kV, 0.15A, 3V	E-22			
CR71M13JY1	AEI	92A, 1.3kV, 0.075A, 3V	E-22			
CR71MX5JY	AEI	110A, 1.5kV, 0.15A, 3V	E-22			
CR71MX5JY1	AEI	92A, 50V, 0.075A, 3V	E-22			
CR71U01JY	AEI	92A, 100V, 0.15A, 3V	E-22			
CR71U01JY1	AEI	92A, 100V, 0.075A, 3V	E-22			
CR71U02JY	AEI	92A, 200V, 0.15A, 3V	E-22			
CR71U02JY1	AEI	92A, 200V, 0.075A, 3V	E-22			
CR71U03JY	AEI	92A, 300V, 0.15A, 3V	E-22			

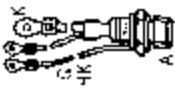

器件型号 Element type	厂名 Manufacturers	材料用途参数 Material Purpose Parameter	图号 Figure	国内外相似替换器件型号 Replace of similar type	备注 Notes	外形参考图 Reference shape
CR71U03JY1	AEI	92A, 300V, 0.075A, 3V	E-22			 图 E-22
CR71U04JY	AEI	92A, 400V, 0.15A, 3V	E-22			
CR71U04JY1	AEI	92A, 400V, 0.075A, 3V	E-22			
CR71U05JY	AEI	92A, 500V, 0.15A, 3V	E-22			
CR71U05JY1	AEI	92A, 500V, 0.075A, 3V	E-22			
CR71U06JY	AEI	92A, 600V, 0.15A, 3V	E-22			
CR71U06JY1	AEI	92A, 600V, 0.075A, 3V	E-22			
CR71U08JY	AEI	92A, 800V, 0.15A, 3V	E-22			
CR71U08JY1	AEI	92A, 800V, 0.075A, 3V	E-22			
CR71U10JY	AEI	92A, 1kV, 0.15A, 3V	E-22			
CR71U11JY	AEI	92A, 1.1kV, 0.15A, 3V	E-22			
CR71U11JY1	AEI	92A, 1.1kV, 0.075A, 3V	E-22			
CR71U12JY	AEI	92A, 1.2kV, 0.15A, 3V	E-22			
CR71U12JY1	AEI	92A, 1.2kV, 0.075A, 3V	E-22			
CR71U13JY	AEI	92A, 1.3kV, 0.15A, 3V	E-22			
CR71U13JY1	AEI	92A, 1.3kV, 0.075A, 3V	E-22			
CR71UX5JY	AEI	92A, 50V, 0.15A, 3V	E-22			
CR71UX5JY1	AEI	92A, 50V, 0.075A, 3V	E-22			
CR72U01JY	AEI	70A, 100V, 0.15A, 3V	E-22			
CR72U01JY1	AEI	70A, 100V, 0.075A, 3V	E-22			
CR72U02JY	AEI	70A, 200V, 0.15A, 3V	E-22			
CR72U02JY1	AEI	70A, 200V, 0.075A, 3V	E-22			
CR72U03JY	AEI	70A, 300V, 0.15A, 3V	E-22			
CR72U03JY1	AEI	70A, 300V, 0.075A, 3V	E-22			
CR72U04JY	AEI	70A, 400V, 0.15A, 3V	E-22			
CR72U04JY1	AEI	70A, 400V, 0.075A, 3V	E-22			
CR72U05JY	AEI	70A, 500V, 0.15A, 3V	E-22			
CR72U05JY1	AEI	70A, 500V, 0.075A, 3V	E-22			
CR72U06JY	AEI	70A, 600V, 0.15A, 3V	E-22			

器件型号 Element type	厂名 Manufacturers	材料用途参数 Material Purpose Parameter	图号 Figure	国内外相似替换器件型号 Replace of similar type	备注 Notes	外形参考图 Reference shape
CR72U06JY1	AEI	70A, 600V, 0.075A, 3V	E-22			
CR72UX5JY	AEI	70A, 50V, 0.15A, 3V	E-22			
CR72UX5JY1	AEI	70A, 50V, 0.075A, 3V	E-22			
CR81F01JY	AEI	157A, 100V, 0.15A, 3V	E-16			
CR81F02JY	AEI	157A, 200V, 0.15A, 3V	E-16			
CR81F03JY	AEI	157A, 300V, 0.15A, 3V	E-16			
CR81F04JY	AEI	157A, 400V, 0.15A, 3V	E-16			
CR81F05JY	AEI	157A, 500V, 0.15A, 3V	E-16			
CR81F06JY	AEI	157A, 600V, 0.15A, 3V	E-16			
CR81F08JY	AEI	157A, 800V, 0.15A, 3V	E-16			
CR81F10JY	AEI	157A, 1kV, 0.15A, 3V	E-16			
CR81F11JY	AEI	157A, 1.1kV, 0.15A, 3V	E-16			
CR81F12JY	AEI	157A, 1.2kV, 0.15A, 3V	E-16			
CR81F13JY	AEI	157A, 1.3kV, 0.15A, 3V	E-16			
CR81FX5JY	AEI	157A, 1.5kV, 0.15A, 3V	E-16			
CR81M01JY	AEI	157A, 100V, 0.15A, 3V	E-22			
CR81M02JY	AEI	157A, 200V, 0.15A, 3V	E-22			
CR81M02JY1	AEI	100A, 200V, 0.075A, 3V	E-22			
CR81M03JY	AEI	157A, 300V, 0.15A, 3V	E-22			
CR81M03JY1	AEI	100A, 300V, 0.075A, 3V	E-22			
CR81M04JY	AEI	157A, 400V, 0.15A, 3V	E-22			
CR81M04JY1	AEI	100A, 400V, 0.075A, 3V	E-22			
CR81M05JY	AEI	157A, 500V, 0.15A, 3V	E-22			
CR81M05JY1	AEI	100A, 500V, 0.075A, 3V	E-22			
CR81M06JY	AEI	157A, 600V, 0.15A, 3V	E-22			
CR81M06JY1	AEI	100A, 600V, 0.075A, 3V	E-22			
CR81M08JY	AEI	157A, 800V, 0.15A, 3V	E-22			
CR81M08JY1	AEI	100A, 800V, 0.075A, 3V	E-22			



图 E-22







图 E-16

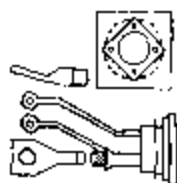

器件型号 Element type	厂名 Manufacturers	材料用途参数 Material Purpose Parameter	图号 Figure	国内外相似替换器件型号 Replace of similar type	备注 Notes	外形参考图 Reference shape
CR81M10JY	AEI	157A, 1kV, 0.15A, 3V	E-22			 图 E-22
CR81M10JY1	AEI	100A, 1kV, 0.075A, 3V	E-22			
CR81M11JY	AEI	157A, 1.1kV, 0.15A, 3V	E-22			
CR81M11JY1	AEI	100A, 1.1kV, 0.075A, 3V	E-22			
CR81M12JY	AEI	157A, 1.2kV, 0.15A, 3V	E-22			
CR81M12JY1	AEI	100A, 1.2kV, 0.075A, 3V	E-22			
CR81M13JY	AEI	157A, 1.3kV, 0.15A, 3V	E-22			
CR81M13JY1	AEI	100A, 1.3kV, 0.075A, 3V	E-22			
CR81MX5JY	AEI	157A, 50V, 0.15A, 3V	E-22			
CR81MX5JY1	AEI	100A, 50V, 0.075A, 3V	E-22			
CR81U01JY	AEI	100A, 100V, 0.15A, 3V	E-22			
CR81U01JY1	AEI	100A, 100V, 0.075A, 3V	E-22			
CR81U02JY	AEI	100A, 200V, 0.15A, 3V	E-22			
CR81U02JY1	AEI	100A, 200V, 0.075A, 3V	E-22			
CR81U03JY	AEI	100A, 300V, 0.15A, 3V	E-22			
CR81U03JY1	AEI	100A, 300V, 0.075A, 3V	E-22			
CR81U04JY	AEI	100A, 400V, 0.15A, 3V	E-22			
CR81U04JY1	AEI	100A, 400V, 0.075A, 3V	E-22			
CR81U05JY	AEI	100A, 500V, 0.15A, 3V	E-22			
CR81U05JY1	AEI	100A, 500V, 0.075A, 3V	E-22			
CR81U06JY	AEI	100A, 600V, 0.15A, 3V	E-22			
CR81U06JY1	AEI	100A, 600V, 0.075A, 3V	E-22			
CR81U08JY	AEI	100A, 800V, 0.15A, 3V	E-22			
CR81U08JY1	AEI	100A, 800V, 0.075A, 3V	E-22			
CR81U10JY	AEI	100A, 1kV, 0.15A, 3V	E-22			
CR81U10JY1	AEI	100A, 1kV, 0.075A, 3V	E-22			
CR81U11JY	AEI	100A, 1.1kV, 0.15A, 3V	E-22			
CR81U11JY1	AEI	100A, 1.1kV, 0.075A, 3V	E-22			
CR81U12JY	AEI	100A, 1.2kV, 0.15A, 3V	E-22			

器件型号 Element type	厂名 Manufacturers	材料用途参数 Material Purpose Parameter	图号 Figure	国内外相似替换器件型号 Replace of similar type	备注 Notes	外形参考图 Reference shape
CR81U12JY1	AEI	100A, 1.2kV, 0.075A, 3V	E-22			 图 E-22
CR81U13JY	AEI	100A, 1.3kV, 0.15A, 3V	E-22			
CR81U13JY1	AEI	100A, 1.3kV, 0.075A, 3V	E-22			
CR81UX5JY	AEI	100A, 50V, 0.15A, 3V	E-22			
CH81UX5JY1	AEI	100A, 50V, 0.075A, 3V	E-22			
CR100-01	ORI	100A, 100V, 0.1A, 3V	F-71			
CR100-02	ORI	100A, 200V, 0.1A, 3V	F-71			
CR100-04	ORI	100A, 400V, 0.1A, 3V	F-71			
CR100-06	ORI	100A, 600V, 0.1A, 3V	F-71			
CR100-08	ORI	100A, 800V, 0.1A, 3V	F-71			
CR100-10	ORI	100A, 1kV, 0.1A, 3V	F-71			
CR100AL4	MIT	100A, 200V, 0.1A, 1.5V	E-22			
CR100AL6	MIT	100A, 300V, 0.1A, 1.5V	E-22			
CR100AL8	MIT	100A, 400V, 0.1A, 1.5V	E-22			
CR100AL10	MIT	100A, 500V, 0.1A, 1.5V	E-22			
CR100AL12	MIT	100A, 600V, 0.1A, 1.5V	E-22			
CR100AL16	MIT	100A, 800V, 0.1A, 1.5V	E-22			
CR100AL20	MIT	100A, 1kV, 0.1A, 1.5V	E-22			
CR100AL24	MIT	100A, 1.2kV, 0.1A, 1.5V	E-22			
CR100AX4	MIT	100A, 200V, 0.1A, 2V	E-22			 图 F-71
CR100AX6	MIT	100A, 300V, 0.1A, 2V	E-22			
CR100AX8	MIT	100A, 400V, 0.1A, 2V	E-22			
CR100AX10	MIT	100A, 500V, 0.1A, 2V	E-22			
CR100AX12	MIT	100A, 600V, 0.1A, 2V	E-22			
CR100AX16	MIT	100A, 800V, 0.1A, 2V	E-22			
CR100AX20	MIT	100A, 1kV, 0.1A, 2V	E-22			
CR100AY4	MIT	100A, 200V, 0.1A, 2V	E-22			
CH100AY6	MIT	100A, 300V, 0.1A, 2V	E-22			



器件型号 Element type	厂名 Manufacturers	材料用途参数 Material Purpose Parameter	图号 Figure	国内外相似替换器件型号 Replace of similar type	备注 Notes	外形参考图 Reference shape
CR100AY8	MIT	SCR-H 100A, 400V, 0.1A, 2V	E-22			
CR100AY10	MIT	SCR-H 100A, 500V, 0.1A, 2V	E-22			
CR100AY12	MIT	SCR-H 100A, 600V, 0.1A, 2V	E-22			
CR100AY16	MIT	SCR-H 100A, 800V, 0.1A, 2V	E-22			
CR100AY20	SCR-H	100A, 1kV	E-22			
CR100DX24	MIT	100A, 1.2kV, 0.1A, 2V	E-22			
CR100DX32	MIT	100A, 1.6kV, 0.1A, 2V	E-22			
CR100DX34	MIT	100A, 1.7kV, 0.1A, 2V	E-22			
CR100DX36	MIT	100A, 1.8kV, 0.1A, 2V	E-22			
CR100FT01	ORI	100A, 100V, 0.1A, 3V	F-71			
CR100FT02	ORI	100A, 200V, 0.1A, 3V	F-71			
CR100FT04	ORI	100A, 400V, 0.1A, 3V	F-71			
CR100FT06	ORI	100A, 600V, 0.1A, 3V	F-71			
CR100FT08	ORI	100A, 800V, 0.1A, 3V	F-71			
CR100FT10	ORI	100A, 1kV, 0.1A, 3V	F-71			
CR101F01JY	AEI	180A, 100V, 0.15A, 3V	E-16			
CR101F02JY	AEI	180A, 200V, 0.15A, 3V	E-16			
CR101F03JY	AEI	180A, 300V, 0.15A, 3V	E-16			
CR101F04JY	AEI	180A, 400V, 0.15A, 3V	F-16			
CR101F05JY	AEI	180A, 500V, 0.15A, 3V	E-16			
CR101F08JY	AEI	180A, 800V, 0.15A, 3V	E-16			
CR101F10JY	AEI	180A, 1kV, 0.15A, 3V	E-16			
CR101F11JY	AEI	180A, 1.1kV, 0.15A, 3V	E-16			
CR101F13JY	AEI	180A, 1.3kV, 0.15A, 3V	E-16			
CR101FX5JY	AEI	180A, 50V, 0.15A, 3V	E-16			
CR101M01JY	AEI	135A, 100V, 0.15A, 3V	E-22			
CR101M01JY1	AEI	135A, 100V, 0.075A, 3V	E-22			



图 E-22



图 F-71



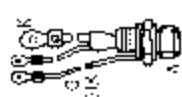

图 E-16

器件型号 Element type	厂名 Manufacturers	材料用途参数 Material Purpose Parameter	图号 Figure	国内外相似替换器件型号 Replace of similar type	备注 Notes	外形参考图 Reference shape
CR101M02JY	AEI	135A, 200V, 0.15A, 3V	E-22			 E-22
CR101M02JY1	AEI	135A, 200V, 0.075A, 3V	E-22			
CR101M03JY	AEI	135A, 300V, 0.15A, 3V	E-22			
CR101M03JY1	AEI	135A, 300V, 0.075A, 3V	E-22			
CR101M04JY	AEI	135A, 400V, 0.15A, 3V	E-22			
CR101M04JY1	AEI	135A, 400V, 0.075A, 3V	E-22			
CR101M05JY	AEI	135A, 500V, 0.15A, 3V	E-22			
CR101M05JY1	AEI	135A, 500V, 0.075A, 3V	E-22			
CR101M06JY	AEI	135A, 600V, 0.15A, 3V	E-22			
CR101M06JY1	AEI	135A, 600V, 0.075A, 3V	E-22			
CR101M08JY	AEI	135A, 800V, 0.15A, 3V	E-22			
CR101M08JY1	AEI	135A, 800V, 0.075A, 3V	E-22			
CR101M10JY	AEI	135A, 1kV, 0.15A, 3V	E-22			
CR101M10JY1	AEI	135A, 1kV, 0.075A, 3V	E-22			
CR101M11JY	AEI	135A, 1.1kV, 0.15A, 3V	E-22			
CR101M11JY1	AEI	135A, 1.1kV, 0.075A, 3V	E-22			
CR101M12JY	AEI	135A, 1.2kV, 0.15A, 3V	E-22			
CR101M12JY1	AEI	135A, 1.2kV, 0.075A, 3V	E-22			
CR101M13JY	AEI	135A, 1.3kV, 0.15A, 3V	E-22			
CR101M13JY1	AEI	135A, 1.3kV, 0.075A, 3V	E-22			
CR101MX5JY	AEI	135A, 50V, 0.15A, 3V	E-22			
CR101MX5JY1	AEI	135A, 50V, 0.075A, 3V	E-22			
CR101U01JY	AEI	135A, 100V, 0.15A, 3V	E-22			
CR101U01JY1	AEI	135A, 100V, 0.075A, 3V	E-22			
CR101U02JY	AEI	135A, 200V, 0.15A, 3V	E-22			
CR101U02JY1	AEI	135A, 200V, 0.075A, 3V	E-22			
CR101U03JY	AEI	135A, 300V, 0.15A, 3V	E-22			
CR101U03JY1	AEI	135A, 300V, 0.075A, 3V	E-22			
CR101U04JY	AEI	135A, 400V, 0.15A, 3V	E-22			

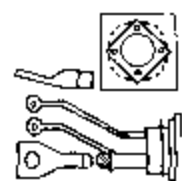

器件型号 Element type	厂名 Manufacturers	材料用途参数 Material Purpose Parameter	图号 Figure	国内外相似替换器件型号 Replace of similar type	备注 Notes	外形参考图 Reference shape	
CR101U04JY1	AEI	135A, 400V, 0.075A, 3V	E-22			 图 E-22	
CR101U05JY	AEI	135A, 500V, 0.15A, 3V	E-22				
CR101U05JY1	AEI	135A, 500V, 0.075A, 3V	E-22				
CR101U06JY	AEI	135A, 600V, 0.15A, 3V	E-22				
CR101U06JY1	AEI	135A, 600V, 0.075A, 3V	E-22				
CR101U08JY	AEI	135A, 800V, 0.15A, 3V	E-22				
CR101U08JY1	AEI	135A, 800V, 0.075A, 3V	E-22				
CR101U10JY	AEI	135A, 1kV, 0.15A, 3V	E-22				
CR101U10JY1	AEI	135A, 1kV, 0.075A, 3V	E-22				
CR101U11JY	AEI	135A, 1.1kV, 0.15A, 3V	E-22				
CR101U11JY1	AEI	135A, 1.1kV, 0.075A, 3V	E-22				
CR101U12JY	AEI	135A, 1.2kV, 0.15A, 3V	E-22				
CR101U12JY1	AEI	135A, 1.2kV, 0.075A, 3V	E-22				
CR101U13JY	AEI	135A, 1.3kV, 0.15A, 3V	E-22				
CR101U13JY1	AEI	135A, 1.3kV, 0.075A, 3V	E-22				
CR101UX5JY	AEI	135A, 50V, 0.15A, 3V	E-22				
CR101UX5JY1	AEI	135A, 50V, 0.075A, 3V	E-22				
CR111F01JY	AEI	200A, 100V, 0.15A, 3V	E-16				 图 E-16
CR111F02JY	AEI	200A, 200V, 0.15A, 3V	E-16				
CR111F03JY	AEI	200A, 300V, 0.15A, 3V	E-16				
CR111F04JY	AEI	200A, 400V, 0.15A, 3V	E-16				
CR111F05JY	AEI	200A, 500V, 0.15A, 3V	E-16				
CR111F06JY	AEI	200A, 600V, 0.15A, 3V	E-16				
CR111F08JY	AEI	200A, 800V, 0.15A, 3V	E-16				
CR111F11JY	AEI	200A, 1.1kV, 0.15A, 3V	E-16				
CR111F10JY	AEI	200A, 1kV, 0.15A, 3V	E-16				
CR111F12JY	AEI	200A, 1.2kV, 0.15A, 3V	E-16				
CR111F14JY	AEI	200A, 1.4kV, 0.15A, 3V	E-16				

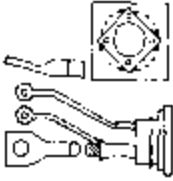
器件型号 Element type	厂名 Manufacturers	材料用途参数 Material Purpose Parameter	图号 Figure	国内外相似替换器件型号 Replace of similar type	备注 Notes	外形参考图 Reference shape
CR111FX5JY	AEI	200A, 50V, 0.15A, 3V	E-16			
CR111M01JY	AEI	140A, 100V, 0.15A, 3V	E-22			
CR111M01JY1	AEI	140A, 100V, 0.075A, 3V	E-22			
CR111M02JY	AEI	140A, 200V, 0.15A, 3V	E-22			
CR111M02JY1	AEI	140A, 200V, 0.075A, 3V	E-22			
CR111M03JY	AEI	140A, 300V, 0.15A, 3V	E-22			
CR111M03JY1	AEI	140A, 300V, 0.075A, 3V	E-22			
CR111M04JY	AEI	140A, 400V, 0.15A, 3V	E-22			
CR111M04JY1	AEI	140A, 400V, 0.075A, 3V	E-22			
CR111M05JY	AEI	140A, 500V, 0.15A, 3V	E-22			
CR111M05JY1	AEI	140A, 500V, 0.075A, 3V	E-22			
CR111M06JY	AEI	140A, 600V, 0.15A, 3V	E-22			
CR111M06JY1	AEI	140A, 600V, 0.075A, 3V	E-22			
CR111M08JY	AEI	140A, 800V, 0.15A, 3V	E-22			
CR111M08JY1	AEI	140A, 800V, 0.075A, 3V	E-22			
CR111M10JY	AEI	140A, 1kV, 0.15A, 3V	E-22			
CR111M10JY1	AEI	140A, 1kV, 0.075A, 3V	E-22			
CR111M11JY	AEI	140A, 1.1kV, 0.15A, 3V	E-22			
CR111M11JY1	AEI	140A, 1.1kV, 0.075A, 3V	E-22			
CR111M12JY	AEI	140A, 1.2kV, 0.15A, 3V	E-22			
CR111M12JY1	AEI	140A, 1.2kV, 0.075A, 3V	E-22			
CR111M13JY	AEI	140A, 1.3kV, 0.15A, 3V	E-22			
CR111M13JY1	AEI	140A, 1.3kV, 0.075A, 3V	E-22			
CR111MX5JY	AEI	140A, 50V, 0.15A, 3V	E-22			
CR111MX5JY1	AEI	140A, 50V, 0.075A, 3V	E-22			
CR111U01JY	AEI	140A, 100V, 0.15A, 3V	E-22			
CR111U01JY1	AEI	140A, 0.075A, 3V	E-22			
CR111U02JY	AEI	140A, 0.15A, 3V	E-22			
CR111U02JY1	AEI	140A, 0.075A, 3V	E-22			

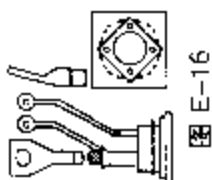

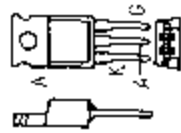
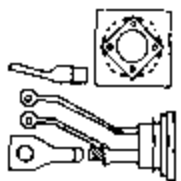

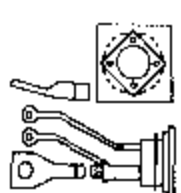
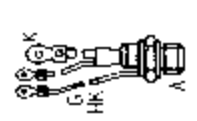
器件型号 Element type	厂名 Manufacturers	材料用途参数 Material Purpose Parameter	图号 Figure	国内外相似替换器件型号 Replace of similar type	备注 Notes	外形参考图 Reference shape
CR111U03JY	AEI	140A, 0.15A, 3V	E-22			 图 E-22
CR111U03JY1	AEI	140A, 0.075A, 3V	E-22			
CR111U04JY	AEI	140A, 0.15A, 3V	E-22			
CR111U04JY1	AEI	140A, 0.075A, 3V	E-22			
CR111U05JY	AEI	140A, 0.15A, 3V	E-22			
CR111U06JY	AEI	140A, 0.15A, 3V	E-22			
CR111U06JY1	AEI	140A, 0.075A, 3V	E-22			
CR111U08JY	AEI	140A, 0.15A, 3V	E-22			
CR111U08JY1	AEI	140A, 0.075A, 3V	E-22			
CR111U10JY	AEI	140A, 0.15A, 3V	E-22			
CR111U10JY1	AEI	140A, 0.075A, 3V	E-22			
CR111U11JY	AEI	140A, 0.15A, 3V	E-22			
CR111U11JY1	AEI	140A, 0.075A, 3V	E-22			
CR111U12JY	AEI	140A, 0.15A, 3V	E-22			
CR111U12JY1	AEI	140A, 0.075A, 3V	E-22			
CR111U13JY	AEI	140A, 1.3KV, 0.15A, 3V	E-22			
CR111U13JY1	AEI	140A, 0.075A, 3V	E-22			
CR111U14JY	AEI	140A, 0.15A, 3V	E-22			
CR111U14JY1	AEI	140A, 0.075A, 3V	E-22			
CR111UX5JY	AEI	140A, 0.15A, 3V	E-22			 图 B-91
CR111UX5JY1	AEI	140A, 50V, 0.075A, 3V	E-22			 图 E-16
CR0121A	AGS	8A, 100V, 0.025A, 1.5V	B-91			
CR0121B	AGS	8A, 200V, 0.025A, 1.5V	B-91			
CR0121D	AGS	8A, 400V, 0.025A, 1.5V	B-91			
CR0121M	AGS	8A, 600V, 0.025A, 1.5V	B-91			
CR0121N	AGS	8A, 800V, 0.025A, 1.5V	B-91			
CR121F01JY	AEI	210A, 100V, 0.15A, 3V	E-16			

器件型号 Element type	厂名 Manufacturers	材料用途参数 Material Purpose Parameter	图号 Figure	国内外相似替换器型号 Replace of similar type	备注 Notes	外形参考图 Reference shape	
CR121F02JY	AEI	210A, 200V, 0.15A, 3V	E-16			 <p>图 E-16</p>	
CR121F03JY	AEI	210A, 300V, 0.15A, 3V	E-16				
CR121F04JY	AEI	210A, 400V, 0.15A, 3V	E-16				
CR121F05JY	AEI	210A, 500V, 0.15A, 3V	E-16				
CR121F06JY	AEI	210A, 600V, 0.15A, 3V	E-16				
CR121F08JY	AEI	210A, 800V, 0.15A, 3V	E-16				
CR121F10JY	AEI	210A, 1KV, 0.15A, 3V	E-16				
CR121F11JY	AEI	210A, 1.1KV, 0.15A, 3V	E-16				
CR121F12JY	AEI	210A, 1.2KV, 0.15A, 3V	E-16				
CR121F13JY	AEI	210A, 1.3KV, 0.15A, 1.5V	E-16				
CR121F14JY	AEI	210A, 1.4KV, 0.15A, 3V	E-16				
CR121FX5JY	AEI	210A, 50V, 0.15A, 3V	E-16				
CR121M01JY	AEI	146A, 100V, 0.15A, 3V	E-22				 <p>图 E-22</p>
CR121M01JY1	AEI	146A, 100V, 0.075A, 3V	E-22				
CR121M02JY	AEI	146A, 200V, 0.15A, 3V	E-22				
CR121M02JY1	AEI	146A, 200V, 0.075A, 3V	E-22				
CR121M03JY	AEI	146A, 300V, 0.15A, 3V	E-22				
CR121M03JY1	AEI	146A, 300V, 0.075A, 3V	E-22				
CR121M04JY	AEI	146A, 400V, 0.15A, 3V	E-22				
CR121M04JY1	AEI	146A, 400V, 0.075A, 3V	E-22				
CR121M05JY	AEI	146A, 500V, 0.15A, 3V	E-22				
CR121M05JY1	AEI	146A, 500V, 0.075A, 3V	E-22				
CR121M06JY	AEI	146A, 600V, 0.15A, 3V	E-22				
CR121M06JY1	AEI	146A, 600V, 0.075A, 3V	E-22				
CR121M08JY	AEI	146A, 800V, 0.15A, 3V	E-22				
CR121M08JY1	AEI	146A, 800V, 0.075A, 3V	E-22				
CR121M10JY	AEI	146A, 1KV, 0.15A, 3V	E-22				
CR121M10JY1	AEI	146A, 1KV, 0.075A, 3V	E-22				
CR121M11JY	AEI	146A, 1.1KV, 0.15A, 3V	E-22				

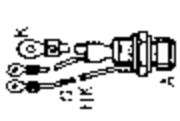

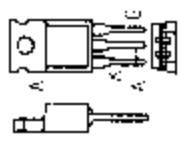
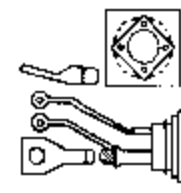
器件型号 Element type	厂名 Manufacturers	材料用途参数 Material Purpose Parameter	图号 Figure	国内外相似替换器件型号 Replace of similar type	备注 Notes	外形参考图 Reference shape
CR121M11JY1	AEI	146A, 1.1kV, 0.075A, 3V	E-22			 图 E-22
CR121M12JY	AEI	146A, 1.2kV, 0.15A, 3V	E-22			
CR121M12JY1	AEI	146A, 1.2kV, 0.075A, 3V	E-22			
CR121MX5JY	AEI	146A, 50V, 0.15A, 3V	E-22			
CR121MX5JY1	AEI	146A, 50V, 0.075A, 3V	E-22			
CR121U01JY	AEI	146A, 100V, 0.15A, 3V	E-22			
CR121U01JY1	AEI	146A, 100V, 0.075A, 3V	E-22			
CR121U02JY	AEI	146A, 200V, 0.15A, 3V	E-22			
CR121U02JY1	AEI	146A, 200V, 0.075A, 3V	E-22			
CR121U03JY	AEI	146A, 300V, 0.15A, 3V	E-22			
CR121U03JY1	AEI	146A, 300V, 0.075A, 3V	E-22			
CR121U04JY	AEI	146A, 400V, 0.15A, 3V	E-22			
CR121U04JY1	AEI	146A, 400V, 0.075A, 3V	E-22			
CR121U05JY	AEI	146A, 500V, 0.15A, 3V	E-22			
CR121U05JY1	AEI	146A, 500V, 0.075A, 3V	E-22			
CR121U06JY	AEI	146A, 600V, 0.15A, 3V	E-22			
CR121U06JY1	AEI	146A, 600V, 0.075A, 3V	E-22			
CR121U08JY	AEI	146A, 800V, 0.15A, 3V	E-22			
CR121U08JY1	AEI	146A, 800V, 0.075A, 3V	E-22			
CR121U10JY	AEI	146A, 1kV, 0.15A, 3V	E-22			
CR121U10JY1	AEI	146A, 1kV, 0.075A, 3V	E-22			
CR121U11JY	AEI	146A, 1.1kV, 0.15A, 3V	E-22			
CR121U11JY1	AEI	146A, 1.1kV, 0.075A, 3V	E-22			
CR121U12JY	AEI	146A, 1.2kV, 0.15A, 3V	E-22			
CR121U12JY1	AEI	146A, 1.2kV, 0.075A, 3V	E-22			
CR121U13JY	AEI	146A, 1.3kV, 0.15A, 3V	E-22			
CR121U13JY1	AEI	120A, 1.3kV, 0.075A, 3V	E-22			
CR121UX5JY	AEI	146A, 50V, 0.15A, 3V	E-22			
CR121UX5JY1	AEI	146A, 50V, 0.075A, 3V	E-22			

器件型号 Element type	厂名 Manufacturers	材料用途参数 Material Purpose Parameter	图号 Figure	国内外相似替换器件型号 Replace of similar type	备注 Notes	外形参考图 Reference shape
CR0122A	AGS	8A, 100V, 0.025A, 1.5V	B-91			
CR0122B	AGS	8A, 200V, 0.025A, 1.5V	B-91			
CR0122C	AGS	8A, 300V, 0.025A, 1.5V	B-91			
CR0122D	AGS	8A, 400V, 0.025A, 1.5V	B-91			
CR0122E	AGS	8A, 500V, 0.025A, 1.5V	B-91			
CR0122F	AGS	8A, 50V, 0.025A, 1.5V	B-91			
CR0122M	AGS	8A, 600V, 0.025A, 1.5V	B-91			
CR0122N	AGS	8A, 800V, 0.025A, 1.5V	B-91			
CR135F01JY	AEI	220A, 100V, 0.15A, 3V	E-16			
CR135F02JY	AEI	220A, 200V, 0.15A, 3V	E-16			
CR135F03JY	AEI	220A, 300V, 0.15A, 3V	E-16			
CR135F04JY	AEI	220A, 400V, 0.15A, 3V	E-16			
CR135F05JY	AEI	220A, 500V, 0.15A, 3V	E-16			
CR135F06JY	AEI	220A, 600V, 0.15A, 3V	E-16			
CR135F08JY	AEI	220A, 800V, 0.15A, 3V	E-16			
CR135F10JY	AEI	220A, 1kV, 0.15A, 3V	E-16			
CR135FX5JY	AEI	220A, 50V, 0.15A, 3V	E-16			
CR135U01JY	AEI	170A, 100V, 0.15A, 3V	E-22			
CR135U01JY2	AEI	170A, 100V, 0.15A, 2.5V	E-22			
CR135U02JY	AEI	170A, 200V, 0.15A, 3V	E-22			
CR135U02JY2	AEI	170A, 200V, 0.15A, 2.5V	E-22			
CR135U03JY	AEI	170A, 300V, 0.15A, 3V	E-22			
CR135U03JY2	AEI	170A, 300V, 0.15A, 2.5V	E-22			
CR135U04JY	AEI	170A, 400V, 0.15A, 3V	E-22			
CR135U04JY2	AEI	170A, 400V, 0.15A, 2.5V	E-22			
CR135U05JY	AEI	170A, 500V, 0.15A, 3V	E-22			
CR135U05JY2	AEI	170A, 500V, 0.15A, 2.5V	E-22			
CR135U06JY	AEI	170A, 600V, 0.15A, 3V	E-22			

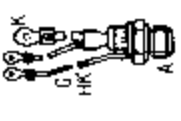
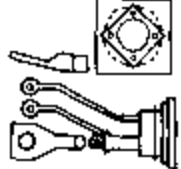
器件型号 Element type	厂名 Manufacturers	材料用途参数 Material Purpose Parameter	图号 Figure	国内外相似替换器件型号 Replace of similar type	备注 Notes	外形参考图 Reference shape
CR135U06JY2	AEI	170A, 600V, 0.15A, 2.5V	E-22			 图 E-22
CR135U08JY	AEI	170A, 800V, 0.15A, 3V	E-22			
CR135U08JY2	AEI	170A, 800V, 0.15A, 2.5V	E-22			
CR135U10JY	AEI	170A, 1kV, 0.15A, 3V	E-22			
CR135U10JY2	AEI	170A, 1kV, 0.15A, 2.5V	E-22			
CR135U11JY	AEI	170A, 1.1kV, 0.15A, 3V	E-22			
CR135U11JY2	AEI	170A, 1.1kV, 0.15A, 2.5V	E-22			
CR135U12JY	AEI	170A, 1.2kV, 0.15A, 3V	E-22			
CR135U12JY2	AEI	170A, 1.2kV, 0.15A, 2.5V	E-22			
CR135U13JY	AEI	170A, 1.3kV, 0.15A, 3V	E-22			
CR135U13JY2	AEI	170A, 1.3kV, 0.15A, 2.5V	E-22			
CR135UX5JY	AEI	170A, 50V, 0.15A, 3V	E-22			
CR135UX5JY2	AEI	170A, 50V, 0.15A, 2.5V	E-22			
CR0137-14	TAG	35A, 1.4kV, 0.05A, 2.5V	F-48			
CR140F01JY	AEI	235A, 100V, 0.15A, 3V	E-16			
CR140F02JY	AEI	235A, 200V, 0.15A, 3V	E-16			
CR140F03JY	AEI	235A, 300V, 0.15A, 3V	E-16			
CR140F04JY	AEI	235A, 400V, 0.15A, 3V	E-16			
CR140F05JY	AEI	235A, 500V, 0.15A, 3V	E-16			
CR140F06JY	AEI	235A, 600V, 0.15A, 3V	E-16			
CR140F08JY	AEI	235A, 800V, 0.15A, 3V	E-16			
CR140F10JY	AEI	235A, 1kV, 0.15A, 3V	E-16			
CR140F11JY	AEI	235A, 1.1kV, 0.15A, 3V	E-16			
CR140F13JY	AEI	235A, 1.3kV, 0.15A, 3V	E-16			
CR140F14JY	AEI	235A, 1.4kV, 0.15A, 3V	E-16			
CR140FX5JY	AEI	235A, 50V, 0.15A, 3V	E-16			
CR140U01JY	AEI	190A, 100V, 0.15A, 3V	E-22			 图 E-16



器件型号 Element type	厂名 Manufacturers	材料用途参数 Material Purpose Parameter	图号 Figure	国内外相似替换器件型号 Replace of similar type	备注 Notes	外形参考图 Reference shape
CR140U01JY2	AEI	190A, 100V, 0.15A, 2.5V	E-22			 图 E-22
CR140U02JY	AEI	190A, 200V, 0.15A, 3V	E-22			
CR140U02JY2	AEI	190A, 200V, 0.15A, 2.5V	E-22			
CR140U03JY	AEI	190A, 300V, 0.15A, 3V	E-22			
CR140U03JY2	AEI	190A, 300V, 0.15A, 2.5V	E-22			
CR140U04JY	AEI	190A, 400V, 0.15A, 3V	E-22			
CR140U04JY2	AEI	190A, 400V, 0.15A, 2.5V	E-22			
CR140U05JY	AEI	190A, 500V, 0.15A, 3V	E-22			
CR140U05JY2	AEI	190A, 500V, 0.15A, 2.5V	E-22			
CR140U06JY	AEI	190A, 600V, 0.15A, 3V	E-22			
CR140U06JY2	AEI	190A, 600V, 0.15A, 2.5V	E-22			
CR140U08JY	AEI	190A, 800V, 0.15A, 3V	E-22			
CR140U08JY2	AEI	190A, 800V, 0.15A, 2.5V	E-22			
CR140U10JY	AEI	190A, 1kV, 0.15A, 3V	E-22			
CR140U10JY2	AEI	190A, 1kV, 0.15A, 2.5V	E-22			
CR140U11JY	AEI	190A, 1.1kV, 0.15A, 3V	E-22			
CR140U11JY2	AEI	190A, 1.1kV, 0.15A, 2.5V	E-22			
CR140U12JY	AEI	190A, 1.2kV, 0.15A, 3V	E-22			
CR140U12JY2	AEI	190A, 1.2kV, 0.15A, 2.5V	E-22			
CR140U13JY	AEI	190A, 1.3kV, 0.15A, 3V	E-22			
CR140U13JY2	AEI	190A, 1.3kV, 0.15A, 2.5V	E-22			
CR140U14JY	AEI	190A, 1.4kV, 0.15A, 3V	E-22			
CR140U14JY2	AEI	190A, 1.4kV, 0.15A, 2.5V	E-22			
CR140UX5JY	AEI	190A, 50V, 0.15A, 3V	E-22			
CR140UX5JY2	AEI	190A, 50V, 0.15A, 2.5V	E-22			
CH150DM4	MIT	175A, 200V, 0.2A, 1.5V	E-22			
CR150DM6	MIT	175A, 300V, 0.2A, 1.5V	E-22			
CR150DM8	MIT	175A, 400V, 0.2A, 1.5V	E-22			



器件型号 Element type	厂名 Manufacturers	材料用途参数 Material Purpose Parameter	图号 Figure	国内外相似替换器件型号 Replace of similar type	备注 Notes	外形参考图 Reference shape
CR150DM10	MIT	175A, 500V, 0.2A, 1.5V	F-22			 图 E-22
CR150DM12	MIT	175A, 600V, 0.2A, 1.5V	E-22			
CR150DM16	MIT	175A, 800V, 0.2A, 1.5V	C-22			
CR150DM20	MIT	175A, 1kV, 0.2A, 1.5V	E-22			
CR150DM24	MIT	175A, 1.2kV, 0.2A, 1.5V	E-22			
CR150DM28	MIT	175A, 1.4kV	E-22			
CR150DM32	MIT	175A, 1.6kV, 0.2A, 1.5V	E-22			
CR150DM36	MIT	175A, 1.8kV, 0.2A, 1.5V	E-22			
CR150DX4	MIT	SCR-H 150A, 200V, 0.2A, 2V	E-22			
CR150DX6	MIT	SCR-H 150A, 300V, 0.2A, 2V	E-22			
CR150DX8	MIT	SCR-H 150A, 400V, 0.2A, 2V	E-22			
CR150DX10	MIT	SCR-H 150A, 500V, 0.2A, 2V	E-22			
CR150DX12	MIT	SCR-H 150A, 600V, 0.2A, 2V	E-22			
CR150DX16	MIT	150A, 800V, 0.2A, 2V	E-22			
CR150DX20	MIT	150A, 1kV, 0.2A, 2V	E-22			
CR150DY4	MIT	SCR-H 150A, 200V, 0.2A, 2V	E-22			
CR150DY6	MIT	SCR-H 150A, 300V, 0.2A, 2V	E-22			
CR150DY8	MIT	SCR-H 150A, 400V, 0.2A, 2V	E-22			
CR150DY10	MIT	SCR-H 150A, 500V, 0.2A, 2V	E-22			
CR150DY12	MIT	SCR-H 150A, 600V, 0.2A, 2V	E-22			
CR150DY16	MIT	150A, 800V, 0.2A, 2V	E-22			
CR250DP4	MIT	250A, 200V, 0.12A, 1.5V	E-22			
CR250DP6	MIT	250A, 300V, 0.12A, 1.5V	E-22			
CR250DP8	MIT	250A, 400V, 0.12A, 1.5V	E-22			
CR250J4	MIT	250A, 200V, 0.2A, 1.5V	E-22			
CR250J6	MIT	250A, 300V, 0.2A, 1.5V	E-22			

器件型号 Element type	厂名 Manufacturers	材料用途参数 Material Purpose Parameter	图号 Figure	国内外相似替换器件型号 Replace of similar type	备注 Notes	外形参考图 Reference shape
CR250J8	MIT	250A, 400V, 0.2A, 1.5V	E-22			 图 E-22
CR250J10	MIT	250A, 500V, 0.2A, 1.5V	E-22			
CR250J12	MIT	250A, 600V, 0.2A, 1.5V	E-22			
CR250J16	MIT	250A, 800V, 0.2A, 1.5V	E-22			
CR250J20	MIT	250A, 1kV, 0.2A, 1.5V	E-22			
CR250J24	MIT	250A, 1.2kV, 0.2A, 1.5V	E-22			
CR250J28	MIT	250A, 1.4kV, 0.2A, 1.5V	E-22			
CR250J32	MIT	250A, 1.6kV, 0.2A, 1.5V	E-22			
CR250J36	MIT	250A, 1.8kV, 0.2A, 1.5V	E-22			
CR250JX4	MIT	SCR-H 250A, 200V, 0.2A, 2V	E-22			
CR250JX6	MIT	SCR-H 250A, 300V, 0.2A, 2V	E-22			
CR250JX8	MIT	SCR-H 250A, 400V, 0.2A, 2V	E-22			
CR250JX10	MIT	SCR-H 250A, 500V, 0.2A, 2V	E-22			
CR250JX12	MIT	SCR-H 250A, 600V, 0.2A, 2V	E-22			
CR250JX16	MIT	SCR-H 250A, 800V, 0.2A, 2V	E-22			
CR250JX20	MIT	SCR-H 250A, 1kV, 0.2A, 2V	E-22			
CH250JY4	MIT	SCR-H 250A, 200V, 0.2A, 2V	E-22			
CR250JY6	MIT	SCR-H 250A, 300V, 0.2A, 2V	E-22			
CR250JY8	MIT	SCR-H 250A, 400V, 0.2A, 2V	E-22			
CR250JY10	MIT	SCR-H 250A, 500V, 0.2A, 2V	E-22			
CR250JY12	MIT	SCR-H 250A, 600V, 0.2A, 2V	E-22			
CR250JY16	MIT	SCR-H 250A, 800V, 0.2A, 2V	E-22			
CR300FX40	MIT	SCR-H 250A, 2kV, 0.35A, 2.5V	E-22			
CR300FX50	MIT	SCR-H 250A, 2.5kV, 0.35A, 2.5V	E-22			
CR400EL4	MIT	400A, 200V, 0.2A, 2.5V	E-22			
CR400EL6	MIT	400A, 300V, 0.2A, 2.5V	E-22			



器件型号 Element type	厂名 Manufacturers	材料用途参数 Material Purpose Parameter	图号 Figure	国内外相似替换器件型号 Replace of similar type	备注 Notes	外形参考图 Reference shape
CR400EL8	MIT	400A, 400V, 0.2A, 2.5V	E-22			 图 E-22
CR400EL10	MIT	400A, 500V, 0.2A, 2.5V	E-22			
CR400EL12	MIT	400A, 600V, 0.2A, 2.5V	E-22			
CR400EL16	MIT	400A, 800V, 0.2A, 2.5V	E-22			
CR400EL20	MIT	400A, 1kV, 0.2A, 2.5V	E-22			
CR400EL24	MIT	400A, 1.2kV, 0.2A, 2.5V	E-22			
CR400EX4	MIT	300A, 200V, 0.2A, 2.5V	E-22			
CR400EX6	MIT	300A, 300V, 0.2A, 2.5V	E-22			
CR400EX8	MIT	300A, 400V, 0.2A, 2.5V	E-22			
CR400EX10	MIT	300A, 500V, 0.2A, 2.5V	E-22			
CR400EX12	MIT	300A, 600V, 0.2A, 2.5V	E-22			
CR400EX16	MIT	300A, 800V, 0.2A, 2.5V	E-22			
CR400EX20	MIT	300A, 1kV, 0.2A, 2.5V	E-22			
CR400EX24	MIT	300A, 1.2kV, 0.2A, 2.5V	E-22			
CR400EY4	MIT	300A, 200V, 0.2A, 2.5V	E-22			
CR400EY6	MIT	300A, 300V, 0.2A, 2.5V	E-22			
CR400EY8	MIT	300A, 400V, 0.2A, 2.5V	E-22			
CR400EY10	MIT	300A, 500V, 0.2A, 2.5V	E-22			
CR400EY12	MIT	300A, 600V, 0.2A, 2.5V	E-22			
CR400EY16	MIT	300A, 800V, 0.2A, 2.5V	E-22			
CR400EY32	MIT	400A, 1.6kV, 0.2A, 2.5V	E-22			
CR400EY34	MIT	400A, 1.7kV, 0.2A, 2.5V	E-22			
CR400FM28		400A, 1.4kV, 0.2A, 2.5V	E-22			
CR400FM32		400A, 1.6kV, 0.2A, 2.5V	E-22			
CR400FM36		400A, 1.8kV, 0.2A, 2.5V	E-22			
CR500AL-4		500A, 200V	F-74			 图 F-74
CR500AL-6		500A, 300V	F-74			
CR500AL-8		500A, 400V	F-74			

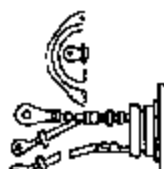

器件型号 Element type	厂名 Manufacturers	材料用途参数 Material Purpose Paramotor	图号 Figure	国内外相似替换器件型号 Replace of similar type	备注 Notes	外形参考图 Reference shape
CR500AL-10		500A, 500V	F-74			 图 F-74
CR500AL-12		500A, 600V	F-74			
CR703SW0101	AEI	470A, 75V, 0.15A, 3.5V	E-9			 图 E-9
CH703SW0202	AEI	470A, 150V, 0.15A, 3.5V	E-9			
CR703SW0303	AEI	470A, 200V, 0.15A, 3.5V	E-9			
CR703SW0404	AEI	470A, 300V, 0.15A, 3.5V	E-9			
CR703SW0505	AEI	470A, 400V, 0.15A, 3.5V	E-9			
CR703SW0606	AEI	470A, 500V, 0.15A, 3.5V	E-9			
CR703SW0707	AEI	470A, 600V, 0.15A, 3.5V	E-9			
CR703SW0808	AEI	470A, 700V, 0.15A, 3.5V	E-9			
CR703SW0909	AEI	470A, 800V, 0.15A, 3.5V	E-9			
CR703SW1010	AEI	470A, 900V, 0.15A, 3.5V	E-9			
CR703SW1111	AEI	470A, 1kV, 0.15A, 3.5V	E-9			
CR703SW1212	AEI	470A, 1.1kV, 0.15A, 3.5V	E-9			
CR703SW1313	AEI	470A, 1.2kV, 0.15A, 3.5V	E-9			
CR703SW1414	AEI	470A, 1.3kV, 0.15A, 3.5V	E-9			
CR703SW1515	AEI	470A, 1.4kV, 0.15A, 3.5V	E-9			
CR705SW0101	AEI	400A, 75V, 0.15A, 3.5V	E-9			
CR705SW0202	AEI	400A, 150V, 0.15A, 3.5V	E-9			
CR705SW0303	AEI	400A, 200V, 0.15A, 3.5V	E-9			
CR705SW0404	AEI	400A, 300V, 0.15A, 3.5V	E-9			
CR705SW0505	AEI	400A, 400V, 0.15A, 3.5V	E-9			
CR705SW0606	AEI	400A, 500V, 0.15A, 3.5V	E-9			
CR705SW0707	AEI	400A, 600V, 0.15A, 3.5V	E-9			
CR705SW0808	AEI	400A, 700V, 0.15A, 3.5V	E-9			
CR705SW0909	AEI	400A, 800V, 0.15A, 3.5V	E-9			
CH705SW1010	AEI	400A, 900V, 0.15A, 3.5V	E-9			

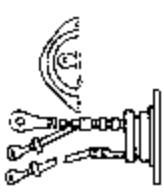
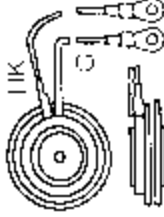
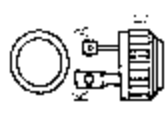

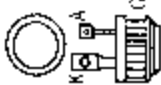
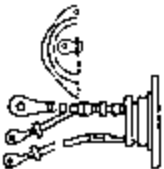
器件型号 Element type	厂名 Manufacturers	材料 Material	用途 Purpose	参数 Parameter	图号 Figure	国内外相似替换器件型号 Replace of similar type	备注 Notes	外形参考图 Reference shape
CR705SW1111	AEI	400A,	1kV,	0.15A,	3.5V	E-9		
CR705SW1212	AEI	400A,	1.1kV,	0.15A,	3.5V	C-67		
CR705SW1313	AEI	400A,	1.2kV,	0.15A,	3.5V	E-9		
CR705SW1414	AEI	400A,	1.3kV,	0.15A,	3.5V	E-9		
CR705SW1415	AEI	400A,	1.4kV,	0.15A,	3.5V	E-9		
CR705SW1616	AEI	400A,	1.5kV,	0.15A,	3.5V	E-9		
CR705SW1717	AEI	400A,	1.6kV,	0.15A,	3.5V	E-9		
CR705SW1818	AEI	400A,	1.7kV,	0.15A,	3.5V	F-9		
CR707SW0101	AEI	360A,	75V,	0.15A,	3.5V	E-9		
CR707SW0202	AEI	360A,	150V,	0.15A,	3.5V	E-9		
CR707SW0303	AEI	360A,	200V,	0.15A,	3.5V	C-85		
CR707SW0404	AEI	360A,	300V,	0.15A,	3.5V	E-9		
CR707SW0505	AEI	360A,	400V,	0.15A,	3.5V	E-9		
CR707SW0606	AEI	360A,	500V,	0.15A,	3.5V	E-9		
CR707SW0707	AEI	360A,	600V,	0.15A,	3.5V	E-9		
CR707SW0808	AEI	360A,	700V,	0.15A,	3.5V	E-9		
CR707SW0909	AEI	360A,	800V,	0.15A,	3.5V	E-9		
CR707SW1010	AEI	360A,	900V,	0.15A,	3.5V	E-9		
CR707SW1111	AEI	360A,	1kV,	0.15A,	3.5V	E-9		
CR707SW1212	AEI	360A,	1.1kV,	0.15A,	3.5V	C-85		
CR707SW1313	AEI	360A,	1.2kV,	0.15A,	3.5V	C-85		
CR707SW1414	AEI	360A,	1.3kV,	0.15A,	3.5V	C-85		
CR707SW1515	AEI	360A,	1.4kV,	0.15A,	3V	E-9		
CR707SW1616	AEI	360A,	1.5kV,	0.15A,	3.5V	E-9		
CR707SW1717	AEI	360A,	1.6kV,	0.15A,	3.5V	E-9		
CR707SW1818	AEI	360A,	1.7kV,	0.15A,	3.5V	E-9		
CR707SW1919	AEI	360A,	1.7kV,	0.15A,	3.5V	E-9		
CR707SW2020	AEI	360A,	1.8kV,	0.15A,	3.5V	C-85		

器件型号 Element type	厂名 Manufacturers	材料用途参数 Material Purpose Parameter	图号 Figure	国内外相似替换器件型号 Replace of similar type	备注 Notes	外形参考图 Reference shape
CR707SW2121	AEI	360A, 1.8kV, 0.15A, 3.5V	C-85			 图 C-85
CR707SW2222	AEI	360A, 1.9kV, 0.15A, 3.5V	E-9			
CR707SW2323	AEI	360A, 1.9kV, 0.15A, 3.5V	E-9			
CR804SW0101	AEI	630A, 75V, 0.15A, 3.5V	E-9			 图 E-9
CR804SW0202	AEI	630A, 150V, 0.15A, 3.5V	E-9			
CR804SW0303	AEI	630A, 200V, 0.15A, 3.5V	E-9			
CR804SW0404	AEI	630A, 300V, 0.15A, 3.5V	E-9			
CR804SW0505	AEI	630A, 400V, 0.15A, 3.5V	E-9			
CR804SW0606	AEI	630A, 500V, 0.15A, 3.5V	E-9			
CR804SW0707	AEI	630A, 600V, 0.15A, 3.5V	E-9			
CR804SW0808	AEI	630A, 700V, 0.15A, 3.5V	E-9			
CR804SW1010	AEI	630A, 900V, 0.15A, 3.5V	E-9			
CR804SW1111	AEI	630A, 1kV, 0.15A, 3.5V	E-9			
CR804SW1212	AEI	630A, 1.1kV, 0.15A, 3.5V	E-9			
CR804SW1313	AEI	630A, 1.2kV, 0.15A, 3.5V	E-9			
CR804SW1414	AEI	630A, 1.3kV, 0.15A, 3.5V	E-9			
CR804SW1515	AEI	630A, 1.4kV, 0.15A, 3.5V	E-9			
CR804SW1616	AEI	630A, 1.5kV, 0.15A, 3.5V	E-9			
CR807SW0101	AEI	535A, 75V, 0.15A, 3.5V	E-9			
CR807SW0202	AEI	535A, 150V, 0.15A, 3.5V	E-9			
CR807SW0303	AEI	535A, 200V, 0.15A, 3.5V	E-9			
CR807SW0404	AEI	535A, 300V, 0.15A, 3.5V	E-9			
CR807SW0505	AEI	535A, 400V, 0.15A, 3.5V	E-9			
CR807SW0606	AEI	535A, 500V, 0.15A, 3.5V	E-9			
CR807SW0707	AEI	535A, 600V, 0.15A, 3.5V	E-9			
CR807SW0808	AEI	535A, 700V, 0.15A, 3.5V	E-9			
CR807SW0909	AEI	535A, 800V, 0.15A, 3.5V	E-9			

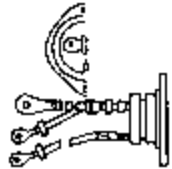

器件型号 Element type	厂名 Manufacturers	材料用途参数 Material Purpose Parameter	图号 Figure	国内外相似替换器件型号 Replace of similar type	备注 Notes	外形参考图 Reference shape
CR807SW1010	AEI	535A, 900V, 0.15A, 3.5V	E-9			 图 E-9
CR807SW1111	AEI	535A, 1kV, 0.15A, 3.5V	E-9			
CR807SW1212	AEI	535A, 1.1kV, 0.15A, 3.5V	E-9			
CR807SW1313	AEI	535A, 1.2kV, 0.15A, 3.5V	E-9			
CR807SW1515	AEI	535A, 1.4kV, 0.15A, 3.5V	E-9			
CR807SW1616	AEI	535A, 1.5kV, 0.15A, 3.5V	E-9			
CR807SW1717	AEI	535A, 1.6kV, 0.15A, 3.5V	E-9			
CR807SW1818	AEI	535A, 1.7kV, 0.15A, 3.5V	E-9			
CR807SW1919	AEI	535A, 1.7kV, 0.15A, 3.5V	E-9			
CR807SW2020	AEI	535A, 1.8kV, 0.15A, 3.5V	E-9			
CR807SW2121	AEI	535A, 1.8kV, 0.15A, 3.5V	E-9			
CR807SW2222	AEI	535A, 1.9kV, 0.15A, 3.5V	E-9			
CR807SW2323	AEI	535A, 1.9kV, 0.15A, 3.5V	E-9			
CR807SW2424	AEI	535A, 2kV, 0.15A, 3.5V	E-9			
CR807SW2525	AEI	535A, 2kV, 0.15A, 3.5V	E-9			
CS0.6-02...-12		50Hz-Thy 1.5A, 0.2~1.2kV, 0.01A	B-108			 图 B-108
CS0.8-02	AEI	50Hz-Thy 8A, 200V, 0.01A, 2V	B-4	BSIA3026M, TAG621 200, TAG632-200		
CS0.8-04	AEI	50Hz-Thy 8A, 400V, 0.01A, 2V	B-4	BSIA3033M, TAG621-400, TAG632-400		
CS0.8-06	AEI	50Hz-Thy 8A, 600V, 0.01A, 2V	B-4	BSIA3040M, TAG621-600, TAG632-600		
CS0.8-07		50Hz-Thy 0.8A, 700V, 0.01A	B-97	BSIA3053M, TAG621-700, TAG632-700		
CS0.8-08	AEI	0.8A, 800V, 0.01A, 2V	B-4			
CS1-02...-12		50Hz-Thy 2A, 0.2~1.2kV, 0.015A	B-108	BSID36...		
CS1.2-02...-07		50Hz-Thy 0.3A, 200~700V, 0.015A	B-97	BSIC07..., TAG620-..., TAG630-...		
CS2.5-02...-06		50Hz-Thy 3.2A, 200~600V, 0.015A	B-11	BSIC10..., TAG620-..., TIC116-...		
CS3-02...-08	BBC	50Hz-Thy 5A, 200~800V, 0.01A, 2V	B-11	T3.5N..., TAG661-..., TAG621-..., TAG662-...		
CS3.5-02...-07		50Hz-Thy 6A, 200~700V, 0.015A	B-11	S2800..., TAG665-..., TIC126-...		

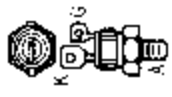
器件型号 Element type	厂名 Manufacturers	材料用途参数 Material Purpose Parameter	图号 Figure	国内外相似替换器作型号 Replace of similar type	备注 Notes	外形参考图 Reference shape
CS5-02	BBC	25A, 200V, 0.03A, 2.5V	F-47			
CS5-04	BBC	25A, 400V, 0.03A, 2.5V	F-47			
CS5-06	BBC	25A, 600V, 0.03A, 2.5V	F-47			
CS5-08	BBC	25A, 800V, 0.03A, 2.5V	F-47			
CS6-02		50Hz-Thy 6A, 200V, 0.015A	B-11	S2800B, TAG665-200, TIC126B		
CS6-03		50Hz-Thy 6A, 300V, 0.015A	B-11	S2800C, TAG665-300, TIC126C		
CS6-04	BBC	50Hz-Thy 6A, 400V, 0.015A, 2V	B-11	S2800D, TAG665-400, TIC126D		
CS6-05	BBC	50Hz-Thy 6A, 500V, 0.015A	B-11	S2800E, TAG665-500, TIC126E		
CS6-06	BBC	50Hz-Thy 6A, 600V, 0.015A, 2V	B-11	S2800M, TAG665-600, TIC126M		
CS6-07	BBC	50Hz-Thy 6A, 700V, 0.015A, 2V	B-11	S2800S, TAG665-700		
CS6-08	BBC	50Hz-Thy 6A, 800V, 0.015A, 2V	B-11	TAG665-800, TIC126N		
CS8-02go2	BBC	25A, 200V, 0.03A, 2.5V	F-47			
CS8-02go3	BBC	16A, 200V, 0.03A, 2.5V	F-50			
CS8-04go2	BBC	25A, 400V, 0.03A, 2.5V	F-47			
CS8-06go2	BBC	25A, 600V, 0.03A, 2.5V	F-47			
CS8-06go3	BBC	16A, 600V, 0.03A, 2.5V	F-50			
CS08C		10A, 200V	D-19			
CS08D		10A, 300V	D-19			
CS08E		10A, 400V	D-19			
CS08F		10A, 500V	D-19			
CS08G		10A, 600V	D-19			
CS08C		10A, 200V	D-19			
CS08D		10A, 300V	D-19			
CS08E		10A, 400V	D-19			
CS08F		10A, 500V	D-19			
CS08G		10A, 600V	D-19			
CS10-02...08		50Hz-Thy 10A, 200-800V, 0.025A	B-11	BS10...M, T9.5N...		
CS10-04go2	BBC	10A, 400V, 0.025A, 2V				



器件型号 Element type	厂名 Manufacturers	材料用途参数 Material Purpose Parameter	图号 Figure	国内外相似替换器件型号 Replace of similar type	备注 Notes	外形参考图 Reference shape
CS10-06go2	BBC	10A, 600V, 0.025A, 2V				
CS10-07go2	BBC	10A, 700V, 0.025A, 2V				图 B-11
CS10-08go2	BBC	10A, 800V, 0.025A, 2V				
CS15-02...08		50Hz-Thy 15A, 200-800V, 0.025A	B-11			
CS15-02go2	BBC	15A, 200V, 0.025A, 2V				
CS15-04go2	BBC	15A, 400V, 0.025A, 2V				
CS15-06go2	BBC	15A, 600V, 0.025A, 2V				
CS15-07go2	BBC	15A, 700V, 0.025A, 2V				
CS15-08go2	BBC	15A, 800V, 0.025A, 2V				
CS15.9-04	BBC	35A, 400V, 0.12A, 3V	F-8	TAG16F400DMFC		
CS15.9-06	BBC	35A, 600V, 0.12A, 3V	F-8	TAG16F600DMFC		
CS15.9-08	BBC	35A, 800V, 0.12A, 3V	F-8			
CS15.9-10gp	BBC	35A, 1kV, 0.12A, 3V	F-8			
CS15.9-10gu	BBC	23A, 1kV, 0.04A, 2V	F-47	TAG16F1000QJEC		
CS15.9-10ht	BBC	35A, 1kV, 0.12A, 3V	F-8			
CS23-10	BBC	32A, 1.2kV, 0.05A, 2.5V	F-8			
CS23-12	BBC	32A, 1.2kV, 0.05A, 2.5V	F-8			
CS38-10	BBC	110A, 1kV, 0.15A, 3V				
CS38-12	BBC	110A, 1.2kV, 0.15A, 3V				
CS50-06go1	BBC	75A, 600V, 0.1A, 3V	F-92			
CS50-06go2	BBC	120A, 600V, 0.1A, 3V	E-30			
CS50-08io1	BBC	75A, 800V, 0.1A, 3V	F-92			
CS50-08io2	BBC	120A, 800V, 0.1A, 3V	E-30			
CS50-10io1	BBC	75A, 1kV, 0.1A, 3V	F-92			
CS50-10io2	BBC	120A, 1kV, 0.1A, 3V	E-30			
CS50-12io1	BBC	75A, 1.2kV, 0.1A, 3V	F-92			

图 F-47



图 F-92



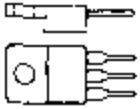
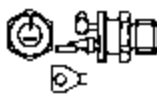

图 E-30

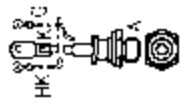
器件型号 Element type	厂名 Manufacturers	材料用途参数 Material Purpose Parameter	图号 Figure	国内外相似替换器件型号 Replace of similar type	备注 Notes	外形参考图 Reference shape
CS50-12ia2	BBC	120A, 1.2kV, 0.1A, 3V	E-30			 图 E-30
CS50-14ia1	BBC	75A, 1.4kV, 0.1A, 3V	F-92			
CS50-14ia2	BBC	120A, 1.4kV, 0.1A, 3V	E-30			
CS50-16ia1	BBC	75A, 1.6kV, 0.1A, 3V	F-92			
CS50-16ia2	BBC	120A, 1.6kV, 0.1A, 3V	E-30			
CS70-06ga1	BBC	102A, 600V, 0.1A, 3V	F-92			 图 F-92
CS70-06ga2	BBC	160A, 600V, 0.1A, 3V	E-30			
CS70-08ia1	BBC	102A, 800V, 0.1A, 3V	F-92			
CS70-08ia2	BBC	160A, 800V, 0.1A, 3V	E-30			
CS70-10ia1	BBC	102A, 1kV, 0.1A, 3V	F-92			
CS70-12ia1	BBC	102A, 1.2kV, 0.1A, 3V	F-92			
CS70-12ia2	BBC	160A, 1.2kV, 0.1A, 3V	E-30			
CS70-16ia2	BBC	160A, 1.6kV, 0.1A, 3V	E-30			
CS70-18	BBC	102A, 1.8kV, 0.1A, 3V	F-92			
CS78-06	BBC	160A, 600V, 0.15A, 3V				
CS78-08	BBC	160A, 800V, 0.15A, 3V				
CS78-10	BBC	160A, 1kV, 0.15A, 3V				
CS78-12	BBC	160A, 1.2kV, 0.15A, 3V	C-30			
CS78-13	BBC	100A, 1.3kV, 0.1A, 3V	F-92			
CS101-36ia2	BBC	100A, 3.6kV, 0.4A, 3V	E-22			 图 E-22
CS101-40ia2	BBC	100A, 4kV, 0.4A, 3V	E-22			
CS110-06	BBC	180A, 600V, 0.1A, 3V	F-74			 图 F-74
CS110-08	BBC	180A, 800V, 0.1A, 3V	F-74			
CS110-10	BBC	180A, 1kV, 0.1A, 3V	F-74			
CS110-12	BBC	180A, 1.2kV, 0.1A, 3V	F-74			



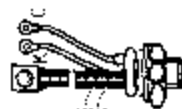
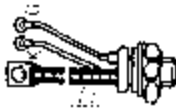
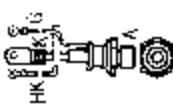
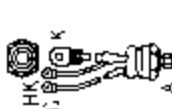





器件型号 Element type	厂名 Manufacturers	材料用途参数 Material Purpose Parameter	图号 Figure	国内外相似替换器件型号 Replace of similar type	备注 Notes	外形参考图 Reference shape
CS110-16	BBC	180A, 1.6kV, 0.1A, 3V	F-74			
CS160-08	BBC	251A, 800V, 0.2A, 3V	E-13			
CS160-16	BBC	251A, 1.6kV, 0.2A, 3V	E-13			
CS186-04	BBC	180A, 400V, 0.15A, 2.5V	C-32			
CS186-06	BBC	180A, 600V, 0.15A, 2.5V	C-32			
CS186-08	BBC	180A, 800V, 0.15A, 2.5V	C-32			
CS186-12	BBC	180A, 1.2kV, 0.15A, 2.5V	C-32			
CS186-16	BBC	180A, 1.6kV, 0.15A, 2.5V	C-32			
CS190-08	BBC	367A, 800V, 0.15A, 3V	F-92			
CS190-12	BBC	367A, 1.2kV, 0.15A, 3V	F-92			
CS190-16	BBC	370A, 1.6kV, 0.15A, 3V	F-92			
CS210-04	BBC	413A, 400V, 0.15A, 3V	F-92			
CS210-06	BBC	413A, 600V, 0.15A, 3V	F-92			
CS210-08	BBC	413A, 800V, 0.15A, 3V	F-92			
CS210-10	BBC	413A, 1kV, 0.15A, 3V	F-92			
CS210-12	BBC	413A, 1.2kV, 0.15A, 3V	F-92			
CS220-08	BBC	450A, 800V, 0.15A, 2V	E-13			
CS220-12	BBC	450A, 1.2kV, 0.15A, 2V	E-13			
CS220-14	BBC	450A, 1.4kV, 0.15A, 2V	E-13			
CS220-16	BBC	450A, 1.6kV, 0.15A, 2V	E-13			
CS226-04	BBC	220A, 400V, 0.15A, 2.5V	C-32			
CS226-06	BBC	220A, 600V, 0.15A, 2.5V	C-32			
CS226-12	BBC	220A, 1.2kV, 0.15A, 2.5V	C-32			



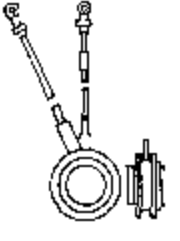
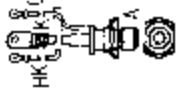
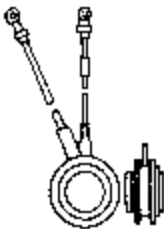
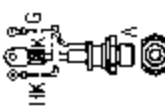
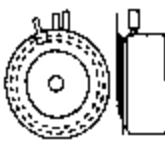

图 F-74



图 E-13

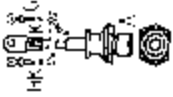

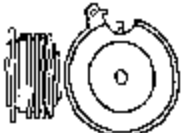

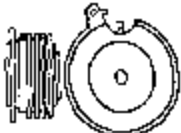
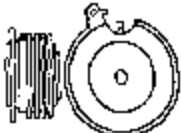
图 C-32

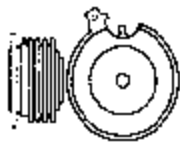
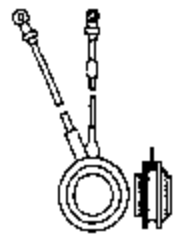
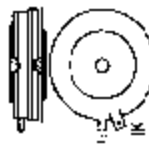
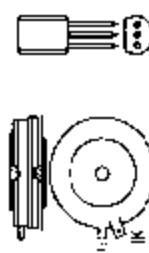
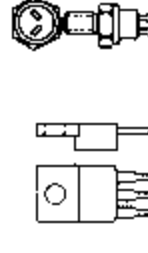
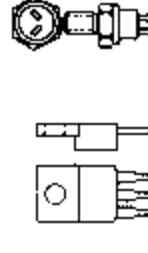
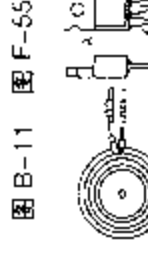
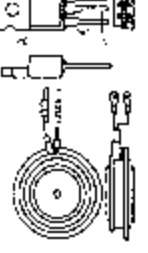
图 F-92

器件型号 Element type	厂名 Manufacturers	材料用途参数 Material Purpose Parameter	图号 Figure	国内外相似替换器件型号 Replace of similar type	备注 Notes	外形参考图 Reference shape
CS226-14	BBC	220A, 1.4kV, 0.15A, 2.5V	C-32			
CS226-16	BBC	220A, 1.6kV, 0.15A, 2.5V	C-32			
CS240-04	BBC	450A, 400V, 0.15A, 3V	F-92			
CS240-06	BBC	450A, 600V, 0.15A, 3V	F-92			
CS250-04	BBC	550A, 400V, 0.15A, 2V	C-32			
CS250-06	BBC	550A, 600V, 0.15A, 2V	C-32			
CS250-08	BBC	450A, 800V, 0.15A, 2V	C-32			
CS250-10	BBC	350A, 1kV, 0.15A, 2V	C-18			
CS250-12	BBC	450A, 1.2kV, 0.15A, 2V	C-32			
CS250-16	BBC	450A, 1.6kV, 0.15A, 2V	C-32			
CS295-08	BBC	554A, 800V, 0.2A, 3V	F-92			
CS295-12	BBC	554A, 1.2kV, 0.2A, 3V	F-92			
CS295-16	BBC	554A, 1.6kV, 0.2A, 3V	F-92			
CS300-08	BBC	600A, 800V, 0.15A, 2V	E-13			
CS300-12	BBC	600A, 1.2kV, 0.15A, 2V	E-13			
CS300-16	BBC	600A, 1.6kV, 0.15A, 2V	E-13			
CS300-18	BBC	600A, 1.8kV, 0.15A, 2V	E-13			
CS330-04	BBC	643A, 400V, 0.2A, 3V	F-92			
CS330-06	BBC	643A, 600V, 0.2A, 3V	F-92			
CS330-08	BBC	643A, 800V, 0.2A, 3V	F-92			
CS330-10	BBC	643A, 1kV, 0.2A, 3V	F-92			
CS330-12	BBC	643A, 1.2kV, 0.2A, 3V	F-92			
CS351-18	BBC	1kA, 1.8kV, 0.2A, 3V	C-18			
CS351-25	BBC	1kA, 2.5kV, 0.2A, 3V	C-18			

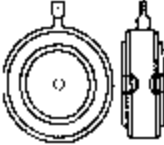
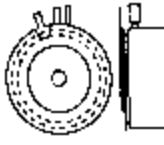
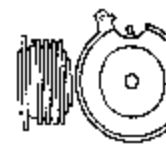
器件型号 Element type	厂名 Manufacturers	材料 Material	用途 Purpose	参数 Parameter	图号 Figure	国内外相似替换器件型号 Replace of similar type	备注 Notes	外形参考图 Reference shape
CS370-04	BBC	704A	400V, 0.2A, 3V		F-92			 图 F-92
CS370-06	BBC	704A	600V, 0.2A, 3V		F-92			
CS400-08	BBC	722A	800V, 0.2A, 2.5V		C-32			 图 C-32
CS400-12	BBC	722A	1.2kV, 0.2A, 2.5V		C-32			
CS400-14	BBC	722A	1.4kV, 0.2A, 2.5V		C-32			
CS400-15	BBC	722A	1.5kV, 0.2A, 2.5V		C-32			
CS400-16	BBC	722A	1.6kV, 0.2A, 2.5V		C-32			
CS411-18	BBC	1.2kA	1.8kV, 0.3A, 3V		C-11			 图 C-11
CS411-20	BBC	1.2kA	2kV, 0.3A, 3V		C-11			
CS411-23	BBC	1.2kA	2.3kV, 0.3A, 3V		C-11			
CS411-25	BBC	1.2kA	2.5kV, 0.3A, 3V		C-11			
CS550-08	BBC	1.5kA	800V, 0.2A, 2.5V		C-32			 图 C-32
CS550-10	BBC	1.5kA	1kV, 0.2A, 2.5V		C-32			
CS550-12	BBC	1.5kA	1.2kV, 0.2A, 2.5V		C-32			
CS550-14	BBC	1.5kA	1.4kV, 0.2A, 2.5V		C-32			
CS550-16	BBC	1.5kA	1.6kV, 0.2A, 2.5V		C-32			
CS601-20	BBC	942A	2kV, 0.25A, 3V		C-11			 图 C-11
CS601-23	BBC	2kA	2.3kV, 0.25A, 3V		C-11			
CS601-25	BBC	942A	2.5kV, 0.25A, 3V		C-11			
CS661-27	BBC	1kA	2.7kV, 0.3A, 4V		C-11			
CS661-30	BBC	1kA	3kV, 0.3A, 4V		C-11			
CS661-32	BBC	1kA	3.2kV, 0.3A, 4V		C-11			
CS1000-08	BBC	3kA	800V, 0.3A, 3V		C-11			 图 C-11
CS1000-10	BBC	3kA	1kV, 0.3A, 3V		C-11			

器件型号 Element type	厂名 Manufacturers	材料用途参数 Material Purpose Parameter	图号 Figure	国内外相似替换器件型号 Replace of similar type	备注 Notes	外形参考图 Reference shape
CS1000-12	BBC	3kA, 1.2kV, 0.3A, 3V	C-11			
CS1000-14	BBC	3kA, 1.4kV, 0.3A, 3V	C-11			
CS1000-16	BBC	3kA, 1.6kV, 0.3A, 3V	C-11			
CS1000-18	BBC	3kA, 1.8kV, 0.3A, 3V	C-11			
CS1001-22	BBC	920A, 2.2kV, 0.3A, 3V	C-11			
CS1001-24	BBC	920A, 2.4kV, 0.3A, 3V	C-11			
CS1001-25	BBC	920A, 2.5kV, 0.3A, 3V	C-11			
CS1300-08	BBC	1.1kA, 800V, 0.3A, 3V	C-32			
CS1300-10	BBC	3kA, 1kV, 0.3A, 3V				
CS1300-14	BBC	1.1kA, 1.4kV, 0.3A, 3V	C-32			
CS1300-18	BBC	1.1kA, 1.8kV, 0.3A, 3V	C-32			
CS2102-44	BBC	5kA, 4.4kV, 0.5A, 4V	C-7			
CSF02AM1		SCR-H 0.26A, 50V, 0.00025A	B-35	BRX45, BRX46, BRX50, BRX51, TAG60F, TAG62F		
CSF02AM2		SCR-H 0.26A, 100V, 0.00025A	B-35	BRX46, BRX47, BRX50, BRX51, TAG60A, TAG62A		
CSF02AM4		SCR-H 0.26A, 200V, 0.00025A	B-35	BRX47, BRX48, BRX52, BRX53, BRX54		
CSF02AM8		SCR-H 0.26A, 400V, 0.00025A	B-35	BRX49, BRX54, BRX55, BRX56, BRY55S-400		
CSF02AM10		SCR-H 0.26A, 500V, 0.00025A	B-35	BRX55, BRX56, BRY55S-500		
CSF0.7-04		SCR-H 3A, 400V, 0.05A	B-11	BT153, TAG650S-400, TAG655S-400		
CSF7.9-04...08		SCR-H 14A, 400-800V, 0.1A	F-55			
CSF11-02...08		SCR-H 10A, 200-800V, 0.035A	B-11			
CSF11-02er1	BBC	10A, 200V, 0.03A, 3V	C-50			
CSF11-04er1	BBC	10A, 400V, 0.03A, 3V	B-91			
CSF11-06ep1	BBC	10A, 600V, 0.03A, 3V	B-91			
CSF11-06et1	BBC	10A, 600V, 0.03A, 3V	B-91			

器件型号 Element type	厂名 Manufacturers	材料用途参数 Material Purpose Parameter	图号 Figure	国内外相似替换器件型号 Replace of similar type	备注 Notes	外形参考图 Reference shape
CSF315-02	BBC	700A, 200V, 0.25A, 2.5V	C-22			 图 C-22
CSF315-04	BBC	700A, 400V, 0.25A, 2.5V	C-22			
CF369-06	BBC	1kA, 600V, 0.3A, 3V	C-18			
CF369-08	BBC	1kA, 800V, 0.3A, 3V	C-18			
CF369-10	BBC	1kA, 1kV, 0.3A, 3V	C-18			 图 C-18
CF369-11	BBC	1kA, 1.1kV, 0.3A, 3V	C-18			
CSF375-02g	BBC	850A, 200V, 0.25A, 2.5V	C-22			
CSF375-04g	BBC	850A, 400V, 0.25A, 2.5V	C-22			
CSF375-04h, i	BBC	370A, 400V, 0.25A, 2.5V	C-22			 图 C-11
CSF375-05g	BBC	850A, 500V, 0.25A, 2.5V	C-22			
CSF375-05h, i	BBC	370A, 500V, 0.25A, 2.5V	C-22			
CSF399-12	BBC	1.5kA, 1.2kV, 0.25A, 2.5V	C-11			
CSF399-14	BBC	1.5kA, 1.4kV, 0.3A, 2.5V	C-32			 图 C-32
CSF495-02g	BBC	1.2kA, 200V, 0.25A, 2.5V	C-22			
CSF495-02h, i	BBC	700A, 200V, 0.25A, 2.5V	C-22			
CSF495-03h, i	BBC	700A, 300V, 0.25A, 2.5V	C-22			
CSF495-04h, i	BBC	1.2kA, 400V, 0.25A, 2.5V	C-22			 图 C-11
CSF495-05g	BBC	1.2kA, 500V, 0.25A, 2.5V	C-22			
CSF495-05h, i	BBC	700A, 500V, 0.25A, 2.5V	C-22			
CSF499-12i	BBC	1.57kA, 1.2kV, 0.3A, 4V	C-11			
CSF547-08	BBC	1.2kA, 800V, 0.25A, 2.5V	C-11			 图 C-32
CSF547-09	BBC	1.2kA, 900V, 0.25A, 2.5V	C-11			
CSF547-10	BBC	1.2kA, 1kV, 0.25A, 2.5V	C-11			

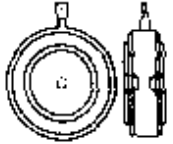
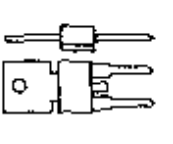
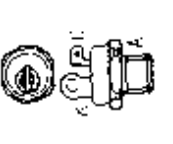
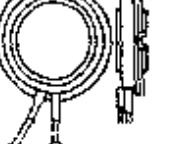
器件型号 Element type	厂名 Manufacturers	材料用途参数 Material Purpose Parameter	图号 Figure	国内外相似替换器件型号 Replace of similar type	备注 Notes	外形参考图 Reference shape
CSF548-11	BBC	1.1kA, 1.1kV, 0.25A, 2.5V	C-11			
CSF548-13	BBC	1.1kA, 1.3kV, 0.25A, 2.5V	C-11			图 C-11
CSF549-14	BBC	934A, 1.4kV, 0.15A, 2V	C-11			
CSF549-15	BBC	934A, 1.5kV, 0.15A, 2V	C-11			图 C-22
CSF549-16	BBC	934A, 1.6kV, 0.15A, 2V	C-11			
CSF551-18	BBC	1kA, 1.8kV, 0.25A, 2.5V	C-11			图 B-7
CSF551-20	BBC	1kA, 2kV, 0.25A, 2.5V	C-11			
CSF595-02	BBC	1.4kA, 200V, 0.25A, 2.5V	C-22			图 F-6
CSF595-04	BBC	1.4kA, 400V, 0.25A, 2.5V	C-22			
CSF595-05	BBC	1.4kA, 500V, 0.25A, 2.5V	C-22			图 C-35
CSM2B2		50Hz-Thy 2A, 200V, 0.001A, 0.0015A	B-7	C106B, C107B, TAG106-200, TAG107-200		
CSM2B4		50Hz-Thy 2A, 400V, 0.001A, 0.0015A	B-7	C106D, C107D, TAG106-400, TAG107-400		
CSM3B2		50Hz-Thy 3A, 200V, 0.001A, 0.0015A	B-7	C106R, C107R, TAG106-200, TAG107-200		
CSM3B4		50Hz-Thy 3A, 400V, 0.001A, 0.0015A	B-7	C106D, C107D, TAG106-400, TAG107-400		
CSM5B2		50Hz-Thy 5A, 200V, 0.03A, 0.025A	F-6	CS2.5 02, TAG651-200, TAG656-200		
CSM5B4		50Hz-Thy 5A, 400V, 0.03A, 0.025A	F-6	CS2.5-04, TAG651-400, TAG656-400		
CSR146-05	BBC	RCT 115A, 500V, 0.35A, 3.5V	C-35			
CSR146-06	BBC	RCT 115A, 600V, 0.35A, 3.5V	C-35			
CSR146-07	BBC	RCT 15A, 700V, 0.35A, 3.5V	C-35			
CSR147-08	BBC	RCT 105A, 800V, 0.35A, 3.5V	C-35			
CSR147-09	BBC	RCT 105A, 1kV, 0.35A, 3.5V	C-35			
CSR148-11	BBC	RCT 105A, 1.1kV, 0.35A, 3.5V	C-35			
CSR148-12	BBC	RCT 105A, 1.2kV, 0.35A, 3.5V	C-35			
CSR148-13	BBC	RCT 105A, 1.2kV, 0.35A, 3.5V	C-35			
CSR149-14	BBC	RCT 100A, 1.4kV, 0.35A, 3.5V	C-35			

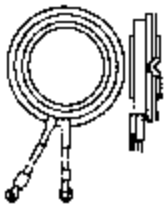
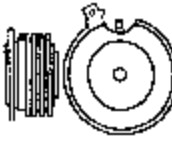
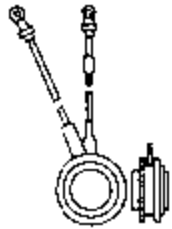
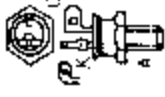
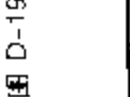
器件型号 Element type	厂名 Manufacturers	材料用途参数 Material Purpose Parameter	图号 Figure	国内外相似替换器件型号 Replace of similar type	备注 Notes	外形参考图 Reference shape
CSR149-15	BBC	RCT 100A, 1.5KV, 0.35A, 3.5V	C-35			 图 C-35
CSR149-16	BBC	RCT 100A, 1.6KV, 0.35A, 3.5V	C-35			
CSR327-08	BBC	RCT 310A, 800V, 0.35A, 3.5V	C-11			 图 C-11
CSR327-09	BBC	RCT 310A, 900V, 0.35A, 3.5V	C-11			
CSR327-10	BBC	RCT 310A, 1KV, 0.35A, 3.5V	C-11			 图 C-32
CSR328-11	BBC	RCT 290A, 1.1KV, 0.35A, 3.5V	C-11			
CSR328-12	BBC	RCT 290A, 1.2KV, 0.35A, 3.5V	C-11			 图 D-19
CSR328-13	BBC	RCT 290A, 1.3KV, 0.35A, 3.5V	C-11			
CSR329-14	BBC	RCT 250A, 1.4KV, 0.35A, 3.5V	C-11			
CSR447-08	BBC	RCT 365A, 800V, 0.35A, 3.5V	C-11			 图 D-19
CSR447-09	BBC	RCT 365A, 900V, 0.35A, 3.5V	C-11			
CSR448-11	BBC	RCT 350A, 1.1KV, 0.35A, 3.5V	C-11			
CSR448-12	BBC	RCT 350A, 1.2KV, 0.35A, 3.5V	C-11			
CSR448-13	BBC	RCT 350A, 1.3KV, 0.35A, 3.5V	C-11			
CSR449-14	BBC	RCT 340A, 1.4KV, 0.35A, 3.5V	C-11			
CSR449-15	BBC	RCT 340A, 1.5KV, 0.35A, 3.5V	C-11			
CSR449-16	BBC	RCT 190A, 1.6KV, 0.35A, 3.5V	C-11			
CSR451-18	BBC	RCT 315A, 1.8KV, 0.35A, 3.5V	C-11			
CSR451-20	BBC	RCT 315A, 2KV, 0.35A, 3.5V	C-11			
CSR729-16	BBC	RCT 650A, 1.6KV, 0.45A, 3.5V	C-32			
CSR731-18	BBC	RCT 590A, 1.8KV, 0.45A, 3.5V	C-32			
CSR731-20	BBC	RCT 590A, 2KV, 0.45A, 3.5V	C-32			
CT08C		5A, 200V	D-19			
CT08D		5A, 300V	D-19			
CT08E		5A, 400V	D-19			

器件型号 Element type	厂名 Manufacturers	材料用途参数 Material Purpose Parameter	图号 Figure	国内外相似替换器件型号 Replace of similar type	备注 Notes	外形参考图 Reference shape
CT08F		5A, 500V	D-19			
CT08G		5A, 500V	D-19			
CT09C		5A, 200V	D-19			
CT09D		5A, 300V	D-19			
CT09E		5A, 400V	D-19			
CT09F		5A, 500V	D-19			
CT09G		5A, 600V	D-19			
CT15-4	MOT	15A, 200V, 0.05A, 2V	B-103			
CT15-5	MOT	15A, 300V, 0.05A, 2V	B-103			
CT15-6	MOT	15A, 400V, 0.05A, 2V	B-103			
CT15-7	MOT	15A, 500V, 0.05A, 2V	B-103			
CT15-8	MOT	15A, 600V, 0.05A, 2V	B-103			
CT15-9	MOT	15A, 700V, 0.05A, 2V	B-103			
CT15-10	MOT	15A, 800V, 0.05A, 2V	B-103			
CT15A1	MOT	15A, 200V, 0.05A, 2V	B-103			
CT15A5	MOT	15A, 300V, 0.05A, 2V	B-103			
CT15A6	MOT	15A, 400V, 0.05A, 2V	B-103			
CT15A7	MOT	15A, 500V, 0.05A, 2V	B-103			
CT15A8	MOT	15A, 600V, 0.05A, 2V	B-103			
CT15A9	MOT	15A, 700V, 0.05A, 2V	B-103			
CT15A10	MOT	15A, 800V, 0.05A, 2V	B-103			
CT223-4	MOT	25A, 200V, 0.05A, 2V	B-103			
CT223-5	MOT	25A, 300V, 0.05A, 2V	B-103			
CT223-6	MOT	25A, 400V, 0.05A, 2V	B-103			
CT223-7	MOT	25A, 500V, 0.05A, 2V	B-103			
CT223-8	MOT	25A, 600V, 0.05A, 2V	B-103			
CT223-9	MOT	25A, 700V, 0.05A, 2V	B-103			



图 D-19





图 B-103

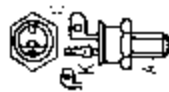

器件型号 Element type	厂名 Manufacturers	材料用途参数 Material Purpose Parameter	图号 Figure	国内外相似替换器件型号 Replace of similar type	备注 Notes	外形参考图 Reference snape
CT223-10	MOT	25A, 600V, 0.05A, 2V	B-103			 <p>图 D-103</p>
CT223A4	MOT	25A, 200V, 0.05A, 2V	B-103			
CT223A5	MOT	25A, 300V, 0.05A, 2V	B-103			
CT223A6	MOT	25A, 400V, 0.05A, 2V	B-103			
CT223A7	MOT	25A, 500V, 0.05A, 2V	B-103			
CT223A8	MOT	25A, 600V, 0.05A, 2V	B-103			
CT223A9	MOT	25A, 700V, 0.05A, 2V	B-103			
CT223A10	MOT	25A, 800V, 0.05A, 2V	B-103			
CU16J6S3		28A, 220V				
CU16L6A3		39A, 220V				
CU16Q6S3		28A, 440V				
CU30J6S3		355A, 220V				
CU30L6A3		81A, 220V				
CU30Q6S3		355A, 440V				
CU50J6S3		94A, 220V				
CU50L6A3		126A, 220V				
CU50Q6S3		94A, 440V				
CU60L3A1, 31		81A, 220V				
CU60L3S1, 31		60A, 220V				
CU60J3A1, 31		81A, 440V				
CU60J3S1, 31		60A, 440V				
CU80J6S3		133A, 220V				
CU80L6A3		171A, 220V				
CU80Q6S3		133A, 440V				
CU90J6A3		171A, 440V				
CU100L3A1		126A, 220V				
CU100L3A31		126A, 220V				

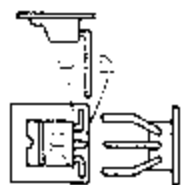
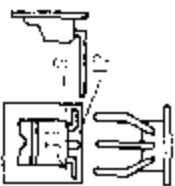
器件型号 Element type	厂名 Manufacturers	材料用途参数 Material Purpose Parameter	图号 Figure	国内外相似替换器件型号 Replace of similar type	备注 Notes	外形参考图 Reference shape
CU100L3S1		95A, 220V				 图 B-80
CU100L3S31		95A, 220V				
CU100U3A1		126A, 440V				
CU100U3A31		126A, 440V				
CU100U3S1		95A, 440V				
CU100U3S31		95A, 440V				
CU150J5S3		94A, 220V				
CU150L6A3		300A, 220V				
CU150Q6S3		94A, 220V				
CU150U6A3		300A, 440V				
CU180L3A1		180A, 220V				
CU180L3A31		180A, 220V				
CU180L3S1		135A, 220V				
CU180U3A31		135A, 440V				
CU180U3A1		180A, 440V				
CU180U3A31		180A, 440V				
CU180U3S1		135A, 220V				
CU180U3S31		135A, 440V				
CU300J6S3		59A, 220V				
CU300L6A3		405A, 220V				
CU300Q6S3		59A, 440V				
CU300U6A3		405A, 440V				
CW01B	Thy	0.2A, 100V, 0.001A, 0.0005A	B-80	MCR1906-100, TAG2-100, 2N1595, 2N1596, 2N1597, 2N1598, 2N1599		
CW01C	Thy	0.2A, 200V, 0.001A, 0.0005A	B-80	MCR1906-200, TAG2-200, 2N1595, 2N1596, 2N1597, 2N1598, 2N1599		



器件型号 Element type	厂名 Manufacturers	材料用途参数 Material Purpose Parameter	图号 Figure	国内外相似替换器件型号 Replace of similar type	备注 Notes	外形参考图 Reference shape
CW12B		50Hz-Thy 0.2A, 100V, 0.001A, 0.0005A	B-35	MCR1906-100, 1AG2-100, 2N1595, 2N1596, 2N1597, 2N1598, 2N1599		 图 D-05
CW12C		50Hz-Thy 0.2A, 200V, 0.001A, 0.0005A	B-35	MCR1906-200, TAG2-200, 2N1595, 2N1596, 2N1597, 2N1598, 2N1599		

C类外形参考图索引



图 B-4



图 B-6



图 B-7

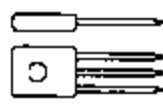

图 B-8

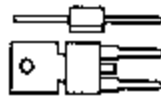

图 B-9



图 B-10

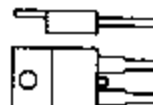

图 B-11



图 B-21

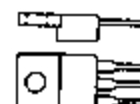

图 B-22



图 B-31

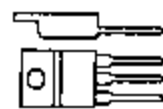

图 B-34



图 B-35

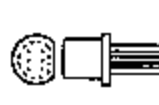

图 B-36

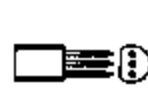

图 B-45



图 B-51



图 B-55



图 B-65

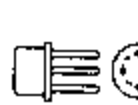

图 B-74



图 B-80

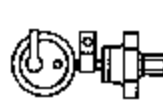

图 B-87



图 B-89

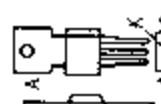

图 B-91

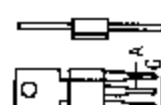

图 B-97

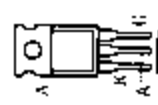

图 B-98



图 B-103

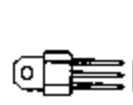

图 B-105

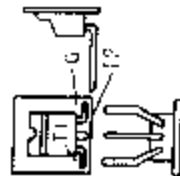

图 B-108



图 C-3



图 C-4



图 C-5



图 C-7



图 C-10



图 C-11

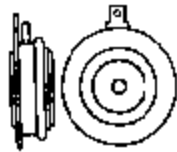

图 C-18

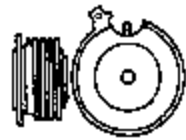

图 C-22

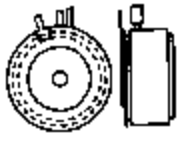

图 C-24

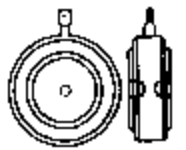

图 C-25

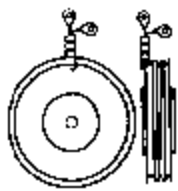

图 C-32

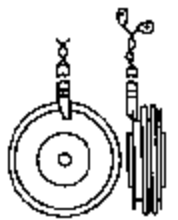

图 C-35

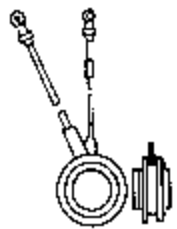

图 C-44

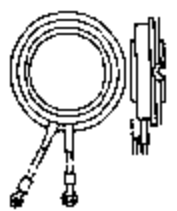

图 C-50

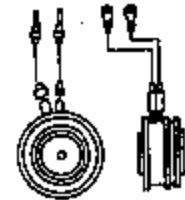

图 C-57

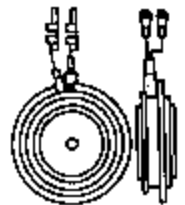

图 C-64

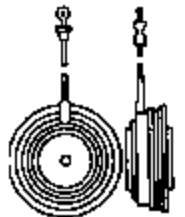

图 C-67



图 C-70

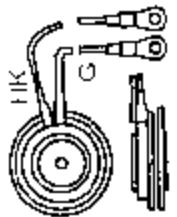

图 C-74

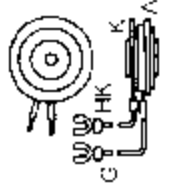

图 C-75

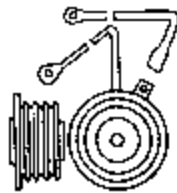

图 C-85

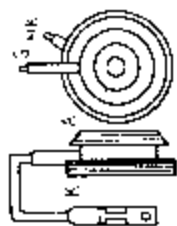

图 D-14

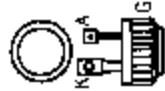

图 D-19



图 D-21



图 D-28

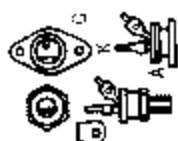

图 D-29

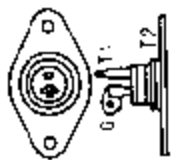

图 D-34

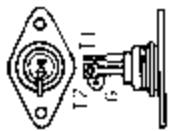

图 E-1

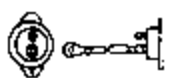

图 E-6

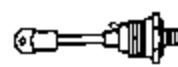

图 E-9



图 E-13

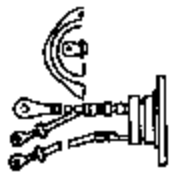

图 E-16



图 E-22

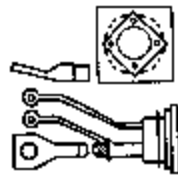

图 E-30



图 F-4



图 F-6



图 F-8



图 F-15



图 F-20



图 F-21



图 F-23



图 F-27

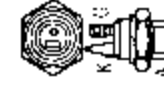

图 F-30

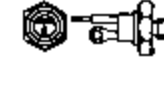

图 F-47



图 F-48



图 F-50

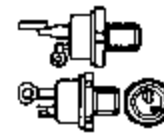

图 F-51



图 F-55



图 F-57



图 F-63



图 F-71

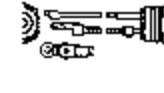

图 F-74



图 F-75



图 F-76



图 F-91



图 F-92



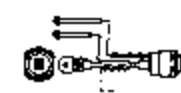





图 H-29

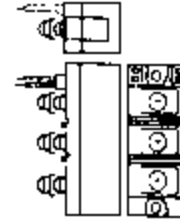

器件型号 Element type	厂名 Manufacturers	材料用途参数 Material Purpose Parameter	图号 Figure	国内外相似替换器件型号 Replace of similar type	备注 Notes	外形参考图 Reference shape
D13H1	GES	SAS, 9V	B-34			
D13H2	GES	SAS, 9V	B-34			
D30	HUT	DAC, 2A, 3.8V, 28V	F-1	ECG6408, GT-32, 1N5762		
D52	Thy	-SOBRY55/30	G-1	SOBRY55/30		
D65		0.3A, 30V, 200 μA, 0.8V	G-2	SOBRY55/30R		
D66, 67		0.3A, 60V, 200 μA, 0.8V	G-2	SOBRY55/60R		
D118441	HIN	315A, 3KV, 0.4A	E-12			
D118441-EH00	HIN	3.5A, 3KV, 0.4A	E-12			
D118442	HIN	315A, 3.1KV, 0.4A	E-12			
D118442-EH00	HIN	3.5A, 3.1KV, 0.4A	E-12			
D118442-GE00	HIN	3.5A, 3.1KV, 0.4A	E-12			
D118443	HIN	315A, 3.1KV, 0.4A	E-12			
D118443 EH00	HIN	3.5A, 3.1KV, 0.4A	E-12			
D118444	HIN	315A, 3.2KV, 0.4A	E-12			
D118444-EH00	HIN	3.5A, 3.2KV, 0.4A	E-12			
D118444-GE00	HIN	3.5A, 3.2KV, 0.4A	E-12			
D118445	HIN	315A, 3.2KV, 0.4A	E-12			
D118445-EH00	HIN	3.5A, 3.2KV, 0.4A	E-12			
D118445-GE00	HIN	3.5A, 3.2KV, 0.4A	E-12			
D118446	HIN	315A, 3.3KV, 0.4A	E-12			
D118446-EH00	HIN	3.5A, 3.3KV, 0.4A	E-12			
D118446-GE00	HIN	3.5A, 3.3KV, 0.4A	E-12			
D118447	HIN	315A, 3.3KV, 0.4A	E-12			
D118447 EH00	HIN	3.5A, 3.3KV, 0.4A	E-12			
D118447-GE00	HIN	3.5A, 3.3KV, 0.4A	E-12			

器件型号 Element type	厂名 Manufacturers	材料用途参数 Material Purpose Parameter	图号 Figure	国内外相似替换器件型号 Replace of similar type	备注 Notes	外形参考图 Reference shape
D118448	HIN	315A, 3.4kV, 0.4A	E-12			
D118448-EH00	HIN	3.5A, 3.4kV, 0.4A	E-12			
D118448-GE00	HIN	3.5A, 3.4kV, 0.4A	E-12			
D118449	HIN	315A, 3.4kV, 0.4A	E-12			
D118449-EH00	HIN	3.5A, 3.4kV, 0.4A	E-12			
D118449-GE00	HIN	3.5A, 3.4kV, 0.4A	E-12			
D118450	HIN	315A, 3.5kV, 0.4A	E-12			
D118450-EH00	HIN	3.5A, 3.5kV, 0.4A	E-12			
D118450-GE00	HIN	3.5A, 3.5kV, 0.4A	E-12			
D118451	HIN	315A, 3.5kV, 0.4A	E-12			
D118451-EH00	HIN	3.5A, 3.5kV, 0.4A	E-12			
D118451-GE00	HIN	3.5A, 3.5kV, 0.4A	E-12			
D118452	HIN	315A, 3.6kV, 0.4A	E-12			
D118452-EH00	HIN	3.5A, 3.6kV, 0.4A	E-12			
D118452-GE00	HIN	3.5A, 3.6kV, 0.4A	E-12			
D118453	HIN	315A, 3.6kV, 0.4A	E-12			
D118453-EH00	HIN	3.5A, 3.6kV, 0.4A	E-12			
D118453-GE00	HIN	3.5A, 3.6kV, 0.4A	E-12			
D118454	HIN	315A, 3.7kV, 0.4A	E-12			
D118454-EH00	HIN	3.5A, 3.7kV, 0.4A	E-12			
D118454-GE00	HIN	3.5A, 3.7kV, 0.4A	E-12			
D118455	HIN	315A, 3.7kV, 0.4A	E-12			
D118455-EH00	HIN	3.5A, 3.7kV, 0.4A	E-12			
D118455-GE00	HIN	3.5A, 3.7kV, 0.4A	E-12			
DAT1	PHI	SAS, 10V	B-77			
DB3	AMR, THE	DAC, 3V, 26V, 5V	A-1	ECC6408		
DB4	THE	DAC, 3V, 45V, 5V	A-1			

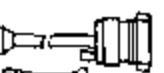
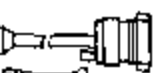
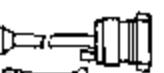
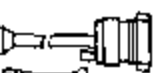
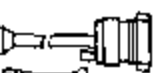
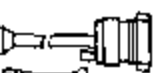
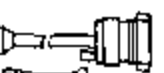
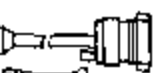
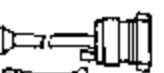
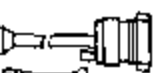
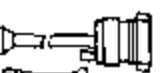
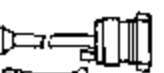
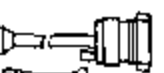
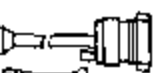
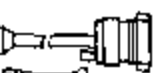
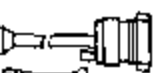
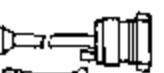
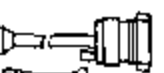
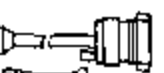
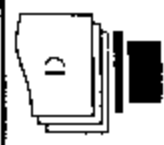
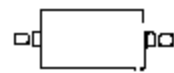
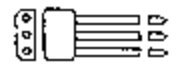
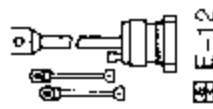

器件型号 Element type	厂名 Manufacturers	材料用途参数 Material Purpose Parameter	图号 Figure	国内外相似替换器件型号 Replace of similar type	备注 Notes	外形参考图 Reference shape
DB6	THE	DAC, 4V, 70V, 10V	A-1			
DCR403ST0101	AEI	540A, 90V, 0.15A, 3V	C-5			
DCR403ST0202	AEI	540A, 180V, 0.15A, 3V	C-5			
DCR403ST0303	AEI	540A, 250V, 0.15A, 3V	C-5			
DCR403ST0404	AEI	540A, 300V, 0.15A, 3V	C-5			
DCR403ST0505	AEI	540A, 400V, 0.15A, 3V	C-5			
DCR403ST0606	AEI	540A, 500V, 0.15A, 3V	C-5			
DCR403ST0707	AEI	350A, 600V, 0.15A, 3V	C-5			
DCR405ST0101	AEI	300A, 75V, 0.15A, 3V	C-5			
DCR405ST0202	AEI	300A, 150V, 0.15A, 3V	C-5			
DCR405ST0303	AEI	300A, 200V, 0.15A, 3V	C-5			
DCR405ST0404	AEI	300A, 300V, 0.15A, 3V	C-5			
DCR405ST0505	AEI	300A, 400V, 0.15A, 3V	C-5			
DCR405ST0606	AEI	300A, 500V, 0.15A, 3V	C-5			
DCR405ST0707	AEI	300A, 600V, 0.15A, 3V	C-5			
DCR405ST0808	AEI	300A, 700V, 0.15A, 3V	C-5			
DCR405ST0909	AEI	300A, 800V, 0.15A, 3V	C-5			
DCR405ST1010	AEI	300A, 900V, 0.15A, 3V	C-5			
DCR405ST1111	AEI	300A, 1kV, 0.15A, 3V	C-5			
DCR405ST1212	AEI	300A, 1.1kV, 0.15A, 3V	C-5			
DCR405ST1313	AEI	300A, 1.2kV, 0.15A, 3V	C-5			
DCR424ST0101	AEI	385A, 90V, 0.15A, 3V	C-5			
DCR424ST0202	AEI	385A, 180V, 0.15A, 3V	C-5			
DCR424ST0303	AEI	385A, 250V, 0.15A, 3V	C-5			
DCR424ST0404	AEI	385A, 300V, 0.15A, 3V	C-5			
DCR424ST0505	AEI	385A, 400V, 0.15A, 3V	C-5			

图 A-1





图 C-5

器件型号 Element type	厂名 Manufacturers	材料用途参数 Material Purpose Parameter	图号 Figure	国内外相似替换器件型号 Replace of similar type	备注 Notes	外形参考图 Reference shape
DCR424ST0606	AEI	385A, 500V, 0.15A, 3V	C-5			 图 C-5
DCR425ST1010	AEI	300A, 90V, 0.15A, 3V	C-5			
DCR425ST0202	AEI	300A, 180V, 0.15A, 3V	C-5			
DCR425ST0303	AEI	300A, 250V, 0.15A, 3V	C-5			
DCR425ST0404	AEI	300A, 300V, 0.15A, 3V	C-5			
DCR425ST0505	AEI	300A, 400V, 0.15A, 3V	C-5			
DCR425ST0606	AEI	300A, 500V, 0.15A, 3V	C-5			
DCR485ST0101	AEI	305A, 90V, 0.15A, 3V	C-5			
DCR485ST0202	AEI	305A, 180V, 0.15A, 3V	C-5			
DCR485ST0303	AEI	305A, 250V, 0.15A, 3V	C-5			
DCR485ST0404	AEI	305A, 300V, 0.15A, 3V	C-5			
DCR485ST0505	AEI	305A, 400V, 0.15A, 3V	C-5			
DCR485ST0606	AEI	305A, 500V, 0.15A, 3V	C-5			
DCR486ST0101	AEI	220A, 90V, 0.25A, 3V	C-5			
DCR486ST0202	AEI	185A, 180V, 0.2A, 3.5V	C-5			
DCR486ST0303	AEI	185A, 250V, 0.2A, 3.5V	C-5			
DCR486ST0404	AEI	185A, 300V, 0.2A, 3.5V	C-5			
DCR486ST0505	AEI	185A, 400V, 0.2A, 3.5V	C-5			
DCR486ST0606	AEI	185A, 500V, 0.2A, 3.5V	C-5			
DCR486ST0707	AEI	185A, 600V, 0.2A, 3.5V	C-5			
DCR486ST0808	AEI	185A, 700V, 0.2A, 3.5V	C-5			
DCR486ST0909	AEI	185A, 800V, 0.2A, 3.5V	C-5			
DCR486ST1010	AEI	185A, 800V, 0.2A, 3.5V	C-5			
DCR486ST1111	AEI	185A, 1kV, 0.2A, 3.5V	C-5			
DCR486ST1212	AEI	185A, 1.1kV, 0.2A, 3.5V	C-5			
DCR486ST1313	AEI	185A, 1.2kV, 0.2A, 3.5V	C-5			
DCR487ST0303	AEI	160A, 250V, 0.15A, 3V	C-5			
DCR487ST0606	AEI	160A, 500V, 0.15A, 3V	C-5			

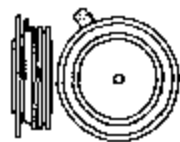
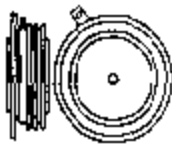
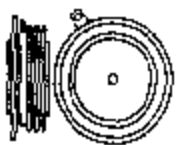
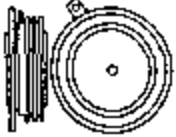
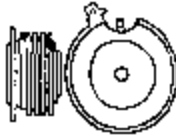

器件型号 Element type	厂名 Manufacturers	材料用途参数 Material Purpose Paramcter	图号 Figure	国内外相似替换器件型号 Replace of similar type	备注 Notes	外形参考图 Reference shape
DCR487ST0707	AEI	160A, 600V, 0.15A, 3V	C-5			 图 C-5
DCR487ST0808	AEI	160A, 700V, 0.15A, 3V	C-5			
DCR487ST0909	AEI	160A, 800V, 0.15A, 3V	C-5			
DCR487ST1010	AEI	160A, 900V, 0.15A, 3V	C-5			
DCR503ST0101	AEI	600A, 90V, 0.15A, 3V	C-5			
DCR503ST0303	AEI	600A, 250V, 0.15A, 3V	C-5			
DCR503ST0404	AEI	600A, 300V, 0.15A, 3V	C-5			
DCR504ST0101	AEI	660A, 90V, 0.15A, 3V	C-5			
DCR504ST0202	AEI	660A, 180V, 0.15A, 3V	C-5			
DCR504ST0303	AEI	660A, 250V, 0.15A, 3V	C-5			
DCR504ST0404	AEI	660A, 300V, 0.15A, 3V	C-5			
DCR504ST0505	AEI	660A, 400V, 0.15A, 3V	C-5			
DCR504ST0606	AEI	660A, 500V, 0.15A, 3V	C-5			
DCR504ST0707	AEI	660A, 600V, 0.15A, 3V	C-5			
DCR504ST0808	AEI	660A, 700V, 0.15A, 3V	C-5			
DCR504ST0909	AEI	660A, 800V, 0.15A, 3V	C-5			
DCR504ST1010	AEI	660A, 900V, 0.15A, 3V	C-5			
DCR504ST1111	AEI	660A, 1kV, 0.15A, 3V	C-5			
DCR504ST1212	AEI	660A, 1.1kV, 0.15A, 3V	C-5			
DCR504ST1313	AEI	660A, 1.2kV, 0.15A, 3V	C-5			
DCR504ST1414	AEI	360A, 1.3kV, 0.15A, 3V	C-5			
DCR504ST1515	AEI	660A, 1.4kV, 0.15A, 3V	C-5			
DCR523ST0101	AEI	440A, 90V, 0.15A, 3V	C-5			
DCR523ST0202	AEI	440A, 180V, 0.15A, 3V	C-5			
DCR523ST0303	AEI	440A, 250V, 0.15A, 3V	C-5			
DCR523ST0404	AEI	440A, 300V, 0.15A, 3V	C-5			
DCR523ST0505	AEI	440A, 400V, 0.15A, 3V	C-5			

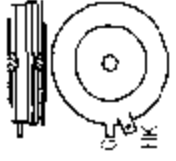
器件型号 Element type	厂名 Manufacturers	材料用途参数 Material Purpose Parameter	图号 Figure	国内外相似替换器件型号 Replace of similar type	备注 Notes	外形参考图 Reference shape	
DCR523ST0606	AEI	440A, 500V, 0.15A, 3V	C-5			 图 C-5	
DCR525SM0101	AEI	470A, 90V, 0.15A, 3V	C-11			 图 C-11	
DCR525SM0202	AEI	470A, 180V, 0.15A, 3V	C-11				
DCR525SM0303	AEI	470A, 250V, 0.15A, 3V	C-11				
DCR525SM0404	AEI	470A, 300V, 0.15A, 3V	C-11				
DCR525SM0505	AEI	470A, 400V, 0.15A, 3V	C-11				
DCR525SM0606	AEI	470A, 500V, 0.15A, 3V	C-11				
DCR586ST0202	AEI	220A, 180V, 0.25A, 3V	C-5			 图 C-1	
DCR586ST0303	AEI	220A, 250V, 0.25A, 3V	C-5				
DCR586ST0404	AEI	220A, 300V, 0.25A, 3V	C-5				
DCR586ST0505	AEI	220A, 400V, 0.25A, 3V	C-5				
DCR586ST0606	AEI	220A, 500V, 0.25A, 3V	C-1				
DCR586ST0707	AEI	220A, 600V, 0.25A, 3V	C-5				
DCR586ST0808	AEI	220A, 700V, 0.25A, 3V	C-5				
DCR586ST0909	AEI	220A, 800V, 0.25A, 3V	C-5				
DCR586ST1010	AEI	220A, 900V, 0.25A, 3V	C-5				
DCR586ST1111	AEI	220A, 1kV, 0.25A, 3V	C-5				
DCR586ST1212	AEI	220A, 1.1kV, 0.25A, 3V	C-5				
DCR586ST1313	AEI	220A, 1.2kV, 0.25A, 3V	C-5				
DCR586ST1414	AEI	220A, 1.3kV, 0.25A, 3V	C-5				
DCR586ST1515	AEI	220A, 1.4kV, 0.25A, 3V	C-5				
DCR586ST1616	AEI	220A, 1.5kV, 0.25A, 3V	C-5				
DCR604SE0101	AEI	555A, 90V, 0.15A, 3V	C-7				 图 C-7
DCR604SE0202	AEI	555A, 180V, 0.15A, 3V	C-1				
DCR604SE0303	AEI	555A, 200V, 0.15A, 3V	C-1				
DCR604SE0404	AEI	555A, 300V, 0.15A, 3V	C-1				

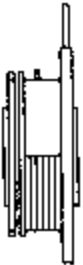

器件型号 Element type	厂名 Manufacturers	材料用途参数 Material Purpose Parameter	图号 Figure	国内外相似替换器件型号 Replace of similar type	备注 Notes	外形参考图 Reference shape
DCR604SE0505	AEI	555A, 400V, 0.15A, 3V	C-1			 <p>图 C-1</p>
DCR604SE0606	AEI	555A, 500V, 0.15A, 3V	C-1			
DCR604SE0707	AEI	555A, 600V, 0.15A, 3V	C-1			
DCR604SE0808	AEI	555A, 700V, 0.15A, 3V	C-1			
DCR604SE0909	AEI	555A, 800V, 0.15A, 3V	C-1			
DCR604SF1010	AEI	555A, 900V, 0.15A, 3V	C-1			
DCR604SE1111	AEI	555A, 1KV, 0.15A, 3V	C-1			
DCR604SE1212	AEI	555A, 1.1KV, 0.15A, 3V	C-1			
DCR604SE1313	AEI	555A, 1.2KV, 0.15A, 3V	C-1			
DCR604SE1414	AEI	555A, 1.3KV, 0.15A, 3V	C-1			
DCR623SE0202	AEI	620A, 180V, 0.15A, 3V	C-1			
DCR623SE0303	AEI	620A, 250V, 0.15A, 3V	C-1			
DCR623SE0404	AEI	620A, 300V, 0.15A, 3V	C-1			
DCR623SE0505	AEI	620A, 400V, 0.15A, 3V	C-1			
DCR623SE0606	AEI	620A, 500V, 0.15A, 3V	C-1			
DCR655SE0101	AEI	425A, 90V, 0.35A, 3.5V	C-1			
DCR655SE0202	AEI	425A, 180V, 0.35A, 3.5V	C-1			
DCR655SE0303	AEI	425A, 250V, 0.35A, 3.5V	C-1			
DCR655SE0404	AEI	425A, 300V, 0.35A, 3.5V	C-1			
DCR655SE0505	AEI	425A, 400V, 0.35A, 3.5V	C-1			
DCR655SE0606	AEI	425A, 500V, 0.35A, 3.5V	C-1			
DCR655SE0707	AEI	425A, 600V, 0.35A, 3.5V	C-1			
DCR655SE0808	AEI	425A, 700V, 0.35A, 3.5V	C-1			
DCR655SE0909	AEI	425A, 800V, 0.35A, 3.5V	C-1			
DCR655SE1010	AEI	425A, 900V, 0.35A, 3.5V	C-1			
DCR655SF1111	AEI	425A, 1KV, 0.35A, 3.5V	C-1			
DCR655SE1212	AEI	425A, 1.1KV, 0.35A, 3.5V	C-1			

器件型号 Element type	厂名 Manufacturers	材料用途参数 Material Purpose Parameter	图号 Figure	国内外相似替换器件型号 Replace of similar type	备注 Notes	外形参考图 Reference shape
DCR655SE1313	AEI	425A, 1.2kV, 0.35A, 3.5V	C-1			 图 C-1
DCR655SE1414	AEI	425A, 1.3kV, 0.35A, 3.5V	C-1			
DCR655SE1515	AEI	425A, 1.4kV, 0.35A, 3.5V	C-1			
DCR655SE1616	AEI	425A, 1.5kV, 0.35A, 3.5V	C-1			
DCR659SE0101	AEI	380A, 90V, 0.35A, 3.5V	C-1			
DCR659SE0202	AEI	380A, 180V, 0.35A, 3.5V	C-1			
DCR659SE0303	AEI	380A, 250V, 0.35A, 3.5V	C-1			
DCR659SE0404	AEI	380A, 300V, 0.35A, 3.5V	C-1			
DCR659SE0505	AEI	380A, 400V, 0.35A, 3.5V	C-1			
DCR659SE0606	AEI	380A, 500V, 0.35A, 3.5V	C-1			
DCR659SE0707	AEI	380A, 600V, 0.35A, 3.5V	C-1			
DCR659SE0909	AEI	380A, 800V, 0.35A, 3.5V	C-1			
DCR659SE1010	AEI	380A, 900V, 0.35A, 3.5V	C-1			
DCR659SE1111	AEI	380A, 1kV, 0.35A, 3.5V	C-1			
DCR659SE1212	AEI	380A, 1.1kV, 0.35A, 3.5V	C-1			
DCR659SE1313	AEI	380A, 1.2kV, 0.35A, 3.5V	C-1			
DCR659SE1414	AEI	380A, 1.3kV, 0.35A, 3.5V	C-1			
DCR659SE1515	AEI	380A, 1.4kV, 0.35A, 3.5V	C-1			
DCR659SE1616	AEI	380A, 1.5kV, 0.35A, 3.5V	C-1			
DCR685SE0101	AEI	520A, 90V, 0.2A, 3.5V	C-1			
DCR685SE0202	AEI	520A, 180V, 0.2A, 3.5V	C-1			
DCR685SE0303	AEI	520A, 200V, 0.2A, 3.5V	C-1			
DCR685SE0404	AEI	520A, 300V, 0.2A, 3.5V	C-1			
DCR685SE0505	AEI	520A, 400V, 0.2A, 3.5V	C-1			
DCR685SE0606	AEI	520A, 500V, 0.2A, 3.5V	C-1			
DCR685SE0707	AEI	520A, 600V, 0.2A, 3.5V	C-1			

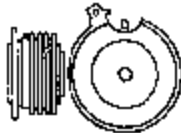

器件型号 Element type	厂名 Manufacturers	材料用途参数 Material Purpose Parameter	图号 Figure	国内外相似替换器件型号 Replace of similar type	备注 Notes	外形参考图 Reference shape
DCR703SM0101	AEI	820A, 75V, 0.15A, 3.5V	C-11			 图 C-11
DCR703SM0202	AEI	820A, 150V, 0.15A, 3.5V	C-11			
DCR703SM0303	AEI	820A, 200V, 0.15A, 3.5V	C-11			
DCR703SM0404	AEI	820A, 300V, 0.15A, 3.5V	C-11			
DCR703SM0505	AEI	820A, 400V, 0.15A, 3.5V	C-11			
DCR703SM0606	AEI	820A, 500V, 0.15A, 3.5V	C-11			
DCR703SM0707	AEI	820A, 600V, 0.15A, 3.5V	C-11			
DCR703SM0808	AEI	820A, 700V, 0.15A, 3.5V	C-11			
DCR703SM0909	AEI	820A, 800V, 0.15A, 3.5V	C-11			
DCR703SM1010	AEI	820A, 900V, 0.15A, 3.5V	C-11			
DCR703SM1111	AEI	820A, 1kV, 0.15A, 3.5V	C-11			
DCR703SM1212	AEI	820A, 1.1kV, 0.15A, 3.5V	C-11			
DCR703SM1313	AEI	820A, 1.2kV, 0.15A, 3.5V	C-11			
DCR703SM1414	AEI	820A, 1.3kV, 0.15A, 3.5V	C-11			
DCR703SM1515	AEI	820A, 1.4kV, 0.15A, 3.5V	C-11			
DCR705SM0101	AEI	780A, 75V, 0.15A, 3.5V	C-11			
DCR705SM0202	AEI	780A, 150V, 0.15A, 3.5V	C-11			
DCR705SM0303	AEI	780A, 200V, 0.15A, 3.5V	C-11			
DCR705SM0404	AEI	780A, 300V, 0.15A, 3.5V	C-11			
DCR705SM0505	AEI	780A, 400V, 0.15A, 3.5V	C-11			
DCR705SM0606	AEI	780A, 500V, 0.15A, 3.5V	C-11			
DCR705SM0707	AEI	780A, 600V, 0.15A, 3.5V	C-11			
DCR705SM0808	AEI	780A, 700V, 0.15A, 3.5V	C-11			
DCR705SM0909	AEI	780A, 800V, 0.15A, 3.5V	C-11			
DCR705SM1010	AEI	780A, 900V, 0.15A, 3.5V	C-11			
DCR705SM1111	AEI	780A, 1kV, 0.15A, 3.5V	C-11			
DCR705SM1212	AEI	780A, 1.1kV, 0.15A, 3.5V	C-11			
DCR705SM1313	AEI	780A, 1.2kV, 0.15A, 3.5V	C-11			

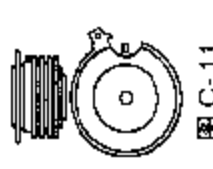
器件型号 Element type	厂名 Manufacturers	材料用途参数 Material Purpose Parameter	图号 Figure	国内外相似替换器件型号 Replace of similar type	备注 Notes	外形参考图 Reference shape
DCR705SM1414	AEI	780A, 1.3KV, 0.15A, 3.5V	C-11			 图 C-11
DCR705SM1515	AEI	780A, 1.4KV, 0.15A, 3.5V	C-11			
DCR705SM1616	AEI	780A, 1.5KV, 0.15A, 3.5V	C-11			
DCR705SM1717	AEI	780A, 1.6KV, 0.15A, 3.5V	C-11			
DCR705SM1618	AEI	780A, 1.7KV, 0.15A, 3.5V	C-11			
DCR707SM0101	AEI	710A, 75V, 0.15A, 3.5V	C-11			
DCR707SM0202	AEI	710A, 150V, 0.15A, 3.5V	C-11			
DCR707SM0303	AEI	710A, 200V, 0.15A, 3.5V	C-11			
DCR707SM0404	AEI	710A, 300V, 0.15A, 3.5V	C-11			
DCR707SM0505	AEI	710A, 400V, 0.15A, 3.5V	C-11			
DCR707SM0606	AEI	710A, 500V, 0.15A, 3.5V	C-11			
DCR707SM0707	AEI	710A, 600V, 0.15A, 3.5V	C-11			
DCR707SM0808	AEI	710A, 700V, 0.15A, 3.5V	C-11			
DCR707SM0909	AEI	710A, 800V, 0.15A, 3.5V	C-11			
DCR707SM1010	AEI	710A, 900V, 0.15A, 3.5V	C-11			
DCR707SM1212	AEI	710A, 1.1KV, 0.15A, 3.5V	C-11			
DCR707SM1313	AEI	710A, 1.2KV, 0.15A, 3.5V	C-11			
DCR707SM1414	AEI	710A, 1.3KV, 0.15A, 3.5V	C-11			
DCR707SM1515	AEI	710A, 1.4KV, 0.15A, 3.5V	C-11			
DCR707SM1616	AEI	710A, 1.5KV, 0.15A, 3.5V	C-11			
DCR707SM1717	AEI	710A, 1.6KV, 0.15A, 3.5V	C-11			
DCR707SM1818	AEI	710A, 1.7KV, 0.15A, 3.5V	C-11			
DCR707SM1919	AEI	710A, 1.7KV, 0.15A, 3.5V	C-11			
DCR707SM2020	AEI	710A, 1.8KV, 0.15A, 3.5V	C-11			
DCR707SM2121	AEI	710A, 1.8KV, 0.15A, 3.5V	C-11			
DCR707SM2222	AEI	710A, 1.9KV, 0.15A, 3.5V	C-11			
DCR707SM2323	AEI	710A, 1.9KV, 0.15A, 3.5V	C-11			
DCR707SM2424	AEI	710A, 2.3KV, 0.2A, 3.5V	C-11			



器件型号 Element type	厂名 Manufacturers	材料用途参数 Material Purposc Paramoter	图号 Figure	国内外相似替换器件型号 Replace of similar type	备注 Notes	外形参考图 Reference shape
DCR707SM2525	AEI	710A, 2.4kV, 0.2A, 3.5V	C-11			
DCR785SG0101	AEI	520A, 90V, 0.2A, 3.5V	C-11			
DCR785SG0202	AEI	520A, 180V, 0.2A, 3.5V	C-11			
DCR785SG0303	AEI	520A, 200V, 0.2A, 3.5V	C-11			
DCR785SG0404	AEI	520A, 300V, 0.2A, 3.5V	C-11			
DCR785SG0505	AEI	520A, 400V, 0.2A, 3.5V	C-11			
DCR785SG0606	AEI	520A, 500V, 0.2A, 3.5V	C-11			
DCR785SG0707	AEI	520A, 600V, 0.2A, 3.5V	C-11			
DCR803SM0101	AEI	1.2kA, 75V, 0.2A, 3.5V	C-11			
DCR803SM0202	AEI	1.2kA, 150V, 0.2A, 3.5V	C-11			
DCR803SM0303	AEI	1.2kA, 200V, 0.2A, 3.5V	C-11			
DCR803SM0404	AEI	1.2kA, 300V, 0.2A, 3.5V	C-11			
DCR803SM0505	AEI	1.2kA, 400V, 0.2A, 3.5V	C-11			
DCR803SM0606	AEI	1.2kA, 500V, 0.2A, 3.5V	C-11			
DCR803SM0707	AEI	1.2kA, 600V, 0.2A, 3.5V	C-11			
DCR803SM0808	AEI	1.2kA, 700V, 0.2A, 3.5V	C-11			
DCR803SM0909	AEI	1.2kA, 800V, 0.2A, 3.5V	C-11			
DCR803SM1010	AEI	1.2kA, 900V, 0.2A, 3.5V	C-11			
DCR803SM1111	AEI	1.2kA, 1kV, 0.2A, 3.5V	C-11			
DCR803SM1212	AEI	1.2kA, 1.1kV, 0.2A, 3.5V	C-11			
DCR803SM1313	AEI	1.2kA, 1.2kV, 0.2A, 3.5V	C-11			
DCR803SM1414	AEI	1.2kA, 1.3kV, 0.2A, 3.5V	C-11			
DCR803SM1515	AEI	1.2kA, 1.4kV, 0.2A, 3.5V	C-11			
DCR803SM1616	AEI	1.2kA, 1.5kV, 0.2A, 3.5V	C-11			
DCR803SM1717	AEI	1.2kA, 1.6kV, 0.2A, 3.5V	C-11			
DCR803SM1818	AEI	1.2kA, 1.7kV, 0.2A, 3.5V	C-11			
DCR804SM0101	AEI	1.19kA, 75V, 0.15A, 3.5V	C-11			





图 C-11

器件型号 Element type	厂名 Manufacturers	材料用途参数 Material Purpose Parameter	图号 Figure	国内外相似替换器件型号 Replace of similar type	备注 Notes	外形参考图 Reference shape
DCR804SM0303	AEI	1.19kA, 200V, 0.15A, 3.5V	C-11			 图 C-11
DCR804SM0404	AEI	1.19kA, 300V, 0.15A, 3.5V	C-11			
DCR804SM0505	AEI	1.19kA, 400V, 0.15A, 3.5V	C-11			
DCR804SM0606	AEI	1.19kA, 500V, 0.15A, 3.5V	C-11			
DCR804SM0707	AEI	1.19kA, 600V, 0.15A, 3.5V	C-11			
DCR804SM0808	AEI	1.19kA, 700V, 0.15A, 3.5V	C-11			
DCR804SM0909	AEI	1.19kA, 800V, 0.15A, 3.5V	C-11			
DCR804SM1010	AEI	1.19kA, 900V, 0.15A, 3.5V	C-11			
DCR804SM1111	AEI	1.19kA, 1kV, 0.15A, 3.5V	C-11			
DCR804SM1212	AEI	1.19kA, 1.1kV, 0.15A, 3.5V	C-11			
DCR804SM1313	AEI	1.19kA, 1.2kV, 0.15A, 3.5V	C-11			
DCR804SM1414	AEI	1.19kA, 1.3kV, 0.15A, 3.5V	C-11			
DCR804SM1515	AEI	1.19kA, 1.4kV, 0.15A, 3.5V	C-11			
DCR804SM1616	AEI	1.19kA, 1.5kV, 0.15A, 3.5V	C-11			
DCR804SM1717	AEI	1.19kA, 1.6kV, 0.2A, 3.5V	C-11			
DCR804SM1818	AEI	1.19kA, 1.7kV, 0.2A, 3.5V	C-11			
DCR804SM1919	AEI	1.19kA, 1.8kV, 0.2A, 3.5V	C-11			
DCR806SM1515	AEI	620A, 1.4kV, 0.2A, 3.5V	C-11			
DCR806SM1616	AEI	620A, 1.5kV, 0.2A, 3.5V	C-11			
DCR806SM1717	AEI	620A, 1.6kV, 0.2A, 3.5V	C-11			
DCR806SM1818	AEI	620A, 1.7kV, 0.2A, 3.5V	C-11			
DCR806SM1919	AEI	620A, 1.8kV, 0.2A, 3.5V	C-11			
DCR806SM2020	AEI	700A, 1.9kV, 0.2A, 3.5V	C-11			
DCR806SM2222	AEI	620A, 2.1kV, 0.2A, 3.5V	C-11			
DCR806SM2323	AEI	620A, 2.2kV, 0.2A, 3.5V	C-11			
DCR806SM2424	AEI	620A, 2.3kV, 0.2A, 3.5V	C-11			
DCR806SM2525	AEI	620A, 2.4kV, 0.2A, 3.5V	C-11			
DCR806SM2626	AEI	620A, 2.5kV, 0.2A, 3.5V	C-11			

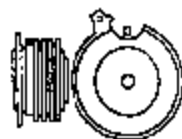

器件型号 Element type	厂名 Manufacturers	材料用途参数 Material Purpose Parameter	图号 Figure	国内外相似替换器件型号 Replace of similar type	备注 Notes	外形参考图 Reference shape
DCR806SM2727	AEI	620A, 2.6KV, 0.2A, 3.5V	C-11			 图 C-11
DCR806SM2828	AEI	620A, 2.7KV, 0.2A, 3.5V	C-11			
DCR806SM2929	AEI	620A, 2.8KV, 0.2A, 3.5V	C-11			
DCR806SM3030	AEI	620A, 2.9KV, 0.2A, 3.5V	C-11			
DCR807SM0101	AEI	1.02kA, 75V, 0.15A, 3.5V	C-11			
DCR807SM0202	AEI	1.02kA, 150V, 0.15A, 3.5V	C-11			
DCR807SM0303	AEI	1.02kA, 200V, 0.15A, 3.5V	C-11			
DCR807SM0404	AEI	1.02kA, 300V, 0.15A, 3.5V	C-11			
DCR807SM0505	AEI	1.02kA, 400V, 0.15A, 3.5V	C-11			
DCR807SM0606	AEI	1.02kA, 500V, 0.15A, 3.5V	C-11			
DCR807SM0707	AEI	1.02kA, 600V, 0.15A, 3.5V	C-11			
DCR807SM0808	AEI	1.02kA, 700V, 0.15A, 3.5V	C-11			
DCR807SM0909	AEI	1.02kA, 800V, 0.15A, 3.5V	C-11			
DCR807SM1010	AEI	1.02kA, 900V, 0.15A, 3.5V	C-11			
DCR807SM1111	AEI	1.02kA, 1kV, 0.15A, 3.5V	C-11			
DCR807SM1212	AEI	1.02kA, 1.1kV, 0.15A, 3.5V	C-11			
DCR807SM1313	AEI	1.02kA, 1.2kV, 0.15A, 3.5V	C-11			
DCR807SM1414	AEI	1.02kA, 1.3kV, 0.15A, 3.5V	C-11			
DCR807SM1515	AEI	1.02kA, 1.4kV, 0.15A, 3.5V	C-11			
DCR807SM1616	AEI	1.02kA, 1.5kV, 0.15A, 3.5V	C-11			
DCR807SM1717	AEI	1.02kA, 1.6kV, 0.15A, 3.5V	C-11			
DCR807SM1818	AEI	1.02kA, 1.7kV, 0.15A, 3.5V	C-11			
DCR807SM1919	AEI	1.02kA, 1.7kV, 0.15A, 3.5V	C-11			
DCR807SM2020	AEI	1.02kA, 1.8kV, 0.15A, 3.5V	C-11			
DCR807SM2121	AEI	1.02kA, 1.8kV, 0.15A, 3.5V	C-11			
DCR807SM2222	AEI	1.02kA, 1.9kV, 0.15A, 3.5V	C-11			
DCR807SM2323	AEI	1.02kA, 1.9kV, 0.15A, 3.5V	C-11			
DCR807SM2626	AEI	1.02kA, 2.5kV, 0.15A, 3.5V	C-11			
DCR807SM2727	AEI	1.02kA, 2.6kV, 0.2A, 3.5V	C-11			

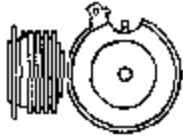
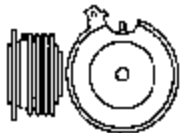
器件型号 Element type	厂名 Manufacturers	材料用途参数 Material Purpose Parameter	图号 Figure	国内外相似替换器件型号 Replace of similar type	备注 Notes	外形参考图 Reference shape
DCR807SM2828	AEI	1.02kV, 2.7kV, 0.2A, 3.5V	C-11			 图 C-11
DCR807SM2929	AEI	1.02kV, 2.8kV, 0.2A, 3.5V	C-11			
DCR807SM3030	AEI	1.02kV, 2.9kV, 0.2A, 3.5V	C-11			
DCR818SM2525	AEI	750A, 2kV, 0.25A, 3.5V	C-11			
DCR818SM2626	AEI	750A, 2kV, 0.25A, 3.5V	C-11			
DCR818SM2727	AEI	750A, 2.1kV, 0.25A, 3.5V	C-11			
DCR818SM2828	AEI	750A, 2.1kV, 0.15A, 3.5V	C-11			
DCR818SM2929	AEI	750A, 2.2kV, 0.25A, 3.5V	C-11			
DCR818SM3030	AEI	750A, 2.3kV, 0.25A, 3.5V	C-11			
DCR818SM3131	AEI	750A, 2.3kV, 0.25A, 3.5V	C-11			
DCR818SM3232	AEI	750A, 2.4kV, 0.25A, 3.5V	C-11			
DCR818SM3333	AEI	750A, 2.5kV, 0.25A, 3.5V	C-11			
DCR818SM3434	AEI	750A, 2.5kV, 0.25A, 3.5V	C-11			
DCR818SM3535	AEI	750A, 2.6kV, 0.25A, 3.5V	C-11			
DCR818SM3636	AEI	750A, 2.7kV, 0.25A, 3.5V	C-11			
DCR818SM3737	AEI	750A, 2.8kV, 0.25A, 3.5V	C-11			
DCR818SM3838	AEI	750A, 2.8kV, 0.25A, 3.5V	C-11			
DCR818SM3939	AEI	750A, 2.9kV, 0.25A, 3.5V	C-11			
DCR818SM4040	AEI	750A, 3kV, 0.25A, 3.5V	C-11			
DCR845SG1313	AEI	605A, 1.2kV, 0.35A, 3.5V				
DCR845SG1414	AEI	605A, 1.3kV, 0.35A, 3.5V	C-11			
DCR845SG1515	AEI	605A, 1.4kV, 0.35A, 3.5V	C-11			
DCR845SG1717	AEI	605A, 1.6kV, 0.35A, 3.5V	C-11			
DCR845SG1818	AEI	605A, 1.7kV, 0.35A, 3.5V	C-11			
DCR845SG1919	AEI	605A, 1.8kV, 0.35A, 3.5V	C-11			
DCR845SG1920	AEI	605A, 1.9kV, 0.35A, 3.5V	C-11			
DCR845SG2021	AEI	605A, 2kV, 0.35A, 3.5V	C-11			

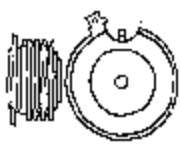
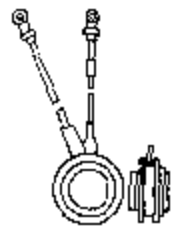

器件型号 Element type	厂名 Manufacturers	材料 Material	用途 Purpose	参数 Parameter	图号 Figure	国内外相似替换器件型号 Replace of similar type	备注 Notes	外形参考图 Reference shape
DCR849SG1414	AEI	545A	1.3kV	0.35A, 3.5V	C-11			 图 C-11
DCR849SG1515	AEI	545A	1.4kV	0.35A, 3.5V	C-11			
DCR849SG1616	AEI	545A	1.5kV	0.35A, 3.5V	C-11			
DCR849SG1717	AEI	545A	1.6kV	0.35A, 3.5V	C-11			
DCR849SG1818	AEI	545A	1.7kV	0.35A, 3.5V	C-11			
DCR849SG1919	AEI	545A	1.8kV	0.35A, 3.5V	C-11			
DCR849SG1920	AEI	545A	1.9kV	0.35A, 3.5V	C-11			
DCR849SG2021	AEI	545A	2kV	0.35A, 3.5V	C-11			
DCR855SG0707	AEI	765A	600V	0.35A, 3.5V	C-11			
DCR855SG0808	AEI	765A	700V	0.35A, 3.5V	C-11			
DCR855SG0909	AEI	765A	800V	0.35A, 3.5V	C-11			
DCR855SG1010	AEI	765A	900V	0.35A, 3.5V	C-11			
DCR855SG1111	AEI	765A	1kV	0.35A, 3.5V	C-11			
DCR855SG1212	AEI	765A	1.1kV	0.35A, 3.5V	C-11			
DCR855SG1313	AEI	765A	1.2kV	0.35A, 3.5V	C-11			
DCR855SG1414	AEI	765A	1.3kV	0.35A, 3.5V	C-11			
DCR855SG1515	AEI	765A	1.4kV	0.35A, 3.5V	C-11			
DCR859SG0707	AEI	600A	600V	0.35A, 3.5V	C-11			 图 C-32
DCR859SG0808	AEI	600A	700V	0.35A, 3.5V	C-11			
DCR859SG0909	AEI	600A	800V	0.35A, 3.5V	C-32			
DCR859SG1010	AEI	600A	900V	0.35A, 3.5V	C-11			
DCR859SG1111	AEI	600A	1kV	0.35A, 3.5V	C-11			
DCR859SG1212	AEI	600A	1.1kV	0.35A, 3.5V	C-11			
DCR859SG1313	AEI	600A	1.2kV	0.35A, 3.5V	C-11			
DCR859SG1414	AEI	600A	1.3kV	0.35A, 3.5V	C-11			
DCR859SG1515	AEI	600A	1.4kV	0.35A, 3.5V	C-11			
DCR859SG1616	AEI	600A	1.5kV	0.35A, 3.5V	C-11			

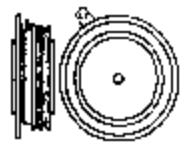
器件型号 Element type	厂名 Manufacturers	材料用途参数 Material Purpose Parameter	图号 Figure	国内外相似替换器件型号 Replace of similar type	备注 Notes	外形参考图 Reference shape
DCR1003SN0101	AEI	2.08kA, 75V, 0.2A, 3.5V	C-5			 图 C-5
DCR1003SN0202	AEI	2.08kA, 150V, 0.2A, 3.5V	C-5			
DCR1003SN0303	AEI	2.08kA, 200V, 0.2A, 3.5V	C-5			
DCR1003SN0404	AEI	2.08kA, 300V, 0.2A, 3.5V	C-5			
DCR1003SN0505	AEI	2.08kA, 400V, 0.2A, 3.5V	C-5			
DCR1003SN0606	AEI	2.08kA, 500V, 0.2A, 3.5V	C-5			
DCR1003SN0707	AEI	2.08kA, 600V, 0.2A, 3.5V	C-5			
DCR1003SN0808	AEI	2.08kA, 700V, 0.2A, 3.5V	C-5			
DCR1003SN0909	AEI	2.08kA, 800V, 0.2A, 3.5V	C-5			
DCR1003SN1010	AEI	2.08kA, 900V, 0.2A, 3.5V	C-5			
DCR1003SN1111	AEI	2.08kA, 1kV, 0.2A, 3.5V	C-5			
DCR1003SN1212	AEI	2.08kA, 1.1kV, 0.2A, 3.5V	C-5			
DCR1003SN1313	AEI	2.08kA, 1.2kV, 0.2A, 3.5V	C-5			
DCR1003SN1515	AEI	2.08kA, 1.4kV, 0.2A, 3.5V	C-5			
DCR1003SN1616	AEI	2.08kA, 1.5kV, 0.2A, 3.5V	C-5			
DCR1003SN1717	AEI	2.08kA, 1.6kV, 0.2A, 3.5V	C-5			
DCR1007SN0101	AEI	1.31kA, 75V, 0.15A, 3.5V	C-5			
DCR1007SN0202	AEI	1.31kA, 150V, 0.15A, 3.5V	C-5			
DCR1007SN0303	AEI	1.31kA, 200V, 0.15A, 3.5V	C-5			
DCR1007SN0404	AEI	1.31kA, 300V, 0.15A, 3.5V	C-5			
DCR1007SN0505	AEI	1.31kA, 400V, 0.15A, 3.5V	C-5			
DCR1007SN0606	AEI	1.31kA, 500V, 0.15A, 3.5V	C-5			
DCR1007SN0707	AEI	1.31kA, 600V, 0.15A, 3.5V	C-5			
DCR1007SN0808	AEI	1.31kA, 700V, 0.15A, 3.5V	C-5			
DCR1007SN0909	AEI	1.31kA, 800V, 0.15A, 3.5V	C-5			
DCR1007SN1010	AEI	1.31kA, 900V, 0.15A, 3.5V	C-5			
DCR1007SN1111	AEI	1.31kA, 1kV, 0.15A, 3.5V	C-5			
DCR1007SN1212	AEI	1.31kA, 1.1kV, 0.15A, 3.5V	C-5			

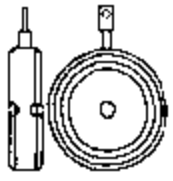

器件型号 Element type	厂名 Manufacturers	材料用途参数 Material Purpose Parameter	图号 Figure	国内外相似替换器件型号 Replace of similar type	备注 Notes	外形参考图 Reference shape
DCR1007SN1313	AEI	1.31kA, 1.2kV, 0.15A, 3.5V	C-5			 图 C-5
DCR1007SN1414	AEI	1.2kA, 1.3kV, 0.15A, 3.5V	C-5			
DCR1007SN1515	AEI	1.2kA, 1.4kV, 0.2A, 3.5V	C-5			
DCR1007SN1616	AEI	1.2kA, 1.5kV, 0.2A, 3.5V	C-5			
DCR1007SN1717	AEI	1.2kA, 1.6kV, 0.2A, 3.5V	C-5			
DCR1007SN1818	AEI	1.2kA, 1.7kV, 0.2A, 3.5V	C-5			
DCR1007SN1919	AEI	1.2kA, 1.8kV, 0.2A, 3.5V	C-5			
DCR1007SN2020	AEI	1.2kA, 1.9kV, 0.2A, 3.5V	C-5			
DCR1007SN2121	AEI	1.2kA, 2kV, 0.2A, 3.5V	C-5			
DCR1007SN2222	AEI	1.2kA, 2.1kV, 0.2A, 3.5V	C-5			
DCR1007SN2323	AEI	1.2kA, 2.2kV, 0.2A, 3.5V	C-5			
DCR1007SN2424	AEI	1.2kA, 2.3kV, 0.2A, 3.5V	C-5			
DCR1007SN2525	AEI	1.2kA, 2.4kV, 0.2A, 3.5V	C-5			
DCR1007SN2626	AEI	1.2kA, 2.5kV, 0.2A, 3.5V	C-5			
DCR1007SN2727	AEI	1.2kA, 2.6kV, 0.2A, 3.5V	C-5			
DCR1007SN2828	AEI	1.2kA, 2.7kV, 0.2A, 3.5V	C-5			
DCR1007SN2929	AEI	1.2kA, 2.8kV, 0.2A, 3.5V	C-5			
DCR1007SN3030	AEI	1.2kA, 2.9kV, 0.2A, 3.5V	C-5			
DCR1018SN3535	AEI	1.2kA, 3.4kV, 0.25A, 3.5V	C-5			
DCR1018SN3636	AEI	1.2kA, 3.5kV, 0.25A, 3.5V	C-5			
DCR1018SN3737	AEI	1.2kA, 3.6kV, 0.25A, 3.5V	C-5			
DCR1018SN3838	AEI	1.2kA, 3.7kV, 0.25A, 3.5V	C-5			
DCR1018SN3939	AEI	1.2kA, 3.8kV, 0.25A, 3.5V	C-5			
DCR1018SN4040	AEI	1.2kA, 3.9kV, 0.25A, 3.5V	C-5			
DCR1018SN4141	AEI	1.2kA, 4kV, 0.25A, 3.5V	C-5			
DCR1018SN4242	AEI	1.2kA, 4.1kV, 0.25A, 3.5V	C-5			
DCR1018SN4343	AEI	1.2kA, 4.2kV, 0.25A, 3.5V	C-5			
DCR1018SN4444	AEI	1.2kA, 4.3kV, 0.25A, 3.5V	C-5			
DCR1018SN4545	AEI	1.2kA, 4.4kV, 0.25A, 3.5V	C-5			

器件型号 Element type	厂名 Manufacturers	材料用途参数 Material Purpose Parameter	图号 Figure	国内外相似替换器件型号 Replace of similar type	备注 Notes	外形参考图 Reference shape
DCR1045SD1313	AEI	855A, 1.2kV, 0.35A, 3.5V				 图 C-6
DCR1045SD1414	AEI	855A, 1.3kV, 0.35A, 3.5V				
DCR1045SD1515	AEI	855A, 1.4kV, 0.35A, 3.5V				
DCR1045SD1616	AEI	855A, 1.5kV, 0.35A, 3.5V				
DCR1045SD1717	AEI	855A, 1.6kV, 0.35A, 3.5V				
DCR1045SD1818	AEI	855A, 1.7kV, 0.35A, 3.5V				
DCR1045SD1919	AEI	855A, 1.8kV, 0.35A, 3.5V				
DCR1045SD1920	AEI	855A, 1.9kV, 0.35A, 3.5V				
DCR1045SD2021	AEI	760A, 2kV, 0.35A, 3.5V				
DCR1049SD1313	AEI	760A, 1.2kV, 0.35A, 3.5V				
DCR1049SD1414	AEI	760A, 1.3kV, 0.35A, 3.5V				
DCR1049SD1515	AEI	760A, 1.4kV, 0.35A, 3.5V				
DCR1049SD1616	AEI	760A, 1.5kV, 0.35A, 3.5V				
DCR1049SD1717	AEI	760A, 1.6kV, 0.35A, 3.5V				
DCR1049SD1818	AEI	760A, 1.7kV, 0.35A, 3.5V				
DCR1049SD1919	AEI	760A, 1.8kV, 0.35A, 3.5V				
DCR1049SD1920	AEI	760A, 1.9kV, 0.35A, 3.5V				
DCR1049SD2021	AEI	760A, 2kV, 0.35A, 3.5V				
DCR1054SD0606	AEI	1.41kA, 500V, 0.35A, 3.5V	C-6			
DCR1054SD0707	AEI	1.41kA, 600V, 0.35A, 3.5V				
DCR1054SD0808	AEI	1.41kA, 700V, 0.35A, 3.5V				
DCR1054SD0909	AEI	1.41kA, 800V, 0.35A, 3.5V				
DCR1054SD1010	AEI	1.41kA, 900V, 0.35A, 3.5V				
DCR1054SD1111	AEI	1.41kA, 1kV, 0.35A, 3.5V				
DCR1054SD1212	AEI	1.41kA, 1.1kV, 0.35A, 3.5V				
DCR1054SD1313	AEI	1.41kA, 1.2kV, 0.35A, 3.5V				
DCR1054SD1414	AEI	1.41kA, 1.3kV, 0.35A, 3.5V				



器件型号 Element type	厂名 Manufacturers	材料用途参数 Material Purpose Parameter	图号 Figure	国内外相似替换器件型号 Replace of similar type	备注 Notes	外形参考图 Reference shape
DCR1054SD1415	AEI	1.41kA, 1.4kV, 0.35A, 3.5V				
DCR1056SD0808	AEI	1.08kA, 700V, 0.35A, 3.5V				
DCR1056SD0909	AEI	1.08kA, 800V, 0.35A, 3.5V				
DCR1056SD1010	AEI	1.08kA, 900V, 0.35A, 3.5V				
DCR1056SD1111	AEI	1.08kA, 1kV, 0.35A, 3.5V				
DCR1056SD1212	AEI	1.08kA, 1.1kV, 0.35A, 3.5V				
DCR1056SD1313	AEI	1.08kA, 1.2kV, 0.35A, 3.5V				
DCR1056SD1414	AEI	1.08kA, 1.3kV, 0.35A, 3.5V				
DCR1056SD1515	AEI	1.08kA, 1.4kV, 0.35A, 3.5V				
DCR1274SD0202	AEI	1.68kA, 100V, 0.4A, 4V				
DCR1274SD0303	AEI	1.68kA, 200V, 0.4A, 4V				
DCR1274SD0404	AEI	1.68kA, 300V, 0.4A, 4V				
DCR1274SD0606	AEI	1.68kA, 500V, 0.4A, 4V				
DCR1274SD0707	AEI	1.68kA, 600V, 0.4A, 4V				
DCR1274SD0808	AEI	1.68kA, 700V, 0.4A, 4V				
DCR1274SD0909	AEI	1.68kA, 800V, 0.4A, 4V				
DCR1274SD1010	AEI	1.68kA, 900V, 0.4A, 4V				
DCR1274SD1111	AEI	1.68kA, 1kV, 0.4A, 4V				
DCR1274SD1212	AEI	1.68kA, 1.1kV, 0.4A, 4V				
DCR1274SD1313	AEI	1.68kA, 1.2kV, 0.4A, 4V				
DCR1274SD1414	AEI	1.68kA, 1.3kV, 0.4A, 4V				
DCR1274SD1515	AEI	1.68kA, 1.4kV, 0.4A, 4V				
DCR1274SD1616	AEI	1.68kA, 1.5kV, 0.4A, 4V				
DCR1278SD2424	AEI	1.55kA, 2.3kV, 0.35A, 3.5V				
DCR1278SD2525	AEI	1.55kA, 2.4kV, 0.35A, 3.5V				
DCR1278SD2626	AEI	1.55kA, 2.5kV, 0.35A, 3.5V				



器件型号 Element type	厂名 Manufacturers	材料用途参数 Material Purpose Parameter	图号 Figure	国内外相似替换器件型号 Replace of similar type	备注 Notes	外形参考图 Reference shape
DCR1278SD2727	AEI	1.55kA, 2.6kV, 0.35A, 3.5V				
DCR1278SD2828	AEI	1.55kA, 2.7kV, 0.35A, 3.5V				
DCR1278SD2929	AEI	1.55kA, 2.8kV, 0.35A, 3.5V				
DCR1278SD3030	AEI	1.55kA, 2.9kV, 0.35A, 3.5V				
DCR1278SD3131	AEI	1.55kA, 3kV, 0.35A, 3.5V				
DCR1278SD3232	AEI	1.55kA, 3.1kV, 0.35A, 3.5V				
DCR1278SD3333	AEI	1.55kA, 3.2kV, 0.35A, 3.5V				
DCR1278SD3434	AEI	1.55kA, 3.3kV, 0.35A, 3.5V				
DCR1278SD3535	AEI	1.55kA, 3.4kV, 0.35A, 3.5V				
DCR1278SD3636	AEI	1.55kA, 3.5kV, 0.35A, 3.5V				
DCR1278SD3737	AEI	1.55kA, 3.6kV, 0.85A, 3.5V				
DCR1284SD2121	AEI	950A, 2kV, 0.4A, 4V				
DCR1284SD2222	AEI	950A, 2.1kV, 0.4A, 4V				
DCR1284SD2323	AEI	950A, 2.2kV, 0.4A, 4V				
DCR1284SD2424	AEI	950A, 2.3kV, 0.4A, 4V				
DCR1284SD2525	AEI	950A, 2.4kV, 0.4A, 4V				
DCR1284SD2626	AEI	950A, 2.5kV, 0.4A, 4V				
DCR1284SD2727	AEI	950A, 2.6kV, 0.4A, 4V				
DCR1284SD2828	AEI	950A, 2.7kV, 0.4A, 4V				
DCR1284SD2929	AEI	950A, 2.8kV, 0.4A, 4V				
DCR1284SD3030	AEI	950A, 2.9kV, 0.4A, 4V				
DCR1284SD3131	AEI	950A, 3kV, 0.4A, 4V				
DCR1284SD3232	AEI	950A, 3.1kV, 0.4A, 4V				
DCR1284SD3333	AEI	950A, 3.2kV, 0.4A, 4V				
DCR1284SD3434	AEI	950A, 3.3kV, 0.4A, 4V				
DCR1284SD3535	AEI	950A, 3.4kV, 0.4A, 4V				
DCR1284SD3636	AEI	950A, 3.5kV, 0.4A, 4V				
DCR1284SD3737	AEI	950A, 3.6kV, 0.4A, 4V				

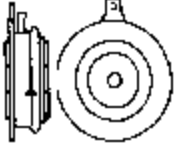

器件型号 Element type	厂名 Manufacturers	材料用途参数 Material Purpose Parameter	图号 Figure	国内外相似替换器件型号 Replace of similar type	备注 Notes	外形参考图 Reference shape
DCR1476SU2424	AEI	2.3kA, 2.3kV, 0.35A, 3.5V	C-10			 图 C-10
DCR1476SU2525	AEI	3kA, 2.4kV, 0.4A, 4V	C-10			
DCR1476SU2626	AEI	3kA, 2.5kV, 0.4A, 4V	C-10			
DCR1476SU2727	AEI	3kA, 2.6kV, 0.4A, 4V	C-10			
DCR1476SU2828	AEI	3kA, 2.7kV, 0.4A, 4V	C-10			
DCR1476SU2929	AEI	3kA, 2.8kV, 0.4A, 4V	C-10			
DCR1476SU3131	AEI	3kA, 3kV, 0.4A, 4V	C-10			
DCR1476SU3333	AEI	3kA, 3.2kV, 0.4A, 4V	C-10			
DCR1476SU3434	AEI	2.75kA, 3.3kV, 0.4A, 4V	C-10			
DCR1476SU3535	AEI	2.3kA, 3.4kV, 0.4A, 4V	C-10			
DCR1476SU3636	AEI	2.3kA, 3.5kV, 0.4A, 4V	C-10			
DCR1476SU3737	AEI	2.3kA, 3.6kV, 0.4A, 4V	C-10			
DCR1476SU3838	AEI	2.3kA, 3.7kV, 0.4A, 4V	C-10			
DCR1476SU3939	AEI	2.3kA, 3.8kV, 0.4A, 4V	C-10			
DCR1478SU3232	AEI	3kA, 3.1kV, 0.4A, 4V	C-10			
DCR1478SU3333	AEI	2.75kA, 3.2kV, 0.4A, 4V	C-10			
DCR1478SU3535	AEI	2.75kA, 3.4kV, 0.4A, 4V	C-10			
DCR1478SU3636	AEI	2.75kA, 3.5kV, 0.4A, 4V	C-10			
DCR1478SU3737	AEI	2.75kA, 3.6kV, 0.4A, 4V	C-10			
DCR1478SU3838	AEI	2.75kA, 3.7kV, 0.4A, 4V	C-10			
DCR1478SU3939	AEI	2.75kA, 3.8kV, 0.4A, 4V	C-10			
DCR1478SU4040	AEI	2.75kA, 3.9kV, 0.4A, 4V	C-10			
DCR1478SU4141	AEI	2.75kA, 4kV, 0.4A, 4V	C-10			
DCR1478SU4242	AEI	2.75kA, 4.1kV, 0.4A, 4V	C-10			
DDA25-40...-160	CHN	25A, 0.4-1.6kV, 0.15A, 3V				
DDA40-40...-160	CHN	40A, 0.4-1.6kV, 0.15A, 3V				
DDA55-40...-160	CHN	55A, 0.4-1.6kV, 0.15A, 3V				

器件型号 Element type	厂名 Manufacturers	材料用途参数 Material Purpose Parameter	图号 Figure	国内外相似替换器件型号 Replace of similar type	备注 Notes	外形参考图 Reference shape
DDA90-40...-160	CHN	90A, 0.4~1.6kV, 0.15A, 3V				 图 E-6
DDA110-40...-160	CHN	110A, 0.4~1.6kV, 0.15A, 3V				
DDA130-40...-160	CHN	130A, 0.4~1.6kV, 0.15A, 3V				
DDA160-40...-160	CHN	160A, 0.4~1.6kV, 0.15A, 3V				
DDA200-40...-160	CHN	200A, 0.4~1.6kV, 0.15A, 3V				
DDA250-40...-160	CHN	250A, 0.4~1.6kV, 0.15A, 3V				
DDC25-40...-160	CHN	25A, 0.4~1.6kV, 0.15A, 3V				
DDC40-40...-160	CHN	40A, 0.4~1.6kV, 0.15A, 3V				
DDC55-40...-160	CHN	55A, 0.4~1.6kV, 0.15A, 3V				
DDC90-40...-160	CHN	90A, 0.4~1.6kV, 0.15A, 3V				
DDC110-40...-160	CHN	110A, 0.4~1.6kV, 0.15A, 3V				
DDC130-40...-160	CHN	130A, 0.4~1.6kV, 0.15A, 3V				
DDC160-40...-160	CHN	160A, 0.4~1.6kV, 0.15A, 3V				
DDC200-40...-160	CHN	200A, 0.4~1.6kV, 0.15A, 3V				
DDC250-40...-160	CHN	250A, 0.4~1.6kV, 0.15A, 3V				
DDS25-40...-160	CHN	25A, 0.4~1.6kV, 0.15A, 3V				
DDS40-40...-160	CHN	40A, 0.4~1.6kV, 0.15A, 3V				
DDS55-40...-160	CHN	55A, 0.4~1.6kV, 0.15A, 3V				
DDS90-40...-160	CHN	90A, 0.4~1.6kV, 0.15A, 3V				
DDS110-40...-160	CHN	110A, 0.4~1.6kV, 0.15A, 3V				
DDS130-40...-160	CHN	130A, 0.4~1.6kV, 0.15A, 3V				
DDS160-40...-160	CHN	160A, 0.4~1.6kV, 0.15A, 3V				
DDS200-40...-160	CHN	200A, 0.4~1.6kV, 0.15A, 3V				
DDS250-40...-160	CHN	250A, 0.4~1.6kV, 0.15A, 3V				
DK1001F	THE	100A, 100V, 0.15A, 3V	E-6			
DK1002F	THE	100A, 200V, 0.15A, 3V	E-6			
DK1004F	THE	100A, 400V, 0.15A, 3V	E-6			
DK1006F	THE	100A, 600V, 0.15A, 3V	E-6			

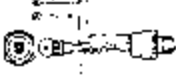

器件型号 Element type	厂名 Manufacturers	材料用途参数 Material Purpose Parameter	图号 Figure	国内外相似替换器件型号 Replace of similar type	备注 Notes	外形参考图 Reference shape
DK1008F	THE	100A, 800V, 0.15A, 3V	E-6			 图 E-6
DK1010F	THE	110A, 1kV, 0.15A, 3V	E-6			
DK1012F	THE	110A, 1.2kV, 0.15A, 3V	E-6			
DK1016F	THE	110A, 1.6kV, 0.15A, 3V	E-6			
DK1101F	THE	110A, 100V, 0.15A, 3V	E-6			 图 F-91
DK1102F	THE	110A, 200V, 0.15A, 3V	E-6			
DK1104F	THE	110A, 400V, 0.15A, 3V	E-6			
DK1106F	THE	110A, 600V, 0.15A, 3V	E-6			
DK1108F	THE	110A, 800V, 0.15A, 3V	E-6			
DK1110F	THE	110A, 1kV, 0.15A, 3V	E-6			
DK1112F	THE	110A, 1.2kV, 0.15A, 3V	E-6			
DK1301FA, FQ	THE	GTO, 130A, 100V, 0.15A, 3V	E-6			
DK1301FB, FY	THE	130A, 100V, 0.15A, 3V	E-6			
DK1302F	THE	130A, 200V, 0.15A, 3V	E-6			
DK1304F	THE	130A, 400V, 0.15A, 3V	E-6			
DK1306F	THE	130A, 600V, 0.15A, 3V	E-6			
DK1308F	THE	130A, 800V, 0.15A, 3V	E-6			
DK2702F	THE	270A, 200V, 0.2A, 3V	F-91			 图 B-35
DK2704F	THE	270A, 400V, 0.2A, 3V	F-91			
DK2706F	THE	270A, 600V, 0.2A, 3V	F-91			
DK2708F	THE	270A, 800V, 0.2A, 3V	F-91			
DK2710F	THE	270A, 1kV, 0.2A, 3V	F-91			
DRA01B...E		50Hz-Thy 0.1A, 100~400V, 0.0002A	B-35	BRX51, BRX52, BRX53, BRX54, BRX55, BRX56, BRY55-..., MCR100-..., TAG06-...		

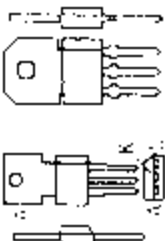
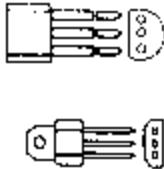
器件型号 Element type	厂名 Manufacturers	材料用途参数 Material Purpose Parameter	图号 Figure	国内外相似替换器件型号 Replace of similar type	备注 Notes	外形参考图 Reference shape
DRA2A	TSA	2A, 50V, 0.0002A, 0.8V	B-87	ECG5453		 图 B-87 图 B-15
DRA2E	TSA	2A, 400V, 0.0002A, 0.8V	B-87	ECG5457		
DRA2F	TSA	2A, 500V, 0.0002A, 0.8V	B-87			
DRA2G	TSA	2A, 600V, 0.0002A, 0.8V	B-87			
DRA2T		20A, 500V	B-15			
DRA2TB...TG		50Hz-Thy 2A, 100-600V, 0.0002A	B-98	C106-..., TAG106-...		
DRA03A	TSA	0.3A, 50V, 0.0005A, 0.8V	B-36			
DRA03B	TSA	0.3A, 100V, 0.0005A, 0.8V	B-36			
DRA03C	TSA	0.3A, 200V, 0.0005A, 0.8V	B-36			
DRA03D	TSA	0.3A, 300V, 0.0005A, 0.8V	B-36			
DRA03E	TSA	0.3A, 400V, 0.0005A, 0.8V	B-36			
DRA03F	TSA	0.3A, 500V, 0.0005A, 0.8V	B-36			
DRA03T		9A, 500V				
DRA03TB...TG		50Hz-Thy 0.3A, 100-600V, 0.0002A	B-35	BHX51, BHX52, BHX53, BHX54, BHX55, BHX56, BRY55-..., MCR100-..., TAG06-...		 图 B-98 图 B-36
DRA3B		50Hz-Thy 3A, 100V	B-98	C108 A, TAG108-100		
DRA3C	TSA	50Hz-Thy 3A, 200V, 0.005A, 1.5V	B-87	C108-B, TAG108-200		
DRA3D		50Hz-Thy 3A, 300V	B-98	C108-C, TAG108-300		
DRA3E	TSA	50Hz-Thy 3A, 400V, 0.005A, 1.5V	B-87	C108-D, TAG108-400		
DRA3F	TSA	50Hz-Thy 3A, 500V, 0.005A, 1.5V	B-87	C108-E, TAG108-500		
DRA3G	TSA	50Hz-Thy 3A, 600V, 0.005A, 1.5V	B-87	C108-M, TAG108-600		
DRA05		9A, 500V				
DRA5		80A, 700V	B-15			
DRA5B	TSA	50Hz-Thy 5A, 100V, 0.04A, 1.5V	B-90	ECG5462, MCR218-100, TAG625-100, TIC116-100		
DRA5C	TSA	50Hz-Thy 5A, 200V, 0.04A, 1.5V	B-90	ECG5463, MCR218-200, TAG625-200, TIC116-200		
DRA5E	TSA	50Hz-Thy 5A, 400V, 0.04A, 1.5V	B-90	ECG5465, MCR218-400, TAG625-400, TIC116-400		
DRA5G	TSA	50Hz-Thy 5A, 600V, 0.04A, 1.5V	B-90	ECG5466, MCR218-600, TAG625-600, TIC116-600		









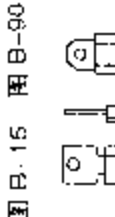

器件型号 Element type	厂名 Manufacturers	材料用途参数 Material Purpose Parameter	图号 Figure	国内外相似替换器件型号 Replace of similar type	备注 Notes	外形参考图 Reference shape
DRA6		120A, 700V	B-15			
DRA8B	TSA	50Hz-Thy 8A, 100V, 0.04A, 1.5V	B-90	ECG5552, TAG680-100, TIC122-100, TIC126-100		
DRA8C	TSA	50Hz-Thy 8A, 200V, 0.04A, 1.5V	B-90	ECG5552, TAG680-200, TIC122-200, TIC126-200		
DRA8E	TSA	50Hz-Thy 8A, 400V, 0.04A, 1.5V	B-90	TAG680-400, TIC122-400, TIC126-400		
DRA8G	TSA	50Hz-Thy 8A, 600V, 0.04A, 1.5V	B-90	ECG5556, TAG680-600, TIC122-600, TIC126-600		
DRB2B	TSA	SCR-H 2A, 100V, 0.0015A, 0.8V	B-89	S3060A		
DRB2C	TSA	SCR-H 2A, 200V, 0.0015A, 0.8V	B-89	S3060B		
DRB2D		SCR-H 2A, 300V, 0.0015A	B-98	S3060C		
DRB2E	TSA	SCR-H 2A, 400V, 0.0015A, 0.8V	B-89	S3060D		
DRB3B	TSA	SCR-H 3A, 100V, 0.0002A, 0.8V	B-87	ECG5454, S5800A, S5801A, S5802A		
DRB3C	TSA	SCR-H 2A, 200V, 0.0002A, 0.8V	C-25	ECG5455, S5800B, S5801B, S5802B		
DRB3D		SCR-H 3A, 300V	B-98	S5800C, S5801C, S5802C		
DRB3E	TSA	SCR-H 2A, 400V, 0.0002A, 0.8V	B-87	ECG5457, S5800D, S5801D, S5802D		
DRC2E	TSA	50Hz-Thy 2A, 400V, 0.0002A, 0.8V	B-97			
DRC3E	TSA	50Hz-Thy 2A, 400V, 0.0002A, 0.8V	B-90	BSIC1026, ECG5465, TAG620-400		
DRD3B...G		50Hz-Thy 3A, 100-600V, 0.015A	D-11	TAG620 ...		
DRE3B...G		50Hz-Thy 3A, 100-600V, 0.0002A	B-98	C108..., TAG108...		
DST1	PHI	SBS, 0.175A, 10V	B-77			
DT1-02...-12		50Hz-Thy 1.3A, 0.2-1.2kV, 0.015A	B-108			
DT18F200	AEG	25.5A, 200V, 0.08A, 2.7V	H-13			
DT18F400	AEG	25.5A, 400V, 0.08A, 2.7V	H-13			
DT18F600	AEG	25.5A, 600V, 0.08A, 2.7V	H-13			
DT18F800	AEG	25.5A, 800V, 0.08A, 2.7V	H-13			
DT18F900	AEG	25.5A, 900V, 0.08A, 2.7V	H-13			
DT18F1000	AEG	25.5A, 1kV, 0.08A, 2.7V	H-13			
DT18F1100	AEG	25.5A, 1.1kV, 0.08A, 2.7V	H-13			

图 B-77 图 B-108

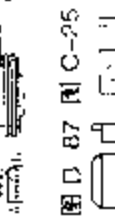
图 H-13

器件型号 Element type	厂名 Manufacturers	材料用途参数 Material Purpose Parameter	图号 Figure	国内外相似替换器件型号 Replace of similar type	备注 Notes	外形参考图 Reference shape
DT18F1200	AEG	25.5A, 1.2kV, 0.08A, 2.7V	H-13			 图 H-13
DT18N400	AEG	25.5A, 400V, 0.08A, 2.7V	H-13			
DT18N600	AEG	25.5A, 600V, 0.08A, 2.7V	H-13			
DT18N800	AEG	25.5A, 800V, 0.08A, 2.7V	H-13			
DT18N1100	AEG	25.5A, 1.1kV, 0.08A, 2.7V	H-13			
DT18N1200	AEG	25.5A, 1.2kV, 0.08A, 2.7V	H-13			
DT18N1400	AEG	25.5A, 1.4kV, 0.08A, 2.7V	H-13			
DT25F200	AEG	32A, 200V, 0.08A, 2.7V	H-13			
DT25F400	AFG	32A, 400V, 0.08A, 2.7V	H-13			
DT25F600	AEG	32A, 600V, 0.08A, 2.7V	H-13			
DT25F800	AEG	32A, 800V, 0.08A, 2.7V	H-13			
DT25F900	AEG	32A, 900V, 0.08A, 2.7V	H-13			
DT25F1000	AEG	32A, 1kV, 0.08A, 2.7V	H-13			
DT25F1100	AEG	32A, 1.1kV, 0.08A, 2.7V	H-13			
DT25N400	AEG	32A, 400V, 0.08A, 2.7V	H-13			
DT25N600	AEG	32A, 600V, 0.08A, 2.7V	H-13			
DT25N800	AEG	32A, 800V, 0.08A, 2.7V	H-13			
DT25N1100	AEG	32A, 1.1kV, 0.08A, 2.7V	H-13			
DT25N1200	AEG	32A, 1.2kV, 0.08A, 2.7V	H-13			
DT25N1400	AEG	32A, 1.4kV, 0.08A, 2.7V	H-13			
DT35F200	AEG	63A, 200V, 0.15A, 1.4V	H-13			
DT35F400	AEG	63A, 400V, 0.15A, 1.4V	H-13			
DT35F600	AEG	63A, 600V, 0.15A, 1.4V	H-13			
DT35F800	AEG	63A, 800V, 0.15A, 1.4V	H-13			
DT35F900	AEG	63A, 900V, 0.15A, 1.4V	H-13			
DT35F1000	AEG	63A, 1kV, 0.15A, 1.4V	H-13			
DT35F1100	AEG	63A, 1.1kV, 0.15A, 1.4V	H-13			

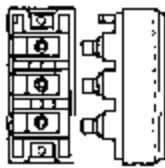

器件型号 Element type	厂名 Manufacturers	材料用途参数 Material Purpose Parameter	图号 Figure	国内外相似替换器件型号 Replace of similar type	备注 Notes	外形参考图 Reference shape
DT35F1200	AEG	63A, 1.2kV, 0.15A, 1.4V	H-13			
DT45F200	AEG	76A, 200V, 0.15A, 1.4V	H-13			
DT45F400	AEG	76A, 400V, 0.15A, 1.4V	H-13			
DT45F600	AEG	76A, 600V, 0.15A, 1.4V	H-13			
DT45F800	AEG	76A, 800V, 0.15A, 1.4V	H-13			
DT45F900	AEG	76A, 900V, 0.15A, 1.4V	H-13			
DT45F1000	AEG	76A, 1kV, 0.15A, 1.4V	H-13			
DT45F1100	AEG	76A, 1.1kV, 0.15A, 1.4V	H-13			
DT45F1200	AEG	76A, 1.2kV, 0.15A, 1.4V	H-13			
DT45N400	AEG	63A, 400V, 0.12A, 1.4V	H-13			
DT45N600	AEG	63A, 600V, 0.12A, 1.4V	H-13			
DT45N800	AEG	63A, 800V, 0.12A, 1.4V	H-13			
DT45N1100	AEG	63A, 1.1kV, 0.12A, 1.4V	H-13			
DT45N1200	AEG	63A, 1.2kV, 0.12A, 1.4V	H-13			
DT45N1400	AEG	63A, 1.4kV, 0.12A, 1.4V	H-13			
DT45N1500	AEG	63A, 1.5kV, 0.12A, 1.4V	H-13			
DT60N400	AEG	76A, 400V, 0.12A, 1.4V	H-13			
DT60N600	AEG	76A, 600V, 0.12A, 1.4V	H-13			
DT60N800	AEG	76A, 800V, 0.12A, 1.4V	H-13			
DT60N1100	AEG	76A, 1.1kV, 0.12A, 1.4V	H-13			
DT60N1200	AEG	76A, 1.2kV, 0.12A, 1.4V	H-13			
DT60N1500	AEG	76A, 1.5kV, 0.12A, 1.4V	H-13			
DT95N400	AEG	95A, 400V, 0.12A, 1.4V	H-13			
DT95N600	AEG	95A, 600V, 0.12A, 1.4V	H-13			
DT95N800	AEG	95A, 800V, 0.12A, 1.4V	H-13			
DT95N1100	AEG	95A, 1.1kV, 0.12A, 1.4V	H-13			







图 H-13

器件型号 Element type	厂名 Manufacturers	材料用途参数 Material Purpose Parameter	图号 Figure	国内外相似替换器件型号 Replace of similar type	备注 Notes	外形参考图 Reference shape
DT95N1200	AEG	95A, 1.2kV, 0.12A, 1.4V	H-13			 图 H-13 图 D-36
DTA05B	TSA	SCR-D 0.05A, 100V, 0.015A, 2.3V	B-36			
DTA05C	TSA	SCR-D 0.05A, 200V, 0.015A, 2.3V	B-36			
DTA05D	TSA	SCR-D 0.5A, 300V, 0.015A	B-35			
DTA05E	TSA	SCR-D 0.05A, 400V, 0.015A, 2.3V	B-36			
DTA1		SCR-D 8A, 400V				
DTA2		SCR-D 12A, 400V				
DTA2B	TSA	SCR-D 2A, 100V, 0.015A, 2.3V	B-21	ECG5629, TAG137-100, TAG138-100		
DTA2C	TSA	SCR-D 2A, 200V, 0.015A, 2.3V	B-21	ECG5629, TAG137-200, TAG138-200		
DTA2D	TSA	SCR-D 2A, 300V, 0.015A	B-98	TAG137-300, TAG138-300		
DTA2E	TSA	SCR-D 2A, 400V, 0.015A, 2.3V	B-21	FCG5629, TAG137-400, TAG138-400		
DTA3C	TSA	SCR-D 3A, 200V, 0.015A, 2.3V	B-89	ECG5629, Z0409B, Z0410B		
DTA3D	TSA	SCR-D 3A, 300V, 0.045A	B-98	Z0409C, Z0410C		
DTA3E	TSA	SCR-D 3A, 400V, 0.015A, 2.3V	B-89	ECG5629, Z0409D, Z0410D		
DTA3F	TSA	SCR-D 3A, 500V, 0.015A, 2.3V	B-89	Z0409E, Z0410E		
DTA3G	TSA	SCR-D 3A, 600V, 0.015A, 2.3V	B-89	Z0409M, Z0410M		
DTA6C...G(N)		SCR-D 6A, 200-600V, 0.05A	B-11	MAC216A..., T2500..., TAG220 ...		 图 B-98 图 B-89
DTA08E		SCR-D 0.8A, 400V, 0.01A, 0.01A	B-35	MAC94(A)-6, MAC95(A)-6, MAC96(A)-6		
DTA8C	TSA	SCR-D 8A, 200V, 0.05A, 3V	B-10	ECG5633, MAC222-A4, MAC228-A4, TIC225B		
DTA8D		SCR-D 8A, 300V	B-11			
DTA8E	TSA	SCR-D 8A, 400V, 0.05A, 3V	B-10	ECG5635, MAC222-A6, MAC228-A6, TIC225D		
DTA8F	TSA	SCR-D 8A, 500V, 0.05A, 3V	B-10			
DTA8G	TSA	SCR-D 8A, 600V, 0.05A, 3V	B-10	ECG5637, MAC222-A8, MAC228-A8, TIC225M		 图 B-11 图 B-10
DTA10C	TSA	SCR-D 10A, 200V, 0.05A, 3V	B-10	ECG5633, BTA22-B, TAG250-200, TAG251 200		
DTA10D		SCR-D 10A, 300V, 0.06A	B-11	BTA22-C, TAG250-300, TAG251-300		

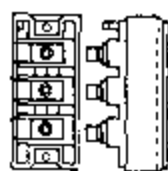
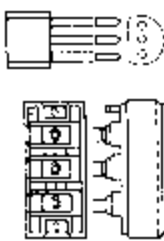
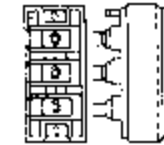
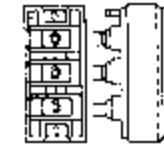
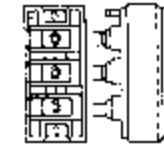
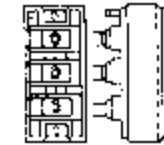
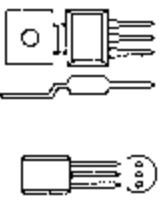
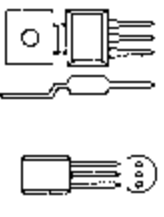
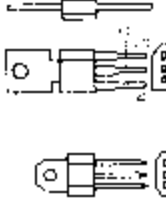
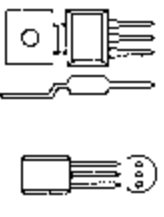
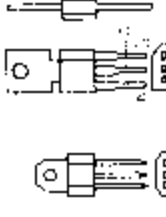
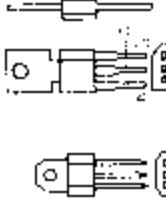
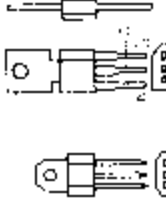
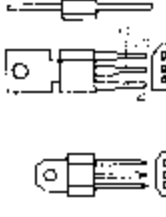
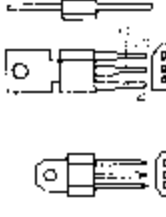
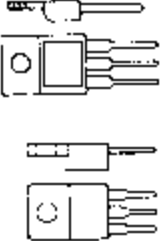
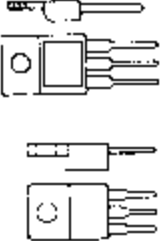
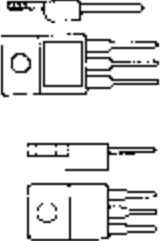
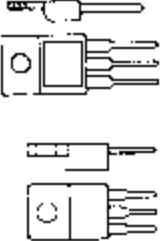
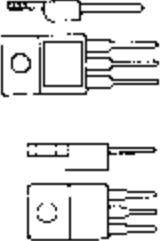
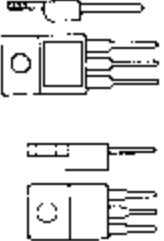
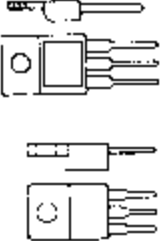
器件型号 Element type	厂名 Manufacturers	材料用途参数 Material Purpose Parameter	图号 Figure	国内外相似替换器件型号 Replace of similar type	备注 Notes	外形参考图 Reference shape
DTA10E	TSA	SCR-D 10A, 100V, 0.05A, 3V	B-10	BTA22-D, FCG5635, TAG250-400, TAG251-400		
DTA10F	TSA	SCR-D 10A, 500V, 0.05A, 3V	B-10	BTA22-E, ECG5637, TAG250-500, TAG251-500		
DTA10G	TSA	SCR-D 10A, 600V, 0.05A, 3V	B-10	BTA22-M, LCC5637, TAG250-600, TAG251-600		
DTA12C	TSA	SCR-D 12A, 200V, 0.05A, 3V	B-10	ECG56004, SC149B, TIC236B		
DTA12D	TSA	SCR-D 12A, 300V	B-11	SC149C, TIC236C		
DTA12E	TSA	SCR-D 12A, 400V, 0.05A, 3V	B-10	BT162-400, ECG56006, SC149D, TIC236D		
DTA12F	TSA	SCR-D 12A, 500V, 0.05A, 3V	B-10	BT162-500, ECG56008, SC149E, TIC236E		
DTA12G	TSA	SCR-D 12A, 600V, 0.05A, 3V	B-10	BT162-600, ECG56008, SC149M, TIC236M		
DTA16C	TSA	SCR-D 16A, 200V, 0.05A, 3V	B-10	ECG56004, MAC15-4, SC151B, TIC246B		
DTA16D	TSA	SCR-D 16A, 300V	B-11	SC151C, MAC15-5, TIC246C		
DTA16E	TSA	SCR-D 16A, 400V, 0.05A, 3V	B-10	ECG56006, MAC15-6, SC151D, TIC246D		
DTA16F	TSA	SCR-D 16A, 500V, 0.05A, 3V	B-10	LCC56008, MAC15-7, SC151E, TIC246E		
DTA16G	TSA	SCR-D 16A, 600V, 0.05A, 3V	B-10	ECG56008, MAC15-8, SC151M, TIC246M		
DTA25C...G		SCR-D 25A, 200-600V, 0.05A	G-12	MAC525(A)		
CTB3		SCR-D 27A, 600V				
CTB3B...G		SCR-D 3A, 100-600V, 0.03A	B-98	TAG136-..., TAG137-...		
DTB8C	TSA	SCR-D 8A, 200V, 0.05A, 2V	B-10	ECG5645, T2800B, T2850B, TAG224-200		
DTB8D	TSA	SCR-D 8A, 300V	B-11	T2800C, T2850C, TAG224-300		
DTB8E	TSA	SCR-D 8A, 400V, 0.05A, 2V	C-23	ECG5645, T2800D, T2850D, TAG224-400		
DTB8F	TSA	SCR-D 8A, 500V, 0.05A, 2V	B-10	ECG5645, T2800E, T2850E, TAG224-500		
DTB8G	TSA	SCR-D 8A, 600V, 0.05A, 2V	B-10	ECG5645, T2800M, T2850M, TAG224-600		
DTB10C	TSA	SCR-D 10A, 200V, 0.05A, 2V	B-44	ECG5645, BTA22B, TAG250-200, TAG252-200		
DTB10D	TSA	SCR-D 10A, 300V	B-11	BTA22C, TAG250-300, TAG252-300		

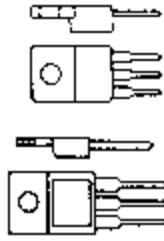
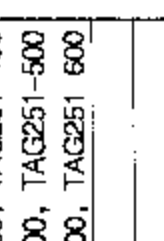
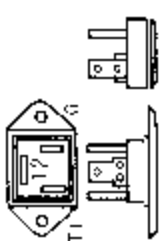
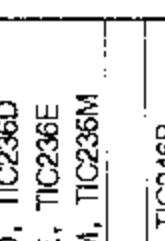
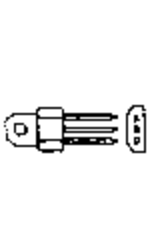
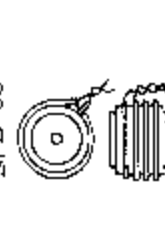
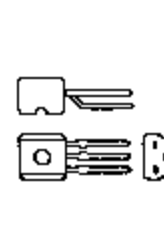
器件型号 Element type	厂名 Manufacturers	材料用途参数 Material Purpose Parameter	图号 Figure	国内外相似替换器件型号 Replace of similar type	备注 Notes	外形参考图 Reference shape
DTB10E	TSA	SCR-D 10A, 400V, 0.05A, 2V	B-44	BTA22D, ECG5645, TAG250-400, TAG252-400		 图 B-44
DTB10F	TSA	SCR-D 10A, 500V, 0.05A, 2V	B-44	BTA22E, ECG5645, TAG250-500, TAG252-500		
DTB10G	TSA	SCR-D 10A, 600V, 0.05A, 2V	B-44	BTA22M, ECG5645, TAG250-600, TAG252-600		
DTB12C...G		SCR-D 12A, 200-600V	B-11	BTA23..., TAG255-..., TAG257-...		 图 B-44
DTB16C	TSA	SCR-D 16A, 200V, 0.05A, 3V	B-44	ECG5679, TIC253B		
DTB16D		SCR-D 16A, 300V	D-10	TIC253C		
DTB16E	TSA	SCR-D 16A, 400V, 0.05A, 3V	B-44	ECG5679, TIC253D		
DTB16F	TSA	SCR-D 16A, 500V, 0.05A, 3V	B-44	ECG5679, TIC253E		
DTB16G	TSA	SCR-D 16A, 600V, 0.05A, 3V	B-44	ECG5679, TIC253M		
DTC8C...G(N)		SCR-D 8A, 200-600V, 0.05A	B-11	T2800..., T2850..., TAG224-...		 图 B-11
DTC10C...G(N)		SCR-D 10A, 200-600V, 0.05A	B-11	BTA22..., TAG250-..., TAG251-...		
DTC12C...G(N)		SCR-D 12A, 200-600V, 0.05A	B-11	BTA23-..., BT138-..., TAG255-..., TAG256-...		
DTC16C	TSA	SCR-D 16A, 200V, 0.05A, 3V	B-44	ECG5679, TIC253B		
DTC16D		SCR-D 16A, 300V	D-10	TIC253C		
DTC16E	TSA	SCR-D 16A, 400V, 0.05A, 3V	B-44	ECG5679, TIC253D		
DTC16F	TSA	SCR-D 16A, 500V, 0.05A, 3V	B-44	ECG5679, TIC253E		
DTC16G	TSA	SCR-D 16A, 600V, 0.05A, 3V	B-44	ECG5679, TIC253M		 图 D-10
DTC25-40...-160	CHN	25A, 0.4-1.6kV, 0.15A, 3V				
DTC40-40...-160	CHN	40A, 0.4-1.6kV, 0.15A, 3V				
DTC55-40...-160	CHN	55A, 0.4-1.6kV, 0.15A, 3V				
DTC90-40...-160	CHN	90A, 0.4-1.6kV, 0.15A, 3V				
DTC110 40...-160	CHN	110A, 0.4-1.6kV, 0.15A, 3V				
DTC130-40...-160	CHN	130A, 0.4-1.6kV, 0.15A, 3V				
DTC160-40...-160	CHN	160A, 0.4-1.6kV, 0.15A, 3V				
DTC200-40...-160	CHN	200A, 0.4-1.6kV, 0.15A, 3V				
DTC250-40...-160	CHN	250A, 0.4-1.6kV, 0.15A, 3V				

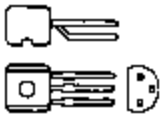
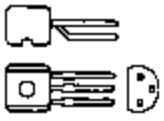
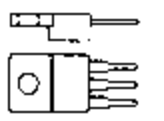
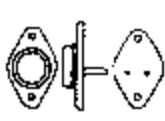

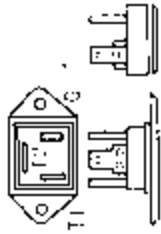
器件型号 Element type	厂名 Manufacturers	材料用途参数 Material Purpose Parameter	图号 Figure	国内外相似替换器件型号 Repace of similar type	备注 Notes	外形参考图 Reference shape
DTE16E...G	Triac	16A, 400-600V, 0.08A	G-12	MAC515(A)..., MAC525(A)...		
DTM6C...G(N)	SCR-D	6A, 200-600V, 0.05A	B-11	MAC210... , TAC420... , T2500...		
DTM8C...G(N)	SCR-D	8A, 200-600V, 0.05A	B-11	TAG425... , TAG451... , T2800... , T2850...		
DTM10C...G(N)	SCR-D	10A, 200-600V, 0.05A	B-11	TAG456... , TAG457... , BTA22...		
DTM12C...G(N)	SCR-D	12A, 200-600V, 0.05A	B-11	BTA23... , BT138... , TAC480... , TAG481...		
DTN6	SCR-D	400V, 60A	B-104			
DTN8	SCR-D	600V, 80A	B-104			
DTN12	SCR-D	600V, 120A	B-104			
DTS25-40...-160	CHN	25A, 0.4-1.6KV, 0.15A, 3V				
DTS40-40...-160	CHN	40A, 0.4-1.6KV, 0.15A, 3V				
DTS55-40...-160	CHN	55A, 0.4-1.6KV, 0.15A, 3V				
DTS90-40...-160	CHN	90A, 0.4-1.6KV, 0.15A, 3V				
DTS110-40...-160	CHN	110A, 0.4-1.6KV, 0.15A, 3V				
DTS130-40...-160	CHN	130A, 0.4-1.6KV, 0.15A, 3V				
DTS160-40...-160	CHN	160A, 0.4-1.6KV, 0.15A, 3V				
DTS200-40...-160	CHN	200A, 0.4-1.6KV, 0.15A, 3V				
DTS250-40...-160	CHN	250A, 0.4-1.6KV, 0.15A, 3V				



图 B-11



图 B-104

D 类外形参考图索引

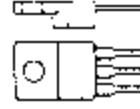

图 A-1

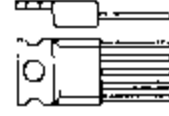

图 B-10

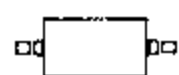

图 B-11

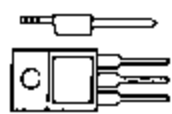

图 B-15

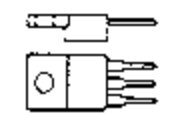

图 B-21

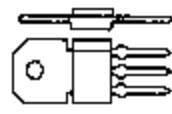

图 B-34

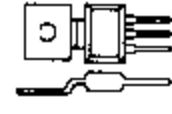

图 B-35

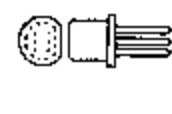

图 B-36



图 B-44

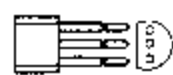

图 B-77

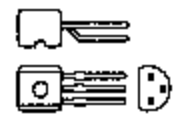

图 B-87

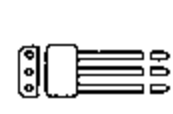

图 B-89

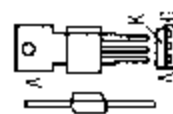

图 B-90

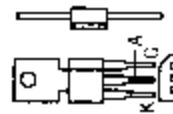

图 B-97

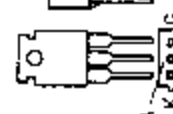

图 B-98

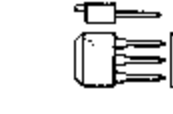

图 B-104



图 B-108

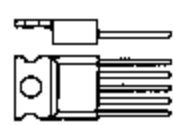

图 C-1

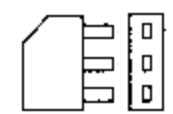

图 C-5



图 C-6



图 C-7



图 C-10



图 C-11



图 C-23



图 C-25

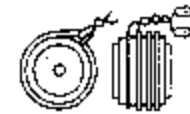

图 C-32



图 D-10



图 E-6





图 E-12

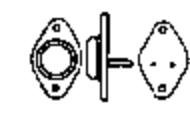

图 H-13

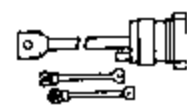

图 F-1

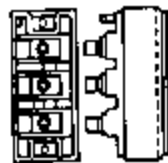

图 F-91



图 G-1



图 G-2



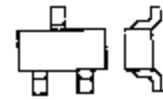

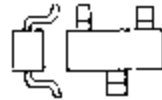

图 G-12

器件型号 Element type	厂名 Manufacturers	材料用途参数 Material Purpose Parameter	图号 Figure	国内外相似替换器件型号 Replace of similar type	备注 Notes	外形参考图 Reference shape
E0100AD	TAG	SCR-H 0.5A, 100V, 20 μ A, 0.8V	B-65			 图 B-65
E0100FD	TAG	SCR-H 0.5A, 60V, 20 μ A, 0.8V	B-65			
E0100YD	TAG	SCR-H 0.5A, 30V, 20 μ A, 0.8V	B-65			
E0102AA	TAG	SCR-H 0.5A, 100V, 200 μ A, 0.8V	B-36	BTX46, BRX47, BRX51, BRX52, TAG62A...Y		 图 B-36
E0102AB	TAG	SCR-H 0.5A, 100V, 200 μ A, 0.8V	B-44	BRX46, BRX47, BRX51, BRX52, TAG62A...Y		
E0102AD	TAG	SCR-H 0.5A, 100V, 200 μ A, 0.8V	B-65	BRX46, BRX47, BRX51, BRX52, TAG62A...Y		
E0102FA	TAG	SCR-H 0.5A, 60V, 200 μ A, 0.8V	B-36	BRX46, BRX47, BRX51, BRX52, TAG62A...Y		
E0102FB	TAG	SCR-H 0.5A, 60V, 200 μ A, 0.8V	B-44	BRX46, BRX47, BRX51, BRX52, TAG62A...Y		
E0102FD	TAG	SCR-H 0.5A, 60V, 200 μ A, 0.8V	B-65	BRX46, BRX47, BRX51, BRX52, TAG62A...Y		
E0102FG	TAG	SCR-H 0.65A, 60V, 0.0002A	B-62	BRX46, BRX47, BRX51, BRX52, TAG62A...Y		
E0102YA	TAG	SCR-H 0.5A, 30V, 200 μ A, 0.8V	B-36	BRX46, BRX47, BRX51, BRX52, TAG62A...Y		
E0102YB	TAG	SCR-H 0.5A, 30V, 200 μ A, 0.8V	B-44	BRX46, BRX47, BRX51, BRX52, TAG62A...Y		
E0102YD	TAG	SCR-H 0.5A, 30V, 200 μ A, 0.8V	B-65	BRX46, BRX47, BRX51, BRX52, TAG62A...Y		
E0102YG(9004)	SCR-H	0.65A, 30V, 0.0002A	B-62	BRX46, BRX47, BRX51, BRX52, TAG62A...Y		
EASD83-4		30A, 45V		MBR3045PT		 图 B-44
EC103A	TCE	0.8A, 100V, 200 μ A, 0.8V	B-36	ECG5402, MCR104, SK3638, SK5402, 2N5062		
EC103A1	TCE	0.8A, 100V, 12 μ A, 0.8V	B-36	MCR22-3		 图 B-62
EC103A2	TCE	0.8A, 100V, 50 μ A, 0.8V	B-36	MCR22-3		
EC103A3	TCE	0.8A, 100V, 500 μ A, 0.8V	B-36	MCR22-3		
EC103B	TCE	0.8A, 200V, 200 μ A, 0.8V	B-36	ECG5404, MCR120, SK3627, SK5404, 2N5064		
EC103B1	TCE	0.8A, 200V, 12 μ A, 0.8V	B-36	MCR22-4		
EC103B2	TCE	0.8A, 200V, 50 μ A, 0.8V	B-36	MCR22-4		
EC103B3	TCE	0.8A, 200V, 500 μ A, 0.8V	B-36	MCR22-4		
EC103C	TCE	0.51A, 300V, 200 μ A, 0.8V	B-36	MCR100-5		
EC103C1	TCE	0.8A, 300V, 12 μ A, 0.8V	B-36	MCR22-5		
EC103C2	TCE	0.8A, 300V, 50 μ A, 0.8V	B-36	MCR22-5		

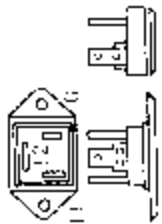

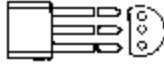
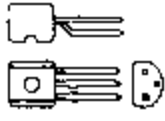
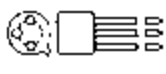
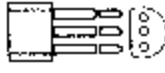
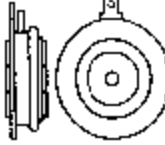
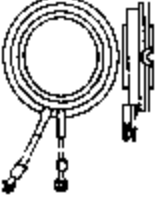
器件型号 Element type	厂名 Manufacturers	材料用途参数 Material Purpose Parameter	图号 Figure	国内外相似替换器件型号 Replace of simillar type	备注 Notes	外形参考图 Reference shape
EC103C3	TCE	0.8A, 300V, 500 μ A, 0.8V	B-36	MCR22-5		 图 B-36
EC103D	TCE	0.8A, 400V, 200 μ A, 0.8V	B-36	ECG5405, MCR100-6, 2N6565		
EC103D1	TCE	0.8A, 400V, 12 μ A, 0.8V	B-36	MCR22-6		
EC103D2	TCE	0.8A, 400V, 50 μ A, 0.8V	B-36	MCR22-6		
EC103D3	TCE	0.8A, 400V, 500 μ A, 0.8V	B-36	MCR22-6		
EC103E	TCE	0.8A, 500V, 200 μ A, 0.8V	B-36	MCR22-7		
EC103E1	TCE	0.8A, 500V, 12 μ A, 0.8V	D-36	MCR22-7		
EC103E2	TCE	0.8A, 500V, 50 μ A, 0.8V	B-36	MCR22-7		
EC103E3	TCE	0.8A, 500V, 500 μ A, 0.8V	B-36	MCR22-7		
EC103M	TCE	0.8A, 600V, 200 μ A, 0.8V	B-36	MCR22-8, SK3952, SK5406		
EC103M1	TCE	0.8A, 600V, 12 μ A, 0.8V	B-36	MCR22-8		
EC103M2	TCE	0.8A, 600V, 50 μ A, 0.8V	B-36	MCR22-8		
EC103M3	TCE	0.8A, 600V, 500 μ A, 0.8V	B-36	MCR22-8		
EC103Y	TCE	0.8A, 800V, 200 μ A, 0.8V	B-36	MCR102, MCR1002, SK3950, SK5400, UN5065		 图 C-10
EC103Y1	TCE	0.8A, 800V, 12 μ A, 0.8V	B-36	MCR22-2		
EC103Y2	TCE	0.8A, 800V, 50 μ A, 0.8V	B-36	MCR22-2		
EC103Y3	TCE	0.8A, 800V, 500 μ A, 0.8V	B-36	MCR22-2		
EC350E	EET	115A, 500V	C-10			 图 C-35
EC350M	EET	180A, 600V, 0.15A, 3V	C-35			
EC350N	EET	180A, 800V, 0.15A, 3V	C-35			
EC350P	EET	180A, 1kV, 0.15A, 1.5V	C-35			
EC350PA	EET	180A, 1.1kV, 0.15A, 3V	C-35			
EC350PB	EET	180A, 1.2kV, 0.15A, 3V	C-35			
EC350PD	EET	180A, 1.4kV, 0.15A, 3V	C-35			
EC350PM	EET	180A, 1.6kV, 0.15A, 3V	C-35			
EC354A	EET	275A, 100V, 0.15A, 3V	C-35			
EC354B	EET	275A, 200V, 0.15A, 3V	C-35			

器件型号 Element type	厂名 Manufacturers	材料用途参数 Material Purpose Parameter	图号 Figure	国内外相似替换器件型号 Replace of similar type	备注 Notes	外形参考图 Reference shape
EC354C	EET	275A, 300V, 0.15A, 3V	C-35			 <p>图 C-35</p>
EC354D	EET	275A, 400V, 0.15A, 3V	C-35			
EC354M	EET	275A, 600V, 0.15A, 3V	C-35			
EC355A	EET	275A, 100V, 0.15A, 3V	C-35			
EC355B	EET	275A, 200V, 0.15A, 3V	C-35			
EC355C	EET	275A, 300V, 0.15A, 3V	C-35			
EC355D	EET	275A, 400V, 0.15A, 3V	C-35			
EC355E	EET	275A, 500V, 0.15A, 3V	C-35			
EC355M	EET	275A, 600V, 0.15A, 3V	C-35			
EC358E	EET	225A, 500V	C-10			
EC358M	EET	225A, 600V	C-10			
EC358N	EET	225A, 800V	C-10			
EC358P	EET	225A, 1kV	C-10			
EC358PB	EET	225A, 1.2kV	C-10			
EC364A	EET	275A, 100V, 0.15A, 3V	C-35			
EC364B	EET	275A, 200V, 0.15A, 3V	C-35			
EC364C	EET	275A, 300V, 0.15A, 3V	C-35			
EC364D	EET	275A, 400V, 0.15A, 3V	C-35			
EC364E	EET	275A, 500V, 0.15A, 3V	C-35			
EC364M	EET	275A, 600V, 0.15A, 3V	C-35			
EC364N	EET	275A, 800V, 0.15A, 3V	C-35			
EC365A	EET	275A, 100V, 0.15A, 3V	C-35			
EC365B	EET	275A, 200V, 0.15A, 3V	C-35			
EC365C	EET	275A, 300V, 0.15A, 3V	C-35			
EC365D	EET	275A, 400V, 0.15A, 3V	C-35			
EC365E	EET	275A, 500V, 0.15A, 3V	C-35			
EC365M	EET	275A, 600V, 0.15A, 3V	C-35			

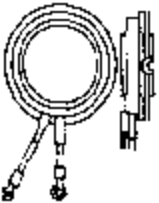
器件型号 Element type	厂名 Manufacturers	材料用途参数 Material Purpose Parameter	图号 Figure	国内外相似替换器件型号 Replace of similar type	备注 Notes	外形参考图 Reference shape
EC365N	EET	275A, 800V, 0.15A, 3V	C-35			
EC376E	EET	600A, 500V, 0.15A, 3V	B-91			
EC376M	EET	600A, 600V, 0.15A, 3V	B-91			
EC376N	EET	600A, 800V, 0.15A, 3V	B-91			
EC376P	EET	600A, 1kV, 0.15A, 3V	B-91			
EC376PB	EET	600A, 1.2kV, 0.15A, 3V	B-91			
EC376PD	EET	600A, 1.4kV, 0.15A, 3V	B-91			
EC377E	EET	700A, 500V, 0.15A, 3V	B-91			
EC377M	EET	700A, 600V, 0.15A, 3V	B-91			
EC377N	EET	700A, 800V, 0.15A, 3V	B-91			
EC377P	EET	700A, 1kV, 0.15A, 3V	B-91			
EC377PB	EET	700A, 1.2kV, 0.15A, 3V	B-91			
EC377PD	EET	700A, 1.4kV, 0.15A, 3V	B-91			
EC380A	EET	ACS, 390A, 100V, 0.15A, 3V	C-50			
EC380AX500	EET	500A, 100V, 0.15A, 3V	C-35			
EC380AX555	EET	450A, 100V, 0.15A, 3V	C-35			
EC380B	EET	ACS, 390A, 200V, 0.15A, 3V	C-50			
EC380BX500	EET	500A, 200V, 0.15A, 3V	C-35			
EC380BX555	EET	450A, 200V, 0.15A, 3V	C-35			
EC380C	EET	ACS, 390A, 300V, 0.15A, 3V	C-50			
EC380CX500	EET	500A, 300V, 0.15A, 3V	C-35			
EC380CX555	EET	450A, 300V, 0.15A, 3V	C-35			
EC380D	EET	ACS, 390A, 400V, 0.15A, 3V	C-50			
EC380DX500	EET	500A, 400V, 0.15A, 3V	C-35			
EC380DX555	EET	450A, 400V, 0.15A, 3V	C-35			
FC380M	EET	ACS, 390A, 600V, 0.15A, 3V	C-50			
EC380MX500	EET	500A, 600V, 0.15A, 3V	C-35			



图 C-35



图 B-91



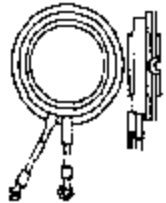

图 C-50

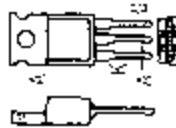
器件型号 Element type	厂名 Manufacturers	材料用途参数 Material Purpose Parameter	图号 Figure	国内外相似替换器件型号 Replace of similar type	备注 Notes	外形参考图 Reference shape
EC380MX555	EET	450A, 600V, 0.15A, 3V	C-35			 图 C-35
EC380N	EET	ACS, 390A, 800V, 0.15A, 3V	C-50			
EC380NX500	EET	500A, 800V, 0.15A, 3V	C-35			
EC380NX555	EET	450A, 800V, 0.15A, 3V	C-35			
EC380P	EET	ACS, 390A, 1kV, 0.15A, 3V	C-50			
EC380PBX500	EET	500A, 1.2kV, 0.15A, 3V	C-35			
EC380PBX555	EET	450A, 1.2kV, 0.15A, 3V	C-35			
EC380PD	EET	ACS, 390A, 1.4kV, 0.15A, 3V	C-50			
EC380PM	EET	ACS, 390A, 1.6kV, 0.15A, 3V	C-50			
EC380PX555	EET	450A, 1kV, 0.15A, 3V	C-35			
EC384A	EET	400A, 100V, 0.15A, 3V	C-35			 图 C-50
EC384B	EET	400A, 200V, 0.15A, 3V	C-35			
EC384C	EET	400A, 300V, 0.15A, 3V	C-35			
EC384D	EET	400A, 400V, 0.15A, 3V	C-35			
EC384E	EET	400A, 500V, 0.15A, 3V	C-35			
EC384M	EET	400A, 600V, 0.15A, 3V	C-35			
EC384N	EET	400A, 800V, 0.15A, 3V	C-35			
EC384S	EET	400A, 700V, 0.15A, 3V	C-50			
EC385A	EET	400A, 100V, 0.15A, 3V	C-35			
EC385C	EET	400A, 300V, 0.15A, 3V	C-35			
EC385D	EET	400A, 400V, 0.15A, 3V	C-35			
EC385E	EET	400A, 500V, 0.15A, 3V	C-35			
EC385M	EET	400A, 600V, 0.15A, 3V	C-35			
EC385N	EET	400A, 800V, 0.15A, 3V	C-35			
EC385S	EET	400A, 700V, 0.15A, 3V	C-50			
EC387E	EET	500A, 500V, 0.15A, 3V	C-35			 E
EC387M	EET	500A, 500V, 0.15A, 3V	C-35			

器件型号 Element type	厂名 Manufacturers	材料用途参数 Material Purpose Parameter	图号 Figure	国内外相似替换器件型号 Replace of similar type	备注 Notes	外形参考图 Reference shape	
EC387N	EET	500A, 800V, 0.15A, 3V	C-35			 图 C-35	
EC387P	EET	500A, 1kV, 0.15A, 3V	C-35				
EC387PB	EET	500A, 1.2kV, 0.15A, 3V	C-35				
EC388E	EET	500A, 500V, 0.15A, 3V	C-35				
EC388M	EET	500A, 600V, 0.15A, 3V	C-35				
EC388N	EET	500A, 800V, 0.15A, 3V	C-35				
EC388P	EET	500A, 1kV, 0.15A, 3V	C-35				
EC390AX500	EET	900A, 100V, 0.15A, 3V	B-91				 图 B-91
EC390AX550	EET	980A, 100V, 0.15A, 3V	C-70				
EC390AX555	EET	800A, 100V, 0.15A, 3V	B-91				
EC390BX500	EET	900A, 200V, 0.15A, 3V	B-91				
EC390BX550	EET	980A, 200V, 0.15A, 3V	C-70				
EC390BX555	EET	800A, 200V, 0.15A, 3V	B-91				
EC390CX500	EET	980A, 300V, 0.15A, 3V	B-91				
EC390DX500	EET	900A, 400V, 0.15A, 3V	B-91				
EC390DX550	EET	980A, 400V, 0.15A, 3V	C-70				
EC390DX555	EET	800A, 400V, 0.15A, 3V	B-91			 图 C-70	
EC390EX500	EET	980A, 500V, 0.15A, 3V	B-91				
EC390MX500	EET	900A, 600V, 0.15A, 3V	B-91				
EC390MX555	EET	800A, 600V, 0.15A, 3V	B-91				
EC390NX500	EET	900A, 800V, 0.15A, 3V	B-91				
EC390NX555	EET	800A, 800V, 0.15A, 3V	B-91				
EC390PBX555	EET	800A, 1.2kV, 0.15A, 3V	B-91				
EC390PFX555	EET	800A, 1kV, 0.15A, 3V	B-91				
EC391L	EET	850A, 2kV, 0.15A, 3V	B-91				 图 C-10
EC391P	EET	850A, 1kV, 0.15A, 3V	B-91				
EC391PD	EET	540A, 1.4kV	C-10				
EC391PM	EET	850A, 1.6kV, 0.15A, 3V	B-91				

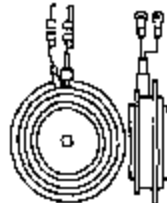
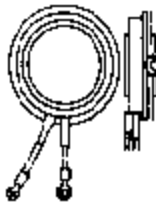
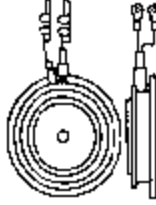
器件型号 Element type	厂名 Manufacturers	材料用途参数 Material Purpose Parameter	图号 Figure	国内外相似替换器件型号 Replace of similar type	备注 Notes	外形参考图 Reference space
EC391PN	EET	850A, 1.8kV, 0.15A, 3V	B-91			
EC392A	EET	500A, 100V, 0.15A, 3V	B-91			
EC392B	EET	500A, 200V, 0.15A, 3V	B-91			
EC392C	EET	500A, 300V, 0.15A, 3V	B-91			
EC392D	EET	500A, 400V, 0.15A, 3V	B-91			
FC392F	EET	500A, 500V, 0.15A, 3V	B-91			
EC392M	EET	500A, 600V, 0.15A, 3V	B-91			
EC393A	EET	500A, 100V, 0.15A, 3V	B-91			
EC393B	EET	500A, 200V, 0.15A, 3V	B-91			
EC393C	EET	500A, 300V, 0.15A, 3V	B-91			
EC393D	EET	500A, 400V, 0.15A, 3V	B-91			
EC393E	EET	500A, 500V, 0.15A, 3V	B-91			
EC393M	EET	500A, 600V, 0.15A, 3V	B-91			
EC394A	EET	700A, 100V, 0.15A, 3V	B-91			
EC394B	EET	700A, 200V, 0.15A, 3V	B-91			
EC394C	EET	700A, 300V, 0.15A, 3V	B-91			
EC394D	EET	700A, 400V, 0.15A, 3V	B-91			
EC394E	EET	700A, 500V, 0.15A, 3V	B-91			
EC394M	EET	700A, 600V, 0.15A, 3V	B-91			
EC395A	EET	700A, 100V, 0.15A, 3V	B-91			
EC395B	EET	700A, 200V, 0.15A, 3V	B-91			
EC395C	EET	700A, 300V, 0.15A, 3V	B-91			
EC395D	EET	700A, 400V, 0.15A, 3V	B-91			
EC395E	EET	700A, 500V, 0.15A, 3V	B-91			
EC395M	EET	700A, 600V, 0.15A, 3V	B-91			
EC397E	EET	650A, 500V, 0.15A, 3V	B-91			
EC397M	EET	650A, 600V, 0.15A, 3V	B-91			
EC397N	EET	650A, 800V, 0.15A, 3V	B-91			

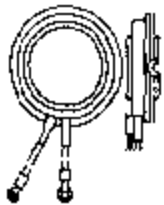
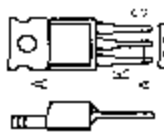
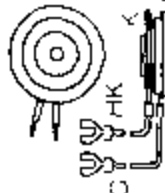
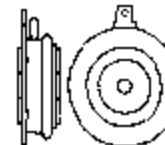

图 B-91



器件型号 Element type	厂名 Manufacturers	材料用途参数 Material Purpose Parameter	图号 Figure	国内外相似替换器件型号 Replace of similar type	备注 Notes	外形参考图 Reference shape	
EC397P	EET	650A, 1kV, 0.15A, 3V	B-91			 图 B-91	
EC397PB	EET	650A, 1.2kV, 0.15A, 3V	B-91				
EC398E	EET	650A, 500V, 0.15A, 3V	B-91				
EC398M	EET	650A, 600V, 0.15A, 3V	B-91				
EC398N	FFT	650A, 800V, 0.15A, 3V	B-91				
EC398P	EET	650A, 1kV, 0.15A, 3V	B-91				
EC398PB	EET	650A, 1.2kV, 0.15A, 3V	B-91				
EC430AX500	EET	1.2kA, 0.15A, 3V	C-70				 图 C-70
EC430AX550	EET	1.25kA, 100V, 0.15A, 3V	C-70				
EC430AX555	EET	1kA, 100V, 0.15A, 3V	C-70				
EC430BX500	EET	1.2kA, 200V, 0.15A, 3V	C-70				
EC430BX550	EET	1.25kA, 200V, 0.15A, 3V	C-70				
EC430BX555	EET	1kA, 200V, 0.15A, 3V	C-70				
EC430CX500	EET	1.2kA, 300V, 0.15A, 3V	C-70				
EC430CX550	FFT	1.25kA, 300V, 0.15A, 3V	C-70				
EC430DX500	EET	1.2kA, 400V, 0.15A, 3V	C-70				
EC430DX550	EET	1.25kA, 400V, 0.15A, 3V	C-70				
EC430DX555	EET	1kA, 300V, 0.15A, 3V	C-70				
EC430EX550	EET	1.25kA, 500V, 0.15A, 3V	C-70				
EC430MX500	EET	1.2kA, 600V, 0.15A, 3V	C-70				
EC430MX555	EET	1kA, 600V, 0.15A, 3V	C-70				
EC430NX500	EET	1.2kA, 800V, 0.15A, 3V	C-70				
EC430NX555	EET	1kA, 800V, 0.15A, 3V	C-70				
EC430PBX555	EET	1kA, 1.2kV, 0.15A, 3V	C-70				
EC430PX555	EET	1kA, 1kV, 0.15A, 3V	C-70				
EC431L	EET	950A, 2kV, 0.15A, 3V	C-70				
EC431P	EET	950A, 1kV, 0.15A, 3V	C-70				
EC431PB	EET	950A, 1.2kV, 0.15A, 3V	C-70				

器件型号 Element type	厂名 Manufacturers	材料用途参数 Material Purpose Parameter	图号 Figure	国内外相似替换器件型号 Replace of similar type	备注 Notes	外形参考图 Reference shape
EC431PD	EET	950A, 1.4kV, 0.15A, 3V	C-70			 <p>图 C-70</p>
EC431PM	EET	950A, 1.6kV, 0.15A, 3V	C-70			
EC431PN	EET	950A, 1.8kV, 0.15A, 3V	C-70			
EC434A	EET	700A, 100V, 0.15A, 3V	C-70			
EC434B	EET	700A, 200V, 0.15A, 3V	C-70			
EC434C	EET	700A, 300V, 0.15A, 3V	C-70			
EC434D	EET	700A, 400V, 0.15A, 3V	C-70			
EC434E	EET	700A, 500V, 0.15A, 3V	C-70			
EC434M	EET	700A, 600V, 0.15A, 3V	C-70			
EC434S	EET	700A, 700V, 0.15A, 3V	C-70			
EC435A	EET	700A, 100V, 0.15A, 3V	C-70			
EC435B	EET	700A, 200V, 0.15A, 3V	C-70			
EC435C	EET	700A, 300V, 0.15A, 3V	C-70			
EC435D	EET	700A, 400V, 0.15A, 3V	C-70			
EC435E	EET	700A, 500V, 0.15A, 3V	C-70			
EC435M	EET	700A, 600V, 0.15A, 3V	C-70			
EC435S	EET	700A, 700V, 0.15A, 3V	C-10			
EC436E	EET	700A, 500V, 0.15A, 3V	C-70			
EC436M	EET	700A, 600V, 0.15A, 3V	C-70			
EC436N	EET	700A, 800V, 0.15A, 3V	C-70			
EC436P	EET	700A, 1kV, 0.15A, 3V	C-70			
EC436PB	EET	700A, 1.2kV, 0.15A, 3V	C-70			
EC437E	EET	750A, 500V, 0.15A, 3V	C-70			
EC437M	EET	750A, 600V, 0.15A, 3V	C-70			
EC437N	EET	750A, 800V, 0.15A, 3V	C-70			
EC437P	EET	750A, 1kV, 0.15A, 3V	C-70			
EC437PB	EET	750A, 1.2kV, 0.15A, 3V	C-70			
EC438P	EET	750A, 1kV, 0.15A, 3V	C-70			

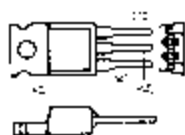
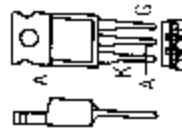
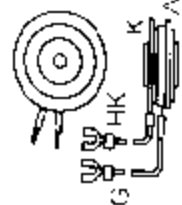
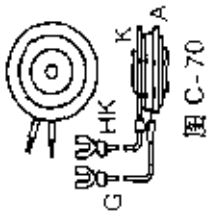

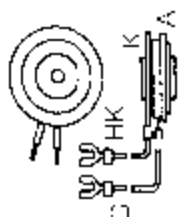
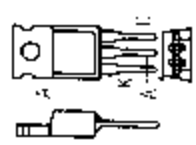
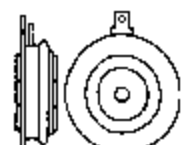
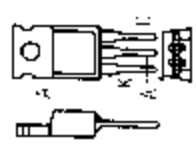
器件型号 Element type	厂名 Manufacturers	材料用途参数 Material Purpose Parameter	图号 Figure	国内外相似替换器件型号 Replace of similar type	备注 Notes	外形参考图 Reference shape
EC438E	EET	750A, 500V, 0.15A, 3V	C-70			 图 C-70
EC438M	EET	750A, 600V, 0.15A, 3V	C-70			
EC438N	EET	750A, 800V, 0.15A, 3V	C-70			
EC438PR	EET	750A, 1.2kV, 0.15A, 3V	C-70			
EC441L	EET	1.1kA, 2kV, 0.15A, 3V	B-91			 图 B-91
EC441P	EET	750A, 1kV	C 10			
EC441PB	EET	1.1kA, 1.2kV, 0.15A, 3V	B-91			
EC441PD	EET	1.1kA, 1.4kV, 0.15A, 3V	B-91			
EC441PM	EET	1.1kA, 1.6kV, 0.15A, 3V	B-91			 图 C-10
EC441PN	EET	1.1kA, 1.8kV, 0.15A, 3V	B-91			
EC444A	EET	1.1kA, 100V, 0.15A, 3V	B-91			
EC444B	EET	1.1kA, 200V, 0.15A, 3V	B-91			
EC444C	EET	1.1kA, 300V, 0.15A, 3V	B-91			 图 B-91
EC444D	EET	1.1kA, 400V, 0.15A, 3V	B-91			
EC444E	EET	1.1kA, 500V, 0.2A, 3V	B-91			
EC444M	EET	1.1kA, 600V, 0.15A, 3V	B-91			
EC444S	EET	1.1kA, 700V, 0.15A, 3V	B-91			
EC445A	EET	1.1kA, 100V, 0.15A, 3V	B-91			
EC445B	EET	1.1kA, 200V, 0.15A, 3V	B-91			
EC445C	EET	1.1kA, 300V, 0.15A, 3V	B-91			
EC445D	EET	1.1kA, 400V, 0.15A, 3V	B-91			
EC445M	EET	1.1kA, 600V, 0.15A, 3V	B-91			
EC445S	EET	1.1kA, 700V, 0.15A, 3V	B-91			
EC447E	EET	1kA, 500V, 0.15A, 3V	B-91			
EC447M	EET	1kA, 600V, 0.15A, 3V	B-91			
EC447N	EET	1kA, 800V, 0.15A, 3V	B-91			

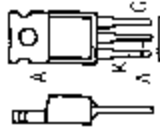
器件型号 Element type	厂名 Manufacturers	材料用途参数 Material Purpose Parameter	图号 Figure	国内外相似替换器件型号 Replace of similar type	备注 Notes	外形参考图 Reference shape
EC447P	EET	1kA, 1kV, 0.15A, 3V	B-91			 <p>图 B-91</p>
EC447PB	EET	1kA, 1.2kV, 0.15A, 3V	B-91			
EC448F	FET	1kA, 500V, 0.15A, 3V	B-91			
EC448M	EET	1kA, 600V, 0.15A, 3V	B-91			
EC448N	EET	1kA, 800V, 0.15A, 3V	B-91			
EC448P	EET	1kA, 1kV, 0.15A, 3V	B-91			
EC448PB	EET	1kA, 1.2kV, 0.15A, 3V	B-91			
EC449PE	EET	850A, 1.5kV, 0.15A, 3V	B-91			
EC449PM	EET	850A, 1.6kV, 0.15A, 3V	B-91			
EC449PN	EET	850A, 1.8kV, 0.15A, 3V	B-91			
EC449PS	EET	850A, 1.7kV, 0.15A, 3V	B-91			
EC450E	EET	2.4kA, 500V, 0.15A, 3V				
EC450M	EET	2.4kA, 600V, 0.15A, 3V				
EC450N	EET	2.4kA, 800V, 0.15A, 3V				
EC450P	EET	2.4kA, 1kV, 0.15A, 3V				
EC450PA	EET	ACS, 2.4kA, 1.2kV, 0.15A, 5V	C-50			
EC450PD	EET	2.4kA, 1.4kV, 0.15A, 3V				
EC451E1	EET	2.2kA, 500V, 0.15A, 3V				
EC451M1	EET	2.2kA, 600V, 0.15A, 3V				
EC451N1	EET	2.2kA, 800V, 0.15A, 3V				
EC451PB1	EET	2.2kA, 1.2kV, 0.15A, 3V				
EC451PD1	EET	2.2kA, 1.4kV, 0.15A, 3V				
EC451PM1	EET	2.2kA, 1.6kV, 0.15A, 3V				
EC451PN1	EET	2.2kA, 1.8kV, 0.15A, 3V				
EC457E	EET	2kA, 500V, 0.15A, 3V				
EC457M	EET	2kA, 600V, 0.15A, 3V				
EC457N	EET	2kA, 800V, 0.15A, 3V				
EC457P	EET	2kA, 1kV, 0.15A, 3V				





图 B-91

图 C-50

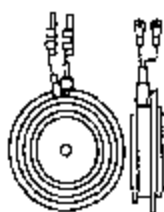
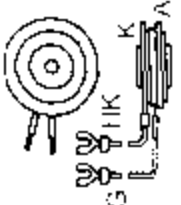
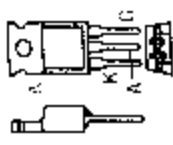
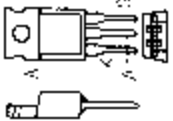

器件型号 Element type	厂名 Manufacturers	材料用途参数 Material Purpose Parameter	图号 Figure	国内外相似替换器件型号 Replace of similar type	备注 Notes	外形参考图 Reference shape
EC457PB	EET	2kA, 1.2kV, 0.15A, 3V				 <p>图 C-70</p>
EC457PD	EET	2kA, 1.4kV, 0.15A, 3V				
EC458E	EET	2kA, 500V, 0.15A, 3V				
EC458M	EET	2kA, 600V, 0.15A, 3V				
EC458N	EET	2kA, 800V, 0.15A, 3V				
EC458P	EET	2kA, 1kV, 0.15A, 3V				
EC458PB	EET	2kA, 1.2kV, 0.15A, 3V				
EC458PD	EET	2kA, 1.4kV, 0.15A, 3V				
EC476E	EET	600A, 500V, 0.15A, 3V	C-70			
EC476M	EET	600A, 600V, 0.15A, 3V	C-70			
EC476N	EET	600A, 800V, 0.15A, 3V	C-70			
EC476P	EET	600A, 1kV, 0.15A, 3V	C-70			
EC476PB	EET	600A, 1.2kV, 0.15A, 3V	C-70			
EC476PD	EET	600A, 1.4kV, 0.15A, 3V	C-70			
EC601L	EET	1.1kA, 2kV, 0.15A, 3V	B-91			 <p>图 B-91</p>
EC601P	EET	1.1kA, 1kV, 0.15A, 3V	B-91			
EC601PB	EET	1.1kA, 1.2kV, 0.15A, 3V	B-91			
EC601PM	EET	1.1kA, 1.6kV, 0.15A, 3V	B-91			
EC601PN	EET	1.1kA, 1.8kV, 0.15A, 3V	B-91			
EC602L	EET	940A, 2kV, 0.15A, 3V	B-91			
EC602LB	EET	940A, 2.2kV, 0.15A, 3V	B-91			
EC602LD	EET	940A, 2.4kV, 0.15A, 3V	B-91			
EC602LM	EET	940A, 2.6kV, 0.15A, 3V	B-91			
EC612L	EET	1.15kA, 2kV, 0.15A, 3V	B-91			
EC612PE	EET	1.15kA, 1.5kV, 0.15A, 3V	B-91			
EC612PM	EET	1.15kA, 1.6kV, 0.15A, 3V	B-91			

器件型号 Element type	厂名 Manufacturers	材料用途参数 Material Purpose Parameter	图号 Figure	国内外相似替换器件型号 Replace of similar type	备注 Notes	外形参考图 Reference shape
EC612PN	EET	1.15kA, 1.8kV, 0.15A, 3V	B-91			 图 B-91
EC612PS	EET	1.15kA, 1.7kV, 0.15A, 3V	B-91			
EC612PT	EET	1.15kA, 1.9kV, 0.15A, 3V	B-91			
EC613PE	EET	820A, 1.5kV, 0.15A, 3V	B-91			
EC613PM	FET	820A, 1.6kV, 0.15A, 3V	B-91			
EC613PN	EET	820A, 1.8kV, 0.15A, 3V	B-91			
EC613PS	EET	820A, 1.7kV, 0.15A, 3V	B-91			
EC613PT	EET	820A, 1.9kV, 0.15A, 3V	B-91			
EC648E	EET	1.15kA, 500V, 0.15A, 3V	B-91			
EC648M	EET	1.15kA, 600V, 0.15A, 3V	B-91			
EC648P	EET	1.15kA, 1kV, 0.15A, 3V	B-91			
EC648PB	EET	1.15kA, 1.2kV, 0.15A, 3V	B-91			
EC702L	EET	1.6kA, 2kV, 0.15A, 3V				 图 C-10
EC702LB	EET	1.6kA, 2.2kV, 0.15A, 3V				
EC702LD	EET	1.6kA, 2.4kV, 0.15A, 3V				
EC702LM	EET	1.6kA, 2.6kV, 0.15A, 3V				
EC702PN	EET	1.6kA, 1.8kV, 0.15A, 3V				
EC712L	EET	1.5kA, 2kV, 0.15A, 3V				
EC712PA	EET	1.5kA, 1.1kV, 0.2A, 3.5V	C-10			
EC712PB	EET	1.5kA, 1.2kV, 0.15A, 3V				
EC712PD	EET	1.5kA, 1.4kV, 0.15A, 3V				
EC712PM	EET	1.5kA, 1.6kV, 0.15A, 3V				
EC712PN	EET	1.5kA, 1.8kV, 0.15A, 3V				
EC713L	EET	1.2kA, 2kV, 0.15A, 3V				
EC713PA	EET	1.2kA, 1.1kV, 0.15A, 3V				
EC713PB	EET	1.2kA, 1.2kV, 0.15A, 3V				

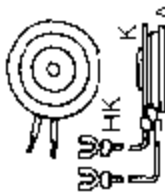
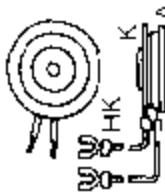
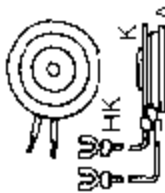
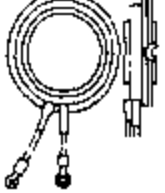
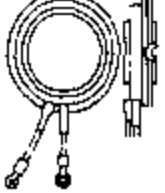
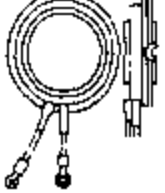
器件型号 Element type	厂名 Manufacturers	材料用途参数 Material Purpose Parameter	图号 Figure	国内外相似替换器件型号 Replace of similar type	备注 Notes	外形参考图 Reference shape
EC713PD	EET	1.2kA, 1.4kV, 0.15A, 3V				 图 C-70
EC713PM	EET	1.2kA, 1.6kV, 0.15A, 3V				
EC713PN	EET	1.2kA, 1.8kV, 0.15A, 3V				
EC4010-1M	EET	700A, 600V, 0.15A, 3V	C-70			 图 C-70
EC4010-1N	EET	700A, 800V, 0.15A, 3V	C-70			
EC4010-1P	EET	700A, 1kV, 0.15A, 3V	C-70			
EC4010-1PB	EET	700A, 1.2kV, 0.15A, 3V	C-70			
EC4105-1A	EET	1.1kA, 100V, 0.15A, 3V	C-70			 图 C-70
EC4105-1B	EET	1.1kA, 200V, 0.15A, 3V	C-70			
EC4105-1C	EET	1.1kA, 300V, 0.15A, 3V	C-70			
EC4105-1D	EET	1.1kA, 400V, 0.15A, 3V	C-70			
EC4105-1E	EET	1.1kA, 500V, 0.15A, 3V	C-70			
EC4131-1M	EET	400A, 600V, 0.15A, 3V	C-35			 图 C-35
EC4131-1N	EET	400A, 800V, 0.15A, 3V	C-35			
EC4131-1P	EET	400A, 1kV, 0.15A, 3V	C-35			
EC4131-1PB	EET	400A, 1.2kV, 0.15A, 3V	C-35			
EC4135-1A	EET	800A, 100V, 0.15A, 3V	C-35			 图 C-35
EC4135-1B	EET	800A, 200V, 0.15A, 3V	C-35			
EC4135-1C	EET	800A, 300V, 0.15A, 3V	C-35			
EC4135-1D	EET	800A, 400V, 0.15A, 3V	C-35			
EC4135-1E	EET	800A, 500V, 0.15A, 3V	C-35			
EC4158L	EET	1.3kA, 2kV, 0.15A, 3V				 图 C-35
EC4158LB	EET	1.3kA, 2.2kV, 0.15A, 3V				
EC4158LD	EET	1.3kA, 2.4kV, 0.15A, 3V				

器件型号 Element type	厂名 Manufacturers	材料用途参数 Material Purpose Parameter	图号 Figure	国内外相似替换器件型号 Replace of similar type	备注 Notes	外形参考图 Reference shape
EC4158LM	FET	1.3kA, 2.6kV, 0.15A, 3V				
EC4158LN	EET	1.3kA, 2.8kV, 0.15A, 3V				
EC4158LR	EET	1.3kA, 3kV, 0.15A, 3V				
EC4158PS	EET	1.3kA, 1.7kV, 0.15A, 3V				
EF02F		17A, 0.08A, 2.5V				
EFC01A		17A, 200V, 0.08A, 2.5V				
EFC01B		17A, 120V, 0.08A, 2.5V				
EFC01C		17A, 240V, 0.08A, 2.5V				
EFC01D		17A, 800V, 0.08A, 2.5V				
EFC01E		17A, 1kV, 0.08A, 2.5V				
EFC01F		17A, 440V, 0.08A, 2.5V				
EFC01G		17A, 1.4kV, 0.08A, 2.5V				
EFC01U		17A, 100V, 0.08A, 2.5V				
EFC02A		17A, 200V, 0.08A, 2.5V				
EFC02B		17A, 120V, 0.08A, 2.5V				
EFC02C		17A, 240V, 0.08A, 2.5V				
EFC02D		17A, 800V, 0.08A, 2.5V				
EFC02E		17A, 1kV, 0.08A, 2.5V				
EFC02G		17A, 1.4kV, 0.08A, 2.5V				
EFC02U		17A, 100V, 0.08A, 2.5V				
EFC04A		17A, 200V, 0.08A, 2.5V				
EFC04B		17A, 120V, 0.08A, 2.5V				
EFC04C		17A, 240V, 0.08A, 2.5V				
EFC04D		17A, 800V, 0.08A, 2.5V				
EFC04E		17A, 1kV, 0.08A, 2.5V				
EFC04F		17A, 440V, 0.08A, 2.5V				



器件型号 Element type	厂名 Manufacturers	材料用途参数 Material Purpose Parameter	图号 Figure	国内外相似替换器件型号 Replace of similar type	备注 Notes	外形参考图 Reference shape
EFC04G		17A, 1.4kV, 0.08A, 2.5V				
EFC04U		17A, 100V, 0.08A, 2.5V				
EFC05A		17A, 200V, 0.08A, 2.5V				
EFC05B		17A, 120V, 0.08A, 2.5V				
EFC05C		17A, 240V, 0.08A, 2.5V				
EFC05D		17A, 800V, 0.08A, 2.5V				
EFC05E		17A, 1kV, 0.08A, 2.5V				
EFC05F		17A, 440V, 0.08A, 2.5V				
EFC05G		17A, 1.4kV, 0.08A, 2.5V				
EFC05U		17A, 100V, 0.08A, 2.5V				
EFC15A		17A, 200V, 0.08A, 2.5V				
EFC15B		17A, 400V, 0.08A, 2.5V				
EFC15C		17A, 600V, 0.08A, 2.5V				
EFC15D		17A, 800V, 0.08A, 2.5V				
EFC15E		17A, 1kV, 0.08A, 2.5V				
EFC15F		17A, 1.2kV, 0.08A, 2.5V				
EFC15G		17A, 1.4kV, 0.08A, 2.5V				
EFC15U		17A, 100V, 0.08A, 2.5V				
EFC16A		17A, 200V, 0.08A, 2.5V				
EFC16B		17A, 400V, 0.08A, 2.5V				
EFC16C		17A, 600V, 0.08A, 2.5V				
EFC16D		17A, 800V, 0.08A, 2.5V				
EFC16E		17A, 1kV, 0.08A, 2.5V				
EFC16F		17A, 1.2kV, 0.08A, 2.5V				
EFC16G		17A, 1.4kV, 0.08A, 2.5V				
EFC16U		17A, 100V, 0.08A, 2.5V				
EFC17A		17A, 200V, 0.08A, 2.5V				
EFC17B		17A, 400V, 0.08A, 2.5V				

器件型号 Element type	厂名 Manufacturers	材料用途参数 Material Purpose Parameter	图号 Figure	国内外相似替换器件型号 Replace of similar type	备注 Notes	外形参考图 Reference shape
EFC17C		17A, 600V, 0.08A, 2.5V				
EFC17D		17A, 800V, 0.08A, 2.5V				
EFC17E		17A, 1kV, 0.08A, 2.5V				
EFC17F		17A, 1.2kV, 0.08A, 2.5V				
EFC17G		17A, 1.4kV, 0.08A, 2.5V				
EFC17U		17A, 100V, 0.08A, 2.5V				
EFC18A		17A, 200V, 0.08A, 2.5V				
EFC18B		17A, 400V, 0.08A, 2.5V				
EFC18C		17A, 600V, 0.08A, 2.5V				
EFC18D		17A, 800V, 0.08A, 2.5V				
EFC18E		17A, 1kV, 0.08A, 2.5V				
EFC18F		17A, 1.2kV, 0.08A, 2.5V				
EFC18G		17A, 1.4kV, 0.08A, 2.5V				
EFC18U		17A, 100V, 0.08A, 2.5V				
EFC19A		17A, 200V, 0.08A, 2.5V				
EFC19B		17A, 400V, 0.08A, 2.5V				
EFC19C		17A, 600V, 0.08A, 2.5V				
EFC19D		17A, 800V, 0.08A, 2.5V				
EFC19E		17A, 1kV, 0.08A, 2.5V				
EFC19F		17A, 1.2kV, 0.08A, 2.5V				
EFC19G		17A, 1.4kV, 0.08A, 2.5V				
EFC19U		17A, 100V, 0.08A, 2.5V				
EFC20A		17A, 200V, 0.08A, 2.5V				
EFC20B		17A, 400V, 0.08A, 2.5V				
EFC20C		17A, 600V, 0.08A, 2.5V				
EFC20D		17A, 800V, 0.08A, 2.5V				
EFC20E		17A, 1kV, 0.08A, 2.5V				
EFC20F		17A, 1.2kV, 0.08A, 2.5V				
EFC20G		17A, 1.4kV, 0.08A, 2.5V				



器件型号 Element type	厂名 Manufacturers	材料用途参数 Material Purpose Parameter	图号 Figure	国内外相似替换器件型号 Replace of similar type	备注 Notes	外形参考图 Reference shape
EFC20U		17A, 100V, 0.08A, 2.5V				
EFD01A		25A, 200V, 0.08A, 2.5V				
EFD01B		25A, 120V, 0.08A, 2.5V				
EFD01C		25A, 240V, 0.08A, 2.5V				
EFD01D		25A, 800V, 0.08A, 2.5V				
EFD01E		25A, 1kV, 0.08A, 2.5V				
EFD01F		25A, 440V, 0.08A, 2.5V				
EFD01G		25A, 1.4kV, 0.08A, 2.5V				
EFD01U		25A, 100V, 0.08A, 2.5V				
EFD02A		25A, 200V, 0.08A, 2.5V				
EFD02B		25A, 120V, 0.08A, 2.5V				
EFD02C		25A, 240V, 0.08A, 2.5V				
EFD02D		25A, 800V, 0.08A, 2.5V				
EFD02F		25A, 440V, 0.08A, 2.5V				
EFD02G		25A, 1.4kV, 0.08A, 2.5V				
EFD02U		25A, 100V, 0.08A, 2.5V				
EFD04A		25A, 200V, 0.08A, 2.5V				
EFD04B		25A, 120V, 0.08A, 2.5V				
EFD04C		25A, 240V, 0.08A, 2.5V				
LTD04D		25A, 800V, 0.08A, 2.5V				
EFD04E		25A, 1kV, 0.08A, 2.5V				
EFD04F		25A, 440V, 0.08A, 2.5V				
EFD04G		25A, 1.4kV, 0.08A, 2.5V				
EFD04U		25A, 100V, 0.08A, 2.5V				
EFD05A		25A, 200V, 0.08A, 2.5V				
EFD05B		25A, 120V, 0.08A, 2.5V				
EFD05C		25A, 240V, 0.08A, 2.5V				

器件型号 Element type	厂名 Manufacturers	材料用途参数 Material Purpose Parameter	图号 Figure	国内外相似替换器件型号 Replace of similar type	备注 Notes	外形参考图 Hetero-CC shape
EFD05D		25A, 800V, 0.08A, 2.5V				
EFD05E		25A, 1kV, 0.08A, 2.5V				
EFD05F		25A, 440V, 0.08A, 2.5V				
EFD05G		25A, 1.4kV, 0.08A, 2.5V				
EFD05U		25A, 100V, 0.08A, 2.5V				
EFD15A		25A, 200V, 0.08A, 2.5V				
EFD15B		25A, 400V, 0.08A, 2.5V				
EFD15C		25A, 600V, 0.08A, 2.5V				
EFD15D		25A, 800V, 0.08A, 2.5V				
EFD15E		25A, 1kV, 0.08A, 2.5V				
EFD15F		25A, 1.2kV, 0.08A, 2.5V				
EFD15G		25A, 1.4kV, 0.08A, 2.5V				
EFD15U		25A, 100V, 0.08A, 2.5V				
EFD16A		25A, 200V, 0.08A, 2.5V				
EFD16B		25A, 400V, 0.08A, 2.5V				
EFD16C		25A, 600V, 0.08A, 2.5V				
EFD16D		25A, 800V, 0.08A, 2.5V				
EFD16E		25A, 1kV, 0.08A, 2.5V				
EFD16F		25A, 1.2kV, 0.08A, 2.5V				
EFD16G		25A, 1.4kV, 0.08A, 2.5V				
EFD16U		25A, 100V, 0.08A, 2.5V				
EFD17A		25A, 200V, 0.08A, 2.5V				
EFD17B		25A, 400V, 0.08A, 2.5V				
EFD17C		25A, 600V, 0.08A, 2.5V				
EFD17D		25A, 800V, 0.08A, 2.5V				
EFD17E		25A, 1kV, 0.08A, 2.5V				
EFD17F		25A, 1.2kV, 0.08A, 2.5V				
EFD17G		25A, 1.4kV, 0.08A, 2.5V				



器件型号 Element type	厂名 Manufacturers	材料用途参数 Material Purpose Parameter	图号 Figure	国内外相似替换器件型号 Repiace of similar type	备注 Notes	外形参考图 Reference shape
EFD17U		25A, 100V, 0.08A, 2.5V				
EFD18A		25A, 200V, 0.08A, 2.5V				
EFD18B		25A, 400V, 0.08A, 2.5V				
EFD18C		25A, 600V, 0.08A, 2.5V				
EFD18D		25A, 800V, 0.08A, 2.5V				
EFD16E		25A, 1kV, 0.08A, 2.5V				
EFD18F		25A, 1.2kV, 0.08A, 2.5V				
EFD18G		25A, 1.4kV, 0.08A, 2.5V				
EFD18U		25A, 100V, 0.08A, 2.5V				
EFD19A		25A, 200V, 0.08A, 2.5V				
EFD19B		25A, 400V, 0.08A, 2.5V				
EFD19C		25A, 600V, 0.08A, 2.5V				
EFD19D		25A, 800V, 0.08A, 2.5V				
EFD19E		25A, 1kV, 0.08A, 2.5V				
EFD19F		25A, 1.2kV, 0.08A, 2.5V				
EFD19G		25A, 1.4kV, 0.08A, 2.5V				
EFD19U		25A, 100V, 0.08A, 2.5V				
EFD20A		25A, 200V, 0.08A, 2.5V				
EFD20B		25A, 400V, 0.08A, 2.5V				
EFD20C		25A, 600V, 0.08A, 2.5V				
EFD20D		25A, 800V, 0.08A, 2.5V				
EFD20E		25A, 1kV, 0.08A, 2.5V				
EFD20F		25A, 1.2kV, 0.08A, 2.5V				
EFD20G		25A, 1.4kV, 0.08A, 2.5V				
EFD20U		25A, 100V, 0.08A, 2.5V				
EFE01A		37A, 200V, 0.08A, 3V				
EFE01B		37A, 120V, 0.08A, 3V				
EFE01C		37A, 240V, 0.08A, 3V				

器件型号 Element type	厂名 Manufacturers	材料用途参数 Material Purpose Parameter	图号 Figure	国内外相似替换器件型号 Replace of similar type	备注 Notes	外形参考图 Reference shape
EFE01D		37A, 600V, 0.08A, 3V				
EFE01E		37A, 1kV, 0.08A, 3V				
EFE01F		37A, 400V, 0.08A, 3V				
EFE01G		37A, 1.4kV, 0.08A, 3V				
LFE01U		37A, 100V, 0.08A, 3V				
EFE02A		37A, 200V, 0.08A, 3V				
EFE02B		37A, 120V, 0.08A, 3V				
EFE02C		37A, 240V, 0.08A, 3V				
EFE02D		37A, 800V, 0.08A, 3V				
EFE02E		37A, 1kV, 0.08A, 3V				
EFE02F		37A, 400V, 0.08A, 3V				
EFE02G		37A, 1.4kV, 0.08A, 3V				
EFE02U		37A, 100V, 0.08A, 3V				
EFE04A		37A, 200V, 0.08A, 3V				
EFE04B		37A, 120V, 0.08A, 3V				
EFE04C		37A, 240V, 0.08A, 3V				
EFE04D		37A, 800V, 0.08A, 3V				
EFE04E		37A, 1kV, 0.08A, 3V				
EFE04F		37A, 400V, 0.08A, 3V				
EFE04G		37A, 1.4kV, 0.08A, 3V				
EFE04U		37A, 100V, 0.08A, 3V				
FPE05A		37A, 200V, 0.08A, 3V				
EFE05B		37A, 120V, 0.08A, 3V				
EFE05C		37A, 240V, 0.08A, 3V				
EFE05D		37A, 800V, 0.08A, 3V				
EFE05E		37A, 1kV, 0.08A, 3V				
EFE05F		37A, 400V, 0.08A, 3V				
EFE05G		37A, 1.4kV, 0.08A, 3V				



器件型号 Element type	厂名 Manufacturers	材料用途参数 Material Purpose Parameter	图号 Figure	国内外相似替换器件型号 Replace of similar type	备注 Notes	外形参考图 Reference shape
EFE05U		37A, 100V, 0.08A, 3V				
EFE15A		37A, 200V, 0.08A, 3V				
EFE15B		37A, 400V, 0.08A, 3V				
EFE15C		37A, 600V, 0.08A, 3V				
EFE15D		37A, 800V, 0.08A, 3V				
EFE15E		37A, 1kV, 0.08A, 3V				
EFE15F		37A, 1.2kV, 0.08A, 3V				
EFE15G		37A, 1.4kV, 0.08A, 3V				
EFE15U		37A, 100V, 0.08A, 3V				
EFE16A		37A, 200V, 0.08A, 3V				
EFE16B		37A, 400V, 0.08A, 3V				
EFE16C		37A, 600V, 0.08A, 3V				
EFE16D		37A, 800V, 0.08A, 3V				
EFE16E		37A, 1kV, 0.08A, 3V				
EFE16F		37A, 1.2kV, 0.08A, 3V				
EFE16G		37A, 1.4kV, 0.08A, 3V				
EFE16U		37A, 100V, 0.08A, 3V				
EFE17A		37A, 200V, 0.08A, 3V				
EFE17B		37A, 400V, 0.08A, 3V				
EFE17C		37A, 600V, 0.08A, 3V				
EFE17D		37A, 800V, 0.08A, 3V				
EFE17E		37A, 1kV, 0.08A, 3V				
EFE17F		37A, 1.2kV, 0.08A, 3V				
EFE17G		37A, 1.4kV, 0.08A, 3V				
EFE17U		37A, 100V, 0.08A, 3V				
EFE18A		37A, 200V, 0.08A, 3V				
EFE18B		37A, 400V, 0.08A, 3V				
EFE18C		37A, 600V, 0.08A, 3V				

器件型号 Element type	厂名 Manufacturers	材料用途参数 Material Purpose Parameter	图号 Figure	国内外相似替换器件型号 Replace of similar type	备注 Notes	外形参考图 Reference shape
EFE18D		37A, 800V, 0.08A, 3V				
EFE18E		37A, 1kV, 0.08A, 3V				
EFE18F		37A, 1.2kV, 0.08A, 3V				
EFE18G		37A, 1.4kV, 0.08A, 3V				
EFE18U		37A, 100V, 0.08A, 3V				
EFE19A		37A, 200V, 0.08A, 3V				
EFE19B		37A, 400V, 0.08A, 3V				
EFE19C		37A, 600V, 0.08A, 3V				
EFE19D		37A, 800V, 0.08A, 3V				
EFE19E		37A, 1kV, 0.08A, 3V				
EFE19F		37A, 1.2kV, 0.08A, 3V				
EFE19G		37A, 1.4kV, 0.08A, 3V				
EFE19U		37A, 100V, 0.08A, 3V				
EFE20A		37A, 200V, 0.08A, 3V				
EFE20B		37A, 400V, 0.08A, 3V				
EFE20C		37A, 600V, 0.08A, 3V				
EFE20D		37A, 800V, 0.08A, 3V				
EFE20E		37A, 1kV, 0.08A, 3V				
EFE20F		37A, 1.2kV, 0.08A, 3V				
EFE20G		37A, 1.4kV, 0.08A, 3V				
EFE20U		37A, 100V, 0.08A, 3V				
EFF01A		50A, 200V, 0.1A, 3V				
EFF01B		50A, 120V, 0.1A, 3V				
EFF01C		50A, 240V, 0.1A, 3V				
EFF01D		50A, 800V, 0.1A, 3V				
EFF01E		50A, 1kV, 0.1A, 3V				
EFF01F		50A, 440V, 0.1A, 3V				
EFF01G		50A, 1.4kV, 0.1A, 3V				



器件型号 Element type	厂名 Manufacturers	材料用途参数 Material Purpose Parameter	图号 Figure	国内外相似替换器件型号 Replace of similar type	备注 Notes	外形参考图 Reference shape
EFF01U		50A, 100V, 0.1A, 3V				
EFF02A		50A, 200V, 0.1A, 3V				
EFF02B		50A, 120V, 0.1A, 3V				
EFF02C		50A, 240V, 0.1A, 3V				
EFF02D		50A, 800V, 0.1A, 3V				
EFF02E		50A, 1kV, 0.1A, 3V				
EFF02F		50A, 440V, 0.1A, 3V				
EFF02G		50A, 1.4kV, 0.1A, 3V				
EFF02U		50A, 100V, 0.1A, 3V				
EFF04A		50A, 200V, 0.1A, 3V				
EFF04B		50A, 120V, 0.1A, 3V				
EFF04C		50A, 240V, 0.1A, 3V				
EFF04D		50A, 800V, 0.1A, 3V				
EFF04E		50A, 1kV, 0.1A, 3V				
EFF04F		50A, 440V, 0.1A, 3V				
EFF04G		50A, 1.4kV, 0.1A, 3V				
EFF04U		50A, 100V, 0.1A, 3V				
EFF05A		50A, 200V, 0.1A, 3V				
EFF05B		50A, 120V, 0.1A, 3V				
EFF05C		50A, 240V, 0.1A, 3V				
EFF05D		50A, 800V, 0.1A, 3V				
EFF05E		50A, 1kV, 0.1A, 3V				
EFF05F		50A, 400V, 0.1A, 3V				
EFF05G		50A, 1.4kV, 0.1A, 3V				
EFF05U		50A, 100V, 0.1A, 3V				
EFF15A		50A, 200V, 0.1A, 3V				
EFF15B		50A, 400V, 0.1A, 3V				

器件型号 Element type	厂名 Manufacturers	材料用途参数 Material Purpose Parameter	图号 Figure	国内外相似替换器件型号 Replace of similar type	备注 Notes	外形参考图 Reference shape
EFF15C		50A, 600V, 0.1A, 3V				
EFF15D		50A, 800V, 0.1A, 3V				
EFF15E		50A, 1kV, 0.1A, 3V				
EFF15F		50A, 1.2kV, 0.1A, 3V				
EFF15G		50A, 1.4kV, 0.1A, 3V				
EFF15U		50A, 100V, 0.1A, 3V				
EFF16A		50A, 200V, 0.1A, 3V				
EFF16B		50A, 400V, 0.1A, 3V				
EFF16C		50A, 600V, 0.1A, 3V				
EFF16D		50A, 800V, 0.1A, 3V				
EFF16E		50A, 1kV, 0.1A, 3V				
EFF16F		50A, 1.2kV, 0.1A, 3V				
EFF16G		50A, 1.4kV, 0.1A, 3V				
EFF16U		50A, 100V, 0.1A, 3V				
EFF17A		50A, 200V, 0.1A, 3V				
EFF17B		50A, 400V, 0.1A, 3V				
EFF17C		50A, 600V, 0.1A, 3V				
EFF17D		50A, 800V, 0.1A, 3V				
EFF17E		50A, 1kV, 0.1A, 3V				
EFF17F		50A, 1.2kV, 0.1A, 3V				
EFF17G		50A, 1.4kV, 0.1A, 3V				
EFF17U		50A, 100V, 0.1A, 3V				
EFF18A		50A, 200V, 0.1A, 3V				
EFF18B		50A, 400V, 0.1A, 3V				
EFF18C		50A, 600V, 0.1A, 3V				
EFF18D		50A, 800V, 0.1A, 3V				
EFF18E		50A, 1kV, 0.1A, 3V				
EFF18F		50A, 1.2kV, 0.1A, 3V				
EFF18G		50A, 1.4kV, 0.1A, 3V				



器件型号 Element type	厂名 Manufacturers	材料用途参数 Material Purpose Parameter	图号 Figure	国内外相似替换器件型号 Replace of similar type	备注 Notes	外形参考图 Reference shape
EFF18U		50A, 100V, 0.1A, 3V				
EFF19A		50A, 200V, 0.1A, 3V				
EFF19B		50A, 400V, 0.1A, 3V				
EFF19C		50A, 600V, 0.1A, 3V				
EFF19D		50A, 800V, 0.1A, 3V				
EFF19E		50A, 1KV, 0.1A, 3V				
EFF19F		50A, 1.2KV, 0.1A, 3V				
EFF19G		50A, 1.4KV, 0.1A, 3V				
EFF19U		50A, 100V, 0.1A, 3V				
EFF20A		50A, 200V, 0.1A, 3V				
EFF20B		50A, 400V, 0.1A, 3V				
EFF20C		50A, 600V, 0.1A, 3V				
EFF20D		50A, 800V, 0.1A, 3V				
EFF20E		50A, 1KV, 0.1A, 3V				
EFF20F		50A, 1.2KV, 0.1A, 3V				
EFF20G		50A, 1.4KV, 0.1A, 3V				
EFF20U		50A, 100V, 0.1A, 3V				
EFG01A		75A, 200V, 0.15A, 3V				
EFG01B		75A, 120V, 0.15A, 3V				
EFG01C		75A, 240V, 0.15A, 3V				
EFG01D		75A, 800V, 0.15A, 3V				
EFG01E		75A, 1KV, 0.15A, 3V				
EFG01F		75A, 440V, 0.15A, 3V				
EFG01G		75A, 1.4KV, 0.15A, 3V				
EFG01U		75A, 100V, 0.15A, 3V				
EFG02A		75A, 200V, 0.15A, 3V				
EFG02B		75A, 120V, 0.15A, 3V				
EFG02C		75A, 240V, 0.15A, 3V				

器件型号 Element type	厂名 Manufacturers	材料用途参数 Material Purpose Parameter	图号 Figure	国内外相似替换器件型号 Replace of similar type	备注 Notes	外形参考图 Reference shape
EFG02D		75A, 800V, 0.15A, 3V				
EFG02E		75A, 1kV, 0.15A, 3V				
EFG02F		75A, 440V, 0.15A, 3V				
EFG02G		75A, 1.4kV, 0.15A, 3V				
EFG02U		75A, 100V, 0.15A, 3V				
EFG04A		75A, 200V, 0.15A, 3V				
EFG04B		75A, 120V, 0.15A, 3V				
EFG04C		75A, 240V, 0.15A, 3V				
EFG04D		75A, 800V, 0.15A, 3V				
EFG04E		75A, 1kV, 0.15A, 3V				
EFG04F		75A, 440V, 0.15A, 3V				
EFG04G		75A, 1.4kV, 0.15A, 3V				
EFG04U		75A, 100V, 0.15A, 3V				
EFG05A		75A, 200V, 0.15A, 3V				
EFG05B		75A, 120V, 0.15A, 3V				
EFG05C		75A, 240V, 0.15A, 3V				
EFG05D		75A, 800V, 0.15A, 3V				
EFG05E		75A, 1kV, 0.15A, 3V				
EFG05F		75A, 440V, 0.15A, 3V				
EFG05G		75A, 1.4kV, 0.15A, 3V				
EFG05U		75A, 100V, 0.15A, 3V				
EFG15A		75A, 200V, 0.15A, 3V				
EFG15B		75A, 400V, 0.15A, 3V				
EFG15C		75A, 600V, 0.15A, 3V				
EFG15D		75A, 800V, 0.15A, 3V				
EFG15E		75A, 1kV, 0.15A, 3V				
EFG15F		75A, 1.2kV, 0.15A, 3V				



器件型号 Element type	厂名 Manufacturers	材料用途参数 Material Purpose Parameter	图号 Figure	国内外相似替换器件型号 Rep ace of similar type	备注 Notes	外形参考图 Reference shape
EFG15G		75A, 1.4kV, 0.15A, 3V				
EFG15U		75A, 100V, 0.15A, 3V				
EFG16A		75A, 200V, 0.15A, 3V				
EFG16B		75A, 400V, 0.15A, 3V				
EFG16C		75A, 600V, 0.15A, 3V				
EFG16D		75A, 800V, 0.15A, 3V				
EFG16E		75A, 1kV, 0.15A, 3V				
EFG16F		75A, 1.2kV, 0.15A, 3V				
EFG16G		75A, 1.4kV, 0.15A, 3V				
EFG16U		75A, 100V, 0.15A, 3V				
EFG17A		75A, 200V, 0.15A, 3V				
EFG17B		75A, 400V, 0.15A, 3V				
EFG17C		75A, 600V, 0.15A, 3V				
EFG17D		75A, 800V, 0.15A, 3V				
EFG17E		75A, 1kV, 0.15A, 3V				
EFG17G		75A, 1.2kV, 0.15A, 3V				
EFG17U		75A, 100V, 0.15A, 3V				
EFG18A		75A, 200V, 0.15A, 3V				
EFG18B		75A, 400V, 0.15A, 3V				
EFG18C		75A, 600V, 0.15A, 3V				
EFG18D		75A, 800V, 0.15A, 3V				
EFG18E		75A, 1kV, 0.15A, 3V				
EFG18F		75A, 1.2kV, 0.15A, 3V				
EFG18G		75A, 1.4kV, 0.15A, 3V				
EFG18U		75A, 100V, 0.15A, 3V				
FFG19A		75A, 200V, 0.15A, 3V				
EFG19B		75A, 400V, 0.15A, 3V				
EFG19C		75A, 600V, 0.15A, 3V				
EFG19D		75A, 800V, 0.15A, 3V				

器件型号 Element type	厂名 Manufacturers	材料用途参数 Material Purpose Parameter	图号 Figure	国内外相似替换器件型号 Replace of similar type	备注 Notes	外形参考图 Reference shape
EFG19E		75A, 1kV, 0.15A, 3V				
EFG19F		75A, 1.2kV, 0.15A, 3V				
EFG19G		75A, 1.4kV, 0.15A, 3V				
EFG19U		75A, 100V, 0.15A, 3V				
EFG20A		75A, 200V, 0.15A, 3V				
EFG20B		75A, 400V, 0.15A, 3V				
EFG20C		75A, 600V, 0.15A, 3V				
EFG20D		75A, 800V, 0.15A, 3V				
EFG20E		75A, 1kV, 0.15A, 3V				
EFG20F		75A, 1.2kV, 0.15A, 3V				
EFG20G		75A, 1.4kV, 0.15A, 3V				
EFG20U		75A, 100V, 0.15A, 3V				
EGD06-02		10A, 200V, 0.5A	F-2			
EGD06-04		10A, 400V, 0.5A	F-2			
EGD06-06		10A, 600V, 0.5A	F-2			
EGD06-08		10A, 800V, 0.5A	F-2			
EGE06-02		20A, 200V, 0.5A	F-2			
EGE06-04		20A, 400V, 0.5A	F-2			
EGE06-06		20A, 600V, 0.5A	F-2			
EGE06-08		20A, 800V, 0.5A	F-2			
EGE16-02		20A, 200V, 0.5A	F-2			
EGE16-04		20A, 400V, 0.5A	F-2			
EGE16-06		20A, 600V, 0.5A	F-2			
EGE16-08		20A, 800V, 0.5A	F-2			
EGG06-02		40A, 200V, 0.5A	F-6			
EGG06-04		40A, 400V, 0.5A	F-6			
EGG06-06		40A, 600V, 0.5A	F-6			







图 F-2

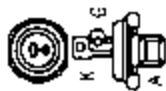

图 F-6

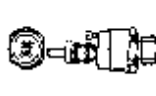

器件型号 Element type	厂名 Manufacturers	材料用途参数 Material Purpose Parameter	图号 Figure	国内外相似替换器型号 Replace of similar type	备注 Notes	外形参考图 Reference shape
EGG06-08		40A, 800V, 0.5A	F-6			 图 F-6
EGH16-06		75A, 600V, 0.5A	F-91			
EGH16A-06		75A, 600V, 0.5A	F-91			
EGH16-08		75A, 800V, 0.5A	F-91			
EGH16A-08		75A, 800V, 0.5A	F-91			
EGH16-10		75A, 1kV, 0.5A	F-91			
EGH16A-10		75A, 1kV, 0.5A	F-91			
EGH16-12		75A, 1.2kV, 0.5A	F-91			
LGH16A-12		75A, 1.2kV, 0.5A	F-91			
EGH16-16		75A, 1.6kV, 0.5A	F-91			
EGH16A-16		75A, 1.6kV, 0.5A	F-91			
EGHA-06		75A, 600V, 0.5A	F-91			 图 F-91
EGHA-08		75A, 800V, 0.5A	F-91			
EGHA-10		75A, 1kV, 0.5A	F-91			
ECGA-12		75A, 1.2kV, 0.5A	F-91			
EGHA-16		75A, 1.6kV, 0.5A	F-91			
EGL16-06		150A, 600V, 0.5A	F-91			
EGL16A-06		150A, 600V, 0.5A	F-54			 图 F-54
EGL16-08		150A, 800V, 0.5A	F-54			
EGL16A-08		150A, 800V, 0.5A	F-54			
EGL16-10		150A, 1kV, 0.5A	F-54			
EGL16A-10		150A, 1kV, 0.5A	F-54			
EGL16-12		150A, 1.2kV, 0.5A	F-54			
EGL16A-12		150A, 1.2kV, 0.5A	F-54			
EGL16-16		150A, 1.6kV, 0.5A	F-54			
EGL16A-16		150A, 1.6kV, 0.5A	F-54			

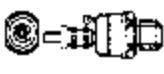
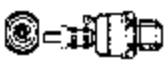
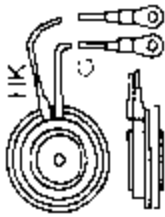
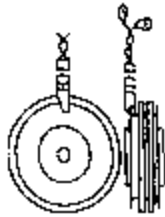
器件型号 Element type	厂名 Manufacturers	材料用途参数 Material Purpose Parameter	图号 Figure	国内外相似替换器件型号 Replace of similar type	备注 Notes	外形参考图 Reference shape
EGLA-06		150A, 600V, 0.5A	F-91			 图 F-91
EGLA-08		150A, 800V, 0.5A	F-54			
EGLA-10		150A, 1kV, 0.5A	F-54			
EGLA-12		150A, 1.2kV, 0.5A	F-54			
EGLA-16		150A, 1.6kV, 0.5A	F-54			
EGN05-06		300A, 600V, 0.5A				 图 F-54
EGN05-08		300A, 800V, 0.5A				
EGN05-10		300A, 1kV, 0.5A				
EGN05-12		300A, 1.2kV, 0.5A				
EGN05-16		300A, 1.6kV, 0.5A				
EGN13-16		400A, 1.6kV, 0.5A		C-67		 图 F-54
EGN14-08		450A, 800V, 0.5A		C-67		
ECN24-06	SCR-H	250A, 600V, 0.5A				
EGN24-08	SCR-H	250A, 800V, 0.5A				
EGN26-08	SCR-H	400A, 800V, 0.5A		C-67		
EGP04-25		500A, 2.5kV, 0.5A		C-25		 图 C-67
EGP13-16		700A, 1.6kV, 0.5A		C-67		
EGP14-08		700A, 1.6kV, 0.5A		C-67		
EGP26-13A	SCR-H	460A, 1.3kV, 0.5A		C-67		
EGP26-13B	SCR-H	460A, 1.3kV, 0.5A		C-67		
EGR03-25		1kA, 2.5kV, 0.5A		C-67		 图 C-25
ES651		55A, 120V, 0.11A, 3V				
ES652		55A, 240V, 0.11A, 3V				
ES653		55A, 280V, 0.11A, 3V				
ES654		55A, 480V, 0.11A, 3V				



器件型号 Element type	厂名 Manufacturers	材料用途参数 Material Purpose Parameter	图号 Figure	国内外相似替换器件型号 Replace of similar type	备注 Notes	外形参考图 Reference shape
ES661		55A, 120V, 0.11A, 3V				
ES662		55A, 240V, 0.11A, 3V				
ES663		55A, 280V, 0.11A, 3V				
ES664		55A, 480V, 0.11A, 3V				
ES671...4		55A, 0.11A, 3V				
ES681...4		55A, 0.11A, 3V				
ES771...4		60A, 0.11A, 3V				
ES781...4		60A, 0.11A, 3V				
ES791		60A, 120V, 0.11A, 3V				
ES792		60A, 240V, 0.11A, 3V				
ES793		60A, 280V, 0.11A, 3V				
ES794		60A, 480V, 0.11A, 3V				
ES861		75A, 120V, 0.11A, 3V				
ES862		75A, 240V, 0.11A, 3V				
ES863		75A, 280V, 0.11A, 3V				
ES864		75A, 480V, 0.11A, 3V				
ES861		75A, 120V, 0.11A, 3V				
ES862		75A, 240V, 0.11A, 3V				
ES863		75A, 280V, 0.11A, 3V				
ES864		75A, 480V, 0.11A, 3V				
ES871...4		75A, 0.11A, 3V				
ES881...4		75A, 0.11A, 3V				
ES891		75A, 120V, 0.11A, 3V				

器件型号 Element type	厂名 Manufacturers	材料用途参数 Material Purpose Parameter	图号 Figure	国内外相似替换器件型号 Replace of similar type	备注 Notes	外形参考图 Reference shape
ES892		75A, 240V, 0.11A, 3V				
ES893		75A, 280V, 0.11A, 3V				
ES894		75A, 480V, 0.11A, 3V				
ES951		110A, 120V, 0.125A, 3V				
ES952		110A, 240V, 0.125A, 3V				
ES953		110A, 280V, 0.125A, 3V				
ES954		110A, 480V, 0.125A, 3V				
ES961		110A, 120V, 0.12A, 3V				
ES962		110A, 240V, 0.12A, 3V				
ES963		110A, 280V, 0.12A, 3V				
ES964		110A, 480V, 0.12A, 3V				
ES971...4		110A, 0.12A, 3V				
ES981...4		110A, 0.125A, 3V				
ES991		110A, 120V, 0.125A, 3V				
ES992		110A, 240V, 0.125A, 3V				
ES993		110A, 280V, 0.125A, 3V				
ES994		110A, 480V, 0.125A, 3V				
ESM22-100...600(N)	SCR-D	2.5A, 100-600V, 0.04A	B-62	T2303... , TAG208...		
ESM23-100...600	SCR-D	6A, 100-600V, 0.08A	D-9	T4700... , TAG260... , TAG265...		
ESM188M/450...750	SCR-D	TV-HA, 5A, 450-750V, 0.06A	D-9	BS1CC01...H, S3703... , TD3F...H		
ESM189M/450...750	SCR-D	TV-HA, 5A, 450-750V, 0.06A	D-9	BS1CC01...R, S6080C... , TD3F...R		
ESM228M/450...750	SCR-D	TV-HA, 5A, 450-750V, 0.06A	D-9	BS1CC01...H, TD3F...H, TD4F...H		
ESM229M/450...750	SCR-D	TV-HA, 5A, 450-750V, 0.06A	D-9	BS1CC01...R, TD3F...R, TD4F...R		
ESM249R/500	SCR-D	5A, 500V, 0.06A, 25 μ s	D-9	S6087B, TD3F500H, TD4F500H		



图 B-62



图 D-9



器件型号 Element type	厂名 Manufacturers	材料用途参数 Material Purpose Parameter	图号 Figure	国内外相似替换器件型号 Replace of similar type	备注 Notes	外形参考图 Reference shape
ESM313/...R	SCR-H	40A, 100-600V, 0.15A	D-10	TAG620..., TAG630..., TIC116...		
ESM504/...	50Hz-Thy	4A, 50-600V, 0.02A	B-11	TAG655-..., 2N6394...-6399		
ESM508/...	50Hz-Thy	8A, 50-600V, 0.04A	B-11	BS1D10..., BT152/..., 2N6394...-6399		
ESM509/...	50Hz-Thy	10A, 50-600V, 0.04A	B-11			
ESM740(G)		10A, -5-300V, 0.05A, 15μs	B-97			
ESP43	ELT	DAC, 1.5A, 36V, 3V				
EU181A	GTN	18A, 200V, 0.16A, 2.5V	H-29			
EU181B	GTN	18A, 400V, 0.16A, 2.5V	H-29			
EU181C	GTN	18A, 600V, 0.16A, 2.5V	H-29			
EU181D	GTN	18A, 800V, 0.16A, 2.5V	H-29			
EU181E	GTN	18A, 1kV, 0.16A, 2.5V	H-29			
EU181F	GTN	18A, 1.2kV, 0.16A, 2.5V	H-29			
EU181G	GTN	18A, 1.4kV, 0.16A, 2.5V	H-29			
EU182A	GTN	18A, 200V, 0.16A, 2.5V	H-29			
EU182B	GTN	18A, 400V, 0.16A, 2.5V	H-29			
EU182C	GTN	18A, 600V, 0.16A, 2.5V	H-29			
EU182D	GTN	18A, 800V, 0.16A, 2.5V	H-29			
EU182E	GTN	18A, 1kV, 0.16A, 2.5V	H-29			
EU182F	GTN	18A, 1.2kV, 0.16A, 2.5V	H-29			
EU182G	GTN	18A, 1.4kV, 0.16A, 2.5V	H-29			
EU183A	GTN	18A, 200V, 0.16A, 2.5V	H-29			
EU183B	GTN	18A, 400V, 0.16A, 2.5V	H-29			
EU183C	GTN	18A, 600V, 0.16A, 2.5V	H-29			
EU183D	GTN	18A, 800V, 0.16A, 2.5V	H-29			
EU183E	GTN	18A, 1kV, 0.16A, 2.5V	H-29			
EU183F	GTN	18A, 1.2kV, 0.16A, 2.5V	H-29			
EU183G	GTN	18A, 1.4kV, 0.16A, 2.5V	H-29			

图 D-10

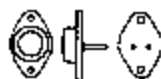

图 B-11

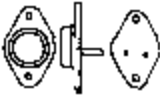

图 B-97

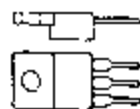

图 H-29

器件型号 Element type	厂名 Manufacturers	材料用途参数 Material Purpose Parameter	图号 Figure	国内外相似替换器型号 Replace of similar type	备注 Notes	外形参考图 Reference shape
EU184A	GTN	SCB 18A, 200V, 0.16A, 2.5V	H-29			
EU184B	GTN	SCB 18A, 400V, 0.16A, 2.5V	H-29			
EU184C	GTN	SCB 18A, 600V, 0.16A, 2.5V	H-29			
EU184D	GTN	SCB 18A, 800V, 0.16A, 2.5V	H-29			
EU184E	GTN	SCB 18A, 1kV, 0.16A, 2.5V	H-29			
EU184F	GTN	SCB 18A, 1.2kV, 0.16A, 2.5V	H-29			
EU184G	GTN	SCB 18A, 1.4kV, 0.16A, 2.5V	H-29			
EU251A	GTN	SCB 25A, 200V, 0.16A, 2.5V	H-29			
EU251B	GTN	SCB 25A, 400V, 0.16A, 2.5V	H-29			
EU251C	GTN	SCB 25A, 600V, 0.16A, 2.5V	H-29			
EU251D	GTN	SCB 25A, 800V, 0.16A, 2.5V	H-29			
EU251E	GTN	SCB 25A, 1kV, 0.16A, 2.5V	H-29			
EU251F	GTN	SCB 25A, 1.2kV, 0.16A, 2.5V	H-29			
EU251G	GTN	SCB 25A, 1.4kV, 0.16A, 2.5V	H-29			
EU252A	GTN	SCB 25A, 200V, 0.16A, 2.5V	H-29			
EU252B	GTN	SCB 25A, 400V, 0.16A, 2.5V	H-29			
EU252C	GTN	SCB 25A, 600V, 0.16A, 2.5V	H-29			
EU252D	GTN	SCB 25A, 800V, 0.16A, 2.5V	H-29			
EU252E	GTN	SCB 25A, 1kV, 0.16A, 2.5V	H-29			
EU252F	GTN	SCB 25A, 1.2kV, 0.16A, 2.5V	H-29			
EU252G	GTN	SCB 25A, 1.4kV, 0.16A, 2.5V	H-29			
EU253A	GTN	SCB 25A, 200V, 0.16A, 2.5V	H-29			
EU253B	GTN	SCB 25A, 400V, 0.16A, 2.5V	H-29			
EU253C	GTN	SCB 25A, 600V, 0.16A, 2.5V	H-29			
EU253D	GTN	SCB 25A, 800V, 0.16A, 2.5V	H-29			
EU253E	GTN	SCB 25A, 1kV, 0.16A, 2.5V	H-29			
EU253F	GTN	SCB 25A, 1.2kV, 0.16A, 2.5V	H-29			
EU253G	GTN	SCB 25A, 1.4kV, 0.16A, 2.5V	H-29			

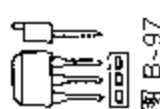
器件型号 Element type	厂名 Manufacturers	材料用途参数 Material Purpose Parameter	图号 Figure	国内外相似替换器件型号 Replace of similar type	备注 Notes	外形参考图 Reference shape
EU254A	GTN	SCB 25A, 200V, 0.16A, 2.5V	H-29			 <p>图 H-29</p>
EU254B	GTN	SCB 25A, 400V, 0.16A, 2.5V	H-29			
EU254C	GTN	SCB 25A, 600V, 0.16A, 2.5V	H-29			
EU254D	GTN	SCB 25A, 800V, 0.16A, 2.5V	H-29			
EU254E	GTN	SCB 25A, 1kV, 0.16A, 2.5V	H-29			
EU254F	GTN	SCB 25A, 1.2kV, 0.16A, 2.5V	H-29			
EU254G	GTN	SCB 25A, 1.4kV, 0.16A, 2.5V	H-29			
EU255A	GTN	SCB 25A, 200V, 0.16A, 2.5V	H-29			
EU255B	GTN	SCB 25A, 400V, 0.16A, 2.5V	H-29			
EU255C	GTN	SCB 25A, 600V, 0.16A, 2.5V	H-29			
EU255D	GTN	SCB 25A, 800V, 0.16A, 2.5V	H-29			
EU255E	GTN	SCB 25A, 1kV, 0.16A, 2.5V	H-29			
EU255F	GTN	SCB 25A, 1.2kV, 0.16A, 2.5V	H-29			
EU255G	GTN	SCB 25A, 1.4kV, 0.16A, 2.5V	H-29			
EU401A	GTN	SCB 40A, 200V, 0.16A, 3V	H-29			
EU401B	GTN	SCB 40A, 400V, 0.16A, 3V	H-29			
EU401C	GTN	SCB 40A, 600V, 0.16A, 3V	H-29			
EU401D	GTN	SCB 40A, 800V, 0.16A, 3V	H-29			
EU401E	GTN	SCB 40A, 1kV, 0.16A, 3V	H-29			
EU401F	GTN	SCB 40A, 1.2kV, 0.16A, 3V	H-29			
EU401G	GTN	SCB 40A, 1.4kV, 0.16A, 3V	H-29			
EU402A	GTN	SCB 40A, 200V, 0.16A, 3V	H-29			
EU402B	GTN	SCB 40A, 400V, 0.16A, 3V	H-29			
EU402C	GTN	SCB 40A, 600V, 0.16A, 3V	H-29			
EU402D	GTN	SCB 40A, 800V, 0.16A, 3V	H-29			
EU402E	GTN	SCB 40A, 1kV, 0.16A, 3V	H-29			
EU402F	GTN	SCB 40A, 1.2kV, 0.16A, 3V	H-29			
EU402G	GTN	SCB 40A, 1.4kV, 0.16A, 3V	H-29			

器件型号 Element type	厂名 Manufacturers	材料用途参数 Material Purpose Parameter	图号 Figure	国内外相似替换器件型号 Replace of similar type	备注 Notes	外形参考图 Reference shape
EU403A	GTN	SCB 40A, 200V, 0.16A, 3V	H-29			 <p>图 H-29</p>
EU403B	GTN	SCB 40A, 400V, 0.16A, 3V	H 29			
EU403C	GTN	SCB 40A, 600V, 0.16A, 3V	H-29			
EU403D	GTN	SCB 40A, 800V, 0.16A, 3V	H-29			
EU403E	GTN	SCB 40A, 1kV, 0.16A, 3V	H 29			
EU403F	GTN	SCB 40A, 1.2kV, 0.16A, 3V	H-29			
EU403G	GTN	SCB 40A, 1.4kV, 0.16A, 3V	H-29			
EU404A	GTN	SCB 40A, 200V, 0.16A, 3V	H 29			
EU404B	GTN	SCB 40A, 400V, 0.16A, 3V	H-29			
EU404C	GTN	SCB 40A, 600V, 0.16A, 3V	H-29			
EU404D	GTN	SCB 40A, 800V, 0.16A, 3V	H-29			
EU404E	GTN	SCB 40A, 1kV, 0.16A, 3V	H-29			
EU404F	GTN	SCB 40A, 1.2kV, 0.16A, 3V	H-29			
EU404G	GTN	SCB 40A, 1.4kV, 0.16A, 3V	H-29			
EU405A	GTN	SCB 40A, 200V, 0.16A, 3V	H-29			
EU405B	GTN	SCB 40A, 400V, 0.16A, 3V	H 29			
EU405C	GTN	SCB 40A, 600V, 0.16A, 3V	H-29			
EU405D	GJN	SCB 40A, 800V, 0.16A, 3V	H-29			
EU405E	GTN	SCB 40A, 1kV, 0.16A, 3V	H-29			
EU405F	GTN	SCB 40A, 1.2kV, 0.16A, 3V	H-29			
EU405G	GTN	SCB 40A, 1.4kV, 0.16A, 3V	H-29			
EU551A	GTN	SCB 55A, 200V, 0.3A, 3V	H-29			
EU551B	GTN	SCB 55A, 400V, 0.3A, 3V	H-29			
EU551C	GTN	SCB 55A, 600V, 0.3A, 3V	H-29			
EU551D	GTN	SCB 55A, 800V, 0.3A, 3V	H-29			
EU551E	GTN	SCB 55A, 1kV, 0.3A, 3V	H 29			
EU551F	GTN	SCB 55A, 1.2kV, 0.3A, 3V	H-29			
EU551G	GTN	SCB 55A, 1.4kV, 0.3A, 3V	H-29			

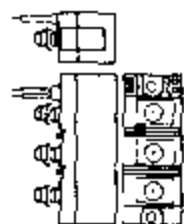
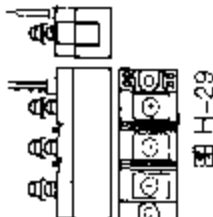
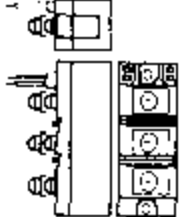
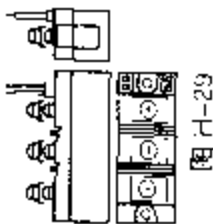
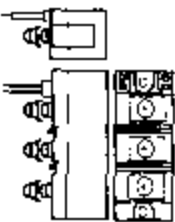
器件型号 Element type	厂名 Manufacturers	材料用途参数 Material Purpose Parameter	图号 Figure	国内外相似替换器型号 Replace of similar type	备注 Notes	外形参考图 Reference shape
EU552A	GTN	SCB 55A, 200V, 0.3A, 3V	H-29			 <p>图 H-29</p>
EU552B	GTN	SCB 55A, 400V, 0.3A, 3V	H-29			
EU552C	GTN	SCB 55A, 600V, 0.3A, 3V	H-29			
EU552D	GTN	SCB 55A, 800V, 0.3A, 3V	H-29			
EU552E	GTN	SCB 55A, 1kV, 0.3A, 3V	H-29			
EU552F	GTN	SCB 55A, 1.2kV, 0.3A, 3V	H-29			
EU552G	GTN	SCB 55A, 1.4kV, 0.3A, 3V	H-29			
EU553A	GTN	SCB 55A, 200V, 0.3A, 3V	H-29			
EU553B	GTN	SCB 55A, 400V, 0.3A, 3V	H-29			
EU553C	GTN	SCB 55A, 600V, 0.3A, 3V	H-29			
EU553D	GTN	SCB 55A, 800V, 0.3A, 3V	H-29			
EU553E	GTN	SCB 55A, 1kV, 0.3A, 3V	H-29			
EU553F	GTN	SCB 55A, 1.2kV, 0.3A, 3V	H-29			
EU553G	GTN	SCB 55A, 1.4kV, 0.3A, 3V	H-29			
EU554A	GTN	SCB 55A, 200V, 0.3A, 3V	H-29			
EU554B	GTN	SCB 55A, 400V, 0.3A, 3V	H-29			
EU554C	GTN	SCB 55A, 600V, 0.3A, 3V	H-29			
EU554D	GTN	SCB 55A, 800V, 0.3A, 3V	H-29			
EU554E	GTN	SCB 55A, 1kV, 0.3A, 3V	H-29			
EU554F	GTN	SCB 55A, 1.2kV, 0.3A, 3V	H-29			
EU554G	GTN	SCB 55A, 1.4kV, 0.3A, 3V	H-29			
EU555A	GTN	SCB 55A, 200V, 0.3A, 3V	H-29			
EU555B	GTN	SCB 55A, 400V, 0.3A, 3V	H-29			
EU555C	GTN	SCB 55A, 600V, 0.3A, 3V	H-29			
EU555D	GTN	SCB 55A, 800V, 0.3A, 3V	H-29			
EU555E	GTN	SCB 55A, 1kV, 0.3A, 3V	H-29			
EU555F	GTN	SCB 55A, 1.2kV, 0.3A, 3V	H-29			
EU555G	GTN	SCB 55A, 1.4kV, 0.3A, 3V	H-29			

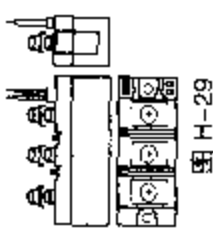
器件型号 Element type	厂名 Manufacturers	材料用途参数 Material Purpose Parameter	图号 Figure	国内外相似替换器作型号 Replace of similar type	备注 Notes	外形参考图 Reference shape
EU901A	GTN	SCB 90A, 200V, 0.3A, 3V	H-29			 <p>图 H-29</p>
EU901B	GTN	SCB 90A, 400V, 0.3A, 3V	H-29			
EU901C	GTN	SCB 90A, 600V, 0.3A, 3V	H-29			
EU901D	GTN	SCB 90A, 800V, 0.3A, 3V	H-29			
EU901E	GTN	SCB 90A, 1kV, 0.3A, 3V	H-29			
EU901F	GTN	SCB 90A, 1.2kV, 0.3A, 3V	H-29			
EU901G	GTN	SCB 90A, 1.4kV, 0.3A, 3V	H-29			
EU902A	GTN	SCB 90A, 200V, 0.3A, 3V	H-29			
EU902B	GTN	SCB 90A, 400V, 0.3A, 3V	H-29			
EU902C	GTN	SCB 90A, 600V, 0.3A, 3V	H-29			
EU902D	GTN	SCB 90A, 800V, 0.3A, 3V	H-29			
EU902E	GTN	SCB 90A, 1kV, 0.3A, 3V	H-29			
EU902F	GTN	SCB 90A, 1.2kV, 0.3A, 3V	H-29			
EU902G	GTN	SCB 90A, 1.4kV, 0.3A, 3V	H-29			
EU903A	GTN	SCB 90A, 200V, 0.3A, 3V	H-29			
EU903B	GTN	SCB 90A, 400V, 0.3A, 3V	H-29			
EU903C	GTN	SCB 90A, 600V, 0.3A, 3V	H-29			
EU903D	GTN	SCB 90A, 800V, 0.3A, 3V	H-29			
EU903F	GTN	SCB 90A, 1kV, 0.3A, 3V	H-29			
EU903F	GTN	SCB 90A, 1.2kV, 0.3A, 3V	H-29			
EU903G	GTN	SCB 90A, 1.4kV, 0.3A, 3V	H-29			
EU904A	GTN	SCB 90A, 200V, 0.3A, 3V	H-29			
EU904B	GTN	SCB 90A, 400V, 0.3A, 3V	H-29			
EU904C	GTN	SCB 90A, 600V, 0.3A, 3V	H-29			
EU904D	GTN	SCB 90A, 800V, 0.3A, 3V	H-29			
EU904E	GTN	SCB 90A, 1kV, 0.3A, 3V	H-29			
EU904F	GTN	SCB 90A, 1.2kV, 0.3A, 3V	H-29			
EU904G	GTN	SCB 90A, 1.4kV, 0.3A, 3V	H-29			
EU905A	GTN	SCB 90A, 200V, 0.3A, 3V	H-29			

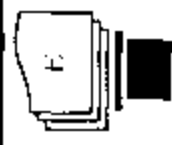

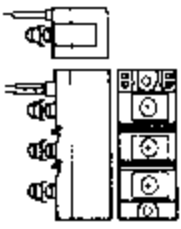
器件型号 Element type	厂名 Manufacturers	材料用途参数 Material Purpose Parameter	图号 Figure	国内外相似替换器件型号 Replace of similar type	备注 Notes	外形参考图 Reference shape
EU905B	GTN	SCB 90A, 400V, 0.3A, 3V	H-29			 <p>图 H-29</p>
EU905C	GTN	SCB 90A, 600V, 0.3A, 3V	H-29			
EU905D	GTN	SCB 90A, 800V, 0.3A, 3V	H-29			
EU905E	GTN	SCB 90A, 1kV, 0.3A, 3V	H-29			
EU905F	GTN	SCB 90A, 1.2kV, 0.3A, 3V	H-29			
EU905G	GTN	SCB 90A, 1.4kV, 0.3A, 3V	H-29			

E 类外形参考图索引



图 B-11



图 B-36

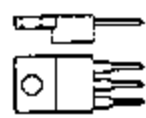

图 B-44

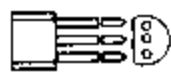

图 B-62



图 B-65



图 B-91



图 B-97

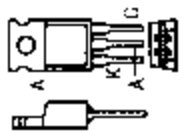

图 C-10



图 C-25



图 C-35

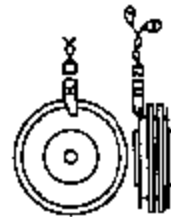

图 C-50

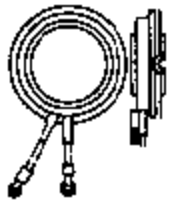

图 C-67

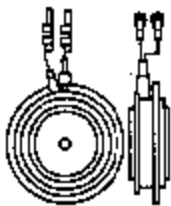

图 C-70

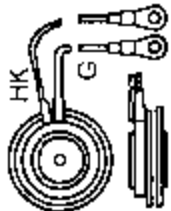

图 D-9



图 D-10

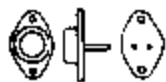

图 F-2

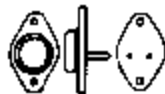

图 F-6



图 F-54



图 F-91









图 I-29

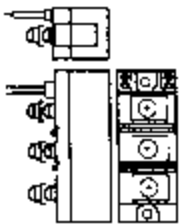
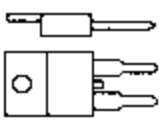

器件型号 Element type	厂名 Manufacturers	材料用途参数 Material Purpose Parameter	图号 Figure	国内外相似替换器件型号 Replace of similar type	备注 Notes	外形参考图 Reference shape
F0810BH	TAG	50Hz-Thy 5.1A, 200V, 0.25A, 2V	B-9	MCR218-4, TIC116B, TAG660-200		
F0810DH	TAG	50Hz-Thy 5.1A, 400V, 0.25A, 2V	B-9	BSIC1040M, MCR218-6, TIC116D, TAG660-400		
F0810MH	TAG	50Hz-Thy 5.1A, 600V, 0.25A, 2V	B-9	BSIC1050M, MCR218-8, TIC116M, TAG660-500		
F0810NH	TAG	50Hz-Thy 5.1A, 800V, 0.25A, 2V	B-9	BSIC1080M, MCR218-10, TIC116-10, TAG660-800		
F1612BH	TAG	50Hz-Thy 10A, 200V, 0.05A, 2V	B-91	CS15-02er1, 2N6402, 2N6403		
F1612DH	TAG	50Hz-Thy 10A, 400V, 0.05A, 2V	B-91	BSID1026M, CS15-04er1, T9.5N400FOB, 2N6403, 2N6404		
F1612MH	TAG	50Hz-Thy 10A, 600V, 0.05A, 2V	B-91	BSID1040M, CS15-06ep1, T9.5N600FOB, 2N6404, 2N6405		
F1612NH	TAG	50Hz-Thy 10A, 800V, 0.05A, 2V	B-91	BSID1053M, CS15-08ep1, T9.5N800FOB, 2N6405		
FB100D-4...24		SCR-D 100A, 0.2-1.2KV	C-49			
FB150D-4...24		SCR-D 150A, 0.2-1.2KV	C-62			
FB300D-4...24		SCR-D 300A, 0.2-1.2KV	C-62			
FC01A	GTN	SCB 17A, 200V, 0.08A, 2.5V	H-32			
FC01B	GTN	SCB 17A, 400V, 0.08A, 2.5V	H-32			
FC01C	GTN	SCB 17A, 600V, 0.08A, 2.5V	H-32			
FC01D	GTN	SCB 17A, 800V, 0.08A, 2.5V	H-32			
FC01E	GTN	SCB 17A, 1KV, 0.08A, 2.5V	H-32			
FC01F	GTN	SCB 17A, 1.2KV, 0.08A, 2.5V	H-32			
FC01G	GTN	SCB 17A, 1.4KV, 0.08A, 2.5V	H-32			
FC01U	GTN	SCB 17A, 100V, 0.08A, 2.5V	H-32			
FC02A	GTN	SCB 17A, 200V, 0.08A, 2.5V	H-32			
FC02B	GTN	SCB 17A, 400V, 0.08A, 2.5V	H-32			
FC02C	GTN	SCB 17A, 600V, 0.08A, 2.5V	H-32			
FC02D	GTN	SCB 17A, 800V, 0.08A, 2.5V	H-32			

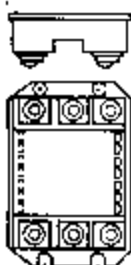

器件型号 Element type	厂名 Manufacturers	材料用途参数 Material Purpose Parameter	图号 Figure	国内外相似替换器件型号 Replace of similar type	备注 Notes	外形参考图 Reference shape
FC02E	GTN	SCB 17A, 1kV, 0.08A, 2.5V	H-32			 <p>图 H-32</p>
FC02F	GTN	SCB 17A, 1.2kV, 0.08A, 2.5V	H-32			
FC02G	GTN	SCB 17A, 1.4kV, 0.08A, 2.5V	H-32			
FC02U	GTN	SCB 17A, 100V, 0.08A, 2.5V	H-32			
FC04A	GTN	SCB 17A, 200V, 0.08A, 2.5V	H-32			
FC04B	GTN	SCB 17A, 400V, 0.08A, 2.5V	H-32			
FC04C	GTN	SCB 17A, 600V, 0.08A, 2.5V	H-32			
FC04D	GTN	SCB 17A, 800V, 0.08A, 2.5V	H-32			
FC04E	GTN	SCB 17A, 1kV, 0.08A, 2.5V	H-32			
FC04F	GTN	SCB 17A, 1.2kV, 0.08A, 2.5V	H-32			
FC04G	GTN	SCB 17A, 1.4kV, 0.08A, 2.5V	H-32			
FC04U	GTN	SCB 17A, 100V, 0.08A, 2.5V	H-32			
FC05A	GTN	SCB 17A, 200V, 0.08A, 2.5V	H-32			
FC05B	GTN	SCB 17A, 400V, 0.08A, 2.5V	H-32			
FC05C	GTN	SCB 17A, 600V, 0.08A, 2.5V	H-32			
FC05D	GTN	SCB 17A, 800V, 0.08A, 2.5V	H-32			
FC05E	GTN	SCB 17A, 1kV, 0.08A, 2.5V	H-32			
FC05F	GTN	SCB 17A, 1.2kV, 0.08A, 2.5V	H-32			
FC05G	GTN	SCB 17A, 1.4kV, 0.08A, 2.5V	H-32			
FC05U	GTN	SCB 17A, 100V, 0.08A, 2.5V	H-32			
FC16A	GTN	SCB 17A, 200V, 0.08A, 2.5V	H-32			
FC16B	GTN	SCB 17A, 400V, 0.08A, 2.5V	H-32			
FC16C	GTN	SCB 17A, 600V, 2.5V	H-32			
FC16D	GTN	SCB 17A, 800V, 2.5V	H-32			
FC16E	GTN	SCB 17A, 1kV, 0.08A, 2.5V	H-32			
FC16F	GTN	SCB 17A, 1.2kV, 0.08A, 2.5V	H-32			
FC16G	GTN	SCB 17A, 1.4kV, 0.08A, 2.5V	H-32			

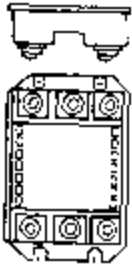

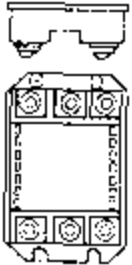
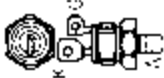
器件型号 Element type	厂名 Manufacturers	材料用途参数 Material Purpose Parameter	图号 Figure	国内外相似替换器件型号 Replace of similar type	备注 Notes	外形参考图 Reference shape
FC16U	GTN	SCB 17A, 100V, 0.08A, 2.5V	H-32			 图 H-32
FC17A	GTN	SCB 17A, 200V, 0.08A, 2.5V	H-32			
FC17B	GTN	SCB 17A, 400V, 0.08A, 2.5V	H-32			
FC17C	GTN	SCB 17A, 600V, 0.08A, 2.5V	H-32			
FC17D	GTN	SCB 17A, 800V, 0.08A, 2.5V	H-32			
FC17E	GTN	SCB 17A, 1kV, 0.08A, 2.5V	H-32			
FC17F	GTN	SCB 17A, 1.2kV, 0.08A, 2.5V	H-32			
FC17G	GTN	SCB 17A, 1.4kV, 0.08A, 2.5V	H-32			
FC17U	GTN	SCB 17A, 100V, 0.08A, 2.5V	H-32			
FC18B	GTN	SCB 17A, 400V, 0.08A, 2.5V	H-32			
FC18C	GTN	SCB 17A, 600V, 0.08A, 2.5V	H-32			
FC18D	GIN	SCB 17A, 800V, 0.08A, 2.5V	H-32			
FC18E	GTN	SCB 17A, 1kV, 0.08A, 2.5V	H-32			
FC18F	GTN	SCB 17A, 1.2kV, 0.08A, 2.5V	H-32			
FC18G	GTN	SCB 17A, 1.4kV, 0.08A, 2.5V	H-32			
FC18U	GTN	SCB 17A, 100V, 0.08A, 2.5V	H-32			
FC19A	GTN	SCB 17A, 200V, 0.08A, 2.5V	H-32			
FC19B	GTN	SCB 17A, 400V, 0.08A, 2.5V	H-32			
FC19C	GTN	SCB 17A, 600V, 0.08A, 2.5V	H-32			
FC19D	GTN	SCB 17A, 800V, 0.08A, 2.5V	H-32			
FC19E	GTN	SCB 17A, 1kV, 0.08A, 2.5V	H-32			
FC19F	GTN	SCB 17A, 1.2kV, 0.08A, 2.5V	H-32			
FC19G	GTN	SCB 17A, 1.4kV, 0.08A, 2.5V	H-32			
FC19U	GTN	SCB 17A, 100V, 0.08A, 2.5V	H-32			
FC20A	GTN	SCB 17A, 200V, 0.08A, 2.5V	H-32			
FC20B	GTN	SCB 17A, 400V, 0.08A, 2.5V	H-32			
FC20C	GTN	SCB 17A, 600V, 0.08A, 2.5V	H-32			
FC20D	GTN	SCB 17A, 800V, 0.08A, 2.5V	H-32			
FC20E	GTN	SCB 17A, 1kV, 0.08A, 2.5V	H-32			

器件型号 Element type	厂名 Manufacturers	材料 Material	用途 Purpose	参数 Parameter	图号 Figure	国内外相似替换器件型号 Replace of similar type	备注 Notes	外形参考图 Reference shape
FC20F	GTN	SCB		17A, 1.2KV, 0.08A, 2.5V	H-32			 图 H-32
FC20G	GTN	SCB		17A, 1.4KV, 0.08A, 2.5V	H-32			
FC20J	GTN	SCB		17A, 100V, 0.08A, 2.5V	H-32			
FCR8U01HA	AEI			7A, 100V, 0.025A, 2.5V	F-47			 图 F-47
FCR8U01HC	AEI			7A, 100V, 0.025A, 2.5V	F-47			
FCR8U01HD	AEI			9.5A, 100V, 0.025A, 2.5V	F-47			
FCR8U02HA	AEI			7A, 200V, 0.025A, 2.5V	F-47			
FCR8U02HC	AEI			7A, 200V, 0.025A, 2.5V	F-47			
FCR8U02HD	AEI			9.5A, 200V, 0.025A, 2.5V	F-47			
FCR8U03HA	AEI			7A, 300V, 0.025A, 2.5V	F-47			
FCR8U03HC	AEI			7A, 300V, 0.025A, 2.5V	F-47			
FCR8U03HD	AEI			9.5A, 300V, 0.025A, 2.5V	F-47			
FCR8U04HA	AEI			7A, 400V, 0.025A, 2.5V	F-47			
FCR8U04HC	AEI			7A, 400V, 0.025A, 2.5V	F-47			
FCR8U04HD	AEI			9.5A, 400V, 0.025A, 2.5V	F-47			
FCR8U05HA	AEI			7A, 500V, 0.025A, 2.5V	F-47			
FCR8U05HC	AEI			7A, 500V, 0.025A, 2.5V	F-47			
FCR8U05HD	AEI			9.5A, 500V, 0.025A, 2.5V	F-47			
FCR8U06HA	AEI			7A, 600V, 0.025A, 2.5V	F-47			
FCR8U06HC	AEI			7A, 600V, 0.025A, 2.5V	F-47			
FCR8U06HD	AEI			9.5A, 600V, 0.025A, 2.5V	F-47			
FCR9U01	AEI			9A, 100V, 0.1A, 3V	F-47			
FCR9U02	AEI			9A, 200V, 0.1A, 3V	F-47			
FCR9U03	AEI			9A, 300V, 0.1A, 3V	F-47			
FCR9U04	AEI			9A, 400V, 0.1A, 3V	F-47			
FCR9U05	AEI			9A, 500V, 0.1A, 3V	F-47			
FCR9U06	AEI			9A, 600V, 0.1A, 3V	F-47			
FCR9U07	AEI			9A, 700V, 0.1A, 3V	F-47			

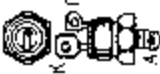

器件型号 Element type	厂名 Manufacturers	材料用途参数 Material Purpose Parameter	图号 Figure	国内外相似替换器件型号 Replace of similar type	备注 Notes	外形参考图 Reference shape
FCR9U08	AEI	9A, 800V, 0.1A, 3V	F-47			 图 F-47
FCR9U09	AEI	9A, 900V, 0.1A, 3V	F-47			
FCR9U10	AEI	9A, 1kV, 0.1A, 3V	F-47			
FCR9U11	AEI	9A, 1.1kV, 0.1A, 3V	F-47			
FCR9U12	AEI	9A, 1.2kV, 0.1A, 3V	F-47			
FCR12U01	AEI	14A, 100V, 0.1A, 3V	F-21			
FCR12U02	AEI	14A, 200V, 0.1A, 3V	F-21			
FCR12U04	AEI	14A, 400V, 0.1A, 3V	F-21			
FCR12U05	AEI	14A, 500V, 0.1A, 3V	F-21			
FCR12U06	AEI	14A, 600V, 0.1A, 3V	F-21			
FCR12U08	AEI	14A, 800V, 0.1A, 3V	F-21			
FCR12U09	AEI	14A, 900V, 0.1A, 3V	F-21			
FCR12U10	AEI	14A, 1kV, 0.1A, 3V	F-21			
FCR12U11	AEI	14A, 1.1kV, 0.1A, 3V	F-21			
FCR12U12	AEI	14A, 1.2kV, 0.1A, 3V	F-21			
TCR12UX5	AEI	14A, 50V, 0.1A, 3V	F-21			 图 F-21
FCR14U01	AEI	17A, 100V, 0.1A, 3V	F-21			
FCR14U02	AEI	17A, 200V, 0.1A, 3V	F-21			
FCR14U03	AEI	17A, 300V, 0.1A, 3V	F-21			
FCR14U04	AEI	17A, 400V, 0.1A, 3V	F-21			
FCR14U05	AEI	17A, 500V, 0.1A, 3V	F-21			
FCR14U06	AEI	17A, 600V, 0.1A, 3V	F-21			
FCR14UX5	AEI	17A, 50V, 0.1A, 3V	F-21			
FCR20U01	AEI	20A, 100V, 0.15A, 3V				
FCR20U02	AEI	20A, 200V, 0.15A, 3V				
FCR20U03	AEI	20A, 300V, 0.15A, 3V				

器件型号 Element type	厂名 Manufacturers	材料用途参数 Material Purpose Parameter	图号 Figure	国内外相似替换器件型号 Replace of similar type	备注 Notes	外形参考图 Reference shape
FCR20U04	AEI	20A, 400V, 0.15A, 3V				 图 F-21
FCR20U05	AEI	20A, 500V, 0.15A, 3V				
FCR20U06	AEI	20A, 600V, 0.15A, 3V				
FCR20U07	AEI	20A, 700V, 0.15A, 3V				
FCR20U08	AEI	20A, 800V, 0.15A, 3V				
FCR20U09	AEI	20A, 900V, 0.15A, 3V				
FCR20U10	AEI	20A, 1kV, 0.15A, 3V				
FCR20U11	AEI	20A, 1.1kV, 0.15A, 3V				
FCR20U12	AEI	20A, 1.2kV, 0.15A, 3V				
FCR24U01	AEI	32A, 100V, 0.1A, 8V	F-21			
FCR24U02	AEI	32A, 200V, 0.1A, 8V	F-21			
FCR24U03	AEI	32A, 300V, 0.1A, 8V	F-21			
FCR24U04	AEI	32A, 400V, 0.1A, 8V	F-21			
FCR24U05	AEI	32A, 500V, 0.1A, 8V	F-21			
FCR24U06	AEI	32A, 600V, 0.1A, 8V	F-21			
FCR24U07	AEI	32A, 700V, 0.15A, 8V	F-21			
FCR24U08	AEI	32A, 800V, 0.1A, 8V	F-21			
FCR24U09	AEI	32A, 900V, 0.15A, 8V	F-21			
FCR24U10	AEI	32A, 1kV, 0.1A, 8V	F-21			
FCR24U11	AEI	32A, 1.1kV, 0.1A, 8V	F-21			
FCR24UX5	AEI	32A, 50V, 0.1A, 8V	F-21			
FCR26U01	AEI	29A, 100V, 0.1A, 8V	F-21			
FCR26U02	AEI	29A, 200V, 0.1A, 8V	F-21			
FCR26U03	AEI	29A, 300V, 0.1A, 8V	F-21			
FCR26U04	AEI	29A, 400V, 0.1A, 8V	F-21			
FCR26U05	AEI	29A, 500V, 0.1A, 8V	F-21			
FCR26U06	AEI	29A, 600V, 0.1A, 8V	F-21			





器件型号 Element type	厂名 Manufacturers	材料用途参数 Material Purpose Parameter	图号 Figure	国内外相似替换器件型号 Replace of similar type	备注 Notes	外形参考图 Reference shape
FCR26UX5	AEI	29A, 50V, 0.1A, 8V	F-21			
FCR31U01	AEI	35A, 100V, 0.15A, 3V	F-91			
FCR31U02	AEI	38A, 200V, 0.15A, 3V	F-91			
FCR31U03	AEI	38A, 300V, 0.15A, 3V	F-91			
FCR31U04	AEI	38A, 400V, 0.15A, 3V	F-91			
FCR31U05	AEI	38A, 500V, 0.15A, 3V	F-91			
FCR31U06	AEI	38A, 600V, 0.15A, 3V	F-91			
FCR31U07	AEI	38A, 700V, 0.15A, 3V	F-91			
FCR31U08	AEI	38A, 800V, 0.15A, 3V	F-91			
FCR31U09	AEI	38A, 900V, 0.15A, 3V	F-91			
FCR31U10	AEI	38A, 1kV, 0.15A, 3V	F-91			
FCR31U11	AEI	38A, 1.1kV, 0.15A, 3V	F-91			
FCR43U01	AEI	60A, 100V, 0.15A, 3V	F-21			
FCR43U02	AEI	60A, 200V, 0.15A, 3V	F-21			
FCR43U03	AEI	60A, 300V, 0.15A, 3V	F-21			
FCR43U04	AEI	60A, 400V, 0.15A, 3V	F-21			
FCR43U05	AEI	60A, 500V, 0.15A, 3V	F-21			
FCR43U06	AEI	60A, 600V, 0.15A, 3V	F-21			
FCR43U07	AEI	43A, 700V, 0.15A, 3V	F-21			
FCR43U08	AEI	60A, 800V, 0.15A, 3V	F-21			
FCR43U09	AEI	43A, 900V, 0.15A, 3V	F-21			
FCR43U10	AEI	60A, 1kV, 0.15A, 3V	F-21			
FCR43U11	AEI	60A, 1.1kV, 0.15A, 3V	F-21			
FCR43U12	AEI	60A, 1.2kV, 0.15A, 3V	F-21			
FCR43UX5	AEI	60A, 50V, 0.15A, 3V	F-21			
FCR44U01	AEI	62A, 100V, 0.15A, 3V	F-21			
FCR44U02	AEI	62A, 200V, 0.15A, 3V	F-21			



图 F-21

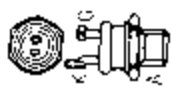

图 F-91

器件型号 Element type	厂名 Manufacturers	材料用途参数 Material Purpose Parameter	图号 Figure	国内外相似替换器件型号 Replace of similar type	备注 Notes	外形参考图 Reference shape
FCR44U03	AEI	62A, 300V, 0.15A, 3V	F-21			 图 F-21
FCR44U04	AEI	62A, 400V, 0.15A, 3V	F-21			
FCR44U05	AEI	62A, 500V, 0.15A, 3V	F-21			
FCR44U06	AEI	62A, 600V, 0.15A, 3V	F-21			
FCR44UX5	AEI	62A, 50V, 0.15A, 3V	F-21			
FCR81U01	AEI	110A, 100V, 0.15A, 3V	E-22			 图 E-22
FCR81U02	AEI	110A, 200V, 0.15A, 3V	E-22			
FCR81U03	AEI	110A, 300V, 0.15A, 3V	E-22			
FCR81U04	AEI	110A, 400V, 0.15A, 3V	E-22			
FCR81U05	AEI	110A, 500V, 0.15A, 3V	E-22			
FCR81U06	AEI	110A, 600V, 0.15A, 3V	E-22			
FCR81U07	AEI	110A, 700V, 0.15A, 3V	E-22			
FCR81U08	AEI	110A, 800V, 0.15A, 3V	E-22			
FCR81U09	AEI	110A, 900V, 0.15A, 3V	E-22			
FCR81U10	AEI	110A, 1kV, 0.15A, 3V	E-22			
FCR81U11	AEI	110A, 1.1kV, 0.15A, 3V	E-22			
FCR81U12	AEI	110A, 1.2kV, 0.15A, 3V	E-22			
FCR100-152L	AEI	170A, 135V, 0.15A, 3V	E-22			
FCR100-202L	AEI	170A, 180V, 0.15A, 3V	E-22			
FCR100-302L	AEI	170A, 250V, 0.15A, 3V	E-22			
FCR100-402L	AEI	170A, 300V, 0.15A, 3V	E-22			
FCR100-502L	AEI	170A, 400V, 0.15A, 3V	E-22			
FCR100-602L	AEI	170A, 500V, 0.15A, 3V	E-22			
FCR100A152L	AEI	170A, 135V, 0.15A, 3V	E-22			
FCR100A202L	AEI	170A, 180V, 0.15A, 3V	E-22			
FCR100A302L	AEI	170A, 250V, 0.15A, 3V	E-22			
FCR100A402L	AEI	170A, 300V, 0.15A, 3V	E-22			

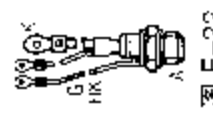

器件型号 Element type	厂名 Manufacturers	材料用途参数 Material Purpose Parameter	图号 Figure	国内外相似替换器件型号 Replace of similar type	备注 Notes	外形参考图 Reference shape
FCR100A502L	AEI	170A, 400V, 0.15A, 3V	E-22			 图 E-22
FCR100A602L	AEI	170A, 500V, 0.15A, 3V	E-22			
FCR100B152L	AEI	170A, 135V, 0.15A, 3V	E-22			
FCR100B202L	AEI	170A, 180V, 0.15A, 3V	E-22			
FCR100B302L	AEI	170A, 250V, 0.15A, 3V	E-22			
FCR100B402L	AEI	170A, 300V, 0.15A, 3V	E-22			
FCR100B502L	AEI	170A, 400V, 0.15A, 3V	E-22			
FCR100B602L	AEI	170A, 500V, 0.15A, 3V	F-22			
FCR100C152L	AEI	170A, 135V, 0.15A, 3V	E-22			
FCR100C202L	AEI	170A, 180V, 0.15A, 3V	E-22			
FCR100C302L	AEI	170A, 250V, 0.15A, 3V	E-22			
FCR100C402L	AEI	170A, 300V, 0.15A, 3V	E-22			
FCR100C502L	AEI	170A, 400V, 0.15A, 3V	E-22			
FCR100C602L	AEI	170A, 500V, 0.15A, 3V	E-22			
FCR100D152L	AEI	170A, 135V, 0.15A, 3V	E-22			
FCR100D202L	AEI	170A, 180V, 0.15A, 3V	E-22			
FCR100D302L	AEI	170A, 250V, 0.15A, 3V	E-22			
FCR100D402L	AEI	170A, 300V, 0.15A, 3V	E-22			
FCR100D502L	AEI	170A, 400V, 0.15A, 3V	E-22			
FCR100D602L	AEI	170A, 500V, 0.15A, 3V	E-22			
FCR100L152L	AEI	170A, 135V, 0.15A, 3V	E-22			
FCR100L202L	AEI	170A, 180V, 0.15A, 3V	E-22			
FCR100L302L	AEI	170A, 250V, 0.15A, 3V	E-22			
FCR100L402L	AEI	170A, 300V, 0.15A, 3V	E-22			
FCR100L502L	AEI	170A, 400V, 0.15A, 3V	E-22			
FCR100L602L	AEI	170A, 500V, 0.15A, 3V	E-22			
FCR100M152L	AEI	170A, 135V, 0.15A, 3V	E-22			
FCR100M202L	AEI	170A, 180V, 0.15A, 3V	E-22			
FCR100M302L	AEI	170A, 250V, 0.15A, 3V	E-22			

器件型号 Element type	厂名 Manufacturers	材料用途参数 Material Purpose Parameter	图号 Figure	国内外相似替换器件型号 Replace of similar type	备注 Notes	外形参考图 Reference shape
FCR100M402L	AEI	170A, 300V, 0.15A, 3V	F-22			
FCR100M502L	AEI	170A, 400V, 0.15A, 3V	E-22			
FCR100M602L	AEI	170A, 500V, 0.15A, 3V	E-22			
FCR100N152L	AEI	170A, 135V, 0.15A, 3V	E-22			
FCR100N202L	AEI	170A, 180V, 0.15A, 3V	E-22			
FCR100N302L	AEI	170A, 250V, 0.15A, 3V	E-22			
FCR100N402L	AEI	170A, 300V, 0.15A, 3V	E-22			
FCR100N502L	AEI	170A, 400V, 0.15A, 3V	E-22			
FCR100N602L	AEI	170A, 500V, 0.15A, 3V	E-22			
FCR100P152L	AEI	170A, 135V, 0.15A, 3V	E-22			
FCR100P202L	AEI	170A, 180V, 0.15A, 3V	E-22			
FCR100P302L	AEI	170A, 250V, 0.15A, 3V	E-22			
FCR100P402L	AEI	170A, 300V, 0.15A, 3V	E-22			
FCR100P502L	AEI	170A, 400V, 0.15A, 3V	E-22			
FCR100P602L	AEI	170A, 500V, 0.15A, 3V	E-22			
FCR100R152L	AEI	170A, 135V, 0.15A, 3V	E-22			
FCR100R202L	AEI	170A, 180V, 0.15A, 3V	E-22			
FCR100R302L	AEI	170A, 250V, 0.15A, 3V	E-22			
FCR100R402L	AEI	170A, 300V, 0.15A, 3V	E-22			
FCR100R502L	AEI	170A, 400V, 0.15A, 3V	E-22			
FCR100R602L	AEI	170A, 500V, 0.15A, 3V	E-22			
FCR100S152L	AEI	170A, 135V, 0.15A, 3V	E-22			
FCR100S202L	AEI	170A, 180V, 0.15A, 3V	E-22			
FCR100S302L	AEI	170A, 250V, 0.15A, 3V	E-22			
FCR100S402L	AEI	170A, 300V, 0.15A, 3V	E-22			
FCR100S502L	AEI	170A, 400V, 0.15A, 3V	E-22			
FCR100S602L	AEI	170A, 500V, 0.15A, 3V	E-22			
FCR100T152L	AEI	170A, 135V, 0.15A, 3V	E-22			
FCR100T202L	AEI	170A, 180V, 0.15A, 3V	E-22			



器件型号 Element type	厂名 Manufacturers	材料用途参数 Material: Purpose Parameter	图号 Figure	国内外相似替换器件型号 Replace of similar type	备注 Notes	外形参考图 Reference shape
FCR100T302L	AEI	170A, 250V, 0.15A, 3V	E-22			 图 E-22
FCR100T402L	AEI	170A, 300V, 0.15A, 3V	E-22			
FCR100T502L	AEI	170A, 400V, 0.15A, 3V	E-22			
FCR100T602L	AEI	170A, 500V, 0.15A, 3V	E-22			
FCR100V152L	AEI	170A, 135V, 0.15A, 3V	E-22			
FCR100V202L	AEI	170A, 180V, 0.15A, 3V	E-22			
FCR100V302L	AEI	170A, 250V, 0.15A, 3V	E-22			
FCR100V402L	AEI	170A, 300V, 0.15A, 3V	E-22			
FCR100V502L	AEI	170A, 400V, 0.15A, 3V	E-22			
FCR100V602L	AEI	170A, 500V, 0.15A, 3V	E-22			
FCR100W152L	AEI	170A, 135V, 0.15A, 3V	E-22			
FCR100W202L	AEI	170A, 180V, 0.15A, 3V	E-22			
FCR100W302L	AEI	170A, 250V, 0.15A, 3V	E-22			
FCR100W402L	AEI	170A, 300V, 0.15A, 3V	E-22			
FCR100W502L	AEI	170A, 400V, 0.15A, 3V	E-22			
FCR100W602L	AEI	170A, 500V, 0.15A, 3V	E-22			
FCR100X152L	AEI	170A, 135V, 0.15A, 3V	E-22			
FCR100X202L	AEI	170A, 180V, 0.15A, 3V	E-22			
FCR100X302L	AEI	170A, 250V, 0.15A, 3V	E-22			
FCR100X402L	AEI	170A, 300V, 0.15A, 3V	E-22			
FCR100X502L	AEI	170A, 400V, 0.15A, 3V	F-22			
FCR100X602L	AEI	170A, 500V, 0.15A, 3V	E-22			
FCR120-152L	AEI	170A, 135V, 0.15A, 3V	E-22			
FCR120-202L	AEI	170A, 180V, 0.15A, 3V				
FCR120-302L	AEI	170A, 250V, 0.15A, 3V				
FCR120-402L	AEI	170A, 300V, 0.15A, 3V				
FCR120-502L	AEI	170A, 400V, 0.15A, 3V				
FCR120-602L	AEI	170A, 500V, 0.15A, 3V				

器件型号 Element type	厂名 Manufacturers	材料用途参数 Material Purpose Parameter	图号 Figure	国内外相似替换器件型号 Replace of similar type	备注 Notes	外形参考图 Reference shape
FCR130-202L	AEI	200A, 180V, 0.15A, 3V				
FCR130-302L	AEI	200A, 250V, 0.15A, 3V				
FCR130-402L	AEI	200A, 300V, 0.15A, 3V				
FCR130-502L	AEI	200A, 400V, 0.15A, 3V				
FCR130-602L	AEI	200A, 500V, 0.15A, 3V				
FD01A	GTN	25A, 200V, 0.08A, 2.5V	H-32			
FD01B	GTN	25A, 400V, 0.08A, 2.5V	H-32			
FD01C	GTN	25A, 600V, 0.08A, 2.5V	H-32			
FD01D	GTN	25A, 800V, 0.08A, 2.5V	H-32			
FD01E	GTN	25A, 1kV, 0.08A, 2.5V	H-32			
FD01F	GTN	25A, 1.2kV, 0.08A, 2.5V	H-32			
FD01G	GTN	25A, 1.4kV, 0.08A, 2.5V	H-32			
FD01U	GTN	25A, 100V, 0.08A, 2.5V	H-32			
FD02A	GTN	25A, 200V, 0.08A, 2.5V	H-32			
FD02B	GTN	25A, 400V, 0.08A, 2.5V	H-32			
FD02C	GTN	25A, 600V, 0.08A, 2.5V	H-32			
FD02D	GTN	25A, 800V, 0.08A, 2.5V	H-32			
FD02E	GTN	25A, 1kV, 0.08A, 2.5V	H-32			
FD02F	GTN	25A, 1.2kV, 0.08A, 2.5V	H-32			
FD02G	GTN	25A, 1.4kV, 0.08A, 2.5V	H-32			
FD02U	GTN	25A, 100V, 0.08A, 2.5V	H-32			
FD04A	GTN	25A, 200V, 0.08A, 2.5V	H-32			
FD04B	GTN	25A, 400V, 0.08A, 2.5V	H-32			
FD04C	GTN	25A, 600V, 0.08A, 2.5V	H-32			
FD04D	GTN	25A, 800V, 0.08A, 2.5V	H-32			
FD04E	GTN	25A, 1kV, 0.08A, 2.5V	H-32			
FD04F	GTN	25A, 1.2kV, 0.08A, 2.5V	H-32			



图 H-32



器件型号 Element type	厂名 Manufacturers	材料用途参数 Material Purpose Parametc:	图号 Figure	国内外相似替换器件型号 Replace of similar type	备注 Notes	外形参考图 Reference shape
FD04G	GTN	SCB 25A, 1.4kV, 0.08A, 2.5V	H-32			 <p>图 H 32</p>
FD04U	GTN	SCB 25A, 100V, 0.08A, 2.5V	H-32			
FD05A	GTN	SCB 25A, 200V, 0.08A, 2.5V	H-32			
FD05B	GTN	SCB 25A, 400V, 0.08A, 2.5V	H-32			
FD05C	GTN	SCB 25A, 600V, 0.08A, 2.5V	H-32			
FD05D	GTN	SCB 25A, 800V, 0.08A, 2.5V	H-32			
FD05E	GTN	SCB 25A, 1kV, 0.08A, 2.5V	H-32			
FD05F	GTN	SCB 25A, 1.2kV, 0.08A, 2.5V	H-32			
FD05G	GTN	SCB 25A, 1.4kV, 0.08A, 2.5V	H-32			
FD05U	GTN	SCB 25A, 100V, 0.08A, 2.5V	H-32			
FD13A	GTN	SCB 25A, 200V, 0.08A, 2.5V	H-32			
FD13B	GTN	SCB 25A, 400V, 0.08A, 2.5V	H-32			
FD13C	GTN	SCB 25A, 600V, 0.08A, 2.5V	H-32			
FD13D	GTN	SCB 25A, 800V, 0.08A, 2.5V	H-32			
FD13E	GTN	SCB 25A, 1kV, 0.08A, 2.5V	H-32			
FD16A	GTN	SCB 25A, 200V, 0.08A, 2.5V	H-32			
FD16B	GTN	SCB 25A, 400V, 0.08A, 2.5V	H-32			
FD16C	GTN	SCB 25A, 600V, 0.08A, 2.5V	H-32			
FD16D	GTN	SCB 25A, 800V, 0.08A, 2.5V	H-32			
FD16E	GTN	SCB 25A, 1kV, 0.08A, 2.5V	H-32			
FD16F	GTN	SCB 25A, 1.2kV, 0.08A, 2.5V	H-32			
FD16G	GTN	SCB 25A, 1.4kV, 0.08A, 2.5V	H-32			
FD16U	GTN	SCB 25A, 100V, 0.08A, 2.5V	H-32			
FD17A	GTN	SCB 25A, 200V, 0.08A, 2.5V	H-32			
FD17B	GTN	SCB 25A, 400V, 0.08A, 2.5V	H-32			
FD17C	GTN	SCB 25A, 600V, 0.08A, 2.5V	H-32			
FD17D	GTN	SCB 25A, 800V, 0.08A, 2.5V	H-32			

器件型号 Element type	厂名 Manufacturers	材料用途参数 Material Purpose Parameter	图号 Figure	国内外相似替换器件型号 Rep ace of similar type	备注 Notes	外形参考图 Reference shape
FD17E	GTN	SCB 25A, 1kV, 0.08A, 2.5V	H-32			
FD17F	GTN	SCB 25A, 1.2kV, 0.08A, 2.5V	H-32			
FD17G	GTN	SCB 25A, 1.4kV, 0.08A, 2.5V	H-32			
FD17U	GTN	SCB 25A, 100V, 0.08A, 2.5V	H-32			
FD18A	GTN	SCB 25A, 200V, 0.08A, 2.5V	H-32			
FD18B	GTN	SCB 25A, 400V, 0.08A, 2.5V	H-32			
FD18C	GTN	SCB 25A, 600V, 0.08A, 2.5V	H-32			
FD18D	GTN	SCB 25A, 800V, 0.08A, 2.5V	H-32			
FD18E	GTN	SCB 25A, 1kV, 0.08A, 2.5V	H-32			
FD18F	GTN	SCB 25A, 1.2kV, 0.08A, 2.5V	H-32			
FD18G	GTN	SCB 25A, 1.4kV, 0.08A, 2.5V	H-32			
FD18U	GTN	SCB 25A, 100V, 0.08A, 2.5V	H-32			
FD19A	GTN	SCB 25A, 200V, 0.08A, 2.5V	H-32			
FD19B	GTN	SCB 25A, 400V, 0.08A, 2.5V	H-32			
FD19C	GTN	SCB 25A, 600V, 0.08A, 2.5V	H-32			
H-19D	GTN	SCB 25A, 800V, 0.08A, 2.5V	H-32			
FD19E	GTN	SCB 25A, 1kV, 0.08A, 2.5V	H-32			
FD19F	GTN	SCB 25A, 1.2kV, 0.08A, 2.5V	H-32			
FD19G	GTN	SCB 25A, 1.4kV, 0.08A, 2.5V	H-32			
FD19U	GTN	SCB 25A, 100V, 0.08A, 2.5V	H-32			
FD20A	GTN	SCB 25A, 200V, 0.08A, 2.5V	H-32			
FD20B	GTN	SCB 25A, 400V, 0.08A, 2.5V	H-32			
FD20C	GTN	SCB 25A, 600V, 0.08A, 2.5V	H-32			
FD20D	GTN	SCB 25A, 800V, 0.08A, 2.5V	H-32			
FD20E	GTN	SCB 25A, 1kV, 0.08A, 2.5V	H-32			
FD20F	GTN	SCB 25A, 1.2kV, 0.08A, 2.5V	H-32			
FD20G	GTN	SCB 25A, 1.4kV, 0.08A, 2.5V	H-32			
FD20U	GTN	SCB 25A, 100V, 0.08A, 2.5V	H-32			

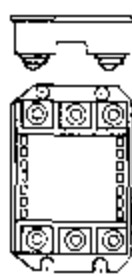
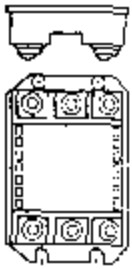

图 H-32



器件型号 Element type	厂名 Manufacturers	材料用途参数 Material Purpose Parameter	图号 Figure	国内外相似替换器件型号 Replace of similar type	备注 Notes	外形参考图 Reference shape
FE01A	GTN	SCB 37A, 200V, 0.08A, 3V	H-32			 图 H-32
FE01B	GTN	SCB 37A, 400V, 0.08A, 3V	H-32			
FE01C	GTN	SCB 37A, 600V, 0.08A, 3V	H-32			
FE01D	GTN	SCB 37A, 800V, 0.08A, 3V	H-32			
FE01E	GTN	SCB 37A, 1kV, 0.08A, 3V	H-32			
FE01F	GTN	SCB 37A, 1.2kV, 0.08A, 3V	H-32			
FE01G	GTN	SCB 37A, 1.4kV, 0.08A, 3V	H-32			
FE01U	GTN	SCB 37A, 100V, 0.08A, 3V	H-32			
FE02A	GTN	SCB 37A, 200V, 0.08A, 3V	H-32			
FE02B	GTN	SCB 37A, 400V, 0.08A, 3V	H-32			
FE02C	GTN	SCB 37A, 600V, 0.08A, 3V	H-32			
FE02D	GTN	SCB 37A, 800V, 0.08A, 3V	H-32			
FE02E	GTN	SCB 37A, 1kV, 0.08A, 3V	H-32			
FE02F	GTN	SCB 37A, 1.2kV, 0.08A, 3V	H-32			
FE02G	GTN	SCB 37A, 1.4kV, 0.08A, 3V	H-32			
FE02U	GTN	SCB 37A, 100V, 0.08A, 3V	H-32			
FE02BC, BS	GTN	0.05A, 3V	H-32			
FE02CC, CS	GTN	0.05A, 3V	H-32			
FE02FC, FS	GTN	0.05A, 3V	H-32			
FE04A	GTN	SCB 37A, 200V, 0.08A, 2.5V	H-32			
FE04B	GTN	SCB 37A, 400V, 0.08A, 3V	H-32			
FE04C	GTN	SCB 37A, 600V, 0.08A, 3V	H-32			
FE04D	GTN	SCB 37A, 800V, 0.08A, 3V	H-32			
FE04E	GTN	SCB 37A, 1kV, 0.08A, 3V	H-32			
FE04U	GTN	SCB 37A, 100V, 0.08A, 3V	H-32			
FE04BC, BS	GTN	0.05A, 3V	H-32			
FE04CC, CS	GTN	0.05A, 3V	H-32			
FE04FC, FS	GTN	0.05A, 3V	H-32			

器件型号 Element type	厂名 Manufacturers	材料用途参数 Material Purpose Parameter	图号 Figure	国内外相似替换器件型号 Replace of similar type	备注 Notes	外形参考图 Reference shape
FE05A	GTN	SCB 37A, 200V, 0.08A, 2.5V	H-32			 <p>图 H-32</p>
FE05B	GTN	SCB 37A, 400V, 0.08A, 3V	H-32			
FE05C	GTN	SCB 37A, 600V, 0.08A, 3V	H-32			
FE05D	GTN	SCB 37A, 800V, 0.08A, 3V	H-32			
FE05E	GTN	SCB 37A, 1kV, 0.08A, 3V	H-32			
FE05F	GTN	SCB 37A, 1.2kV, 0.08A, 3V	H-32			
FE05G	GTN	SCB 37A, 1.4kV, 0.08A, 3V	H-32			
FE05U	GTN	SCB 37A, 100V, 0.08A, 3V	H-32			
FE14A	GTN	SCB 37A, 200V, 0.08A, 2.5V	H-32			
FE14B	GTN	SCB 37A, 400V, 0.08A, 3V	H-32			
FE14C	GTN	SCB 37A, 600V, 0.08A, 3V	H-32			
FE14D	GTN	SCB 37A, 800V, 0.08A, 3V	H-32			
FE14E	GTN	SCB 37A, 1kV, 0.08A, 3V	H-32			
FE14F	GTN	SCB 37A, 1.2kV, 0.08A, 3V	H-32			
FE14G	GTN	SCB 37A, 1.4kV, 0.08A, 3V	H-32			
FE14U	GTN	SCB 37A, 100V, 0.08A, 3V	H-32			
FE16A	GTN	SCB 37A, 200V, 0.08A, 2.5V	H-32			
FE16B	GTN	SCB 37A, 400V, 0.08A, 3V	H-32			
FE16C	GTN	SCB 37A, 600V, 0.08A, 3V	H-32			
FE16D	GTN	SCB 37A, 800V, 0.08A, 3V	H-32			
FE16E	GTN	SCB 37A, 1kV, 0.08A, 3V	H-32			
FE16F	GTN	SCB 37A, 1.2kV, 0.08A, 3V	H-32			
FE16G	GTN	SCB 37A, 1.4kV, 0.08A, 3V	H-32			
FE16U	GTN	SCB 37A, 100V, 0.08A, 3V	H-32			
FE17A	GTN	SCB 37A, 200V, 0.08A, 2.5V	H-32			
FE17B	GTN	SCB 37A, 400V, 0.08A, 3V	H-32			
FE17C	GTN	SCB 37A, 600V, 0.08A, 3V	H-32			

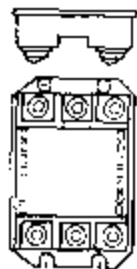
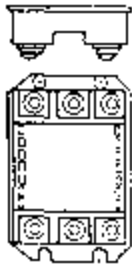
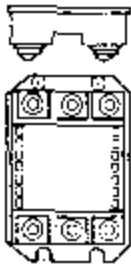

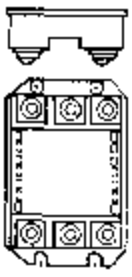
器件型号 Element type	厂名 Manufacturers	材料用途参数 Material Purpose Parameter	图号 Figure	国内外相似替换器型号 Replace of similar type	备注 Notes	外形参考图 Reference shape
FE17D	GTN	SCB 37A, 800V, 0.08A, 3V	H-32			 <p>图 H-32</p>
FE17E	GTN	SCB 37A, 1kV, 0.08A, 3V	H-32			
FE17F	GTN	SCB 37A, 1.2kV, 0.08A, 3V	H-32			
FE17G	GTN	SCB 37A, 1.4kV, 0.08A, 3V	H-32			
FE17U	GTN	SCB 37A, 100V, 0.08A, 3V	H-32			
FE18A	GTN	SCB 37A, 200V, 0.08A, 2.5V	H-32			
FE18B	GTN	SCB 37A, 400V, 0.08A, 3V	H-32			
FE18C	GTN	SCB 37A, 600V, 0.08A, 3V	H-32			
FE18D	GTN	SCB 37A, 800V, 0.08A, 3V	H-32			
FE18E	GTN	SCB 37A, 1kV, 0.08A, 3V	H-32			
FE18F	GTN	SCB 37A, 1.2kV, 0.08A, 3V	H-32			
FE18G	GTN	SCB 37A, 1.4kV, 0.08A, 3V	H-32			
FE18U	GTN	SCB 37A, 100V, 0.08A, 3V	H-32			
FE19A	GTN	SCB 37A, 200V, 0.08A, 2.5V	H-32			
FE19B	GTN	SCB 37A, 400V, 0.08A, 3V	H-32			
FE19C	GTN	SCB 37A, 600V, 0.08A, 3V	H-32			
FE19D	GTN	SCB 37A, 800V, 0.08A, 3V	H-32			
FE19E	GTN	SCB 37A, 1kV, 0.08A, 3V	H-32			
FE19F	GTN	SCB 37A, 1.2kV, 0.08A, 3V	H-32			
FE19G	GTN	SCB 37A, 1.4kV, 0.08A, 3V	H-32			
FE19U	GTN	SCB 37A, 100V, 0.08A, 3V	H-32			
FE20A	GTN	SCB 37A, 200V, 0.08A, 2.5V	H-32			
FE20B	GTN	SCB 37A, 400V, 0.08A, 3V	H-32			
FE20C	GTN	SCB 37A, 600V, 0.08A, 3V	H-32			
FE20D	GTN	SCB 37A, 800V, 0.08A, 3V	H-32			
FE20E	GTN	SCB 37A, 1kV, 0.08A, 3V	H-32			
FE20F	GTN	SCB 37A, 1.2kV, 0.08A, 3V	H-32			
FE20G	GTN	SCB 37A, 1.4kV, 0.08A, 3V	H-32			
FE20U	GTN	SCB 37A, 100V, 0.08A, 3V	H-32			

器件型号 Element type	厂名 Manufacturers	材料用途参数 Material Purpose Parameter	图号 Figure	国内外相似替换器件型号 Replace of similar type	备注 Notes	外形参考图 Reference shape
FF01A	GTN	SCB 50A, 200V, 0.1A, 3V	H-32			 <p>图 H 32</p>
FF01B	GTN	SCB 50A, 400V, 0.1A, 3V	H-32			
FF01C	GTN	SCB 50A, 600V, 0.1A, 3V	H-32			
FF01D	GTN	SCB 50A, 800V, 0.1A, 3V	H-32			
FF01E	GTN	SCB 50A, 1kV, 0.1A, 3V	H-32			
FF01F	GTN	SCB 50A, 1.2kV, 0.1A, 3V	H-32			
FF01G	GTN	SCB 50A, 1.4kV, 0.1A, 3V	H-32			
FF01U	GTN	SCB 50A, 100V, 0.1A, 3V	H-32			
FF01BC, BS	GTN	0.1A, 3V	H-32			
FF01CC, CS	GTN	0.1A, 3V	H-32			
FF01FC, FS	GTN	0.1A, 3V	H-32			
FF02A	GTN	SCB 50A, 200V, 0.1A, 3V	H-32			
FF02B	GTN	SCB 50A, 400V, 0.1A, 3V	H-32			
FF02C	GTN	SCB 50A, 600V, 0.1A, 3V	H-32			
FF02D	GTN	SCB 50A, 800V, 0.1A, 3V	H-32			
FF02E	GTN	SCB 50A, 1kV, 0.1A, 3V	H-32			
FF02F	GTN	SCB 50A, 1.2kV, 0.1A, 3V	H-32			
FF02G	GTN	SCB 50A, 1.4kV, 0.1A, 3V	H-32			
FF02U	GTN	SCB 50A, 100V, 0.1A, 3V	H-32			
FF02FC, FS	GTN	0.1A, 3V	H-32			
FF04A	GTN	SCB 50A, 200V, 0.1A, 3V	H-32			
FF04B	GTN	SCB 50A, 400V, 0.1A, 3V	H-32			
FF04C	GTN	SCB 50A, 600V, 0.1A, 3V	H-32			
FF04D	GTN	SCB 50A, 800V, 0.1A, 3V	H-32			
FF04E	GTN	SCB 50A, 1kV, 0.1A, 3V	H-32			
FF04F	GTN	SCB 50A, 1.2kV, 0.1A, 3V	H-32			
FF04G	GTN	SCB 50A, 1.4kV, 0.1A, 3V	H-32			
FF04U	GTN	SCB 50A, 100V, 0.1A, 3V	H-32			

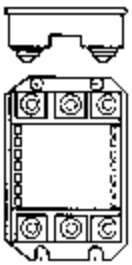
器件型号 Element type	厂名 Manufacturers	材料用途参数 Material Purpose Parameter	图号 Figure	国内外相似替换器件型号 Replace of similar type	备注 Notes	外形参考图 Reference shape
FF04BC, BS	GTN	0.1A, 3V	H-32			 <p>图 H-32</p>
FF04CC, CS	GTN	0.1A, 3V	H-32			
FF04FC, FS	GTN	0.1A, 3V	H-32			
FF05A	GTN	SCB 50A, 200V, 0.1A, 3V	H-32			
FF05B	GTN	SCB 50A, 400V, 0.1A, 3V	H-32			
FF05C	GTN	SCB 50A, 600V, 0.1A, 3V	H-32			
FF05D	GTN	SCB 50A, 800V, 0.1A, 3V	H-32			
FF05E	GTN	SCB 50A, 1kV, 0.1A, 3V	H-32			
FF05F	GTN	SCB 50A, 1.2kV, 0.1A, 3V	H-32			
FF05G	GTN	SCB 50A, 1.4kV, 0.1A, 3V	H-32			
FF05U	GTN	SCB 50A, 100V, 0.1A, 3V	H-32			
FF13A	GTN	SCB 50A, 200V, 0.1A, 3V	H-32			
FF13B	GTN	SCB 50A, 400V, 0.1A, 3V	H-32			
FF13C	GTN	SCB 50A, 600V, 0.1A, 3V	H-32			
FF13D	GTN	SCB 50A, 800V, 0.1A, 3V	H-32			
FF13E	GTN	SCB 50A, 1kV, 0.1A, 3V	H-32			
FF13F	GTN	SCB 50A, 1.2kV, 0.1A, 3V	H-32			
FF13G	GTN	SCB 50A, 1.4kV, 0.1A, 3V	H-32			
FF13U	GTN	SCB 50A, 100V, 0.1A, 3V	H-32			
FF16A	GTN	SCB 50A, 200V, 0.1A, 3V	H-32			
FF16B	GTN	SCB 50A, 400V, 0.1A, 3V	H-32			
FF16C	GTN	SCB 50A, 600V, 0.1A, 3V	H-32			
FF16D	GTN	SCB 50A, 800V, 0.1A, 3V	H-32			
FF16E	GTN	SCB 50A, 1kV, 0.1A, 3V	H-32			
FF16F	GTN	SCB 50A, 1.2kV, 0.1A, 3V	H-32			
FF16G	GTN	SCB 50A, 1.4kV, 0.1A, 3V	H-32			
FF16U	GTN	SCB 50A, 100V, 0.1A, 3V	H-32			

器件型号 Element type	厂名 Manufacturers	材料用途参数 Material Purpose Paramete:	图号 Figure	国内外相似替换器件型号 Replace of similar type	备注 Notes	外形参考图 Reference shape
FF17A	GTN	SCB 50A, 200V, 0.1A, 3V	H-32			
FF17B	GTN	SCB 50A, 400V, 0.1A, 3V	H-32			
FF17C	GTN	SCB 50A, 600V, 0.1A, 3V	H-32			
FF17D	GTN	SCB 50A, 800V, 0.1A, 3V	H-32			
FF17E	GTN	SCB 50A, 1kV, 0.1A, 3V	H-32			
FF17F	GTN	SCB 50A, 1.2kV, 0.1A, 3V	H-32			
FF17G	GTN	SCB 50A, 1.4kV, 0.1A, 3V	H-32			
FF17U	GTN	SCB 50A, 100V, 0.1A, 3V	H-32			
FF18A	GTN	SCB 50A, 200V, 0.1A, 3V	H-32			
FF18B	GTN	SCB 50A, 400V, 0.1A, 3V	H-32			
FF18C	GTN	SCB 50A, 600V, 0.1A, 3V	H-32			
FF18D	GTN	SCB 50A, 800V, 0.1A, 3V	H-32			
FF18E	GTN	SCB 50A, 1kV, 0.1A, 3V	H-32			
FF18F	GTN	SCB 50A, 1.2kV, 0.1A, 3V	H-32			
FF18G	GTN	SCB 50A, 1.4kV, 0.1A, 3V	H-32			
FF18U	GTN	SCB 50A, 100V, 0.1A, 3V	H-32			
FF19A	GTN	SCB 50A, 200V, 0.1A, 3V	H-32			
FF19B	GTN	SCB 50A, 400V, 0.1A, 3V	H-32			
FF19C	GTN	SCB 50A, 600V, 0.1A, 3V	H-32			
FF19D	GTN	SCB 50A, 800V, 0.1A, 3V	H-32			
FF19E	GTN	SCB 50A, 1kV, 0.1A, 3V	H-32			
FF19F	GTN	SCB 50A, 1.2kV, 0.1A, 3V	H-32			
FF19G	GTN	SCB 50A, 1.4kV, 0.1A, 3V	H-32			
FF19U	GTN	SCB 50A, 100V, 0.1A, 3V	H-32			
FF20A	GTN	SCB 50A, 200V, 0.1A, 3V	H-32			
FF20B	GTN	SCB 50A, 400V, 0.1A, 3V	H-32			
FF20C	GTN	SCB 50A, 600V, 0.1A, 3V	H-32			
FF20D	GTN	SCB 50A, 800V, 0.1A, 3V	H-32			
FF20E	GTN	SCB 50A, 1kV, 0.1A, 3V	H-32			



图 H 32





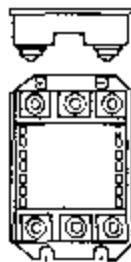
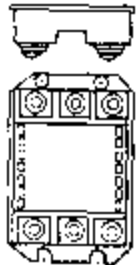
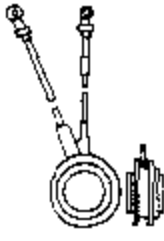
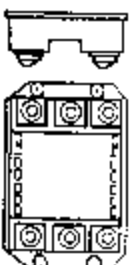

器件型号 Element type	厂名 Manufacturers	材料用途参数 Material Purpose Parameter	图号 Figure	国内外相似替换器件型号 Replace of similar type	备注 Notes	外形参考图 Reference snap	
FF20F	GTN	SCB 50A, 1.2KV, 0.1A, 3V	H-32			 图 H-32	
FF20G	GTN	SCB 50A, 1.4KV, 0.1A, 3V	H-32				
FF20U	GTN	SCB 50A, 100V, 0.1A, 3V	H-32				
FF150DY-4		SCR-H 150A, 200V	C-32				
FF150DY-6		SCR-H 150A, 300V	C-32				
FF150DY-8		SCR-H 150A, 400V	C-32				
FF150DY-10		SCR-H 150A, 500V	C-32				
FF150DY-12		SCR-H 150A, 600V	C-32				
FF150DY-16		SCR-H 100A, 800V	C-32				
FG01A	GTN	SCB 75A, 200V, 0.15A, 3V	H-32				 图 C-32
FG01B	GTN	SCB 75A, 400V, 0.15A, 3V	H-32				
FG01C	GTN	SCB 75A, 600V, 0.15A, 3V	H-32				
FG01D	GTN	SCB 75A, 800V, 0.15A, 3V	H-32				
FG01E	GTN	SCB 75A, 1KV, 0.15A, 3V	H-32				
FG01F	GTN	SCB 75A, 1.2KV, 0.15A, 3V	H-32				
FG01G	GTN	SCB 75A, 1.4KV, 0.15A, 3V	H-32				
FG01U	GTN	SCB 75A, 100V, 0.15A, 3V	H-32				
FG01CC, CS	GTN	0.15A, 3V	H-32				
FG01FC, FS	GTN	0.15A, 3V	H-32				
FG02A	GTN	SCB 75A, 200V, 0.15A, 3V	H-32				
FG02B	GTN	SCB 75A, 400V, 0.15A, 3V	H-32				
FG02C	GTN	SCB 75A, 600V, 0.15A, 3V	H-32				
FG02D	GTN	SCB 75A, 800V, 0.15A, 3V	H-32				
FG02E	GTN	SCB 75A, 1KV, 0.15A, 3V	H-32				
FG02F	GTN	SCB 75A, 1.2KV, 0.15A, 3V	H-32				
FG02G	GTN	SCB 75A, 1.4KV, 0.15A, 3V	H-32				
FG02U	GTN	SCB 75A, 100V, 0.15A, 3V	H-32				

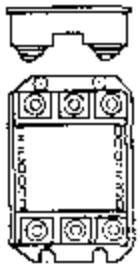
器件型号 Element type	厂名 Manufacturers	材料用途参数 Material Purpose Parameter	图号 Figure	国内外相似替换器件型号 Replace of similar type	备注 Notes	外形参考图 Reference shape
FG02CC, CS	GTN	0.15A, 3V	H-32			 图 H-32
FG02FC, FS	GTN	0.15A, 3V	H-32			
FG04A	GTN	75A, 200V, 0.15A, 3V	H-32			
FG04B	GTN	75A, 400V, 0.15A, 3V	H-32			
FG04C	GTN	75A, 600V, 0.15A, 3V	H-32			
FG04D	GTN	75A, 800V, 0.15A, 3V	H-32			
FG04E	GTN	75A, 1kV, 0.15A, 3V	H-32			
FG04F	GTN	75A, 1.2kV, 0.15A, 3V	H-32			
FG04G	GTN	75A, 1.4kV, 0.15A, 3V	H-32			
FG04U	GTN	75A, 100V, 0.15A, 3V	H-32			
FG04BC, BS	GTN	0.15A, 3V	H-32			
FG04CC, CS	GTN	0.15A, 3V	H-32			
FG04FC, FS	GTN	0.15A, 3V	H-32			
FG05A	GTN	75A, 200V, 0.15A, 3V	H-32			
FG05B	GTN	75A, 400V, 0.15A, 3V	H-32			
FG05C	GTN	75A, 600V, 0.15A, 3V	H-32			
FG05D	GTN	75A, 800V, 0.15A, 3V	H-32			
FG05E	GTN	75A, 1kV, 0.15A, 3V	H-32			
FG05F	GTN	75A, 1.2kV, 0.15A, 3V	H-32			
FG05G	GTN	75A, 1.4kV, 0.15A, 3V	H-32			
FG05U	GTN	75A, 100V, 0.15A, 3V	H-32			
FG16A	GTN	75A, 200V, 0.15A, 3V	H-32			
FG16B	GTN	75A, 400V, 0.15A, 3V	H-32			
FG16C	GTN	75A, 600V, 0.15A, 3V	H-32			
FG16D	GTN	75A, 800V, 0.15A, 3V	H-32			
FG16E	GTN	75A, 1kV, 0.15A, 3V	H-32			
FG16F	GTN	75A, 1.2kV, 0.15A, 3V	H-32			

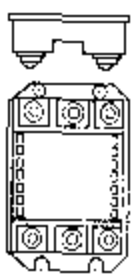

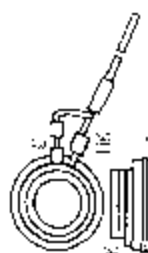

器件型号 Element type	厂名 Manufacturers	材料用途参数 Material Purpose Parameter	图号 Figure	国内外相似替换器件型号 Replace of similar type	备注 Notes	外形参考图 Reference shape
FG16G	GTN	SCB 75A, 1.4kV, 0.15A, 3V	H-32			 图 H-32
FG16U	GTN	SCB 75A, 100V, 0.15A, 3V	H-32			
FG17A	GTN	SCB 75A, 200V, 0.15A, 3V	H-32			
FG17B	GTN	SCB 75A, 400V, 0.15A, 3V	H-32			
FG17C	GTN	SCB 75A, 600V, 0.15A, 3V	H-32			
FG17D	GTN	SCB 75A, 800V, 0.15A, 3V	H-32			
FG17E	GTN	SCB 75A, 1kV, 0.15A, 3V	H-32			
FG17F	GTN	SCB 75A, 1.2kV, 0.15A, 3V	H-32			
FG17G	GTN	SCB 75A, 1.4kV, 0.15A, 3V	H-32			
FG17U	GTN	SCB 75A, 100V, 0.15A, 3V	H-32			
FG18A	GTN	SCB 75A, 200V, 0.15A, 3V	H-32			
FG18B	GTN	SCB 75A, 400V, 0.15A, 3V	H-32			
FG18C	GTN	SCB 75A, 600V, 0.15A, 3V	H-32			
FG18D	GTN	SCB 75A, 800V, 0.15A, 3V	H-32			
FG18E	GTN	SCB 75A, 1kV, 0.15A, 3V	H-32			
FG18F	GTN	SCB 75A, 1.2kV, 0.15A, 3V	H-32			
FG18G	GTN	SCB 75A, 1.4kV, 0.15A, 3V	H-32			
FG18U	GTN	SCB 75A, 100V, 0.15A, 3V	H-32			
FG19A	GTN	SCB 75A, 200V, 0.15A, 3V	H-32			
FG19B	GTN	SCB 75A, 400V, 0.15A, 3V	H-32			
FG19C	GTN	SCB 75A, 600V, 0.15A, 3V	H-32			
FG19D	GTN	SCB 75A, 800V, 0.15A, 3V	H-32			
FG19E	GTN	SCB 75A, 1kV, 0.15A, 3V	H-32			
FG19F	GTN	SCB 75A, 1.2kV, 0.15A, 3V	H-32			
FG19G	GTN	SCB 75A, 1.4kV, 0.15A, 3V	H-32			
FG19U	GTN	SCB 75A, 100V, 0.15A, 3V	H-32			
FG20A	GTN	SCB 75A, 200V, 0.15A, 3V	H-32			
FG20B	GTN	SCB 75A, 400V, 0.15A, 3V	H-32			
FG20C	GTN	SCB 75A, 600V, 0.15A, 3V	H-32			

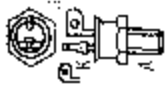
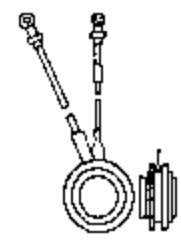
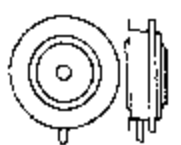

器件型号 Element type	厂名 Manufacturers	材料用途参数 Material Purpose Parameter	图号 Figure	国内外相似替换器件型号 Replace of similar type	备注 Notes	外形参考图 Reference shape
FG200	GTN	SCB 75A, 800V, 0.15A, 3V	H-32			 <p>图 H-32</p>
FG20E	GTN	SCB 75A, 1kV, 0.15A, 3V	H-32			
FG20F	GTN	SCB 75A, 1.2kV, 0.15A, 3V	H-32			
FG20G	GTN	SCB 75A, 1.4kV, 0.15A, 3V	H-32			
FG20U	GTN	SCB 75A, 100V, 0.15A, 3V	H-32			
FG450AL16	MIT	SCR-GC GTO, 200A, 800V, 1A, 3V	C-31			 <p>图 C-31</p>
FG450AL20	MIT	SCR-GC GTO, 200A, 1kV, 1A, 3V	C-31			
FG450AL24	MIT	SCR-GC GTO, 200A, 1.2kV, 1A, 3V	C-31			
FG450AL32	MIT	SCR-GC 450A, 1.6kV	C-31			
FG600AH32	MIT	GTO, 270A, 1.6kV, 2A, 3V	C-84			 <p>图 C-84</p>
FG600AH40	MIT	GTO, 270A, 2kV, 2A, 3V	C-84			
FG600AH50	MIT	GTO, 270A, 2.5kV, 2A, 3V	C-84			
FG600AL16	MIT	SCR-GC GTO, 270A, 800V, 2A, 3V	C-84			
FG600AL20	MIT	SCR-GC GTO, 270A, 1kV, 2A, 3V	C-84			
FG600AL24	MIT	SCR-GC GTO, 270A, 1.2kV, 2A, 3V	C-84			
FG600AL32	MIT	SCR-GC 600A, 1.6kV	C-84			
FG1000AH32	MIT	GTO, 450A, 1.6kV, 2A, 3V	C-84			
FG1000AH40	MIT	GTO, 450A, 2kV, 2A, 3V	C-84			
FG1000AH50	MIT	GTO, 450A, 2.5kV, 2A, 3V	C-84			
FG1000A16	MIT	GTO, 450A, 800V, 1A, 3V	C-84			
FG1000AL20	MIT	GTO, 450A, 1kV, 1A, 3V	C-84			
FG1000AL24	MIT	GTO, 450A, 1.2kV, 1A, 3V	C-84			
FG1800AH32	MIT	GTO, 860A, 1.6kV, 2A, 3V	C-84			
FG1800AH40	MIT	GTO, 860A, 2kV, 2A, 3V	C-84			
FG1800AH50	MIT	GTO, 860A, 2.5kV, 2A, 3V	C-84			

器件型号 Element type	厂名 Manufacturers	材料用途参数 Material Purpose Parameter	图号 Figure	国内外相似替换器件型号 Replace of similar type	备注 Notes	外形参考图 Reference shape
FP08C	SCR-D	30A, 200V, 0.05A, 0.03A	D-19	T6417B, T6410B, 2N5444, 2N5445, 2N5446		 图 D-19
FP08D	SCR-D	30A, 300V, 0.05A, 0.03A	D-19	T6417C, T6410C, 2N5444, 2N5445, 2N5446		
FP08E	SCR-D	30A, 400V, 0.05A, 0.03A	D-19	T6417D, T6410D, 2N5444, 2N5445, 2N5446		
FP08F	SCR-D	30A, 500V, 0.05A, 0.03A	D-19	T6417E, T6410E, 2N5446		
FP08G	SCR-D	30A, 600V, 0.05A, 0.03A	D-19	T6417M, T6410M, 2N5446		
FP08C	SCR-D	30A, 200V	D-19			
FP08D	SCR-D	30A, 300V	D-19			
FP08E	SCR-D	30A, 400V	D-19			
FP08F	SCR-D	30A, 500V	D-19			
FP08G	SCR-D	30A, 600V	D-19			
FQ08C	SCD-D	20A, 200V, 0.05A, 0.03A	D-19	SC260B, T6411R, T6410B, TXE99...		
FQ08D	SCD-D	20A, 300V, 0.05A, 0.03A	D-19	SC260C, T6411C, T6410C, TXE99...		
FQ08E	SCD-U	20A, 400V, 0.05A, 0.03A	D-19	SC260D, T6411D, T6410D, TXE99...		
FQ08F	SCD-D	20A, 500V, 0.05A, 0.03A	D-19	SC260E, T6411E, T6410E, TXE99...		
FQ08G	SCD-D	20A, 600V, 0.05A, 0.03A	D-19	SC260M, T6411M, T6410M, TXE99...		
FQ08C	SCD-D	20A, 200V	D-19			
FQ08D	SCD-D	20A, 300V	D-19			
FQ08E	SCD-D	20A, 400V	D-19			
FQ08F	SCD-D	20A, 500V	D-19			
FQ08G	SCD-D	20A, 600V	D-19			
FR08C	SCR-D	16A, 200V	D-19			
FR08D	SCR-D	16A, 300V	D-19			
FR08E	SCR-E	16A, 400V	D-19			
FR08F	SCR-D	16A, 500V	D-19			
FR08G	SCR-D	16A, 600V	D-19			
FR08C	SCR-D	16A, 200V	D-19			
FR08D	SCR-D	16A, 300V	D-19			

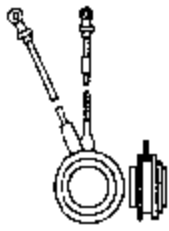
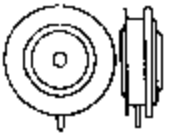
器件型号 Element type	厂名 Manufacturers	材料用途参数 Material Purpose Parameter	图号 Figure	国内外相似替换器件型号 Replace of similar type	备注 Notes	外形参考图 Reference shape
FR09F	SCR-D	16A, 400V	D-19			 图 D-19
FR09F	SCR-D	16A, 500V	D-19			
FR09G	SCR D	16A, 600V	D-19			
FR150CY-4	SCR-N	150A, 160V	C-32			 图 C-32
FR150CY-6	SCR-N	150A, 240V	C-32			
FR150CY-8	SCR-N	150A, 320V	C-32			
FR150CY-10	SCR-N	150A, 400V	C-32			
FR150CY-12	SCR-N	150A, 480V	C-32			
FR150CY-16	SCR-N	150A, 640V	C-32			
FR150DX12	MIT	RCT, 150A, 600V, 0.2A, 3V	C-32			
FR150DX16	MIT	RCT, 150A, 800V, 0.2A, 3V	C-32			
FR150DX20	MIT	RCT, 250A, 1kV, 0.25A, 3V	C-32			
FR150DX24	MIT	RCT, 250A, 1.2kV, 0.2A, 3V	C-32			
FR150DY4	MIT	RCT, 150A, 200V, 0.2A, 3V	C-16			
FR150DY6	MIT	RCT, 150A, 300V, 0.2A, 3V	C-16			
FR150DY8	MIT	RCT, 150A, 400V, 0.2A, 3V	C-16			
FR150DY10	MIT	RCT, 150A, 500V, 0.2A, 3V	C-16			
FR150DY12	MIT	RCT, 150A, 600V, 0.2A, 3V	C-16			
FR150DY16	MIT	RCT, 150A, 800V, 0.2A, 3V	C-16			
FR300D6-10	SCR-N	400V, 250V	C-32			 图 C-16
FR300D6-12	SCR-N	480V, 250V	C-32			
FR300DX12	MIT	RCT, 250A, 600V, 0.25A, 3V	C-32			
FR300DX16	MIT	RCT, 250A, 800V, 0.25A, 3V	C-32			
FR300DX20	MIT	RCT, 250A, 1kV, 0.25A, 3V	C-32			
FR300DX24	MIT	RCT, 250A, 1.2kV, 0.25A, 3V	C-32			
FR300DY4	MIT	RCT, 250A, 200V, 0.25A, 3V	C-32			
FR300DY6	MIT	RCT, 250A, 300V, 0.25A, 3V	C-32			



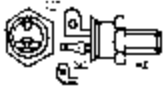
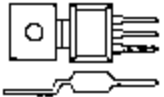
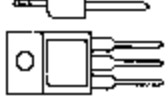

器件型号 Element type	厂名 Manufacturers	材料用途参数 Material Purpose Parameter	图号 Figure	国内外相似替换器件型号 Replace of similar type	备注 Notes	外形参考图 Reference shape
FR300DY8	MIT	SCR-N RCT, 250A, 400V, 0.25A, 3V	C-32			
FR300DY10	MIT	SCR-N RCT, 250A, 500V, 0.25A, 3V	C-16			
FR300DY12	MIT	RCT, 250A, 600V, 0.25A, 3V	C-16			
FR300DY16	MIT	RCT, 250A, 800V, 0.25A, 3V	C-32			
FR500AX12	MIT	RCT, 400A, 600V, 0.35A, 3V	C-76			
FR500AX16	MIT	RCT, 400A, 800V, 0.35A, 3V	C-76			
FR500AX20	MIT	RCT, 400A, 1kV, 0.35A, 3V	C-76			
FR500AX24	MIT	RCT, 400A, 1.2kV, 0.35A, 3V	C-76			
FR500AY4	MIT	RCT, 400A, 200V, 0.35A, 3V	C-76			
FR500AY6	MIT	RCT, 400A, 300V, 0.35A, 3V	C-76			
FR500AY8	MIT	RCT, 400A, 400V, 0.35A, 3V	C-76			
FR500AY10	MIT	RCT, 400A, 500V, 0.35A, 3V	C-76			
FR500AY12	MIT	RCT, 400A, 600V, 0.35A, 3V	C-76			
FR500AY16	MIT	RCT, 400A, 800V, 0.35A, 3V	C-76			
FR500AY20	MIT	RCT, 400A, 1kV, 0.35A, 3V	C-76			
FR500AY24	MIT	RCT, 400A, 1.2kV, 0.35A, 3V	C-76			
FR600AW50	MIT	SCR-N RCT, 400A, 2.5kV, 0.4A, 4V	C-76			
FR600AX50	MIT	SCR-N RCT, 400A, 2.5kV, 0.35A, 4V	C-76			
FR1000BW50	MIT	SCR-N RCT, 1kA, 2.5kV, 0.35A, 4V	C-78			
FR1000BX50	MIT	SCR-N RCT, 1kA, 2.5kV, 0.3A, 4V	C-78			
FS08C		SCR-D 10A, 200V	D-19			
FS08D		SCR-D 10A, 300V	D-19			
FS08E		SCR-D 10A, 400V	D-19			
FS08F		SCR-D 10A, 500V	D-19			
FS08G		SCR-D 10A, 600V	D-19			

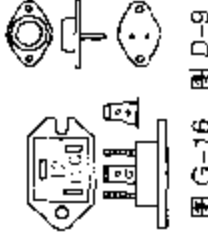
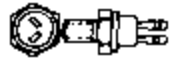
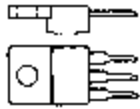
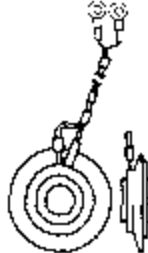
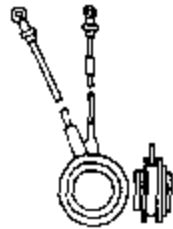
器件型号 Element type	厂名 Manufacturers	材料 Material	用途 Purpose	参数 Parameter	图号 Figure	国内外相似替换器件型号 Replace of similar type	备注 Notes	外形参考图 Reference shape
FS09C	SCR-D	10A, 200V			D-19			 图 D-19
FS09D	SCR-D	10A, 300V			D-19			
FS09E	SCR-D	10A, 400V			D-19			
FS09F	SCR-D	10A, 500V			D-19			
FS09G	SCR-D	10A, 600V			D-19			
FSD20A30	MOD	2 x SCR-3D, 20A, 300V						
FSM3B2	SCR-D	3A, 200V, 0.04A, 0.02A			B-21	TAG136-200, ZO410B		 图 B-21
FSM3B4	SCR-D	3A, 400V, 0.04A, 0.02A			B-21	TAG136-400, ZO410D		
FSM6B2	SCR-D	6A, 200V, 0.03A, 0.02A			B-10	T2856B, TAG426-200, TAG452-200		
FSM6B4	SCR-D	6A, 400V, 0.03A, 0.02A			B-10	T2856D, TAG426-400, TAG452-400		
FSM10B4	SCR-D	10A, 400V, 0.03A, 0.02A			B-10	TAG457-400, BT162D, TAG257-400		
FSM16C2	SCR-D	16A, 200V, 0.05A			G-16	MAC515, MAC515A, MAC525		 图 B-10
FSM16C4	SCR-D	16A, 400V, 0.05A			G-16	MAC515-400, MAC515A-400, MAC525-400		
FSM16C6	SCR-D	16A, 600V, 0.05A			G-16	MAC515-600, MAC515A-600, MAC525-600		
FSM20C2	SCR-D	20A, 200V, 0.05A			G-16	MAC525-200, MAC525A-200		
FSM20C4	SCR-D	20A, 400V, 0.05A			G-16	MAC525-400, MAC525A-400		
FSM20C6	SCR-D	20A, 600V			G-16			
FSM25C2		25A, 200V			G-16			 图 G-16
FSM25C4		25A, 400V			G-16			
FSM25C6		25A, 600V			G-16			
FSM30C2	SCR-D	30A, 200V, 0.05A			G-16	MAC50-200, MAC50A-200, TAG740-200		
FSM30C4	SCR-D	30A, 400V, 0.05A			G-16	MAC50-400, MAC50A-400, TAG740-400		

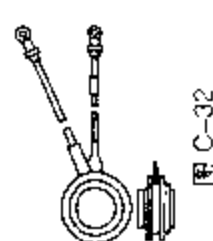
器件型号 Element type	厂名 Manufacturers	材料用途参数 Material Purpose Parameter	图号 Figure	国内外相似替换器件型号 Replace of similar type	备注 Notes	外形参考图 Reference shape
FSM300C6	SCR-D	30A, 600V	G-16			 图 G-16 图 D-9
FT06B	SCR-D	6A, 100V, 0.075A	D-9	TAG260-100, TAG265-100, T4700A		
FT06C	SCR-D	6A, 200V, 0.075A	D-9	TAG260-200, TAG265-200, T4700B		
FT06D	SCR-D	6A, 300V, 0.075A	D-9	TAG260-300, TAG265-300, T4700C		
FT06E	SCR-D	6A, 400V, 0.075A	D-9	TAG260-400, TAG265-400, T4700D		
FT07C	SCR-D	6A, 200V, 0.05A	D-9	TAG260-200, TAG265-200, T4700B		
FT07D	SCR-D	6A, 300V, 0.05A	D-9	TAG260-300, TAG265-300, T4700C		
FT07E	SCR-D	6A, 400V, 0.05A	D-9	TAG260-400, TAG265-400, T4700D		
FT07F	SCR-D	6A, 500V, 0.05A	D-9	TAG260-500, TAG265-500, T4700E		
FT07G	SCR-D	6A, 600V, 0.05A	D-9	TAG260-600, TAG265-600, T4700M		
FT08C		6A, 200V, 0.05A	F-55	BS6-02A, BS8-02A, TW8N200C, TW8N200C		 图 F-55
FT08D		6A, 300V, 0.05A	F-55	BS6-03A, BS8-03A, TW6N300C, TW8N300C		 图 B-11
FT08E		6A, 400V, 0.05A	F-55	BS6-04A, BS8-04A, TW6N400C, TW8N400C		
FT08F		6A, 500V, 0.05A	F-55	BS6-05A, BS8-05A, TW6N500C, TW8N500C		
FT08G		6A, 600V, 0.05A	F-55	BS6-06A, BS8-06A, TW6N600C, TW8N600C		
FT09C		6A, 200V				
FT09D		6A, 300V				
FT09E		6A, 400V				
FT09F		6A, 500V				
FT09G		6A, 600V				
FT12C	SCR-D	6A, 200V, 0.075A	B-11	BS7-02A, MAC216A4, SC141B, T2801B		 图 C-76
FT12E	SCR-D	6A, 400V, 0.075A	B-11	BS7-04A, MAC216A6, SC141D, T2801D		 图 C-32
FT100A 20		100A, 1kV	C-76			
FT100DM4	MIT	100A, 200V, 0.1A, 1.5V	C-32			
FT100DM6	MIT	100A, 300V, 0.1A, 1.5V	C-32			
FT100DM8	MIT	100A, 400V, 0.1A, 1.5V	C-32			

器件型号 Element type	厂名 Manufacturers	材料 Material	用途 Purpose	参数 Parameter	图号 Figure	国内外相似替换器件型号 Replace of similar type	备注 Notes	外形参考图 Reference shape
FT100DM10	MIT	100A	500V, 0.1A, 1.5V	C-32				 <p>图 C-32</p>
FT100DM12	MIT	100A	600V, 0.1A, 1.5V	C-32				
FT100DM16	MIT	100A	800V, 0.1A, 1.5V	C-32				
FT100DM20	MIT	100A	1kV, 0.1A, 1.5V	C-32				
FT100DM24	MIT	100A	1.2kV, 0.1A, 1.5V	C-32				
FT100DM28	MIT	100A	1.4kV	C-32				
FT100DM32	MIT	100A	1.6kV, 0.1A, 1.5V	C-32				
FT100DM36	MIT	100A	1.8kV, 0.1A, 1.5V	C-32				
FT100DX4	MIT	SCR-H	100A, 200V, 0.1A, 2V	C-32				
FT100DX6	MIT	SCR-H	100A, 300V, 0.1A, 2V	C-32				
FT100DX8	MIT	SCR-H	100A, 400V, 0.1A, 2V	C-32				
FT100DX10	MIT	SCR-H	100A, 500V, 0.1A, 2V	C-32				
FT100DX12	MIT	SCR-H	100A, 600V, 0.1A, 2V	C-32				
FT100DX16	MIT	SCR-H	100A, 800V, 0.1A, 2V	C-32				
FT100DX20	MIT	SCR-H	100A, 1kV, 0.1A, 2V	C-32				
FT100DY4	MIT	SCR-H	100A, 200V, 0.1A, 2V	C-32				
FT100DY6	MIT	SCR-H	100A, 300V, 0.1A, 2V	C-32				
FT100DY8	MIT	SCR-H	100A, 400V, 0.1A, 2V	C-32				
FT100DY10	MIT	SCR-H	100A, 500V, 0.1A, 2V	C-32				
FT100DY12	MIT	SCR-H	100A, 600V, 0.1A, 2V	C-32				
FT100DY16	MIT	SCR-H	100A, 800V, 0.1A, 2V	C-32				
FT150DX4	MIT	SCR-H	150A, 200V, 0.2A, 2V	C-32				
FT150DX6	MIT	SCR-H	150A, 300V, 0.2A, 2V	C-32				
FT150DX8	MIT	SCR-H	150A, 400V, 0.2A, 2V	C-32				
FT150DX10	MIT	SCR-H	150A, 500V, 0.2A, 2V	C-32				
FT150DX12	MIT	SCR-H	150A, 600V, 0.2A, 2V	C-32				
FT150DX16	MIT	SCR-H	150A, 800V, 0.2A, 2V	C-32				
FT150DX20	MIT	SCR-H	150A, 1kV, 0.2A, 2V	C-32				



器件型号 Element type	厂名 Manufacturers	材料用途参数 Material Purpose Parameter	图号 Figure	国内外相似替换器件型号 Replace of similar type	备注 Notes	外形参考图 Reference shape
FT150DY4	MIT	150A, 200V, 0.2A, 2V	C-16			 图 C-16
FT150DY6	MIT	150A, 300V, 0.2A, 2V	C-16			
FT150DY8	MIT	150A, 400V, 0.2A, 2V	C-16			
FT150DY10	MIT	150A, 500V, 0.2A, 2V	E-8			
FT150DY12	MIT	150A, 600V, 0.2A, 2V	C-16			
FT150DY16	MIT	150A, 800V, 0.2A, 2V	C-16			
FT150EM16	MIT	100A, 800V, 0.25A, 2.5V	C-32			
FT150EM20	MIT	100A, 1kV, 0.25A, 2.5V	C-32			
FT150EM24	MIT	100A, 1.2kV, 0.25A, 2.5V	C-32			
FT150EM28	MIT	100A, 1.4kV, 0.25A, 2.5V	C-32			
FT150EM32	MIT	100A, 1.6kV, 0.25A, 2.5V	C-32			
FT150EM36	MIT	100A, 1.8kV, 0.25A, 2.5V	C-32			
FT150EX16	MIT	100A, 800V, 0.25A, 2.5V	C-32			
FT150EX20	MIT	100A, 1kV, 0.25A, 2.5V	C-32			
FT150EX24	MIT	100A, 1.2kV, 0.25A, 2.5V	C-32			
FT150EX28	MIT	100A, 1.4kV, 0.25A, 2.5V	C-32			
FT150EX32	MIT	100A, 1.6kV, 0.25A, 2.5V	C-32			
FT150EX36	MIT	100A, 1.8kV, 0.25A, 2.5V	C-32			
FT250DM4	MIT	250A, 200V, 0.2A, 1.5V	C-32			 图 E-8
FT250DM6	MIT	250A, 300V, 0.2A, 1.5V	C-32			
FT250DM8	MIT	250A, 400V, 0.2A, 1.5V	C-32			
FT250DM10	MIT	250A, 500V, 0.2A, 1.5V	C-32			
FT250DM12	MIT	250A, 600V, 0.2A, 1.5V	C-32			
FT250DM16	MIT	250A, 800V, 0.2A, 1.5V	C-32			
FT250DM20	MIT	250A, 1kV, 0.2A, 1.5V	C-32			
FT250DM24	MIT	250A, 1.2kV, 0.2A, 1.5V	C-32			
FT250DM28	MIT	250A, 1.4kV, 0.2A, 1.5V	C-32			
FT250DM32	MIT	250A, 1.6kV, 0.2A, 1.5V	C-32			
FT250DM4	MIT	250A, 200V, 0.2A, 1.5V	C-32			
FT250DM6	MIT	250A, 300V, 0.2A, 1.5V	C-32			
FT250DM8	MIT	250A, 400V, 0.2A, 1.5V	C-32			
FT250DM10	MIT	250A, 500V, 0.2A, 1.5V	C-32			
FT250DM12	MIT	250A, 600V, 0.2A, 1.5V	C-32			
FT250DM16	MIT	250A, 800V, 0.2A, 1.5V	C-32			
FT250DM20	MIT	250A, 1kV, 0.2A, 1.5V	C-32			
FT250DM24	MIT	250A, 1.2kV, 0.2A, 1.5V	C-32			
FT250DM28	MIT	250A, 1.4kV, 0.2A, 1.5V	C-32			
FT250DM32	MIT	250A, 1.6kV, 0.2A, 1.5V	C-32			



图 C-32

器件型号 Element type	厂名 Manufacturers	材料用途参数 Material Purpose Parameter	图号 Figure	国内外相似替换器件型号 Replace of similar type	备注 Notes	外形参考图 Reference shape
FT250DM36	MIT	250A, 1.8kV, 0.2A, 1.5V	C-32			
FT250DX4	MIT	SCR-H 250A, 200V, 0.2A, 2V	C-32			
FT250DX6	MIT	SCR-H 250A, 300V, 0.2A, 2V	C-32			
FT250DX8	MIT	SCR-H 250A, 400V, 0.2A, 2V	C-32			
FT250DX10	MIT	SCR-H 250A, 500V, 0.2A, 2V	C-32			
FT250DX12	MIT	SCR-H 250A, 600V, 0.2A, 2V	C-32			
FT250DX16	MIT	SCR-H 250A, 800V, 0.2A, 2V	C-32			
FT250DX20	MIT	SCR-H 250A, 1kV, 0.2A, 2V	C-32			
FT250DY4	MIT	SCR-H 250A, 200V, 0.2A, 2V	C-32			
FT250DY6	MIT	SCR-H 250A, 300V, 0.2A, 2V	C-32			
FT250DY8	MIT	SCR-H 250A, 400V, 0.2A, 2V	C-32			
FT250DY10	MIT	SCR-H 250A, 500V, 0.2A, 2V	C-32			
FT250DY12	MIT	SCR-H 250A, 600V, 0.2A, 2V	C-32			
FT250DY16	MIT	SCR-H 250A, 800V, 0.2A, 2V	C-32			
FT300AV60		3kA, 3kV	C-78			
FT300AV70		3kA, 3.5kV	C-78			
FT300AV80		3kA, 4kV	C-78			
FT300DL4	MIT	SCR-H 300A, 200V, 0.2A, 2.5V	C-32			
FT300DL6	MIT	SCR-H 300A, 300V, 0.2A, 2.5V	C-32			
FT300DL8	MIT	SCR-H 300A, 400V, 0.2A, 2.5V	C-32			
FT300DL10	MIT	SCR-H 300A, 500V, 0.2A, 2.5V	C-32			
FT300DL12	MIT	SCR-H 300A, 600V, 0.2A, 2.5V	C-32			
FT300DL16	MIT	SCR-H 300A, 800V, 0.2A, 2.5V	C-32			
FT300DL20	MIT	SCR-H 300A, 1kV, 0.2A, 2.5V	C-32			
FT300DL24	MIT	SCR-H 300A, 1.2kV, 0.2A, 2.5V	C-32			
FT300DM26		SCR-H 300A, 1.4kV	C-76			
FT300DM28	MIT	SCR-H 300A, 1.4kV, 0.2A, 2.5V	C-32			
FT300DM32		SCR-H 300A, 1.6kV	C-76			



图 C-32

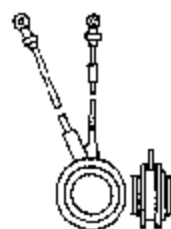
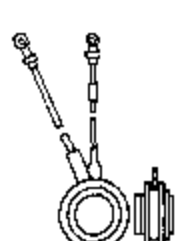

图 C-78

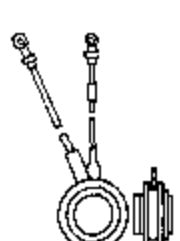

图 C-76

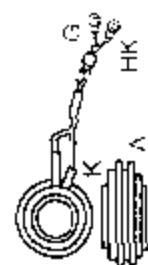
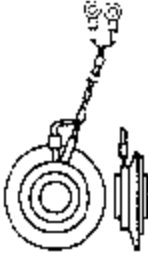

器件型号 Element type	厂名 Manufacturers	材料用途参数 Material Purpose Parameter	图号 Figure	国内外相似替换器件型号 Replace of similar type	备注 Notes	外形参考图 Reference shape
FT300DM36	MIT	SCR-H 300A, 1.8kV, 0.2A, 2.5V	C-76			
FT300DX4	MIT	SCR-H 300A, 200V, 0.2A, 2.5V	C-32			
FT300DX6	MIT	SCR-H 300A, 300V, 0.2A, 2.5V	C-32			
FT300DX8	MIT	SCR-H 300A, 400V, 0.2A, 2.5V	C-32			
FT300DX10	MIT	SCR-H 300A, 500V, 0.2A, 2.5V	C-32			
FT300DX12	MIT	SCR-H 300A, 600V	C-32			
FT300DX16	MIT	SCR-H 300A, 800V, 0.2A, 2.5V	C-32			
FT300DX20	MIT	SCR-H 300A, 1kV, 0.2A, 2.5V	C-32			
FT300DX24	MIT	SCR-H 300A, 1.2kV, 0.2A, 2.5V	C-32			
FT300DY4	MIT	SCR-H 300A, 200V, 0.2A, 2.5V	C-32			
FT300DY6	MIT	SCR-H 300A, 300V, 0.2A, 2.5V	C-32			
FT300DY8	MIT	SCR-H 300A, 400V, 0.2A, 2.5V	C-32			
FT300DY10	MIT	SCR-H 300A, 500V, 0.2A, 2.5V	C-32			
FT300DY16	MIT	SCR-H 300A, 800V, 0.2A, 2.5V	C-32			
FT300EM16	MIT	SCR-H 200A, 800V	C-32			
FT300EM20	MIT	SCR-H 200A, 1kV, 0.25A, 2.5V	C-32			
FT300EM24	MIT	SCR-H 200A, 1.2kV, 0.25A, 2.5V	C-32			
FT300EM28	MIT	SCR-H 200A, 1.4kV, 0.25A, 2.5V	C-32			
FT300EM32	MIT	SCR-H 200A, 1.6kV, 0.25A, 2.5V	C-32			
FT300EM36	MIT	SCR-H 200A, 1.8kV, 0.25A, 2.5V	C-32			
FT300EX16	MIT	SCR-H 200A, 800V, 0.25A, 2.5V	C-32			
FT300EX20	MIT	SCR-H 200A, 1kV, 0.25A, 2.5V	C-32			
FT300EX24	MIT	SCR-H 200A, 1.2kV, 0.25A, 2.5V	C-32			
FT300EX28	MIT	SCR-H 200A, 1.4kV, 0.25A, 2.5V	C-32			
FT300EX32	MIT	SCR-H 200A, 1.6kV, 0.25A, 2.5V	C-32			
FT300EX36	MIT	SCR-H 200A, 1.8kV, 0.25A, 2.5V	C-32			
FT317	SCR-H	8A, 100V, 40W, 240MHz		MJE15028, 3DK109D		
FT317A	SCR-H	8A, 120V, 40W, 20MHz		MJE15028, 3DK109E		







图 C-32

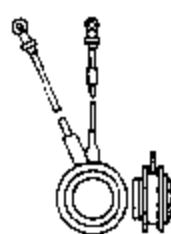

图 C-76

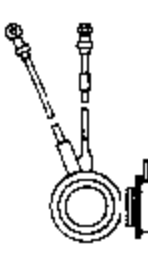
器件型号 Element type	厂名 Manufacturers	材料 Material	用途 Purpose	参数 Parameter	图号 Figure	国内外相似替换器件型号 Replace of similar type	备注 Notes	外形参考图 Reference shape
FT317B	SCR-H	8A, 140V, 40W, 20MHz				MUE1502B, 3DK109E		
FT500A16	MIT	SCR-H	628A, 800V, 0.25A, 2.5V	C-76				 <p>图 C-76</p>
FT500A20	MIT	SCR-H	628A, 1kV, 0.25A, 2.5V	C-76				
FT500A24	MIT	SCR-H	628A, 1.2kV, 0.25A, 2.5V	C-76			 <p>图 C-32</p>	
FT500A28	MIT	SCR-H	628A, 1.4kV, 0.25A, 2.5V	C-76				
FT500A32	MIT	SCR-H	628A, 1.6kV, 0.25A, 2.5V	C-76				
FT500A36	MIT	SCR-H	628A, 1.8kV, 0.25A, 2.5V	C-76				
FT500A40	MIT	SCR-H	628A, 2kV, 0.25A, 2.5V	C-76				
FT500A50	MIT	SCR-H	628A, 2.5kV, 0.25A, 2.5V	C-76				
FT500AH60	MIT	SCR-H	320A, 3kV, 0.25A, 2.5V	C-76				
FT500AH70	MIT	SCR-H	320A, 3.5kV, 0.25A, 2.5V	C-76				
FT500AH80	MIT	SCR-H	320A, 4kV	C-76				
FT500DL4	MIT	FT500DL4	500A, 200V, 0.25A, 2.5V	C-32				
FT500DL6	MIT	FT500DL6	500A, 300V, 0.25A, 2.5V	C-32				
FT500DL8	MIT	FT500DL8	500A, 400V, 0.25A, 2.5V	C-32				
FT500DL10	MIT	FT500DL10	500A, 500V, 0.25A, 2.5V	C-32				
FT500DL12	MIT	FT500DL12	500A, 600V, 0.25A, 2.5V	C-32				
FT500DL16	MIT	FT500DL16	500A, 800V, 0.25A, 2.5V	C-32				
FT500DL20	MIT	FT500DL20	500A, 1kV, 0.25A, 2.5V	C-32				
FT500DL24	MIT	FT500DL24	500A, 1.2kV, 0.25A, 2.5V	C-32				
FT500DL28	MIT	FT500DL28	500A, 1.4kV, 0.25A, 2.5V	C-32				
FT500DX16	MIT	FT500DX16	400A, 800V, 0.25A, 2.5V	C-76				
FT500DX20	MIT	FT500DX20	400A, 1kV, 0.25A, 2.5V	C-76				
FT500DX24	MIT	FT500DX24	400A, 1.2kV, 0.25A, 2.5V	C-76				
FT500DY16	MIT	FT500DY16	400A, 800V, 0.25A, 2.5V	C-76				
FT500DY20	MIT	FT500DY20	400A, 1kV, 0.25A, 2.5V	C-76				
FT500DY24	MIT	FT500DY24	400A, 1.2kV, 0.25A, 2.5V	C-76				
FT500EX20	MIT	SCR-H	400A, 1kV, 0.25A, 2.5V	C-32				

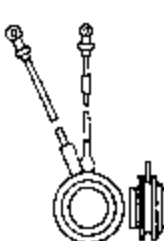
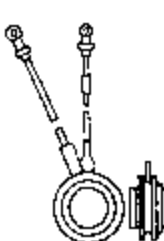
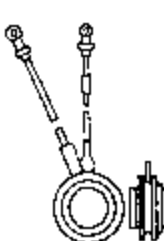

器件型号 Element type	厂名 Manufacturers	材料用途参数 Material Purpose Parameter	图号 Figure	国内外相似替换器型号 Replace of similar type	备注 Notes	外形参考图 Reference shape
FT500EX24	MIT	SCR-H 400A, 1.2kV, 0.25A, 2.5V	C-32			 图 C-32
FT500EY20	MIT	SCR-H 400A, 1kV, 0.25A, 2.5V	C-32			
FT500EY24	MIT	SCR-H 400A, 1.2kV, 0.25A, 2.5V	C-32			
FT500GZ16	MIT	SCR-H 400A, 800V, 0.35A, 2.5V	C-32			 图 C-32
FT500GZ20	MIT	SCR-H 400A, 1kV, 0.35A, 2.5V	C-32			
FT500GZ24	MIT	SCR-H 400A, 1.2kV, 0.35A, 2.5V	C-32			
FT500HZ16	MIT	SCR-H 400A, 800V, 0.35A, 2.5V	C-32			 图 C-32
FT500HZ20	MIT	SCR-H 400A, 1kV, 0.35A, 2.5V	C-32			
FT500HZ24	MIT	SCR-H 400A, 1.2kV, 0.35A, 2.5V	C-32			
FT800DL4	MIT	800A, 200V, 0.2A, 3V	C-32			 图 C-76
FT800DL6	MIT	800A, 300V, 0.2A, 3V	C-32			
FT800DL8	MIT	800A, 400V, 0.2A, 3V	C-32			
FT800DL10	MIT	800A, 500V, 0.2A, 3V	C-32			
FT800DL12	MIT	800A, 600V, 0.2A, 3V	C-32			
FT800DL16	MIT	800A, 800V, 0.2A, 3V	C-32			
FT800DL20	MIT	800A, 1kV, 0.2A, 3V	C-32			
FT800DL24	MIT	800A, 1.2kV, 0.2A, 3V	C-32			
FT1000A16	MIT	1kA, 800V, 0.25A, 3V	C-76			
FT1000A20	MIT	1kA, 1kV, 0.25A, 3V	C-11			
FT1000A24	MIT	1kA, 1.2kV, 0.25A, 3V	C-76			
FT1000A28	MIT	1kA, 1.4kV	C-76			
FT1000A32	MIT	1kA, 1.6kV, 0.25A, 3V	C-76			
FT1000A36	MIT	1kA, 1.8kV, 0.25A, 3V	C-76			
FT1000A40	MIT	1kA, 2kV, 0.25A, 3V	C-76			
FT1000A50	MIT	1kA, 2.5kV, 0.25A, 3V	C-76			







图 C-11

器件型号 Element type	厂名 Manufacturers	材料用途参数 Material Purpose Parameter	图号 Figure	国内外相似替换器件型号 Replace of similar type	备注 Notes	外形参考图 Reference shape
FT1000BV60	MIT	1.57kA, 3kV, 0.25A, 2.5V	C-78			 图 C-78
FT1000BV70	MIT	1.57kA, 3.5kV, 0.25A, 2.5V	C-78			
FT1000BV80		1kA, 4kV	C-78			
FT1000CM16	MIT	800A, 600V, 0.35A, 3V	C-11			 图 C-11
FT1000CM20	MIT	800A, 1kV, 0.35A, 3V	C-11			
FT1000CM24	MIT	800A, 1.2kV, 0.35A, 3V	C-11			
FT1000CM28	MIT	800A, 1.4kV, 0.35A, 3V	C-11			
FT1000CM32	MIT	800A, 1.6kV, 0.35A, 3V	C-11			
FT1000CX16	MIH	800A, 800V, 0.35A, 3V	C-76			
FT1000CX20	MIT	800A, 1kV, 0.35A, 3V	C-76			
FT1000CX24	MIT	800A, 1.2kV, 0.35A, 3V	C-76			
FT1000CX28	MIT	800A, 1.4kV, 0.35A, 3V	C-76			
FT1000CX32	MIT	800A, 1.6kV, 0.35A, 3V	C-76			
FT1000CX36	MIT	800A, 1.8kV, 0.35A, 3V	C-76			
FT1000CY16	MIT	800A, 800V, 0.35A, 3V	C-76			
FT1000CY20	MIT	800A, 1kV, 0.35A, 3V	C-76			
FT1000CY24	MIT	800A, 1.2kV, 0.35A, 3V	C-76			
FT1500CH-32		1.5kA, 1.6kV				 图 C-76
FT1500CH-36		1.5kA, 1.8kV				
FT1500CH-40		1.5kA, 2kV				
FT1500CH-50		1.5kA, 2.5kV				
FT1500CH-54		1.5kA, 2.7kV				
FT1500DL4	MIT	1.5kA, 200V, 0.25A, 2.5V	C-78			
FT1500DL6	MIT	1.5kA, 300V, 0.25A, 2.5V	C-78			
FT1500DL8	MIT	1.5kA, 400V, 0.25A, 2.5V	C-78			
FT1500DL12	MIT	1.5kA, 600V, 0.25A, 2.5V	C-78			
FT1500DL16	MIT	1.5kA, 800V, 0.25A, 2.5V	C-78			
FT1500DL20	MIT	1.5kA, 1kV, 0.25A, 2.5V	C-78			

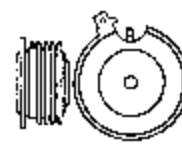
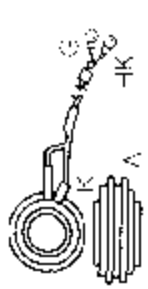
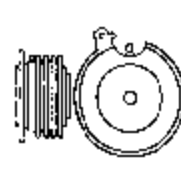

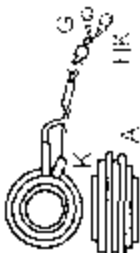
器件型号 Element type	厂名 Manufacturers	材料用途参数 Material Purpose Parameter	图号 Figure	国内外相似替换器件型号 Replace of similar type	备注 Notes	外形参考图 Reference shape
FT1500DL24		1.5kA, 1.2kV	C-78			 <p>图 C-78</p>
FT1500DV60	MIT	1.5kA, 3kV, 0.35A, 3V	C-78			
FT1500DV70	MIT	1.5kA, 3.5kV, 0.35A, 3V	C-78			
FT1500DV80	MIT	1.5kA, 4kV, 0.35A, 3V	C-78			
FT1500EX16	MIT	SCR-GC 1.5kA, 800V, 0.35A, 3V	C-78			
FT1500EX20	MIT	SCR GC 1.5kA, 1kV, 0.35A, 3V	C-78			
FT1500EX24	MIT	SCR-GC 1.5kA, 1.2kV, 0.35A, 3V	C-78			
FT1500EY16		SCR-GC 1.5kA, 800V	C-78			
FT1500EY20		SCR-GC 1.5kA, 1kV	C-78			
FT1500EY24		SCR-GC 1.5kA, 1.2kV	C-78			
FT1500GV-70		1.5kA, 3kV	C-78			 <p>图 B-62</p>
FT1500GV-80		1.5kA, 3.5kV	C-78			
FT1500GV-90		1.5kA, 4kV	C-78			
FT1869...1874		50Hz-Thy 1.25A, 15-200V, 0.002A, 0.8V	B-62	2N1869...1874		 <p>图 C-17</p>
FT1881...1885		50Hz-Thy 1.25A, 60-200V, 0.02A, 80V	B-62	2N1881...1885		
FT2009...2013		50Hz Thy 1.3A, 25-300V, 0.02A, 1V	B-62	2N2009...2013		
FT2500BH16	MIT	2.5kA, 800V, 0.25A, 2.5V	C-17			 <p>图 C-17</p>
FT2500BH20	MIT	2.5kA, 1kV, 0.25A, 2.5V	C-17			
FT2500BH24	MIT	2.5kA, 1.2kV, 0.25A, 2.5V	C-17			
FT2500BH28	MIT	2.5kA, 1.4kV, 0.25A, 2.5V	C-17			
FT2500BH32	MIT	2.5kA, 1.6kV, 0.25A, 2.5V	C-78			
FT2500BH36	MIT	2.5kA, 1.8kV, 0.25A, 2.5V	C-78			
FT2500BH40	MIT	2.5kA, 2kV, 0.25A, 2.5V	C-78			
FT2500BH50	MIT	2.5kA, 2.5kV, 0.25A, 2.5V	C-78			
FT2500BH56	MIT	2.5kA, 2.8kV, 0.25A, 2.5V	C-78			
FT2500CL4	MIT	2.5kA, 200V, 0.12A, 3.5V	C-78			
FT2500CL6	MIT	2.5kA, 300V, 0.12A, 3.5V	C-78			

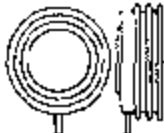
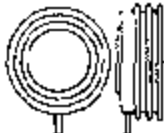
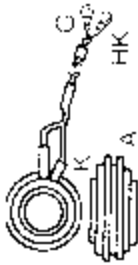
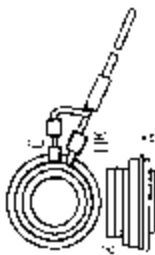
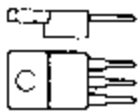
器件型号 Element type	厂名 Manufacturers	材料用途参数 Material Purpose Parameter	图号 Figure	国内外相似替换器件型号 Replace of similar type	备注 Notes	外形参考图 Reference shape
FT2500CL8	MIT	2.5kA, 400V, 0.12A, 3.5V	C-78			 <p>图 C-78</p>
FT2500CL12	MIT	2.5kA, 600V, 0.12A, 3.5V	C-78			
FT2500CL16	MIT	2.5kA, 800V, 0.12A, 3.5V	C-78			
FT2500CL20	MIT	2.5kA, 1kV, 0.12A, 3.5V	C-78			
FT2500CL24	MIT	2.5kA, 1.2kV, 0.12A, 3.5V	C-78			
FT3000AV60		3kA, 3kV, 0.35A, 3V	C-84			 <p>图 C-84</p>
FT3000AV70		3kA, 3.5kV, 0.35A, 3V	C-84			
FT3000AV80		3kA, 4kV, 0.35A, 3V	C-84			
FU12B	Triac	3A, 100V, 0.03A	B-11	TAG220-100, TAG230-100, TAG231-100		 <p>图 B-11</p>
FU12C	Triac	3A, 200V, 0.03A	B-11	TAG220-200, TAG230-200, TAG231-200		
FU12D	Triac	3A, 300V, 0.03A	B-11	TAG220-300, TAG230-300, TAG231-300		
FU12E	Triac	3A, 400V, 0.03A	B-11	TAG220-400, TAG230-400, TAG231-400		



F 类外形参考图索引



图 B-9



图 B-10

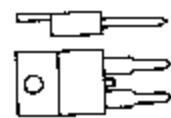

图 B-11

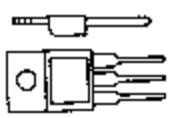

图 B-21

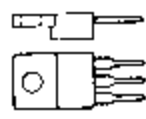

图 B-62

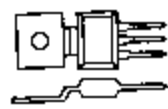

图 B-91



图 C-11

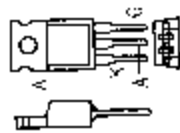

图 C-16



图 C-17

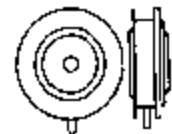

图 C-31

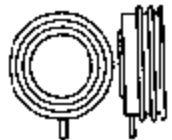

图 C-32

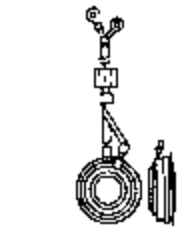

图 C-49

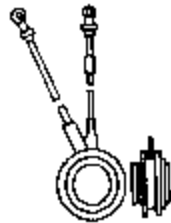

图 C-76

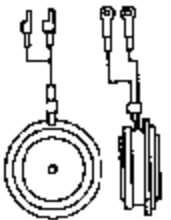

图 C-78

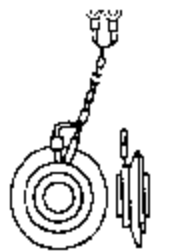

图 C-84

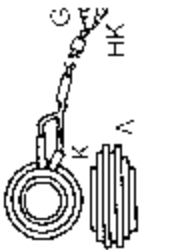

图 D-9

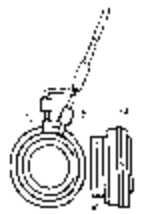

图 D-19

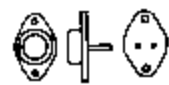

图 E-22

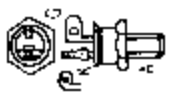

图 E-8



图 F-17



图 F-21



图 F-55



图 F-91



图 G-16







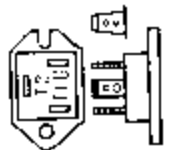

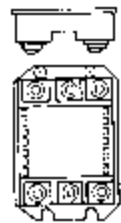

图 H-32

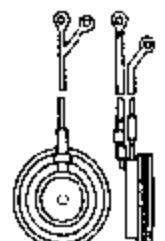

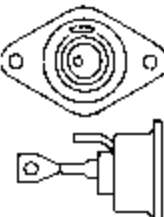
器件型号 Element type	厂名 Manufacturers	材料用途参数 Material Purpose Parameter	图号 Figure	国内外相似替换器件型号 Replace of similar type	备注 Notes	外形参考图 Reference shape
GA100	UNI	0.4A, 30V, 0.0035A, 0.7V	B-65			 图 B-65
GA101	UNI	0.4A, 60V, 0.0035A, 0.7V	B-65			
GA102	UNI	0.4A, 80V, 0.0035A, 0.7V	B-65			
GA200, A	UNI	0.4A, 60V, 200 μ A, 0.75V	B-65	S1001MS2		 图 F-59
GA201, A	UNI	0.4A, 100V, 200 μ A, 0.75V	B-65	S1001MS2		
GA300, A	UNI	100A, 60V, 100 μ A, 0.75V	B-65	S1006MS2		
GA301, A	UNI	100A, 100V, 100 μ A, 0.75V	B-65	S1006MS2		
GB200, A	UNI	0.4A, 60V, 200 μ A, 0.75V	F-59	S1001MS2		 图 C-29
GB201, A	UNI	0.4A, 100V, 200 μ A, 0.75V	F-59	S1001MS2		
GB300, A	UNI	100A, 60V, 100 μ A, 0.75V	F-59	S1006MS2		 图 D-9
GB301, A	UNI	100A, 100V, 100 μ A, 0.75V	F-59	S1006MS2		
GFF1000B25		SCR-GC 400A, 2.5kV	C-29			 图 D-23
GFF200E12		SCR-GC 70A, 1.2kV	C-29			
GFP450A8		SCR-GC 200A, 800V	C-29			
GFP450B12		SCR-GC 200A, 1.2kV	C-29			
GFP600C16		SCR-GC 270A, 1.6kV	C-29			
GFT20A6		SCR-GC 16A, 600V, 0.1A	D-9			 图 G-1
GFT20B12		SCR-GC 7A, 1.2kV, 0.1A	D-9			
GFT50A6		SCR-GC 20A, 600V, 0.3A	D-9			
GFT50B12		SCR-GC 18A, 1.2kV, 0.3A	D-9			
GFT90A6		SCR-GC 42A, 600V	D-23			
GFT90B12		SCR-GC 30A, 1.2kV	D-23			

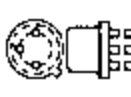
器件型号 Element type	厂名 Manufacturers	材料用途参数 Material Purpose Parameter	图号 Figure	国内外相似替换器件型号 Replace of similar type	备注 Notes	外形参考图 Reference shape
HI03SC	HUT	3A, 50V, 0.004A, 2.2V	B-51	L2003M3		 B-51
HI03SD	HUT	3A, 50V, 0.005A, 2.2V	B-51	L2003M5		
HI03SG	HUT	3A, 50V, 0.01A, 2.2V	B-51	L2003M7		
HI13SC	HUT	3A, 100V, 0.004A, 2.2V	B-51	L2003M3		
HI13SD	HUT	3A, 100V, 0.005A, 2.2V	B-51	L2003M5		
HI13SG	HUT	3A, 100V, 0.01A, 2.2V	B-51	L2003M7		
HI13SH	HUT	3A, 100V, 0.025A, 2.2V	B-51	L2003M9		
HI13SS	HUT	3A, 100V, 0.003A, 2.2V	B-51	L2003M3		
HI23SC	HUT	3A, 200V, 0.004A, 2.2V	B-51	L2003M3		
HI23SD	HUT	3A, 200V, 0.005A, 2.2V	B-51	L2003M5		
HI23SH	HUT	3A, 200V, 0.025A, 2.2V	B-51	L2003M9		
HI23SS	HUT	3A, 200V, 0.003A, 2.2V	B-51	L2003M3		
HI33SC	HUT	3A, 300V, 0.004A, 2.2V	B-51	L2003M3		
HI33SD	HUT	3A, 300V, 0.005A, 2.2V	B-51	L2003M5		
HI33SG	HUT	3A, 300V, 0.01A, 2.2V	B-51	L2003M7		
HI33SH	HUT	3A, 300V, 0.025A, 2.2V	B-51	L2003M9		
HI33SS	HUT	3A, 300V, 0.003A, 2.2V	B-51	L2003M3		
HI43SC	HUT	3A, 400V, 0.004A, 2.2V	B-51	L2003M3		
HI43SD	HUT	3A, 400V, 0.005A, 2.2V	B-51	L2003M5		
HI43SG	HUT	3A, 400V, 0.01A, 2.2V	B-51	L2003M7		
HI43SH	HUT	3A, 400V, 0.025A, 2.2V	B-51	L2003M9		
HI53SC	HUT	3A, 500V, 0.004A, 2.2V	B-51			
HI53SD	HUT	3A, 500V, 0.005A, 2.2V	B-51			
HI53SG	HUT	3A, 500V, 0.01A, 2.2V	B-51			

器件型号 Element type	厂名 Manufacturers	材料用途参数 Material Purpose Parameter	图号 Figure	国内外相似替换器件型号 Replace of similar type	备注 Notes	外形参考图 Reference shape
HI53SS	HUT	3A, 500V, 0.003A, 2.2V	B-51			 B-51
HI53SH	HUT	3A, 500V, 0.025A, 2.2V	B-51			
HI63SC	HUT	3A, 600V, 0.004A, 2.2V	B-51			
HI63SD	HUT	3A, 600V, 0.005A, 2.2V	B-51			
HI63SG	HUT	3A, 600V, 0.01A, 2.2V	B-51			
HI63SS	HUT	3A, 600V, 0.003A, 2.2V	B-51			
HI63SH	HUT	3A, 600V, 0.025A, 2.2V	B-51			
HS04	HUT	4A, 50V, 0.001A, 1V	B-51	S0503MS3		
HS04S	HUT	4A, 50V, 200 μ A, 0.8V	B-51	S0503MS2		
HS07	HUT	7A, 50V, 0.025A, 1.5V	B-51	S0508L		
HS034	HUT	4A, 30V, 0.001A, 1V	B-51			
HS034S	HUT	4A, 30V, 200 μ A, 0.8V	B-51			
HS14	HUT	4A, 100V, 0.001A, 1V	B-51	S1003MS3		
HS14S	HUT	4A, 100V, 200 μ A, 0.8V	B-51	S1003MS2, TAG615-1000		
HS24	HUT	4A, 200V, 0.001A, 1V	B-51	S2003MS3		
HS24S	HUT	4A, 200V, 200 μ A, 0.8V	B-51	S2003MS2, IAG615-200		
HS27	HUT	7A, 200V, 0.025A, 1.5V	B-51	S2008L		
HS34	HUT	4A, 30V, 0.001A, 1V	B-51	S4003MS3		
HS34S	HUT	4A, 30V, 200 μ A, 0.8V	B-51	S4003MS2		
HS37	HUT	7A, 300V, 0.025A, 1.5V	B-51	S4008L		
HS44	HUT	4A, 400V, 0.001A, 1V	B-51	S4003MS3		
HS44S	HUT	4A, 400V, 200 μ A, 0.8V	B-51	S4003MS2, TAG615-400		

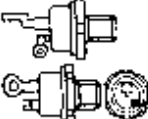

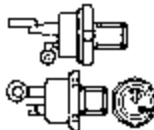

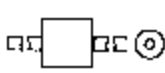
器件型号 Element type	厂名 Manufacturers	材料用途参数 Material Purpose Parameter	图号 Figure	国内外相似替换器件型号 Replace of similar type	备注 Notes	外形参考图 Reference shape
HS47	HUT	7A, 400V, 0.025A, 1.5V	B-51	S4008L		 B-51
HS54	HUT	4A, 500V, 0.001A, 1V	B-51			
HS54S	HUT	4A, 500V, 200 μ A, 0.8V	B-51			
HS57	HUT	7A, 500V, 0.025A, 1.5V	B-51	S6008L		
HS64	HUT	4A, 600V, 0.001A, 1V	B-51			
HS64S	HUT	4A, 600V, 200 μ A, 0.8V	B-51	TAG615-600		
HS67	HUT	7A, 600V, 0.025A, 1.5V	B-51	S6008L		
HSE700-RT	HSE	1.6A, 25V, 0.01A, 3V	B-51			
HSE701-RT	HSE	1.6A, 50V, 0.01A, 3V	B-51			
HSE702-RT	HSE	1.6A, 100V, 0.01A, 3V	B-51			
HSE703-RT	HSE	1.6A, 200V, 0.01A, 3V	B-51			
HSE704-RT	HSE	1.6A, 300V, 0.01A, 3V	B-51			
HSE705-RT	HSE	1.6A, 400V, 0.01A, 3V	B-51			
HSE706-RT	HSE	1.6A, 500V, 0.01A, 3V	B-51			
HSE707-RT	HSE	1.6A, 600V, 0.01A, 3V	B-51			
HSE5000-RT	HSE	7.6A, 25V, 0.02A, 3V	F-48			 F-48
HSE5001-RT	HSE	7.6A, 50V, 0.02A, 3V	F-48			
HSE5002-RT	HSE	7.6A, 100V, 0.02A, 3V	F-48			
HSE5003-RT	HSE	7.6A, 200V, 0.02A, 3V	F-48			
HSE5004-RT	HSE	7.6A, 300V, 0.02A, 3V	F-48			
HSE5005-RT	HSE	7.6A, 400V, 0.02A, 3V	F-48			
HSE5011-RT	HSE	16A, 100V, 0.04A, 3V	F-48			
HSE5012-RT	HSE	16A, 200V, 0.04A, 3V	F-48			
HSE5013-RT	HSE	16A, 300V, 0.04A, 3V	F-48			

器件型号 Element type	厂名 Manufacturers	材料用途参数 Material Purpose Parameter	图号 Figure	国内外相似替换器件型号 Reprace of similar type	备注 Notes	外形参考图 Reference shape
HSE5014-RT	HSE	16A, 400V, 0.04A, 3V	F-48			 图 F-48
HSE5050-RT	HSE	7A, 25V, 0.015A, 3V	F-47			 图 F-47
HSE5051-RT	HSE	7A, 50V, 0.015A, 3V	F-47			
HSE5052-RT	HSE	7A, 100V, 0.015A, 3V	F-47			
HSE5053-RT	HSE	7A, 150V, 0.015A, 3V	F-47			
HSE5054-RT	HSE	7A, 200V, 0.015A, 3V	F-47			
HSE5055-RT	HSE	7A, 250V, 0.015A, 3V	F-47			
HSE5056-RT	HSE	7A, 300V, 0.015A, 3V	F-47			
HSE5057-RT	HSE	7A, 400V, 0.015A, 3V	F-47			
HSE5058-RT	HSE	7A, 500V, 0.015A, 3V	F-47			
HSE5059-RT	HSE	7A, 600V, 0.015A, 3V	F-47			
HT06	HUT	6A, 50V, 0.05A, 2.5V	B-51	Q2006L4		 B-51
HT16	HUT	6A, 100V, 0.05A, 2.5V	B-51	Q2006L4		
HT26	TCE	6A, 200V, 0.05A, 2.5V	B-51	Q2006L4		
HT32	TCE	DAC 1.5A, 3V, 27V, 5V	A-5			
HT35	HUT	DAC 1.5A, 3V, 30V, 5V	A-5			
HT36	TCE	DAC 6A, 300V, 0.05A, 2.5V	B-51	Q4006L4		
HT40	HUI	DAC 1.5A, 3V, 35V, 5V	A-5			
HT50	HUT	DAC 1.5A, 4V, 42V, 8V	A-5			
HT56	TCT	DAC 6A, 500V, 0.05A, 2.5V	B-51	Q5006L4		
HT60	HUT	DAC 1.5A, 4V, 56V, 10V	A-5			
HT66	TCE	DAC 6A, 600V, 0.05A, 2.5V	B-51	Q6006L4		 图 A-5
HT105	TCE	DAC 0.6A, 10V, 95V, 25V	A-5			
HT110	TCE	DAC 0.6A, 10V, 104V, 25V	A-5			
HT120	TCE	DAC 0.6A, 10V, 110V, 25V	A-5			
HT130	TCE	DAC 0.6A, 10V, 120V, 25V	A-5			

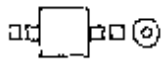

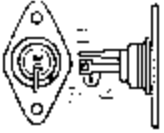
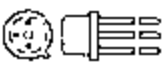



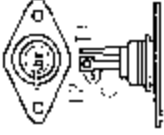
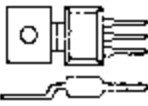

器件型号 Component type	厂名 Manufacturers	材料 Material	用途 Purpose	参数 Parameter	图号 Figure	国内外相似替换器件型号 Replace of similar type	备注 Notes	外形参考图 Reference shape
HT200	TCE	DAC	0.34A, 20V, 190V, 50V	A-5				 图 A-5
HT220	TCE	DAC	0.34A, 20V, 205V, 50V	A-5				
HT240	TCE	DAC	0.34A, 20V, 220V, 50V	A-5				

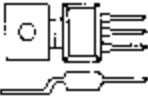
器件型号 Element type	厂名 Manufacturers	材料用途参数 Material Purpose Parameter	图号 Figure	国内外相似替换器件型号 Replace of similar type	备注 Notes	外形参考图 Reference snape	
I3PS035	HUT	35A, 50V, 0.025A, 1.5V	D-29			 图 D-29	
I3PS135	HUT	35A, 100V, 0.025A, 1.5V	D-29				
I3PS235	HUT	35A, 200V, 0.025A, 1.5V	D-29				
I3PS335	HUT	35A, 300V, 0.025A, 1.5V	D-29				
I3PS435	HUT	35A, 400V, 0.025A, 1.5V	D-29				
I3PS535	HUT	35A, 500V, 0.025A, 1.5V	D-29				
I3PS635	HUT	35A, 600V, 0.025A, 1.5V	D-29				
ID100	UNI	0.5A, 30V, 200 μ A, 0.8V	B-65	EC103Y, ECG5400, TAG06Y			 图 B-65
ID101	UNI	0.5A, 60V, 200 μ A, 0.8V	B-65	ECG5401, SK3638, SK5402			
ID102	UNI	0.5A, 100V, 200 μ A, 0.8V	B-65	EC103A, ECG5402, TAG06A			
ID103	UNI	0.5A, 150V, 200 μ A, 0.8V	B-65	ECG5404, SK3627, SK5404			
ID104	UNI	0.5A, 200V, 200 μ A, 0.8V	B-65	EC103B, ECG5404, TAG06B			
ID105	UNI	0.5A, 300V, 200 μ A, 0.8V	B-65	ECG5405, SK3951, SK5405, TAG06C			
ID106	UNI	0.5A, 400V, 200 μ A, 0.8V	B-65	ECG5405, SK3951, SK5408, TAG06D			
ID200	UNI	1.6A, 50V, 200 μ A, 0.8V	B-51			 图 B-51	
ID201	UNI	1.6A, 100V, 200 μ A, 0.8V	B-51				
ID202	UNI	1.6A, 150V, 200 μ A, 0.8V	B-51				
ID203	UNI	1.6A, 200V, 200 μ A, 0.8V	B-51				
ID300	UNI	1.6A, 300V, 200 μ A, 0.8V	B-51				
ID301	UNI	1.6A, 400V, 200 μ A, 0.8V	B-51				
IP100	SCR-H	0.8A, 30V, 200 μ A	B-35	BR103, BRX44, BRX45, BRX50, TAG60Y, TAG62Y		 图 B-35	
IP101	SCR-H	0.8A, 60V, 200 μ A	B-35	BRX46, BRX47, BRX51, BRX52, TAG60A, TAG62A			
IP102	SCR-H	0.8A, 100V, 200 μ A	B-35	BRX46, BRX47, BRX51, BRX52, TAG60A, TAG62A			
IP103	SCR-H	0.8A, 150V, 200 μ A	B-35	BRX47, BRX48, BRX49, BRX52, BRX53, BRX54			
IP104	SCR-H	0.8A, 200V, 200 μ A	B-35	BRX47, BRX48, BRX49, BRX52, BRX53, BRX54			
IP105	SCR-H	0.8A, 300V, 200 μ A	B-35	BRX48, BRX49, BRX53, BRX54, BRX55, BRX56			

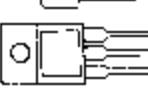



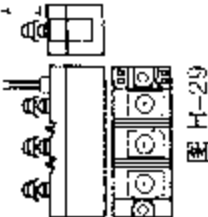
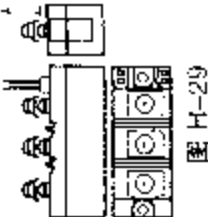
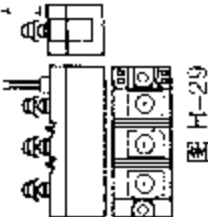
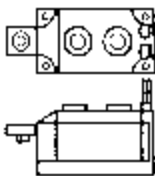
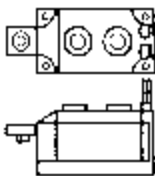
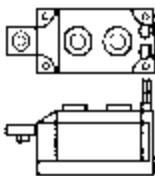

器件型号 Element type	厂名 Manufacturers	材料用途参数 Material Purpose Parameter	图号 Figure	国内外相似替换器件型号 Replace of's similar type	备注 Notes	外形参考图 Reference shape
IP106	SCR-H	0.8A, 400V, 200 μ A	B-35	BRX49, BRX54, BRX55, BRX56		 图 B 35
IPS035	HUT	35A, 50V, 0.025A, 1.5V	D-29	S0535		
IPS135	HUT	35A, 100V, 0.025A, 1.5V	D-29	S1535		
IPS235	HUT	35A, 200V, 0.025A, 1.5V	D-29	S2535		
IPS335	HUT	35A, 300V, 0.025A, 1.5V	D-29	S3535		
IPS435	HUT	35A, 400V, 0.025A, 1.5V	D-29	S4535		
IPS535	HUT	35A, 500V, 0.025A, 1.5V	D-29	S5535		
IPS635	HUT	35A, 600V, 0.025A, 1.5V	D-29	S6535		
IPT030	HUT	30A, 50V, 0.1A, 2.5V	D-29			
IPT040	HUT	40A, 50V, 0.1A, 2.5V	D-29	Q2040		
IPT130	HUT	30A, 100V, 0.1A, 2.5V	D-29			
IPT140	HUT	40A, 100V, 0.1A, 2.5V	D-29	Q2040		 图 D 29
IPT230	HUT	30A, 200V, 0.1A, 2.5V	D-29			
IPT240	HUT	40A, 200V, 0.1A, 2.5V	D-29	Q2040		
IPT330	HUT	30A, 300V, 0.1A, 2.5V	D-29			
IPT340	HUT	40A, 300V, 0.1A, 2.5V	D-29	Q4040		
IPT430	HUT	30A, 400V, 0.1A, 2.5V	D-29			
IPT440	HUT	40A, 400V, 0.1A, 2.5V	D-29	Q4040		
IPT530	HUT	30A, 500V, 0.1A, 2.5V	D-29			
IPT540	HUT	40A, 500V, 0.1A, 2.5V	D-29	Q5040		
IPT630	HUT	30A, 600V, 0.1A, 2.5V	D-29			
IPT640	HUT	40A, 600V, 0.1A, 2.5V	D-29	Q6040		 图 B-21
IR106A	SST	4A, 100V, 0.2A, 0.8V	B-21	ECG5454, SK6754, SK5454, T106A1		
IR106B	SST	4A, 200V, 0.2A, 0.8V	B-21			
IR106C	SST	4A, 300V, 0.2A, 0.8V	B-21			
IR106D	SST	4A, 400V, 0.2A, 0.8V	B-21			

器件型号 Element type	厂名 Manufacturers	材料用途参数 Material Purpose Parameter	图号 Figure	国内外相似替换器件型号 Replace of similar type	备注 Notes	外形参考图 Reference shape
IR106F	SST	4A, 50V, 0.2A, 0.8V	B-21			 图 B-21
IR106Q	SST	4A, 15V, 0.2A, 0.8V	B-21			
IR106Y	SST	4A, 20V, 0.2A, 0.8V	B-21			
IR122A1, A2	INR	8A, 100V, 0.025A, 1.5V	B-91	ECG5462		 图 B-91
IR122A3, A4, A5, A6	INR	8A, 100V, 0.025A, 1.5V	B-10			
IR122B1, B2	INR	8A, 200V, 0.025A, 1.5V	B-91	ECG5463		 图 B-91
IR122B3, B4, B5, B6	INR	8A, 200V, 0.025A, 1.5V	B-10			
IR122C1, C2	INR	8A, 300V, 0.025A, 1.5V	B-91	ECG5465		 图 B-91
IR122C3, C4, C5, C6	INR	8A, 300V, 0.025A, 1.5V	B-10			
IR122D1, D2	INR	8A, 400V, 0.025A, 1.5V	B-91	ECG5465		 图 B-91
IR122D3, D4, D5, D6	INR	8A, 400V, 0.025A, 1.5V	B-10			
IR122E1, E2	INR	8A, 500V, 0.025A, 1.5V	B-91	ECG5466		 图 B-91
IR122E3, E4, E5, E6	INR	8A, 500V, 0.025A, 1.5V	B-10			
IR122F1, F2	INR	8A, 50V, 0.025A, 1.5V	B-91	ECG5461		 图 B-91
IR122F3, F4, F5, F6	INR	8A, 50V, 0.025A, 1.5V	B-10			
IR122M1, M2	INR	8A, 600V, 0.025A, 1.5V	B-91	ECG5466		 图 H-29
IR122M3, M4, M5, M6	INR	8A, 600V, 0.025A, 1.5V	B-10			
IRKH26-04S90	INR	25A, 400V, 0.1A, 2.5V	H-29			 图 H-29
IRKH26-06S90	INR	25A, 600V, 0.1A, 2.5V	H-29			

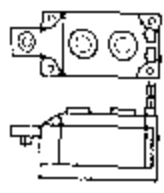
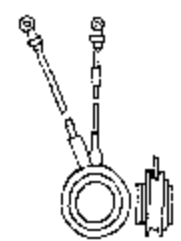

器件型号 Element type	厂名 Manufacturers	材料用途参数 Material Purpose Parameter	图号 Figure	国内外相似替换器件型号 Replace of similar type	备注 Notes	外形参考图 Reference shape
IRKH26-08S90	INR	SCA 25A, 800V, 0.1A, 2.5V				
IRKH26-10S90	INR	SCA 25A, 1kV, 0.1A, 2.5V				
IRKH26-12S90	INR	SCA 25A, 1.2kV, 0.1A, 2.5V	H-29			
IRKH41-04S90	INR	SCA 40A, 400V, 0.1A, 2.5V	H-29			
IRKH41-06S90	INR	SCA 40A, 600V, 0.1A, 2.5V	H-29			
IRKH41-08S90	INR	SCA 40A, 800V, 0.1A, 2.5V	H-29			
IRKH41-12S90	INR	SCA 40A, 1.2kV, 0.1A, 2.5V	H-29			
IRKH56-06S90	INR	SCA 55A, 600V, 0.1A, 2.5V	H-29			
IRKH56-07S90	INR	SCA 55A, 400V, 0.1A, 2.5V	H-29			
IRKH56-08S90	INR	SCA 55A, 800V, 0.1A, 2.5V	H-29			
IRKH56-10S90	INR	SCA 55A, 1kV, 0.1A, 2.5V	H-29			
IRKH71-04S90	INR	SCA 70A, 400V, 0.12A, 2.5V	H-29			
IRKH71-06S90	INR	SCA 70A, 600V, 0.12A, 2.5V	H-29			
IRKH71-08S90	INR	SCA 70A, 800V, 0.12A, 2.5V	H-29			
IRKH71-10S90	INR	SCA 70A, 1kV, 0.12A, 2.5V	H-29			
IRKH71-12S90	INR	SCA 70A, 1.2kV, 0.12A, 2.5V	H-29			
IRKH91-04S90	INR	SCA 90A, 400V, 0.12A, 2.5V	H-29			
IRKH91-06S90	INR	SCA 90A, 600V, 0.12A, 2.5V	H-29			
IRKH91-08S90	INR	SCA 90A, 800V, 0.12A, 2.5V	H-29			
IRKH91-10S90	INR	SCA 90A, 1kV, 0.12A, 2.5V	H-29			
IRKH91-12S90	INR	SCA 90A, 1.2kV, 0.12A, 2.5V	H-29			
IRKH130-04	INR	SCA 143A, 400V, 0.15A, 2.5V	H-30			
IRKH130-08	INR	SCA 143A, 800V, 0.15A, 2.5V	H-30			
IRKH130-10	INR	SCA 143A, 1kV, 0.15A, 2.5V	H-30			

器件型号 Element type	厂名 Manufacturers	材料用途参数 Material Purpose Parameter	图号 Figure	国内外相似替换器件型号 Replace of similar type	备注 Notes	外形参考图 Reference snace
IRKH130-12	INR	SCA 143A, 1.2kV, 0.15A, 2.5V	H-30			
IRKH130-16	INR	SCA 143A, 1.6kV, 0.15A, 2.5V	H-30			
IRKH160-04	INR	SCA 160A, 400V, 0.15A, 2.5V	H-30			
IRKH160-08	INR	SCA 160A, 800V, 0.15A, 2.5V	H-30			
IRKH160-10	INR	SCA 160A, 1kV, 0.15A, 2.5V	H-30			
IRKH160-12	INR	SCA 160A, 1.2kV, 0.15A, 2.5V	H-30			
IRKH160-16	INR	SCA 160A, 1.6kV, 0.15A, 2.5V	H-30			
IRKH180-04	INR	SCA 180A, 400V, 0.15A, 2.5V	H-30			
IRKH180-06	INR	SCA 180A, 600V, 0.15A, 2.5V	H-30			
IRKH180-08	INR	SCA 180A, 800V, 0.15A, 2.5V	H-30			
IRKH180-10	INR	SCA 180A, 1kV, 0.15A, 2.5V	H-30			
IRKH180-12	INR	SCA 180A, 1.2kV, 0.15A, 2.5V	H-30			
IRKH180-16	INR	SCA 180A, 1.6kV, 0.15A, 2.5V	H-30			
IRKH210-04	INR	SCA 210A, 400V, 0.15A, 2.5V	H-30			
IRKH210-06	INR	SCA 210A, 600V, 0.15A, 2.5V	H-30			
IRKH210-08	INR	SCA 210A, 800V, 0.15A, 2.5V	H-30			
IRKH210-10	INR	SCA 210A, 1kV, 0.15A, 2.5V	H-30			
IRKH210-12	INR	SCA 210A, 1.2kV, 0.15A, 2.5V	H-30			
IRKH210-14	INR	SCA 210A, 1.4kV, 0.15A, 2.5V	H-30			
IRKH210-16	INR	SCA 210A, 1.6kV, 0.15A, 2.5V	C-32			
IRKH13614D20	MOD-D	135A, 1.4kV, 2kV	G-21			
IRKH13616D25	MOD-D	135A, 1.6kV, 2.5kV	G-21			
IRKH14214D20	MOD-D	140A, 1.4kV, 2kV	G-21			
IRKH14216D25	MOD-D	140A, 1.6kV, 2.5kV	G-21			
IRKH14218D28	MOD-D	140A, 1.8kV, 2.8kV	G-21			

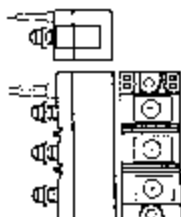

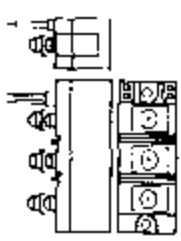
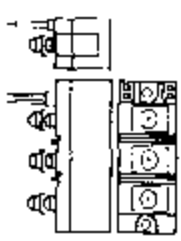
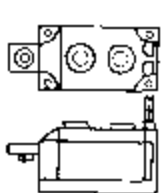
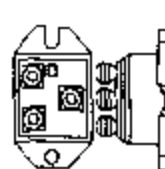
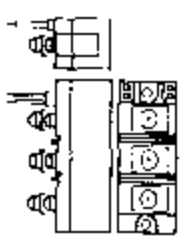

器件型号 Element type	厂名 Manufacturers	材料用途参数 Material Purpose Parameter	图号 Figure	国内外相似替换器件型号 Replace of similar type	备注 Notes	外形参考图 Reference shape	
IRKH14220D32	MOD-D	140A, 2kV, 3.2kV	G-21			 图 G-21	
IRKH16214D20	MOD-D	160A, 1.4kV, 2kV	G-21				
IRKH16216D25	MOD-D	160A, 1.6kV, 2.5kV	G-21				
IRKH17014D20	MOD-D	170A, 1.4kV, 2kV					
IRKH17016D25	MOD-D	170A, 1.6kV, 2.5kV					
IRKH23014D20	MOD-D	230A, 1.4kV, 2kV					
IRKH23016D25	MOD-D	230A, 1.6kV, 2.5kV					
IRKH23018D28	MOD-D	230A, 1.8kV, 2.8kV					
IRKH23020D32	MOD-D	230A, 2kV, 3.2kV					
IRKH25014D20	MOD-D	250A, 1.4kV, 2kV					
IRKH25016D25	MOD-D	250A, 1.6kV, 2.5kV					
IRKL26-06S90	INR	SCA 25A, 600V, 0.1A, 2.5V					 图 H-29
IRKL26-08S90	INR	SCA 25A, 800V, 0.1A, 2.5V	H-29				
IRKL26-10S90	INR	SCA 25A, 1kV, 0.1A, 2.5V					
IRKL26-12S90	INR	SCA 25A, 1.2kV, 0.1A, 2.5V	H-29				
IRKL41-04S90	INR	SCA 40A, 400V, 0.1A, 2.5V	H-29				
IRKL41-06S90	INR	SCA 40A, 600V, 0.1A, 2.5V	H-29				
IRKL41-08S90	INR	SCA 40A, 800V, 0.1A, 2.5V	H-29				
IRKL41-10S90	INR	SCA 40A, 1kV, 0.1A, 2.5V	H-29				
IRKL41-12S90	INR	SCA 40A, 1.2kV, 0.1A, 2.5V	H-29				
IRKL56-04S90	INR	SCA 55A, 400V, 0.1A, 2.5V	H-29				
IRKL56-06S90	INR	SCA 55A, 600V, 0.1A, 2.5V	H-29				
IRKL56-08S90	INR	SCA 55A, 800V, 0.1A, 2.5V	H-29				
IRKL56-10S90	INR	SCA 55A, 1kV, 0.1A, 2.5V	H-29				
IRKL56-12S90	INR	SCA 55A, 1.2kV, 0.1A, 2.5V	H-29				

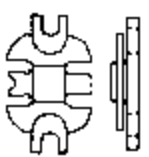
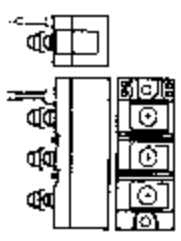

器件型号 Element type	厂名 Manufacturers	材料用途参数 Material Purpose Parameter	图号 Figure	国内外相似替换器件型号 Replace of similar type	备注 Notes	外形参考图 Reference shacc
IRKL71-04S90	INR	SCA 70A, 400V, 0.12A, 2.5V	H-29			 图 H-29
IRKL71-06S90	INR	SCA 70A, 600V, 0.12A, 2.5V	H-29			
IRKL71-08S90	INR	SCA 70A, 800V, 0.12A, 2.5V	H-29			
IRKL71-10S90	INR	SCA 70A, 1kV, 0.12A, 2.5V	H-29			
IRKL71-12S90	INR	SCA 70A, 1.2kV, 0.12A, 2.5V	H-29			
IRKL91-04S90	INR	SCA 90A, 400V, 0.1A, 2.5V	H-29			 图 H-29
IRKL91-06S90	INR	SCA 90A, 600V, 0.1A, 2.5V	H-29			
IRKL91-08S90	INR	SCA 90A, 800V, 0.1A, 2.5V	H-29			
IRKL91-10S90	INR	SCA 90A, 1kV, 0.1A, 2.5V	H-29			
IRKL91-12S90	INR	SCA 90A, 1.2kV, 0.1A, 2.5V	H-29			
IRKL130-04	INR	SCA 143A, 400V, 0.15A, 2.5V	H-30			 图 H-30
IRKL130-06	INR	SCA 143A, 600V, 0.15A, 2.5V	H-16			
IRKL130-08	INR	SCA 143A, 800V, 0.15A, 2.5V	H-30			
IRKL130-10	INR	SCA 143A, 1kV, 0.15A, 2.5V	H-30			
IRKL130-12	INR	SCA 143A, 1.2kV, 0.15A, 2.5V	H-30			
IRKL130-14	INR	SCA 143A, 1.4kV, 0.15A, 2.5V	H-30			 图 H-16
IRKL130-16	INR	SCA 143A, 1.6kV, 0.15A, 2.5V	H-30			
IRKL160-04	INR	SCA 160A, 400V, 0.15A, 2.5V	H-30			
IRKL160-06	INR	SCA 160A, 600V, 0.15A, 2.5V	H-30			
IRKL160-08	INR	SCA 160A, 800V, 0.15A, 2.5V	H-30			
IRKL160-10	INR	SCA 160A, 1kV, 0.15A, 2.5V	H-30			 图 H-30
IRKL160-12	INR	SCA 160A, 1.2kV, 0.15A, 2.5V	H-30			
IRKL160-14	INR	SCA 160A, 1.4kV, 0.15A, 2.5V	H-30			
IRKL160-16	INR	SCA 160A, 1.6kV, 0.15A, 2.5V	H-30			
IRKL180-04	INR	SCA 180A, 400V, 0.15A, 2.5V	H-30			



器件型号 Element type	厂名 Manufacturers	材料用途参数 Material Purpose Parameter	图号 Figure	国内外相似替换器件型号 Replace of similar type	备注 Notes	外形参考图 Reference snape	
IRKL23016D25		MOD-D 250A, 1.6kV, 2.5kV					
IRKL23018D28		MOD-D 230A, 1.8kV, 2.8kV					
IRKL23020D32		MOD-D 230A, 2kV, 3.2kV					
IRKL25014D20		MOD-D 250A, 1.4kV, 2kV					
IRKT26-04		MOD 25A, 400V	G-22			 <p>图 G-22</p>	
IRKT26-04S90	INR	SCA 25A, 400V, 0.1A, 2.5V	H-29				
IRKT26-06		MOD 25A, 600V	G-22				
IRKT26-06S90	INR	SCA 25A, 600V, 0.1A, 2.5V					
IRKT26-08		MOD 25A, 800V	G-22				
IRKT26-08S90	INR	SCA 25A, 800V, 0.1A, 2.5V					
IRKT26-10		MOD 25A, 1kV	G-22				
IRKT26-10S90	INR	SCA 25A, 1kV, 0.1A, 2.5V	H-29				
IRKT26-12		MOD 25A, 1.2kV	G-22				
IRKT26-12S90	INR	SCA 25A, 1.2kV, 0.1A, 2.5V	H-29				
IRKT26-14		MOD 25A, 1.4kV	G-22				
IRKT26-16		MOD 25A, 1.6kV	G-22				
IRKT41-04		MOD 40A, 400V	G-22				 <p>图 H-29</p>
IRKT41-04S90	INR	SCA 40A, 400V, 0.1A, 2.5V					
IRKT41-06		MOD 40A, 600V	G-22				
IRKT41-06S90	INR	SCA 40A, 600V, 0.1A, 2.5V	H-29				
IRKT41-08		MOD 40A, 800V	G-22				
IRKT41-08S90	INR	SCA 40A, 800V, 0.1A, 2.5V	H-29				
IRKT41-10		MOD 40A, 1kV	G-22				
IRKT41-10S90	INR	SCA 40A, 1kV, 0.1A, 2.5V	H-29				
IRKT41-12		MOD 40A, 1.2kV	G-22				
IRKT41-12S90	INR	SCA 40A, 1.2kV, 0.1A, 2.5V	H-29				

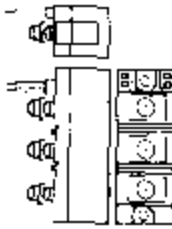

器件型号 Element type	厂名 Manufacturers	材料用途参数 Material Purpose Parameter	图号 Figure	国内外相似替换器件型号 Replace of similar type	备注 Notes	外形参考图 Reference shape
IRKT41-14	MOD	40A, 1.4kV	G-22			  图 G-22
IRKT41-16	MOD	40A, 1.6kV	G-22			
IRKT41-18	MOD	40A, 1.8kV	G-22			
IRKT56-04	MOD	55A, 400V	G-22			
IRKT56-04S90	INR	55A, 400V, 0.1A, 2.5V	H-29			
IRKT56-06	MOD	55A, 600V	G-22			
IRKT56-06S90	INR	55A, 600V, 0.1A, 2.5V	H-29			
IRKT56-08	MOD	55A, 800V	G-22			
IRKT56-08S90	INR	55A, 800V, 0.1A, 2.5V	H-29			
IRKT56-10	MOD	55A, 1kV	G-22			
IRKT56-10S90	INR	55A, 1kV, 0.1A, 2.5V	H-29			
IRKT56-12	MOD	55A, 1.2kV	G-22			
IRKT56-12S90	INR	55A, 1.2kV, 0.1A, 2.5V	H-29			
IRKT56-14	MOD	55A, 1.4kV	G-22			
IRKT56-16	MOD	55A, 1.6kV	G-22			
IRKT56-18	MOD	55A, 1.8kV	G-22			
IRKT71-04	MOD	70A, 400V	G-22			  图 H-29
IRKT71-04S90	INR	70A, 400V, 0.12A, 2.5V	H-29			
IRKT71-06	MOD	70A, 600V	G-22			
IRKT71-06S90	INR	70A, 600V, 0.12A, 2.5V	H-29			
IRKT71-08	MOD	70A, 800V	G-22			
IRKT71-08S90	INR	70A, 800V, 0.12A, 2.5V	H-29			
IRKT71-10	MOD	70A, 1kV	G-22			
IRKT71-10S90	INR	70A, 1kV, 0.12A, 2.5V	H-29			
IRKT71-12	MOD	70A, 1.2kV	G-22			
IRKT71-12S90	INR	70A, 1.2kV, 0.12A, 2.5V	H-29			
IRKT71-14	MOD	70A, 1.4kV	G-22			

器件型号 Element type	厂名 Manufacturers	材料用途参数 Material Purpose Parameter	图号 Figure	国内外相似替换器件型号 Replace of similar type	备注 Notes	外形参考图 Reference shape
IRKT71-16	MOD	70A, 1.6kV	G-22			  图 G-22
IRKT71-18	MOD	70A, 1.8kV	G-22			
IRKT91-04	MOD	90A, 400V	G-22			 图 H-29
IRKT91-04S90	INR	SCA 90A, 400V, 0.1A, 2.5V	G-22			
IRKT91-06	MOD	90A, 600V	G-22			
IRKT91-06S90	INR	SCA 90A, 600V, 0.1A, 2.5V	H-29			
IRKT91-08	MOD	90A, 800V	G-22			
IRKT91-08S90	INR	SCA 90A, 800V, 0.1A, 2.5V	H-29			
IRKT91-10	MOD	90A, 1kV	G-22			
IRKT91-10S90	INR	SCA 90A, 1kV, 0.1A, 2.5V	H-29			
IRKT91-12	MOD	90A, 1.2kV	G-22			
IRKT91-12S90	INR	SCA 90A, 1.2kV, 0.1A, 2.5V	H-29			
IRKT91-14	MOD	90A, 1.4kV	G-22			
IRKT91-16	MOD	90A, 1.6kV	G-22			
IRKT91-18	MOD	90A, 1.8kV	G-22			
IRKT130-04	INR	SCA 143A, 400V, 0.15A, 2.5V	H-30			
IRKT130-06	INR	SCA 143A, 600V, 0.15A, 2.5V	H-30			
IRKT130-08	INR	SCA 143A, 800V, 0.15A, 2.5V	H-30			
IRKT130-10	INR	SCA 143A, 1kV, 0.15A, 2.5V	H-30			
IRKT130-12	INR	SCA 143A, 1.2kV, 0.15A, 2.5V	H-30			
IRKT130-14	INR	SCA 143A, 1.4kV, 0.15A, 2.5V	H-30			
IRKT130-16	INR	SCA 143A, 1.6kV, 0.15A, 2.5V	H-30			
IRKT136-04	MOD	135A, 400V	G-21			
IRKT136-06	MOD	135A, 600V	G-21			
IRKT136-08	MOD	135A, 800V	G-21			
IRKT136-10	MOD	135A, 1kV	G-21			



器件型号 Element type	厂名 Manufacturers	材料用途参数 Material Purpose Parameter	图号 Figure	国内外相似替换器型号 Replace of similar type	备注 Notes	外形参考图 Reference shape
IRKT136-12	MOD	135A, 1.2KV	G-21			
IRKT136-14	MOD	135A, 1.4KV	G-21			
IRKT136-15	MOD	135A, 1.6KV	G-21			
IRKT142-04	MOD	140A, 400V	G-21			
IRKT142-06	MOD	140A, 600V	G-21			
IRKT142-08	MOD	140A, 800V	G-21			
IRKT142-10	MOD	140A, 1KV	G-21			
IRKT142-12	MOD	140A, 1.2KV	G-21			
IRKT142-16	MOD	140A, 1.6KV	G-21			
IRKT142-18	MOD	140A, 1.8KV	G-21			
IRKT142-20	MOD	140A, 2KV	G-21			
IRKT160-04	INR	SCA 160A, 400V, 0.15A, 2.5V	H-30			
IRKT160-06	INR	SCA 160A, 600V, 0.15A, 2.5V	H-30			
IRKT160-08	INR	SCA 160A, 800V, 0.15A, 2.5V	H-30			
IRKT160-12	INR	SCA 160A, 1.2KV, 0.15A, 2.5V	H-30			
IRKT160-14	INR	SCA 160A, 1.4KV, 0.15A, 2.5V	H-30			
IRKT160-16	INR	SCA 160A, 1.6KV, 0.15A, 2.5V	H-30			
IRKT162-04	MOD	160A, 400V	G-21			
IRKT162-06	MOD	160A, 600V	G-21			
IRKT162-08	MOD	160A, 800V	G-21			
IRKT162-10	MOD	160A, 1KV	G-21			
IRKT162-12	MOD	160A, 1.2KV	G-21			
IRKT162-16	MOD	160A, 1.6KV	G-21			
IRKT170-04	MOD	170A, 400V				
IRKT170-06	MOD	170A, 600V				

图 G-21

图 H-30

器件型号 Element type	厂名 Manufacturers	材料用途参数 Material Purpose Parameter	图号 Figure	国内外相似替换器件型号 Replace of similar type	备注 Notes	外形参考图 Reference shape
IRKT170-08	MOD	170A, 800V				
IRKT170-10	MOD	170A, 1kV				
IRKT170-12	MOD	170A, 1.2kV				
IRKT170-14	MOD	170A, 1.4kV				
IRKT170-16	MOD	170A, 1.6kV				
IRKT180-04	INR	SCA 180A, 400V, 0.15A, 2.5V	H-30			 图 H-30
IRKT180-06	INR	SCA 180A, 600V, 0.15A, 2.5V	H-30			
IRKT180-08	INR	SCA 180A, 800V, 0.15A, 2.5V	H-30			
IRKT180-10	INR	SCA 180A, 1kV, 0.15A, 2.5V	H-30			
IRKT180-12	INR	SCA 180A, 1.2kV, 0.15A, 2.5V	H-30			
IRKT180-14	INR	SCA 180A, 1.4kV, 0.15A, 2.5V	H-30			
IRKT180-16	INR	SCA 180A, 1.6kV, 0.15A, 2.5V	H-30			
IRKT210-04	INR	SCA 210A, 400V, 0.15A, 2.5V	H-30			 图 H-30
IRKT210-06	INR	SCA 210A, 600V, 0.15A, 2.5V	H-30			
IRKT210-08	INR	SCA 210A, 800V, 0.15A, 2.5V	H-30			
IRKT210-10	INR	SCA 210A, 1kV, 0.15A, 2.5V	H-30			
IRKT210-12	INR	SCA 210A, 1.2kV, 0.15A, 2.5V	H-30			
IRKT210-14	INR	SCA 210A, 1.4kV, 0.15A, 2.5V	H-30			
IRKT210-16	INR	SCA 210A, 1.6kV, 0.15A, 2.5V	C-32			
IRKT230-04	MOD	230A, 400V				 图 C-32
IRKT230-06	MOD	230A, 600V				
IRKT230-08	MOD	230A, 800V				
IRKT230-10	MOD	230A, 1kV				
IRKT230-12	MOD	230A, 1.2kV				
IRKT230-16	MOD	230A, 1.6kV				
IRKT230-18	MOD	230A, 1.8kV				

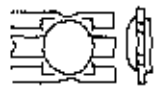
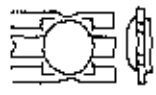
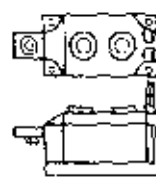
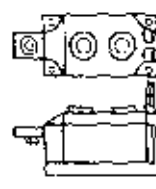
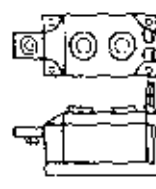
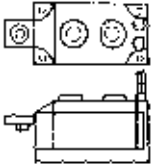
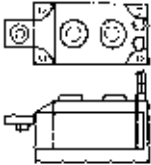
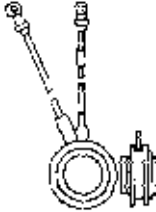

器件型号 Element type	厂名 Manufacturers	材料用途参数 Material Purpose Parameter	图号 Figure	国内外相似替换器件型号 Replace of similar type	备注 Notes	外形参考图 Reference shape
IRKT230-20	MOD	230A, 2KV				
IRKT250-04	MOD	250A, 400V				
IRKT250-08	MOD	250A, 800V				
IRKT250-10	MOD	250A, 1KV				
IRKT250-12	MOD	250A, 1.2KV				
IRKT250 14	MOD	250A, 1.4KV				
IRKT250-16	MOD	250A, 1.6KV				
IRKTF72-06	MOD	71A, 600V	G-21			
IRKTF72-08	MOD	71A, 800V	G-21			
IRKTF72-10	MOD	71A, 1KV	G-21			
IRKTF72-12	MOD	71A, 1.2KV	G-21			
IRKTF82-02	MOD	81A, 200V	G-21			
IRKTF82-04	MOD	81A, 400V	G-21			
IRKTF82-06	MOD	81A, 600V	G-21			
IRKTF82-08	MOD	81A, 800V	G-21			
IRKTF102-06	MOD	105A, 600V	G-21			
IRKTF102-08	MOD	105A, 800V	G-21			
IRKTF102-10	MOD	105A, 1KV	G-21			
IRKTF102-12	MOD	105A, 1.2KV	G-21			
IRKTF112-02	MOD	112A, 200V	G-21			
IRKTF112-04	MOD	112A, 400V	G-21			
IRKTF112-06	MOD	112A, 600V	G-21			
IRKTF112-08	MOD	112A, 800V	G-21			



图 G-21

器件型号 Element type	厂名 Manufacturers	材料用途 Material Purpose	参数 Parameter	图号 Figure	国内外相似替换器件型号 Replace of similar type	备注 Notes	外形参考图 Reference shape
IRKTF132-02	MOD	130A, 200V		G-21			
IRKTF132-04	MOD	130A, 400V		G-21			
IRKTF132-06	MOD	130A, 600V		G-21			
IRKTF132-08	MOD	130A, 800V		G-21			
IRKTF152-02	MOD	150A, 200V		G-21			
IRKTF152-04	MOD	150A, 400V		G-21			
IRKTF152-06	MOD	150A, 600V		G-21			
IRKTF152-08	MOD	150A, 800V		G-21			
IRKTF180-02	MOD	180A, 200V					
IRKTF180-04	MOD	180A, 400V					
IRKTF180-06	MOD	180A, 600V					
IRKTF180-08	MOD	180A, 800V					
IRKTF180-10	MOD	180A, 1kV					
IRKTF180-12	MOD	180A, 1.2kV					
IRKTF200-02	MOD	200A, 200V					
IRKTF200-04	MOD	200A, 400V					
IRKTF200-06	MOD	200A, 600V					
IRKTF200-08	MOD	200A, 800V					
IRKTF200-10	MOD	200A, 1kV					
IRKTF200-12	MOD	200A, 1.2kV					
IRKU136-04	MOD	135A, 400V		G-21			
IRKU136-06	MOD	135A, 600V		G-21			
IRKU136-08	MOD	135A, 800V		G-21			
IRKU136-10	MOD	135A, 1kV		G-21			
IRKU136-12	MOD	135A, 1.2kV		G-21			



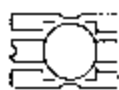
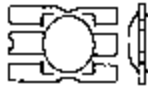
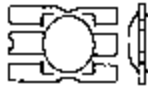
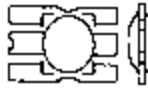
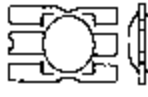
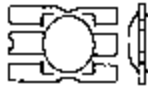
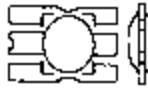

图 G-21

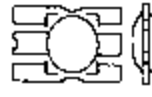

器件型号 Element type	厂名 Manufacturers	材料用途参数 Material Purpose Parameter	图号 Figure	国内外相似替换器件型号 Replace of similar type	备注 Notes	外形参考图 Reference shape
IRKU136-14	MOD	135A, 1.4kV	G-21			 图 G-21
IRKU136-16	MOD	135A, 1.6kV	G-21			
IRKU142-04	MOD	140A, 400V	G-21			
IRKU142-06	MOD	140A, 600V	G-21			
IRKU142-08	MOD	140A, 800V	G-21			
IRKU142-10	MOD	140A, 1kV	G-21			
IRKU142-12	MOD	140A, 1.2kV	G-21			
IRKU142-16	MOD	140A, 1.6kV	G-21			
IRKU142-18	MOD	140A, 1.8kV	G-21			
IRKU142-20	MOD	140A, 2kV	G-21			
IRKU162-04	MOD	160A, 400V	G-21			
IRKU162-06	MOD	160A, 600V	G-21			
IRKU162-08	MOD	160A, 800V	G-21			
IRKU162-10	MOD	160A, 1kV	G-21			
IRKU162-12	MOD	160A, 1.2kV	G-21			
IRKU162-16	MOD	160A, 1.6kV	G-21			
IRKU170-04	MOD	170A, 400V				
IRKU170-06	MOD	170A, 600V				
IRKU170-08	MOD	170A, 800V				
IRKU170-10	MOD	170A, 1kV				
IRKU170-12	MOD	170A, 1.2kV				
IRKU170-14	MOD	170A, 1.4kV				
IRKU170-16	MOD	170A, 1.6kV				
IRKU230-04	MOD	230A, 400V				
IRKU230-06	MOD	230A, 600V				

器件型号 Element type	厂名 Manufacturers	材料用途参数 Material Purpose Parameter	图号 Figure	国内外相似替换器件型号 Replace of similar type	备注 Notes	外形参考图 Reference shape
IRKU230-08	MOD	230A, 800V				 图 G-21
IRKU230-10	MOD	230A, 1kV				
IRKU230-12	MOD	230A, 1.2kV				
IRKU230-16	MOD	230A, 1.6kV				
IRKU230-18	MOD	230A, 1.8kV				
IRKU230-20	MOD	230A, 2kV				
IRKU250-04	MOD	250A, 400V				
IRKU250-08	MOD	250A, 800V				
IRKU250-10	MOD	250A, 1kV				
IRKU250-12	MOD	250A, 1.2kV				
IRKU250-14	MOD	250A, 1.4kV				
IRKU250-16	MOD	250A, 1.6kV				
IRKUF72-06	MOD	71A, 600V	G-21			
IRKUF72-08	MOD	71A, 800V	G-21			
IRKUF72-10	MOD	71A, 1kV	G-21			
IRKUF72-12	MOD	71A, 1.2kV	G-21			
IRKUF82-02	MOD	81A, 200V	G-21			
IRKUF82-04	MOD	81A, 400V	G-21			
IRKUF82-06	MOD	81A, 600V	G-21			
IRKUF82-08	MOD	81A, 800V	G-21			
IRKUF102-06	MOD	105A, 600V	G-21			
IRKUF102-08	MOD	105A, 800V	G-21			
IRKUF102-10	MOD	105A, 1kV	G-21			
IRKUF102-12	MOD	105A, 1.2kV	G-21			

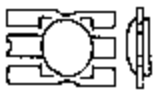

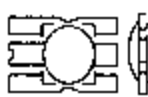
器件型号 Element type	厂名 Manufacturers	材料用途参数 Material Purpose Parameter	图号 Figure	国内外相似替换器件型号 Replace of similar type	备注 Notes	外形参考图 Reference shape
IRKUF112-02	MOD	112A, 200V	G-21			 图 G-21
IRKUF112-04	MOD	112A, 400V	G-21			
IRKUF112-06	MOD	112A, 600V	G-21			
IRKUF112-08	MOD	112A, 800V	G-21			
IRKUF132-02	MOD	130A, 200V	G-21			
IRKUF132-04	MOD	130A, 400V	G-21			
IRKUF132-06	MOD	130A, 600V	G-21			
IRKUF132-08	MOD	130A, 800V	G-21			
IRKUF152-02	MOD	150A, 200V	G-21			
IRKUF152-04	MOD	150A, 400V	G-21			
IRKUF152-06	MOD	150A, 600V	G-21			
IRKUF152-08	MOD	150A, 800V	G-21			
IRKUF180-02	MOD	180A, 200V				
IRKUF180-04	MOD	180A, 400V				
IRKUF180-06	MOD	180A, 600V				
IRKUF180-08	MOD	180A, 800V				
IRKUF180-10	MOD	180A, 1kV				
IRKUF180-12	MOD	180A, 1.2kV				
IRKUF200-02	MOD	200A, 200V				
IRKUF200-04	MOD	200A, 400V				
IRKUF200-06	MOD	200A, 600V				
IRKUF200-08	MOD	200A, 800V				
IRKUF200-10	MOD	200A, 1kV				
IRKUF200-12	MOD	200A, 1.2kV				

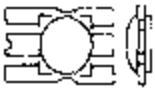
器件型号 Element type	厂名 Manufacturers	材料用途参数 Material Purpose Parameter	图号 Figure	国内外相似替换器件型号 Replace of similar type	备注 Notes	外形参考图 Reference shape
IRKV136-04	MOD	135A, 600V	G-21			 图 G-21
IRKV136-06	MOD	135A, 600V	G-21			
IRKV136-08	MOD	135A, 800V	G-21			
IRKV136-10	MOD	135A, 1kV	G-21			
IRKV136-12	MOD	135A, 1.2kV	G-21			
IRKV136-14	MOD	135A, 1.4kV	G-21			
IRKV136-16	MOD	135A, 1.6kV	G-21			
IRKV142-04	MOD	140A, 400V	G-21			
IRKV142-06	MOD	140A, 600V	G-21			
IRKV142-08	MOD	140A, 800V	G-21			
IRKV142-10	MOD	140A, 1kV	G-21			
IRKV142-12	MOD	140A, 1.2kV	G-21			
IRKV142-16	MOD	140A, 1.6kV	G-21			
IRKV142-18	MOD	140A, 1.8kV	G-21			
IRKV142-20	MOD	140A, 2kV	G-21			
IRKV162-04	MOD	160A, 400V	G-21			
IRKV162-06	MOD	160A, 600V	G-21			
IRKV162-08	MOD	160A, 800V	G-21			
IRKV162-10	MOD	160A, 1kV	G-21			
IRKV162-12	MOD	160A, 1.2kV	G-21			
IRKV162-16	MOD	160A, 1.6kV	G-21			
IRKV170-04	MOD	170A, 400V				
IRKV170-06	MOD	170A, 600V				
IRKV170-08	MOD	170A, 800V				
IRKV170-10	MOD	170A, 1kV				
IRKV170-12	MOD	170A, 1.2kV				



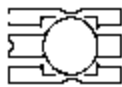

器件型号 Element type	厂名 Manufacturers	材料用途参数 Material Purpose Parameter	图号 Figure	国内外相似替换器件型号 Replace of similar type	备注 Notes	外形参考图 Reference shape
IRKV170-14	MOD	170A, 1.4kV				 图 G-21
IRKV170-16	MOD	170A, 1.6kV				
IRKV230-04	MOD	230A, 400V				
IRKV230-06	MOD	230A, 600V				
IRKV230-08	MOD	230A, 800V				
IRKV230-10	MOD	230A, 1kV				
IRKV230-12	MOD	230A, 1.2kV				
IRKV230-16	MOD	230A, 1.6kV				
IRKV230-18	MOD	230A, 1.8kV				
IRKV230-20	MOD	230A, 2kV				
IRKV250-04	MOD	250A, 400V				
IRKV250-06	MOD	250A, 600V				
IRKV250-08	MOD	250A, 800V				
IRKV250-10	MOD	250A, 1kV				
IRKV250-12	MOD	250A, 1.2kV				
IRKV250-14	MOD	250A, 1.4kV				
IRKV250-16	MOD	250A, 1.6kV				
IRKVF72-06	MOD	71A, 600V	G-21			
IRKVF72-08	MOD	71A, 800V	G-21			
IRKVF72-10	MOD	71A, 1kV	G-21			
IRKVF72-12	MOD	71A, 1.2kV	G-21			
IRKVF82-02	MOD	81A, 200V	G-21			
IRKVF82-04	MOD	81A, 400V	G-21			
IRKVF82-06	MOD	81A, 600V	G-21			
IRKVF82-08	MOD	81A, 800V	G-21			

器件型号 Element type	厂名 Manufacturers	材料 Material	用途 Purpose	参数 Parameter	图号 Figure	国内外相似替换器件型号 Replace of similar type	备注 Notes	外形参考图 Reference shape
IRKVF102-06	MOD	105A, 600V			G-21			 图 G-21
IRKVF102-08	MOD	105A, 800V			G-21			
IRKVF102-10	MOD	105A, 1kV			G-21			
IRKVF102-12	MOD	105A, 1.2kV			G-21			
IRKVF112-02	MOD	112A, 200V			G-21			
IRKVF112-04	MOD	112A, 400V			G-21			
IRKVF112-08	MOD	112A, 800V			G-21			
IRKVF132-02	MOD	130A, 200V			G-21			
IRKVF132-04	MOD	130A, 400V			G-21			
IRKVF132-06	MOD	130A, 600V			G-21			
IRKVF132-08	MOD	130A, 800V			G-21			
IRKVF152-02	MOD	150A, 200V			G-21			
IRKVF152-04	MOD	150A, 400V			G-21			
IRKVF152-06	MOD	150A, 600V			G-21			
IRKVF152-08	MOD	150A, 800V			G-21			
IRKVF180-02	MOD	180A, 200V						
IRKVF180-04	MOD	180A, 400V						
IRKVF180-06	MOD	180A, 600V						
IRKVF180-08	MOD	180A, 800V						
IRKVF180-10	MOD	180A, 1kV						
IRKVF180-12	MOD	180A, 1.2kV						
IRKVF200-02	MOD	200A, 200V						
IRKVF200-04	MOD	200A, 400V						
IRKVF200-06	MOD	200A, 600V						

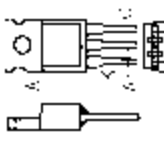
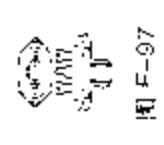

器件型号 Element type	厂名 Manufacturer's	材料用途参数 Material Purpose Parameter	图号 Figure	国内外相似替换器件型号 Replace of similar type	备注 Notes	外形参考图 Reference shape
IRKVF200-08	MOD	200A, 800V				
IRKVF200-10	MOD	200A, 1kV				
IRKVF200-12	MOD	200A, 1.2kV				
IS08	HUT	8A, 50V, 0.025A, 1.5V	B-91	S0508L		 图 B-91
IS010	HUT	10A, 50V, 0.025A, 1.5V	R-91	ECG5550, S0510L		
IS18	HUT	8A, 100V, 0.025A, 1.5V	B-91	S0508L		
IS020	HUT	20A, 50V, 0.025A, 1.5V	B-91	S0520L, ECG5550		
IS28	HUT	8A, 200V, 0.025A, 1.5V	B-91	S2008L		
IS38	HUT	8A, 300V, 0.025A, 1.5V	B-91	S4008L		
IS48	HUT	8A, 400V, 0.025A, 1.5V	B-91	S4008L		
IS58	HUT	8A, 500V, 0.025A, 1.5V	B-91	S6008L		
IS68	HUT	10A, 50V, 0.025A, 1.5V	B-91	ECG5550, S6008L		
IS110	HUT	10A, 100V, 0.025A, 1.5V	B-91	ECG5552, S1010L		
IS120	HUT	20A, 100V, 0.025A, 1.5V	B-91	ECG5552, S1020L		
IS210	HUT	10A, 200V, 0.025A, 1.5V	R-91	ECG5552, S2010I		
IS220	HUT	20A, 200V, 0.025A, 1.5V	B-91	ECG5552, S2020L		
IS310	HUT	10A, 300V, 0.025A, 1.5V	B-91	ECG5554, S3010L		
IS320	HUT	20A, 300V, 0.025A, 1.5V	B-91	ECG5554, S3020L		
IS410	HUT	10A, 400V, 0.025A, 1.5V	B-91	ECG5554, S4010L		
IS420	HUT	20A, 400V, 0.025A, 1.5V	B-91	ECG5554, S4020L		
IS510	HUT	10A, 500V, 0.025A, 1.5V	B-91	ECG5556, S5010L		
IS520	HUT	20A, 500V, 0.025A, 1.5V	B-91	ECG5556, S5020L		
IS610	HUT	10A, 600V, 0.025A, 1.5V	B-91	ECG5556, S6010L		
IS620	HUT	20A, 600V, 0.025A, 1.5V	B-91	ECG5556, S6020L		
ISPS035	HUT	35A, 50V, 0.025A, 1.5V	F-97	S0535D		 图 F-97
ISPS135	HUT	35A, 100V, 0.025A, 1.5V	F-97	S1535D		

器件型号 Element type	厂名 Manufacturers	材料用途参数 Material Purpose Parameter	图号 Figure	国内外相似替换器件型号 Replace of similar type	备注 Notes	外形参考图 Reference shape
ISPS235	HUT	35A, 200V, 0.025A, 1.5V	F-97	S2535D		 图 F-97
ISPS335	HUT	35A, 300V, 0.025A, 1.5V	F-97	S3535D		
ISPS435	HUT	35A, 400V, 0.025A, 1.5V	F-97	S4535D		
ISPS535	HUT	35A, 500V, 0.025A, 1.5V	F-97	S5535D		
ISPS635	HUT	35A, 600V, 0.025A, 1.5V	F-97	S6535D		
ISPT030	HUT	30A, 50V, 0.1A, 2.5V	F-97	ECG56022		
ISPT040	HUT	40A, 50V, 0.1A, 2.5V	F-97	ECG56022, Q2040D		
ISPT130	HUT	30A, 100V, 0.1A, 2.5V	F-97	ECG56022		
ISPT140	HUT	40A, 100V, 0.1A, 2.5V	F-97	ECG56022, Q2040D		
ISPT230	HUT	30A, 200V, 0.1A, 2.5V	F-97	ECG56022		
ISPT240	HUT	40A, 200V, 0.1A, 2.5V	F-97	ECG56022, Q2040D		
ISPT330	HUT	30A, 300V, 0.1A, 2.5V	F-97	ECG56024		
ISPT340	HUT	40A, 300V, 0.1A, 2.5V	F-97	ECG56024, Q4040D		
ISPT430	HUT	30A, 400V, 0.1A, 2.5V	F-97	ECG56024		
ISPT440	HUT	40A, 400V, 0.1A, 2.5V	F-97	ECG56024, Q1040D		
ISPT530	HUT	30A, 500V, 0.1A, 2.5V	F-97	ECG56026		
ISPT540	HUT	40A, 500V, 0.1A, 2.5V	F-97	ECG56026, Q5040D		
ISPT630	HUT	30A, 600V, 0.1A, 2.5V	F-97	ECG56026		
ISPT640	HUT	40A, 600V, 0.1A, 2.5V	F-97	ECG56026, Q6040D		
IT08, A	HUT	8A, 50V, 0.05A, 2.5V	B-91	ECG5645, Q2006L4, Q2006L5, SK3658, SK56004, T2850A		 图 B-91
IT08B	HUT	8A, 50V, 0.1A, 2.5V	B-91	Q2008L6		
IT08HA	HUT	8A, 50V, 0.025A, 2.5V	B-91	ECG5645, Q2008L4		
IT08HX	HUT	8A, 50V, 0.025A, 2.5V	B-91	ECG5645, Q2008L4		
IT010	HUT	10A, 50V, 0.05A, 2.5V	B-91	ECG5645, Q2010L4, SK3658, SK56004		
IT015, A	HUT	15A, 50V, 0.05A, 2.5V	B-91	ECG5604, Q2015L5, SK3658, SK56004		
IT015B	HUT	15A, 50V, 0.1A, 2.5V	B-91	Q2015L6		

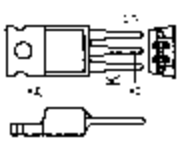

器件型号 Element type	厂名 Manufacturers	材料用途参数 Material Purpose Parameter	图号 Figure	国内外相似替换器件型号 Replace of similar type	备注 Notes	外形参考图 Reference shape
IT015HA	HUT	15A, 50V, 0.025A, 2.5V	B-91	Q2015L4		 图 B-91
IT015HX	HUT	15A, 50V, 0.025A, 2.5V	B-91			
IT18, A	HUT	8A, 100V, 0.05A, 2.5V	B-91	ECG5645, Q2008L4, Q2008L5, SK3658, SK56004, T2850A		
IT18B	HUT	8A, 100V, 0.1A, 2.5V	B-91	Q2008L6		
IT18H	HUT	8A, 100V, 0.025A, 2.5V	B-91	ECG5645, Q2008L4		
IT28, A	HUT	8A, 200V, 0.05A, 2.5V	B-91	ECG56004, Q2008L4, Q2008L5, SK3658, SK56004, T2850B		
IT28B	HUT	8A, 200V, 0.1A, 2.5V	B-91	Q2008L6		
IT28H	HUT	8A, 200V, 0.025A, 2.5V	B-91	ECG5645, Q2008L4		
IT38, A	HUT	8A, 300V, 0.05A, 2.5V	B-91	ECG5645, Q4008L4, Q4008L5, SK3659, SK56006, T2850D		
IT38B	HUT	8A, 300V, 0.1A, 2.5V	B-91	Q4008L6		
IT38H	HUT	8A, 300V, 0.025A, 2.5V	B-91	ECG5645, Q4008L4		
IT48, A	HUT	8A, 400V, 0.05A, 2.5V	B-91	ECG5645, Q4008L4, Q4008L5, SK3659, SK56006, T2850D		
IT48B	HUT	8A, 400V, 0.1A, 2.5V	B-91	Q4008L6		
IT48H	HUT	8A, 400V, 0.025A, 2.5V	B-91	ECG5645, Q4008L4		
IT58, A	HUT	8A, 500V, 0.05A, 2.5V	B-91	ECG5645, Q5008L4, Q5008L5, SK3660, SK56008		
IT58B	HUT	8A, 500V, 0.1A, 2.5V	B-91	Q5008L6		
IT58H	HUT	8A, 500V, 0.025A, 2.5V	B-91	ECG5645, Q5008L4		
IT68, A	HUT	8A, 600V, 0.05A, 2.5V	B-91	ECG5645, Q6008L4, Q6008L5, SK3660, SK56008		
IT68B	HUT	8A, 600V, 0.1A, 2.5V	B-91	Q6008L6		
IT68H	HUT	8A, 600V, 0.025A, 2.5V	B-91	ECG5645, Q6008L4		
IT110, A	HUT	10A, 100V, 0.05A, 2.5V	B-91	ECG5645, Q2010L4, Q2010L5, SK3658, SK56004		
IT110B	HUT	10A, 100V, 0.1A, 2.5V	B-91	Q2010L6		
IT110H	HUT	10A, 100V, 0.025A, 2.5V	B-91	ECG5645, Q2010L4		

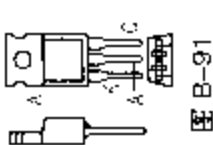
器件型号 Element type	厂名 Manufacturers	材料用途参数 Material Purpose Parameter	图号 Figure	国内外相似替换器件型号 Replace of similar type	备注 Notes	外形参考图 Reference shape
IT115, A	HUT	15A, 100V, 0.05A, 2.5V	B-91	ECG56004, Q2015L5, SK3658, SK56004		 图 B-91
IT115B	HUT	15A, 100V, 0.1A, 2.5V	B-91	Q2010L6		
IT115H	HUT	15A, 100V, 0.025A, 2.5V	B-91	Q2015L4		
IT210, A	HUT	10A, 200V, 0.05A, 2.5V	B-91	ECG5645, Q2010L4, Q2010L5, SK3112		
IT210B	HUT	10A, 200V, 0.1A, 2.5V	B-91	Q2010L6		
IT210H	HUT	10A, 200V, 0.025A, 2.5V	B-91	ECG5645, Q2010L4		
IT215, A	HUT	15A, 200V, 0.05A, 2.5V	B-91	ECG560404, Q2015L5, S3658, SK56004		
IT215B	HUT	15A, 200V, 0.1A, 2.5V	B-91	Q2015L6		
IT215H	HUT	15A, 200V, 0.025A, 2.5V	B-91	Q2015L4		
IT310, A	HUT	10A, 300V, 0.05A, 2.5V	B-91	ECG5645, Q4010L4, Q4010L5, SK3659, SK56006		
IT310B	HUT	10A, 300V, 0.1A, 2.5V	B-91	Q4010L6		
IT310H	HUT	10A, 300V, 0.025A, 2.5V	B-91	ECG5645, Q4010L4		
IT315, A	HUT	15A, 300V, 0.05A, 2.5V	B-91	ECG56006, Q4015L5, SK3659, SK56006		
IT315B	HUT	15A, 300V, 0.1A, 2.5V	B-91	Q4015L6		
IT315H	HUT	15A, 300V, 0.025A, 2.5V	B-91	Q4015L4		
IT410, A	HUT	10A, 400V, 0.05A, 2.5V	B-91	ECG5645, Q4010L4, Q4010L5, SK3659, SK56006		
IT410B	HUT	10A, 400V, 0.1A, 2.5V	B-91	Q4010L6		
IT410H	HUT	10A, 400V, 0.025A, 2.5V	B-91	ECG5645, Q4010L4		
IT415, A	HUT	15A, 400V, 0.05A, 2.5V	B-91	ECG56006, Q4015L5, SK3659, SK56006		
IT415B	HUT	15A, 400V, 0.1A, 2.5V	B-91	Q4015L6		
IT415H	HUT	15A, 400V, 0.025A, 2.5V	B-91	ECG5645, Q4010L4		
IT510, A	HUT	10A, 500V, 0.05A, 2.5V	B-91	ECG5645, Q5010L4, Q5010L5, SK3669, SK56008		
IT510B	HUT	10A, 500V, 0.1A, 2.5V	B-91	Q5010L6		
IT510H	HUT	10A, 500V, 0.025A, 2.5V	B-91	ECG5645, Q5010L4		
IT515, A	HUT	15A, 500V, 0.05A, 2.5V	B-91	ECG56008, Q5010L5, SK3660, SK56008		

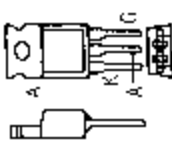
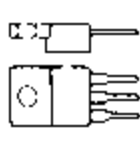

器件型号 Element type	厂名 Manufacturers	材料用途参数 Material Purpose Parameter	图号 Figure	国内外相似替换器型号 Replace of similar type	备注 Notes	外形参考图 Reference shape
IT515B IT515H	HUT HUT	15A, 500V, 0.1A, 2.5V 15A, 500V, 0.025A, 2.5V	B-91 B-91	Q6015L6		 图 B-91
IT610, A IT610B IT610H IT615, A IT615B IT615H	HUT HUT HUT HUT HUT HUT	10A, 600V, 0.05A, 2.5V 10A, 600V, 0.1A, 2.5V 10A, 600V, 0.025A, 2.5V 15A, 600V, 0.05A, 2.5V 15A, 600V, 0.1A, 2.5V 15A, 600V, 0.025A, 2.5V	B-91 B-91 B-91 B-91 B-91 B-91	EGG5645, Q6010L4, Q6010L5, SK3660, SK56008 Q6010L6 ECG5645, Q6010L4 EGG56008, Q6015L5, SK3660, SK56008 Q6015L6 Q6015L4		
ITR17052 ITR17053		8A, 700V, 0.04A, 4V 8A, 750V, 0.04A, 4V	B-11 B-11	17052 17053		 图 B-11

G~I 类外形参考图索引



图 A-5



图 B-10

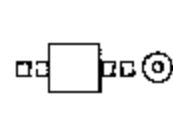

图 B-11

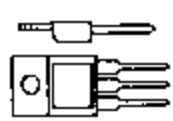

图 B-21

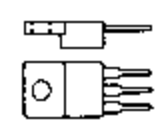

图 B-35

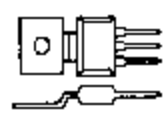

图 B-51

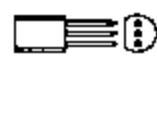

图 B-65



图 B-91

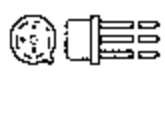

图 C-29



图 C-32

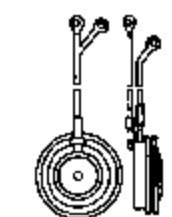

图 D-23

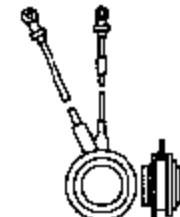

图 D-29

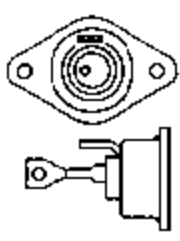

图 F-47

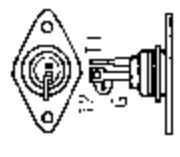

图 F-48



图 F-59

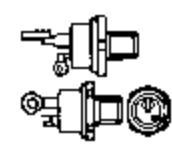

图 F-97



图 G-22



图 G-21

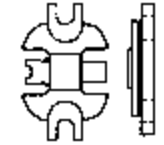

图 H-16

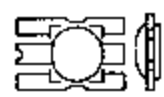

图 H-29



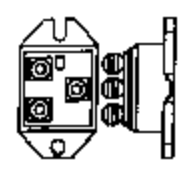

图 H-30

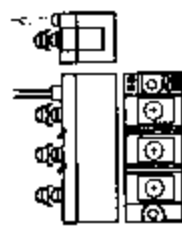

器件型号 Element type	厂名 Manufacturers	材料用途参数 Material Purpose Parameter	图号 Figure	国内外相似替换器件型号 Replace of similar type	备注 Notes	外形参考图 Reference shape
K1V5	SHE	DAC 50A, 45V, 45V, 1.5V	F-1	EGG6415		 图 1-1
K1V6	SHE	DAC 50A, 45V, 55V, 1.5V	F-1	EGG6416		
K1V10	SHE	DAC 50A, 90V, 95V, 1.5V	F-1	EGG6417		
K1V11	SHE	DAC 50A, 90V, 104V, 1.5V	F-1	EGG6418		
K1100E	TCE	DAC 30A, 90V, 104V, 1.5V	B-36			 图 B-36
K1200E	TCE	DAC 30A, 90V, 110V, 1.5V	B-36			
K1300E	TCE	SAT 20A, 120V, 1.5V	B-36			
K2200E	TCE	SAT 20A, 205V, 1.5V	B-36			
K2400E	TCE	SAT 20A, 220V, 1.5V	B-36			
KG20	CHN	SCR-GC 20A, 600V				 图 1-27
KG30	CHN	SCR-GC 30A, 600V				
KG40	CHN	SCR-GC 40A, 600V				
KG50	CHN	SCR-GC 50A, 600V				
KK1	CHN	SCR-H 1A, 1.05kV				
KK1-1	CHN	1A, 100V, 0.003-0.03A, 2.5V	F-27			
KK1-2	CHN	1A, 200V, 0.003-0.03A, 2.5V	F-27			
KK1-3	CHN	1A, 300V, 0.003-0.03A, 2.5V	F-27			
KK1-4	CHN	1A, 400V, 0.003-0.03A, 2.5V	F-27			
KK1-5	CHN	1A, 500V, 0.003-0.03A, 2.5V	F-27			
KK1-6	CHN	1A, 600V, 0.003-0.03A, 2.5V	F-27			
KK1-7	CHN	1A, 700V, 0.003-0.03A, 2.5V	F-27			
KK1-8	CHN	1A, 800V, 0.003-0.03A, 2.5V	F-27			
KK1-9	CHN	1A, 900V, 0.003-0.03A, 2.5V	F-27			
KK1-10	CHN	1A, 1kV, 0.003-0.03A, 2.5V	F-27			
KK1-12	CHN	1A, 1.2kV, 0.003-0.03A, 2.5V	F-27			
KK1-14	CHN	1A, 1.4kV, 0.003-0.03A, 2.5V	F-27			

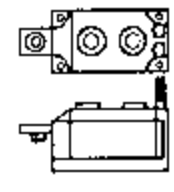
器件型号 Element type	厂名 Manufacturers	材料用途参数 Material Purpose Parameter	图号 Figure	国内外相似替换器件型号 Replace of similar type	备注 Notes	外形参考图 Reference shape
KK5	CHN	SCR-H 5A, 1.05kV				
KK5-1	CHN	5A, 100V, 0.05-0.07A, 3.5V	F-27			
KK5-2	CHN	5A, 200V, 0.05-0.07A, 3.5V	F-27			
KK5-3	CHN	5A, 300V, 0.05-0.07A, 3.5V	F-27			
KK5-4	CHN	5A, 400V, 0.05-0.07A, 3.5V	F-27			
KK5-5	CHN	5A, 500V, 0.05-0.07A, 3.5V	F-27			
KK5-6	CHN	5A, 600V, 0.05-0.07A, 3.5V	F-27			
KK5-7	CHN	5A, 700V, 0.05-0.07A, 3.5V	F-27			
KK5-8	CHN	5A, 800V, 0.05-0.07A, 3.5V	F-27			
KK5-9	CHN	5A, 900V, 0.05-0.07A, 3.5V	F-27			
KK5-10	CHN	5A, 1kV, 0.05-0.07A, 3.5V	F-27			
KK5-12	CHN	5A, 1.2kV, 0.05-0.07A, 3.5V	F-27			
KK5-14	CHN	5A, 1.4kV, 0.05-0.07A, 3.5V	F-27			
KK5-16	CHN	5A, 1.6kV, 0.05-0.07A, 3.5V	F-27			
KK5-18	CHN	5A, 1.8kV, 0.05-0.07A, 3.5V	F-27			
KK5-20	CHN	5A, 2kV, 0.05-0.07A, 3.5V	F-27			
KK10		SCR-H 10A, 1.05kV				
KK10-1	CHN	10A, 100V, 0.005-0.1A, 3.5V	F-27			
KK10-2	CHN	10A, 200V, 0.005-0.1A, 3.5V	F-27			
KK10-3	CHN	10A, 300V, 0.005-0.1A, 3.5V	F-27			
KK10-4	CHN	10A, 400V, 0.005-0.1A, 3.5V	F-27			
KK10-5	CHN	10A, 500V, 0.005-0.1A, 3.5V	F-27			
KK10-6	CHN	10A, 600V, 0.005-0.1A, 3.5V	F-27			
KK10-7	CHN	10A, 700V, 0.005-0.1A, 3.5V	F-27			
KK10-8	CHN	10A, 800V, 0.005-0.1A, 3.5V	F-27			
KK10-9	CHN	10A, 900V, 0.005-0.1A, 3.5V	F-27			
KK10-10	CHN	10A, 1kV, 0.005-0.1A, 3.5V	F-27			
KK10-12	CHN	10A, 1.2kV, 0.005-0.1A, 3.5V	F-27			

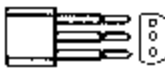
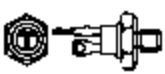

图 F-27



器件型号 Element type	厂名 Manufacturers	材料用途参数 Material Purpose Parameter	图号 Figure	国内外相似替换器件型号 Replace of similar type	备注 Notes	外形参考图 Reference shape
KK10-14	CHN	10A, 1.4kV, 0.005-0.1A, 3.5V	F-27			 图 F-27
KK10-16	CHN	10A, 1.6kV, 0.005-0.1A, 3.5V	F-27			
KK10-18	CHN	10A, 1.8kV, 0.005-0.1A, 3.5V	F-27			
KK10-20	CHN	10A, 2kV, 0.005-0.1A, 3.5V	F-27			
KK20	SCR-H	20A, 1.05kV				
KK20-1	CHN	20A, 100V, 0.005-0.1A, 3.5V	F-27			
KK20-2	CHN	20A, 200V, 0.005-0.1A, 3.5V	F-27			
KK20-3	CHN	20A, 300V, 0.005-0.1A, 3.5V	F-27			
KK20-4	CHN	20A, 400V, 0.005-0.1A, 3.5V	F-27			
KK20-5	CHN	20A, 500V, 0.005-0.1A, 3.5V	F-27			
KK20-6	CHN	20A, 600V, 0.005-0.1A, 3.5V	F-27			
KK20-7	CHN	20A, 700V, 0.005-0.1A, 3.5V	F-27			
KK20-8	CHN	20A, 800V, 0.005-0.1A, 3.5V	F-27			
KK20-9	CHN	20A, 900V, 0.005-0.1A, 3.5V	F-27			
KK20-10	CHN	20A, 1kV, 0.005-0.1A, 3.5V	F-27			
KK20-12	CHN	20A, 1.2kV, 0.005-0.1A, 3.5V	F-27			
KK20-14	CHN	20A, 1.4kV, 0.005-0.1A, 3.5V	F-27			
KK20-16	CHN	20A, 1.6kV, 0.005-0.1A, 3.5V	F-27			
KK20-18	CHN	20A, 1.8kV, 0.005-0.1A, 3.5V	F-27			
KK20-20	CHN	20A, 2kV, 0.005-0.1A, 3.5V	F-27			
KK25F		25A, 0.4-1.6kV, 0.05A, 3V				
KK25F-40	MOD	2 x SCR, 25A, 400V				
KK25F-80	MOD	2 x SCR, 25A, 600V				
KK25F-120	MOD	2 x SCR, 25A, 1.2kV				
KK25F-160	MOD	2 x SCR, 25A, 1.6kV				
KK25GB		25A, 400V, 0.05A, 3V				
KK25GB-40	MOD	2 x SCR, 25A, 400V				

器件型号 Element type	厂名 Manufacturers	材料用途参数 Material Purpose Parameter	图号 Figure	国内外相似替换器件型号 Replace of similar type	备注 Notes	外形参考图 Reference snap
KK25GB-80	MOD	2 x SCR, 25A, 800V				
KK25HB		25A, 1.2kV, 0.05A, 2V				
KK25HB-120	MOD	2 x SCR, 25A, 1.2kV				
KK25HB-160	MOD	2 x SCR, 25A, 1.6kV				
KK40F		40A, 0.4-1.6kV, 0.07A, 3V				
KK40F-40	MOD	2 x SCR, 40A, 400V				
KK40F-80	MOD	2 x SCR, 40A, 800V				
KK40F-120	MOD	2 x SCR, 40A, 1.2kV				
KK40F-160	MOD	2 x SCR, 40A, 1.6kV				
KK50	CHN	50A, 1.05kV				
KK50-1	CHN	50A, 100V, 0.008-0.15A, 3.5V				
KK50-2	CHN	50A, 200V, 0.008-0.15A, 3.5V				
KK50-3	CHN	50A, 300V, 0.008-0.15A, 3.5V				
KK50-4	CHN	50A, 400V, 0.008-0.15A, 3.5V				
KK50-5	CHN	50A, 500V, 0.008-0.15A, 3.5V				
KK50-6	CHN	50A, 600V, 0.008-0.15A, 3.5V				
KK50-7	CHN	50A, 700V, 0.008-0.15A, 3.5V				
KK50-8	CHN	50A, 800V, 0.008-0.15A, 3.5V				
KK50-9	CHN	50A, 900V, 0.008-0.15A, 3.5V				
KK50-10	CHN	50A, 1kV, 0.008-0.15A, 3.5V				
KK50-12	CHN	50A, 1.2kV, 0.008-0.15A, 3.5V				
KK50-14	CHN	50A, 1.4kV, 0.008-0.15A, 3.5V				
KK50-16	CHN	50A, 1.6kV, 0.008-0.15A, 3.5V				
KK50-18	CHN	50A, 1.8kV, 0.008-0.15A, 3.5V				
KK50-20	CHN	50A, 2kV, 0.008-0.15A, 3.5V				
KK55F-40	MOD	2 x SCR, 55A, 400V				

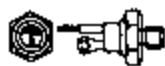
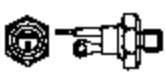

器件型号 Element type	厂名 Manufacturers	材料用途参数 Material Purpose Parameter	图号 Figure	国内外相似替换器件型号 Replace of similar type	备注 Notes	外形参考图 Reference shape
KK55F-80	MOD	2 x SCR, 55A, 800V				
KK55F-120	MOD	2 x SCR, 55A, 1.2kV				
KK55F-160	MOD	2 x SCR, 55A, 1.6kV				
KK55GB	CHN	55A, 400V, 0.1A, 3V				
KK55GB-40	MOD	2 x SCR, 55A, 400V				
KK55GB-80	MOD	2 x SCR, 55A, 800V				
KK55HB	CHN	55A, 1.2kV, 0.07A, 3V				
KK55HB-120	MOD	2 x SCR, 55A, 1.2kV				
KK55HB-160	MOD	2 x SCR, 55A, 1.6kV				
KK70F	CHN	70A, 0.4~1.6kV, 0.07A, 3V				
KK70F-40	MOD	2 x SCR, 70A, 400V				
KK70F-80	MOD	2 x SCR, 70A, 800V				
KK70F-120	MOD	2 x SCR, 70A, 1.2kV				
KK70F-160	MOD	2 x SCR, 70A, 1.6kV				
KK90F	CHN	90A, 0.4~1.6kV, 0.1A, 3V				
KK90F-40	MOD	2 x SCR, 90A, 400V				
KK90F-80	MOD	2 x SCR, 90A, 800V				
KK90F-120	MOD	2 x SCR, 90A, 1.2kV				
KK90F-160	MOD	2 x SCR, 90A, 1.6kV				
KK90GB	CHN	90A, 400V, 0.1A, 3V				
KK90GB-40	MOD	2 x SCR, 90A, 400V				
KK90GB-80	MOD	2 x SCR, 90A, 800V				
KK90HB	CHN	90A, 1.2kV, 0.1A, 3V				
KK90HB-120	MOD	2 x SCR, 90A, 1.2kV				
KK90HB-160	MOD	2 x SCR, 90A, 1.6kV				
KK100	CHN	SCR-H 100A, 1.05kV				

器件型号 Element type	厂名 Manufacturers	材料用途参数 Material Purpose Parameter	图号 Figure	国内外相似替换器件型号 Replace of similar type	备注 Notes	外形参考图 Reference shape
KK100A	CHN	SCR-H 100A, 850V				
KK100-1	CHN	100A, 100V, 0.01-0.25A, 4V	E-8			
KK100-2	CHN	100A, 200V, 0.01-0.25A, 4V	E-8			
KK100-3	CHN	100A, 300V, 0.01-0.25A, 4V	E-8			
KK100-4	CHN	100A, 400V, 0.01-0.25A, 4V	E-8			
KK100-5	CHN	100A, 500V, 0.01-0.25A, 4V	E-8			
KK100-6	CHN	100A, 600V, 0.01-0.25A, 4V	E-8			
KK100-7	CHN	100A, 700V, 0.01-0.25A, 4V	E-8			
KK100-8	CHN	100A, 800V, 0.01-0.25A, 4V	E-8			
KK100-9	CHN	100A, 900V, 0.01-0.25A, 4V	E-8			
KK100-10	CHN	100A, 1kV, 0.01-0.25A, 4V	E-8			
KK100-12	CHN	100A, 1.2kV, 0.01-0.25A, 4V	E-8			
KK100-14	CHN	100A, 1.4kV, 0.01-0.25A, 4V	E-8			
KK100-16	CHN	100A, 1.6kV, 0.01-0.25A, 4V	E-8			
KK100-18	CHN	100A, 1.8kV, 0.01-0.25A, 4V	E-8			
KK100-20	CHN	100A, 2kV, 0.01-0.25A, 4V	E-8			
KK110F	CHN	110A, 0.4-1.6kV, 0.1A, 3V				
KK110F-40		MOD 2 x SCR, 110A, 400V				
KK110F-80		MOD 2 x SCR, 110A, 800V				
KK110F-120		MOD 2 x SCR, 110A, 1.2kV				
KK110F-160		MOD 2 x SCR, 110A, 1.6kV				
KK130F-40		MOD 2 x SCR, 130A, 400V				
KK130F-80		MOD 2 x SCR, 130A, 800V				
KK130F-120		MOD 2 x SCR, 130A, 1.2kV				
KK130F-160		MOD 2 x SCR, 130A, 1.6kV				
KK160F-40		MOD 2 x SCR, 120A, 1kV				



图 E-8



器件型号 Element type	厂名 Manufacturers	材料用途参数 Material Purpose Parameter	图号 Figure	国内外相似替换器件型号 Replace of similar type	备注 Notes	外形参考图 Reference shape
KK160F-80	MOD	2 x SCR, 120A, 1kV				 图 E-8
KK160F-120	MOD	2 x SCR, 120A, 1.6kV				
KK160F-160	MOD	2 x SCR, 160A, 1.6kV				
KK200	CHN	SCR-H 200A, 1.05kV				
KK200A	CHN	SCR-H 200A, 850V				
KK200GB-40	MOD	2 x SCR, 200A, 400V				
KK200GB-80	MOD	2 x SCR, 200A, 800V				
KK200HB-120	MOD	2 x SCR, 200A, 1.2kV				
KK200-1	CHN	200A, 100V, 0.02-0.3A, 5V	E-8			
KK200-2	CHN	200A, 200V, 0.02-0.3A, 5V	E-8			
KK200-3	CHN	200A, 300V, 0.02-0.3A, 5V	E-8			
KK200-4	CHN	200A, 400V, 0.02-0.3A, 5V	E-8			
KK200-5	CHN	200A, 500V, 0.02-0.3A, 5V	E-8			
KK200-6	CHN	200A, 600V, 0.02-0.3A, 5V	E-8			
KK200-7	CHN	200A, 700V, 0.02-0.3A, 5V	E-8			
KK200-8	CHN	200A, 800V, 0.02-0.3A, 5V	E-8			
KK200-9	CHN	200A, 900V, 0.02-0.3A, 5V	E-8			
KK200-10	CHN	200A, 1kV, 0.02-0.3A, 5V	E-8			
KK200-12	CHN	200A, 1.2kV, 0.02-0.3A, 5V	E-8			
KK200-14	CHN	200A, 1.4kV, 0.02-0.3A, 5V	F-8			
KK200-16	CHN	200A, 1.6kV, 0.02-0.3A, 5V	E-8			
KK200-18	CHN	200A, 1.8kV, 0.02-0.3A, 5V	E-8			
KK200-20	CHN	200A, 2kV, 0.02-0.3A, 5V	E-8			
KK250GB-40	MOD	2 x SCR, 250A, 400V				
KK300	CHN	SCR-H 300A, 1.05kV				
KK300A	CHN	SCR-H 300A, 600V				

器件型号 Element type	厂名 Manufacturers	材料用途参数 Material Purpose Parameter	图号 Figure	国内外相似替换器件型号 Replace of similar type	备注 Notes	外形参考图 Reference shape
KK300-1	CHN	300A, 100V, 0.02-0.3A, 5V				
KK300-2	CHN	300A, 200V, 0.02-0.3A, 5V				
KK300-3	CHN	300A, 300V, 0.02-0.3A, 5V				
KK300-4	CHN	300A, 400V, 0.02-0.3A, 5V				
KK300-5	CHN	300A, 500V, 0.02-0.3A, 5V				
KK300-6	CHN	300A, 600V, 0.02-0.3A, 5V				
KK300-7	CHN	300A, 700V, 0.02-0.3A, 5V				
KK300-8	CHN	300A, 800V, 0.02-0.3A, 5V				
KK300-9	CHN	300A, 900V, 0.02-0.3A, 5V				
KK300-10	CHN	300A, 1kV, 0.02-0.3A, 5V				
KK300-12	CHN	300A, 1.2kV, 0.02-0.3A, 5V				
KK300-14	CHN	300A, 1.4kV, 0.02-0.3A, 5V				
KK300-16	CHN	300A, 1.6kV, 0.02-0.3A, 5V				
KK300-18	CHN	300A, 0.02-0.3A, 5V				
KK300-20	CHN	300A, 0.02-0.3A, 5V				
KK400	CHN	SCR-H 400A, 1.05kV				
KK400A	CHN	SCR-H 400A, 600V				
KK500	CHN	SCR-H 500A, 1.05kV				
KK500A	CHN	SCR-H 500A, 600V				
KK500-1	CHN	500A, 100V, 0.02-0.3A, 5V				
KK500-2	CHN	500A, 200V, 0.02-0.3A, 5V				
KK500-3	CHN	500A, 300V, 0.02-0.3A, 5V				
KK500-4	CHN	500A, 400V, 0.02-0.3A, 5V				
KK500-5	CHN	500A, 500V, 0.02-0.3A, 5V				
KK500-6	CHN	500A, 600V, 0.02-0.3A, 5V				
KK500-7	CHN	500A, 700V, 0.02-0.3A, 5V				
KK500-8	CHN	500A, 800V, 0.02-0.3A, 5V				



器件型号 Element type	厂名 Manufacturers	材料用途参数 Material Purpose Parameter	图号 Figure	国内外相似替换器件型号 Replace of similar type	备注 Notes	外形参考图 Reference shape
KK500-9	CHN	500A, 900V, 0.02-0.3A, 5V				
KK500-10	CHN	500A, 1kV, 0.02-0.3A, 5V				
KK500-12	CHN	500A, 1.2kV, 0.02-0.3A, 5V				
KK500-14	CHN	500A, 1.4kV, 0.02-0.3A, 5V				
KK500-16	CHN	500A, 1.6kV, 0.02-0.3A, 5V				
KK500-18	CHN	500A, 0.02-0.3A, 5V				
KK500-20	CHN	500A, 0.02-0.3A, 5V				
KP1		1A, 1.275kV				
KP1-0.5	CHN	1A, 50V, 0.02A, 2.5V				
KP1-1	CHN	1A, 100V, 0.02A, 2.5V				
KP1-2	CHN	1A, 200V, 0.02A, 2.5V				
KP1-3	CHN	1A, 300V, 0.02A, 2.5V				
KP1-4	CHN	1A, 400V, 0.02A, 2.5V				
KP1-5	CHN	1A, 500V, 0.02A, 2.5V				
KP1-6	CHN	1A, 600V, 0.02A, 2.5V				
KP1-7	CHN	1A, 700V, 0.02A, 2.5V				
KP1-8	CHN	1A, 800V, 0.02A, 2.5V				
KP1-9	CHN	1A, 900V, 0.02A, 2.5V				
KP1-10	CHN	1A, 1kV, 0.02A, 2.5V				
KP1-12	CHN	1A, 1.2kV, 0.02A, 2.5V				
KP1-14	CHN	1A, 1.4kV, 0.02A, 2.5V				
KP3-1	CHN	3A, 100V, 0.06A, 3V				
KP3-2	CHN	3A, 200V, 0.06A, 3V				
KP3-3	CHN	3A, 300V, 0.06A, 3V				
KP3-4	CHN	3A, 400V, 0.06A, 3V				
KP3-5	CHN	3A, 500V, 0.06A, 3V				
KP3-6	CHN	3A, 600V, 0.06A, 3V				

器件型号 Element type	厂名 Manufacturers	材料用途参数 Material Purpose Parameter	图号 Figure	国内外相似替换器件型号 Replace of similar type	备注 Notes	外形参考图 Reference shape
KP3-7	CHN	3A, 700V, 0.06A, 3V				
KP3-8	CHN	3A, 800V, 0.06A, 3V				
KP3-9	CHN	3A, 900V, 0.06A, 3V				
KP3-10	CHN	3A, 1kV, 0.06A, 3V				
KP3-12	CHN	3A, 1.2kV, 0.06A, 3V				
KP3-14	CHN	3A, 1.4kV, 0.06A, 3V				
KP3-16	CHN	3A, 1.6kV, 0.06A, 3V				
KP3-18	CHN	3A, 1.8kV, 0.06A, 3V				
KP5	CHN	5A, 800V				
KP5-1	CHN	5A, 100V, 0.06A, 3V				
KP5-2	CHN	5A, 200V, 0.06A, 3V				
KP5-3	CHN	5A, 300V, 0.06A, 3V				
KP5-4	CHN	5A, 400V, 0.06A, 3V				
KP5-5	CHN	5A, 500V, 0.06A, 3V				
KP5-6	CHN	5A, 600V, 0.06A, 3V				
KP5-7	CHN	5A, 700V, 0.06A, 3V				
KP5-8	CHN	5A, 800V, 0.06A, 3V				
KP5-9	CHN	5A, 900V, 0.06A, 3V				
KP5-10	CHN	5A, 1kV, 0.06A, 3V				
KP5-12	CHN	5A, 1.2kV, 0.06A, 3V				
KP5-14	CHN	5A, 1.4kV, 0.06A, 3V				
KP5-16	CHN	5A, 1.6kV, 0.06A, 3V				
KP5-18	CHN	5A, 1.8kV, 0.06A, 3V				
KP10	CHN	190A, 775V				
KP10-1	CHN	10A, 100V, 0.1A, 3V				
KP10-2	CHN	10A, 200V, 0.1A, 3V				
KP10-3	CHN	10A, 300V, 0.1A, 3V				



器件型号 Element type	厂名 Manufacturers	材料用途参数 Material Purpose Parameter	图号 Figure	国内外相似替换器件型号 Replace of similar type	备注 Notes	外形参考图 Reference shape
KP10-4	CHN	10A, 400V, 0.1A, 3V				
KP10-5	CHN	10A, 500V, 0.1A, 3V				
KP10-6	CHN	10A, 600V, 0.1A, 3V				
KP10-7	CHN	10A, 700V, 0.1A, 3V				
KP10-8	CHN	10A, 800V, 0.1A, 3V				
KP10-9	CHN	10A, 900V, 0.1A, 3V				
KP10-10	CHN	10A, 1kV, 0.1A, 3V				
KP10-12	CHN	10A, 1.2kV, 0.1A, 3V				
KP10-14	CHN	10A, 1.4kV, 0.1A, 3V				
KP10-16	CHN	10A, 1.6kV, 0.1A, 3V				
KP10-18	CHN	10A, 1.8kV, 0.1A, 3V				
KP20	CHN	20A, 775V				
KP20-1	CHN	20A, 100V, 0.1A, 3V				
KP20-2	CHN	20A, 200V, 0.1A, 3V				
KP20-3	CHN	20A, 300V, 0.1A, 3V				
KP20-4	CHN	20A, 400V, 0.1A, 3V				
KP20-5	CHN	20A, 500V, 0.1A, 3V				
KP20-6	CHN	20A, 600V, 0.1A, 3V				
KP20-7	CHN	20A, 700V, 0.1A, 3V				
KP20-8	CHN	20A, 800V, 0.1A, 3V				
KP20-9	CHN	20A, 900V, 0.1A, 3V				
KP20-10	CHN	20A, 1kV, 0.1A, 3V				
KP20-12	CHN	20A, 1.2kV, 0.1A, 3V				
KP20-14	CHN	20A, 1.4kV, 0.1A, 3V				
KP20-16	CHN	20A, 1.6kV, 0.1A, 3V				
KP20-18	CHN	20A, 1.8kV, 0.1A, 3V				
KP30	CHN	30A, 775V				

器件型号 Element type	厂名 Manufacturers	材料用途参数 Material Purpose Parameter	图号 Figure	国内外相似替换器件型号 Replace of similar type	备注 Notes	外形参考图 Reference shape
KP30-1	CHN	30A, 100V, 0.15A, 3V				
KP30-2	CHN	30A, 200V, 0.15A, 3V				
KP30-3	CHN	30A, 300V, 0.15A, 3V				
KP30-4	CHN	30A, 400V, 0.15A, 3V				
KP30-5	CHN	30A, 500V, 0.15A, 3V				
KP30-6	CHN	30A, 600V, 0.15A, 3V				
KP30-7	CHN	30A, 700V, 0.15A, 3V				
KP30-8	CHN	30A, 800V, 0.15A, 3V				
KP30-9	CHN	30A, 900V, 0.15A, 3V				
KP30-10	CHN	30A, 1kV, 0.15A, 3V				
KP30-12	CHN	30A, 1.2kV, 0.15A, 3V				
KP30-14	CHN	30A, 1.4kV, 0.15A, 3V				
KP30-16	CHN	30A, 1.6kV, 0.15A, 3V				
KP30-18	CHN	30A, 1.8kV, 0.15A, 3V				
KP50	CHN	50A, 800V				
KP50-1	CHN	50A, 100V, 0.2A, 3V				
KP50-2	CHN	50A, 200V, 0.2A, 3V				
KP50-3	CHN	50A, 300V, 0.2A, 3V				
KP50-4	CHN	50A, 400V, 0.2A, 3V				
KP50-5	CHN	50A, 500V, 0.2A, 3V				
KP50-6	CHN	50A, 600V, 0.2A, 3V				
KP50-7	CHN	50A, 700V, 0.2A, 3V				
KP50-8	CHN	50A, 800V, 0.2A, 3V				
KP50-9	CHN	50A, 900V, 0.2A, 3V				
KP50-10	CHN	50A, 1kV, 0.2A, 3V				
KP50-12	CHN	50A, 1.2kV, 0.2A, 3V				
KP50-14	CHN	50A, 1.4kV, 0.2A, 3V				
KP50-16	CHN	50A, 1.6kV, 0.2A, 3V				



器件型号 Element type	厂名 Manufacturers	材料用途参数 Material Purpose Parameter	图号 Figure	国内外相似替换器型号 Replace of similar type	备注 Notes	外形参考图 Reference shape
KP50-18	CHN	50A, 1.8kV, 0.2A, 3V				
KP100	CHN	100A, 1.025kV				
KP100-1	CHN	100A, 100V, 0.25A, 3.5V	E-8			
KP100-2	CHN	100A, 200V, 0.25A, 3.5V	E-8			
KP100-3	CHN	100A, 300V, 0.25A, 3.5V	E-8			
KP100-4	CHN	100A, 400V, 0.25A, 3.5V	E-8			
KP100-5	CHN	100A, 500V, 0.25A, 3.5V	E-8			
KP100-6	CHN	100A, 600V, 0.25A, 3.5V	E-8			
KP100-7	CHN	100A, 700V, 0.25A, 3.5V	E-8			
KP100-8	CHN	100A, 800V, 0.25A, 3.5V	E-8			
KP100-9	CHN	100A, 900V, 0.25A, 3.5V	E-8			
KP100-10	CHN	100A, 1kV, 0.25A, 3.5V	E-8			
KP100-12	CHN	100A, 1.2kV, 0.25A, 3.5V	E-8			
KP100-14	CHN	100A, 1.4kV, 0.25A, 3.5V	E-8			
KP100-16	CHN	100A, 1.6kV, 0.25A, 3.5V	E-8			
KP100-18	CHN	100A, 1.8kV, 0.25A, 3.5V	E-8			
KP200	CHN	200A, 1.5kV				
KP200-1	CHN	200A, 100V, 0.25A, 3.5V				
KP200-2	CHN	200A, 200V, 0.25A, 3.5V				
KP200-3	CHN	200A, 300V, 0.25A, 3.5V				
KP200-4	CHN	200A, 400V, 0.25A, 3.5V				
KP200-5	CHN	200A, 500V, 0.25A, 3.5V				
KP200-6	CHN	200A, 600V, 0.25A, 3.5V				
KP200-7	CHN	200A, 700V, 0.25A, 3.5V				
KP200-8	CHN	200A, 800V, 0.25A, 3.5V				
KP200-9	CHN	200A, 900V, 0.25A, 3.5V				
KP200-10	CHN	200A, 1kV, 0.25A, 3.5V				
KP200-12	CHN	200A, 1.2kV, 0.25A, 3.5V				



图 E-8

器件型号 Element type	厂名 Manufacturers	材料用途参数 Material Purpose Parameter	图号 Figure	国内外相似替换器件型号 Replace of similar type	备注 Notes	外形参考图 Reference shape
KP200-14	CHN	200A, 1.4kV, 0.25A, 3.5V				
KP200-16	CHN	200A, 1.6kV, 0.25A, 3.5V				
KP200-18	CHN	200A, 1.8kV, 0.25A, 3.5V				
KP200-20	CHN	200A, 2kV, 0.25A, 3.5V				
KP300	CHN	300A, 1.5kV				
KP300-1	CHN	300A, 100V, 0.35A, 3.5V				
KP300-2	CHN	300A, 200V, 0.35A, 3.5V				
KP300-3	CHN	300A, 300V, 0.35A, 3.5V				
KP300-4	CHN	300A, 400V, 0.35A, 3.5V				
KP300-5	CHN	300A, 500V, 0.35A, 3.5V				
KP300-6	CHN	300A, 600V, 0.35A, 3.5V				
KP300-7	CHN	300A, 700V, 0.35A, 3.5V				
KP300-8	CHN	300A, 800V, 0.35A, 3.5V				
KP300-9	CHN	300A, 900V, 0.35A, 3.5V				
KP300-10	CHN	300A, 1kV, 0.35A, 3.5V				
KP300-12	CHN	300A, 1.2kV, 0.35A, 3.5V				
KP300-14	CHN	300A, 1.4kV, 0.35A, 3.5V				
KP300-16	CHN	300A, 1.6kV, 0.35A, 3.5V				
KP300-18	CHN	300A, 1.8kV, 0.35A, 3.5V				
KP300-20	CHN	300A, 2kV, 0.35A, 3.5V				
KP400	CHN	400A, 1.5kV				
KP400-1	CHN	400A, 100V, 0.35A, 4V				
KP400-2	CHN	400A, 200V, 0.35A, 4V				
KP400-3	CHN	400A, 300V, 0.35A, 4V				
KP400-4	CHN	400A, 400V, 0.35A, 4V				
KP400-5	CHN	400A, 500V, 0.35A, 4V				
KP400-6	CHN	400A, 600V, 0.35A, 4V				



器件型号 Element type	厂名 Manufacturers	材料用途参数 Material Purpose Parameter	图号 Figure	国内外相似替换器件型号 Replace of similar type	备注 Notes	外形参考图 Reference shape
KP400-7	CHN	400A, 700V, 0.35A, 4V				
KP400-8	CHN	400A, 800V, 0.35A, 4V				
KP400-9	CHN	400A, 900V, 0.35A, 4V				
KP400-10	CHN	400A, 1kV, 0.35A, 4V				
KP400-12	CHN	400A, 1.2kV, 0.35A, 4V				
KP400-14	CHN	400A, 1.4kV, 0.35A, 4V				
KP400-16	CHN	400A, 1.6kV, 0.35A, 4V				
KP400-18	CHN	400A, 1.8kV, 0.35A, 4V				
KP400-20	CHN	400A, 2kV, 0.35A, 4V				
KP500	CHN	500A, 825V				
KP500-1	CHN	500A, 100V, 0.35A, 4V				
KP500-2	CHN	500A, 200V, 0.35A, 4V				
KP500-3	CHN	500A, 300V, 0.35A, 4V				
KP500-4	CHN	500A, 400V, 0.35A, 4V				
KP500-5	CHN	500A, 500V, 0.35A, 4V				
KP500-6	CHN	500A, 600V, 0.35A, 4V				
KP500-7	CHN	500A, 700V, 0.35A, 4V				
KP500-8	CHN	500A, 800V, 0.35A, 4V				
KP500-9	CHN	500A, 900V, 0.35A, 4V				
KP500-10	CHN	500A, 1kV, 0.35A, 4V				
KP500-12	CHN	500A, 1.2kV, 0.35A, 4V				
KP500-14	CHN	500A, 1.4kV, 0.35A, 4V				
KP500-16	CHN	500A, 1.6kV, 0.35A, 4V				
KP500-18	CHN	500A, 1.8kV, 0.35A, 4V				
KP500-20	CHN	500A, 2kV, 0.35A, 4V				
KP600	CHN	600A, 1.05kV				
KP600-1	CHN	600A, 100V, 0.35A, 4V				

器件型号 Element type	厂名 Manufacturers	材料用途参数 Material Purpose Parameter	图号 Figure	国内外相似替换器件型号 Replace of similar type	备注 Notes	外形参考图 Reference shape
KP600-2	CHN	600A, 200V, 0.35A, 4V				
KP600-3	CHN	600A, 300V, 0.35A, 4V				
KP600-4	CHN	600A, 400V, 0.35A, 4V				
KP600-5	CHN	600A, 500V, 0.35A, 4V				
KP600-6	CHN	600A, 600V, 0.35A, 4V				
KP600-7	CHN	600A, 700V, 0.35A, 4V				
KP600-8	CHN	600A, 800V, 0.35A, 4V				
KP600-9	CHN	600A, 900V, 0.35A, 4V				
KP600-10	CHN	600A, 1kV, 0.35A, 4V				
KP600-12	CHN	600A, 1.2kV, 0.35A, 4V				
KP600-14	CHN	600A, 1.4kV, 0.35A, 4V				
KP600-16	CHN	600A, 1.6kV, 0.35A, 4V				
KP600-18	CHN	600A, 1.8kV, 0.35A, 4V				
KP600-20	CHN	600A, 2kV, 0.35A, 4V				
KP800	CHN	800A, 1.025kV				
KP800-1	CHN	800A, 100V, 0.45A, 4V				
KP800-2	CHN	800A, 200V, 0.45A, 4V				
KP800-3	CHN	800A, 300V, 0.45A, 4V				
KP800-4	CHN	800A, 400V, 0.45A, 4V				
KP800-5	CHN	800A, 500V, 0.45A, 4V				
KP800-6	CHN	800A, 600V, 0.45A, 4V				
KP800-7	CHN	800A, 700V, 0.45A, 4V				
KP800-8	CHN	800A, 800V, 0.45A, 4V				
KP800-9	CHN	800A, 900V, 0.45A, 4V				
KP800-10	CHN	800A, 1kV, 0.45A, 4V				
KP800-12	CHN	800A, 1.2kV, 0.45A, 4V				
KP800-14	CHN	800A, 1.4kV, 0.45A, 4V				
KP800-16	CHN	800A, 1.6kV, 0.45A, 4V				

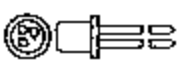
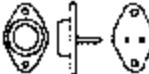
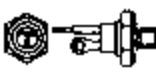
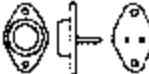
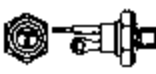

器件型号 Element type	厂名 Manufacturers	材料用途参数 Material Purpose Parameter	图号 Figure	国内外相似替换器件型号 Replace of similar type	备注 Notes	外形参考图 Reference shape
KP800-18	CHN	800A, 1.8kV, 0.45A, 4V				 图 B-68
KP800-20	CHN	800A, 2kV, 0.45A, 4V				
KP1000	CHN	1kA, 105V				 图 D-9
KP1500	CHN	1.5kA, 1.55kV				
KS05-1	CHN	SCR-D 0.5A, 100V, 0.002-0.05A, 2.5V B-68				 图 F-27
KS05-2	CHN	SCR-D 0.5A, 200V, 0.002-0.05A, 2.5V B-68				
KS05-3	CHN	SCR-D 0.5A, 300V, 0.002-0.05A, 2.5V B-68				
KS05-4	CHN	SCR-D 0.5A, 400V, 0.002-0.05A, 2.5V B-68				
KS05-5	CHN	SCR-D 0.5A, 500V, 0.002-0.05A, 2.5V B-68				
KS05-6	CHN	SCR-D 0.5A, 600V, 0.002-0.05A, 2.5V B-68				
KS05-7	CHN	SCR-D 0.5A, 700V, 0.002-0.05A, 2.5V B-68				
KS05-8	CHN	SCR-D 0.5A, 800V, 0.002-0.05A, 2.5V B-68				
KS1	CHN	SCR-D 1A, 550V				 图 D-9
KS1-1	CHN	SCR-D 1A, 100V, 0.003-0.1A, 2V D-9				
KS1-2	CHN	SCR-D 1A, 200V, 0.003-0.1A, 2V D-9				
KS1-3	CHN	SCR-D 1A, 300V, 0.003-0.1A, 2V D-9				
KS1-4	CHN	SCR-D 1A, 400V, 0.003-0.1A, 2V D-9				
KS1-5	CHN	SCR-D 1A, 500V, 0.003-0.1A, 2V D-9				
KS1-6	CHN	SCR-D 1A, 600V, 0.003-0.1A, 2V D-9				
KS1-7	CHN	SCR-D 1A, 700V, 0.003-0.1A, 2V D-9				
KS1-8	CHN	SCR-D 1A, 800V, 0.003-0.1A, 2V D-9				
KS3	CHN	SCR-D 3A, 550V				 图 F-27
KS3-1	CHN	SCR-D 3A, 100V, 0.005-0.1A, 3V F-27				
KS3-2	CHN	SCR-D 3A, 200V, 0.005-0.1A, 3V F-27				

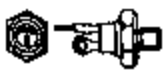
器件型号 Element type	厂名 Manufacturers	材料用途参数 Material Purpose Parameter	图号 Figure	国内外相似替换器件型号 Replace of similar type	备注 Notes	外形参考图 Reference shape
KS3-3	CHN	SCR-D 3A, 300V, 0.005-0.1A, 3V	F-27			 图 F-27
KS3-4	CHN	SCR-D 3A, 400V, 0.005-0.1A, 3V	F-27			
KS3-5	CHN	SCR-D 3A, 500V, 0.005-0.1A, 3V	F-27			
KS3-6	CHN	SCR-D 3A, 600V, 0.005-0.1A, 3V	F-27			
KS3-7	CHN	SCR-D 3A, 700V, 0.005-0.1A, 3V	F-27			
KS3-8	CHN	SCR-D 3A, 800V, 0.005-0.1A, 3V	F-27			
KS3-9	CHN	SCR-D 3A, 900V				
KS3-10	CHN	SCR-D 3A, 1kV, 0.005-0.1A, 3V	F-27			
KS3-12	CHN	SCR-D 3A, 1.2kV, 0.005-0.1A, 3V	F-27			
KS3-14	CHN	SCR-D 3A, 1.4kV, 0.005-0.1A, 3V	F-27			
KS3-16	CHN	SCR-D 3A, 1.6kV, 0.005-0.1A, 3V	F-27			
KS5-1	CHN	5A, 100V, 0.005-0.1A, 3V	F-27			
KS5-2	CHN	5A, 200V, 0.005-0.1A, 3V	F-27			
KS5-3	CHN	5A, 300V, 0.005-0.1A, 3V	F-27			
KS5-4	CHN	5A, 400V, 0.005-0.1A, 3V	F-27			
KS5-5	CHN	5A, 500V, 0.005-0.1A, 3V	F-27			
KS5-6	CHN	5A, 600V, 0.005-0.1A, 3V	F-27			
KS5-7	CHN	5A, 700V, 0.005-0.1A, 3V	F-27			
KS5-8	CHN	5A, 800V, 0.005-0.1A, 3V	F-27			
KS5-10	CHN	5A, 1kV, 0.005-0.1A, 3V	F-27			
KS5-12	CHN	5A, 1.2kV, 0.005-0.1A, 3V	F-27			
KS5-14	CHN	5A, 1.4kV, 0.005-0.1A, 3V	F-27			
KS5-16	CHN	5A, 1.6kV, 0.005-0.1A, 3V	F-27			
KS10	CHN	SCR-D 10A, 1.05kV				
KS10-1	CHN	SCR-D 10A, 100V, 0.005-0.1A, 3V	F-27			
KS10-2	CHN	SCR-D 10A, 200V, 0.005-0.1A, 3V	F-27			
KS10-3	CHN	SCR-D 10A, 300V, 0.005-0.1A, 3V	F-27			



器件型号 Element type	厂名 Manufacturers	材料用途参数 Material Purpose Parameter	图号 Figure	国内外相似替换器件型号 Replace of similar type	备注 Notes	外形参考图 Reference shape
KS10-4	CHN	SCR-D 10A, 400V, 0.005-0.1A, 3V	F-27			
KS10-5	CHN	SCR-D 10A, 500V, 0.005-0.1A, 3V	F-27			
KS10-6	CHN	SCR-D 10A, 600V, 0.005-0.1A, 3V	F-27			
KS10-7	CHN	SCR-D 10A, 700V, 0.005-0.1A, 3V	F-27			
KS10-8	CHN	SCR-D 10A, 800V, 0.005-0.1A, 3V	F-27			
KS10-9		SCR-D 10A, 900V				
KS10-10	CHN	SCR-D 10A, 1kV, 0.005-0.1A, 3V	F-27			
KS10-12	CHN	SCR-D 10A, 1.2kV, 0.005-0.1A, 3V	F-27			
KS10-14	CHN	SCR-D 10A, 1.4kV, 0.005-0.1A, 3V	F-27			
KS10-16	CHN	SCR-D 10A, 1.6kV, 0.005-0.1A, 3V	F-27			
KS20	CHN	SCR-D 20A, 650V				
KS20-1	CHN	SCR-D 20A, 100V, 0.2A, 3V	F-27			
KS20-2	CHN	SCR-D 20A, 200V, 0.2A, 3V	F-27			
KS20-3	CHN	SCR-D 20A, 300V, 0.2A, 3V	F-27			
KS20-4	CHN	SCR-D 20A, 400V, 0.2A, 3V	F-27			
KS20-5	CHN	SCR-D 20A, 500V, 0.2A, 3V	F-27			
KS20-6	CHN	SCR-D 20A, 600V, 0.2A, 3V	F-27			
KS20-7	CHN	SCR-D 20A, 700V, 0.2A, 3V	F-27			
KS20-8	CHN	SCR-D 20A, 800V, 0.2A, 3V	F-27			
KS20-9		SCR-D 20A, 900V				
KS20-10	CHN	SCR-D 20A, 1kV, 0.2A, 3V	F-27			
KS20-12	CHN	SCR-D 20A, 1.2kV, 0.2A, 3V	F-27			
KS20-14	CHN	SCR-D 20A, 1.4kV, 0.2A, 3V	F-27			
KS20-16	CHN	SCR-D 20A, 1.6kV, 0.2A, 3V	F-27			
KS50	CHN	SCR-D 50A, 1.05kV				
KS100	CHN	SCR-D 100A, 1.05kV				
KS200	CHN	SCR-D 200A, 1.05kV				







图 F-27



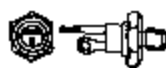
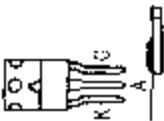

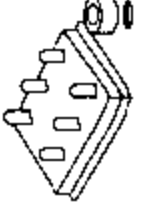
器件型号 Element type	厂名 Manufacturers	材料用途参数 Material Purpose Parameter	图号 Figure	国内外相似替换器型号 Replace of similar type	备注 Notes	外形参考图 Reference shape
KS400	CHN	SCR-D 400A, 1.05kV				
KS500	CHN	SCR-D 500A, 1.05kV				
KZG0.5A	CHN	0.5A, 50V				
KZG0.5B	CHN	0.5A, 100V				
KZG0.5C	CHN	0.5A, 200V				
KZG0.5D	CHN	0.5A, 300V				
KZG0.5E	CHN	0.5A, 400V				
KZG0.5F	CHN	0.5A, 500V				
KZG0.5G	CHN	0.5A, 600V				
KZG0.5H	CHN	0.5A, 700V				

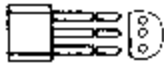
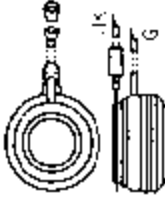
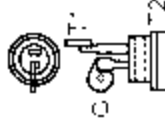



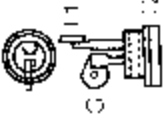
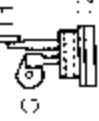
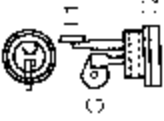
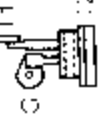
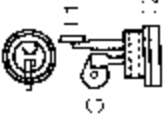
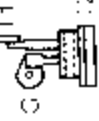
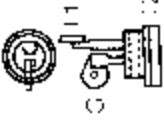
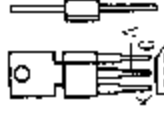
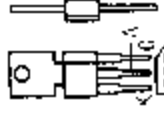
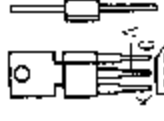
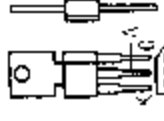
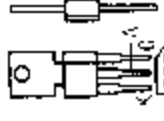
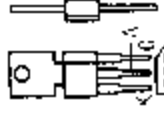
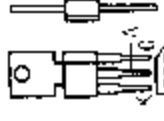

器件型号 Element type	厂名 Manufacturers	材料用途参数 Material Purpose Parameter	图号 Figure	国内外相似替换器型号 Replace of similar type	备注 Notes	外形参考图 Reference shape
L7R08152F	UNI	15A, 200V, 0.015A, 1.5V	B-76			
L7R08154F	UNI	15A, 400V, 0.015A, 1.5V	B-76			
L7R08154S	UNI	15A, 400V, 0.015A, 1.5V	B-75			
L7R08156F	UNI	15A, 600V, 0.015A, 1.5V	B-75			
L7R08158F	UNI	15A, 800V, 0.015A, 1.5V	B-76			
L7R08158S	UNI	15A, 800V, 0.015A, 1.5V	B-75			
L8A	GES	1.6A, 100V, 220 μA, 0.8V	B-51			
L8B	GES	1.6A, 200V, 220 μA, 0.8V	B-51			
L8F	GES	1.6A, 50V, 220 μA, 0.8V	B-51			
L8G	GES	1.6A, 150V, 220 μA, 0.8V	B-51			
L8U	GES	1.6A, 25V, 220 μA, 0.8V	B-51			
L9A	GES	1.6A, 100V, 220 μA, 0.8V	B-51			
L9B	GES	1.6A, 200V, 220 μA, 0.8V	B-51			
L9F	GES	1.6A, 5 V, 220 μA, 0.8V	B-51			
L9G	GES	1.6A, 150V, 220 μA, 0.8V	B-51			
L9U	GES	1.6A, 25V, 220 μA, 0.8V	B-51			
L200E3, 5, 7, 9	SCR-D	0.6A, 200V		MAC97B4, MAC97A4, MAC97-4, MAC97-4		
L201E3	TCE	1A, 200V, 0.003A, 2V	B-36			
L201E5	TCE	1A, 200V, 0.005A, 2V	B-36			
L201E7	TCE	1A, 200V, 0.01A, 2V	B-36			
L201E9	TCE	1A, 200V, 0.025A, 2V	B-36			
L311, 312	GITN	15A, 0.04A, 2.5V	H-31			
L321, 322	GITN	15A, 0.04A, 2.5V	H-31			
L331, 332	GITN	15A, 0.04A, 2.5V	H-31			
L341, 342	GITN	15A, 0.04A, 2.5V	H-31			
L351, 352	GITN	15A, 0.04A, 2.5V	H-31			

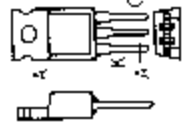
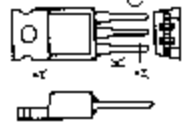
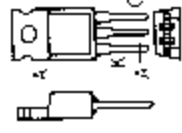
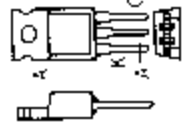
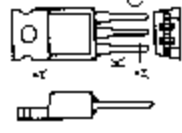
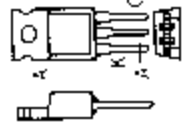

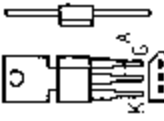

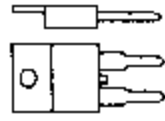





器件型号 Element type	厂名 Manufacturers	材料用途参数 Material Purpose Parameter	图号 Figure	国内外相似替换器件型号 Replace of similar type	备注 Notes	外形参考图 Reference shape	
L361, 362	GTN	SCB 15A, 0.04A, 2.5V	H-31			 图 H-31	
L371, 372	GTN	SCB 15A, 0.04A, 2.5V	H-31				
L381, 382	GTN	SCB 15A, 0.04A, 2.5V	H-31				
L391, 392	GTN	SCB 15A, 0.04A, 2.5V	H-31				
L400E3, 5, 7, 9	SCR-D	0.6A, 400V		MAC97B6, MAC97A6, MAC97-G, MAC97-6			
L401E3	TCE	1A, 400V, 0.003A, 2V	B-36			 图 B-36	
L401E5	TCE	1A, 400V, 0.005A, 2V	B-36				
L401E7	TCE	1A, 400V, 0.01A, 2V	B-36				
L401E9	TCE	1A, 400V, 0.025A, 2V	B-36				
L411, 412	GTN	SCB 20A, 0.04A, 2.5V	H-31			 图 C-20	
L421, 422	GTN	SCB 20A, 0.04A, 2.5V	H-31				
L431, 432	GTN	SCB 20A, 0.04A, 2.5V	H-31				
L441, 442	GTN	SCB 20A, 0.04A, 2.5V	H-31				
L451	GTN	SCB 20A, 0.04A, 2.5V	H-31				
L452	GTN	SCB 20A, 0.04A, 2.5V	C-20				
L461	GTN	SCB 20A, 0.04A, 2.5V	H-31				
L462	GTN	SCB 20A, 0.04A, 2.5V	C-20				
L471	GTN	SCB 20A, 0.04A, 2.5V	H-31				
L472	GTN	SCB 20A, 0.04A, 2.5V	C-20				
L481	GTN	SCB 20A, 0.04A, 2.5V	H-31				
L482	GTN	SCB 20A, 0.04A, 2.5V	C-20				
L491	GTN	SCB 20A, 0.04A, 2.5V	H-31				
L492	GTN	SCB 20A, 0.04A, 2.5V	C-20				
L811A	GES	LAS 1.6A, 100V, 220 μA, 0.8V	C-86				 图 C-86
L811B	GES	LAS 1.6A, 200V, 220 μA, 0.8V	C-86				
L811F	GES	LAS 1.6A, 50V, 220 μA, 0.8V	C-86				

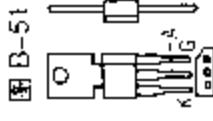
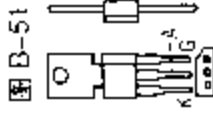
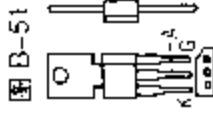
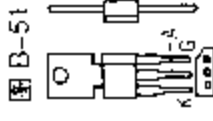
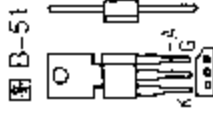
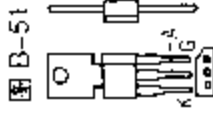
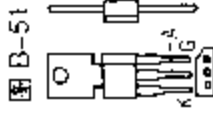
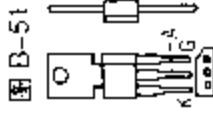
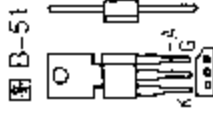
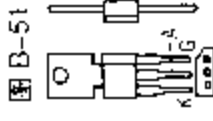
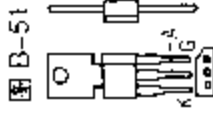
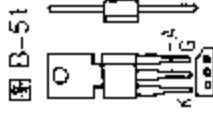
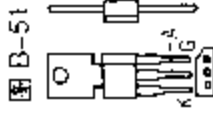
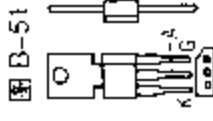
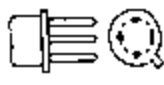



器件型号 Element type	厂名 Manufacturers	材料用途参数 Material Purpose Parameter	图号 Figure	国内外相似替换器件型号 Replace of similar type	备注 Notes	外形参考图 Reference shape
L811G	GES	LAS 1.6A, 150V, 220 μ A, 0.8V	C-86			
L811U	GES	LAS 1.6A, 25V, 220 μ A, 0.8V	C-86			
L911A	GES	LAS 1.6A, 100V, 220 μ A, 0.8V	C-86			
L911B	GES	LAS 1.6A, 200V, 220 μ A, 0.8V	C-86			
L911F	GES	LAS 1.6A, 50V, 220 μ A, 0.8V	C-86			
L911G	GES	LAS 1.6A, 150V, 220 μ A, 0.8V	C-86			
L911U	GES	LAS 1.6A, 25V, 220 μ A, 0.8V	C-86			
L2001F31		SCR-D 2.5A, 200V				
L2001F32	TCE	1.6A, 200V, 0.003A, 2V	B-89			
L2001F51	TCE	2.5A, 200V	B-89			
L2001F52	TCE	1.6A, 200V, 0.005A, 2V	B-89			
L2001F71	TCE	2.5A, 200V	B-89			
L2001F72	TCE	1.6A, 200V, 0.01A, 2V	B-89			
L2001F91	TCE	3A, 200V	B-89			
L2001F92	TCE	1.6A, 200V, 0.025A, 2V	B-89			
L2001L3	TCE	SCR-D 1.6A, 200V, 0.003A, 2.5V		ECC5638, 2N6071		
L2001L5	TCE	SCR-D 1.6A, 200V, 0.005A, 2.5V		ECC5638, T2323B		
L2001L7	TCE	SCR-D 1.6A, 200V, 0.01A, 2.5V		ECC5638, T2323B		
L2001L9	TCE	SCR-D 1.6A, 200V, 0.025A, 2.5V		ECC5638, T2323B		
L2001M3, M5, M7		SCR-D 2.5A, 200V				
L2001M9		SCR-D 3A, 200V				
L2003M3	TCE	SCR-D 3A, 200V, 0.003A, 2V	B-51			
L2003M5	TCE	SCR-D 3A, 200V, 0.005A, 2V	B-51			
L2003M7	TCE	SCR-D 3A, 200V, 0.01A, 2V	B-51			
L2003M9	TCE	SCR-D 3A, 200V	B-51			
L2004F31, 51	TCE	SCR-D 4A, 200V, 0.003A, 2V	B-81	ECC5629		
L2004F71	TCE	SCR-D 1.6A, 200V, 0.01A, 2V	B-89	ECC5629		

器件型号 Element type	厂名 Manufacturers	材料用途参数 Material Purpose Parameter	图号 Figure	国内外相似替换器件型号 Replace of similar type	备注 Notes	外形参考图 Reference shape
L2004F91	TCE	SCR-D 1.6A, 200V, 0.025A, 2V	B-89	ECG5629		 图 B-89
L2004L3	TCE	SCR-D 4A, 200V, 0.003A, 2V	B-91			
L2004L5	TCE	SCR-D 4A, 200V, 0.005A, 2V	B-91			
L2004L7	TCE	SCR-D 4A, 200V, 0.01A, 2V	B-91			
L2004L9	TCE	SCR-D 4A, 200V, 0.025A, 2V	B-91			
L2006L6	TCE	SCR-D 6A, 200V, 0.005A, 2V	B-91			
L2006L7	TCE	SCR-D 6A, 200V, 0.01A, 2V	B-91			
L2006L9	TCE	SCR-D 6A, 200V, 0.025A, 2V	B-91			
L2008L6	TCE	SCR-D 8A, 200V, 0.005A, 2V	B-9	MAC228A4		
L2008L7	TCE	SCR-D 8A, 200V, 0.01A, 2V	B-91	MAC228A4		 图 B-91
L2008L9	TCE	SCR-D 8A, 200V, 0.025A, 2V	B-91	MAC228A4		
L4001F32	TCE	1.6A, 400V, 0.003A, 2V	B-89			
L4001F51	TCE	2.5A, 400V	B-89			
L4001F52	TCE	1.6A, 400V, 0.005A, 2V	B-89			
L4001F71	TCE	2.5A, 400V	B-89			
L4001F72	TCE	1.6A, 400V, 0.01A, 2V	B-89			
L4001F91	TCE	3A, 400V	B-89			
L4001F92	TCE	1.6A, 400V, 0.025A, 2V	B-89			 图 B-9
L4001L3	TCE	1.6A, 400V, 0.003A, 2.5V				
L4001L5	TCE	1.6A, 400V, 0.005A, 2.5V				
L4001L7	TCE	1.6A, 400V, 0.01A, 2.5V				
L4001L9	TCE	1.6A, 400V, 0.025A, 2.5V				 图 B-51
L4001M5, M7		SCR-D 2.5A, 400V				
L4001M9		SCR-D 3A, 400V				
L4003M3	TCE	3A, 400V, 0.003A, 2V	B-51			

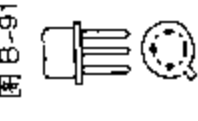
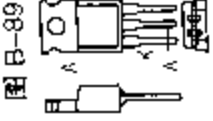
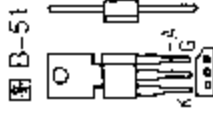

器件型号 Element type	厂名 Manufacturers	材料用途参数 Material Purpose Parameter	图号 Figure	国内外相似替换器件型号 Replace of similar type	备注 Notes	外形参考图 Reference shape
L4003M5	TCE	3A, 400V, 0.005A, 2V	B-51			
L4003M7	TCE	3A, 400V, 0.01A, 2V	B-51			
L4003M9	TCE	3A, 400V, 0.025A, 2V	B-51			
L4004F31	TCE	SCR-D 1.6A, 400V, 0.003A, 2V	B-89	ECG5629		
L4004F51	TCE	SCR-D 1.6A, 400V, 0.005A, 2V	B-89	ECG5629		
L4004F71	TCE	SCR-D 1.6A, 400V, 0.01A, 2V	B-89	ECG5629		
L4004F91	TCE	SCR-D 1.6A, 400V, 0.025A, 2V	B-89	ECG5629		
L4004L3	TCE	SCR-D 4A, 400V, 0.003A, 2V	B-91			
L4004L5	TCE	SCR-D 4A, 400V, 0.005A, 2V	B-91			
L4004L7	TCE	SCR-D 4A, 400V, 0.01A, 2V	B-91			
L4004L9	TCE	SCR-D 4A, 400V, 0.025A, 2V	B-91			
L4006L6	TCE	SCR-D 6A, 400V, 0.005A, 2V	B-91			
L4006L7	TCE	SCR-D 10A, 400V	B-91			
L4006L9	TCE	SCR-D 6A, 400V, 0.025A, 2V	B-91			
L4008L6	TCE	SCR-D 8A, 400V, 0.005A, 2V	B-91			
L4008L7	TCE	SCR-D 8A, 400V, 0.01A, 2V	B-91			
L4008L9	TCE	SCR-D 8A, 400V	B-91			
LASCS	GES	LAS 0.175A, 40V, 10 μ A, 1V	B-55			
LC201B3	TCE	1.6A, 200V, 0.003A, 2V	A-10			
LC201B5	TCE	1.6A, 200V, 0.005A, 2V	A-10			
LC201B7	TCE	1.6A, 200V, 0.01A, 2V	A-10			
LC201B9	TCE	1.6A, 200V, 0.025A, 2V	A-10			
LC204C3	TCE	4A, 200V, 0.003A, 2V	A-10			
LC204C5	TCE	4A, 200V, 0.005A, 2V	A-10			
LC204C7	TCE	4A, 200V, 0.01A, 2V	A-10			
LC204C9	TCE	4A, 200V, 0.025A, 2V	A-10			



器件型号 Element type	厂名 Manufacturers	材料 Material	用途 Purpose	参数 Parameter	图号 Figure	国内外相似替换器件型号 Replace of similar type	备注 Notes	外形参考图 Reference shape	
LC401B3	TCE			1.6A, 400V, 0.01A, 2V	A-10			 图 A-10	
LC401B5	TCE			1.6A, 400V, 0.005A, 2V	A-10				
LC401B7	TCE			1.6A, 400V, 0.01A, 2V	A-10				
LC401B9	TCE			1.6A, 400V, 0.025A, 2V	A-10				
LC404C3	TCE			4A, 400V, 0.003A, 2V	A-10				
LC404C5	TCE			4A, 400V, 0.005A, 2V	A-10				
LC404C7	TCE			4A, 400V, 0.01A, 2V	A-10				
LC404C9	TCE			4A, 400V, 0.025A, 2V	A-10				



K~L 类外形参考图索引



图 A-10



图 B-9



图 B-36

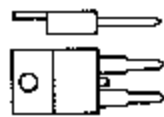

图 B-51

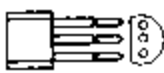

图 B-55



图 B-68



图 B-75

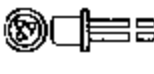

图 B-76



图 B-89

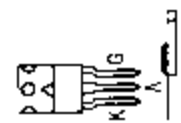

图 B-91

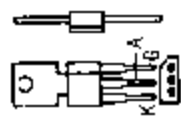

图 C-20

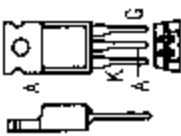

图 C-86

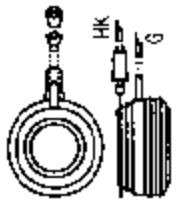

图 D-9

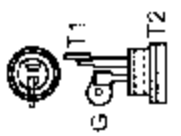

图 E-8

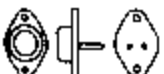

图 F-1







图 F-27

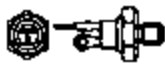
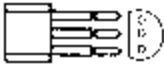
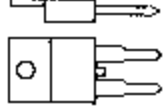

图 H-31

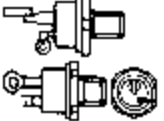

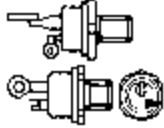
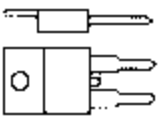
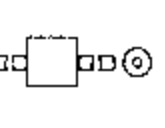
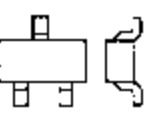
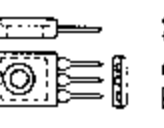
器件型号 Element type	厂名 Manufacturers	材料用途参数 Material Purpose Parameter	图号 Figure	国内外相似替换器件型号 Replace of similar type	备注 Notes	外形参考图 Reference shape
M4C77-7	SCR-D	4A, 600V		2N6075		 图 B-36
M21C	MAT	0.2A, 200V, 0.001A, 0.8V	B-36	BRX45...BRX56, BRY55-200, ECC5404		
M21CA	MAT	0.2A, 400V, 0.001A, 0.8V	B-36	BRX45...BRX56, BRY55-400		
M23C	MAT	2A, 200V, 0.001A, 0.8V	B-9	C106B, C107B, SK3504, SK5508, TAG107-200		
M23CA	MAT	2A, 400V, 0.001A, 0.8V	B-9	C106D, C107D, TAG106-400, TAG107-400		
M1713DP	TAG	9A, 400V, 0.05A, 2V	F-47	2N5170		
M1713MP	TAG	9A, 600V, 0.05A, 2V	F-47	2N5171		 图 B-9
M1713NP	TAG	9A, 800V, 0.05A, 2V	F-48			
M1713PP	TAG	9A, 100V, 0.05A, 2V	F-48			
M2513DP	TAG	14A, 400V, 0.05A, 2V	F-47	2N688		
M2513MP	TAG	14A, 600V, 0.05A, 2V	F-47	2N690		
M2513NP	TAG	14A, 800V, 0.05A, 2V	F-47	2N692		 图 F-47
M2513PP	TAG	14A, 100V, 0.05A, 2V	F-48			
M3013DP	TAG	16A, 400V, 0.05A, 2V	F-48			
M3013MP	TAG	16A, 600V, 0.05A, 2V	F-48			
M3013NP	TAG	16A, 800V, 0.05A, 2V	F-48			
M3013PP	TAG	16A, 100V, 0.05A, 2V	F-48			
M3015DP		35A, 400V	B-36	C228D		 图 F-48
M3015MP		35A, 600V	B-36	C228M		
M4013NP	TAG	24A, 800V, 0.05A, 2V	F-47	MCR64-10		
M4013PP	TAG	24A, 100V, 0.05A, 2V	F-48			
M4013VP	TAG	24A, 120V, 0.05A, 2V	F-48			



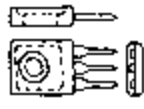
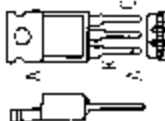

器件型号 Element type	厂名 Manufacturers	材料用途参数 Materials Purpose Parameter	图号 Figure	国内外相似替换器件型号 Replace of similar type	备注 Notes	外形参考图 Reference shape
MA013ZP	IAG	24A, 140V, 0.05A, 2V	F-48			 图 F-48
MA12D		Triac 12A, 400V	B-9			 图 B-9
MA12M		Triac 12A, 600V	B-9			
MA12N		Triac 12A, 800V	B-9			
MA15D		Triac 15A, 400V	B-9			
MA15M		Triac 15A, 600V	B-9			
MA15N		Triac 15A, 800V	B-9			
MA16D		Triac 15A, 400V	B-9			 图 B-9
MA16M		Triac 15A, 600V	B-9			
MA16N		Triac 15A, 800V	B-9			
MA52	MAT	DAC 2A, 28V, 4V	A-5	ECG6408		 图 A-5
MAC08BT1		Triac 0.8A, 200V	G-1			 图 G-1
MAC08DT1		Triac 0.8A, 400V	G-1			
MAC08MT1		Triac 0.8A, 600V	G-1			
MAC8D		Triac 8A, 400V	B-9			
MAC8M		Triac 8A, 600V	B-9			
MAC8N		Triac 8A, 800V	B-9			
MAC9D		Triac 8A, 400V	B-9			
MAC9M		Triac 8A, 600V	B-9			
MAC9N		Triac 8A, 800V	B-9			
MAC10-1		Triac 10A, 25V, 0.075A	B-82	BTA22B, TAG250-100, TAG251-100		 图 B-82
MAC10-2		Triac 10A, 50V, 0.075A	B-82	BTA22B, TAG250-100, TAG251-100		
MAC10-3		Triac 10A, 100V, 0.075A	B-82	BTA22B, TAG250-100, TAG251-100		
MAC10-4		SCR-D 10A, 200V, 0.075A	B-82	BTA22B, TAG250-200, TAG251-200, 2N6151		
MAC10-5		Triac 10A, 300V, 0.075A	B-82	BTA22C, TAG250-300, TAG251-300		

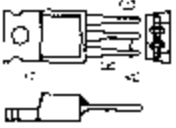
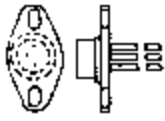
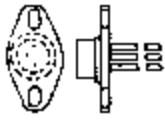
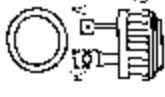

器件型号 Element type	厂名 Manufacturers	材料用途参数 Material Purpose Parameter	图号 Figure	国内外相似替换器件型号 Replace of similar type	备注 Notes	外形参考图 Reference shape	
MAC10-6		SCR-D 10A, 400V, 0.075A	B-82	BTA22D, TAG250-400, TAG251-400, 2N6152		 <p>图 B-82</p>	
MAC10-7		Triac 10A, 500V, 0.075A	B-82	BTA22E, TAG250-500, TAG251-500			
MAC10-8		SCR-D 10A, 600V, 0.075A	B-82	BTA22M, TAG250-600, TAG251-600, 2N6153			
MAC11-1		Triac 10A, 25V, 0.05A	B-82	BTA22B, TAG250-100, TAG251-100			
MAC11-2		Triac 10A, 50V, 0.05A	B-82	BTA22B, TAG250-100, TAG251-100			
MAC11-3		Triac 10A, 100V, 0.05A	B-82	BTA22B, TAG250-100, TAG251-100			
MAC11-4		SCR-D 10A, 200V, 0.05A	B-82	BTA22B, TAG250-200, TAG251-200, 2N6154			
MAC11-5		Triac 10A, 300V, 0.05A	B-82	BTA22C, TAG250-300, TAG251-300			
MAC11-6		SCR-D 10A, 400V, 0.05A	B-82	BTA22D, TAG250-400, TAG251-400, 2N6155			
MAC11-7		Triac 10A, 500V, 0.05A	B-82	BTA22E, TAG250-500, TAG251-500			
MAC11-8		SCR-D 10A, 600V, 0.05A	B-82	BTA22M, TAG250-600, TAG251-600, 2N6156			
MAC15-4	MOT, RCA	SCR-D 15A, 200V, 0.05A, 2V	B-91	ECG56004, Q2015L5, SK3658, SK56004, TAG280-200, TIC246B, TXE10L20			 <p>图 B-91</p>
MAC15-6	MOT, RCA	SCR-D 15A, 400V, 0.05A, 2V	B-91	BT139-500, ECG56006, Q4015L5, SK3659, SK56006, TAG280-400, TIC246D, TXE10L40			
MAC15-8	MOT, RCA	SCR-D 15A, 600V, 0.05A, 2V	B-91	BT139-600, ECG56006, Q6015L5, SK3660, SK56008, TAG280-600, TIC246M, TXE10L60			
MAC15-9		SCR-D 15A, 80V	B-9				
MAC15-10	MOI	SCR-D 15A, 800V, 0.05A, 2V	B-9	BT139-800, Q8015L5, ECG56010, TIC246N, TXE10L80			
MAC15A-4...10		Triac =MAC15-4...10: 0.075A	B-91				
MAC15A-FP		Triac =MAC15A...: Iso					
MAC16-4		15A, 200V, 0.1A, 2V	B-91				
MAC16-6		15A, 400V, 0.1A, 2V	B-91				
MAC16-8		15A, 600V, 0.1A, 2V	B-91				
MAC16-10		15A, 800V, 0.1A, 2V	B-91				





器件型号 Element type	厂名 Manufacturers	材料用途参数 Material Purpose Parameter	图号 Figure	国内外相似替换器件型号 Replace of similar type	备注 Notes	外形参考图 Reference shape	
MAC19-4		8A, 200V, 0.1A, 2V	B-91			 图 B-91	
MAC19-6		8A, 400V, 0.1A, 2V	B-91				
MAC19-8		8A, 600V, 0.1A, 2V	B-91				
MAC19-10		8A, 800V, 0.1A, 2V	B-91				
MAC20-4	MOT	SCR-D 15A, 200V, 0.05A, 2V	D-33	MAC25(A)-4		 图 D-33	
MAC20-5	MOT	SCR-D 15A, 300V, 0.05A, 2V	D-33	MAC25(A)-5			
MAC20-6	MOT	SCR-D 15A, 400V, 0.05A, 2V	D-33	MAC25(A)-6			
MAC20-7	MOT	SCR-D 15A, 500V, 0.05A, 2V	D-33	MAC25(A)-7			
MAC20-8	MOT	SCR-D 15A, 600V, 0.05A, 2V	D-33	MAC25(A)-8			
MAC20-9	MOT	SCR-D 15A, 700V, 0.05A, 2V	D-33	MAC25(A)-9			
MAC20-10	MOT	SCR-D 15A, 800V, 0.05A, 2V	D-33	MAC25(A)-10			
MAC20A-4...10		Triac =MAC20-4...10: 0.075A	D-33	MAC25A-...			
MAC25-4...10		Triac 25A, 200-800V, 0.07A	D-33	MAC50-...			 图 D-33
MAC25A-4...10		Triac =MAC25-4...10: 0.1A	D-33	MAC50A-...			
MAC35-1	MOT	SCR-D 25A, 25V, 0.01A, 3V	C-85	ECG5688, Q2025G, T6401B, 2N6157		 图 C-85	
MAC35-2	MOT	SCR-D 25A, 50V, 0.01A, 3V	C-85	ECG5688, Q2025G, T6401B, 2N6157			
MAC35-3	MOT	SCR-D 25A, 100V, 0.01A, 3V	C-85	ECG5688, Q2025G, T6401B, 2N6157			
MAC35-4		SCR-D 30A, 200V					
MAC35-5	MOT	SCR-D 25A, 300V, 0.01A, 3V	C-85	ECG5688, T6401D, 2N6158			
MAC35-6		SCR-D 30A, 400V					
MAC35-7	MOT	SCR-D 25A, 500V, 0.01A, 3V	C-85	ECG5690, T6401M, 2N6159			
MAC35-8	MOT	SCR-D 25A, 600V, 0.01A, 3V	C-85	ECG5690, 2N6159			
MAC35-10	MOT	SCR-D 25A, 800V, 0.01A, 3V	C-85				
MAC36-1	MOT	25A, 25V, 0.1A, 3V	F-47	Q2025H, SK3521, SK5686, T6411B, 2N6160			 图 F-47
MAC36-1#	ASI	25A, 25V, 0.1A, 3V	F-47	ECG5681			
MAC36-2	MOT	SCR-D 25A, 50V, 0.1A, 3V	F-47	Q2025H, SK3521, SK5686, T6411B, 2N6160			
MAC36-2#	ASI	25A, 50V, 0.1A, 3V	F-47	ECG5681			

器件型号 Element type	厂名 Manufacturers	材料用途参数 Material Purpose Parameter	图号 Figure	国内外相似替换器件型号 Replace of similarity type	备注 Notes	外形参考图 Reference shape
MAC36-3	MOT	SCR-D 25A, 100V, 0.1A, 3V	F-47	Q2025H, SK3521, SK5686, T6411B, 2N6160		 图 F-47
MAC36-3#	ASI	25A, 100V, 0.1A, 3V	F-47	ECG5682		
MAC36-4		SCR-D 30A, 200V				
MAC36-5	MOT	SCR-D 25A, 300V, 0.1A, 3V	F-47	ECG5685, SK3521, SK5686, T6411B, 2N6161		
MAC36-5#	ASI	25A, 300V, 0.1A, 3V	F-47			
MAC36-6		SCR-D 30A, 400V				
MAC36-7	MOT	SCR-D 25A, 500V, 0.1A, 3V	F-47	ECG5687, SK3521, SK5686, T6411M, 2N6162		
MAC36-7#	ASI	25A, 500V, 0.1A, 3V	F-47			
MAC36-8	MOT	SCR-D 25A, 600V, 0.1A, 3V	F-47	2N6162		
MAC36-8#	ASI	25A, 600V, 0.1A, 3V	F-47			
MAC36-10	MOT	25A, 800V, 0.1A, 3V	F-47			 图 C-85
MAC36-10#	ASI	25A, 800V, 0.1A, 3V	F-47			
MAC37-1	MOT	SCR-D 25A, 25V, 0.075A, 3V	C-85	ECG5688, Q2025G, T6401B, 2N6157		
MAC37-2	MOT	SCR-D 25A, 50V, 0.075A, 3V	C-85	ECG5688, Q2025G, T6401B, 2N6157		
MAC37-3	MOT	SCR-D 25A, 100V, 0.075A, 3V	C-85	ECG5688, Q2025G, T6401B, 2N6157		
MAC37-4	MOT	SCR-D 25A, 200V, 0.075A, 3V	C-85	ECG5688, Q2025G, T6401B, 2N6157		
MAC37-5	MOT	SCR-D 25A, 300V, 0.075A, 3V	C-85	ECG5689, Q4025G, T6401D, 2N6158		
MAC37-6	MOT	SCR-D 25A, 400V, 0.075A, 3V	C-85	ECG5689, Q4025G, T6401D, 2N6158		
MAC37-7	MOT	SCR-D 25A, 500V, 0.075A, 3V	C-85	ECG5690, Q5025G, T6401M, 2N6159		
MAC37-8		SCR-D 30A, 600V, 0.075A		2N6159		
MAC38-1	MOT	SCR-D 25A, 25V, 0.075A, 3V	F-21	Q2025H, T6411B, 2N6160		 图 F-21
MAC38-1#	ASI	25A, 25V, 0.075A, 3V	F-21			
MAC38-2	MOT	SCR-D 25A, 50V, 0.075A, 3V	F-21	Q2025H, T6411B, 2N6160		
MAC38-2#	ASI	25A, 50V, 0.075A, 3V	F-21			
MAC38-3	MOT	SCR-D 25A, 100V, 0.075A, 3V	F-21	Q2025H, T6411B, 2N6160		
MAC38-3#	ASI	25A, 100V, 0.075A, 3V	F-21			
MAC38-4	MOT	SCR-D 25A, 200V, 0.075A, 3V	F-21	Q2025H, T6411B, 2N6160		
MAC38-4#	ASI	25A, 200V, 0.075A, 3V	F-21			
MAC38-5	MOT	SCR-D 25A, 300V, 0.075A, 3V	F-21	Q4025H, T6411D, 2N6161		

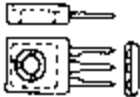

器件型号 Element type	厂名 Manufacturers	材料用途参数 Material Purpose Parameter	图号 Figure	国内外相似替换器件型号 Replace of similar type	备注 Notes	外形参考图 Reference shape	
MAC38-5#	ASI	25A, 300V, 0.075A, 3V	F-21			 图 F-21	
MAC38-6	MOT	SCR-D 25A, 400V, 0.075A, 3V	F-21	Q4025H, T6411D, 2N6161			
MAC38-6#	ASI	25A, 400V, 0.075A, 3V	F-21				
MAC38-7	MOT	SCR-D 25A, 500V, 0.075A, 3V	F-21	Q5025H, T6411M, 2N6162			
MAC38-7#	ASI	25A, 500V, 0.075A, 3V	F-21				
MAC38-8		SCR-D 3A, 600V, 0.075A	F-21	2N6162			
MAC50-4	MOT	SCR-D 40A, 200V, 0.07A, 2V	D-33	TAG740-200, TAG741-200			
MAC50-5	MOT	SCR-D 40A, 300V, 0.07A, 2V	D-33	TAG740-300, TAG741-300			
MAC50-6	MOT	SCR-D 40A, 400V, 0.07A, 2V	D-33	TAG740-400, TAG741-400			
MAC50-7	MOT	SCR-D 40A, 500V, 0.07A, 2V	D-33	TAG740-500, TAG741-500			
MAC50-8	MOT	SCR-D 40A, 600V, 0.07A, 2V	D-33	TAG740-600, TAG741-600			
MAC50-9	MOT	SCR-D 40A, 700V, 0.07A, 2V	D-33	TAG740-700, TAG741-700			
MAC50-10	MOT	SCR-D 40A, 800V, 0.07A, 2V	D-33	TAG740-800, TAG741-800			
MAC50A-4	MOT	SCR-D 40A, 200V, 0.1A, 2.5V	D-33	TAG740-200, TAG741-200		 图 D-33	
MAC50A-5	MOT	SCR-D 40A, 300V, 0.1A, 2.5V	D-33	TAG740-300, TAG741-300			
MAC50A-6	MOT	SCR-D 40A, 400V, 0.1A, 2.5V	D-33	TAG740-400, TAG741-400			
MAC50A-7	MOT	SCR-D 40A, 500V, 0.1A, 2.5V	D-33	TAG740-500, TAG741-500			
MAC50A-8		SCR-D 40A, 600V, 0.1A, 0.075A		TAG740-600, TAG741-600			
MAC50A-9	MOT	SCR-D 40A, 700V, 0.1A, 2.5V	D-33	TAG740-700, TAG741-700			
MAC50A-10	MOT	SCR-D 40A, 800V, 0.1A, 2.5V	D-33	TAG740-800, TAG741-800			
MAC77-1		Triac 4A, 25V, 0.03A	D-83	BT158/400, TAG220-100, TAG231-200			 图 B-83
MAC77-2		SCR-D 4A, 50V, 0.03A	B-83	BT158/400, TAG220-100, TAG231-200, 2N6069			
MAC77-3		SCR-D 4A, 100V, 0.03A	B-83	BT158/400, TAG220-100, TAG231-200, 2N6070			
MAC77-4		SCR-D 4A, 200V, 0.03A	B-83	BT158/400, TAG220-200, TAG231-200, 2N6071			
MAC77-5		SCR-D 4A, 300V, 0.03A	B-83	BT158/400, TAG220-300, TAG231-400, 2N6072			
MAC77-6		SCR-D 4A, 400V, 0.03A	B-83	BT158/400, TAG220-400, TAG231-400, 2N6073			
MAC77-7		SCR-D 4A, 500V, 0.03A	B-83	BT158/600, TAG220-500, TAG231-600, 2N6074			

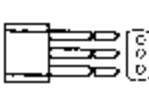
器件型号 Element type	名称 Manufacturers	材料用途参数 Material Purpose Parameter	图号 Figure	国内外相似替换器件型号 Replace of similar type	备注 Notes	外形参考图 Reference shape
MAC77-8	SCR-D	4A, 600V, 0.03A	B-83	BT158-600, TAG220-600, TAG231-600, 2N6075		 图 B-83
MAC80-6	MOT	SCR-D 40A, 400V, 0.08A, 2.5V	F-57			
MAC80-8	MOT	SCR-D 40A, 600V, 0.08A, 2.5V	F-57			
MAC81-6	MOT	SCR-D 30A, 400V, 0.08A, 2.5V	F-57			
MAC81-8	MOT	SCR-D 30A, 600V, 0.08A, 2.5V	F-57			
MAC91-1	MOT	SCR-D 0.6A, 30V, 0.01A, 2.5V	B-36	MAC94-1, MAC94A-1, Z0106B		
MAC91-2	MOT	SCR D 0.6A, 60V, 0.01A, 2.5V	B-36	MAC94-2, MAC94A-2, Z0106B		
MAC91-3	MOT	SCR-D 0.6A, 100V, 0.01A, 2.5V	B-36	MAC94-3, MAC94A-3, Z0106B		
MAC91-4	MOT	SCR D 0.6A, 200V, 0.01A, 2.5V	B-36	MAC94-4, MAC94A-4, Z0106B		
MAC91-5	MOT	SCR-D 0.6A, 300V, 0.01A, 2.5V	B-36	MAC94-5, MAC94A-5, Z0106D		
MAC91-6	MOT	SCR-D 0.6A, 400V, 0.01A, 2.5V	B-36	MAC94-6, MAC94A-6, Z0106D		
MAC91-7	MOT	SCR-D 0.6A, 500V, 0.01A, 2.5V	B-36	MAC94-7, MAC94A-7, Z0106M		 图 F-57
MAC91-8	MOT	SCR-D 0.6A, 600V, 0.01A, 2.5V	B-36	MAC94-8, MAC94A-8, Z0106M		
MAC91A-1	MOT	SCR-D 0.8A, 30V, 0.01A, 2V	B-36	MAC94A-1, Z0106BA, Z0106BB		
MAC91A-2	MOT	SCR-D 0.8A, 60V, 0.01A, 2V	B-36	MAC94A-2, Z0106BA, Z0106BB		
MAC91A-3	MOT	SCR-D 0.8A, 100V, 0.01A, 2V	B-36	MAC94A-3, Z0106BA, Z0106BB		
MAC91A-4	MOT	SCR-D 0.8A, 200V, 0.01A, 2V	B-36	MAC94A-4, Z0106BA, Z0106BB		
MAC91A-5	MOT	SCR-D 0.8A, 300V, 0.01A, 2V	B-36	MAC94A-5, Z0106DA, Z0106DB		
MAC91A-6	MOT	SCR-D 0.8A, 400V, 0.01A, 2V	B-36	MAC94A-6, Z0106DA, Z0106DB		
MAC91A-7	MOT	SCR-D 0.8A, 500V, 0.01A, 2V	B-36	MAC94A-7, Z0106MA, Z0106MB		
MAC91A-8	MOT	SCR-D 0.8A, 600V, 0.01A, 2V	B-36	MAC94A-8, Z0106MA, Z0106MB		 图 B-36
MAC92-1...8	Triac	=MAC91-1...8; 0.005A	B-36	MAC95-...; Z0104...		
MAC92A-1...8	SCR-D	=MAC91-1...8; 0.005A	B-35	MAC95A ...		
MAC93-1...8	SCR-D	=MAC91-1...8; 0.003A	B-35	MAC96-...; Z0101...		
MAC93A-1...8	SCR-D	=MAC91-1...8; 0.003A	B-35	MAC98A-...		
MAC94-1...8	SCR-D	=MAC91-1...8; 0.8A	B-35	Z0106...		
MAC94A-1...8	SCR-D	=MAC91A-1...8; 0.8A	B-35	Z0106...		

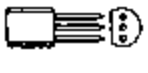
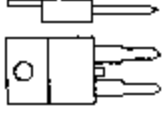

器件型号 Element type	厂名 Manufacturers	材料用途参数 Material Purpose Parameter	图号 Figure	国内外相似替换器件型号 Replace of similar type	备注 Notes	外形参考图 Reference shape
MAC95-1...8	SCR-D	=MAC92-1...8; 0.8A	B-35	Z0101...		 图 B-35
MAC95A-1...8	SCR-D	=MAC92A-1...8; 0.8A	B-35	T2301P..., T2327..., TXC18D..., Z0405...		
MAC96-1...8	SCR-D	=MAC93-1...8; 0.8A	B-35	Z0101...		
MAC96A-1...8	SCR-D	0.8A, 30V, 0.003A, 0.01A	B-35	T2300P..., T2320..., Z0402...		
MAC97-1	SCR-D	0.6A, 30V				
MAC97-2	SCR-D	0.6A, 60V, 0.01A, 2V				
MAC97-3	SCR-D	0.6A, 100V, 0.01A, 2V				
MAC97-4	SCR-D	0.6A, 200V, 0.01A, 2V				
MAC97-6	SCR-D	0.6A, 400V, 0.01A, 2V				
MAC97-7	SCR-D	0.6A, 500V, 0.01A, 2V				
MAC97-8	SCR-D	0.6A, 600V, 0.01A, 2V				
MAC97A1	SCR-D	0.6A, 30V				 图 B-9
MAC97A2	SCR-D	0.6A, 60V, 0.005A, 2V				
MAC97A3	SCR-D	0.6A, 100V, 0.005A, 2V				
MAC97A4	SCR-D	0.6A, 200V, 0.005A, 2V				
MAC97A6	SCR-D	0.6A, 400V, 0.005A, 2V				
MAC97A7	SCR-D	0.6A, 500V, 0.005A, 2V				
MAC97A8	SCR-D	0.6A, 600V, 0.005A, 2V				
MAC97B1	SCR-D	0.6A, 30V				
MAC97B2	SCR-D	0.6A, 60V, 0.003A, 2V				
MAC97B3	SCR-D	0.6A, 100V, 0.003A, 2V				
MAC97B4	SCR-D	0.6A, 200V, 0.003A, 2V				
MAC97B6	SCR-D	0.6A, 400V, 0.003A, 2V				
MAC97B7	SCR-D	0.6A, 500V, 0.003A, 2V				
MAC97B8	SCR-D	0.6A, 600V, 0.003A, 2V				
MAC137G500	Triac	8A, 500V	B-9			
MAC137G600	Triac	8A, 600V	B-9			
MAC137G700	Triac	8A, 700V	B-9			

器件型号 Element type	厂名 Manufacturers	材料用途参数 Material Purpose Parameter	图号 Figure	国内外相似替换器件型号 Replace of similar type	备注 Notes	外形参考图 Reference shape
MAC137G800	Triac	8A, 800V	B-9			
MAC154	SCR-D	15A, 200V	B-9			
MAC156	SCR-D	15A, 400V	B-9			
MAC158	SCR-D	15A, 600V	B-9			
MAC158-FP	SCR-D	15A, 600V				
MAC210-4	Triac	10A, 200V, 0.05A, 2.5V	B-91			
MAC210-4FP	Triac	10A, 200V				
MAC210-5	SCR-D	10A, 300V				
MAC210-6	SCR-D	10A, 400V, 0.05A, 2.5V	B-91			
MAC210-6FP	Triac	10A, 400V				
MAC210-7	SCR-D	10A, 500V				
MAC210-8	SCR-D	10A, 600V, 0.05A, 2.5V	B-91			
MAC210-8FP	Triac	10A, 600V				
MAC210-9	SCR-D	10A, 700V				
MAC210-10	SCR-D	10A, 800V, 0.05A, 2.5V	B-91			
MAC210-10FP	Triac	10A, 800V				
MAC210A4	SCR-D	10A, 200V, 0.05A, 2V	B-91			
MAC210A4FP	Triac	10A, 200V				
MAC210A5	SCR-D	10A, 300V, 0.05A, 2.5V	B-91			
MAC210A6	SCR-D	10A, 400V, 0.05A, 2V	B-91			
MAC210A6FP	Triac	10A, 400V				
MAC210A7	SCR-D	10A, 500V, 0.05A, 2.5V	B-91			
MAC210A8	SCR-D	10A, 600V, 0.05A, 2V	B-91			
MAC210A8FP	Triac	10A, 600V				
MAC210A9	SCR-D	10A, 700V, 0.05A, 2.5V	B-91			
MAC210A10	SCR-D	10A, 800V, 0.05A, 2V	B-91			
MAC210A10FP	Triac	10A, 800V				



图 B-9



图 D-91

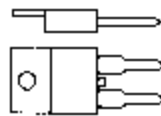

器件型号 Element type	厂名 Manufacturers	材料 用途 参数 Material Purpose Parameter	图号 Figure	国内外相似替换器件型号 Replace of similar type	备注 Notes	外形参考图 Reference shape
MAC212-4	SCR-D	12A, 200V, 0.05A, 2.5V	B-91			 <p>图 B-91</p>
MAC212-4FP	Triac	12A, 200V	B-9			
MAC212-6	SCR-D	12A, 400V, 0.05A, 2.5V	B-91			
MAC212-6FP	Triac	12A, 400V	B-9			
MAC212-8	SCR-D	12A, 600V, 0.05A, 2.5V	B-91			
MAC212-8FP	Triac	12A, 600V	B-9			
MAC212-10	SCR-D	12A, 800V, 0.05A, 2.5V	B-91			
MAC212-10FP	Triac	12A, 800V	B-9			
MAC212A4	SCR-D	12A, 200V, 0.05A, 2V	B-91			
MAC212A4FP	Triac	12A, 200V	B-9			
MAC212A6	SCR-D	12A, 400V, 0.05A, 2V	B-91			
MAC212A6FP	Triac	12A, 400V	B-9			
MAC212A8	SCR-D	12A, 600V, 0.05A, 2V	B-91			
MAC212A8FP	Triac	12A, 600V	B-9			
MAC212A10	SCR-D	12A, 800V, 0.05A, 2V	B-91			
MAC212A10FP	Triac	12A, 800V	B-9			
MAC213-4	SCR-D	12A, 200V, 0.1A, 2V	B-91			 <p>图 B-9</p>
MAC213-6	SCR-D	12A, 400V, 0.1A, 2V	B-91			
MAC213-8	SCR-D	12A, 600V, 0.1A, 2V	B-91			
MAC213-10	SCR-D	12A, 800V, 0.1A, 2V	B-91			
MAC215A4FP		15A, 200V	B-91			
MAC215A6FP		15A, 400V	B-91			
MAC215A8FP		15A, 600V	B-91			
MAC215A10FP		15A, 800V	B-91			
MAC216-4	MOT	6A, 200V, 0.05A, 2.5V	B-91	BTA20C, SC141B, T2801B, TCX10K40M		
MAC216-6	MOT	6A, 400V, 0.05A, 2.5V	B-91	BTA20D, SC141D, T2801D, TCX10K40M		
MAC216-7	MOT	6A, 500V, 0.05A, 2.5V	B-91	BTA20E, SC141E, T2801E, TCX10K50M		
MAC216-8	MOT	6A, 600V, 0.05A, 2.5V	B-91	BTA20M, SC141M, T2801M, TCX10K60M		
MAC216A4	MOT	6A, 200V, 0.07A	B-91	BT137-500, T2800B, T2850B, TAG224-200		

器件型号 Element type	厂名 Manufacturers	材料用途参数 Material Purpose Parameter	图号 Figure	国内外相似替换器件型号 Replace of similar type	备注 Notes	外形参考图 Reference shape
MAC216A6	MOT	6A, 400V, 0.07A	B-91	BT137-500, T2800D, T2850D, TAG224-400		 图 B-91
MAC216A7	MOT	6A, 500V, 0.07A	B-91	BT137-500, T2800E, T2850E, TAG224-500		
MAC216A8	MOT	6A, 600V, 0.07A	B-91	BT137-600, T2800M, T2850M, TAG224-600		
MAC218-4	MOT	SCR-D 8A, 200V, 0.08A, 2.5V	B-91			
MAC218-4FP		Triac 8A, 200V				
MAC218-5	MOT	SCR-D 8A, 300V, 0.08A, 2.5V	B-91			
MAC218-6	MOT	SCR-D 8A, 400V, 0.08A, 2.5V	B-91			
MAC218-6FP		Triac 8A, 400V				
MAC218-7	MOT	SCR-D 8A, 500V, 0.08A, 2.5V	B-89			
MAC218-8	MOT	SCR-D 8A, 600V, 0.08A, 2.5V	B-91			
MAC218-8FP		Triac 8A, 600V				
MAC218-9	MOT	SCR-D 8A, 700V, 0.08A, 2.5V	B-91			
MAC218-10	MOT	SCR-D 8A, 800V, 0.08A, 2.5V	B-91			
MAC218-10FP		Triac 8A, 800V				
MAC218A4	MOT	SCR-D 8A, 200V, 0.06A, 2.5V	B-91			 图 B-89
MAC218A4FP		Triac 8A, 200V				
MAC218A5	MOT	SCR-D 8A, 300V, 0.06A, 2.5V	B-91			
MAC218A6	MOT	SCR-D 8A, 400V, 0.06A, 2.5V	B-91			
MAC218A6FP		Triac 8A, 400V				
MAC218A7	MOT	SCR-D 8A, 500V, 0.06A, 2.5V	B-89			
MAC218A8	MOT	SCR-D 8A, 600V, 0.06A, 2.5V	B-91			
MAC218A8FP		Triac 8A, 600V				
MAC218A9	MOT	SCR-D 8A, 700V, 0.06A, 2.5V	B-91			
MAC218A10	MOT	SCR-D 8A, 800V, 0.06A, 2.5V	B-91			
MAC218A10FP		Triac 8A, 800V				
MAC219-4		8A, 200V, 0.1A, 2V	B-91			
MAC219-6		8A, 400V, 0.1A, 2V	B-91			
MAC219-8		8A, 600V, 0.1A, 2V	B-91			
MAC219-10		8A, 800V, 0.1A, 2V	B-91			

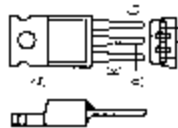
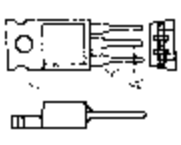
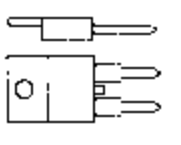
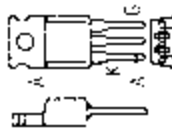
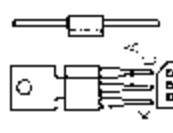

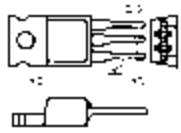
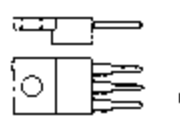
器件型号 Element type	厂名 Manufacturers	材料用途参数 Material Purpose Parameter	图号 Figure	国内外相似替换器件型号 Replace of similar type	备注 Notes	外形参考图 Reference shape	
MAC220-2	ASI, MOT	8A, 50V, 0.05A, 2V	B-91	Q2008L4, BT138-500		 图 B-91	
MAC220-3	ASI, MOT	8A, 100V, 0.05A, 2V	B-91	Q2008L4, BT138-500			
MAC220-5	ASI, MOT	8A, 300V, 0.05A, 2V	B-91	Q4008L4, BT138-500			
MAC220-7	ASI, MOT	8A, 500V, 0.05A, 2V	B-91	Q4008L4, BT138-500			
MAC220-9	ASI, MOT	8A, 700V, 0.05A, 2V	B-91	Q8010L5, BT138-600			
MAC220A-2		Triac	B-11	2N6342(A)			
MAC220A-3		Triac	B-11	2N6342(A)			
MAC220A-5		Triac	B-11	2N6343(A)			
MAC220A-7		Triac	B-11	2N6344(A)			
MAC220A-9		Triac	B-11	2N6345(A)			
MAC221-2	ASI, MOT	8A, 50V, 0.05A, 2V	B-91	Q2008L4, BT138-500			 图 B-11
MAC221-3	ASI, MOT	8A, 100V, 0.05A, 2V	B-91	Q2008L4, BT138-500			
MAC221-5	ASI, MOT	8A, 300V, 0.05A, 2V	B-91	Q4008L4, BT138-500			
MAC221-7	ASI, MOT	8A, 500V, 0.05A, 2V	B-91	Q4008L4, BT138-500			
MAC221-9	ASI, MOT	8A, 700V, 0.05A, 2V	B-91	Q8010L5, BT138-600			
MAC221A-2		Triac	B-11	2N6346(A)			
MAC221A-3		Triac	B-11	2N6346(A)			
MAC221A-5		Triac	B-11	2N6347(A)			
MAC221A-7		Triac	B-11	2N6348(A)			
MAC221A-9		Triac	B-11	2N6349(A)			
MAC222-1		SCR-D	B-11	TIC226A, TW9N400, TXD10K40, 2N6342			
MAC222-2		SCR-D	B-11	TIC226A, TW9N400, TXD10K40, 2N6342			
MAC222-3		SCR-D	B-11	TIC226A, TW9N400, TXD10K40, 2N6342			
MAC222-4		SCR-D	B-11	TIC226B, TW9N400, TXD10K40, 2N6342			
MAC222-5		SCR-D	B-11	TIC226C, TW9N400, TXD10K40, 2N6343			
MAC222-6		SCR-D	B-11	TIC226D, TW9N400, TXD10K40, 2N6343			
MAC222-7		SCR-D	B-11	TIC226E, TW9N500, TXD10K50, 2N6344			
MAC222-8		SCR-D	B-11	TIC226M, TW9N600, TXD10K60, 2N6344			
MAC222-9		SCR-D	B-91	TIC226S, TW9N700, TXD10K70, 2N6345			

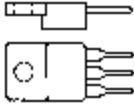
器件型号 Element type	厂名 Manufacturers	材料用途参数 Material Purpose Parameter:	图号 Figure	国内外相似替换器件型号 Replace of similar type	备注 Notes	外形参考图 Reference shape
MAC222 10		SCR-D 8A, 800V, 0.05A, 0.04A	B-11	TIC226N, TW9N800, TXD10K80, 2N6345		 图 B-11
MAC222A-1...10		SCR-D 8A, 25V, 0.75A, 25V	B-11	BT137/..., TAG224-..., TXD10H...		
MAC222A4		SCR-D 8A, 200V, 0.075A, 2.5V	B-91			
MAC222A5		SCR-D 8A, 300V	B-91			
MAC222A6		SCR-D 8A, 400V, 0.075A, 2.5V	B-91			
MAC222A7		SCR-D 8A, 500V	B-91			
MAC222A8		SCR-D 8A, 600V, 0.075A, 2.5V	B-91			
MAC222A9		SCR-D 8A, 700V, 0.075A, 2.5V	B-91			
MAC222A10		SCR-D 8A, 800V	B-91			
MAC223-3		SCR-D 25A, 100V, 0.05A	B-11	TXE10L20		
MAC223 4		SCR-D 25A, 200V, 0.05A	B-91	TXE10L20		
MAC223-5		SCR-D 25A, 300V, 0.05A	B-11	TXE10L40		
MAC223-6		SCR-D 25A, 400V, 0.05A	B-91	TXE10L40		
MAC223-7		SCR-D 25A, 500V, 0.05A	B-91	TXE10L60		
MAC223-8		SCR-D 25A, 600V, 0.05A	B-91	TXE10L60		
MAC223-9		SCR-D 25A, 700V, 0.05A	B-11	TXE10L80		
MAC223-10		SCR-D 25A, 800V, 0.05A	B-91	TXE10L80		
MAC223A-3...10		Triac =MAC223-3...10; 0.075A	B-11			
MAC223A-FP		Triac =MAC223A... : 150				
MAC224-4	MOT	SCR-D 40A, 200V, 0.05A, 2V	B-91			
MAC224-5	MOT	SCR-D 40A, 300V, 0.05A, 2V	B-91			
MAC224-6	MOT	SCR-D 40A, 400V, 0.05A, 2V	B-91			
MAC224-7	MOT	SCR-D 40A, 500V, 0.05A, 2V	B-91			
MAC224-8	MOT	SCR D 40A, 600V, 0.05A, 2V	B-91			
MAC224-9	MOT	SCR-D 40A, 700V, 0.05A, 2V	B-91			
MAC224-10	MOT	SCR-D 40A, 800V, 0.05A, 2V	B-91			
MAC224A4	MOT	SCR-D 40A, 200V, 0.075A, 2.5V	B-91			
MAC224A5	MOT	SCR-D 40A, 300V, 0.075A, 2.5V	B-91			





器件型号 Element type	厂名 Manufacturers	材料用途参数 Material Purpose Parameter	图号 Figure	国内外相似替换器件型号 Replac of similar type	备注 Notes	外形参考图 Reference shape
MAC224A6	MOT	SCR-D 40A, 400V, 0.075A, 2.5V	B-91			 图 B-91
MAC224A7	MOT	SCR-D 40A, 500V, 0.075A, 2.5V	B-91			
MAC224A8	MOT	SCR-D 40A, 600V, 0.075A, 2.5V	B-91			
MAC224A9	MOT	SCR-D 40A, 700V, 0.075A, 2.5V	B-91			
MAC224A10	MOT	SCR-D 40A, 800V, 0.075A, 2.5V	B-91			
MAC228-2		SCR-D 8A, 50V, 0.005A	B-11	TAG227-100, TIC225A		
MAC228-3		SCR-D 8A, 100V, 0.005A	B-11	TAG227-100, TIC225A		
MAC228-4		SCR-D 8A, 200V, 0.005A	B-91	TAG227-200, TIC225B		
MAC228-4FP		Triac 8A, 200V				
MAC228-5		SCR-D 8A, 300V, 0.005A, 0.015A	B-11	TAG227-300, TIC225C		
MAC228-6		SCR-D 8A, 400V, 0.005A	B-91	TAG227-400, TIC225D		
MAC228-6FP		Triac 8A, 400V				
MAC228-7		SCR-D 8A, 500V, 0.005A	B-91	TAG227-500, TIC225E		
MAC228-8		SCR-D 8A, 600V, 0.005A	B-91	TAG227-600, TIC225M		
MAC228-8FP		Triac 8A, 600V				
MAC228-9		SCR-D 8A, 700V, 0.005A, 0.015A	B-11	TAG227-700, TIC225S		
MAC228-10		SCR-D 8A, 800V, 0.005A	B-91	TAG227-800, TIC225N		
MAC228-10FP		Triac 8A, 800V				
MAC228A-2...10		Triac =MAC228-2...10; 0.01A	B-11	TAG226...		
MAC228A4FP		Triac 8A, 200V				
MAC228A6FP		Triac 8A, 400V				
MAC228A8FP		Triac 8A, 600V				
MAC228A10FP		Triac 8A, 800V				
MAC229-4		SCR-D 8A, 200V	B-91			
MAC229-4FP		Triac 8A, 200V				
MAC229-6		SCR-D 8A, 400V				
MAC229-6FP		Triac 8A, 400V				
MAC229-8		SCR-D 8A, 600V	B-91			



图 B-11

器件型号 Element type	厂名 Manufacturers	材料用途参数 Material Purpose Parameter	图号 Figure	国内外相似替换器件型号 Heplace of similar type	备注 Notes	外形参考图 Reference shape
MAC229-8FP	Triac	8A, 600V	B-91			 图 B-31
MAC229-10	SCR-D	8A, 800V	B-91			
MAC229-10FP	Triac	8A, 800V	B-91			
MAC229A4	SCR-D	8A, 200V, 0.01A, 2V	B-91			
MAC229A4FP	Triac	8A, 200V	B-9			
MAC229A6	SCR-D	8A, 400V	B-91			
MAC229A6FP	Triac	8A, 400V	B-91			
MAC229A8	SCR-D	8A, 600V, 0.01A, 2V	B-91			
MAC229A8FP	Triac	8A, 600V	B-91			
MAC229A10	SCR-D	8A, 800V, 0.01A, 2V	B-91			
MAC229A10FP	Triac	8A, 800V	B-91			 图 B-9
MAC231-4		20A, 200V, 0.1A, 2V	B-91			
MAC231-6		20A, 400V, 0.1A, 2V	B-91			
MAC231-8		20A, 600V, 0.1A, 2V	B-91			
MAC231-10		20A, 800V, 0.1A, 2V	B-91			
MAC245B	SCR-D	10A, 200V	F-47			
MAC245D	SCR-D	10A, 400V	F-47			
MAC245M	SCR-D	10A, 600V	F-47			
MAC245N	SCR-D	10A, 800V	F-47			
MAC246B	SCR-D	10A, 200V	F-47			
MAC246D	SCR-D	10A, 400V	F-47			
MAC246M	SCR-D	10A, 600V	F-47			
MAC246N	SCR-D	10A, 800V	F-47			 图 F-47
MAC256B	SCR-D	15A, 200V	F-47			
MAC256B3	SCR-D	15A, 200V	F-57			
MAC256D	SCR-D	15A, 400V	F-47			
						 图 F-57

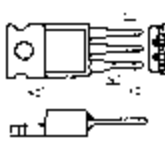
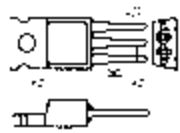
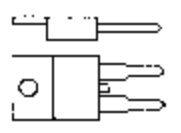
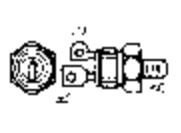
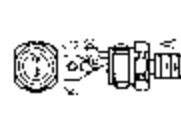

器件型号 Element type	厂名 Manufacturers	材料用途参数 Material Purpose Parameter	图号 Figure	国内外相似替换器件型号 Replace of similar type	备注 Notes	外形参考图 Reference shape
MAC256D3	SCR-D	15A, 400V	F-57			
MAC256M	SCR-D	15A, 600V	F-47			
MAC256M3	SCR-D	15A, 600V	F-57			
MAC256N	SCR-D	15A, 800V	F-47			
MAC256N3	SCR-D	15A, 800V	F-57			
MAC261B	SCR-D	25A, 200V				
MAC261D	SCR-D	25A, 400V				
MAC261M	SCR-D	25A, 600V				
MAC310-4	Triac	10A, 200V, 0.005A, 2.2V	B-91			
MAC310-4FP	Triac	10A, 200V	B-9			
MAC310-6	Triac	10A, 400V, 0.005A, 2.2V	B-91			
MAC310-6FP	Triac	10A, 400V	B-9			
MAC310-8	Triac	10A, 600V, 0.005A, 2.2V	B-91			
MAC310-8FP	Triac	10A, 600V	B-9			
MAC310-10	Triac	10A, 800V, 0.005A, 2.2V	B-91			
MAC310-10FP	Triac	10A, 800V	B-9			
MAC310A4	Triac	10A, 200V, 0.01A, 2.5V	B-91			
MAC310A4FP	Triac	10A, 200V	B-9			
MAC310A6	Triac	10A, 400V, 0.01A, 2.5V	B-91			
MAC310A6FP	Triac	10A, 400V	B-9			
MAC310A8	Triac	10A, 600V, 0.01A, 2.5V	B-91			
MAC310A8FP	Triac	10A, 600V	B-9			
MAC310A10	Triac	10A, 800V, 0.01A, 2.5V	B-91			
MAC310A10FP	Triac	10A, 800V	B-9			
MAC320-4	SCR-D	20A, 200V				
MAC320-6	SCR-D	20A, 400V				



图 F-57



图 F-47

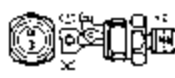

图 B-91







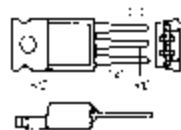



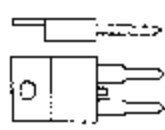
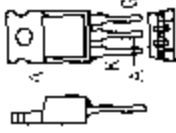
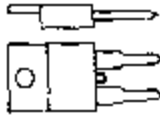
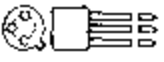

图 B-9

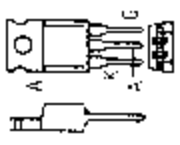

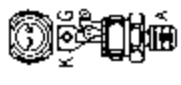
器件型号 Element type	厂名 Manufacturers	材料用途参数 Material Purpose Parameter	图号 Figure	国内外相似替换器件型号 Replace of similar type	备注 Notes	外形参考图 Reference shape
MAC320-8	SCR-D	20A, 600V				 图 B-91
MAC320-10	SCR-D	20A, 800V				
MAC320A4	SCR-D	20A, 200V, 0.05A, 2V	B-91			
MAC320A6	SCR-D	20A, 400V, 0.05A, 2V	B-91			
MAC320A8	SCR-D	20A, 600V, 0.05A, 2V	B-91			
MAC320A10	SCR-D	20A, 800V, 0.05A, 2V	B-91			
MAC321-4	SCR-D	20A, 200V, 0.1A, 2V	B-9			
MAC321-6	SCR-D	20A, 400V, 0.1A, 2V	B-9			
MAC321-8	SCR-D	20A, 600V, 0.1A, 2V	B-9			
MAC321-10	SCR-D	20A, 800V, 0.1A, 2V	B-9			
MAC515-4	SCR-D	15A, 200V, 0.05A		MAC525(A)-4		 图 B-9
MAC515-5	SCR-D	15A, 300V, 0.05A, 0.04A		MAC525(A)-5		
MAC515-6	SCR-D	15A, 400V, 0.05A		MAC525(A)-6		
MAC515-7	SCR-D	15A, 500V, 0.05A, 0.04A		MAC525(A)-7		
MAC515-8	SCR-D	15A, 600V, 0.05A		MAC525(A)-8		
MAC515-9	SCR-D	15A, 700V, 0.05A, 0.04A		MAC525(A)-9		
MAC515-10	SCR-D	15A, 800V, 0.05A		MAC525(A)-10		
MAC515A-4...10	Triac	=MAC515-4...10; 0.075A		MAC525A-..., TAG725-..., TAG726-...		
MAC525-4	MOT	25A, 200V, 0.05A, 2V		TAG725-200, TAG726-200		
MAC525-5	MOT	25A, 300V, 0.05A, 2V		TAG725-300, TAG726-300		
MAC525-6	MOT	25A, 400V, 0.05A, 2V		TAG725-400, TAG726-400		
MAC525-7	MOT	25A, 500V, 0.05A, 2V		TAG725-500, TAG726-500		
MAC525-8	MOT	25A, 600V, 0.05A, 2V		TAG725-600, TAG726-600		
MAC525-9	MOT	25A, 700V, 0.05A, 2V		TAG725-700, TAG726-700		
MAC525-10	MOT	25A, 800V, 0.075A		TAG725-800, TAG726-800		
MAC525A4	MOT	25A, 200V, 0.05A, 2V		TAG725-200, TAG726-200, TAG740-200		
MAC525A5	MOT	25A, 300V, 0.05A, 2V		TAG725-300, TAG726-300, TAG740-300		



器件型号 Element type	厂名 Manufacturers	材料用途参数 Material Purpose Parameter	图号 Figure	国内外相似替换器件型号 Replace of similar type	备注 Notes	外形参考图 Reference snap
MAC525A6	MOT	SCR-D 25A, 400V, 0.05A, 2V		TAG725-400, TAG726-400, TAG740-400		 图 B-62
MAC525A7	MOT	SCR-D 25A, 500V, 0.05A, 2V		TAG725-500, TAG726-500, TAG740-500		
MAC525A8	MOT	SCR-D 25A, 600V, 0.05A, 2V		TAG725-600, TAG726-600, TAG740-600		
MAC525A9	MOT	SCR-D 25A, 700V, 0.05A, 2V		TAG725-700, TAG726-700, TAG740-700		
MAC525A10	MOT	SCR-D 25A, 800V, 0.05A, 2V		TAG725-800, TAG726-800, TAG740-800		
MAC625-4		SCR-D 25A, 200V, 0.05A, 3V				 图 B-6
MAC625-6		SCR-D 25A, 400V, 0.05A, 3V				
MAC625-8		SCR-D 25A, 600V, 0.05A, 3V				
MAC625-10		SCR-D 25A, 800V, 0.05A, 3V				
MAC635-4		SCR-D 35A, 200V, 0.05A, 3V				
MAC635-6		SCR-D 35A, 400V, 0.05A, 3V				 图 G-91
MAC635-8		SCR-D 35A, 600V, 0.05A, 3V				
MAC635-10		SCR-D 35A, 800V, 0.05A, 3V				
MAC800-02...80		Triac 4A, 25-800V, 0.03A	B-62			
MAC800A-02...80		Triac =MAC800-...; 0.01A	B-62			
MAC800B 02...80		Triac =MAC800-...; 0.003A	B-62			 图 F-47
MAC3010-4	MOT	SCR-D 4A, 250V, 0.003A, 2V	B-6			
MAC3010-8	MOT	SCR-D 8A, 250V, 0.04A, 2V	B-91			
MAC3010-15	MOT	SCR-D 15A, 250V, 0.04A, 2V	B-91			
MAC3010-25	MOT	SCR-D 25A, 250V, 0.04A, 2V	B-91			
MAC3010-40	MOI	SCR-D 40A, 250V, 0.04A, 2V	F-47			
MAC3010-40I	MOT	SCR-D 40A, 250V, 0.04A, 2V	F-57			 图 F-57
MAC3020-4	MOT	SCR-D 4A, 400V, 0.003A, 2V	B-6			
MAC3020-8	MOT	SCR-D 8A, 400V, 0.04A, 2V	B-91			

器件型号 Element type	厂名 Manufacturers	材料用途参数 Material Purpose Parameter	图号 Figure	国内外相似替换器件型号 Replace of similar type	备注 Notes	外形参考图 Reference shape
MAC3020-15	MOT	SCR-D 15A, 400V, 0.04A, 2V	B-91			 图 B-91
MAC3020-25	MOT	SCR-D 25A, 400V, 0.04A, 2V	B-91			
MAC3020 40	MOT	SCR-D 40A, 400V, 0.04A, 2V	F-47			
MAC3020-40I	MOT	SCR-D 40A, 400V, 0.04A, 2V	F-57			
MAC3030-4	MOT	SCR-D 4A, 250V, 0.003A, 2V	B-6	TAG96C, 2N6072, 2N6073, 2N6074, 2N6075		 图 B-91
MAC3030-8	MOT	SCR-D 8A, 250V, 0.04A, 2V	B-91	BTA21C, BT158/400, T2806C, T2856D		
MAC3030-15	MOT	SCR-D 15A, 250V, 0.04A, 2V	B-91	T6006C		
MAC3030-25	MOT	SCR-D 25A, 250V, 0.04A, 2V	B-91	TXE10L40, MAC223-5, MAC223A-5		
MAC3030-40	MOT	SCR-D 40A, 250V, 0.04A, 2V	F-47	T6414D, T6410D, 2N5445, 2N5446		
MAC3030-40I	MOT	SCR-D 40A, 250V, 0.04A, 2V	F-57			
MAC3040-4	MOT	SCR-D 4A, 400V, 0.003A, 2V	B-6			 图 F-47
MAC3040-8	MOT	SCR-D 8A, 400V, 0.04A, 2V	B-91			
MAC3040-15	MOT	SCR-D 15A, 400V, 0.04A, 2V	B-91			
MAC3040-25	MOT	SCR-D 25A, 400V, 0.04A, 2V	B-91			
MAC3040-40	MOT	SCR-D 40A, 400V, 0.04A, 2V	F-47			
MAC3040-40I	MOT	SCR-D 40A, 400V, 0.04A, 2V	F-57			
MAC3060-4	MOT	4A, 600V, 0.03A, 2V	B-6			 图 F-57
MAC3060-8	MOT	8A, 600V, 0.04A, 2V	B-91			
MAC3060-15	MOT	15A, 600V, 0.04A, 2V	B-91			
MAC3060-25	MOT	25A, 600V, 0.04A, 2V	B-91			
MAC4110M		15A, 600V, 0.08A, 2.5V	F-59			 图 B-6
MAC4111M		10A, 600V, 0.04A, 2.5V	F-59			
MAC4120B		15A, 200V, 0.08A, 2.5V	F-59			 图 F-59
MAC4120D		15A, 400V, 0.08A, 2.5V	F-59			



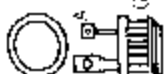

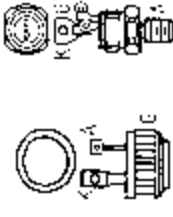
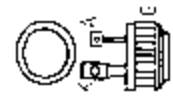
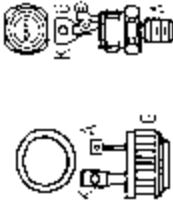
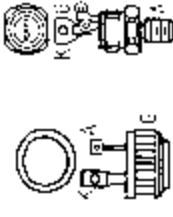
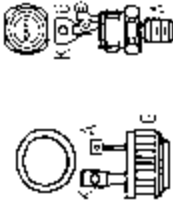
器件型号 Element type	厂名 Manufacturers	材料用途参数 Material Purpose Parameter	图号 Figure	国内外相似替换器件型号 Replace of similar type	备注 Notes	外形参考图 Reference shape
MAC4120M		15A, 600V, 0.08A, 2.5V	F-59			
MAC4120N		15A, 800V, 0.08A, 2.5V	F-59			
MAC4121B		6.7A, 200V, 0.04A, 2.5V	F-59			
MAC4121D		6.7A, 400V, 0.04A, 2.5V	F-59			
MAC4121M		10A, 600V, 0.04A, 2.5V	F-59			
MAC4121N		10A, 800V, 0.04A, 2.5V	F-59			
MAC4688	Triac	40A, 200V, 0.07A	E-8	T6420B		
MAC4689	Triac	40A, 400V, 0.07A	E-8	T6420D		
MAC4690	Triac	40A, 600V, 0.07A	E-8	T6420M		
MAC5441		40A, 200V, 0.1A		2N5441		
MAC5442		40A, 400V, 0.1A		2N5442		
MAC5443		40A, 600V, 0.1A		2N5443		
MAC5544		40A, 200V, 0.1A	F-47	2N5444		
MAC5545		40A, 400V, 0.1A	F-47	2N5445		
MAC5546		40A, 600V, 0.1A	F-47	2N5446		
MAC5567	SCR-D	10A, 200V				
MAC5568	SCR-D	10A, 400V				
MAC5569	SCR-D	6.7A, 200V, 0.04A, 2.5V	F-47			
MAC5570	SCR-D	6.7A, 400V, 0.04A, 2.5V				
MAC5571	SCR-D	15A, 200V	C-85	2N5571		
MAC5572	SCR-D	15A, 400V	C-85			
MAC5573	SCR-D	15A, 200V, 0.08A, 2.5V	F-47	SK3520, SK5677, 2N5573		
MAC5574	SCR-D	15A, 400V, 0.08A, 2.5V	F-47	SK3520, SK5677, 2N5574		
MAC6400B	SCR-D	40A, 200V, 0.05A, 2.5V	C-85			
MAC6400D	SCR-D	40A, 400V, 0.05A, 2.5V	C-85			



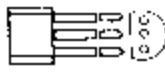
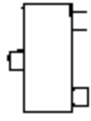
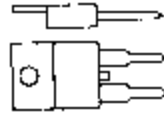
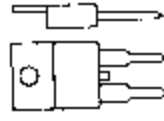
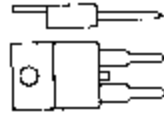

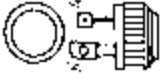



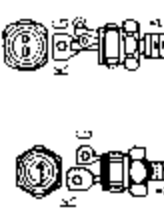
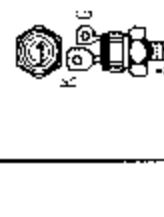

器件型号 Element type	厂名 Manufacturers	材料用途参数 Material Purpose Parameter	图号 Figure	国内外相似替换器件型号 Replace of similar type	备注 Notes	外形参考图 Reference shape
MAC6400M		SCR-D 40A, 600V				
MAC6400N		SCR-D 40A, 600V, 0.05A, 2.5V	C-85			
MAC6401B		30A, 200V, 0.05A, 2.5V	C-85			
MAC6401D		30A, 400V, 0.05A, 2.5V	C-85			
MAC6401N		30A, 800V, 0.05A, 2.5V	C-85			
MAC6410M		40A, 600V, 0.05A, 2.5V	C-85			
MAC6411M		30A, 600V, 0.05A, 2.5V	C-85			
MAC40688	ASI	SCR-D 40A, 200V, 0.07A, 2V	F-57	Q2040D, T6420B, 2N5441		
MAC40689	MOT	SCR-D 20A, 400V, 0.24A, 3.4V	F-57	Q4040D, T6420D, 2N5442		
MAC40689#	ASI	40A, 400V, 0.07A, 2V	F-57			
MAC40690	MOT	SCR-D 20A, 600V, 0.24A, 3.4V	F-57	Q6040D, T6420M, 2N5443		
MAC40690#	ASI	40A, 600V, 0.07A, 2V	F-57			
MAC40795		SCR-D 10A, 600V, 0.04A	D-14	I4101M, T6401M		
MAC40796		SCR-D 10A, 600V, 0.04A	F-55	T4111M		
MAC40797		Triac 15A, 600V, 0.08A	D-14	2N6159, T6400M, 2N5443		
MAC40798		Triac 15A, 600V, 0.08A	F-55	T6411M, 2N6162, T6410M, 2N5446		
MAC40799		SCR-D 10A, 600V, 0.08A	E-8	T4121B, 2N6145		
MAC40800		SCR-D 10A, 600V, 0.08A	E-8	T4121D, 2N6146		
MAC40801		SCR-D =T4100M	E-8	T4100M, T4121M		
MAC40802		SCR-D 10A, 200V		2N6145		
MAC40803		SCR-D 10A, 400V		2N6146		
MAC40804		SCR-D 10A, 600V		2N6147		
MAS32	MEH	SCS 0.1A, 70V	B-52			
MAS39	MEH	SCS 0.1A, 50V	B-52			

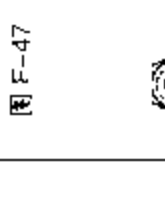





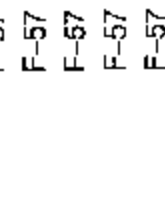
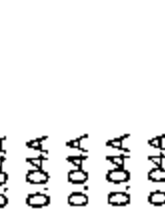
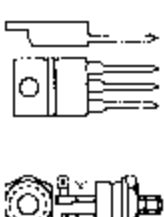
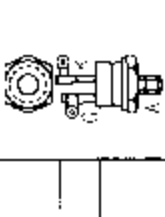
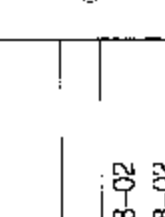
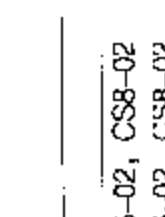
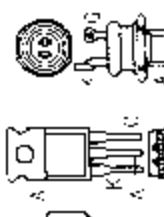
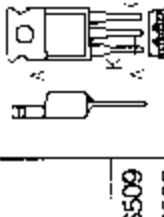
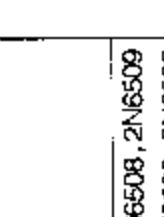
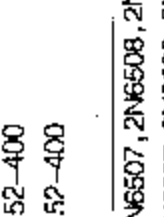
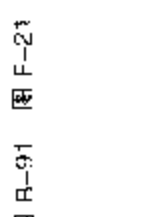
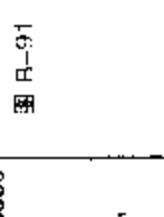
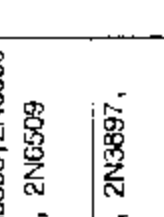
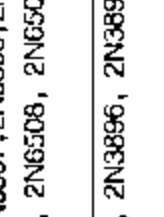



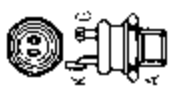
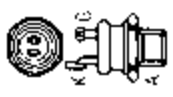









器件型号 Element type	厂名 Manufacturers	材料用途参数 Material Purpose Parameter	图号 Figure	国内外相似替换器件型号 Replace of similar type	备注 Notes	外形参考图 Reference shape
MBS4991	MOT	SBS Ub=6-10V, Is<500 μ A, Iism=5A	B-36			 图 B-36
MBS4992	MOT	SBS Ub=7.5-9V, Is<120 μ A, Iism=5A	B-36			
MCR08BT1		SCR 0.8A, 200V	G-3			
MCR08DT1		SCR 0.8A, 400V	G-3			 图 G-3
MCR08MT1		SCR 0.8A, 500V	G-3			
MCR8D		8A, 400V	B-9			 图 B-9
MCR8M		8A, 600V	B-9			
MCR8N		8A, 800V	B-9			
MCR8SD		8A, 400V	B-9			
MCR8SM		8A, 600V	B-9			
MCR8SN		8A, 800V	B-9			
MCR12D		12A, 400V	B-9			
MCR12M		12A, 600V	B-9			
MCR12N		12A, 800V	B-9			
MCR16D		16A, 400V	B-9			 图 B-9
MCR16M		16A, 600V	B-9			
MCR16N		16A, 800V	B-9			
MCR22-2	MOT	1.5A, 50V, 200 μ A, 0.8V	B-36			 图 B-9
MCR22-3	MOT	1.5A, 100V, 200 μ A, 0.8V	B-36			
MCR22-4	MOT	1.5A, 200V, 200 μ A, 0.8V	B-36			
MCR22-5	MOT	1.5A, 300V, 200 μ A, 0.8V	B-36			
MCR22-6	MOT	1.5A, 400V, 200 μ A, 0.8V	B-36			
MCR22-7	MOT	1.5A, 500V, 200 μ A, 0.8V	B-36			
MCR22-8	MOT	1.5A, 600V, 200 μ A, 0.8V	B-36			

器件型号 Element type	厂名 Manufacturers	材料用途参数 Material Purpose Parameter	图号 Figure	国内外相似替换器件型号 Replace of similar type	备注 Notes	外形参考图 Reference shape
MCR23-2		50V, 0.0002A	B-35			 图 B-35
MCR23-3		100V, 0.0002A	B-35			
MCR23-4		200V, 0.0002A	B-35			
MCR23-5		300V, 0.0002A	B-35			
MCR23-6		400V, 0.0002A	B-35			
MCR23-7		500V, 0.0002A	B-35			
MCR23-8		600V, 0.0002A	B-35			
MCR25D		25A, 400V	B-9			
MCR25M		25A, 600V	B-9			
MCR25N		25A, 800V	B-9			
MCR63-1	MOT	50Hz-Thy 35A, 25V, 0.04A	C-85			 图 C-85
MCR63-2	MOT	50Hz-Thy 35A, 50V, 0.04A	C-85			
MCR63-3	MOT	50Hz-Thy 35A, 100V, 0.04A	C-85			
MCR63-4	MOT	50Hz-Thy 35A, 200V, 0.04A	C-85			
MCR63-5	MOT	50Hz-Thy 35A, 300V, 0.04A	C-85			
MCR63-6	MOT	50Hz-Thy 35A, 400V, 0.04A	C-85			
MCR63-7	MOT	50Hz-Thy 35A, 500V, 0.04A	C-85			
MCR63-8	MOT	50Hz-Thy 35A, 600V, 0.04A	C-85			
MCR63-9	MOT	50Hz-Thy 35A, 700V, 0.04A	C-85			
MCR63-10	MOT	50Hz-Thy 35A, 1000V, 0.04A	C-85			
MCR64-1	MOT	50Hz-Thy 35A, 25V, 0.04A	F-47	TAG35-100		 图 F-47
MCR64-2	MOT	50Hz-Thy 35A, 50V, 0.04A	F-47	TAG35-200		
MCR64-3	MOT	50Hz-Thy 35A, 100V, 0.04A	F-47	TAG35-300		
MCR64-4	MOT	50Hz-Thy 35A, 200V, 0.04A	F-47	TAG35-400		
MCR64-5	MOT	50Hz-Thy 35A, 300V, 0.04A	F-47	TAG35-500		
MCR64-6	MOT	50Hz-Thy 35A, 400V, 0.04A	F-47	TAG35-600		
MCR64-7	MOT	50Hz-Thy 35A, 500V, 0.04A	F-47	TAG35-700		



器件型号 Element type	厂名 Manufacturers	材料用途参数 Material Purpose Parameter	图号 Figure	国内外相似替换器件型号 Replace of similar type	备注 Notes	外形参考图 Reference shape
MCR64-8	MOT	50Hz-Thy 35A, 600V, 0.04A	F-47	TAG35-800		
MCR64-9	MOT	50Hz-Thy 35A, 700V, 0.04A	F-47	TAG35-900		
MCR64-10	MOT	50Hz-Thy 35A, 1000V, 0.04A	F-47	IAG35-1000		
MCR65-1	MOT	50Hz-Thy 35A, 25V, 0.04A	F-57			
MCR65-2	MOT	50Hz-Thy 35A, 50V, 0.04A	F-57			
MCR65-3	MOT	50Hz-Thy 35A, 100V, 0.04A	F-57			
MCR65-4	MOT	50Hz-Thy 35A, 200V, 0.04A	F-57			
MCR65-5	MOT	50Hz-Thy 35A, 300V, 0.04A	F-57			
MCR65-6	MOT	50Hz-Thy 35A, 400V, 0.04A	F-57			
MCR65-7	MOT	50Hz-Thy 35A, 500V, 0.04A	F-57			
MCR65-8	MOT	50Hz-Thy 35A, 600V, 0.04A	F-57			
MCR65-9	MOT	50Hz-Thy 35A, 700V, 0.04A	F-57			
MCR65-10	MOT	50Hz-Thy 35A, 1000V, 0.04A	F-57			
MCR67-1	MOT	50Hz-Thy 8A, 25V, 0.03A	F-50	BSiC0313, BSiD0313, CS5-02, CS8-02		
MCR67-2	MOT	50Hz-Thy 8A, 50V, 0.03A	F-50	BSiC0313, BSiD0313, CS5-02, CS8-02		
MCR67-3		50Hz-Thy 8A, 100V, 0.03A, 0.05A		BSiC0313, BSiD0313, CS5-02, CS8-02		
MCR67-6		8A, 400V				
MCR68-1	MOT	50Hz-Thy 8A, 25V, 0.03A	B-22	BSiD1026, BSiD1666, BT152-400		
MCR68-2	MOT	50Hz-Thy 8A, 50V, 0.03A	B-22	BSiD1026, BSiD1666, BT152-400		
MCR68-3	MOT	50Hz-Thy 8A, 100V, 0.03A	B-22	BSiD1026, BSiD1666, BT152-400		
MCR68-6		8A, 400V	B-22			
MCR69-1	MOT	50Hz-Thy 16A, 25V, 0.03A	B-91	2N6504, 2N6505, 2N6506, 2N6507, 2N6508, 2N6509		
MCR69-2	MOT	50Hz-Thy 16A, 50V, 0.03A	B-91	2N6504, 2N6505, 2N6506, 2N6507, 2N6508, 2N6509		
MCR69-3	MOT	50Hz-Thy 16A, 100V, 0.03A	B-91	2N6505, 2N6506, 2N6507, 2N6508, 2N6509		
MCR69-6		16A, 400V				
MCR70-1	MOT	50Hz-Thy 22A, 25V, 0.03A	F-21	C35A, C228A, MCR64-..., 2N3896, 2N3897, 2N3898, 2N3899		

器件型号 Element type	厂名 Manufacturers	材料 Material	用途 Purpose	参数 Parameter	图号 Figure	国内外相似替换器件型号 Replace of similar type	备注 Notes	外形参考图 Reference shape
MCR70-2	MOT	50Hz-Thy	22A, 50V, 0.03A	F-21	C35A, C226A, MCR64-1, 2N3896, 2N3897, 2N3898, 2N3899			
MCR70-3	MOT	50Hz-Thy	22A, 100V, 0.03A	F-21	C35A, C228A, MCR64-100, 2N3896, 2N3897, 2N3898, 2N3899			
MCR71-1	MOT	50Hz-Thy	35A, 25V, 0.03A	F-47	MCR64-1, TAG35-100			
MCR71-2	MOT	50Hz-Thy	35A, 50V, 0.03A	F-47	MCR64-2, TAG35-100			
MCR71-3	MOT	50Hz-Thy	35A, 100V, 0.03A	F-47	MCR64-3, TAG35-100			
MCR72-1	MOT	50Hz-Thy	5A, 25V, 200 μA	B-91	ECG5437, S4060U			
MCR72-2	MOT	50Hz-Thy	5A, 50V, 200 μA	B-91	ECG5437, S4060F			
MCR72-3	MOT	50Hz-Thy	5A, 100V, 200 μA	B-91	ECG5437, S4060A			
MCR72-4	MOT	50Hz-Thy	5A, 200V, 200 μA	B-91	ECG5437, S4060B			
MCR72-5	MOT	50Hz-Thy	5A, 300V, 200 μA	B-91	ECG5437, S4060C			
MCR72-6	MOT	50Hz-Thy	5A, 400V, 200 μA	B-91	ECG5437, S4060D			
MCR72-7	MOT	50Hz-Thy	5A, 500V, 200 μA	B-91	FCG5438, S4060F			
MCR72-8	MOT	50Hz-Thy	5A, 600V, 200 μA	B-91	ECG5438, S4060M			
MCR72-10	MOT	8A, 800V		B-22				
MCR100-3	MOT	50Hz-Thy	0.5A, 100V, 200 μA	B-36	BRY55-100, SK3638, SK5402, TAG70D, TAG72D, TIC63			
MCR100-4	MOT	50Hz-Thy	0.5A, 200V, 200 μA	B-36	BRY55-200, SK3627, SK5404, TAG70D, TAG72D, TIC64			
MCR100-5	MOT	50Hz-Thy	0.5A, 300V, 200 μA	B-36	BRY55-300, EC103D, SK3951, SK5405, TAG70D, TAG72D, 2N6565			
MCR100-6	MOT	50Hz-Thy	0.5A, 400V, 200 μA	B-36	BRY55-400, EC103D, ECG5405, SK3951, SK5405, TAG70D, TAG72D, 2N6565			
MCR100-7	MOT	50Hz-Thy	0.5A, 500V, 200 μA	B-36	BRY55-500, SK3952, SK5406, TAG59E, TAG70E, TAG72E			
MCR100-8	MOT	50Hz-Thy	0.5A, 600V, 200 μA	B-36	BRY55-600, ECG5406, SK3952, SK5406, TAG59M, TAG70M, TAG72M			





器件型号 Element type	厂名 Manufacturers	材料用途参数 Material Purpose Parameter	图号 Figure	国内外相似替换器件型号 Replace of similar type	备注 Notes	外形参考图 Reference shape
MCR101	MOT	50Hz Thy 0.8A, 15V, 200 μ A	B-36	BRY55-30, ECG5400, EC103Y, SK3950, SK5400, TAG59F, TAG70D, TAG72D		
MCR102	MOT	50Hz-Thy 0.8A, 30V, 200 μ A	B-36	BRY55-30, ECG5400, EC103Y, SK3950, SK5400, TAG59F, TAG70D, TAG72D		
MCR103	MOT	50Hz-Thy 0.8A, 60V, 200 μ A	B-36	BRY55-60, ECG5401, EC103A, SK3638, SK5402, TAG59A, TAG70D, TAG72D		
MCR104	MOT	50Hz-Thy 0.8A, 100V, 200 μ A	B-36	BRY55-100, ECG5402, EC103A, SK3638, SK5402, TAG59A, TAG70D, TAG72D		
MCR106-1	MOT	50Hz-Thy 2.55A, 30V, 200 μ A	B-81	ECG5411, S2060Y, SK3953, SK5412, T106Y1, TAG623-100, TAG633-100, 2N6236		
MCR106-2	MOT	50Hz-Thy 2.55A, 60V, 200 μ A	B-81	BRX60, ECG5412, SK3953, SK5412, S2060A, TAG623-100, TAG633-100, 2N6237, 2N6238		
MCR106-3	MOT	50Hz-Thy 2.55A, 100V, 200 μ A	B-81	BRX61, ECG5413, S2060A, SK3954, SK5414, T106A1, TAG633-100, TAG623-100, 2N6238		
MCR106-4	MOT	50Hz-Thy 2.55A, 200V, 200 μ A	B-81	BRX62, ECG5414, S2060B, SK3954, SK5414, T106B1, TAG633-200, TAG623-200, 2N6239		
MCR106-5	MOT	50Hz-Thy 2.55A, 300V, 200 μ A	B-81	S2060C, TAG633-300, TAG623-300, 2N6240		
MCR106-6	MOT	50Hz Thy 2.55A, 400V, 200 μ A	B-81	BRX64, S2060D, SK3955, SK5415, T106D1, TAG633-400, TAG623-400, 2N6240		
MCR106-7	MOT	50Hz-Thy 2.55A, 500V, 200 μ A	B-81	S2060E, TAG633-500, TAG623-500, 2N6241		
MCR106-8	MOT	50Hz-Thy 2.55A, 600V, 200 μ A	B-81	S2060M, SK3956, SK5416, TAG633-600, TAG623-600, 2N6241		
MCR106-9		50Hz-Thy 4A, 700V, 200 μ A	B-81	TAG633-700, TAG623-700, TIC106M		
MCR106-10		50Hz-Thy 4A, 1kV, 200 μ A	B-81			
MCR107-1		50Hz-Thy 2.55A, 30V, 0.02A	B-81	BSIC1026, TAG620-100, TAG630-100		
MCR107-2		50Hz-Thy 2.55A, 60V, 0.02A	B-81	BSIC1026, TAG620-100, TAG630-100		
MCR107-3		50Hz-Thy 2.55A, 100V, 0.02A	B-81	BSIC1026, TAG620-100, TAG630-100		
MCR107-4		50Hz-Thy 2.55A, 200V, 0.02A	B-81	BSIC1026, TAG620-200, TAG630-200		



图 B-36

图 B-81

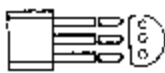
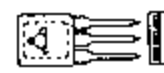
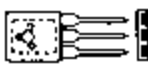

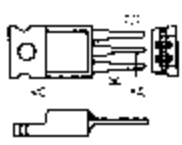
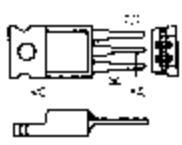
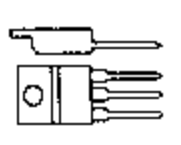
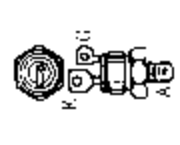
器件型号 Element type	厂名 Manufacturers	材料用途参数 Material Purpose Parameter	图号 Figure	国内外相似替换器件型号 Replace of similar type	备注 Notes	外形参考图 Reference shape
MCR107-5		50Hz-Thy 2.55A, 300V, 0.02A	B-81	BSIC1026, TAG620-300, TAG630-300		
MCR107-6		50Hz-Thy 2.55A, 400V, 0.02A	B-81	BSIC1026, TAG620-400, TAG630-400		
MCR107-7		50Hz Thy 2.55A, 500V, 0.02A	B-81	BSIC1033, TAG620-500, TAG630-500		
MCR107-8		50Hz-Thy 2.55A, 600V, 0.02A	B-81	BSIC1040, TAG620-600, TAG630-600		
MCR107-9		50Hz-Thy 2.55A, 700V, 0.02A	B-81	BSIC1046, TAG620-700, TAG630-700		
MCR107-10		50Hz-Thy 2.55A, 1kV, 0.02A	B-81	BSID1666N		
MCR115		50Hz-Thy 0.8A, 150V, 200 μA	B-35	BRY55-100, MCR100-3, TAG70D, TIC62		
MCR120		50Hz-Thy 0.8A, 200V, 200 μA	B-35	BRY55-200, MCR100-4, TAG70D, TIC63, 2N5064		
MCR201		50Hz-Thy 0.5A, 15V, 200 μA	B-62	BRY58-30, TAG06Y		
MCR202		50Hz-Thy 0.5A, 30V, 200 μA	B-62	BRY58-30, TAG06Y		
MCR203		50Hz-Thy 0.5A, 60V, 200 μA	B-62	BRY58-60, TAG06YY		
MCR204		50Hz-Thy 0.5A, 100V, 200 μA	B-62	BRY58-100, TAG06A		
MCR205		50Hz-Thy 0.5A, 150V, 200 μA	B-62	BRY58-200, TAG06B		
MCR206		50Hz-Thy 0.5A, 200V, 200 μA	B-62	BRY58-200, TAG06B		
MCR218-2		8A, 50V				
MCR218-3	MOT	8A, 100V, 0.025A, 2.5V	B-91			
MCR218-4	MOT	8A, 200V, 0.025A, 2.5V	B-91			
MCR218-4FP		8A, 200V				
MCR218-5	MOT	8A, 300V, 0.025A, 2.5V	B-91			
MCR218-6	MOT	8A, 400V, 0.025A, 2.5V	B-91			
MCR218-6FP		8A, 400V				
MCR218-7	MOT	8A, 500V, 0.025A, 2.5V	B-91			
MCR218-8	MOT	8A, 600V, 0.025A, 2.5V	B-91			
MCR218-8FP		8A, 600V				
MCR218-9	MOT	8A, 700V, 0.025A, 2.5V	B-91			



器件型号 Element type	厂名 Manufacturers	材料用途参数 Material Purpose Parameter	图号 Figure	国内外相似替换器件型号 Replace of similar type	备注 Notes	外形参考图 Reference shape
MCR218-10	MOT	8A, 800V, 0.025A, 2.5V	B-91			 图 B-91
MCR218-10FP		8A, 800V				
MCR219-4		8A, 200V	B-22			
MCR219-6		8A, 400V	B-22			
MCR219-8		8A, 600V	B-22			
MCR219-10		8A, 800V	B-22			
MCR220-5	MOT	50Hz-Thy 12A, 300V, 0.03A	B-91	BT151-500R, S4008L, TIC126C, TAG665-300, T7.5N400		 图 B-91
MCR220-7	MOT	50Hz-Thy 12A, 500V, 0.03A	B-91	BT151-500R, S6008L, TIC126E, TAG665-500, T7.5N600		
MCR220-9	MOT	50Hz-Thy 12A, 700V, 0.03A	B-91	BT151-650R, TAG665-700, TIC126S, T7.5N700		
MCR221-5	MOT	50Hz-Thy 16A, 300V, 0.03A, 1.5V	B-91	CS15-04, S4015L, TAG680-400, T9.5N400		
MCR221-7	MOT	50Hz-Thy 16A, 500V, 0.03A, 1.5V	B-91	CS15-06, S6015L, TAG680-500, T9.5N600		
MCR221-9	MOT	50Hz-Thy 16A, 700V, 0.03A, 1.5V	B-91	CS15-07, TAG680-700, T9.5N700		
MCR225-5		16A, 300V				 图 B-22
MCR225-7		16A, 500V				
MCR225-9		16A, 700V				
MCR225-12		16A, 1kV				
MCR225FP-2		25A, 50V				
MCR225FP-4		25A, 200V				
MCR225FP-6		25A, 400V				
MCR225FP-8		25A, 600V				
MCR225FP-10		25A, 800V				
MCR229A		35A, 100V				 图 F-47
MCR229B		35A, 200V				
MCR229D		35A, 400V				
MCR229M		35A, 600V				
MCR230A3		25A, 100V	F-47			
MCR230B3		25A, 200V	F-47			

器件型号 Element type	厂名 Manufacturers	材料用途参数 Material Purpose Parameter	图号 Figure	国内外相似替换器件型号 Replaces of similar type	备注 Notes	外形参考图 Reference shape
MCR230D3		25A, 400V	F-47			 图 F-47
MCR230F3		25A, 500V	F-47			
MCR230M3		25A, 600V	F-47			
MCR231A3		25A, 100V	F-47			
MCR231B3		25A, 200V	F-47			
MCR231D3		25A, 400V	F-47			
MCR231F3		25A, 500V	F-47			
MCR231M3		25A, 600V	F-47			
MCR264-2	MOT	25A, 50V, 0.05A, 1.5V	B-11			
MCR264-3	MOT	25A, 100V, 0.05A, 1.5V	B-11			
MCR264-4		25A, 200V				
MCR264-6	MOT	25A, 400V, 0.05A, 1.5V	B-11			
MCR264-8	MOT	25A, 600V, 0.05A, 1.5V	B-11			
MCR264-10	MOT	25A, 800V, 0.05A, 1.5V	B-11			
MCR264-12		25A, 1.2kV				
MCR265-2	MOT	35A, 50V, 0.05A, 1.5V	B-91			
MCR265-4	MOT	35A, 200V, 0.05A, 1.5V	B-91			
MCR265-6	MOT	35A, 400V, 0.05A, 1.5V	B-91			
MCR265-8	MO1	35A, 600V, 0.05A, 1.5V	B-91			
MCR265-10	MOT	35A, 800V, 0.05A, 1.5V	B-91			
MCR306-1		2.6A, 30V		2N6236		 图 B-91
MCR306-2		2.6A, 50V		2N6237		
MCR306-3		2.6A, 100V		2N6238		
MCR306-4		2.6A, 200V		2N6239		
MCR306-5		2.6A, 400V		2N6240		
MCR306-6		2.6A, 400V		2N6240		

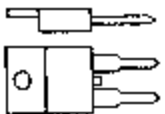

器件型号 Element type	厂名 Manufacturers	材料用途参数 Material Purpose Parameter	图号 Figure	国内外相似替换器件型号 Replace of similar type	备注 Notes	外形参考图 Reference shape
MCR310-2		10A, 50V	B-9			 图 B-9
MCR310-3		10A, 100V	B-9			
MCR310-4		10A, 200V	B-9			
MCR310-6		10A, 400V	B-9			
MCR310-8		10A, 600V	B-9			
MCR310-10		10A, 800V	B-9			
MCR320-1...8		50Hz-Thy 7A, 25-600V, 0.02A	B-62			 图 B-62
MCR406-1		50Hz-Thy 4A, 30V, 200 μA	B-82	S2060Y, TAG106Y, TIC106Y		
MCR406-2		50Hz-Thy 4A, 60V, 200 μA	B-82	S2060A, TAG633-100, TIC106A		
MCR406-3		50Hz-Thy 4A, 100V, 200 μA	B-82	S2060A, TAG633-100, TIC106A		
MCR406-4		50Hz-Thy 4A, 200V, 200 μA	B-82	S2060B, TAG633-200, TIC106B		
MCR407-1		50Hz-Thy 2.55A, 30V, 500 μA	B-82	S2060Y, S2061Y, TIC106Y, TIC108Y		
MCR407-2		50Hz-Thy 2.55A, 60V, 500 μA	B-82	S2060A, S2061A, TIC106A, TIC108A		
MCR407-3		50Hz-Thy 2.55A, 100V, 500 μA	B-82	S2060A, S2061A, TIC106A, TIC108A		
MCR407-4		50Hz-Thy 2.55A, 200V, 500 μA	B-82	S2060B, S2061B, TIC106B, TIC108B		
MCR506-1		3.8A, 25V				
MCR506-2		3.8A, 50V				
MCR506-3		3.8A, 100V				
MCR506-4		3.8A, 200V				
MCR506-6		3.8A, 300V				
MCR506-8		3.8A, 400V				
MCR525-4	MOT	50Hz-Thy 25A, 200V, 0.04A		MCR569-6		
MCR525-5	MOT	50Hz-Thy 25A, 300V, 0.04A		MCR569-6		
MCR525-6	MOT	50Hz-Thy 25A, 400V, 0.04A		MCR569-6		
MCR525-7	MOT	50Hz-Thy 25A, 500V, 0.04A				

器件型号 Element type	厂名 Manufacturers	材料用途参数 Material Purpose Parameter	图号 Figure	国内外相似替换器件型号 Replace of similar type	备注 Notes	外形参考图 Reference shape
MCR525-8	MOT	50Hz-Thy 25A, 600V, 0.04A				
MCR525-9	MOT	50Hz-Thy 25A, 700V, 0.04A				
MCR525-10		50Hz-Thy 25A, 800V, 0.04A				
MCR568-1	MOT	50Hz-Thy 8A, 25V, 0.03A		MCR525-4, MCR569-1		
MCR568-2	MOT	50Hz-Thy 8A, 50V, 0.03A		MCR525-4, MCR569-2		
MCR568-3	MOT	50Hz-Thy 8A, 100V, 0.03A		MCR525-4, MCR569-3		
MCR568-6	MOT	50Hz-Thy 8A, 400V, 0.03A		MCR525-6, MCR569-6		
MCR569-1	MOT	50Hz-Thy 16A, 25V, 0.03A				
MCR569-2	MOT	50Hz-Thy 16A, 50V, 0.03A				
MCR569-3	MOT	50Hz Thy 16A, 100V, 0.03A				
MCR569-4		16A, 400V				
MCR569-6	MOT	50Hz-Thy 16A, 400V, 0.03A				
MCR606-2	MOT	50Hz Thy 4A, 50V, 200 μ A	B-35	C106F, C106F, TAG106F, X0403B		
MCR606-3	MOT	50Hz-Thy 4A, 100V, 200 μ A	B-35	C106A, C108A, TAG106A, X0403B		
MCR606-4	MOT	50Hz-Thy 4A, 200V, 200 μ A	B-35	C106B, C108B, TAG106B, X0403B		
MCR606-5		50Hz Thy 4A, 300V, 200 μ A	B-35	C106C, C108C, TAG106C, X0403D		
MCR606-6	MOT	50Hz-Thy 4A, 400V, 200 μ A	B-35	C106D, C108D, TAG106D, X0403D		
MCR606-7		50Hz-Thy 4A, 500V, 200 μ A	B-35	C108E, C108E, TAG106E, X0403M		
MCR606-8	MOT	50Hz-Thy 4A, 600V, 200 μ A	B-35	C106M, C108M, TAG106M, X0403M		
MCR649-1	MOT	50Hz-Thy 20A, 25V, 0.08A	D-9	S0325C		
MCR649-2	MOT	50Hz-Thy 20A, 50V, 0.08A	D-9	S0525C		
MCR649-3	MOT	50Hz-Thy 20A, 100V, 0.08A	D-9	S1025C		
MCR649-4	MOT	50Hz-Thy 20A, 200V, 0.08A	D-9	S2025C		
MCR649-5		50Hz-Thy 20A, 300V, 0.08A	D-9			
MCR649-6	MOT	50Hz-Thy 20A, 400V, 0.08A	D-9	S4025C		
MCR649-7		50Hz Thy 20A, 500V, 0.08A	D-9			



图 B-35









图 D-9

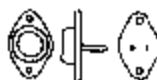
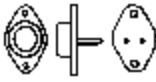
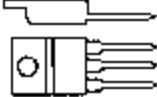

器件型号 Element type	厂名 Manufacturers	材料用途参数 Material Purpose Parameter	图号 Figure	国内外相似替换器件型号 Replace of similar type	备注 Notes	外形参考图 Reference shape
MCR649-8		50Hz-Thy 20A, 600V, 0.08A	D-9			 图 D 9
MCR649-9		50Hz-Thy 20A, 700V, 0.08A	D-9			
MCR649-10		50Hz-Thy 20A, 800V, 0.08A	D-9			
MCR649A(P)-1	MOT	50Hz-Thy 20A, 25V, 0.04A	D-9	S0320L, 2N2573		
MCR649A(P)-2	MOT	50Hz-Thy 20A, 50V, 0.04A	D-9	S0520L, 2N2574		
MCR649A(P)-3	MOT	50Hz Thy 20A, 100V, 0.04A	D-9	S1020L, 2N2575		
MCR649A(P)-4	MOT	50Hz-Thy 20A, 200V, 0.04A	D-9	S2020L, 2N2576		
MCR649A(P)-5	MOT	50Hz-Thy 20A, 300V, 0.04A	D-9	S4020L, 2N2577		
MCR649A(P)-6	MOT	50Hz-Thy 20A, 400V, 0.04A	D-9	S4020L, 2N2578		
MCR649A(P)-7	MOT	50Hz-Thy 20A, 500V, 0.04A	D-9	S6020L, 2N2579		
MCR649A(P)-8	MOT	50Hz-Thy 20A, 600V, 0.04A	D-9	S6020L		
MCR649A(P)-9	MOT	50Hz-Thy 20A, 700V, 0.04A	D-9	S8020L		
MCR649A(P)-10	MOT	50Hz-Thy 20A, 800V, 0.04A	D-9	S8020L		
MCR703, A, A1		4A, 100V	B-22			 图 B 22
MCR703-1		4A, 150V				
MCR704, A, A1		4A, 200V	B-22			
MCR704-1		4A, 250V				
MCR706, A, A1		4A, 400V	B-22			 图 F 8
MCR706-1		4A, 450V				
MCR708, A, A1		4A, 600V	B-22			 图 F 8
MCR708-1		4A, 650V				
MCR729-5	MOT	SCR-H 5A, 300V, 0.05A, <15μs	F-8	S4006B, TAG15S-400, T6F300C, T12F300		
MCR729-6	MOT	SCR-H 5A, 400V, 0.05A, <15μs	F-8	S4006B, TAG15S-400, T6F400C, T12F400		
MCR729-7	MOT	SCR-H 5A, 500V, 0.05A, <15μs	F-8	S5006B, TAG15S-500, T6F500C, T12F500		
MCR729-8	MOT	SCR-H 5A, 600V, 0.05A, <15μs	F-8	S6006B, TAG15S-600, T6F600C, T12F600		

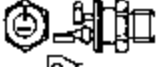
器件型号 Element type	厂名 Manufacturers	材料用途参数 Material Purpose Parameter	图号 Figure	国内外相似替换器件型号 Replace of similar type	备注 Notes	外形参考图 Reference shape
MCR729-9		SCR-H 5A, 700V, 0.05A, <15 μs	F-55	TAG15S-700, T6F700C, T12F700		
MCR729-10	MOT	SCR-H 5A, 800V, 0.05A, <15 μs	F-8	S6006B, TAG15S-800, T6F800C, T12F800		图 F-55
MCR808-1		50Hz-Thy 18A, 25V, 0.05A, 0.008A	D-14	BSIE4026P, BSIE4026PM		
MCR808-2		50Hz-Thy 18A, 50V, 0.05A, 0.008A	D-14	BSIE4026P, BSIE4026PM		图 F-8
MCR808-3		50Hz-Thy 18A, 100V, 0.05A, 0.008A	D-14	BSIE4026P, BSIE4026PM		
MCR808-4		50Hz-Thy 18A, 200V, 0.05A, 0.008A	D-14	BSIE4026P, BSIE4026PM		图 D-14
MCR808-5		50Hz-Thy 18A, 300V, 0.05A, 0.008A	D-14	BSIE4026P, BSIE4026PM		
MCR808-6		50Hz-Thy 18A, 400V, 0.05A, 0.008A	D-14	BSIE4026P, BSIE4026PM		图 B-62
MCR808-7		13A, 500V				
MCR808-8		13A, 600V				
MCR808-9		13A, 700V				
MCR808-10		2A, 30V				
MCR808R2		13A, 50V				
MCR808R4		13A, 200V				
MCR808R6		13A, 400V				
MCR808R8		13A, 600V				
MCR846-1		50Hz-Thy 2A, 25V, 0.05A	F-55	BTW42/600		
MCR846-2		50Hz-Thy 2A, 50V, 0.05A	F-55	BTW42/600		
MCR846-3		50Hz-Thy 2A, 100V, 0.05A	F-55	BTW42/600		
MCR846-4		50Hz-Thy 2A, 200V, 0.05A	F-55	BTW42/600		
MCR914-1		50Hz-Thy 1.6A, 25V, 0.008A	B-62	BTX30-50, TAG1-50, T1N100, 2N1595		
MCR914-2		50Hz-Thy 1.6A, 50V, 0.008A	B-62	BTX30-50, TAG1-50, T1N100, 2N1595		
MCR914-3		50Hz-Thy 1.6A, 100V, 0.008A	B-62	BTX30-100, TAG1-100, T1N100, 2N1596		
MCR914-4		50Hz-Thy 1.6A, 200V, 0.008A	B-62	BTX30-200, TAG1-200, T1N200, 2N1597		
MCR914-5		50Hz-Thy 1.6A, 300V, 0.008A	B-62	BTX30-300, TAG1-300, T1N300, 2N1598		
MCR914-6		50Hz Thy 1.6A, 400V, 0.008A	B-62	BTX30-400, TAG1-400, T1N400, 2N1599		











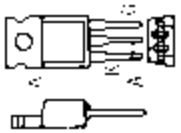

器件型号 Element type	厂名 Manufacturers	材料用途参数 Material Purpose Parameter	图号 Figure	国内外相似替换器件型号 Replace of similar type	备注 Notes	外形参考图 Reference shape
MCR1000-4	MOT	15A, 200V, 2.5V	B-91			
MCR1000-6	MOT	15A, 400V, 2.5V	B-91			
MCR1000-8	MOT	15A, 600V, 2.5V	B-91			
MCR1305R2		13A, 50V				
MCR1305R4		13A, 200V				
MCR1305R6		13A, 400V				
MCR1305R8		13A, 600V				
MCR1308-1		50Hz-Thy 18A, 25V, 0.05A	F-55	BSIE4126P, BTW40-200, CS16-02		
MCR1308-2		50Hz-Thy 18A, 50V, 0.05A	F-55	BSIE4126P, BTW42-200, CS16-02		
MCR1308-3		50Hz-Thy 18A, 100V, 0.05A	F-55	BSIE4126P, BTW42-200, CS16-02		
MCR1308-4		50Hz-Thy 18A, 200V, 0.05A	F-55	BSIE4126P, BTW42-200, CS16-02		
MCR1308-5		50Hz-Thy 18A, 300V, 0.05A	F-55	BSIE4126P, BTW42-400, CS16-04		
MCR1308-6		50Hz-Thy 18A, 400V, 0.05A	F-55	BSIE4126P, BTW42-400, CS16-04		
MCR1308-7		13A, 500V				
MCR1308-8		13A, 600V				
MCR1308-9		13A, 700V				
MCR1308R2		13A, 50V				
MCR1308R4		13A, 200V				
MCR1308R6		13A, 400V				
MCR1308R8		13A, 600V				
MCR1336-5		SCR-H 300V, 0.04A	F-55			
MCR1336-6		SCR-H 400V, 0.04A	F-55			
MCR1336-7		SCR-H 500V, 0.04A	F-55			
MCR1336-8		SCR-H 600V, 0.04A	F-55			
MCR1336-9		SCR-H 700V, 0.04A	F-55			
MCR1336-10		SCR-H 800V, 0.04A	F-55			

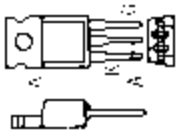
图 F-55

器件型号 Element type	厂名 Manufacturers	材料用途参数 Material Purpose Parameter	图号 Figure	国内外相似替换器件型号 Replace of similar type	备注 Notes	外形参考图 Reference shape
MCR1604-1		8A, 25V				 图 F-47
MCR1604-2		8A, 50V				
MCR1604-3		8A, 100V				
MCR1604-4		8A, 200V				
MCR1604-5		8A, 300V				
MCR1604-6		8A, 400V				
MCR1604-7		8A, 500V				
MCR1604-8		8A, 600V				
MCR1718-5	MOT	SCR-H 25A, 300V, 0.05A, 20 μ s	F-47	C234C, S4025HH, T12F300, 2N687		 图 B-51
MCR1718-6	MOT	SCR-H 25A, 400V, 0.05A, 20 μ s	F-47	C234D, S4025HH, T12F400, 2N688		
MCR1718-7	MOT	SCR-H 25A, 500V, 0.05A, 20 μ s	F-47	C234E, S5025H, T12F500, 2N689		
MCR1718-8	MOT	SCR-H 25A, 600V, 0.05A, 20 μ s	F-47	C234M, S6025H, T12F600, 2N690		
MCR1906-1	MOT	50Hz-Thy 1.6A, 25V, 0.001A	B-51	S0301MS3, TAG2-50, TAG614-100, 2N1595A		
MCR1906-2	MOT	50Hz-Thy 1.6A, 50V, 0.001A	B-51	S0501MS3, TAG2-50, TAG614-100, 2N1595A		
MCR1906-3	MOT	50Hz-Thy 1.6A, 100V, 0.001A	B-51	S1001MS3, TAG2-100, TAG614-100, 2N1596A		
MCR1906-4	MOT	50Hz Thy 1.6A, 200V, 0.001A	B-51	S2001MS3, TAG2-200, TAG614-200, 2N1597A		
MCR1906-5	MOT	50Hz-Thy 1.6A, 300V, 0.001A	B-51	S4001MS3, TAG2-300, TAG614-400, 2N1598A		
MCR1906-6	MOT	50Hz-Thy 1.6A, 400V, 0.001A	B-51	S4001MS3, TAG2-400, TAG614-400, 2N1599A		
MCR1906-7		1.6A, 500V				 图 F-55
MCR1906-8		1.6A, 600V				
MCR1907-1		SCR-H 25A, 25V, 0.03A, <12 μ s	F-55	C234U, MCR1718-5, T12F100		
MCR1907-2		SCR-H 25A, 50V, 0.03A, <12 μ s	F-55	C234F, MCR1718-5, T12F100		
MCR1907-3		SCR-H 25A, 100V, 0.03A, <12 μ s	F-55	C234A, MCR1718-5, T12F100		
MCR1907-4		SCR-H 25A, 200V, 0.03A, <12 μ s	F-55	C234B, MCR1718-5, T12F200		
MCR1907-5		SCR-H 25A, 300V, 0.03A, <12 μ s	F-55	C234C, MCR1718-5, T12F300		
MCR1907-6		SCR-H 25A, 400V, 0.03A, <12 μ s	F-55	C234D, MCR1718-6, T12F400		

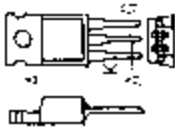

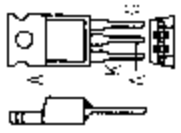

器件型号 Element type	厂名 Manufacturers	材料用途参数 Material Purpose Parameter	图号 Figure	国内外相似替换器件型号 Replace of similar type	备注 Notes	外形参考图 Reference shape
MCR2080		8A, 200V				 图 B-91
MCR2080-4	MOT	8A, 200V, 0.05A, 2.5V	B-91			
MCR2080-5	MOT	8A, 300V, 0.05A, 2.5V	B-91			
MCR2080-6	MOT	8A, 400V, 0.05A, 2.5V	B-91			
MCR2080-7	MOT	8A, 500V, 0.05A, 2.5V	B-91			
MCR2080-8	MOT	8A, 600V, 0.05A, 2.5V	B-91			
MCR2080-9	MOT	8A, 700V, 0.05A, 2.5V	B-91			
MCR2080-10	MOT	8A, 800V, 0.05A, 2.5V	B-91			
MCR2080A		8A, 200V				
MCR2080A4		8A, 200V				
MCR2080A5		8A, 300V				
MCR2080A6		8A, 400V				
MCR2080A7		8A, 500V				
MCR2080A8		8A, 600V				
MCR2080A9		8A, 700V				
MCR2080A10		8A, 800V				
MCR2130-4		SCR-H 200V, 0.01A	B-62			 图 B-62
MCR2130-5		SCR-H 300V, 0.01A	B-62			
MCR2130-6		SCR-H 400V, 0.01A	B-62			
MCR2130-7		SCR-H 500V, 0.01A	B-62			
MCR2130-8		SCR-H 600V, 0.01A	B-62			
MCR2150-4	MOT	15A, 200V, 0.05A, 2.5V	B-91			
MCR2150-5	MOT	15A, 300V, 0.05A, 2.5V	B-91			
MCR2150-6	MOT	15A, 400V, 0.05A, 2.5V	B-91			
MCR2150-7	MOT	15A, 500V, 0.05A, 2.5V	B-91			
MCR2150-8	MOT	15A, 600V, 0.05A, 2.5V	B-91			
MCR2150-9	MOT	15A, 700V, 0.05A, 2.5V	B-91			

器件型号 Element type	厂名 Manufacturers	材料用途参数 Material Purpose Paramoter	图号 Figure	国内外相似替换器件型号 Replace of similar type	备注 Notes	外形参考图 Reference shape	
MCR2150-10	MOT	15A, 800V, 0.05A, 2.5V	B-91			 图 B-91	
MCR2150A4		15A, 200V					
MCR2150A5		15A, 300V					
MCR2150A6		15A, 400V					
MCR2150A7		15A, 500V					
MCR2150A8		15A, 600V					
MCR2150A9		15A, 700V					
MCR2150A10		15A, 800V					
MCR2301		8A, 25V					 图 F-55
MCR2302		8A, 50V					
MCR2303		8A, 105V					
MCR2304		8A, 200V					
MCR2305		8A, 300V					
MCR2305-1		8A, 25V					
MCR2305-2		8A, 50V					
MCR2305-3		8A, 100V					
MCR2305-4		8A, 200V					
MCR2305-5		8A, 300V					
MCR2305-6		8A, 400V					
MCR2305-7		8A, 500V					
MCR2305-8		8A, 600V					
MCR2306		8A, 400V					
MCR2307		8A, 500V					
MCR2308		8A, 600V					
MCR2315-1		50Hz-Thy 8A, 25V, 0.04A	F-55	BSIC0313, BSID0313, CS5-02, MCR67-1			
MCR2315-2		50Hz-Thy 8A, 50V, 0.04A	F-55	BSIC0313, BSID0313, CS5-02, MCR67-2			
MCR2315-3		50Hz-Thy 8A, 100V, 0.04A	F-55	BSIC0313, BSID0313, CS5-02, MCR67-3			

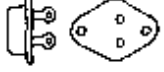

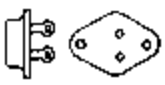

器件型号 Element type	厂名 Manufacturers	材料用途参数 Material Purpose Parameter	图号 Figure	国内外相似替换器件型号 Replace of similar type	备注 Notes	外形参考图 Reference snapp
MCR2315-4	50Hz-Thy	8A, 200V, 0.04A	F-55	BSIC0313, BSID0313, CS5-02, CS8-02		 图 F-55
MCR2315-5	50Hz-Thy	8A, 300V, 0.04A	F-55	BSIC0326, BSID0326, CS5-04, CS8-04		
MCR2315-6	50Hz-Thy	8A, 400V, 0.04A	F-55	BSIC0326, BSID0326, CS5-04, CS8-04		
MCR2315-7		8A, 500V				
MCR2315-8		8A, 600V				
MCR2604L1		8A, 25V				
MCR2604L2		8A, 50V				
MCR2604L3		8A, 100V				
MCR2604L4		8A, 200V				
MCR2604L5		8A, 300V				
MCR2604L6		8A, 400V				
MCR2604L7		8A, 500V				
MCR2604L8		8A, 600V				
MCR2640-1		8A, 25V				 图 D-14
MCR2640-2		8A, 50V				
MCR2640-3		8A, 100V				
MCR2640-4		8A, 200V				
MCR2640-5		8A, 300V				
MCR2640-6		8A, 400V				
MCR2640-7		8A, 500V				
MCR2640-8		8A, 600V				
MCR2818-1	50Hz-Thy	25A, 25V, 0.04A	D-14	BSIE4026M, MCR63-1, MCR3835-1, 2N3870		
MCR2818-2	50Hz Thy	25A, 50V, 0.04A	D-14	BSIE4026M, MCR63-2, MCR3835-2, 2N3870		
MCR2818-3	50Hz-Thy	25A, 100V, 0.04A	D-14	BSIE4026M, MCR63-3, MCR3835-3, 2N3870		
MCR2818-4	50Hz-Thy	25A, 200V, 0.04A	D-14	BSIE4026M, MCR63-4, MCR3835-4, 2N3871		
MCR2818-5	50Hz-Thy	25A, 300V, 0.04A	D-14	BSIE4026M, MCR63-5, MCR3835-5, 2N3872		

器件型号 Element type	厂名 Manufacturers	材料 Material	用途 Purpose	参数 Parameter	图号 Figure	国内外相似替换器件型号 Replace of similar type	备注 Notes	外形参考图 Reference shape
MCR2818-6		50Hz-Thy	25A, 400V, 0.04A		D-14	BSIE4026M, MCR63-6, MCR3835-6, 2N3872		 图 D-14
MCR2818-7		50Hz-Thy	25A, 500V, 0.04A		D-14	BSIE4033M, MCR63-7, MCR3835-7, 2N3873		
MCR2818-8		50Hz-Thy	25A, 600V, 0.04A		D-14	BSIE4040M, MCR63-8, MCR3835-8, 2N3873		
MCR2818R2			13A, 50V					
MCR2818R4			13A, 200V					
MCR2818R6			13A, 400V					
MCR2818R8			13A, 600V					
MCR2819-1...8		50Hz-Thy	=MCR2818		F-55	MCR3935-...		
MCR2835-1		50Hz-Thy	35A, 25V, 0.04A		F-55	MCR63-1		 图 F-55
MCR2835-2		50Hz-Thy	35A, 50V, 0.04A		F-55	MCR63-2		
MCR2835-3		50Hz-Thy	35A, 100V, 0.04A		F-55	MCR63-3		
MCR2835-4		50Hz-Thy	35A, 200V, 0.04A		F-55	MCR63-4		
MCR2835-5		50Hz-Thy	35A, 300V, 0.04A		F-55	MCR63-5		
MCR2835-6		50Hz-Thy	35A, 400V, 0.04A		F-55	MCR63-6		
MCR2835-7		50Hz-Thy	35A, 500V, 0.04A		F-55	MCR63-7		
MCR2835-8		50Hz-Thy	35A, 600V, 0.04A		F-55	MCR63-8		
MCR2918-1...8		50Hz-Thy	=MCR2818-...		F-55	C228A, MCR3935-1, T12N100COB, T12N100COC, 2N681		
MCR2935-1...8		50Hz-Thy	=MCR2835-...		F-55	MCR64-..., TAG35-...		 图 B-82
MCR3000-1		50Hz-Thy	5A, 25V, 0.03A		B-82	TAG680-100, TIC126F, T7.5N400		
MCR3000-2		50Hz-Thy	5A, 50V, 0.03A		B-82	TAG680-100, TIC126F, T7.5N400		
MCR3000-3		50Hz-Thy	5A, 100V, 0.03A		B-82	TAG680-100, TIC126A, T7.5N400		
MCR3000-3C			5.1A, 50V					
MCR3000-4		50Hz-Thy	5A, 200V, 0.03A		B-82	TAG680-200, TIC126B, T7.5N400		
MCR3000-5		50Hz-Thy	5A, 300V, 0.03A		B-82	TAG680-400, TIC126C, T7.5N400		

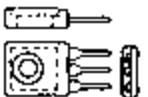
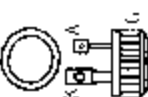

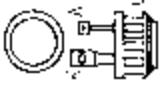
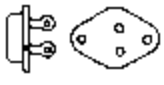
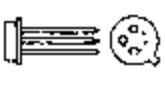
器件型号 Element type	厂名 Manufacturers	材料用途参数 Material Purpose Parameter	图号 Figure	国内外相似替换器件型号 Replace of similar type	备注 Notes	外形参考图 Reference shape
MCR3000-5C		5.1A, 200V				
MCR3000-6		50Hz-Thy 5A, 400V, 0.03A	B-82	TAG680-400, TIC126D, T7.5N400		
MCR3000-7		50Hz-Thy 5A, 500V, 0.03A	B-82	TAG680-500, TIC126E, T7.5N500		
MCR3000-7C		5.1A, 400V				
MCR3000-8		50Hz-Thy 5A, 600V, 0.03A	B-82	TAG680-600, TIC126M, T7.5N600		
MCR3000-9		50Hz-Thy 5A, 700V, 0.03A	B-82	TAG680-700, TIC126S, T7.5N700		
MCR3000-9C		5.1A, 600V				
MCR3000-10		50Hz-Thy 5A, 800V, 0.03A	B-82	TAG690-800, TIC126N, T7.5N800		
MCR3000-10C		5.1A, 800V				
MCR3818-1	MOT	50Hz-Thy 13A, 25V, 0.04A	C-85	BS1D4026M, BS1E4026M, ECG5514, MCR3835-1, S0325G, SK3613, SK5514		 图 B-82
MCR3818-2	MOT	50Hz-Thy 13A, 50V, 0.04A	C-85	BS1D4026M, BS1E4026M, ECG5514, MCR3835-2, S0525G, SK3613, SK5514, 2N5164		
MCR3818-3	MOT	50Hz Thy 13A, 100V, 0.04A	C-85	BS1D4026M, BS1E4026M, ECG5514, MCR3835-3, S1025G, SK3613, SK5514		
MCR3818-4	MOT	50Hz-Thy 13A, 200V, 0.04A	C-85	BS1D4026M, BS1E4026M, ECG5514, MCR3835-4, S2025G, SK3613, SK5514, 2N5165		
MCR3818-5	MOT	50Hz-Thy 13A, 300V, 0.04A	C-85	BS1D4026M, BS1E4026M, ECG5514, MCR3835-5, S4025G, SK6615, SK5515		 图 C-85
MCR3818-6	MOT	50Hz-Thy 13A, 400V, 0.04A	C-85	BS1D4026M, BS1E4026M, MCR3835-6, S4025G, SK6615, SK5515, 2N5166		
MCR3818-7	MOT	50Hz-Thy 13A, 500V, 0.04A	C-85	BS1D4033M, BS1E4033M, ECG5514, MCR3835-7, S5025G, SK6616, SK5516,		
MCR3818-8	MOT	50Hz-Thy 13A, 600V, 0.04A	C-85	BS1D4040M, BS1E4040M, ECG5514, MCR3835-8, S6025G, SK6616, SK5516, 2N5167		
MCR3818-9	MOT	50Hz-Thy 13A, 700V, 0.04A	C-85	BS1D4046M, BS1E4046M, MCR3835-9		
MCR3818-10	MOT	50Hz-Thy 13A, 800V, 0.04A	C-85	BS1D4053M, BS1E4053M, MCR3835-10		

器件型号 Element type	厂名 Manufacturers	材料用途参数 Material Purpose Parameter	图号 Figure	国内外相似替换器作型号 Replace of similar type	备注 Notes	外形参考图 Reference shape
MCR3835-1	MOT	50Hz-Thy 35A, 25V, 0.04A	C-85	BSiE4026M, ECG5517, MCR63-1, S0335G, SK3615, SK5517, 2N3870		 图 C-85
MCR3835-2	MOT	50Hz-Thy 35A, 50V, 0.04A	C-85	BSiE4026M, ECG5517, MCR63-2, S0535G, SK3615, SK5517, 2N3870		
MCR3835-3		50Hz-Thy 35A, 100V, 0.04A	D-14	BSiE4026M, MCR63-3		
MCR3835-4		50Hz-Thy 35A, 200V, 0.04A	D-14	BSiE4026M, MCR63-4		
MCR3835-5	MOT	50Hz-Thy 35A, 300V, 0.04A	C-85	BSiE4026M, ECG5518, MCR63-5, S1035G		
MCR3835-6		50Hz-Thy 35A, 400V, 0.04A	D-14	BSiE4026M, MCR63-6		
MCR3835-7	MOT	50Hz-Thy 35A, 500V, 0.04A	C-85	DSiE4033M, ECG5519, MCR63-7, S5035G		
MCR3835-8		50Hz-Thy 35A, 600V, 0.04A	D-14	BSiE4040M, MCR63-8		 图 D-14
MCR3835-9		50Hz-Thy 35A, 700V, 0.04A	D-14	BSiE4046M, MCR63-9		
MCR3835-10	MOT	50Hz-Thy 35A, 800V, 0.04A	C-85	BSiE4053M, MCR63-10		
MCR3896		35A, 100V	B-60			
MCR3897		35A, 200V	B-60			
MCR3898		35A, 400V	B-60			 图 B-60
MCR3899		35A, 600V	B-60			
MCR3918-1	MOT	50Hz-Thy 13A, 25V, 0.04A, 1.5V	F-21	BUW45-400R, BSiD4126M, ECG5521, S0325H, S6210A, SK6621, SK5521, T12N100COB, T12N100COC, 2N681		 图 F-21
MCR3918-2	MOT	50Hz-Thy 13A, 50V, 0.04A, 1.5V	F-21	BSiD4126M, ECG5521, S0525H, T12N100COB, T12N100COC, 2N682, 2N5168		
MCR3918-3	MOT	50Hz-Thy 13A, 100V, 0.04A, 1.5V	F-21	BTW45-400R, BSiD4126M, ECG5522, S1025H, S6210A, SK6621, SK5521, T12N100COB, T12N100COC, 2N683, 2N684		
MCR3918-4	MOT	50Hz-Thy 13A, 200V, 0.04A, 1.5V	F-21	BSiD4126M, ECG5524, S2025H, T12N200COB, T12N200COC, 2N685, 2N686, 2N5169		

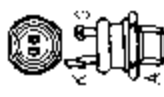

器件型号 Element type	厂名 Manufacturers	材料 Material	用途 Purpose	参数 Parameter	图号 Figure	国内外形相似替换器件型号 Replace of similar: type	备注 Notes	外形参考图 Reference shape
MCR3918-5	MOT	50Hz-Thy	13A, 300V,	0.04A, 1.5V	F-21	BTW45-400R, BSiD4126M, ECG5527, S4025H, S6210D, SK6629, SK5529, T12N300COB, T12N300COE, 2N687		 图 F-21
MCR3918-6	MOT	50Hz-Thy	13A, 400V,	0.04A, 1.5V	F-21	BSiD4126M, S4025H, T12N400COB, T12N400COE, 2N688, 2N5170		
MCH3918-7	MOT	50Hz-Thy	13A, 500V,	0.04A, 1.5V	F-21	BSiD4133M, BTW45-600R, ECG5529, S5025H, T12N500COB, T12N500COE, 2N689		
MCR3918-8	MOI	50Hz-Thy	13A, 600V,	0.04A, 1.5V	F-21	BSiD4140M, ECG5529, S6025H, T12N600COB, T12N600COE, 2N690, 2N5171		
MCR3918-9	MOT	50Hz-Thy	13A, 700V,	0.04A, 1.5V	F-21	BSiD4146M, T12N700COB, T12N700COE, 2N691		
MCR3918-10	MOT	50Hz-Thy	13A, 800V,	0.04A, 1.5V	F-21	BSiD4153M, T12N800COB, T12N800COE, 2N692		
MCR3935-1...10		50Hz-Thy	=MCR3835-...		F-21	BSiE41...M, C35-..., TAG35..., 2N5204...5207		
MCR4018-3			13A, 100V					
MCR4018-4			13A, 200V			TAG35-200, 2N5204, 2N5205,		
MCR4018-5			13A, 300V					
MCR4018-6			13A, 400V					
MCR4018-7			13A, 500V					
MCR4018-8			13A, 600V					
MCR4035-3			22A, 100V					
MCR4035-4			22A, 200V					
MCR4035-5			22A, 300V					
MCR4035-6			22A, 400V					
MCR4035-7			22A, 500V					
MCR4035-8			22A, 600V					
MCR5164			20A, 50V					
MCR5165			20A, 200V					

器件型号 Element type	厂名 Manufacturers	材料用途参数 Material Purpose Parameter	图号 Figure	国内外相似替换器件型号 Replace of similar type	备注 Notes	外形参考图 Reference shape
MCR5166		20A, 400V				
MCR5167		20A, 600V				
MCR5168		20A, 50V	F-47			
MCR5169		20A, 200V	F-47			
MCR5170		20A, 400V	F-47			
MCR5171		20A, 600V	F-47			
MCR6200A		20A, 100V				
MCR6200B		20A, 200V				
MCR6200D		20A, 400V				
MCR6200M		20A, 600V				
MCR6210A		20A, 100V	F-47			
MCR6210B		20A, 200V	F-47			
MCR6210D		20A, 400V	F-47			
MCR6210M		20A, 600V	F-47			
MCR6220A, B, D, M		20A, 100V	F-47			
MDT40A06N	SIE	SCA 48A, 600V, 0.15A, 1.5V	H-13			
MDT40A08N	SIE	SCA 48A, 800V, 0.15A, 1.5V	H-13			
MDT40A12N	SIE	SCA 48A, 1.2kV, 0.15A, 1.5V	H-13			
MDT40A14N	SIE	SCA 48A, 1.4kV, 0.15A, 1.5V	H-13			
MDT40A16N	SIE	SCA 48A, 1.6kV, 0.15A, 1.5V	H-13			
MDT45A06	SIE	SCA 120A, 600V, 0.25A, 1.5V	H-13			
MDT45A08	SIE	SCA 120A, 800V, 0.25A, 1.5V	H-13			
MDT45A12	SIE	SCA 120A, 1.2kV, 0.25A, 1.5V	H-13			
MDT45A13	SIE	SCA 120A, 1.3kV, 0.25A, 1.5V	H-13			
MDT46A09	SIE	SCA 120A, 900V, 0.25A, 1.5V	H-13			



图 F-47











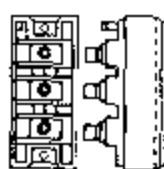
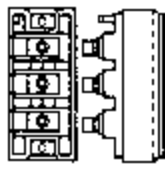
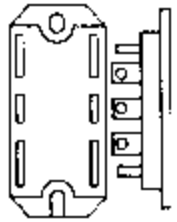



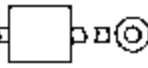
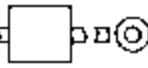
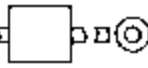
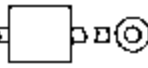
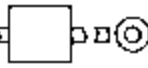



图 H-13

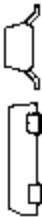
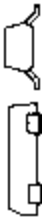
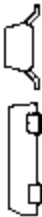

器件型号 Element type	厂名 Manufacturers	材料用途参数 Material Purpose Parameter	图号 Figure	国内外相似替换器件型号 Replace of similar type	备注 Notes	外形参考图 Reference shape
MDT46A10	SIE	SCA 120A, 1kV, 0.25A, 1.5V	H-13			 图 H-13
MDT50A06N	SIE	SCA 65A, 600V, 0.15A, 1.5V	H-13			
MDT50A08N	SIE	SCA 65A, 800V, 0.15A, 1.5V	H-13			
MDT50A12N	SIE	SCA 65A, 1.2kV, 0.15A, 1.5V	H-13			
MDT50A14N	SIE	SCA 65A, 1.4kV, 0.15A, 1.5V	H-13			
MDT50A16N	SIE	SCA 65A, 1.6kV, 0.15A, 1.5V	H-13			
MDT65A06N	SIE	SCA 75A, 600V, 0.15A, 1.5V	H-13			
MDT65A08N	SIE	SCA 75A, 800V, 0.15A, 1.5V	H-13			
MDT65A12N	SIE	SCA 75A, 1.2kV, 0.15A, 1.5V	H-13			
MDT65A14N	SIE	SCA 75A, 1.4kV, 0.15A, 1.5V	H-13			
MDT65A16N	SIE	SCA 75A, 1.6kV, 0.15A, 1.5V	H-13			
MDT95A06N	SIE	SCA 95A, 600V, 0.15A, 1.5V	H-13			
MDT95A08N	SIE	SCA 95A, 800V, 0.15A, 1.5V	H-13			
MDT95A12N	SIE	SCA 95A, 1.2kV, 0.15A, 1.5V	H-13			
MDT95A14N	SIE	SCA 95A, 1.4kV, 0.15A, 1.5V	H-13			
MEU21	MEH	PUT 1A, 40V, 100 μ A	B-48			
MEU22	MEH	PUT 1A, 40V, 100 μ A	B-48			
MFC25	CHN	25A, 0.2~1.6kV, 0.1A, 3V				
MFC55	CHN	55A, 0.2~1.6kV, 0.2A, 3V				
MFC63	CHN	63A, 0.2~1.6kV, 0.2A, 3V				
MFC90	CHN	90A, 0.2~1.6kV, 0.25A, 3.5V				
MFC110	CHN	110A, 0.2~1.6kV, 0.25A, 3.5V				
MFC130	CHN	130A, 0.2~1.6kV, 0.25A, 3.5V				
MFC160	CHN	160A, 0.2~1.6kV, 0.25A, 3.5V				

器件型号 Element type	厂名 Manufacturers	材料 Material	用途 Purpose	参数 Parameter	图号 Figure	国内外相似替换器件型号 Replace of similar type	备注 Notes	外形参考图 Reference shape
MH25-500	AFI	SCA	25A, 0.04A, 2.5V		H-11			
MK1V115	MOT	DAC	20A, 104V, 1.5V		F-1			
MK1V125	MOT	DAC	20A, 110V, 1.5V		F-1			
MK1V135	MOT	DAC	20A, 120V, 1.5V		F-1			
MKP9V120	MOT	DAC	0.9A, 110V, 1.5V		A-6			
MKP9V130	MOT	DAC	0.9A, 120V, 1.5V		A-6			
MKP9V240	MOT	DAC	0.9A, 220V, 1.5V		A-6			
MKP9V260	MOT	DAC	0.9A, 240V, 1.5V		A-6			
MKP9V270	MOT	DAC	0.9A, 250V, 1.5V		A-6			
MMBS5060		50Hz-Thy	0.51A, 30V, 200 μA		G-3			
MMBS5061		50Hz-Thy	0.51A, 60V, 200 μA		G-3			
MMBS5062		50Hz-Thy	0.51A, 100V, 200 μA		G-3			
MPT20		SBS	0.2A			MBS4491		
MPT24		SBS	0.2A					
MPT28		SBS	0.2A					
MPT36		SBS	0.2A					
MPU131		PUT	1A, 40V			MPU131		
MPU132		PUT	1A, 40V			MPU132		
MPU133		PUT	1A, 40V			MPU133		
MPU231		PUT	1A, 40V		B-51	2N6116		
MPU232		PUT	1A, 40V		B-51	2N6117		
MPU233		PUT	1A, 40V		B-51	2N6118		
MSC180L353F		SOB	133A, 220V					



器件型号 Element type	厂名 Manufacturers	材料用途参数 Material Purpose Parameter	图号 Figure	国内外相似替换器件型号 Replace of similar type	备注 Notes	外形参考图 Reference shape
MSG60G43	SCB	2 x SCR, 30A, 400V				
MSG60L2B3F	SCB	4 x SCR, 60A, 220V				
MSG60L3A3F	SCB	6 x SCR, 80A, 220V				
MSG60L3S3F	SCB	2 x SCR, 59A, 220V				
MSG60L43	SCB	2 x SCR, 30A, 800V				
MSG60Q43	SCB	2 x SCR, 30A, 1.2kV				
MSG60U2B3F	SCB	4 x SCR, 60A, 440V				
MSG60U3A3F	SCB	4 x SCR, 81A, 440V				
MSG60U3S3F	SCB	2 x SCR, 59A, 440V				
MSG60U43	SCB	2 x SCR, 30A, 1.6kV				
MSG100G43	SCB	2 x SCR, 50A, 400V				
MSG100L2B3F	SCB	4 x SCR, 84A, 220V				
MSG100L3A3F	SCB	6 x SCR, 126A, 200V				
MSG100L3S3F	SCB	2 x SCR, 94A, 220V				
MSG100L43	SCB	2 x SCR, 50A, 800V				
MSG100Q43	SCB	2 x SCR, 50A, 1.2kV				
MSG100U2B3F	SCB	4 x SCR, 84A, 440V				
MSG100U3A3F	SCB	6 x SCR, 126A, 440V				
MSG100UF3S3F	SCB	2 x SCR, 94A, 440V				
MSG100U43	SCB	2 x SCR, 50A, 1.6kV				
MSG180G43	SCB	2 x SCR, 90A, 400V				
MSG180L2B3F	SCB	4 x SCR, 110A, 220V				
MSG180L3A3F	SCB	6 x SCR, 171A, 220V				
MSG180L3S3F	SCB	2 x SCR, 133A, 220V				
MSG180L43	SCB	2 x SCR, 90A, 800V				
MSG180Q43	SCB	2 x SCR, 90A, 1.2kV				
MSG180U2B3F	SCB	4 x SCR, 110A, 440V				

器件型号 Element type	厂名 Manufacturers	材料用途参数 Material Purpose Parameter	图号 Figure	国内外相似替换器件型号 Replace of similar type	备注 Notes	外形参考图 Reference shape
MSG180U3A3F	SCB	6 x SCR, 171A, 440V				
MSG180UF3S3F	SCB	2 x SCR, 133A, 440V				
MSG180U43	SCB	2 x SCR, 90A, 1.6kV				
MSR80U611	SCB	3 x SCR+4 x D, 105A, 440V				
MSR150U6P2	SCB	3 x SCR+4 x D, 175A, 440V				
MSR300U6P2	SCB	3 x SCR+4 x D, 240A, 440V				
MTC25	CHN	25A, 0.2~1.6kV, 0.1A, 3V				
MTC55	CHN	55A, 0.2~1.6kV, 0.2A, 3V				
MTC63	CHN	63A, 0.2~1.6kV, 0.2A, 3V				
MTC90	CHN	90A, 0.2~1.6kV, 0.025A, 3.5V				
MTC110	CHN	110A, 0.2~1.6kV, 0.025A, 3.5V				
MTC130	CHN	130A, 0.2~1.6kV, 0.025A, 3.5V				
MTC160	CHN	160A, 0.2~1.6kV, 0.025A, 3.5V				
MTD16C	TSA	16A, 200V, 0.05A, 3V	D-9			
MTD16E	TSA	16A, 400V, 0.05A, 3V	D 9			
MTD40A06	SIE	48A, 600V	H-13			
MTD40A12	SIE	48A, 1.2kV	H-13			
MTD40A14	SIE	48A, 1.4kV	H-13			
MTD40A16	SIE	48A, 1.6kV	H-13			
MTD45A08	SIE	120A, 800V, 0.25A, 1.5V	H-13			
MTD45A12	SIE	120A, 1.2kV, 0.25A, 1.5V	H-13			
MTD45A13	SIE	120A, 1.3kV, 0.25A, 1.5V	H-13			
MTD46A08	SIE	120A, 800V, 0.25A, 1.5V	H-13			
MTD46A09	SIE	120A, 900V, 0.25A, 1.5V	H-13			



图 D-9



图 H-13

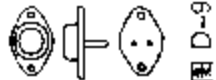

器件型号 Element type	厂名 Manufacturers	材料用途参数 Material Purpose Parameter	图号 Figure	国内外相似替换器件型号 Replace of similar type	备注 Notes	外形参考图 Reference shape
MTD50A06	SIE	SCA 65A, 600V	H-13			 <p>图 H-13</p>
MTD50A08	SIE	SCA 65A, 800V	H-13			
MTD50A12	SIE	SCA 65A, 1.2KV	H-13			
MTD50A14	SIE	SCA 65A, 1.4KV	H-13			
MTD50A16	SIE	SCA 65A, 1.6KV	H-13			
MTD65A06	SIE	SCA 75A, 600V	H-13			
MTD65A08	SIE	SCA 75A, 800V	H-13			
MTD65A12	SIE	SCA 75A, 1.2KV	H-13			
MTD65A14	SIE	SCA 75A, 1.4KV	H-13			
MTD65A16	SIE	SCA 75A, 1.6KV	H-13			
MTD95A06	SIE	SCA 95A, 600V	H-13			
MTD95A08	SIE	SCA 95A, 800V	H-13			
MTD95A12	SIE	SCA 95A, 1.2KV	H-13			
MTD95A14	SIE	SCA 95A, 1.4KV	H-13			
MTD95A16	SIE	SCA 95A, 1.6KV	H-13			
MTT18M06N	SIE	SCA 25A, 600V, 0.1A, 1.5V				
MTT18M08N	SIE	SCA 25A, 800V, 0.1A, 1.5V				
MTT18M12N	SIE	SCA 25A, 1.2KV, 0.1A, 1.5V				
MTT18M14N	SIE	SCA 25A, 1.4KV, 0.1A, 1.5V				
MTT18M16N	SIE	SCA 25A, 1.6KV, 0.1A, 1.5V				
MTT25M06N	SIE	SCA 32A, 600V, 0.1A, 1.5V				
MTT25M08N	SIE	SCA 32A, 800V, 0.1A, 1.5V				
MTT25M12N	SIE	SCA 32A, 1.2KV, 0.1A, 1.5V				
MTT25M14N	SIE	SCA 32A, 1.4KV, 0.1A, 1.5V				
MTT25M16N	SIE	SCA 32A, 1.6KV, 0.1A, 1.5V				

器件型号 Element type	厂名 Manufacturers	材料用途参数 Material Purpose Parameter	图号 Figure	国内外相似替换器件型号 Replace of similar type	备注 Notes	外形参考图 Reference shape
MTT40A06N	SIE	SCA 48A, 600V, 0.15A, 1.5V				
MTT40A08N	SIE	SCA 48A, 800V, 0.15A, 1.5V				
MTT40A12N	SIE	SCA 48A, 1.2kV, 0.15A, 1.5V				
MTT40A14N	SIE	SCA 48A, 1.4kV, 0.15A, 1.5V				
MTT40A16N	SIE	SCA 48A, 1.6kV, 0.15A, 1.5V				
MTT40M08N	SIE	SCA 65A, 800V, 0.15A, 1.4V				
MTT40M12N	SIE	SCA 48A, 1.2kV, 0.15A, 1.5V				
MTT40M14N	SIE	SCA 48A, 1.4kV, 0.15A, 1.5V				
MTT40M16N	SIE	SCA 48A, 1.6kV, 0.15A, 1.5V				
MTT50A06N	SIE	SCA 65A, 600V, 0.15A, 1.5V				
MTT50A08N	SIE	SCA 65A, 800V, 0.15A, 1.5V				
MTT50A12N	SIE	SCA 65A, 1.2kV, 0.15A, 1.5V				
MTT50A14N	SIE	SCA 65A, 1.4kV, 0.15A, 1.5V				
MTT50A16N	SIE	SCA 65A, 1.6kV, 0.15A, 1.5V				
MTT65A06N	SIE	SCA 75A, 600V, 0.15A, 1.5V				
MTT65A08N	SIE	SCA 75A, 800V, 0.15A, 1.5V				
MTT65A12N	SIE	SCA 75A, 1.2kV, 0.15A, 1.5V				
MTT65A14N	SIE	SCA 75A, 1.4kV, 0.15A, 1.5V				
MTT65A16N	SIE	SCA 75A, 1.6kV, 0.15A, 1.5V				
MTT95A08N	SIE	SCA 95A, 800V, 0.15A, 1.5V				
MTT95A12N	SIE	SCA 95A, 1.2kV, 0.15A, 1.5V				
MTT95A14N	SIE	SCA 95A, 1.4kV, 0.15A, 1.5V				
MTT95A16N	SIE	SCA 95A, 1.6kV, 0.15A, 1.5V				

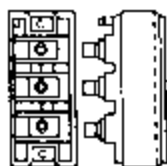
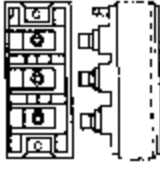

M 类外形参考图索引



图 A-5



图 A-6

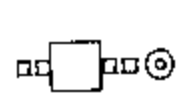

图 B-36

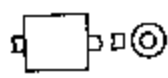

图 B-48



图 B-83

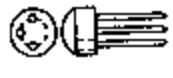

图 B-51

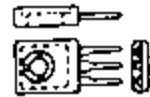

图 B-91



图 B-6

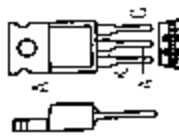

图 B-52



图 B-9



图 B-60

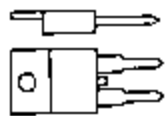

图 C-85



图 B-22

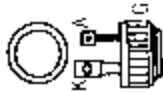

图 B-81

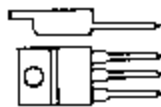

图 D-9



图 B-35

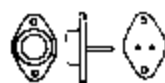

图 B-82



图 D-14

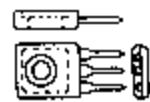

图 D-33

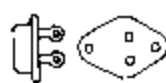

图 D-36

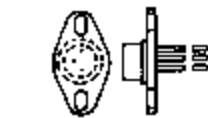

图 F-1



图 F-8



图 F-21



图 E-8



图 F-47



图 F-48



图 F-50

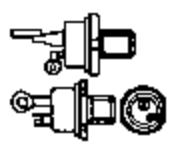

图 F-55



图 F-57

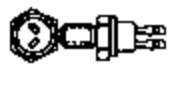

图 F-59



图 G-1



图 G-3

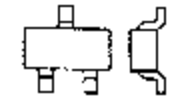

图 G-12

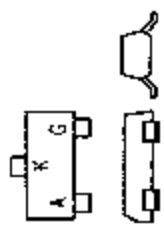

图 H-11

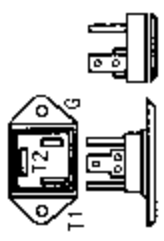

图 H-13

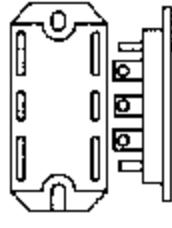

器件型号 Element type	厂名 Manufacturers	材料用途参数 Material Purpose Parameter	图号 Figure	国内外相似替换器件型号 Replace of similar type	备注 Notes	外形参考图 Reference shape
N13T1, T2	NEC, NEJ	PUT 2A, 40V, 20 μ A, 500V	B-36	ECG6402		
N016RH02	WES	21A, 200V, 0.05A, 3V	F-48			
N016RH04	WES	21A, 400V, 0.05A, 3V	F-48			
N016RH06	WES	21A, 600V, 0.05A, 3V	F-48			
N016RH08	WES	21A, 800V, 0.05A, 3V	F-48			
N016RH10	WES	21A, 1kV, 0.05A, 3V	F-48			
N016RH15	WES	21A, 1.5kV, 0.05A, 3V	F-48			
N023RH02	WES	23A, 200V, 0.05A, 3V	F-48			
N023RH04	WES	23A, 400V, 0.05A, 3V	F-48			
N023RH06	WES	23A, 600V, 0.05A, 3V	F-48			
N023RH08	WES	23A, 800V, 0.05A, 3V	F-48			
N023RH10	WES	23A, 1kV, 0.05A, 3V	F-48			
N023RH12	WES	23A, 1.2kV, 0.05A, 3V	F-48			
N023RH15	WES	23A, 1.5kV, 0.05A, 3V	F-48			
N029RH02	WES	48A, 200V, 0.05A, 3V	F-48			
N029RH04	WES	48A, 400V, 0.05A, 3V	F-48			
N029RH06	WES	48A, 600V, 0.05A, 3V	F-48			
N029RH08	WES	48A, 800V, 0.05A, 3V	F-48			
N029RH10	WES	48A, 1kV, 0.05A, 3V	F-48			
N029RH12	WES	48A, 1.2kV, 0.05A, 3V	F-48			
N029RH15	WES	48A, 1.5kV, 0.05A, 3V	F-48			
N044RH02	WES	45A, 200V, 0.06A, 3V	F-21			
N044RH04	WES	45A, 400V, 0.06A, 3V	F-21			
N044RH06	WES	45A, 600V, 0.06A, 3V	F-21			
N044RH08	WES	45A, 800V, 0.06A, 3V	F-21			

图 B-36

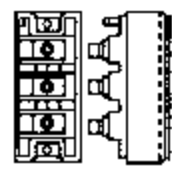



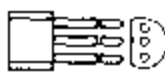

图 F-48



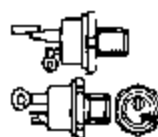

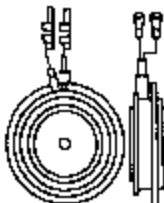
图 F-21

器件型号 Element type	厂名 Manufacturers	材料用途参数 Material Purpose Parameter	图号 Figure	国内外相似替换器件型号 Replace of similar type	备注 Notes	外形参考图 Reference shape
N044RH10	WES	45A, 1kV, 0.06A, 3V	F-21			 图 F-21
N044RH12	WES	45A, 1.2kV, 0.06A, 3V	F-21			
N044RH15	WES	45A, 1.5kV, 0.06A, 3V	F-21			
N060RH04	WES	100A, 400V, 0.06A, 3V	F-21			
N060RH06	WES	100A, 600V, 0.06A, 3V	F-21			
N060RH08	WES	100A, 800V, 0.06A, 3V	F-21			
N060RH10	WES	100A, 1kV, 0.06A, 3V	F-21			
N060RH12	WES	100A, 1.2kV, 0.06A, 3V	F-21			
N086CH02	WES	320A, 200V, 0.15A, 3V	C-50			 图 C-50
N086CH04	WES	320A, 400V, 0.15A, 3V	C-50			
N086CH06	WES	320A, 600V, 0.15A, 3V	C-50			
N086CH08	WES	320A, 800V, 0.15A, 3V	C-50			
N086CH12	WES	320A, 1.2kV, 0.15A, 2.5V	C-50			
N086CH14	WES	320A, 1.4kV, 0.15A, 3V	C-50			
N086CH15	WES	320A, 1.5kV, 0.15A, 3V	C-50			
N086PH02	WES	85A, 200V, 0.15A, 3V	E-28			 图 E-28
N086PH04	WES	85A, 400V, 0.15A, 3V	E-28			
N086PH06	WES	85A, 600V, 0.15A, 3V	E-28			
N086PH08	WES	85A, 800V, 0.15A, 3V	E-28			
N086PH10	WES	85A, 1kV, 0.15A, 3V	E-28			
N105CH02	WES	440A, 200V, 0.15A, 3V	C-50			
N105CH04	WES	440A, 400V, 0.15A, 3V	C-50			
N105CH06	WES	440A, 600V, 0.15A, 3V	C-50			
N105CH08	WES	440A, 800V, 0.15A, 3V	C-50			
N105CH12	WES	440A, 1.2kV, 0.15A, 3V	C-50			
N105CH15	WES	440A, 1.5kV, 0.15A, 3V	C-50			

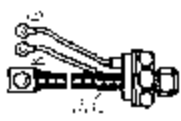
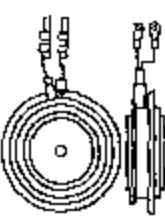
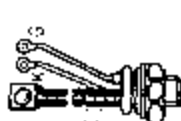

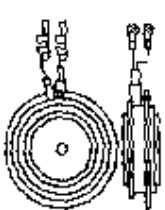
器件型号 Element type	厂名 Manufacturers	材料用途参数 Material Purpose Parameter	图号 Figure	国内外相似替换器件型号 Replace of similar type	备注 Notes	外形参考图 Reference shape
N105PH02	WES	110A, 200V, 0.15A, 3V	E-28			 图 E-28
N105PH04	WES	110A, 400V, 0.15A, 3V	E-28			
N105PH06	WES	110A, 600V, 0.15A, 3V	E-28			
N105PH08	WES	110A, 800V, 0.15A, 3V	E-28			
N105PH10	WES	110A, 1kV, 0.15A, 3V	E-28			
N105PH12	WES	110A, 1.2kV, 0.15A, 3V	E-28			
N105PH15	WES	110A, 1.5kV, 0.15A, 3V	E-28			
N170CH02	WES	575A, 200V, 0.15A, 3V	C-50			 图 C-50
N170CH04	WES	575A, 400V, 0.15A, 3V	C-50			
N170CH06	WES	575A, 600V, 0.15A, 3V	C-50			
N170CH08	WES	575A, 800V, 0.15A, 3V	C-50			
N170CH10	WES	575A, 1kV, 0.15A, 3V	C-50			
N170CH14	WES	575A, 1.4kV, 0.15A, 3V	C-50			
N170CH15	WES	575A, 1.5kV, 0.15A, 3V	C-50			
N170PH02	WES	355A, 200V, 0.15A, 3V	E-30			 图 E-30
N170PH04	WES	355A, 400V, 0.15A, 3V	E-30			
N170PH06	WES	355A, 600V, 0.15A, 3V	E-30			
N170PH08	WES	355A, 800V, 0.15A, 3V	E-30			
N170PH10	WES	355A, 1kV, 0.15A, 3V	E-30			
N170PH12	WES	355A, 1.2kV, 0.15A, 3V	E-30			
N170PH14	WES	355A, 1.4kV, 0.15A, 3V	E-30			
N170PH15	WES	355A, 1.5kV, 0.15A, 3V	E-30			
N195CH02	WES	668A, 200V, 0.15A, 3V	C-50			
N195CH04	WES	668A, 400V, 0.15A, 3V	C-50			
N195CH06	WES	668A, 600V, 0.15A, 3V	C-50			
N195CH08	WES	668A, 800V, 0.15A, 3V	C-50			
N195CH10	WES	668A, 1kV, 0.15A, 3V	C-50			

器件型号 Element type	厂名 Manufacturers	材料用途参数 Material Purpose Parameter	图号 Figure	国内外相似替换器件型号 Replace of similar type	备注 Notes	外形参考图 Reference shape	
N195CH12	WES	668A, 1.2KV, 0.15A, 3V	C-50			 图 C-50	
N195CH14	WES	668A, 1.4KV, 0.15A, 3V	C-50				
N195CH15	WES	668A, 1.5KV, 0.15A, 3V	C-50				
N195PH02	WES	226A, 200V, 0.15A, 3V	E-30				
N195PH04	WES	226A, 400V, 0.15A, 3V	E-30				
N195PH06	WES	226A, 600V, 0.15A, 3V	E-30				
N195PH08	WES	226A, 800V, 0.15A, 3V	E-30				
N195PH10	WES	226A, 1KV, 0.15A, 3V	E-30				
N195PH14	WES	226A, 1.4KV, 0.15A, 3V	E-30				
N195PH15	WES	226A, 1.5KV, 0.15A, 3V	E-30				
N203A...YY		50Hz-Thy 0.5A, 50-400V, 200 μ A, 25 μ s	B-35	BT149...; TAG59...; 2N6681...6685			 图 E-30
N213		SBS					 图 B-35
N260CH02	WES	880A, 200V, 0.3A, 3V	C-50				
N260CH04	WES	880A, 400V, 0.3A, 3V	C-50				
N260CH06	WES	880A, 600V, 0.3A, 3V	C-50				
N260CH08	WES	880A, 800V, 0.3A, 3V	C-50				
N260CH10	WES	880A, 1KV, 0.3A, 3V	C-50				
N260CH12	WES	880A, 1.2KV, 0.3A, 3V	C-50				
N260CH14	WES	880A, 1.4KV, 0.3A, 3V	C-50				
N260CH16	WES	880A, 1.6KV, 0.3A, 3V	C-50				
N260CH20	WES	880A, 2KV, 0.3A, 3V	C-50				
N260CH22	WES	880A, 2.2KV, 0.3A, 3V	C-50				
N260CH24	WES	880A, 2.4KV, 0.3A, 3V	C-50				
N260CH26	WES	880A, 2.6KV, 0.3A, 3V	C-50				
N260CH28	WES	880A, 2.8KV, 0.3A, 3V	C-50				

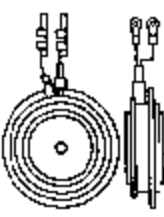
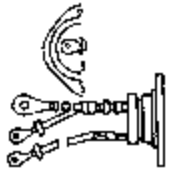

器件型号 Element type	厂名 Manufacturers	材料用途参数 Material Purpose Paramoter	图号 Figure	国内外相似替换器件型号 Replacoe of similar type	备注 Notes	外形参考图 Reference shape	
N260CH30	WES	880A, 3kV, 0.3A, 3V	C-50			 图 C-50	
N260CH32	WES	880A, 3.2kV, 0.3A, 3V	C-50				
N260CH34	WES	880A, 3.4kV, 0.3A, 3V	C-50				
N260CH36	WES	880A, 3.6kV, 0.3A, 3V	C-50				
N260KH02	WES	550A, 200V, 0.3A, 3V	E-9				 图 E-9
N260KH04	WES	550A, 400V, 0.3A, 3V	E-9				
N260KH06	WES	550A, 600V, 0.3A, 3V	E-9				
N260KH08	WES	550A, 800V, 0.3A, 3V	E-9				
N260KH10	WES	550A, 1kV, 0.3A, 3V	E-9				
N260KH12	WES	550A, 1.2kV, 0.15A, 3V	E-9				
N260KH14	WES	550A, 1.4kV, 0.3A, 3V	E-9				
N260KH16	WES	550A, 1.6kV, 0.3A, 3V	E-9				
N260KH18	WES	550A, 1.8kV, 0.3A, 3V	E-9				
N260KH20	WES	550A, 2kV, 0.3A, 3V	E-9				
N260KH22	WES	550A, 2.2kV, 0.3A, 3V	E-9				
N260KH24	WES	550A, 2.4kV, 0.3A, 3V	E-9				
N260KH26	WES	550A, 2.6kV, 0.3A, 3V	E-9				
N260KH28	WES	550A, 2.8kV, 0.3A, 3V	E-9				
N260KH30	WES	550A, 3kV, 0.3A, 3V	E-9				
N260KH32	WES	550A, 3.2kV, 0.3A, 3V	E-9				
N260KH34	WES	550A, 3.4kV, 0.3A, 3V	E-9				
N260KH36	WES	550A, 3.6kV, 0.3A, 3V	E-9				
N280CH02	WES	290A, 200V, 0.2A, 3V	C-50				
N280CH04	WES	290A, 400V, 0.2A, 3V	C-50				
N280CH06	WES	290A, 800V, 0.2A, 3V	C-50				
N280CH10	WES	290A, 1kV, 0.2A, 3V	C-50				
N280CH13	WES	290A, 1.3kV, 0.2A, 3V	C-50				

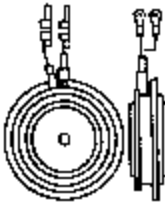
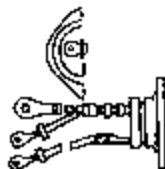
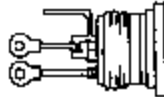
器件型号 Element type	厂名 Manufacturers	材料用途参数 Material Purpose Parameter	图号 Figure	国内外相似替换器件型号 Replace of similar type	备注 Notes	外形参考图 Reference shape
N313	SBS	0.175A, $I_{ism}=5A$, $U_b=7-9V$, $I_s < 200 \mu A$	B-35	BS08A, 2N4992		 图 B-35
N320CH36	WES	1.3kA, 3.6kV, 0.3A, 3V				
N320CH38	WES	1.3kA, 3.8kV, 0.3A, 3V				
N320CH40	WES	1.3kA, 4kV, 0.3A, 3V				
N320CH42	WES	1.3kA, 4.2kV, 0.3A, 3V				
N330CH16	WES	1.2kA, 1.6kV, 0.3A, 3V	C-50			 图 C-50
N330CH18	WES	1.2kA, 1.8kV, 0.3A, 3V	C-50			
N330CH20	WES	1.2kA, 2kV, 0.3A, 3V	C-50			
N330CH22	WES	1.2kA, 2.2kV, 0.3A, 3V	C-50			
N330CH24	WES	1.2kA, 2.4kV, 0.3A, 3V	C-50			
N330KH16	WES	550A, 1.6kV, 0.3A, 3V	E-9			 图 E-9
N330KH18	WES	550A, 1.8kV, 0.3A, 3V	E-9			
N330KH20	WES	550A, 2kV, 0.3A, 3V	E-9			
N330KH22	WES	550A, 2.2kV, 0.3A, 3V	E-9			
N330KH24	WES	550A, 2.4kV, 0.3A, 3V	E-9			
N350CH02	WES	1.4kA, 200V, 0.3A, 3V	C-50			
N350CH04	WES	1.4kA, 400V, 0.3A, 3V	C-50			
N350CH06	WES	1.4kA, 600V, 0.3A, 3V	C-50			
N350CH08	WES	1.4kA, 800V, 0.3A, 3V	C-50			
N350CH10	WES	1.4kA, 1kV, 0.3A, 3V	C-50			
N350CH12	WES	1.4kA, 1.2kV, 0.3A, 3V	C-50			
N350CH14	WES	1.4kA, 1.4kV, 0.3A, 3V	C-50			
N350CH16	WES	1.4kA, 1.6kV, 0.3A, 3V	C-50			
N350CH18	WES	1.4kA, 1.8kV, 0.3A, 3V	C-50			 图 E-15
N350MH02	WES	900A, 200V, 0.3A, 3V	E-15			



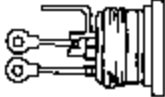
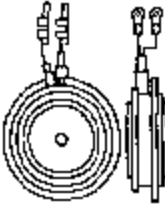

器件型号 Element type	厂名 Manufacturers	材料用途参数 Material Purpose Parameter	图号 Figure	国内外相似替换器件型号 Replace of similar type	备注 Notes	外形参考图 Reference shape	
N350MH04	WES	900A, 400V, 0.3A, 3V	E-15			 图 E-15	
N350MH06	WES	900A, 600V, 0.3A, 3V	E-15				
N350MH10	WES	900A, 1kV, 0.3A, 3V	E-15				
N350MH12	WES	900A, 1.2kV, 0.3A, 3V	E-15				
N350MH14	WES	900A, 1.4kV, 0.3A, 3V	E-15				
N350MH16	WES	900A, 1.6kV, 0.3A, 3V	E-15				
N350MH18	WES	900A, 1.8kV, 0.3A, 3V	E-15				
N360CH30	WES	1.5kA, 3kV, 0.3A, 3V					
N360CH32	WES	1.5kA, 3.2kV, 0.3A, 3V					
N360CH34	WES	1.5kA, 3.4kV, 0.3A, 3V					
N360CH36	WES	1.5kA, 3.6kV, 0.3A, 3V					
N360CH38	WES	1.5kA, 3.8kV, 0.3A, 3V					
N370CH04	WES	1.5kA, 400V, 0.33A, 3V	C-50				 图 C-50
N370CH06	WES	1.5kA, 600V, 0.33A, 3V	C-50				
N370CH08	WES	1.5kA, 800V, 0.33A, 3V	C-50				
N370CH10	WES	1.5kA, 1kV, 0.33A, 3V	C-50				
N370CH12	WES	1.5kA, 1.2kV, 0.33A, 3V	C-50				
N370CH14	WES	1.5kA, 1.4kV, 0.33A, 3V	C-50				
N370CH15	WES	1.5kA, 1.5kV, 0.33A, 3V	C-50				
N370MH02	WES	900A, 200V, 0.3A, 3V	E-15				
N370MH04	WES	900A, 400V, 0.3A, 3V	E-15				
N370MH06	WES	900A, 600V, 0.3A, 3V	E-15				
N370MH08	WES	900A, 800V, 0.3A, 3V	E-15				
N370MH10	WES	900A, 1kV, 0.3A, 3V	E-15				
N370MH12	WES	900A, 1.2kV, 0.3A, 3V	E-15				
N370MH14	WES	900A, 1.4kV, 0.3A, 3V	E-15				
N370MH15	WES	900A, 1.5kV, 0.3A, 3V	E-15				



器件型号 Element type	厂名 Manufacturers	材料用途参数 Material Purpose Parameter	图号 Figure	国内外相似替换器件型号 Replace of similar type	备注 Notes	外形参考图 Reference shape
N390CH22	WES	1.6kV, 2.2kV, 0.3A, 3V				
N390CH24	WES	1.6kV, 2.4kV, 0.3A, 3V				
N390CH26	WES	1.6kV, 2.6kV, 0.3A, 3V				
N390CH28	WES	1.6kV, 2.8kV, 0.3A, 3V				
N390CH30	WES	1.6kV, 3kV, 0.3A, 3V				
N390CH32	WES	1.6kV, 3.2kV, 0.3A, 3V				
N413L	NEC, NEJ	2A, 3V, 26V, 5V	F-1	ECG6407		
N413M	NEC, NEJ	2A, 3V, 29V, 5V	F-1			
N413N	NEC, NEJ	2A, 3V, 34V, 5V	F-1			
N450CH14	WES	1.9kV, 1.4kV, 0.3A, 3V				
N450CH15	WES	1.9kV, 1.5kV, 0.3A, 3V				
N450CH16	WES	1.9kV, 1.6kV, 0.3A, 3V				
N450CH18	WES	1.9kV, 1.8kV, 0.3A, 3V				
N450CH20	WES	1.9kV, 2kV, 0.3A, 3V				
N450CH22	WES	1.9kV, 2.2kV, 0.3A, 3V				
N450CH24	WES	1.9kV, 2.4kV, 0.3A, 3V				
N490CH08	WES	2.1kV, 800V, 0.3A, 3V				
N490CH10	WES	2.1kV, 1kV, 0.3A, 3V				
N490CH12	WES	2.1kV, 1.2kV, 0.3A, 3V				
N490CH14	WES	2.1kV, 1.4kV, 0.3A, 3V				
N490CH15	WES	2.1kV, 1.5kV, 0.3A, 3V				
N490CH16	WES	2.1kV, 1.6kV, 0.3A, 3V				
N490CH18	WES	2.1kV, 1.8kV, 0.3A, 3V				
N540CH02	WES	2.4kV, 200V, 0.3A, 3V				
N540CH04	WES	2.4kV, 400V, 0.3A, 3V				



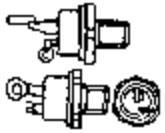

图 F-1

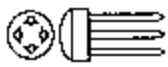
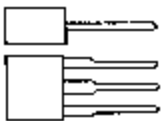
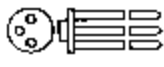

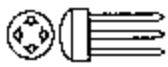
器件型号 Element type	厂名 Manufacturers	材料用途参数 Material Purpose Parameter	图号 Figure	国内外相似替换器件型号 Replace of similar type	备注 Notes	外形参考图 Reference shape
N540CH06	WES	2.4kA, 600V, 0.3A, 3V				
N540CH08	WES	2.4kA, 800V, 0.3A, 3V				
N540CH10	WES	2.4kA, 1kV, 0.3A, 3V				
N540CH12	WES	2.4kA, 1.2kV, 0.3A, 3V				
N540CH14	WES	2.4kA, 1.4kV, 0.3A, 3V				
N600CH02	WES	600A, 200V, 0.3A, 3V				
N600CH04	WES	600A, 400V, 0.3A, 3V				
N600CH06	WES	600A, 600V, 0.3A, 3V				
N600CH08	WFS	600A, 800V, 0.3A, 3V				
N600CH10	WES	600A, 1kV, 0.3A, 3V				
N600CH12	WES	600A, 1.2kV, 0.3A, 3V				
NAE30	NAE	35A, 50V, 0.04A, 2.5V	F-48			
NAE35	NAE	35A, 50V, 0.04A, 2.5V	F-48			
NAE40	NAE	35A, 50V, 0.08A, 2.5V	F-48			
NAE45	NAE	35A, 50V, 0.08A, 3V	F-48			
NAE50	NAE	35A, 50V, 0.08A, 3V	F-48			
NAS006P	NAS	1.6A, 50V, 500 μ A, 1V	B-51			
NAS006Q	NAS	1.6A, 100V, 500 μ A, 1V	B-51			
NAS006R	NAS	1.6A, 200V, 500 μ A, 1V	B-51			
NAS006S	NAS	1.6A, 400V, 500 μ A, 1V	B-51			
NAS006T	NAS	1.6A, 600V, 500 μ A, 1V	B-51			
NAS106P	NAS	4A, 50V, 0.01A, 1.5V				
NAS106R	NAS	4A, 200V, 0.01A, 1.5V				
NAS106S	NAS	4A, 400V, 0.01A, 1.5V				

器件型号 Element type	厂名 Manufacturers	材料用途参数 Material Purpose Parameter	图号 Figure	国内外相似替换器件型号 Replaco of similar type	备注 Notes	外形参考图 Reference shape
NAS0161	NAS	1.6A, 100V, 0.025A, 1V	B-47			 图 B-47
NAS0162	NAS	1.6A, 200V, 0.025A, 1V	B-47			
NAS0164	NAS	1.6A, 400V, 0.025A, 1V	B-47			
NAS0166	NAS	1.6A, 600V, 0.025A, 1V	B-47			
NAS206P	NAS	6A, 50V, 0.015A, 1.5V				 图 B-4
NAS206Q	NAS	6A, 100V, 0.015A, 1.5V				
NAS206R	NAS	6A, 200V, 0.015A, 1.5V				
NAS206S	NAS	6A, 400V, 0.015A, 1.5V				
NAS206T	NAS	6A, 600V, 0.015A, 1.5V				
NAS246A	NAS	10A, 500V, 0.015A, 1.5V				
NAS0301	NAS	3A, 100V, 0.025A, 1V	B-4			 图 B-66
NAS0302	NAS	3A, 200V, 0.025A, 1V	B-4			
NAS0304	NAS	3A, 400V, 0.025A, 1V	B-4			
NAS0306	NAS	3A, 600V, 0.025A, 1V	B-4			
NAS306P	NAS	8.5A, 50V, 0.015A, 1.5V				 图 B-4
NAS306Q	NAS	8.5A, 100V, 0.015A, 1.5V				
NAS306R	NAS	8.5A, 200V, 0.015A, 1.5V				
NAS306S	NAS	8.5A, 400V, 0.015A, 1.5V				
NAS306T	NAS	8.5A, 600V, 0.015A, 1.5V				
NAS0351	NAS	3.5A, 100V, 0.025A, 1V				 图 B-47
NAS0352	NAS	3.5A, 200V, 0.025A, 1V				
NAS0354	NAS	3.5A, 400V, 0.025A, 1V				
NAS0356	NAS	3.5A, 600V, 0.025A, 1V				
NAS0651	NAS	6.5A, 100V, 0.025A, 1V	B-66			

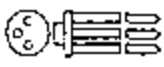

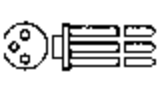
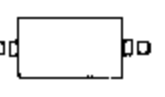

器件型号 Element type	厂名 Manufacturers	材料用途参数 Material Purpose Parameter	图号 Figure	国内外相似替换器件型号 Replace of similar type	备注 Notes	外形参考图 Reference shape
NAS0652	NAS	6.5A, 200V, 0.025A, 1V	B-66			 图 B-66
NAS0654	NAS	6.5A, 400V, 0.025A, 1V	B-66			
NAS0656	NAS	6.5A, 600V, 0.025A, 1V	B-66			
NAS806P#1	NAS	16A, 50V, 0.02A, 1.5V				
NAS806P#2	NAS	16A, 50V, 0.02A, 1.5V	F-50			
NAS806Q#1	NAS	16A, 100V, 0.02A, 1.5V				
NAS806R#1	NAS	16A, 200V, 0.02A, 1.5V				
NAS806R#2	NAS	16A, 200V, 0.02A, 1.5V	F-50			
NAS806S#1	NAS	16A, 400V, 0.02A, 1.5V				
NAS806S#2	NAS	16A, 400V, 0.02A, 1.5V	F-50			
NAS806T#1	NAS	16A, 600V, 0.02A, 1.5V				
NAS806T#2	NAS	16A, 600V, 0.02A, 1.5V	F-50			
NAS815P	NAS	25A, 50V, 0.025A, 2V	F-50			 图 F-50
NAS815Q	NAS	25A, 100V, 0.025A, 2V	F-50			
NAS815R	NAS	25A, 200V, 0.025A, 2V	F-50			
NAS815S	NAS	25A, 400V, 0.025A, 2V	F-50			
NAS815T	NAS	25A, 600V, 0.025A, 2V	F-50			
NAS815U	NAS	25A, 800V, 0.025A, 2V	F-50			
NAS0851	NAS	8.5A, 100V, 0.025A, 1V	B-66			
NAS0852	NAS	8.5A, 200V, 0.025A, 1V	B-66			
NAS0854	NAS	8.5A, 400V, 0.025A, 1V	B-66			
NAS0856	NAS	8.5A, 600V, 0.025A, 1V	B-66			
NAS915P	NAS	35A, 50V, 0.025A, 2V	F-50			
NAS915Q	NAS	35A, 100V, 0.025A, 2V	F-50			
NAS915R	NAS	35A, 200V, 0.025A, 2V	F-50			

器件型号 Element type	厂名 Manufacturers	材料用途参数 Material Purpose Parameter	图号 Figure	国内外相似替换器件型号 Replace of similar type	备注 Notes	外形参考图 Reference shape
NAS915S	NAS	35A, 400V, 0.025A, 2V	F-50			
NAS915T	NAS	35A, 600V, 0.025A, 2V	F-50			
NAS915U	NAS	35A, 800V, 0.025A, 2V	F-50			
NAS1001	NAS	10A, 100V, 0.025A, 1V	B-66			
NAS1002	NAS	10A, 200V, 0.025A, 1V	B-66			
NAS1004	NAS	10A, 400V, 0.025A, 1V	B-66			
NAS1006	NAS	10A, 600V, 0.025A, 1V	B-66			
NAS1601	NAS	16A, 100V, 0.025A, 1V	B-66			
NAS1602	NAS	16A, 200V, 0.025A, 1V	B-66			
NAS1604	NAS	16A, 400V, 0.025A, 1V	B-66			
NAS1606	NAS	16A, 600V, 0.025A, 1V	B-66			
NAS4441	NAS	5A, 50V, 0.025A, 1.5V				
NAS4442	NAS	5A, 200V, 0.025A, 1.5V				
NAS4443	NAS	5A, 400V, 0.025A, 1.5V				
NAS4444	NAS	5A, 600V, 0.025A, 1.5V				
NASB-T109	NAS	6.5A, 500V, 0.01A, 2V				
NASD32	NAS	DAC 0.22A, 3V, 28V, 6V	A-1			
NCF020C	NAE	6A, 25V, 0.03A, 2V	F-8			
NCF020D	NAE	10A, 20V, 0.05A, 3.5V	F-48			
NCF050C	NAE	6A, 50V, 0.03A, 2V	F-8			
NCF050D	NAE	10A, 50V, 0.05A, 3.5V	F-48			
NCF100C	NAE	6A, 100V, 0.03A, 2V	F-8			
NCF100D	NAE	10A, 100V, 0.05A, 3.5V	F-48			

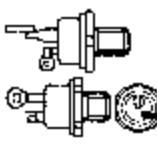



器件型号 Element type	厂名 Manufacturers	材料用途参数 Material Purpose Parameter	图号 Figure	国内外相似替换器件型号 Replace of similar type	备注 Notes	外形参考图 Reference shape	
NCF150C	NAE	6A, 150V, 0.03A, 2V	F-8			 图 F-8	
NCF150D	NAE	10A, 150V, 0.05A, 3.5V	F-48				
NCF200C	NAE	6A, 200V, 0.03A, 2V	F-8				
NCF200D	NAE	10A, 200V, 0.05A, 3.5V	F-48				
NCF250C	NAE	6A, 250V, 0.03A, 2V	F-8				
NCF250D	NAE	10A, 250V, 0.05A, 3.5V	F-48				
NCF300C	NAE	6A, 300V, 0.03A, 2V	F-8				
NCF300D	NAE	10A, 300V, 0.05A, 3.5V	F-48				
NCF400C	NAE	6A, 400V, 0.03A, 2V	F-8				
NCF400D	NAE	10A, 400V, 0.05A, 3.5V	F-48				
NCF500C	NAE	6A, 500V, 0.03A, 2V	F-8				
NCF500D	NAE	10A, 500V, 0.05A, 3.5V	F-48				
NCF600C	NAE	6A, 600V, 0.03A, 2V	F-8				
NCF600D	NAE	10A, 600V, 0.05A, 3.5V	F-48				
NCM050C	NAE	3A, 50V, 0.03A, 1.5V	F-8				 图 F-8
NCM100C	NAE	3A, 100V, 0.03A, 1.5V	F-8				
NCM100E	NAE	10A, 100V, 0.15A, 2V	F-48				
NCM200C	NAE	3A, 200V, 0.03A, 1.5V	F-8				
NCM200E	NAE	10A, 200V, 0.15A, 2V	F-48				
NCM300C	NAE	3A, 300V, 0.03A, 1.5V	F-8				
NCM300E	NAE	10A, 300V, 0.15A, 2V	F-48				
NCM400C	NAE	3A, 400V, 0.03A, 1.5V	F-8				
NCM400E	NAE	10A, 400V, 0.15A, 2V	F-48				
NCM500C	NAE	3A, 500V, 0.03A, 1.5V	F-8				
NCM500F	NAE	10A, 500V, 0.15A, 2V	F-48				
NCM600C	NAE	3A, 600V, 0.03A, 1.5V	F-8				
NCM600E	NAE	10A, 600V, 0.15A, 2V	F-48				
NCM700C	NAE	3A, 700V, 0.03A, 1.5V	F-8				

器件型号 Element type	厂名 Manufacturers	材料用途参数 Material Purpose Parameter	图号 Figure	国内外相似替换器件型号 Replace of similar type	备注 Notes	外形参考图 Reference shape
NCR020B	NAE	3A, 25V, 0.025A, 2.5V	F-8			 图 F-8
NCR050B	NAE	3A, 50V, 0.025A, 2.5V	F-8			
NCR150B	NAE	3A, 150V, 0.025A, 2.5V	F-8			
NCR200B	NAE	3A, 200V, 0.025A, 2.5V	F-8			
NCR300B	NAE	3A, 300V, 0.025A, 2.5V	F-8			
NCR400B	NAE	3A, 400V, 0.025A, 2.5V	F-8			
NCR500B	NAE	3A, 500V, 0.025A, 2.5V	F-8			
NCR600B	NAE	3A, 600V, 0.025A, 2.5V	F-8			
NL511-3	ASI	16A, 960V, 0.08A, 3V	F-48			
NL511-4	ASI	16A, 1kV, 0.08A, 3V	F-48			
NL511-6	ASI	16A, 1.2kV, 0.08A, 3V	F-48			
NL570A	ASI	35A, 100V, 0.08A, 3V	F-48			
NL570B	ASI	35A, 200V, 0.08A, 3V	F-48			
NL570C	ASI	35A, 300V, 0.08A, 3V	F-48			
NL570D	ASI	35A, 400V, 0.08A, 3V	F-48			
NL570E	ASI	35A, 500V, 0.08A, 3V	F-48			
NL570M	ASI	35A, 600V, 0.08A, 3V	F-48			
NL576B	ASI	55A, 200V, 0.15A, 3V	F-23			 图 F-23
NL576C	ASI	55A, 300V, 0.15A, 3V	F-23			
NL576D	ASI	55A, 400V, 0.15A, 3V	F-23			
NL576E	ASI	55A, 500V, 0.15A, 3V	F-23			
NL576M	ASI	55A, 600V, 0.15A, 3V	F-23			
NL576N	ASI	55A, 800V, 0.15A, 3V	F-23			
NL576P	ASI	55A, 1kV, 0.15A, 3V	F-23			
NL576PA	ASI	55A, 1.1kV, 0.15A, 3V	F-23			
NL576PB	ASI	55A, 1.2kV, 0.15A, 3V	F-23			

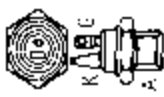

器件型号 Element type	厂名 Manufacturers	材料用途参数 Material Purpose Parameter	图号 Figure	国内外相似替换器件型号 Roplace of similar type	备注 Notes	外形参考图 Reference shape
NL576S	ASI	55A, 700V, 0.15A, 3V	F-23			 图 F-23
NL576T	ASI	55A, 900V, 0.15A, 3V	F-23			
NL577B	ASI	55A, 200V, 0.15A, 3V	F-23			
NL577C	ASI	55A, 300V, 0.15A, 3V	F-23			
NL577D	ASI	55A, 400V, 0.15A, 3V	F-23			
NL577E	ASI	55A, 500V, 0.15A, 3V	F-23			
NL577M	ASI	55A, 600V, 0.15A, 3V	F-23			
NL577N	ASI	55A, 800V, 0.15A, 3V	F-23			
NL577PA	ASI	55A, 1.1KV, 0.15A, 3V	F-23			
NL577PB	ASI	55A, 1.2KV, 0.15A, 3V	F-23			
NL577S	ASI	55A, 700V, 0.15A, 3V	F-23			
NL577T	ASI	55A, 900V, 0.15A, 3V	F-23			
NL578B	ASI	63A, 200V, 0.15A, 3V	F-23			
NL578C	ASI	63A, 300V, 0.15A, 3V	F-23			
NL578D	ASI	63A, 400V, 0.15A, 3V	F-23			
NL578E	ASI	63A, 500V, 0.15A, 3V	F-23			
NL578M	ASI	63A, 600V, 0.15A, 3V	F-23			
NL578N	ASI	63A, 800V, 0.15A, 3V	F-23			
NL578P	ASI	63A, 1KV, 0.15A, 3V	F-23			
NL578PA	ASI	63A, 1.1KV, 0.15A, 3V	F-23			
NL578PB	ASI	63A, 1.2KV, 0.15A, 3V	F-23			
NL578S	ASI	63A, 700V, 0.15A, 3V	F-23			
NL578T	ASI	63A, 900V, 0.15A, 3V	F-23			
NL579B	ASI	63A, 200V, 0.15A, 3V	F-23			
NL579C	ASI	63A, 300V, 0.15A, 3V	F-23			
NL579D	ASI	63A, 400V, 0.15A, 3V	F-23			
NL579E	ASI	63A, 500V, 0.15A, 3V	F-23			
NL579M	ASI	63A, 600V, 0.15A, 3V	F-23			
NL579N	ASI	63A, 800V, 0.15A, 3V	F-23			

器件型号 Element type	厂名 Manufacturers	材料用途参数 Material Purpose Parameter	图号 Figure	国内外相似替换器件型号 Replace of similar type	备注 Notes	外形参考图 Reference shape
NL579P	ASI	63A, 1kV, 0.15A, 3V	F-23			
NL579PA	ASI	63A, 1.1kV, 0.15A, 3V	F-23			图 F-23
NL579PB	ASI	63A, 1.2kV, 0.15A, 3V	F-23			
NL579S	ASI	63A, 700V, 0.15A, 3V	F-23			
NL579T	ASI	63A, 900V, 0.15A, 3V	F-23			
NL1580A	ASI, VAN	625A, 100V, 0.15A, 6.5V				
NL1580B	ASI, VAN	625A, 200V, 0.15A, 6.5V				
NL1580C	ASI, VAN	625A, 300V, 0.15A, 6.5V				
NL1580D	ASI, VAN	625A, 400V, 0.15A, 6.5V				
NL1580E	ASI, VAN	625A, 500V, 0.15A, 6.5V				
NL1580M	ASI, VAN	625A, 600V, 0.15A, 6.5V				
NL1580N	ASI, VAN	625A, 800V, 0.15A, 6.5V				
NL1580P	ASI, VAN	625A, 1kV, 0.15A, 6.5V				
NL1580PA	ASI, VAN	625A, 1.1kV, 0.15A, 6.5V				
NL1580PB	ASI, VAN	625A, 1.2kV, 0.15A, 6.5V				
NL1580PC	ASI, VAN	625A, 1.3kV, 0.15A, 6.5V				
NL1580PD	ASI, VAN	625A, 1.4kV, 0.15A, 6.5V				
NL1580PE	ASI, VAN	625A, 1.5kV, 0.15A, 6.5V				
NL1580PM	VAN	625A, 1.6kV, 0.15A, 6.5V				
NL1580PS	VAN	625A, 1.7kV, 0.15A, 6.5V	C-4			
NL1580S	ASI, VAN	625A, 700V, 0.15A, 6.5V	C-4			
NL1580T	ASI, VAN	625A, 900V, 0.15A, 6.5V	C-4			
NLC52H	VAN	110A, 250V, 0.07A, 3V	B-74			
NLC147B	VAN	40A, 200V, 0.15A, 3V	F-21			图 F-21
NLC147C	VAN	40A, 300V, 0.15A, 3V	F-21			
NLC147D	VAN	40A, 400V, 0.15A, 3V	F-21			



器件型号 Element type	厂名 Manufacturers	材料用途参数 Material Purpose Parameter	图号 Figure	国内外相似替换器作型号 Replace of similar type	备注 Notes	外形参考图 Reference shape
NLC147E	VAN	40A, 500V, 0.15A, 3V	F-21			
NLC147M	VAN	40A, 600V, 0.15A, 3V	F-21			
NLC147N	VAN	40A, 800V, 0.15A, 3V	F-21			
NLC147P	VAN	40A, 1kV, 0.15A, 3V	F-21			
NLC147PA	VAN	40A, 1.1kV, 0.15A, 3V	F-21			
NLC147S	VAN	40A, 700V, 0.15A, 3V	F-21			
NLC147T	VAN	40A, 900V, 0.15A, 3V	F-21			
NLC154B	VAN	110A, 200V, 0.5A, 3.5V	F-91			
NLC154C	VAN	110A, 300V, 0.5A, 3.5V	F-91			
NLC154D	VAN	110A, 400V, 0.5A, 3.5V	F-91			
NLC154E	VAN	110A, 500V, 0.5A, 3.5V	F-91			
NLC154M	VAN	110A, 600V, 0.5A, 3.5V	F-91			
NLC154N	VAN	110A, 800V, 0.5A, 3.5V	F-91			
NLC154P	VAN	110A, 1kV, 0.5A, 3.5V	F-91			
NLC154PA	VAN	110A, 1.1kV, 0.5A, 3.5V	F-91			
NLC154S	VAN	110A, 700V, 0.5A, 3.5V	F-91			
NLC154T	VAN	110A, 900V, 0.5A, 3.5V	F-91			
NLC178A	VAN	200A, 100V, 0.3A, 2.5V	F-91			
NLC178B	VAN	200A, 200V, 0.3A, 2.5V	F-91			
NLC178C	VAN	200A, 300V, 0.3A, 2.5V	F-91			
NLC178D	VAN	200A, 400V, 0.3A, 2.5V	F-91			
NLC178E	VAN	200A, 500V, 0.3A, 2.5V	F-91			
NLC178M	VAN	200A, 600V, 0.3A, 2.5V	F-91			
NLC178N	VAN	200A, 800V, 0.3A, 2.5V	F-91			
NLC178P	VAN	200A, 1kV, 0.3A, 2.5V	F-91			
NLC178PA	VAN	200A, 1.1kV, 0.3A, 2.5V	F-91			
NLC178PB	VAN	200A, 1.2kV, 0.3A, 2.5V	F-91			



图 F-21



图 F-91

器件型号 Element type	厂名 Manufacturers	材料用途参数 Material Purpose Parameter	图号 Figure	国内外相似替换器件型号 Replaco of similar type	备注 Notes	外形参考图 Reference shape
NLC178S	VAN	200A, 700V, 0.3A, 2.5V	F-91			 图 F-91
NLC178T	VAN	200A, 900V, 0.3A, 2.5V	F-91			
NLC180A	VAN	235A, 100V, 0.15A, 2.5V	F-91			
NLC180B	VAN	235A, 200V, 0.15A, 2.5V	F-91			
NLC180C	VAN	235A, 300V, 0.15A, 2.5V	F-91			
NLC180D	VAN	235A, 400V, 0.15A, 2.5V	F-91			
NLC180E	VAN	235A, 500V, 0.15A, 2.5V	F-91			
NLC180M	VAN	235A, 600V, 0.15A, 2.5V	F-91			
NLC180N	VAN	235A, 800V, 0.15A, 2.5V	F-91			
NLC180P	VAN	235A, 1KV, 0.15A, 2.5V	F-91			
NLC180PA	VAN	235A, 1.1KV, 0.15A, 3V	F-91			
NLC180PB	VAN	235A, 1.2KV, 0.15A, 2.5V	F-91			
NLC180PC	VAN	235A, 1.3KV, 0.15A, 3V	F-91			
NLC180S	VAN	235A, 700V, 0.15A, 2.5V	F-91			
NLC180T	VAN	235A, 900V, 0.15A, 2.5V	F-91			
NLC181A	VAN	235A, 100V, 0.3A, 3V	F-91			
NLC181B	VAN	235A, 200V, 0.3A, 2.5V	F-91			
NLC181C	VAN	235A, 300V, 0.3A, 3V	F-91			
NLC181D	VAN	235A, 400V, 0.3A, 3V	F-91			
NLC181E	VAN	235A, 500V, 0.3A, 3V	F-91			
NLC181M	VAN	235A, 600V, 0.3A, 3V	F-91			
NLC181N	VAN	235A, 800V, 0.3A, 3V	F-91			
NLC181P	VAN	235A, 1KV, 0.3A, 3V	F-91			
NLC181S	VAN	235A, 700V, 0.3A, 3V	F-91			
NLC181T	VAN	235A, 900V, 0.3A, 3V	F-91			
NLC184A	VAN	300A, 100V, 0.3A, 2.5V	F-91			
NLC184B	VAN	300A, 200V, 0.3A, 2.5V	F-91			



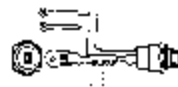
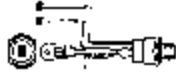

器件型号 Element type	厂名 Manufacturers	材料用途参数 Material Purpose Parameter	图号 Figure	国内外相似替换器件型号 Replace of similar type	备注 Notes	外形参考图 Reference shape
NLC184C	VAN	300A, 300V, 0.3A, 2.5V	F-91			 图 F-91
NLC184D	VAN	300A, 400V, 0.3A, 2.5V	F-91			
NLC184E	VAN	300A, 500V, 0.3A, 2.5V	F-91			
NLC184M	VAN	300A, 600V, 0.3A, 2.5V	F-91			
NLC185A	VAN	235A, 100V, 0.3A, 3V	F-91			
NLC185B	VAN	235A, 200V, 0.3A, 3V	F-91			
NLC185C	VAN	235A, 300V, 0.3A, 3V	F-91			
NLC185D	VAN	235A, 400V, 0.3A, 3V	F-91			
NLC185E	VAN	235A, 500V, 0.3A, 3V	F-91			
NLC185M	VAN	235A, 600V, 0.3A, 3V	F-91			
NLC280A	VAN	200A, 100V, 0.15A, 3V	F-71			 图 F-71
NLC280B	VAN	200A, 200V, 0.15A, 3V	F-71			
NLC280C	VAN	200A, 300V, 0.15A, 3V	F-71			
NLC280D	VAN	200A, 400V, 0.15A, 3V	F-71			
NLC280E	VAN	200A, 500V, 0.15A, 3V	F-71			
NLC280M	VAN	200A, 600V, 0.15A, 3V	F-71			
NLC280N	VAN	200A, 800V, 0.15A, 3V	F-71			
NLC280P	VAN	200A, 1kV, 0.15A, 3V	F-71			
NLC280PA	VAN	200A, 1.1kV, 0.15A, 3V	F-71			
NLC280PB	VAN	200A, 1.2kV, 0.15A, 3V	F-71			
NLC280S	VAN	200A, 700V, 0.15A, 3V	F-71			
NLC280T	VAN	200A, 900V, 0.15A, 3V	F-71			
NLC281A	VAN	200A, 100V, 0.15A, 3V	D-37			
NLC281B	VAN	200A, 200V, 0.15A, 3V	D-37			
NLC281C	VAN	200A, 300V, 0.15A, 3V	D-37			
NLC281D	VAN	200A, 400V, 0.15A, 3V	D-37			
NLC281E	VAN	200A, 500V, 0.15A, 3V	D-37			
NLC281M	VAN	200A, 600V, 0.15A, 3V	D-37			

图 D-37



器件型号 Element type	厂名 Manufacturers	材料用途参数 Material Purpose Parameter	图号 Figure	国内外相似替换器件型号 Replace of similar type	备注 Notes	外形参考图 Reference shape
NLC281N	VAN	200A, 600V, 0.15A, 3V	D-37			 图 D-37
NLC281P	VAN	200A, 1kV, 0.15A, 3V	D-37			
NLC281PA	VAN	200A, 1.1kV, 0.15A, 3V	D-37			
NLC281PB	VAN	200A, 1.2kV, 0.15A, 3V	D-37			
NLC281S	VAN	200A, 700V, 0.15A, 3V	D-37			
NLC281T	VAN	200A, 900V, 0.15A, 3V	D-37			
NLC290A	VAN	470A, 100V, 0.15A, 3V	F-71			 图 F-71
NLC290B	VAN	470A, 200V, 0.15A, 3V	F-71			
NLC290C	VAN	470A, 300V, 0.15A, 3V	F-71			
NLC290D	VAN	470A, 400V, 0.15A, 3V	F-71			
NLC290E	VAN	470A, 500V, 0.15A, 3V	F-71			
NLC290M	VAN	470A, 600V, 0.15A, 3V	F-71			
NLC290N	VAN	470A, 800V, 0.15A, 3V	F-71			
NLC290P	VAN	470A, 1kV, 0.15A, 3V	F-71			
NLC290PA	VAN	470A, 1.1kV, 0.15A, 3V	F-71			
NLC290PB	VAN	470A, 1.3kV, 0.15A, 3V	F-71			
NLC290S	VAN	470A, 700V, 0.15A, 3V	F-71			
NLC290T	VAN	470A, 900V, 0.15A, 3V	F-71			
NLC291A	VAN	470A, 100V, 0.15A, 3V	D-37			
NLC291B	VAN	470A, 200V, 0.15A, 3V	D-37			
NLC291C	VAN	470A, 300V, 0.15A, 3V	D-37			
NLC291D	VAN	470A, 400V, 0.15A, 3V	D-37			
NLC291E	VAN	470A, 500V, 0.15A, 3V	D-37			
NLC291M	VAN	470A, 600V, 0.15A, 3V	D-37			
NLC291N	VAN	470A, 800V, 0.15A, 3V	D-37			
NLC291P	VAN	470A, 1kV, 0.15A, 3V	D-37			
NLC291PA	VAN	470A, 1.1kV, 0.15A, 3V	D-37			
NLC291PB	VAN	470A, 1.2kV, 0.15A, 3V	D-37			

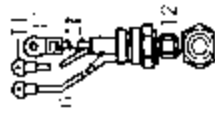
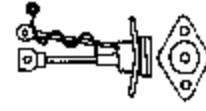



器件型号 Element type	厂名 Manufacturers	材料 Material	用途 Purpose	参数 Parameter	图号 Figure	国内外相似替换器件型号 Replace of similar type	备注 Notes	外形参考图 Reference shape
NLC291S	VAN	470A, 700V, 0.15A, 3V			D-37			
NLC291T	VAN	470A, 900V, 0.15A, 3V			D-37			
NLC295A	VAN	470A, 100V, 0.3A, 3.5V			F-71			
NLC295B	VAN	470A, 200V, 0.3A, 3.5V			F-71			
NLC295C	VAN	470A, 300V, 0.3A, 3.5V			F-71			
NLC295D	VAN	470A, 400V, 0.3A, 3.5V			F-71			
NLC295E	VAN	470A, 500V, 0.3A, 3.5V			F-71			
NLC295M	VAN	470A, 600V, 0.3A, 3.5V			F-71			
NLC297A	VAN	470A, 100V, 0.3A, 3.5V			D-37			
NLC297B	VAN	470A, 200V, 0.3A, 3.5V			D-37			
NLC297C	VAN	470A, 300V, 0.3A, 3.5V			D-37			
NLC297D	VAN	470A, 400V, 0.3A, 3.5V			D-37			
NLC297E	VAN	470A, 500V, 0.3A, 3.5V			D-37			
NLC297F	VAN	470A, 500V, 0.3A, 3.5V			D-37			
NLC297M	VAN	470A, 600V, 0.3A, 3.5V			D-37			
NLC350A	VAN	175A, 100V, 0.15A, 2.5V			C-10			
NLC350B	VAN	175A, 200V, 0.15A, 2.5V			C-10			
NLC350C	VAN	175A, 300V, 0.15A, 2.5V			C-10			
NLC350D	VAN	175A, 400V, 0.15A, 2.5V			C-10			
NLC350E	VAN	175A, 500V, 0.15A, 2.5V			C-10			
NLC350M	VAN	175A, 600V, 0.15A, 2.5V			C-10			
NLC350N	VAN	175A, 800V, 0.15A, 2.5V			C-10			
NLC350P	VAN	175A, 1kV, 0.15A, 2.5V			C-10			
NLC350PA	VAN	175A, 1.1kV, 0.15A, 2.5V			C-10			
NLC350PB	VAN	175A, 1.2kV, 0.15A, 2.5V			C-10			
NLC350PC	VAN	175A, 1.3kV, 0.15A, 2.5V			C-10			
NLC350S	VAN	175A, 700V, 0.15A, 2.5V			C-10			

图 D-37

图 F-71

图 C-10

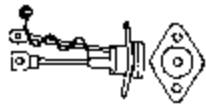
器件型号 Element type	厂名 Manufacturers	材料用途参数 Material Purpose Parameter	图号 Figure	国内外相似替换器件型号 Replace of similar type	备注 Notes	外形参考图 Reference shape
NLC350T	VAN	175A, 900V, 0.15A, 2.5V	C-10			
NLC354A	VAN	175A, 100V, 0.15A, 2.5V	C-10			
NLC354B	VAN	175A, 200V, 0.15A, 2.5V	C-10			
NLC354C	VAN	175A, 300V, 0.15A, 2.5V	C-10			
NLC354D	VAN*	175A, 400V, 0.15A, 2.5V	C-10			
NLC354E	VAN	175A, 500V, 0.15A, 2.5V	C-10			
NLC354M	VAN	175A, 600V, 0.15A, 2.5V	C-10			
NLC355A	VAN	175A, 100V, 0.15A, 2.5V	C-10			
NLC355B	VAN	175A, 200V, 0.15A, 2.5V	C-10			
NLC355C	VAN	175A, 300V, 0.15A, 2.5V	C-10			
NLC355D	VAN	175A, 400V, 0.15A, 2.5V	C-10			
NLC355E	VAN	175A, 500V, 0.15A, 2.5V	C-10			
NLC355M	VAN	175A, 600V, 0.15A, 2.5V	C-10			
NLC380A	VAN	380A, 100V, 0.15A, 2.5V	C-10			
NLC380B	VAN	380A, 200V, 0.15A, 2.5V	C-10			
NLC380C	VAN	380A, 300V, 0.15A, 2.5V	C-10			
NLC380D	VAN	380A, 400V, 0.15A, 2.5V	C-10			
NLC380E	VAN	380A, 500V, 0.15A, 2.5V	C-10			
NLC380M	VAN	380A, 600V, 0.15A, 2.5V	C-10			
NLC380N	VAN	380A, 800V, 0.15A, 2.5V	C-10			
NLC380P	VAN	380A, 1kV, 0.15A, 2.5V	C-10			
NLC380PB	VAN	380A, 1.2kV, 0.15A, 2.5V	C-10			
NLC380PC	VAN	380A, 1.3kV, 0.15A, 2.5V	C-10			
NLC380S	VAN	380A, 700V, 0.15A, 2.5V	C-10			
NLC380T	VAN	380A, 900V, 0.15A, 2.5V	C-10			
NLC385A	VAN	380A, 100V, 0.15A, 2.5V	C-10			

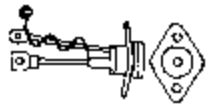
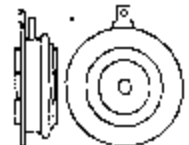



图 C-10

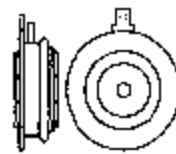
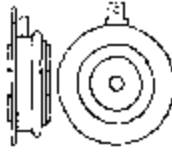

器件型号 Element type	厂名 Manufacturers	材料用途参数 Material Purpose Parameter	图号 Figure	国内外相似替换器件型号 Replace of similar type	备注 Notes	外形参考图 Reference shape
NLC385C	VAN	380A, 300V, 0.15A, 2.5V	C-10			 图 C-10
NLC385D	VAN	380A, 400V, 0.15A, 2.5V	C-10			
NLC385E	VAN	380A, 500V, 0.15A, 2.5V	C-10			
NLC385M	VAN	380A, 600V, 0.15A, 2.5V	C-10			
NLC501A	VAN	550A, 100V, 0.15A, 6.5V	C-4			 图 C-4
NLC501B	VAN	550A, 200V, 0.15A, 6.5V	C-4			
NLC501C	VAN	550A, 300V, 0.15A, 6.5V	C-4			
NLC501D	VAN	550A, 400V, 0.15A, 6.5V	C-4			
NLC501E	VAN	550A, 500V, 0.15A, 6.5V	C-4			
NLC501M	VAN	550A, 600V, 0.15A, 6.5V	C-4			
NLC501N	VAN	550A, 800V, 0.15A, 6.5V	C-4			
NLC501P	VAN	550A, 1kV, 0.15A, 6.5V	C-4			
NLC501PA	VAN	550A, 1.1kV, 0.15A, 6.5V	C-4			
NLC501PB	VAN	550A, 1.2kV, 0.15A, 6.5V	C-4			
NLC501PC	VAN	550A, 1.3kV, 0.15A, 6.5V	C-4			
NLC501PE	VAN	550A, 1.5kV, 0.15A, 6.5V	C-4			
NLC501PM	VAN	550A, 1.6kV, 0.15A, 6.5V	C-4			
NLC501PS	VAN	550A, 1.7kV, 0.15A, 6.5V	C-4			
NLC501S	VAN	550A, 700V, 0.15A, 6.5V	C-4			
NLC501T	VAN	550A, 900V, 0.15A, 6.5V	C-4			
NLC601N	VAN	1.2A, 800V, 0.15A, 6.5V				
NLC601P	VAN	1.2A, 1kV, 0.15A, 6.5V				
NLC601PA	VAN	1.2A, 1.1kV, 0.15A, 6.5V				
NLC601PB	VAN	1.2A, 1.2kV, 0.15A, 6.5V				
NLC601PC	VAN	1.2A, 1.3kV, 0.15A, 6.5V				
NLC601PD	VAN	1.2A, 1.4kV, 0.15A, 6.5V				
NLC601PE	VAN	1.2A, 1.5kV, 0.15A, 6.5V				

器件型号 Element type	厂名 Manufacturers	材料用途参数 Material Purpose Parameter	图号 Figure	国内外相似替换器件型号 Replce of similar type	备注 Notes	外形参考图 Reference shape
NLC601PM	VAN	1.2A, 1.6KV, 0.15A, 6.5V				
NLC601T	VAN	1.2A, 900V, 0.15A, 6.5V				
NLC602L	VAN	700A, 2KV, 0.075A, 0.15V	B-91			
NLC602LA	VAN	700A, 2.1KV, 0.075A, 0.15V	B 91			
NLC602LB	VAN	700A, 2.2KV, 0.075A, 0.15V	B-91			
NLC602LD	VAN	700A, 2.4KV, 0.075A, 0.15V	B-91			
NLC602LE	VAN	700A, 2.5KV, 0.075A, 0.15V	B-91			
NLC602PN	VAN	700A, 1.8KV, 0.075A, 0.15V	B-91			
NLC602PS	VAN	700A, 1.7KV, 0.075A, 0.15V	B-91			
NLC602PT	VAN	700A, 1.9KV, 0.075A, 0.15V	B-91			
NLC3500L	VAN	500A, 2KV, 0.15A, 3V	C-3			
NLC3500LPC	VAN	500A, 3.3KV, 0.15A, 3V	C-3			
NLC3500LPD	VAN	500A, 3.4KV, 0.15A, 3V	C-3			
NLC3500LPE	VAN	500A, 3.5KV, 0.15A, 3V	C-3			
NLF150B	ASI	110A, 200V, 0.15A, 2.5V	F-91	ECG5570		
NLF150C	ASI	110A, 300V, 0.15A, 2.5V	F-91	ECG5572		
NLF150D	ASI	110A, 400V, 0.15A, 2.5V	F-91	ECG5572		
NLF150E	ASI	110A, 500V, 0.15A, 2.5V	F-91	ECG5572		
NLF150M	ASI	110A, 600V, 0.15A, 2.5V	F-91	ECG5572		
NLF150N	ASI	110A, 800V, 0.15A, 2.5V	F-91	ECG5574		
NLF150P	ASI	110A, 1KV, 0.15A, 2.5V	F-91	ECG5574		
NLF150S	ASI	110A, 700V, 0.15A, 2.5V	F-91	ECG5574		
NLF150T	ASI	110A, 900V, 0.15A, 2.5V	F-91	ECG5574		
NLF151B	ASI	110A, 200V, 0.15A, 2.5V	F-91	ECG5371		
NLF151C	ASI	110A, 300V, 0.15A, 2.5V	F-91	ECG5371		
NLF151D	ASI	110A, 400V, 0.15A, 2.5V	F-91	ECG5371		
NLF151E	ASI	110A, 500V, 0.15A, 2.5V	F-91	ECG5371		



图 B-91





图 C-3

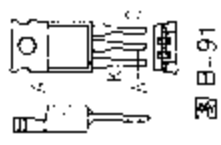

图 F-91

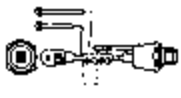
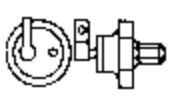



器件型号 Element type	厂名 Manufacturers	材料用途参数 Material Purpose Parameter	图号 Figure	国内外相似替换器型号 Replace of similar type	备注 Notes	外形参考图 Reference shape
NLF151M	ASI	110A, 600V, 0.15A, 2.5V	F-91	ECG5371		
NLF151N	ASI	110A, 800V, 0.15A, 2.5V	F-91	ECG5372		
NLF151P	ASI	110A, 1KV, 0.15A, 2.5V	F-91	ECG5372		
NLF151S	ASI	110A, 700V, 0.15A, 2.5V	F-91	ECG5372		
NLF151T	ASI	110A, 900V, 0.15A, 2.5V	F-91	ECG5372		
NLF152B	ASI	110A, 200V, 0.15A, 2.5V	B-74	ECG5575		
NLF152C	ASI	110A, 300V, 0.15A, 2.5V	B-74			
NLF152D	ASI	110A, 400V, 0.15A, 2.5V	F-91	ECG5577		
NLF152E	ASI	110A, 500V, 0.15A, 2.5V	B-74	ECG5577		
NLF152M	ASI	110A, 600V, 0.15A, 2.5V	B-74	ECG5577		
NLF152N	ASI	110A, 800V, 0.15A, 2.5V	B-74	ECG5579		
NLF152P	ASI	110A, 1KV, 0.15A, 2.5V	B-74	ECG5579		
NLF152S	ASI	110A, 700V, 0.15A, 2.5V	B-74	ECG5579		
NLF152T	ASI	110A, 900V, 0.15A, 2.5V	B-74	ECG5579		
NLF153B	ASI	110A, 200V, 0.15A, 2.5V	B-74	ECG5368		
NLF153C	ASI	110A, 300V, 0.15A, 2.5V	B-74	ECG5368		
NLF153D	ASI	110A, 400V, 0.15A, 2.5V	B-74	ECG5368		
NLF153E	ASI	110A, 500V, 0.15A, 2.5V	B-74	ECG5368		
NLF153M	ASI	110A, 600V, 0.15A, 2.5V	B-74	ECG5368		
NLF153P	ASI	110A, 1KV, 0.15A, 2.5V	B-74	ECG5368		
NLF153S	ASI	110A, 700V, 0.15A, 2.5V	B-74	ECG5368		
NLF153T	ASI	110A, 900V, 0.15A, 2.5V	B-74	ECG5368		
NLF154A	ASI	110A, 100V, 0.15A, 2.5V	F-91			
NLF154B	ASI	110A, 200V, 0.15A, 2.5V	F-91			
NLF154C	ASI	110A, 300V, 0.15A, 2.5V	F-91			
NLF154E	ASI	110A, 500V, 0.15A, 2.5V	F-91			
NLF154M	ASI	110A, 600V, 0.15A, 2.5V	F-91			
NLF155A	ASI	110A, 100V, 0.15A, 2.5V	F-91			
NLF155B	ASI	110A, 200V, 0.15A, 2.5V	F-91			

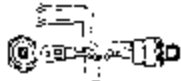

器件型号 Element type	厂名 Manufacturers	材料用途参数 Material Purpose Parameter	图号 Figure	国内外相似替换器件型号 Replace of similar type	备注 Notes	外形参考图 Reference shape
NLF155C	ASI	110A, 300V, 0.15A, 2.5V	F-91			 图 F-91
NLF155D	ASI	110A, 400V, 0.15A, 2.5V	F-91			
NLF155E	ASI	110A, 500V, 0.15A, 2.5V	F-91			
NLF155M	ASI	110A, 600V, 0.15A, 2.5V	F-91			
NLF156A	ASI	110A, 100V, 0.15A, 2.5V	B-74			
NLF156B	ASI	110A, 200V, 0.15A, 2.5V	B-74			
NLF156C	ASI	110A, 300V, 0.15A, 2.5V	B-74			
NLF156D	ASI	110A, 400V, 0.15A, 2.5V	B-74			
NLF156E	ASI	110A, 500V, 0.15A, 2.5V	B-74			
NLF156M	ASI	110A, 600V, 0.15A, 2.5V	B-74			
NLF157A	ASI	110A, 100V, 0.15A, 2.5V	B-74			
NLF157B	ASI	110A, 200V, 0.15A, 2.5V	B-74			
NLF157C	ASI	110A, 300V, 0.15A, 2.5V	B-74			
NLF157D	ASI	110A, 400V, 0.15A, 2.5V	B-74			
NLF157E	ASI	110A, 500V, 0.15A, 2.5V	B-74			
NLF157M	ASI	110A, 600V, 0.15A, 2.5V	B-74			
NLF158A	ASI	110A, 100V, 0.15A, 2.5V	F-91	EG5371		
NLF158B	ASI	110A, 200V, 0.15A, 2.5V	F-91	EG5371		
NLF158C	ASI	110A, 300V, 0.15A, 2.5V	F-91	EG5371		
NLF158D	ASI	110A, 400V, 0.15A, 2.5V	F-91	EG5371		
NLF158E	ASI	110A, 500V, 0.15A, 2.5V	F-91	EG5371		
NLF158M	ASI	110A, 600V, 0.15A, 2.5V	F-91	EG5371		
NLF158N	ASI	110A, 800V, 0.15A, 2.5V	F-91			
NLF158P	ASI	110A, 1kV, 0.15A, 2.5V	F-91			
NLF158S	ASI	110A, 700V, 0.15A, 2.5V	F-91			
NLF158T	ASI	110A, 600V, 0.15A, 2.5V	F-91			
NLF159A	ASI	110A, 100V, 0.15A, 2.5V	B-74	ECT5368		
NLF159B	ASI	110A, 200V, 0.15A, 2.5V	B-74	ECT5368		
NLF159C	ASI	110A, 300V, 0.15A, 2.5V	B-74	ECT5368		

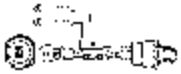
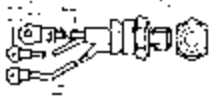

器件型号 Element type	厂名 Manufacturers	材料用途参数 Material Purpose Parameters	图号 Figure	国内外相似替换器件型号 Replace of similar type	备注 Notes	外形参考图 Reference shape	
NLF159D	ASI	110A, 400V, 0.15A, 2.5V	B-74	ECT5368		 图 B-74	
NLF159E	ASI	110A, 500V, 0.15A, 2.5V	B-74	ECT5368			
NLF159M	ASI	110A, 600V, 0.15A, 2.5V	B-74	ECT5368			
NLF159N	ASI	110A, 800V, 0.15A, 2.5V	B-74	ECT5369			
NLF159P	ASI	110A, 1kV, 0.15A, 2.5V	B-74	ECT5369			
NLF159S	ASI	110A, 700V, 0.15A, 2.5V	B-74	ECT5369			
NLF159T	ASI	110A, 900V, 0.15A, 2.5V	B-74	ECT5369			
NLF180A	ASI, VAN	235A, 100V, 0.15A, 2.5V	F-91	ECG5580			 图 F-91
NLF180B	ASI, VAN	235A, 200V, 0.15A, 2.5V	F-91	ECG5580			
NLF180C	ASI, VAN	235A, 300V, 0.15A, 2.5V	F-91	ECG5582			
NLF180D	ASI, VAN	235A, 400V, 0.15A, 2.5V	F-91	ECG5582			
NLF180E	ASI, VAN	235A, 500V, 0.15A, 2.5V	F-91	ECG5582			
NLF180M	ASI, VAN	235A, 600V, 0.15A, 2.5V	F-91	ECG5582			
NLF180N	ASI, VAN	235A, 800V, 0.15A, 2.5V	F-91	ECG5584			
NLF180P	ASI, VAN	235A, 1kV, 0.15A, 2.5V	F-91	ECG5584			
NLF180S	ASI, VAN	235A, 700V, 0.15A, 2.5V	F-91	ECG5584			
NLF180T	ASI, VAN	235A, 900V, 0.15A, 2.5V	F-91	ECG5584			
NLF181A	VAN	250A, 100V, 0.15A, 2.5V	F-91				
NLF181B	VAN	250A, 200V, 0.15A, 2.5V	F-91				
NLF181C	VAN	250A, 300V, 0.15A, 2.5V	F-91				
NLF181D	VAN	250A, 400V, 0.15A, 2.5V	F-91				
NLF181E	VAN	250A, 500V, 0.15A, 2.5V	F-91				
NLF181M	VAN	250A, 600V, 0.15A, 2.5V	F-91				
NLF181N	VAN	250A, 800V, 0.15A, 2.5V	F-91				
NLF181P	VAN	250A, 1kV, 0.15A, 2.5V	F-91				
NLF181S	VAN	250A, 700V, 0.15A, 2.5V	F-91				
NLF181T	VAN	250A, 900V, 0.15A, 2.5V	F-91				

器件型号 Element type	厂名 Manufacturers	材料用途参数 Material Purpose Parameter	图号 Figure	国内外相似替换器型号 Replace of similar type	备注 Notes	外形参考图 Reference shape
NLF184A	VAN	300A, 100V, 0.15A, 2.5V	F-91			 <p>图 F-91</p>  <p>图 F-71</p>  <p>图 D-37</p>
NLF184B	VAN	300A, 200V, 0.15A, 2.5V	F-91			
NLF184C	VAN	300A, 300V, 0.15A, 2.5V	F-91			
NLF184D	VAN	300A, 400V, 0.15A, 2.5V	F-91			
NLF184E	VAN	300A, 500V, 0.15A, 2.5V	F-91			
NLF184M	VAN	300A, 600V, 0.15A, 2.5V	F-91			
NLF185A	ASI, VAN	235A, 100V, 0.15A, 2.5V	F-91			
NLF185B	ASI, VAN	235A, 200V, 0.15A, 2.5V	F-91			
NLF185C	ASI, VAN	235A, 300V, 0.15A, 2.5V	F-91			
NLF185D	ASI, VAN	235A, 400V, 0.15A, 2.5V	F-91			
NLF185E	ASI, VAN	235A, 500V, 0.15A, 2.5V	F-91			
NLF185M	ASI, VAN	235A, 600V, 0.15A, 2.5V	F-91			
NLF280A	VAN	200A, 100V, 0.15A, 2.5V	F-71			
NLF280B	VAN	200A, 200V, 0.15A, 2.5V	F-71			
NLF280C	VAN	200A, 300V, 0.15A, 2.5V	F-71			
NLF280D	VAN	200A, 400V, 0.15A, 2.5V	F-71			
NLF280E	VAN	200A, 500V, 0.15A, 2.5V	F-71			
NLF280M	VAN	200A, 600V, 0.15A, 2.5V	F-71			
NLF280N	VAN	200A, 800V, 0.15A, 2.5V	F-71			
NLF280P	VAN	200A, 1kV, 0.15A, 2.5V	F-71			
NLF280PA	VAN	200A, 1.1kV, 0.15A, 2.5V	F-71			
NLF280PB	VAN	200A, 1.2kV, 0.15A, 2.5V	F-71			
NLF280S	VAN	200A, 700V, 0.15A, 2.5V	F-71			
NLF280T	VAN	200A, 900V, 0.15A, 2.5V	F-71			
NLF281A	VAN	200A, 100V, 0.15A, 2.5V	D-37			
NLF281B	VAN	200A, 200V, 0.15A, 2.5V	D-37			
NLF281C	VAN	200A, 300V, 0.15A, 2.5V	D-37			
NLF281D	VAN	200A, 400V, 0.15A, 2.5V	D-37			

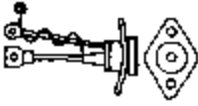

器件型号 Element type	厂名 Manufacturers	材料用途参数 Material Purpose Parameter	图号 Figure	国内外相似替换器件型号 Replace of similar type	备注 Notes	外形参考图 Reference shacc
NLF281E	VAN	200A, 500V, 0.15A, 2.5V	D-37			 <p>图 D-37</p>
NLF281M	VAN	200A, 600V, 0.15A, 2.5V	D-37			
NLF281N	VAN	200A, 800V, 0.15A, 2.5V	D-37			
NLF281PA	VAN	200A, 1.1kV, 0.15A, 2.5V	D-37			
NLF281PB	VAN	200A, 1.2kV, 0.15A, 2.5V	D-37			
NLF281S	VAN	200A, 700V, 0.15A, 2.5V	D-37			
NLF281T	VAN	200A, 900V, 0.15A, 2.5V	D-37			
NLF290A	ASI, VAN	470A, 100V, 0.15A, 2.5V	F-71	ECG5587		
NLF290B	ASI, VAN	470A, 200V, 0.15A, 2.5V	F-71	ECG5587		
NLF290C	ASI, VAN	470A, 300V, 0.15A, 2.5V	F-71	ECG5587		
NLF290D	ASI, VAN	470A, 400V, 0.15A, 2.5V	F-71	ECG5587		
NLF290E	ASI, VAN	470A, 500V, 0.15A, 2.5V	F-71	ECG5587		
NLF290M	ASI, VAN	470A, 600V, 0.15A, 2.5V	F-71	ECG5587		
NLF290N	ASI, VAN	470A, 800V, 0.15A, 2.5V	F-71	ECG5589		
NLF290P	ASI, VAN	470A, 1kV, 0.15A, 2.5V	F-71	ECG5589		
NLF290S	ASI, VAN	470A, 700V, 0.15A, 2.5V	F-71	ECG5589		
NLF290T	ASI, VAN	470A, 900V, 0.15A, 2.5V	F-71	ECG5589		
NLF291A	ASI, VAN	470A, 100V, 0.15A, 2.5V	E-9			 <p>图 E-9</p>
NLF291B	ASI, VAN	470A, 200V, 0.15A, 2.5V	E-9			
NLF291C	ASI, VAN	470A, 300V, 0.15A, 2.5V	E-9			
NLF291D	ASI, VAN	470A, 400V, 0.15A, 2.5V	E-9			
NLF291E	ASI, VAN	470A, 500V, 0.15A, 2.5V	E-9			
NLF291M	ASI, VAN	470A, 600V, 0.15A, 2.5V	E-9			
NLF291N	ASI, VAN	470A, 800V, 0.15A, 2.5V	E-9			
NLF291P	ASI, VAN	470A, 1kV, 0.15A, 2.5V	E-9			
NLF291S	ASI, VAN	470A, 700V, 0.15A, 2.5V	E-9			
NLF291T	ASI, VAN	470A, 900V, 0.15A, 2.5V	E-9			

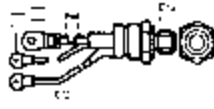
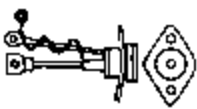
器件型号 Element type	厂名 Manufacturers	材料用途参数 Material Purpose Parameter	图号 Figure	国内外相似替换器型号 Replace of similar type	备注 Notes	外形参考图 Reference shape
NLF295A	ASI, VAN	470A, 100V, 0.15A, 2.5V	F-71			 图 F-71
NLF295B	ASI, VAN	470A, 200V, 0.15A, 2.5V	F-71			
NLF295C	ASI, VAN	470A, 300V, 0.15A, 2.5V	F-71			
NLF295D	ASI, VAN	470A, 400V, 0.15A, 2.5V	F-71			
NLF295E	ASI, VAN	470A, 500V, 0.15A, 2.5V	F-71			
NLF295M	ASI, VAN	470A, 600V, 0.15A, 2.5V	F-71			
NLF297A	ASI, VAN	470A, 100V, 0.15A, 2.5V	D-37			 图 D-37
NLF297B	ASI, VAN	470A, 200V, 0.15A, 2.5V	D-37			
NLF297C	ASI, VAN	470A, 300V, 0.15A, 2.5V	D-37			
NLF297D	ASI, VAN	470A, 400V, 0.15A, 2.5V	D-37			
NLF297E	ASI, VAN	470A, 500V, 0.15A, 2.5V	D-37			
NLF297M	ASI, VAN	470A, 600V, 0.15A, 2.5V	D-37			
NLF350A	ASI, VAN	175A, 100V, 0.15A, 2.5V	C-67	ECG5590		
NLF350B	ASI, VAN	175A, 200V, 0.15A, 2.5V	C-67	ECG5590		
NLF350C	ASI, VAN	175A, 300V, 0.15A, 2.5V	C-67	ECG5591		
NLF350D	ASI, VAN	175A, 400V, 0.15A, 2.5V	C-67	ECG5591		
NLF350E	ASI, VAN	175A, 500V, 0.15A, 2.5V	C-67	ECG5591		
NLF350M	ASI, VAN	175A, 600V, 0.15A, 2.5V	C-67	ECG5591		
NLF350N	ASI, VAN	175A, 800V, 0.15A, 2.5V	C-67	ECG5592		
NLF350P	ASI, VAN	175A, 1kV, 0.15A, 2.5V	C-67	ECG5592		
NLF350S	ASI, VAN	175A, 700V, 0.15A, 2.5V	C-67	ECG5592		
NLF350T	ASI, VAN	175A, 900V, 0.15A, 2.5V	C-67	ECG5592		
NLF354A	ASI, VAN	175A, 100V, 0.15A, 2.5V	C-67			
NLF354B	ASI, VAN	175A, 200V, 0.15A, 2.5V	C-67			
NLF354C	ASI, VAN	175A, 300V, 0.15A, 2.5V	C-67			
NLF354D	ASI, VAN	175A, 400V, 0.15A, 2.5V	C-67			



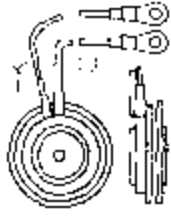
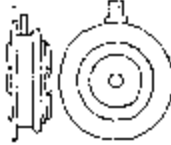

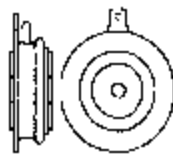
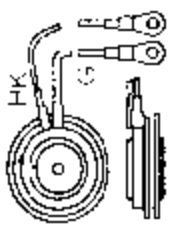
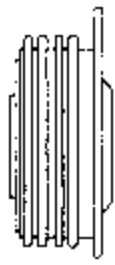
器件型号 Element type	厂名 Manufacturers	材料用途参数 Material Purpose Parameter	图号 Figure	国内外相似替换器件型号 Replace of similar type	备注 Notes	外形参考图 Reference shape
NLF354E	ASI, VAN	175A, 500V, 0.15A, 2.5V	C-67			 <p>图 C-67</p>
NLF354M	ASI, VAN	175A, 600V, 0.15A, 2.5V	C-67			
NLF355A	ASI, VAN	175A, 100V, 0.15A, 2.5V	C-67			
NLF355B	ASI, VAN	175A, 200V, 0.15A, 2.5V	C-67			
NLF355C	ASI, VAN	175A, 300V, 0.15A, 2.5V	C-67			
NLF355D	ASI, VAN	175A, 400V, 0.15A, 2.5V	C-67			
NLF355E	ASI, VAN	175A, 500V, 0.15A, 2.5V	C-67			
NLF355M	ASI, VAN	175A, 600V, 0.15A, 2.5V	C-67			
NLF358A	ASI, VAN	175A, 100V, 0.15A, 2.5V	C-67	ECG5380		
NLF358B	ASI, VAN	175A, 200V, 0.15A, 2.5V	C-67	ECG5380		
NLF358C	ASI, VAN	175A, 300V, 0.15A, 2.5V	C-67	ECG5380		
NLF358D	ASI, VAN	175A, 400V, 0.15A, 2.5V	C-67	ECG5380		
NLF358E	ASI, VAN	175A, 500V, 0.15A, 2.5V	C-67	ECG5380		
NLF358M	ASI, VAN	175A, 600V, 0.15A, 2.5V	C-67	ECG5380		
NLF358N	VAN	175A, 800V, 0.15A, 2.5V	C-67	ECG5381		
NLF358P	VAN	175A, 1kV, 0.15A, 2.5V	C-67	ECG5381		
NLF358S	VAN	175A, 700V, 0.15A, 2.5V	C-67	ECG5381		
NLF358T	VAN	175A, 900V, 0.15A, 2.5V	C-67	ECG5381		
NLF364A	VAN	275A, 100V, 0.25A, 3V	C-10			 <p>图 C-10</p>
NLF364B	VAN	275A, 200V, 0.25A, 3V	C-10			
NLF364C	VAN	275A, 300V, 0.25A, 3V	C-10			
NLF364D	VAN	275A, 400V, 0.25A, 3V	C-10			
NLF364E	VAN	275A, 500V, 0.25A, 3V	C-10			
NLF364M	VAN	275A, 600V, 0.25A, 3V	C-10			
NLF365A	VAN	275A, 100V, 0.25A, 3V	C-10			
NLF365B	VAN	275A, 200V, 0.25A, 3V	C-10			
NLF365C	VAN	275A, 300V, 0.25A, 3V	C-10			

器件型号 Element type	厂名 Manufacturers	材料用途参数 Material Purpose Parameter	图号 Figure	国内外相似替换器件型号 Replace of similar type	备注 Notes	外形参考图 Reference shape
NLF365D	VAN	275A, 400V, 0.25A, 3V	C-10			 图 C-10
NLF365E	VAN	275A, 500V, 0.25A, 3V	C-10			
NLF365M	VAN	275A, 600V, 0.25A, 3V	C-10			
NLF380A	ASI, VAN	380A, 100V, 0.15A, 2.5V	C-67	ECG5590		 图 C-67
NLF380B	ASI, VAN	380A, 200V, 0.15A, 2.5V	C-67	ECG5590		
NLF380C	ASI, VAN	380A, 300V, 0.15A, 2.5V	C-67	ECG5592		
NLF380D	ASI, VAN	380A, 400V, 0.15A, 2.5V	C-67	ECG5592		
NLF380E	ASI, VAN	380A, 500V, 0.15A, 2.5V	C-67	ECG5592		
NLF380M	ASI, VAN	380A, 600V, 0.15A, 2.5V	C-67	ECG5592		
NLF380P	ASI, VAN	380A, 1kV, 0.15A, 2.5V	C-67	ECG5594		
NLF380S	ASI, VAN	380A, 700V, 0.15A, 2.5V	C-67	ECG5594		
NLF380T	ASI, VAN	380A, 900V, 0.15A, 2.5V	C-67	ECG5591		
NLF385A	ASI, VAN	380A, 100V, 0.15A, 2.5V	C-67			
NLF385B	ASI, VAN	380A, 200V, 0.15A, 2.5V	C-67			
NLF385C	ASI, VAN	380A, 300V, 0.15A, 2.5V	C-67			
NLF385D	ASI, VAN	380A, 400V, 0.15A, 2.5V	C-67			
NLF385E	ASI, VAN	380A, 500V, 0.15A, 2.5V	C-67			
NLF385M	ASI, VAN	380A, 600V, 0.15A, 2.5V	C-67			
NLF387	VAN	490A, 0.15A, 3V				 图 C-3
NLF387A	VAN	490A, 100V, 0.15A, 3V	C-3			
NLF387B	VAN	490A, 200V, 0.15A, 3V	C-3			
NLF387C	VAN	490A, 300V, 0.15A, 3V	C-3			
NLF387D	VAN	490A, 400V, 0.15A, 3V	C-3			
NLF387E	VAN	490A, 500V, 0.15A, 3V	C-3			
NLF387M	VAN	490A, 600V, 0.15A, 3V	C-3			
NLF387N	VAN	490A, 800V, 0.15A, 3V	C-3			

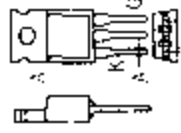

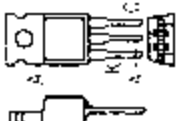
器件型号 Element type	厂名 Manufacturers	材料用途参数 Material Purpose Parameter	图号 Figure	国内外相似替换器件型号 Replace of similar type	备注 Notes	外形参考图 Reference shape
NLF387P	VAN	490A, 1kV, 0.15A, 3V	C-3			 <p>图 C-3</p>  <p>图 B-91</p>
NLF387PA	VAN	490A, 1.1kV, 0.15A, 3V	C-3			
NLF387PB	VAN	490A, 1.2kV, 0.15A, 3V	C-3			
NLF387S	VAN	490A, 700V, 0.15A, 3V	C-3			
NLF387T	VAN	490A, 900V, 0.15A, 3V	C-3			
NLF388A	VAN	490A, 100V, 0.15A, 3V	C-3			
NLF388B	VAN	490A, 200V, 0.15A, 3V	C-3			
NLF388C	VAN	490A, 300V, 0.15A, 3V	C-3			
NLF388D	VAN	490A, 400V, 0.15A, 3V	C-3			
NLF388E	VAN	490A, 500V, 0.15A, 3V	C-3			
NLF388M	VAN	490A, 600V, 0.15A, 3V	C-3			
NLF388N	VAN	490A, 800V, 0.15A, 3V	C-3			
NLF388P	VAN	490A, 1kV, 0.15A, 3V	C-3			
NLF388PA	VAN	490A, 1.1kV, 0.15A, 3V	C-3			
NLF388PB	VAN	490A, 1.2kV, 0.15A, 3V	C-3			
NLF388S	VAN	490A, 700V, 0.15A, 3V	C-3			
NLF388T	VAN	490A, 900V, 0.15A, 3V	C-3			
NLF390A	VAN	850A, 100V, 0.15A, 2.5V	B-91			
NLF390B	VAN	850A, 200V, 0.15A, 2.5V	B-91			
NLF390C	VAN	850A, 300V, 0.15A, 2.5V	B-91			
NLF390D	VAN	850A, 400V, 0.15A, 2.5V	B-91			
NLF390E	ASI, VAN	850A, 500V, 0.15A, 2.5V	B-91	ECG5595		
NLF390M	ASI, VAN	850A, 600V, 0.15A, 2.5V	B-91	ECG5595		
NLF390N	ASI, VAN	850A, 800V, 0.15A, 2.5V	B-91	ECG5596		
NLF390P	ASI, VAN	850A, 1kV, 0.15A, 2.5V	B-91	ECG5596		
NLF390PA	ASI, VAN	850A, 1.1kV, 0.15A, 2.5V	B-91	ECG5596		
NLF390PB	ASI, VAN	850A, 1.2kV, 0.15A, 2.5V	B-91	ECG5596		
NLF390PC	ASI, VAN	850A, 1.3kV, 0.15A, 2.5V	B-91	ECG5596		

器件型号 Element type	厂名 Manufacturers	材料用途参数 Material Purpose Parameter	图号 Figure	国内外相似替换器件型号 Replace of similar type	备注 Notes	外形参考图 Reference shape
NLF390S	ASI, VAN	850A, 700V, 0.15A, 2.5V	B-91	ECG5596		 图 B-91
NLF390T	ASI, VAN	850A, 900V, 0.15A, 2.5V	B-91	ECG5596		
NLF392	VAN	490A, 600V, 0.2A, 3V	C-3			 图 C-3
NLF392A	VAN	490A, 100V, 0.2A, 3V				
NLF392B	VAN	490A, 200V, 0.2A, 3V				
NLF392C	VAN	490A, 300V, 0.2A, 3V				
NLF392D	VAN	490A, 400V, 0.2A, 3V				
NLF392E	VAN	490A, 500V, 0.2A, 3V				
NLF392M	VAN	490A, 600V, 0.2A, 3V				
NLF393	VAN	490A, 600V, 0.2A, 3V				
NLF393A	VAN	490A, 100V, 0.2A, 3V	C-3			
NLF393B	VAN	490A, 200V, 0.2A, 3V	C-3			
NLF393C	VAN	490A, 300V, 0.2A, 3V	C-3			
NLF393D	VAN	490A, 400V, 0.2A, 3V	C-3			
NLF393E	VAN	490A, 500V, 0.2A, 3V	C-3			
NLF393M	VAN	490A, 600V, 0.2A, 3V	C-3			
NLF394A	ASI, VAN	700A, 100V, 0.2A, 2.5V	B-91			
NLF394B	ASI, VAN	700A, 200V, 0.2A, 2.5V	B-91			
NLF394C	ASI, VAN	700A, 300V, 0.2A, 2.5V	B-91			
NLF394D	ASI, VAN	700A, 400V, 0.2A, 2.5V	B-91			
NLF394E	ASI, VAN	700A, 500V, 0.2A, 2.5V	B-91			
NLF394M	ASI, VAN	700A, 600V, 0.2A, 2.5V	B-91			
NLF395A	ASI, VAN	700A, 100V, 0.2A, 2.5V	B-91			
NLF395B	ASI, VAN	700A, 200V, 0.2A, 2.5V	B-91			
NLF395C	ASI, VAN	700A, 300V, 0.2A, 2.5V	B-91			
NLF395D	ASI, VAN	700A, 400V, 0.2A, 2.5V	B-91			
NLF395E	ASI, VAN	700A, 500V, 0.2A, 2.5V	B-91			
NLF395M	ASI, VAN	700A, 600V, 0.2A, 2.5V	B-91			

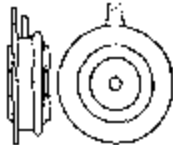

器件型号 Element type	厂名 Manufacturers	材料用途参数 Material Purpose Parameter	图号 Figure	国内外相似替换器件型号 Replace of similar type	备注 Notes	外形参考图 Reference shape
NLF397A	ASI, VAN	700A, 100V, 0.15A, 2.5V	B-91			 图 B-91
NLF397B	ASI, VAN	700A, 200V, 0.15A, 2.5V	B-91			
NLF397C	ASI, VAN	700A, 300V, 0.15A, 2.5V	B-91			
NLF397D	ASI, VAN	700A, 400V, 0.15A, 2.5V	B-91			
NLF397E	ASI, VAN	700A, 500V, 0.15A, 2.5V	B-91			
NLF397M	ASI, VAN	700A, 600V, 0.15A, 2.5V	B-91			
NLF397N	ASI, VAN	700A, 800V, 0.15A, 2.5V	B-91			
NLF397P	ASI, VAN	700A, 1KV, 0.15A, 2.5V	B-91			
NLF397PA	ASI, VAN	700A, 1.1KV, 0.15A, 2.5V	B-91			
NLF397PB	ASI, VAN	700A, 1.2KV, 0.15A, 2.5V	B-91			
NLF397S	VAN	700A, 700V, 0.15A, 2.5V	B-91			
NLF397T	VAN	700A, 900V, 0.15A, 2.5V	B-91			
NLF398A	ASI, VAN	700A, 100V, 0.15A, 2.5V	B-91			
NLF398B	ASI, VAN	700A, 200V, 0.15A, 2.5V	B-91			
NLF398C	ASI, VAN	700A, 300V, 0.15A, 2.5V	B-91			
NLF398D	ASI, VAN	700A, 400V, 0.15A, 2.5V	B-91			
NLF398E	ASI, VAN	700A, 500V, 0.15A, 2.5V	B-91			
NLF398M	ASI, VAN	700A, 600V, 0.15A, 2.5V	B-91			
NLF398N	ASI, VAN	700A, 800V, 0.15A, 2.5V	B-91			
NLF398P	ASI, VAN	700A, 1KV, 0.15A, 2.5V	B-91			
NLF398PA	ASI, VAN	700A, 1.1KV, 0.15A, 2.5V	B-91			
NLF398PB	ASI, VAN	700A, 1.2KV, 0.15A, 2.5V	B-91			
NLF398S	ASI, VAN	700A, 700V, 0.15A, 2.5V	B-91			
NLF398T	ASI, VAN	700A, 900V, 0.15A, 2.5V	B-91			
NLF430E	VAN	930A, 500V, 0.15A, 4V	C-10			 图 C-10
NLF430M	VAN	930A, 600V, 0.15A, 4V	C-10			
NLF430N	VAN	930A, 800V, 0.15A, 4V	C-10			
NLF430P	VAN	930A, 1KV, 0.15A, 4V	C-10			

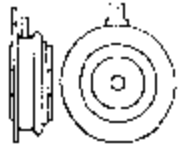
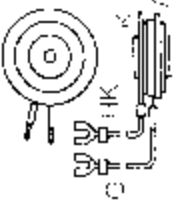
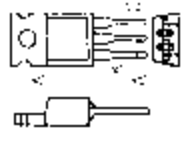



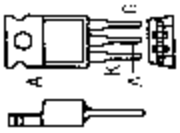

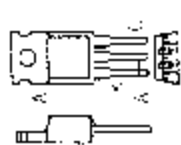
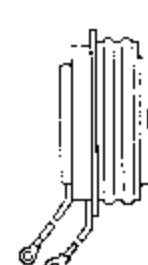



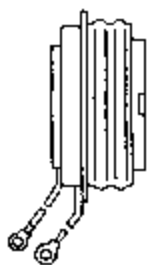
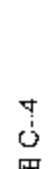



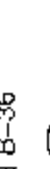



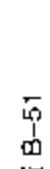
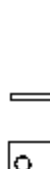

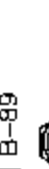

器件型号 Element type	厂名 Manufacturers	材料用途参数 Material Purpose Parameter	图号 Figure	国内外相似替换器件型号 Replace of similar type	备注 Notes	外形参考图 Reference shape
NLF430PA	VAN	930A, 1.1kV, 0.15A, 4V	C-10			 图 C-10
NLF430PB	VAN	930A, 1.2kV, 0.15A, 4V	C-10			
NLF430PC	VAN	930A, 1.3kV, 0.15A, 4V	C-10			
NLF430S	VAN	930A, 700V, 0.15A, 4V	C-10			
NLF430T	VAN	930A, 900V, 0.15A, 4V	C-10			
NLF431PC	VAN	900A, 1.3kV, 0.15A, 4V	C-10			
NLF431PD	VAN	900A, 1.4kV, 0.15A, 4V	C-10			
NLF431PE	VAN	900A, 1.5kV, 0.15A, 4V	C-10			
NLF431PM	VAN	1kA, 1.6kV, 0.15A, 4V	C-70			
NLF431PN	VAN	1kA, 1.8kV, 0.15A, 4V	C-70			
NLF431PS	VAN	900A, 1.7kV, 0.15A, 4V	C-10			 图 C-70
NLF447A	VAN	1.2kA, 100V, 0.15A, 2.5V	B-91			
NLF447B	VAN	1.2kA, 200V, 0.15A, 2.5V	B-91			
NLF447C	VAN	1.2kA, 300V, 0.15A, 2.5V	B-91			
NLF447D	VAN	1.2kA, 400V, 0.15A, 2.5V	B-91			
NLF447E	VAN	1.2kA, 500V, 0.15A, 2.5V	B-91			
NLF447M	VAN	1.2kA, 600V, 0.15A, 2.5V	B-91			
NLF447N	VAN	1.2kA, 800V, 0.15A, 2.5V	B-91			
NLF447P	VAN	1.2kA, 1kV, 0.15A, 2.5V	B-91			
NLF447PA	VAN	1.2kA, 1.1kV, 0.15A, 2.5V	B-91			
NLF447PB	VAN	1.2kA, 1.2kV, 0.15A, 2.5V	B-91			
NLF447PC	VAN	1.2kA, 1.3kV, 0.15A, 2.5V	B-91			
NLF447S	VAN	1.2kA, 700V, 0.15A, 2.5V	B-91			
NLF447T	VAN	1.2kA, 900V, 0.15A, 2.5V	B-91			 图 B-91
NLF448A	VAN	1.2kA, 100V, 0.15A, 2.5V	B-91			
NLF448B	VAN	1.2kA, 200V, 0.15A, 2.5V	B-91			
NLF448C	VAN	1.2kA, 300V, 0.15A, 2.5V	B-91			
NLF448D	VAN	1.2kA, 400V, 0.15A, 2.5V	B-91			

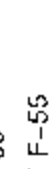

器件型号 Element type	厂名 Manufacturers	材料用途参数 Material Purpose Parameter	图号 Figure	国内外相似替换器件型号 Replace of similar type	备注 Notes	外形参考图 Reference shape
NLF448E	VAN	1.2kA, 500V, 0.15A, 2.5V	B-91			 <p>图 D-91</p>
NLF448M	VAN	1.2kA, 600V, 0.15A, 2.5V	B-91			
NLF448N	VAN	1.2kA, 800V, 0.15A, 2.5V	B-91			
NLF448P	VAN	1.2kA, 1kV, 0.15A, 2.5V	B-91			
NLF448PA	VAN	1.2kA, 1.1kV, 0.15A, 2.5V	B-91			
NLF448PB	VAN	1.2kA, 1.2kV, 0.15A, 2.5V	B-91			
NLF448PC	VAN	1.2kA, 1.3kV, 0.15A, 2.5V	B-91			
NLF448S	VAN	1.2kA, 700V, 0.15A, 2.5V	B-91			
NLF448T	VAN	1.2kA, 900V, 0.15A, 2.5V	B-91			
NLF450E	VAN	2.4kA, 500V, 0.15A, 4V	B-91			
NLF450M	VAN	2.4kA, 600V, 0.15A, 4V	B-91			
NLF450N	VAN	2.4kA, 800V, 0.15A, 4V	B-91			
NLF450P	VAN	2.4kA, 1kV, 0.15A, 4V	B-91			
NLF450PA	VAN	2.4kA, 1.1kV, 0.15A, 4V	B-91			
NLF450PB	VAN	2.4kA, 1.2kV, 0.15A, 4V	B-91			
NLF450PC	VAN	2.4kA, 1.3kV, 0.15A, 4V	B-91			
NLF450PD	VAN	2.4kA, 1.4kV, 0.15A, 4V	B-91			
NLF450S	VAN	2.4kA, 700V, 0.15A, 4V	B-91			
NLF450T	VAN	2.4kA, 900V, 0.15A, 4V	B-91			
NLF451E	VAN	1.9kA, 500V, 0.15A, 4V	B-91			
NLF451M	VAN	1.9kA, 600V, 0.15A, 4V	B-91			
NLF451P	VAN	1.9kA, 1kV, 0.15A, 4V	B-91			
NLF451PB	VAN	1.9kA, 1.2kV, 0.15A, 4V	B-91			
NLF451PD	VAN	1.9kA, 1.4kV, 0.15A, 4V	B-91			
NLF451PE	VAN	1.9kA, 1.5kV, 0.15A, 4V	B-91			
NLF451PM	VAN	1.9kA, 1.6kV, 0.15A, 4V	B-91			
NLF451PN	VAN	1.9kA, 1.8kV, 0.15A, 4V	B-91			
NLF451PS	VAN	1.9kA, 1.7kV, 0.15A, 4V	B-91			

器件型号 Element type	厂名 Manufacturers	材料用途参数 Material Purpose Parameter	图号 Figure	国内外相似替换器件型号 Replace of similar type	备注 Notes	外形参考图 Reference shape
NLF451S	VAN	1.9kA, 700V, 0.15A, 4V	B-91			 注 B-91
NLF451T	VAN	1.9kA, 900V, 0.15A, 4V	B-91			
NLF609A	VAN	1.2kA, 100V, 0.15A, 2.5V	B-91			 注 C 4
NLF609B	VAN	1.2kA, 200V, 0.15A, 2.5V	B 91			
NLF609C	VAN	1.2kA, 300V, 0.15A, 2.5V	B-91			
NLF609D	VAN	1.2kA, 400V, 0.15A, 2.5V	B-91			
NLF609E	VAN	1.2kA, 500V, 0.15A, 2.5V	B-91			
NLF609M	VAN	1.2kA, 600V, 0.15A, 2.5V	B-91			
NLF609N	VAN	1.2kA, 800V, 0.15A, 2.5V	B-91			
NLF609P	VAN	1.2kA, 1kV, 0.15A, 2.5V	B-91			
NLF609PA	VAN	1.2kA, 1.1kV, 0.15A, 2.5V	B-91			
NLF609PB	VAN	1.2kA, 1.2kV, 0.15A, 2.5V	B-91			
NLF609PC	VAN	1.2kA, 1.3kV, 0.15A, 2.5V	B 91			
NLF609S	VAN	1.2kA, 700V, 0.15A, 2.5V	B-91			
NLF609T	VAN	1.2kA, 900V, 0.15A, 2.5V	B-91			
NLF701E	ASI, VAN	1.6kA, 500V, 0.15A, 3V	C-4	ECG5598		
NLF701M	ASI, VAN	1.6kA, 600V, 0.15A, 3V	C-4	ECG5598		
NLF701N	ASI, VAN	1.6kA, 800V, 0.15A, 3V	C-4	ECG5599		
NLF701P	ASI, VAN	1.6kA, 1kV, 0.15A, 3V	C-4	ECG5599		
NLF701PA	ASI, VAN	1.6kA, 1.1kV, 0.15A, 3V	C-4	ECG5599		
NLF701PB	ASI, VAN	1.6kA, 1.2kV, 0.15A, 3V	C-4	ECG5599		
NLF701PC	ASI, VAN	1.6kA, 1.3kV, 0.15A, 3V	C-4	ECG5599		
NLF701PD	ASI, VAN	1.6kA, 1.4kV, 0.15A, 3V	C-4	ECG5599		
NLF701PE	ASI, VAN	1.6kA, 1.5kV, 0.15A, 3V	C-4	ECG5599		
NLF701PM	ASI, VAN	1.6kA, 1.6kV, 0.15A, 3V	C-4	ECG5599		
NLF701PS	ASI, VAN	1.6kA, 1.7kV, 0.15A, 3V	C-4	ECG5599		
NLF701S	ASI, VAN	1.6kA, 700V, 0.15A, 3V	C-4	ECG5599		

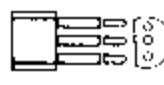

器件型号 Element type	厂名 Manufacturers	材料用途参数 Material Purpose Parameter	图号 Figure	国内外相似替换器件型号 Replace of similar type	备注 Notes	外形参考图 Reference shape
NLF701T	ASI, VAN	1.6kA, 900V, 0.15A, 3V	C-4	ECG5599		
NMB125	HTN	0.8A, 25V, 200 μA, 0.8V	B-36			
NMB126	HTN	0.8A, 50V, 200 μA, 0.8V	B-36			
NMB127	HTN	0.8A, 75V, 200 μA, 0.8V	B-36			
NMB128	HTN	0.8A, 125V, 200 μA, 0.8V	B-36			
NMB129	HTN	0.8A, 150V, 200 μA, 0.8V	B-36			
NMB130	HTN	0.8A, 175V, 200 μA, 0.8V	B-36			
NMB131	HTN	1.6A, 30V, 0.001A, 0.8V	B-51			
NMB132	HTN	1.6A, 60V, 0.001A, 0.8V	B-51			
NMB133	HTN	1.6A, 125V, 0.001A, 0.8V	B-51			
NMB134	HTN	1.6A, 175V, 0.001A, 0.8V	B-51			
NMB135	HTN	1.6A, 225V, 0.001A, 0.8V	B-51			
NMB136	HTN	1.6A, 275V, 0.001A, 0.8V	B-51			
NMB137	HTN	1.6A, 325V, 0.001A, 0.8V	B-51			
NMB138	HTN	1.6A, 375V, 0.001A, 0.8V	B-51			
NMB139	HTN	4A, 25V, 200 μA, 0.8V	B-89			
NMB140	HTN	4A, 60V, 200 μA, 0.8V	B-89			
NMB141	HTN	4A, 125V, 200 μA, 0.8V	B-89			
NMB142	HTN	4A, 175V, 200 μA, 0.8V	B-89			
NMB144	HTN	4A, 275V, 200 μA, 0.8V	B-89			
NMB145	HTN	4A, 325V, 200 μA, 0.8V	B-89			
NMB146	HTN	4A, 375V, 200 μA, 0.8V	B-89			
NMB147	HTN	4A, 425V, 200 μA, 0.8V	B-89			
NMB148	HTN	4A, 475V, 200 μA, 0.8V	B-89			
NMB149	HTN	4A, 525V, 200 μA, 0.8V	B-89			
NMB150	HTN	4A, 575V, 200 μA, 0.8V	B-89			
NO18RH03	WES	28A, 300V, 0.05A, 3V	F-50			

器件型号 Element type	厂名 Manufacturers	材料用途参数 Material Purpose Parameter	图号 Figure	国内外相似替换器件型号 Replace of similar type	备注 Notes	外形参考图 Reference shape
NO18RH04	WES	28A, 400V, 0.05A, 3V	F-50			 图 F-50
NO18RH05	WES	28A, 500V, 0.05A, 3V	F-50			
NO18RH06	WES	28A, 600V, 0.05A, 3V	F-50			
NT101	MIT	2A, 40V, 20 μA, 500V	B-36	ECC5401		 图 B-36
NT102	MIT	2A, 40V, 20 μA, 500V	B-36	ECC6402		



N类外形参考图索引



图 A-1



图 B-4

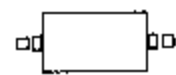

图 B-35

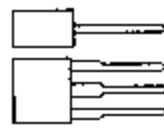

图 B-36



图 B-47



图 B-51



图 B-66



图 B-74

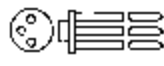

图 B-89



图 B-91

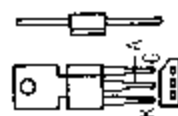

图 C-3

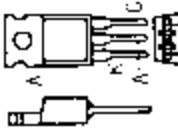

图 C-4

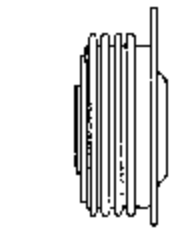

图 C-10

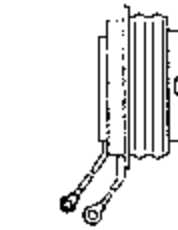

图 C-50

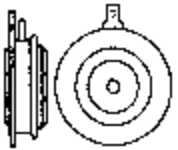

图 C-67

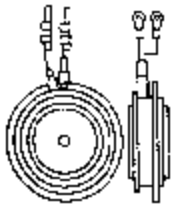

图 C-70

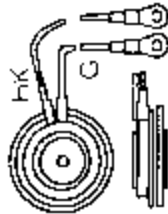

图 D-37

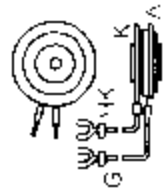

图 E-9

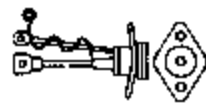

图 E-15

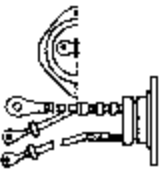

图 E-28

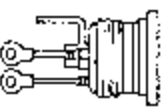

图 E-30

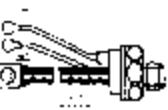

图 F-1



图 F-8



图 F-21



图 F-23



图 F-48



图 F-50



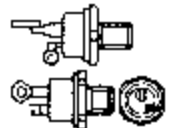



图 F-71



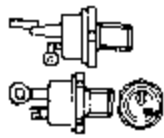

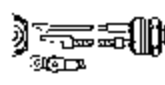
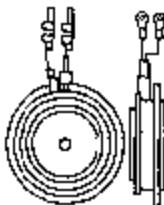
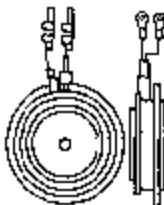

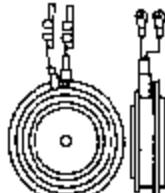
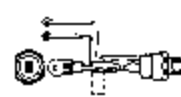



图 F-91

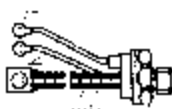







器件型号 Element type	厂名 Manufacturers	材料用途参数 Material Purpose Parameter	图号 Figure	国内外相似替换器件型号 Replace of similar type	备注 Notes	外形参考图 Reference shape
P015QH02	WES	48A, 200V, 0.1A, 3V	F-48			 图 F-48
P015QH04	WES	48A, 400V, 0.1A, 3V	F-48			
P015QH06	WES	48A, 600V, 0.1A, 3V	F-48			
P015QH08	WES	48A, 800V, 0.1A, 3V	F-48			
P015QH10	WES	48A, 1kV, 0.1A, 3V	F-48			
P027QH02	WES	100A, 200V, 0.1A, 3V	F-21			 图 F-21
P027QH04	WES	100A, 400V, 0.1A, 3V	F-21			
P027QH06	WES	100A, 600V, 0.1A, 3V	F-21			
P027QH08	WES	100A, 800V, 0.1A, 3V	F-21			
P027QH10	WES	100A, 1kV, 0.1A, 3V	F-21			
P027QH12	WES	100A, 1.2kV, 0.1A, 3V	F-21			
P036PH08	WES	57A, 800V, 0.1A, 3V	F-63			 图 F-63
P036QH02	WES	100A, 200V, 0.1A, 3V	F-21			
P036QH04	WES	100A, 400V, 0.1A, 3V	F-21			
P036QH06	WES	100A, 600V, 0.1A, 3V	F-21			
P036QH08	WES	100A, 800V, 0.1A, 3V	F-21			
P036QH10	WES	100A, 1kV, 0.1A, 3V	F-21			
P036QH12	WES	100A, 1.2kV, 0.1A, 3V	F-21			 图 C-50
P042QH02	WES	100A, 200V, 0.1A, 3V	F-21			
P042QH04	WES	100A, 400V, 0.1A, 3V	F-21			
P042QH06	WES	100A, 600V, 0.1A, 3V	F-21			
P042QH08	WES	100A, 800V, 0.1A, 3V	F-21			
P080CH02	WES	67A, 200V, 0.2A, 3V	C-50			 图 C-50
P080CH04	WES	67A, 400V, 0.2A, 3V	C-50			

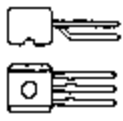

器件型号 Element type	厂名 Manufacturers	材料用途参数 Material Purpose Parameter	图号 Figure	国内外相似替换器件型号 Replace of similar type	备注 Notes	外形参考图 Reference shape	
P080CH06	WES	67A, 600V, 0.2A, 3V	C-50			 <p>图 C-50</p>	
P080CH08	WES	67A, 600V, 0.2A, 3V	C-50				
P080CH10	WES	67A, 1kV, 0.2A, 3V	C-50				
P080CH12	WES	67A, 1.2kV, 0.2A, 3V	C-50				
P080PH02	WES	75A, 200V, 0.2A, 3V	F-91				
P080PH04	WES	75A, 400V, 0.2A, 3V	F-91				
P080PH06	WES	75A, 600V, 0.2A, 3V	F-91				
P080PH08	WES	75A, 800V, 0.2A, 3V	F-91				
P080PH10	WES	75A, 1kV, 0.2A, 3V	F-91				
P080PH12	WES	75A, 1.2kV, 0.2A, 3V	F-91				
P086CH02	WES	314A, 200V, 0.2A, 3V	C-50				 <p>图 F-91</p>
P086CH04	WES	314A, 400V, 0.2A, 3V	C-50				
P086CH06	WES	314A, 600V, 0.2A, 3V	C-50				
P086PH02	WES	81A, 200V, 0.2A, 3V	E-28				
P086PH04	WES	81A, 400V, 0.2A, 3V	E-28				
P086PH06	WES	81A, 600V, 0.2A, 3V	E-28				
P095CH02	WES	356A, 200V, 0.2A, 3V	C-50			 <p>图 F-28</p>	
P095CH04	WES	356A, 400V, 0.2A, 3V	C-50				
P095CH06	WES	356A, 600V, 0.2A, 3V	C-50				
P095CH08	WES	356A, 800V, 0.2A, 3V	C-50				
P095CH10	WES	356A, 1kV, 0.2A, 3V	C-50				
P095CH12	WES	356A, 1.2kV, 0.2A, 3V	C-50				
P095PH02	WES	175A, 200V, 0.2A, 3V	E-28				
P095PH04	WES	175A, 400V, 0.2A, 3V	E-28				
P095PH06	WES	175A, 600V, 0.2A, 3V	E-28				
P095PH08	WES	175A, 800V, 0.2A, 3V	E-28				
P095PH10	WES	175A, 1kV, 0.2A, 3V	E-28				

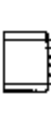

器件型号 Element type	厂名 Manufacturers	材料用途参数 Material Purpose Parameter	图号 Figure	国内外相似替换器件型号 Reclace of similar type	备注 Notes	外形参考图 Reference shape
P095PH12	WES	175A, 12kV, 0.2A, 3V	E-28			 图 E-28
P0100BA, BB		50Hz-Thy 0.5A, 200V, 20 μA	B-35			
P0100DA, DB		50Hz-Thy 0.5A, 400V, 20 μA	B-35			
P0100MA, MB		50Hz-Thy 0.5A, 600V, 20 μA	B-35			
P0100NA, NB		50Hz-Thy 0.5A, 800V, 20 μA	B-35			
P0100AD		50Hz-Thy 0.5A, 100V, 20 μA	B-62	2N2324A, 2N2325A, 2N2326A, 2N2327A, 2N2328A, 2N2329A		 图 B-35
P0100BD		50Hz-Thy 0.5A, 200V, 20 μA	B-62	2N2326A, 2N2327A, 2N2328A, 2N2329A		 图 B-62
P0100CD		50Hz-Thy 0.5A, 300V, 20 μA	B-62	2N2328A, 2N2329A		
P0100DD		50Hz-Thy 0.5A, 400V, 20 μA	B-62	2N2329		
P0102AA, AB	TAG	50Hz-Thy 0.5A, 100V, 200 μA, 0.8V	B-36	MCR100-3		
P0102AL, AN		7A, 100V	G-1			 图 B-36
P0102BA, BB	TAG	50Hz-Thy 0.5A, 200V, 200 μA, 0.8V	B-44	MCR100-4		
P0102BL, BN		7A, 200V	G-1			 图 G-1
P0102CA, CB	TAG	50Hz-Thy 0.5A, 300V, 200 μA, 0.8V	B-36	MCR100-5		
P0102CL, CN		7A, 300V	G-1			
P0102DA, DB	TAG	50Hz-Thy 0.5A, 400V, 200 μA, 0.8V	B-44	MCR100-6		
P0102DL, DN		7A, 400V	G-1			 图 B-44
P0103AN		7A, 100V	G-1			 图 G-1
P0103AD	TAG	50Hz-Thy 0.5A, 100V, 200 μA, 0.8V	B-65	TAG615-100, 2N2324, 2N2325, 2N2326, 2N2327, 2N2328, 2N2329, 2N6334, 2N6335, 2N6336, 2N6337		 图 B-65
P0103BA	TAG	50Hz-Thy 0.5A, 200V, 200 μA, 0.8V	B-36	MCR100-3		

器件型号 Element type	厂名 Manufacturers	材料用途参数 Material Purpose Parameter	图号 Figure	国内外相似替换器件型号 Replace of similar type	备注 Notes	外形参考图 Reference shape
P0103BB	TAG	50Hz-Thy 0.5A, 200V, 200 μ A, 0.8V, 0.005A	B-44	MCR100-3		
P0103BD		50Hz-Thy 0.5A, 200V, 200 μ A, 0.005A	B-62	TAG615-200, 2N2326, 2N2327, 2N2328, 2N2329, 2N6335, 2N6336, 2N6337		
P0103BN		7A, 200V	G-1			图 B-44
P0103CD		50Hz-Thy 0.5A, 300V, 200 μ A, 0.005A	B-62	TAG615 300, 2N2328, 2N2329, 2N6336, 2N6337		
P0103CN		7A, 300V	G-1			
P0103DA		50Hz-Thy 0.5A, 400V, 200 μ A, 0.8V, 0.005A	B-36	MCR100-5, TAG70D		
P0103DB	TAG	50Hz-Thy 0.5A, 400V, 200 μ A, 0.8V, 0.005A	B-44	MCR100-5, TAG70D		
P0103DU	TAG	50Hz-Thy 0.5A, 400V, 200 μ A, 0.005A	B-62	TAG615-400, 2N2329, 2N6337		
P0103DN		7A, 400V	G-1			
P0103MA		50Hz-Thy 0.5A, 600V, 200 μ A, 0.005A	B-35	MCR100-7, TAG70M		图 B-62
P0103MB		50Hz-Thy 0.5A, 600V, 200 μ A, 0.005A	B-35	MCR100-7, TAG70M		
P0103NA		50Hz-Thy 0.5A, 800V, 200 μ A, 0.005A	B-35	TAG70N		
P0103NB		50Hz-Thy 0.5A, 800V, 200 μ A, 0.005A	B-35	TAG70N		
P0109AA		7A, 100V	B-36			
P0109AB		7A, 100V				
P0109AL		7A, 100V	G-1			图 G-1
P0109BA		7A, 200V	B-36			
P0109BB		7A, 200V				
P0109BL		7A, 200V	G-1			
P0109CA		7A, 300V	B-36			图 B-36
P0109CB		7A, 300V				
P0109CL		7A, 300V	G-1			
P0109DA		7A, 400V	B-36			
P0109DB		7A, 400V				
P0109DL		7A, 400V	G-1			
P0111AB		7A, 100V	G-1			图 B-35

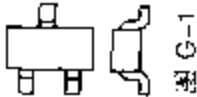

器件型号 Element type	厂名 Manufacturers	材料用途参数 Material Purpose Parameter	图号 Figure	国内外相似替换器件型号 Replace of similar type	备注 Notes	外形参考图 Reference shape
P0111BL		7A, 200V	G-1			 图 G-1  图 B-36
P0111CL		7A, 300V	G-1			
P0111DL		7A, 400V	G-1			
P0115AB		7A, 100V				
P0115AL		7A, 100V	G-1			
P0115BB		7A, 200V				
P0115BL		7A, 200V	G-1			
P0115CB		7A, 300V				
P0115CL		7A, 300V	G-1			
P0115DB		7A, 400V				
P0115DL		7A, 400V	G-1			
P0118AA		7A, 100V				
P0118AB		7A, 100V	B-36			
P0118AL		7A, 100V	G-1			
P0118BA		7A, 200V	B-36			
P0118BB		7A, 200V				
P0118BL		7A, 200V	G-1			
P0118CA		7A, 300V	B-36			
P0118CB		7A, 300V				
P0118CI		7A, 300V	G-1			
P0118DA		7A, 400V	B-36			
P0118DB		7A, 400V				
P0118DL		7A, 400V	G-1			
P0201AA		22.5A, 50V	B-36			
P0201BA		22.5A, 100V	B-36			
P0201CA		22.5A, 200V	B-36			

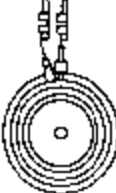
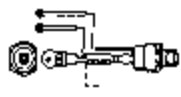
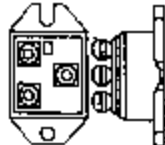
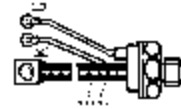
器件型号 Element type	厂名 Manufacturers	材料用途参数 Material Purpose Parameter	图号 Figure	国内外相似替换器型号 Repace of similar type	备注 Notes	外形参考图 Reference shape	
P0201DA		22.5A, 400V	B-36			 图 B-36	
P0201EA		22.5A, 600V	B-36				
P0201MA		22.5A, 800V	B-36				
P100CH02	WES	74A, 200V, 0.2A, 3V	C-50			 图 C-50	
P100CH04	WES	74A, 400V, 0.2A, 3V	C-50				
P100CH06	WES	74A, 600V, 0.2A, 3V	C-50				
P100CH08	WES	74A, 800V, 0.2A, 3V	C-50				
P100PH02	WES	85A, 200V, 0.2A, 3V	F-91				
P100PH04	WES	85A, 400V, 0.2A, 3V	F-91				
P100PH06	WES	85A, 600V, 0.2A, 3V	F-91				
P100PH08	WES	85A, 800V, 0.2A, 3V	F-91				
P101, K, KW	INR	12A, 400V, 0.06A, 2V	H-16			 图 F-91	
P101W	SCB	25A, 400V	H-16				
P102, K, KW	INR	12A, 600V, 0.06A, 2V	H-16				
P102W	SCB	25A, 600V	H-16				
P103, K, KW	INR	12A, 800V, 0.06A, 2V	H-16				
P103W	SCB	25A, 800V	H-16				
P104, K, KW	INR	12A, 1kV, 0.06A, 2V	H-16				
P104W	SCB	25A, 1kV	H-16				
P105, K, KW	INR	12A, 1.2kV, 0.06A, 2V	H-16				
P105W	SCB	25A, 1.2kV	H-16				
P105CH02	WES	396A, 200V, 0.2A, 3V	C-50				 图 H-16
P105CH04	WES	396A, 400V, 0.2A, 3V	C-50				
P105CH06	WES	396A, 600V, 0.2A, 3V	C-50				
P105PH02	WES	175A, 200V, 0.2A, 3V	E-28				
P105PH04	WES	175A, 400V, 0.2A, 3V	E-28				 图 E-28



器件型号 Element type	厂名 Manufacturers	材料用途参数 Material Purpose Parameter	图号 Figure	国内外相似替换器件型号 Replace of similar type	备注 Notes	外形参考图 Reference shape
P105PH06	WES	175A, 600V, 0.2A, 3V	E-28			
P111, K, KW	INR	12A, 400V, 0.06A, 2V	H-16			
P111W	SCB	25A, 400V				
P112, K, KW	INR	12A, 600V, 0.06A, 2V	H-16			
P112W	SCB	25A, 600V				
P113, K, KW	INR	12A, 800V, 0.06A, 2V	H-16			
P113W	SCB	25A, 800V				
P114, K, KW	INR	12A, 1kV, 0.06A, 2V	H-16			
P114W	SCB	25A, 1kV				
P115, K, KW	INR	12A, 1.2kV, 0.06A, 2V	H-16			
P115W	SCB	25A, 1.2kV				
P121	INR	12A, 400V, 0.06A, 2V	H-16			
P121K	SCB	25A, 400V				
P122	INR	12A, 600V, 0.06A, 2V	H-16			
P122K	SCB	25A, 600V				
P123	INR	12A, 800V, 0.06A, 2V	H-16			
P123K	SCB	25A, 800V				
P124	INR	12A, 1kV, 0.06A, 2V	H-16			
P124K	SCB	25A, 1kV				
P125	INR	12A, 1.2kV, 0.06A, 2V	H-16			
P125K	SCB	25A, 1.2kV				
P131	INR	12A, 400V, 0.06A, 2V	H-16			
P131K	SCB	25A, 400V				
P132	INR	12A, 600V, 0.06A, 2V	H-16			
P132K	SCB	25A, 600V				
P133	INR	12A, 800V, 0.06A, 2V	H-16			



图 E-28



图 H-16

器件型号 Element type	厂名 Manufacturers	材料用途参数 Material Purpose Parameter	图号 Figure	国内外相似替换器件型号 Replace of similar type	备注 Notes	外形参考图 Reference snape
P133K		SCB 25A, 800V				
P134	INR	SCB 12A, 1kV, 0.06A, 2V	H-16			
P134K		SCB 25A, 1kV				
P135	INR	SCB 12A, 1.2kV, 0.06A, 2V	H-16			
P135K		SCB 25A, 1.2kV				
P141	INR	SCB 12A, 400V, 0.06A, 2V	H-16			
P141K		SCB 28A, 400V				
P142	INR	SCB 12A, 600V, 0.06A, 2V	H-16			
P142K		SCB 28A, 600V				
P143	INR	SCB 12A, 800V, 0.06A, 2V	H-16			
P143K		SCB 28A, 800V				
P144	INR	SCB 12A, 1kV, 0.06A, 2V	H-16			
P144K		SCB 28A, 1kV				
P145	INR	SCB 12A, 1.2kV, 0.06A, 2V	H-16			
P145K		SCB 28A, 1.2kV				
P161	INH	SCB 12A, 400V, 0.06A, 2V	H-16			
P162	INR	SCB 12A, 600V, 0.06A, 2V	H-16			
P163	INR	SCB 12A, 800V, 0.06A, 2V	H-16			
P164	INR	SCB 12A, 1kV, 0.06A, 2V	H-16			
P165	INR	SCB 12A, 1.2kV, 0.06A, 2V	H-16			
P171	INR	SCB MOD, 12A, 400V, 0.06A, 2V	H-16			
P172	INR	SCB MOD, 12A, 600V, 0.06A, 2V	H-16			
P173	INR	SCB MOD, 12A, 800V, 0.06A, 2V	H-16			
P174	INR	SCB MOD, 12A, 1kV, 0.06A, 2V	H-16			
P175	INR	SCB MOD, 12A, 1.2kV, 0.06A, 2V	H-16			

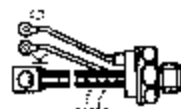



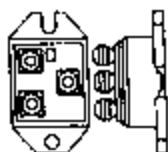

图 H-16

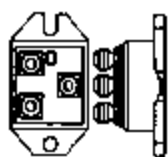
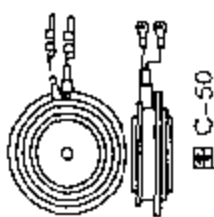
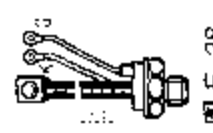
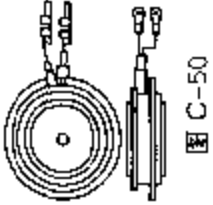

器件型号 Element type	厂名 Manufacturers	材料用途参数 Material Purpose Parameter	图号 Figure	国内外相似替换器件型号 Replace of similar type	备注 Notes	外形参考图 Reference shape
P200CH02	WES	106A, 200V, 0.2A, 3V	C-50			 图 C-50
P200CH04	WES	106A, 400V, 0.2A, 3V	C-50			
P200CH06	WES	106A, 600V, 0.2A, 3V	C-50			
P200CH08	WES	106A, 800V, 0.2A, 3V	C-50			
P200CH10	WES	106A, 1kV, 0.2A, 3V	C-50			
P200CH12	WES	106A, 1.2kV, 0.2A, 3V	C-50			
P200PH02	WES	160A, 200V, 0.2A, 3V	C-50			
P200PH04	WES	160A, 400V, 0.2A, 3V	C-50			
P200PH06	WES	160A, 600V, 0.2A, 3V	C-50			
P200PH08	WES	160A, 800V, 0.2A, 3V	C-50			
P200PH10	WES	160A, 1kV, 0.2A, 3V	C-50			
P200PH12	WES	160A, 1.2kV, 0.2A, 3V	C-50			
P202CH02	WES	120A, 200V, 0.2A, 3V	C-50			 图 E-2B
P202CH04	WES	120A, 400V, 0.2A, 3V	C-50			
P202CH08	WES	120A, 800V, 0.2A, 3V	C-50			
P202CH10	WES	120A, 1kV, 0.2A, 3V	C-50			
P202CH12	WES	120A, 1.2kV, 0.2A, 3V	C-50			
P202PH02	WES	175A, 200V, 0.2A, 3V	E-28			
P202PH04	WES	175A, 400V, 0.2A, 3V				
P202PH06	WES	175A, 600V, 0.2A, 3V				
P202PH08	WES	175A, 800V, 0.2A, 3V				
P202PH10	WES	175A, 1kV, 0.2A, 3V				
P202PH12	WES	175A, 1.2kV, 0.2A, 3V				
P204CH02	WES	125A, 200V, 0.2A, 3V	C-50			
P204CH04	WES	125A, 400V, 0.2A, 3V	C-50			
P204CH06	WES	125A, 600V, 0.2A, 3V	C-50			
P204CH08	WES	125A, 800V, 0.2A, 3V	C-50			

器件型号 Element type	厂名 Manufacturers	材料用途参数 Material Purpose Parameter	图号 Figure	国内外相似替换器件型号 Replace of similar type	备注 Notes	外形参考图 Reference shape
P204PH02	WES	183A, 200V, 0.2A, 3V				 图 C-50
P204PH04	WES	183A, 400V, 0.2A, 3V				
P204PH06	WES	183A, 600V, 0.2A, 3V				
P204PH08	WES	183A, 800V, 0.2A, 3V				
P205CH02	WES	610A, 200V, 0.2A, 3V	C-50			 图 E-30
P205CH04	WES	610A, 400V, 0.2A, 3V	C-50			
P205CH06	WES	610A, 600V, 0.2A, 3V	C-50			
P205CH08	WES	610A, 800V, 0.2A, 3V	C-50			
P205CH10	WES	610A, 1KV, 0.2A, 3V	C-50			
P205CH12	WES	610A, 1.2KV, 0.2A, 3V	C-50			
P205PH02	WES	355A, 200V, 0.2A, 3V	E-30			
P205PH04	WES	355A, 400V, 0.2A, 3V	E-30			
P205PH06	WES	355A, 600V, 0.2A, 3V	E-30			
P205PH08	WES	355A, 800V, 0.2A, 3V	E-30			
P205PH10	WES	355A, 1KV, 0.2A, 3V	E-30			
P205PH12	WES	355A, 1.2KV, 0.2A, 3V	E-30			
P214CH02	WES	130A, 200V, 0.2A, 3V	C-50			
P214CH04	WES	130A, 400V, 0.2A, 3V	C-50			
P214CH06	WES	130A, 600V, 0.2A, 3V	C-50			
P214CH08	WES	130A, 800V, 0.2A, 3V	C-50			
P214PH02	WES	195A, 200V, 0.2A, 3V				
P214PH04	WES	195A, 400V, 0.2A, 3V				
P214PH06	WES	195A, 600V, 0.2A, 3V				
P214PH08	WES	195A, 800V, 0.2A, 3V				
P215CH02	WES	650A, 200V, 0.2A, 3V	C-50			
P215CH04	WES	650A, 400V, 0.2A, 3V	C-50			

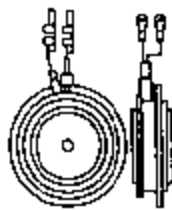

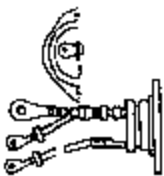
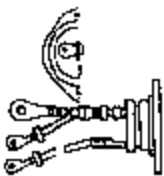
器件型号 Element type	厂名 Manufacturers	材料用途参数 Material Purpose Parameter	图号 Figure	国内外相似替换器件型号 Replace of similar type	备注 Notes	外形参考图 Reference shape
P215CH06	WES	650A, 600V, 0.2A, 3V	C-50			 <p>图 C-50</p>
P215PH02	WES	355A, 200V, 0.2A, 3V	E-30			
P215PH04	WES	355A, 400V, 0.2A, 3V	E-30			
P215PH06	WES	355A, 600V, 0.2A, 3V	E-30			
P230CH02	WES	230A, 200V, 0.2A, 3V	C-50			 <p>图 E-30</p>
P230CH04	WES	230A, 400V, 0.2A, 3V	C-50			
P230CH06	WES	230A, 600V, 0.2A, 3V	C-50			
P230CH08	WES	230A, 800V, 0.2A, 3V	C-50			
P230CH10	WES	230A, 1kV, 0.2A, 3V	C-50			
P230CH12	WES	230A, 1.2kV, 0.2A, 3V	C-50			
P280CH02	WES	272A, 200V, 0.2A, 3V	C-50			 <p>图 E-9</p>
P280CH04	WES	272A, 400V, 0.2A, 3V	C-50			
P280CH06	WES	272A, 600V, 0.2A, 3V	C-50			
P280CH07	WES	272A, 700V, 0.2A, 3V	C-50			
P300CH02	WES	1.1kA, 200V, 0.3A, 3V	C-50			 <p>图 E-9</p>
P300CH04	WES	1.1kA, 400V, 0.3A, 3V	C-50			
P300CH06	WES	1.1kA, 600V, 0.3A, 3V	C-50			
P300CH08	WES	1.1kA, 800V, 0.3A, 3V	C-50			
P300CH10	WES	1.1kA, 1kV, 0.3A, 3V	C-50			
P300CH12	WES	1.1kA, 1.2kV, 0.3A, 3V	C-50			
P300KH02	WES	300A, 200V, 0.3A, 3V	E-9			
P300KH04	WES	300A, 400V, 0.3A, 3V	E-9			
P300KH06	WES	300A, 600V, 0.3A, 3V	E-9			
P300KH08	WES	300A, 800V, 0.3A, 3V	E-9			
P300KH10	WES	300A, 1kV, 0.3A, 3V	E-9			
P300KH12	WES	300A, 1.2kV, 0.2A, 3V	E-9			

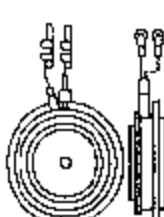
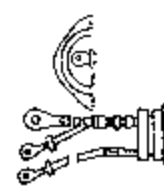
器件型号 Element type	厂名 Manufacturers	材料用途参数 Material Purpose Parameter	图号 Figure	国内外相似替换器件型号 Replace of similar type	备注 Notes	外形参考图 Reference shape
P370CH02	WES	300A, 200V, 0.3A, 3V	C-50			 图 C-50
P370CH04	WES	300A, 400V, 0.3A, 3V	C-50			
P370CH06	WES	300A, 600V, 0.3A, 3V	C-50			
P370CH08	WES	300A, 800V, 0.3A, 3V	C-50			
P370KH02	WES	350A, 200V, 0.3A, 3V	E-9			
P370KH04	WES	350A, 400V, 0.3A, 3V	E-9			
P370KH06	WES	350A, 600V, 0.3A, 3V	E-9			
P370KH08	WES	350A, 800V, 0.3A, 3V	E-9			
P401, K, KW, W	SCB	40A, 400V				 图 E-9
P402, K, KW, W	SCB	40A, 600V				
P403, K, KW, W	SCB	40A, 800V				
P404, K, KW, W	SCB	40A, 1KV				
P405, K, KW, W	SCB	40A, 1.2KV				
P411, K, KW, W	SCB	40A, 400V				
P412, K, KW, W	SCB	40A, 600V				
P413, K, KW, W	SCB	40A, 800V				
P414, K, KW, W	SCB	40A, 1KV				
P415, K, KW, W	SCB	40A, 1.2KV				
P421, K	SCB	40A, 400V				
P422, K	SCB	40A, 600V				
P423, K	SCB	40A, 800V				
P424, K	SCB	40A, 1KV				
P425, K	SCB	40A, 1.2KV				
P431, K	SCB	40A, 400V				
P432, K	SCB	40A, 600V				

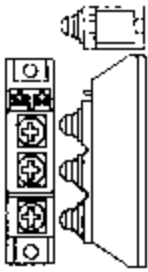

器件型号 Element type	厂名 Manufacturers	材料 Material	用途 Purpose	参数 Parameter	图号 Figure	国内外相似替换器件型号 Replac of similar type	备注 Notes	外形参考图 Reference shape
P433, K	SCB	40A, 800V						 <p>图 H-15</p>
P434, K	SCB	40A, 1kV						
P435, K	SCB	40A, 1.2kV						
P441, K	SCB	44A, 400V						
P442, K	SCB	44A, 600V						
P443, K	SCB	44A, 800V						
P444, K	SCB	44A, 1kV						
P445, K	SCB	44A, 1.2kV						
P472	MOD	20A, 600V						
P473	MOD	20A, 800V						
P474	MOD	20A, 1kV						
P475	MOD	20A, 1.2kV						
PBH25A	CHN	25A, 400V, 0.1A, 3V						
PBH25B	CHN	25A, 500V, 0.1A, 3V						
PBH25C	CHN	25A, 600V, 0.1A, 3V						
PBH25D	CHN	25A, 700V, 0.1A, 3V						
PBH25E	CHN	25A, 800V, 0.1A, 3V						
PBH25F	CHN	25A, 900V, 0.1A, 3V						
PBH25G	CHN	25A, 1kV, 0.1A, 3V						
PBH25H	CHN	25A, 1.2kV, 0.1A, 3V						
PBH25J	CHN	25A, 1.4kV, 0.1A, 3V						
PBH25K	CHN	25A, 1.6kV, 0.1A, 3V						
PBH25-04	AEI	SCA	25A, 400V, 0.08A, 3V		H-15			
PBH25-06	AEI	SCA	25A, 600V, 0.08A, 3V		H-15			
PBH25-08	AEI	SCA	25A, 800V, 0.08A, 3V		H-15			

器件型号 Element type	厂名 Manufacturers	材料用途参数 Material Purpose Parameter	图号 Figure	国内外相似替换器件型号 Replace of similar type	备注 Notes	外形参考图 Reference shape
PBH25-10	AEI	SCA 25A, 1kV, 0.08A, 3V	H-15			 <p>图 H-15</p>
PBH25-12	AEI	SCA 25A, 1.2kV, 0.08A, 3V	H-15			
PBH25-14	AEI	SCA 25A, 1.4kV, 0.08A, 3V	H-15			
PBH45-04	AEI	SCA 45A, 400V, 0.15A, 3V	H-15			
PBH45-06	AEI	SCA 45A, 600V, 0.15A, 3V	H-15			
PBH45-08	AEI	SCA 45A, 800V, 0.15A, 3V	H-15			
PBH45-10	AEI	SCA 45A, 1kV, 0.15A, 3V	H-15			
PBH45-12	AEI	SCA 45A, 1.2kV, 0.15A, 3V	H-15			
PBH55A	CHN	55A, 400V, 0.1A, 3V				
PBH55B	CHN	55A, 500V, 0.1A, 3V				
PBH55C	CHN	55A, 600V, 0.1A, 3V				
PBH55D	CHN	55A, 700V, 0.1A, 3V				
PBH55E	CHN	55A, 800V, 0.1A, 3V				
PBH55F	CHN	55A, 900V, 0.1A, 3V				
PBH55G	CHN	55A, 1kV, 0.1A, 3V				
PBH55H	CHN	55A, 1.2kV, 0.1A, 3V				
PBH55J	CHN	55A, 1.4kV, 0.1A, 3V				
PBH55K	CHN	55A, 1.6kV, 0.1A, 3V				
PBH90A	CHN	90A, 400V, 0.1A, 3V				
PBH90B	CHN	90A, 500V, 0.1A, 3V				
PBH90C	CHN	90A, 600V, 0.1A, 3V				
PBH90D	CHN	90A, 700V, 0.1A, 3V				
PBH90E	CHN	90A, 800V, 0.1A, 3V				
PBH90F	CHN	90A, 900V, 0.1A, 3V				
PBH90G	CHN	90A, 1kV, 0.1A, 3V				
PBH90H	CHN	90A, 1.2kV, 0.1A, 3V				



器件型号 Element type	厂名 Manufacturers	材料用途参数 Material Purpose Parameter	图号 Figure	国内外相似替换器件型号 Replace of similar type	备注 Notes	外形参考图 Reference shape
PBH90J	CHN	90A, 1.4kV, 0.1A, 3V				
PBH90K	CHN	90A, 1.6kV, 0.1A, 3V				
PBH110A	CHN	110A, 400V, 0.1A, 3V				
PBH110B	CHN	110A, 500V, 0.1A, 3V				
PBH110C	CHN	110A, 600V, 0.1A, 3V				
PBH110D	CHN	110A, 700V, 0.1A, 3V				
PBH110E	CHN	110A, 800V, 0.1A, 3V				
PBH110F	CHN	110A, 900V, 0.1A, 3V				
PBH110G	CHN	110A, 1kV, 0.1A, 3V				
PBH110H	CHN	110A, 1.2kV, 0.1A, 3V				
PBH110J	CHN	110A, 1.4kV, 0.1A, 3V				
PBH110K	CHN	110A, 1.6kV, 0.1A, 3V				
PBH130A	CHN	130A, 400V, 0.1A, 3V				
PBH130B	CHN	130A, 500V, 0.1A, 3V				
PBH130C	CHN	130A, 600V, 0.1A, 3V				
PBH130D	CHN	130A, 700V, 0.1A, 3V				
PBH130E	CHN	130A, 800V, 0.1A, 3V				
PBH130F	CHN	130A, 900V, 0.1A, 3V				
PBH130G	CHN	130A, 1kV, 0.1A, 3V				
PBH130H	CHN	130A, 1.2kV, 0.1A, 3V				
PBH130J	CHN	130A, 1.4kV, 0.1A, 3V				
PBH130K	CHN	130A, 1.6kV, 0.1A, 3V				
PBH160A	CHN	160A, 400V, 0.1A, 3V				
PBH160B	CHN	160A, 500V, 0.1A, 3V				
PBH160C	CHN	160A, 600V, 0.1A, 3V				
PBH160D	CHN	160A, 700V, 0.1A, 3V				

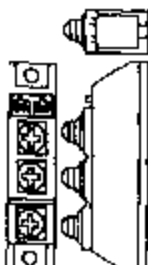

器件型号 Element type	厂名 Manufacturers	材料用途参数 Material Purpose Parameter	图号 Figure	国内外相似替换器件型号 Repace of similar type	备注 Notes	外形参考图 Reference shape
PBH160F	CHN	160A, 800V, 0.1A, 3V				 <p>图 H-15</p>
PBH160F	CHN	160A, 900V, 0.1A, 3V				
PBH160G	CHN	160A, 1kV, 0.1A, 3V				
PBH160H	CHN	160A, 1.2kV, 0.1A, 3V				
PBH160J	CHN	160A, 1.4kV, 0.1A, 3V				
PBH160K	CHN	160A, 1.6kV, 0.1A, 3V				
PBT25A	CHN	25A, 400V, 0.1A, 3V				
PBT25B	CHN	25A, 500V, 0.1A, 3V				
PBT25C	CHN	25A, 600V, 0.1A, 3V				
PBT25D	CHN	25A, 700V, 0.1A, 3V				
PBT25E	CHN	25A, 800V, 0.1A, 3V				
PBT25F	CHN	25A, 900V, 0.1A, 3V				
PBT25G	CHN	25A, 1kV, 0.1A, 3V				
PBT25H	CHN	25A, 1.2kV, 0.1A, 3V				
PBT25J	CHN	25A, 1.4kV, 0.1A, 3V				
PBT25K	CHN	25A, 1.6kV, 0.1A, 3V				
PBT25-04	AEI	SCA 25A, 400V, 0.08A, 3V	H-15			
PBT25-06	AEI	SCA 25A, 600V, 0.08A, 3V	H-15			
PBT25-08	AEI	SCA 25A, 800V, 0.08A, 3V	H-15			
PBT25-10	AEI	SCA 25A, 1kV, 0.08A, 3V	H-15			
PBT25-12	AEI	SCA 25A, 1.2kV, 0.08A, 3V	H-15			
PBT25-14	AEI	SCA 25A, 1.4kV, 0.08A, 3V	H-15			
PBT45-04	AEI	SCA 45A, 400V, 0.15A, 3V	H-15			
PBT45-06	AEI	SCA 45A, 600V, 0.15A, 3V	H-15			
PBT45-08	AEI	SCA 45A, 800V, 0.15A, 3V	H-15			
PBT45-10	AEI	SCA 45A, 1kV, 0.15A, 3V	H-15			

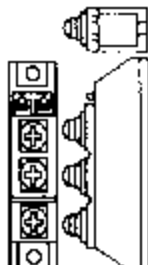



器件型号 Element type	厂名 Manufacturers	材料用途参数 Material Purpose Parameter	图号 Figures	国内外相似替换器件型号 Replace of similar type	备注 Notes	外形参考图 Reference snapp
PBT45-12	AEI	SCA 45A, 1.2kV, 0.15A, 3V	H-15			 <p>图 H 15</p>
PBT45-14	AEI	SCA 45A, 1.4kV, 0.15A, 3V	H-15			
PBT55A	CHN	55A, 400V, 0.1A, 3V				
PBT55B	CHN	55A, 500V, 0.1A, 3V				
PBT55C	CHN	55A, 600V, 0.1A, 3V				
PBT55D	CHN	55A, 700V, 0.1A, 3V				
PBT55E	CHN	55A, 800V, 0.1A, 3V				
PBT55F	CHN	55A, 900V, 0.1A, 3V				
PBT55G	CHN	55A, 1kV, 0.1A, 3V				
PBT55H	CHN	55A, 1.2kV, 0.1A, 3V				
PBT55J	CHN	55A, 1.4kV, 0.1A, 3V				
PBT55K	CHN	55A, 1.6kV, 0.1A, 3V				
PBT55-04	AEI	SCA 55A, 400V, 0.15A, 3V	H-15			
PBT55-06	AEI	SCA 55A, 600V, 0.15A, 3V	H-15			
PBT55-08	AEI	SCA 55A, 800V, 0.15A, 3V	H-15			
PBT55-10	AEI	SCA 55A, 1kV, 0.15A, 3V	H-15			
PBT55-12	AEI	SCA 55A, 1.2kV, 0.15A, 3V	H-15			
PBT55-14	AEI	SCA 55A, 1.4kV, 0.15A, 3V	H-15			
PBT90A	CHN	90A, 400V, 0.1A, 3V				
PBT90B	CHN	90A, 500V, 0.1A, 3V				
PBT90C	CHN	90A, 600V, 0.1A, 3V				
PBT90D	CHN	90A, 700V, 0.1A, 3V				
PBT90E	CHN	90A, 800V, 0.1A, 3V				
PBT90F	CHN	90A, 900V, 0.1A, 3V				
PBT90G	CHN	90A, 1kV, 0.1A, 3V				
PBT90H	CHN	90A, 1.2kV, 0.1A, 3V				

器件型号 Element: type	厂名 Manufacturers	材料用途参数 Material Purpose Parameter	图号 Figure	国内外相似替换器件型号 Replace of similar type	备注 Notes	外形参考图 Reference shape
PBT90J	CHN	90A, 1.4kV, 0.1A, 3V				 <p>图 H-15</p>
PBT90K	CHN	90A, 1.6kV, 0.1A, 3V				
PBT90-04	AEI	SCA 90A, 400V, 0.15A, 3V	H-15			
PBT90-06	AEI	SCA 90A, 600V, 0.15A, 3V	H-15			
PBT90-08	AEI	SCA 90A, 800V, 0.15A, 3V	H-15			
PBT90-10	AEI	SCA 90A, 1kV, 0.15A, 3V	H-15			
PBT90-12	AEI	SCA 90A, 1.2kV, 0.15A, 3V	H-15			
PBT90-14	AEI	SCA 90A, 1.4kV, 0.15A, 3V	H-15			
PBT110A	CHN	110A, 400V, 0.1A, 3V				
PBT110B	CHN	110A, 500V, 0.1A, 3V				
PBT110C	CHN	110A, 600V, 0.1A, 3V				
PBT110D	CHN	110A, 700V, 0.1A, 3V				
PBT110E	CHN	110A, 800V, 0.1A, 3V				
PBT110F	CHN	110A, 900V, 0.1A, 3V				
PBT110G	CHN	110A, 1kV, 0.1A, 3V				
PBT110H	CHN	110A, 1.2kV, 0.1A, 3V				
PBT110J	CHN	110A, 1.4kV, 0.1A, 3V				
PBT110K	CHN	110A, 1.6kV, 0.1A, 3V				
PBT130A	CHN	130A, 400V, 0.1A, 3V				
PBT130B	CHN	130A, 500V, 0.1A, 3V				
PBT130C	CHN	130A, 600V, 0.1A, 3V				
PBT130D	CHN	130A, 700V, 0.1A, 3V				
PBT130E	CHN	130A, 800V, 0.1A, 3V				
PBT130F	CHN	130A, 900V, 0.1A, 3V				
PBT130G	CHN	130A, 1kV, 0.1A, 3V				
PBT130H	CHN	130A, 1.2kV, 0.1A, 3V				

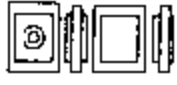

器件型号 Element type	厂名 Manufacturers	材料用途参数 Material Purpose Parameter	图号 Figure	国内外相似替换器件型号 Replace of similar type	备注 Notes	外形参考图 Reference shape
PBT130J	CHN	130A, 1.4kV, 0.1A, 3V				 图 A-10
PBT130K	CHN	130A, 1.6kV, 0.1A, 3V				
PBT160A	CHN	160A, 400V, 0.1A, 3V				 图 A-11
PBT160B	CHN	160A, 500V, 0.1A, 3V				
PBT160C	CHN	160A, 600V, 0.1A, 3V				
PBT160D	CHN	160A, 700V, 0.1A, 3V				
PBT160E	CHN	160A, 800V, 0.1A, 3V				
PBT160F	CHN	160A, 900V, 0.1A, 3V				
PBT160G	CHN	160A, 1kV, 0.1A, 3V				
PBT160H	CHN	160A, 1.2kV, 0.1A, 3V				
PBT160J	CHN	160A, 1.4kV, 0.1A, 3V				
PBT160K	CHN	160A, 1.6kV, 0.1A, 3V				
PC204C	TCE	4A, 200V, 0.01A, 1.5V	A-10			
PC210B	TCE	10A, 200V, 0.15A, 1.5V	A-10			
PC215B	TCE	15A, 200V, 0.02A, 1.5V	A-11			
PC235B	TCE	35A, 200V, 0.05A, 2V	A-11			
PC245C	TCE	45A, 200V, 0.05A, 2V	A-11			
PC265B	TCE	65A, 200V, 0.1A, 2V	A-11			
PC404C	TCE	4A, 400V, 0.01A, 1.5V	A-10			
PC435B	TCE	35A, 400V, 0.05A, 2V	A-11			
PC445C	TCE	45A, 400V, 0.05A, 2V	A-11			
PC465B	TCE	65A, 400V, 0.1A, 2V	A-11			
PC504C	TCE	4A, 500V, 0.01A, 1.5V	A-10			
PC510B	TCE	10A, 500V, 0.015A, 1.5V	A-10			
PC515B	TCE	15A, 500V, 0.02A, 1.5V	A-11			

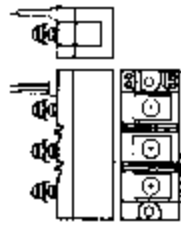
器件型号 Element type	厂名 Manufacturers	材料用途参数 Material Purpose Parameter	图号 Figure	国内外相似替换器件型号 Replace of similar type	备注 Notes	外形参考图 Reference shape
PC535B	TCE	35A, 500V, 0.05A, 2V	A-11			 图 A-11
PC545C	TCE	45A, 500V, 0.05A, 2V	A-11			
PC565B	TCE	65A, 500V, 0.1A, 2V	A-11			
PC604C	TCE	4A, 600V, 0.01A, 1.5V	A-10			
PC615B	TCE	15A, 600V, 0.02A, 1.5V	A-11			
PC635B	TCE	35A, 600V, 0.05A, 2V	A-11			
PC645C	TCE	45A, 600V, 0.05A, 2V	A-11			
PC665B	TCE	65A, 600V, 0.1A, 2V	A-11			
PD25C100	SEM	25A, 1kV, 0.05A, 3V	H-29			 图 A-10
PD25C120	SEM	25A, 1.2kV, 0.05A, 3V	H-29			
PD25F-40		MOD-D, 25A, 400V				
PD25F-80		MOD-D, 25A, 800V				
PD25F-120		MOD-D, 25A, 1.2kV, 0.05A, 3V				
PD25F-160		MOD-D, 25A, 1.6kV, 0.05A, 3V				
PD25GB	CHN	25A, 400V, 0.05A, 3V				
PD25GB-40		MOD-D, 25A, 400V, 0.05A, 3V				
PD25GB-80		MOD-D, 25A, 800V, 0.05A, 3V				
PD25HB	CHN	25A, 1.2kV, 0.05A, 2V				
PD25HB-120		MOD-D, 25A, 1.2kV				
PD25HB-160		MOD-D, 25A, 1.6kV				
PD40C100	SEM	40A, 1kV, 0.07A, 3V	H-29			 图 H-29
PD40C120	SEM	40A, 1.2kV, 0.07A, 3V	H-29			
PD40F-40		MOD-D, 40A, 400V, 0.07A, 3V				
PD40F-80		MOD-D, 40A, 800V, 0.07A, 3V				
PD40F-120		MOD-D, 40A, 1.2kV, 0.07A, 3V				
PD40F-160		MOD-D, 40A, 1.6kV, 0.07A, 3V				

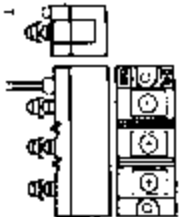

器件型号 Element type	厂名 Manufacturers	材料用途参数 Material Purpose Parameter	图号 Figure	国内外相似替换器件型号 Replace of similar type	备注 Notes	外形参考图 Reference shape
PD50C100	SEM	50A, 1kV, 0.07A, 3V	H-29			 <p>图 H-29</p>
PD50C120	SEM	50A, 1.2kV, 0.07A, 3V	H-29			
PD55F-40		MOD-D, 55A, 400V				
PD55F-80		MOD-D, 55A, 800V				
PD55F-120		MOD-D, 55A, 1.2kV				
PD55F-160		MOD-D, 55A, 1.6kV				
PD55GB	CHN	55A, 400V, 0.1A, 3V				
PD55GR-40		MOD-D, 55A, 400V				
PD55GB-80		MOD-D, 55A, 800V				
PD55HB		55A, 1.2kV, 0.07A, 3V				
PD55HB-120	CHN	MOD-D, 55A, 1.2kV				
PD55HB-160		MOD-D, 55A, 1.6kV				
PD70F-40		MOD-D, 70A, 400V				
PD70F-80		MOD-D, 70A, 800V				
PD70F-120		MOD-D, 70A, 1.2kV				
PD90F-40		MOD-D, 90A, 400V				
PD90F-80		MOD-D, 90A, 800V				
PD90F-120		MOD-D, 90A, 1.2kV				
PD90F-160		MOD-D, 90A, 1.6kV				
PD90GB	CHN	90A, 400V, 0.1A, 3V				
PD90GB-40		MOD-D, 90A, 400V				
PD90GB-80		MOD-D, 90A, 800V				
PD90HB	CHN	90A, 1.2kV, 0.1A, 3V				
PD90HB-120		MOD-D, 90A, 1.2kV				
PD90HB-160		MOD-D, 90A, 1.6kV				
PD100C100	SEM	100A, 1kV, 0.1A, 3V	H-29			

器件型号 Element type	厂名 Manufacturers	材料用途参数 Material Purpose Parameter	图号 Figure	国内外相似替换器件型号 Replace of similar type	备注 Notes	外形参考图 Reference shape
PD100C120	SEM	100A, 1.2kV, 0.1A, 3V	H-29			
PD110F-40		MOD-D, 110A, 400V				
PD110F-80		MOD-D, 110A, 800V				
PD110F-120		MOD-D, 110A, 1.2kV				
PD110F-160		MOD-D, 110A, 1.6kV				
PD130C100	SEM	130A, 1kV, 0.1A, 3V	H-27			
PD130C120	SEM	130A, 1.2kV, 0.1A, 3V	H-27			
PD130F-40		MOD-D, 130A, 400V				
PD130F-80		MOD-D, 130A, 800V				
PD130F-120		MOD-D, 130A, 1.2kV				
PD130F-160		MOD-D, 130A, 1.6kV				
PD160F-40		MOD-D, 160A, 400V				
PD160F-80		MOD-D, 160A, 800V				
PD160F-120		MOD-D, 160A, 1.2kV				
PD160F-160		MOD-D, 160A, 1.6kV				
PD200GB-40		MOD-D, 200A, 400V				
PD200GB-80		MOD-D, 200A, 800V				
PD200HB-120		MOD-D, 200A, 1.2kV				
PD200HB-160		MOD-D, 200A, 1.6kV				
PD250GB-40		MOD-D, 250A, 400V				
PD250GB-80		MOD-D, 250A, 800V				
PD250HB-120		MOD-D, 250A, 1.2kV				
PD250HB-160		MOD-D, 250A, 1.6kV				



图 H-29





图 H-27

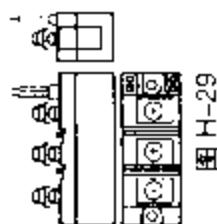

器件型号 Element type	厂名 Manufacturers	材料用途参数 Material Purpose Parameter	图号 Figure	国内外相似替换器件型号 Replace of similar type	备注 Notes	外形参考图 Reference shape
PE25F-40		MOD-D, 25A, 400V				
PE25F-80		MOD-D, 25A, 800V				
PE25F-120		MOD-D, 25A, 1.2kV				
PE25F-160		MOD-D, 25A, 1.6kV				
PE25GB-40		MOD-D, 25A, 400V				
PE25GB-80		MOD-D, 25A, 800V				
PE25HB-120		MOD-D, 25A, 1.2kV				
PE25HB-160		MOD-D, 25A, 1.6kV				
PE40F-40		MOD-D, 40A, 400V				
PE40F-80		MOD-D, 40A, 800V				
PE40F-120		MOD-D, 40A, 1.2kV				
PE40F-160		MOD-D, 40A, 1.6kV				
PE55F-40		MOD-D, 55A, 400V				
PE55F-80		MOD-D, 55A, 800V				
PE55F-120		MOD-D, 55A, 1.2kV				
PE55F-160		MOD-D, 55A, 1.6kV				
PE55GB-40		MOD-D, 55A, 400V				
PE55GB-80		MOD-D, 55A, 800V				
PE55HB-120		MOD-D, 55A, 1.2kV				
PE55HB-160		MOD-D, 55A, 1.6kV				
PE70F-40		MOD-D, 70A, 400V				
PE70F-80		MOD-D, 70A, 800V				
PE70F-120		MOD-D, 70A, 1.2kV				
PE70F-160		MOD-D, 70A, 1.6kV				
PE90F-40		MOD-D, 90A, 400V				

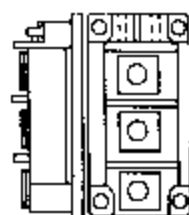
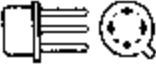
器件型号 Element type	厂名 Manufacturers	材料用途参数 Material Purpose Parameter	图号 Figure	国内外相似替换器件型号 Replace of similar type	备注 Notes	外形参考图 Reference shape
PE90F-80		MOD-D, 90A, 800V				 图 B-55
PE90F-120		MOD-D, 90A, 1.2kV				
PE90F-160		MOD-D, 90A, 1.6kV				
PE90GB-40		MOD-D, 90A, 400V				
PE90HB-120		MOD-D, 90A, 1.2kV				
PE90HB-160		MOD-D, 90A, 1.6kV				
PE110F-40		MOD-D, 110A, 400V				
PE110F-80		MOD-D, 110A, 800V				
PE110F-120		MOD-D, 110A, 1.2kV				
PE110F-160		MOD-D, 110A, 1.6kV				
PE130F-40		MOD-D, 130A, 400V				
PE130F-80		MOD-D, 130A, 800V				
PE130F-120		MOD-D, 130A, 1.2kV				
PE130F-160		MOD-D, 130A, 1.6kV				
PE160F-40		MOD-D, 160A, 400V				
PE160F-160		MOD-D, 160A, 1.6kV				
PED160F-80		MOD-D, 160A, 800V				
PFB15AA80		MOD-D, 6 x SCR, 15A, 800V				
PFB15AA120		MOD-D, 6 x SCR, 15A, 1.2kV				
PFB15AA160		MOD-D, 6 x SCR, 15A, 1.6kV				
PIC100, 101		0.8A, 200V	B-55			
PIC102, 103		0.8A, 400V	B-55			
PIC110		0.8A, 175V	B-55			

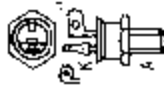

器件型号 Element type	厂名 Manufacturers	材料用途参数 Material Purpose Parameter	图号 Figure	国内外相似替换器件型号 Replace of similar type	备注 Notes	外形参考图 Reference shape	
PIC111		0.8A, 350V	B-55				
PIC120, 121		4A, 200V	D-19				
PIC122, 123		4A, 400V	D-19				
PIC130		4A, 175V	D-19				
PIC131		4A, 350V	D-19				
PK25F-40		MOD, 2 x SCR, 25A, 400V				  图 B-55	
PK25F-80		MOD, 2 x SCR, 25A, 800V					
PK25F-120		MOD, 2 x SCR, 25A, 1.2kV					
PK25F-160		MOD, 2 x SCR, 25A, 1.6kV					
PK25GB-40		MOD, 2 x SCR, 25A, 400V					
PK25GB-80		MOD, 2 x SCR, 25A, 800V					
PK25HB-120		MOD, 2 x SCR, 25A, 1.2kV					
PK25HB-160		MOD, 2 x SCR, 25A, 1.6kV					
PK40F-40		MOD, 2 x SCR, 40A, 400V					 图 D-19
PK40F-80		MOD, 2 x SCR, 40A, 800V					
PK40F-120		MOD, 2 x SCR, 40A, 1.2kV					
PK40F-160		MOD, 2 x SCR, 40A, 1.6kV					
PK55F-40		MOD, 2 x SCR, 55A, 400V					
PK55F-80		MOD, 2 x SCR, 55A, 800V					
PK55F-120		MOD, 2 x SCR, 55A, 1.2kV					
PK55F-160		MOD, 2 x SCR, 55A, 1.6kV					
PK55GB-40		MOD, 2 x SCR, 55A, 400V					
PK55GB-80		MOD, 2 x SCR, 55A, 800V					
PK55HB-120		MOD, 2 x SCR, 55A, 1.2kV					

器件型号 Element type	厂名 Manufacturers	材料用途参数 Material Purpose Parameter	图号 Figure	国内外相似替换器件型号 Replace of similar type	备注 Notes	外形参考图 Reference shape
PK55HB-160		MOD, 2 x SCR, 55A, 1.6kV				
PK70F-40		MOD, 2 x SCR, 70A, 400V				
PK70F-80		MOD, 2 x SCR, 70A, 800V				
PK70F-120		MOD, 2 x SCR, 70A, 1.2kV				
PK70F-160		MOD, 2 x SCR, 70A, 1.6kV				
PK90F-40		MOD, 2 x SCR, 90A, 400V				
PK90F-80		MOD, 2 x SCR, 90A, 800V				
PK90F-120		MOD, 2 x SCR, 90A, 1.2kV				
PK90F-160		MOD, 2 x SCR, 90A, 1.6kV				
PK90GB-40		MOD, 2 x SCR, 90A, 400V				
PK90GB-80		MOD, 2 x SCR, 90A, 800V				
PK90HB-120		MOD, 2 x SCR, 90A, 1.2kV				
PK90HB-160		MOD, 2 x SCR, 90A, 1.6kV				
PK110F-40		MOD, 2 x SCR, 110A, 400V				
PK110F-80		MOD, 2 x SCR, 110A, 800V				
PK110F-120		MOD, 2 x SCR, 110A, 1.2kV				
PK110F-160		MOD, 2 x SCR, 110A, 1.6kV				
PK130F-40		MOD, 2 x SCR, 130A, 400V				
PK130F-80		MOD, 2 x SCR, 130A, 800V				
PK130F-120		MOD, 2 x SCR, 130A, 1.2kV				
PK130F-160		MOD, 2 x SCR, 130A, 1.6kV				
PK160F-40		MOD, 2 x SCR, 120A, 400V				
PK160F-80		MOD, 2 x SCR, 120A, 800V				
PK160F-120		MOD, 2 x SCR, 120A, 1.2kV				



器件型号 Element type	厂名 Manufacturers	材料用途参数 Material Purpose Parameter	图号 Figure	国内外相似替换器件型号 Roplace of similar type	备注 Notes	外形参考图 Reference shape
PK160F-160		MOD, 2 x SCR, 160A, 1.6kV				
PK200GB-40		MOD, 2 x SCR, 200A, 400V				
PK200GB-80		MOD, 2 x SCR, 200A, 800V				
PK200HB-120		MOD, 2 x SCR, 200A, 1.2kV				
PK200HB-160		MOD, 2 x SCR, 200A, 1.6kV				
PK250GB-40		MOD, 2 x SCR, 250A, 400V				
PK250GB-80		MOD, 2 x SCR, 250A, 800V				
PK250HB-120		MOD, 2 x SCR, 250A, 1.2kV				
PK250HB-160		MOD, 2 x SCR, 250A, 1.6kV				
PL111AA		7A, 100V	B-36			
PL111BA		7A, 200V	B-36			
PL111CA		7A, 300V	B-36			
PL111DA		7A, 400V	B-36			
PL115AA		7A, 100V	B-36			
PL115BA		7A, 200V	B-36			
PL115CA		7A, 300V	B-36			
PL115DA		7A, 400V	B-36			
PM51A2G	AEI	SCA 5A, 0.025A, 3V	H-26			
PM51A2QG	AEI	SCA 8A, 0.025A, 3V	H-26			
PM51A4G	AEI	SCA 5A, 0.025A, 3V	H-26			
PM51A4QG	AEI	SCA 8A, 0.025A, 3V	H-26			
PM51A5G	AEI	SCA 5A, 0.025A, 3V	H-26			
PM51A5QG	AEI	SCA 8A, 0.025A, 3V	H-26			
PM51A6G	AEI	SCA 5A, 0.025A, 3V	H-26			
PM51A6QG	AEI	SCA 8A, 0.025A, 3V	H-26			



图 B-36



图 H-26

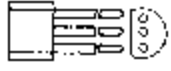

器件型号 Element type	厂名 Manufacturers	材料用途参数 Material Purpose Parameter	图号 Figure	国内外相似替换器件型号 Replace of similar type	备注 Notes	外形参考图 Reference snape
PM51A7G	AEI	SCA 5A, 0.025A, 3V	H-26			 图 H-26
PM51A7QG	AEI	SCA 8A, 0.025A, 3V	H-26			
PO100DA		0.8A, 220V		MCR100-4		 图 B-55
PO100MA		0.8A, 400V		MCR100-6		
PO102AA		0.8A, 500V		MCR100-8		 图 H-26
PO102BA, CA		0.8A, 200V		MCR100-4		
PO102DA		0.8A, 400V		MCR100-6		
PO103AD		0.8A, 400V		MCR100-6		
PO103BA		1.6A, 100V	B-55	2N2324		
PO103BD		0.8A, 200V		MCR100-4		
PO103CD		1.8A, 200V	B-55	2N2326		
PO103DA		1.6A, 400V	B-55	2N2329		
PO103DD		0.8A, 400V		MCR100-6		
PS010	HUT	10A, 50V, 0.025A, 2V		SK3016		
PS020	HUT	20A, 50V, 0.025A, 2V		S0520L, S6200A		
PS025	HUT	25A, 50V, 0.025A, 2V		SK3016, S0535G		
PS035	HUT	35A, 50V, 0.025A, 2V		SK3016, S0535G		
PS08	HUT	8A, 50V, 0.025A, 2V		S0508B, S6200A, ECG5514		 图 B-55
PS18	HUT	8A, 100V, 0.025A, 2V		ECG5514, SK3613, SK5514		
PS28	HUT	8A, 200V, 0.025A, 2V		ECG5514, SK3613, SK5514		
PS38	HUT	8A, 300V, 0.025A, 2V		ECG5515, SK6615, SK5515		
PS48	HUT	8A, 400V, 0.025A, 2V		ECG5515, S4008		
PS58	HUT	8A, 500V, 0.025A, 2V		ECG5516, SK6616, SK5516		
PS68	HUT	8A, 600V, 0.025A, 2V		ECG5516, S6008		

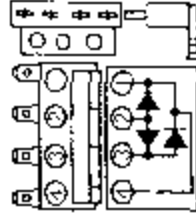
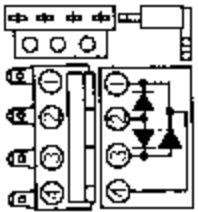
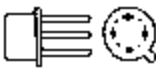
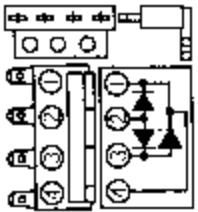
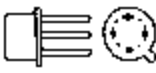
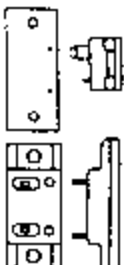
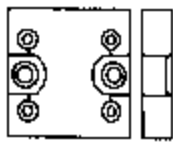
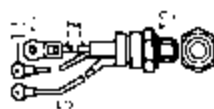
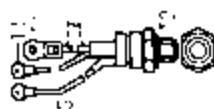
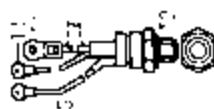
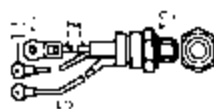
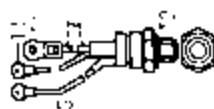
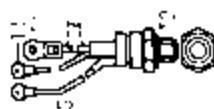

器件型号 Element type	厂名 Manufacturers	材料用途参数 Material Purpose Parameter	图号 Figure	国内外相似替换器件型号 Replace of similar type	备注 Notes	外形参考图 Reference shape
PS25-02	AEI	SCA 25A, 200V, 0.06A, 3V	H-3			 图 H-3
PS25-04	AEI	SCA 25A, 400V, 0.06A, 3V	H-3			
PS25-06	AEI	SCA 25A, 600V, 0.06A, 3V	H-3			
PS100-01	AEI	SCA 45A, 0.15A, 3V	H-1			
PS100-02	AEI	SCA 45A, 0.15A, 3V	H-1			
PS100-02 # ai	AEI	SCA 100A, 200V, 0.15A, 3V	H-1			
PS100-03	AEI	SCA 45A, 0.15A, 3V	H-1			
PS100-03 # ai	AEI	SCA 100A, 200V, 0.15A, 3V	H-1			
PS100-04	AEI	SCA 45A, 0.15A, 3V	H-1			
PS100-04 # ai	AEI	SCA 100A, 400V, 0.15A, 3V	H-1			
PS100-05	AEI	SCA 45A, 0.15A, 3V	H-1			
PS100-05 # ai	AEI	SCA 100A, 500V, 0.15A, 3V	H-1			
PS100-06	AEI	SCA 45A, 0.15A, 3V	H-1			
PS100-06 # ai	AEI	SCA 100A, 600V, 0.15A, 3V	H-1			
PS100-08	AEI	SCA 45A, 0.15A, 3V	H-1			
PS100-08 # ai	AEI	SCA 100A, 800V, 0.15A, 3V	H-1			
PS100-10	AEI	SCA 45A, 0.15A, 3V	H-1			
PS100-10 # ai	AEI	SCA 100A, 1kV, 0.15A, 3V	H-1			
PS100-11	AEI	SCA 45A, 0.15A, 3V	H-1			
PS100-11 # ai	AEI	SCA 100A, 1.1kV, 0.15A, 3V	H-1			
PS100-12	AEI	SCA 45A, 0.15A, 3V	H-1			
PS100-12 # ai	AEI	SCA 100A, 1.2kV, 0.15A, 3V	H-1			
PS110	HUT	10A, 100V, 0.025A, 2V		SK3017B/117		 图 H-1
PS120	HUT	20A, 100V, 0.025A, 2V		S1020L, S6200M, S1025G		
PS125	HUT	25A, 100V, 0.025A, 2V		ECG116, SK3016		
PS136	HUT	35A, 100V, 0.025A, 2V		SK3615, SK5517, S1035G		

器件型号 Element type	厂名 Manufacturers	材料用途参数 Material Purpose Parameter	图号 Figure	国内外相似替换器件型号 Replace of similar type	备注 Notes	外形参考图 Reference shape
PS210	HUT	10A, 200V, 0.025A, 2V		ECG5514, S2010B		 图 F-71
PS220	HUT	20A, 200V, 0.025A, 2V		ECG5514, S2020L, S6200B		
PS225	HUT	25A, 200V, 0.025A, 2V		S2025G		
PS235	HUT	35A, 200V, 0.025A, 2V		ECG5517, SK3615, SK5517, S2035G		
PS310	HUT	10A, 300V, 0.025A, 2V		ECG5515, SK6615, SK5515		 图 F-71
PS320	HUT	20A, 300V, 0.025A, 2V		ECG5515, S3020L, S6200D		
PS325	HUT	25A, 300V, 0.025A, 2V				
PS335	HUT	35A, 300V, 0.025A, 2V		ECG5518		
PS410	HUT	10A, 400V, 0.025A, 2V		SK6615, SK5515		 图 F-71
PS420	HUT	20A, 400V, 0.025A, 2V		SK6615, SK5515		
PS425	HUT	25A, 400V, 0.025A, 2V		ECG116, SK3016, S4025G		
PS435	HUT	35A, 400V, 0.025A, 2V		SK3016, S4035G		
PS510	HUT	10A, 500V, 0.025A, 2V		ECG5516, SK6616, SK5516		 图 F-71
PS520	HUT	20A, 500V, 0.025A, 2V		ECG5516, S5020L, S6200M		
PS525	HUT	25A, 500V, 0.025A, 2V		S5025G		
PS535	HUT	35A, 500V, 0.025A, 2V		ECG5519, S5035G		
PS610	HUT	10A, 600V, 0.025A, 2V		SK6616, SK5516		 图 F-71
PS620	HUT	20A, 600V, 0.025A, 2V		ECG5516, S6020L, S6200M		
PS625	HUT	25A, 600V, 0.025A, 2V		S6025G		
PS610	HUT	10A, 600V, 0.025A, 2V		SK6616, SK5516		
PSIC235-1	POS	150A, 100V, 0.15A, 3V	F-71			 图 F-71
PSIC235-2	POS	150A, 200V, 0.15A, 3V	F-71			
PSIC235-3	POS	150A, 300V, 0.15A, 3V	F-8			
PSIC235-4	POS	150A, 400V, 0.15A, 3V	F-71			
PSIC235-5	POS	150A, 500V, 0.15A, 3V	F-71			



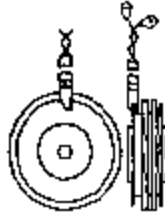

器件型号 Element type	厂名 Manufacturers	材料用途参数 Material Purpose Parameter	图号 Figure	国内外相似替换器件型号 Replace of similar type	备注 Notes	外形参考图 Reference shape	
PSIC235-6	POS	150A, 600V, 0.15A, 3V	F-71			 图 F-71	
PSIC235-7	POS	150A, 700V, 0.15A, 3V	F-71				
PSIC235-8	POS	150A, 800V, 0.15A, 3V	F-71				
PSIC235-9	POS	150A, 900V, 0.15A, 3V	F-71				
PSIC235-10	POS	150A, 1kV, 0.15A, 3V	F-71				
PSIC235-11	POS	150A, 1.1kV, 0.15A, 3V	F-71				
PSIC235-13	POS	150A, 1.3kV, 0.15A, 3V	F-71				
PSID470-1	POS	300A, 100V, 0.15A, 3V	F-76				 图 F-76
PSID470-2	POS	300A, 200V, 0.15A, 3V	F-76				
PSID470-3	POS	300A, 300V, 0.15A, 3V	F-76				
PSID470-4	POS	300A, 400V, 0.15A, 3V	F-76				
PSID470-5	POS	300A, 500V, 0.15A, 3V	F-76				
PSID470-6	POS	300A, 600V, 0.15A, 3V	F-76				
PSID470-7	POS	300A, 700V, 0.15A, 3V	F-76				
PSID470-8	POS	300A, 800V, 0.15A, 3V	F-76				
PSID470-9	POS	300A, 900V, 0.15A, 3V	F-76				
PSID470-10	POS	300A, 1kV, 0.15A, 3V	F-76				
PSID470-11	POS	300A, 1.1kV, 0.15A, 3V	F-76				
PSID470-13	POS	300A, 1.3kV, 0.15A, 3V	F-76				
PSIE180-1	POS	330A, 100V, 0.15A, 3V	C-25			 图 C-25	
PSIE180-2	POS	330A, 200V, 0.15A, 3V	C-25				
PSIE180-3	POS	330A, 300V, 0.15A, 3V	C-25				
PSIE180-4	POS	330A, 400V, 0.15A, 3V	C-25				
PSIE180-5	POS	330A, 500V, 0.15A, 3V	C-25				
PSIE180-6	POS	330A, 600V, 0.15A, 3V	C-25				
PSIE180-7	POS	330A, 700V, 0.15A, 3V	C-25				
PSIE180-8	POS	330A, 800V, 0.15A, 3V	C-25				

器件型号 Element type	厂名 Manufacturers	材料用途参数 Material Purpose Parameter	图号 Figure	国内外相似替换器件型号 Replace of similar type	备注 Notes	外形参考图 Reference shape
PSIE180-9	POS	330A, 900V, 0.15A, 3V	C-25			 <p>图 C-25</p>
PSIE180-10	POS	330A, 1kV, 0.15A, 3V	C-25			
PSIE180-20	POS	330A, 2kV, 0.15A, 3V	C-25			
PSIE180-22	POS	330A, 2.2kV, 0.15A, 3V	C-25			
PSIE180-24	POS	330A, 2.4kV, 0.15A, 3V	C-25			
PSIE180-26	POS	330A, 2.6kV, 0.15A, 3V	C-25			
PSIE180-28	POS	330A, 2.8kV, 0.15A, 3V	C-25			
PSIE181-1	POS	190A, 100V, 0.15A, 3V	C-25			
PSIE181-2	POS	190A, 200V, 0.15A, 3V	C-25			
PSIE181-3	POS	190A, 300V, 0.15A, 3V	C-25			
PSIE181-4	POS	190A, 400V, 0.15A, 3V	C-25			
PSIE181-5	POS	190A, 500V, 0.15A, 3V	C-25			
PSIE181-6	POS	190A, 600V, 0.15A, 3V	C-25			
PSIE300-1	POS	450A, 100V, 0.15A, 3V	C-25			
PSIE300-2	POS	450A, 200V, 0.15A, 3V	C-25			
PSIE300-3	POS	450A, 300V, 0.15A, 3V	C-25			
PSIE300-4	POS	450A, 400V, 0.15A, 3V	C-25			
PSIE300-5	POS	450A, 500V, 0.15A, 3V	C-25			
PSIE300-6	POS	450A, 600V, 0.15A, 3V	C-25			
PSIE300-7	POS	450A, 700V, 0.15A, 3V	C-25			
PSIE300-8	POS	450A, 800V, 0.15A, 3V	C-25			
PSIE300-9	POS	450A, 900V, 0.15A, 3V	C-25			
PSIE300-10	POS	450A, 1kV, 0.15A, 3V	C-25			
PSIE300-12	POS	450A, 1.2kV, 0.15A, 3V	C-25			
PSIE300-14	POS	450A, 1.4kV, 0.15A, 3V	C-25			
PSIE300-16	POS	450A, 1.6kV, 0.15A, 3V	C-25			
PSIE300-18	POS	450A, 1.8kV, 0.15A, 3V	C-25			
PSIE300-20	POS	450A, 2kV, 0.15A, 3V	C-25			

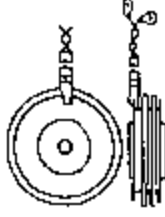

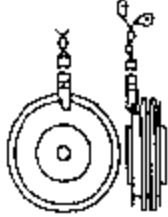
器件型号 Element type	厂名 Manufacturers	材料用途参数 Material Purpose Parameter	图号 Figure	国内外相似替换器件型号 Replace of similar type	备注 Notes	外形参考图 Reference shape
TSIE301-2	POS	260A, 200V, 0.15A, 3V	C-25			 <p>图 C-25</p>
TSIE301-3	POS	260A, 300V, 0.15A, 3V	C-25			
TSIE301-4	POS	260A, 400V, 0.15A, 3V	C-25			
TSIE301-5	POS	260A, 500V, 0.15A, 3V	C-25			
TSIE301-6	POS	260A, 600V, 0.15A, 3V	C-25			
PSIE400-1	POS	550A, 100V, 0.15A, 3V	C-25			
PSIE400-2	POS	550A, 200V, 0.15A, 3V	C-25			
PSIE400-3	POS	550A, 300V, 0.15A, 3V	C-25			
PSIE400-4	POS	550A, 400V, 0.15A, 3V	C-25			
PSIE400-5	POS	550A, 500V, 0.15A, 3V	C-25			
PSIE400-6	POS	550A, 600V, 0.15A, 3V	C-25			
PSIE400-7	POS	550A, 700V, 0.15A, 3V	C-25			
PSIE400-8	POS	550A, 800V, 0.15A, 3V	C-25			
PSIE400-9	POS	550A, 900V, 0.15A, 3V	C-25			
PSIE400-10	POS	550A, 1kV, 0.15A, 3V	C-25			
PSIE400-12	POS	550A, 1.2kV, 0.15A, 3V	C-25			
PSIE400-14	POS	550A, 1.4kV, 0.15A, 3V	C-25			
PSIE400-16	POS	600A, 1.6kV, 0.15A, 3V	C-25			
PSIE400-18	POS	550A, 1.8kV, 0.15A, 3V	C-25			
PSIE401-1	POS	320A, 100V, 0.15A, 3V	C-25			
PSIE401-2	POS	320A, 200V, 0.15A, 3V	C-25			
PSIE401-3	POS	320A, 300V, 0.15A, 3V	C-25			
PSIE401-4	POS	320A, 400V, 0.15A, 3V	C-25			
PSIE401-5	POS	320A, 500V, 0.15A, 3V	C-25			
PSIE401-6	POS	320A, 600V, 0.15A, 3V	C-25			
PSIE500-1	POS	600A, 100V, 0.15A, 3V	C-25			
PSIE500-2	POS	600A, 200V, 0.15A, 3V	C-25			

器件型号 Element type	厂名 Manufacturers	材料用途参数 Material Purpose Parameter	图号 Figure	国内外相似替换器件型号 Replace of similar type	备注 Notes	外形参考图 Reference shape
PSIE500-3	POS	600A, 300V, 0.15A, 3V	C-25			 图 C-25
PSIE500-4	POS	600A, 400V, 0.15A, 3V	C-25			
PSIE500-5	POS	600A, 500V, 0.15A, 3V	C-25			
PSIE500-6	POS	600A, 600V, 0.15A, 3V	C-25			
PSIE500-7	POS	600A, 700V, 0.15A, 3V	C-25			
PSIE500-8	POS	600A, 800V, 0.15A, 3V	C-25			
PSIE500-9	POS	600A, 900V, 0.15A, 3V	C-25			
PSIE500-10	POS	600A, 1kV, 0.15A, 3V	C-25			
PSIE501-1	POS	350A, 100V, 0.15A, 3V	C-25			
PSIE501-2	POS	350A, 200V, 0.15A, 3V	C-25			
PSIE501-3	POS	350A, 300V, 0.15A, 3V	C-25			
PSIE501-4	POS	350A, 400V, 0.15A, 3V	C-25			
PSIE501-5	POS	350A, 500V, 0.15A, 3V	C-25			
PSIE501-6	POS	350A, 600V, 0.15A, 3V	C-25			
PSIE600-1	POS	650A, 100V, 0.15A, 3V	C-25			 图 C-2
PSIE600-2	POS	650A, 200V, 0.15A, 3V	C-25			
PSIE600-3	POS	650A, 300V, 0.15A, 3V	C-25			
PSIE600-4	POS	650A, 400V, 0.15A, 3V	C-25			
PSIE600-5	POS	650A, 500V, 0.15A, 3V	C-25			
PSIE600-6	POS	650A, 600V, 0.15A, 3V	C-25			
PSIE600-7	POS	650A, 700V, 0.15A, 3V	C-25			
PSIE600-8	POS	650A, 800V, 0.15A, 3V	C-25			
PSIE600-9	POS	650A, 900V, 0.15A, 3V	C-25			
PSIE600-10	POS	650A, 1kV, 0.15A, 3V	C-25			
PSIE600-12	POS	600A, 1.2kV, 0.15A, 3V	C-2			
PSIE600-14	POS	600A, 1.4kV, 0.15A, 3V	C-2			
PSIE601-1	POS	385A, 100V, 0.15A, 3V	C-25			
PSIE601-2	POS	385A, 200V, 0.15A, 3V	C-25			

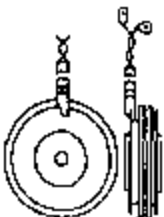

器件型号 Element type	厂名 Manufacturers	材料 Material	器件用途与参数 Purpose and parameter	图号 Figure	国内外相似替换器件型号 Replace of similar type	备注 Notes	外形参考图 Reference shape
PSIE601-3	POS		385A, 300V, 0.15A, 3V	C-25			 图 C-25
PSIE601-4	POS		385A, 400V, 0.15A, 3V	C-25			
PSIE601-5	POS		385A, 500V, 0.15A, 3V	C-25			
PSIE601-6	POS		385A, 600V, 0.15A, 3V	C-25			
PSIF180-1	POS		330A, 100V, 0.15A, 3V	C-25			
PSIF180-2	POS		330A, 200V, 0.15A, 3V	C-25			
PSIF180-3	POS		330A, 300V, 0.15A, 3V	C-25			
PSIF180-4	POS		330A, 400V, 0.15A, 3V	C-25			
PSIF180-5	POS		330A, 500V, 0.15A, 3V	C-25			
PSIF180-6	POS		330A, 600V, 0.15A, 3V	C-25			
PSIF180-7	POS		330A, 700V, 0.15A, 3V	C-25			
PSIF180-8	POS		330A, 800V, 0.15A, 3V	C-25			
PSIF180-9	POS		330A, 900V, 0.15A, 3V	C-25			
PSIF180-10	POS		330A, 1kV, 0.15A, 3V	C-25			
PSIF180-14	POS		330A, 1.4kV, 0.15A, 3V	C-25			
PSIF180-16	POS		330A, 1.6kV, 0.15A, 3V	C-25			
PSIF180-18	POS		330A, 1.8kV, 0.15A, 3V	C-25			
PSIF180-20	POS		330A, 2kV, 0.15A, 3V	C-25			
PSIF180-22	POS		330A, 2.2kV, 0.15A, 3V	C-25			
PSIF180-24	POS		330A, 2.4kV, 0.15A, 3V	C-25			
PSIF180-26	POS		330A, 2.6kV, 0.15A, 3V	C-25			
PSIF180-28	POS		330A, 2.8kV, 0.15A, 3V	C-25			
PSIF180-30	POS		330A, 3kV, 0.15A, 3V	C-25			
PSIF220-1	POS		370A, 100V, 0.15A, 3V	C-25			
PSIF220-2	POS		370A, 200V, 0.15A, 3V	C-25			
PSIF220-3	POS		370A, 300V, 0.15A, 3V	C-25			
PSIF220-4	POS		370A, 400V, 0.15A, 3V	C-25			

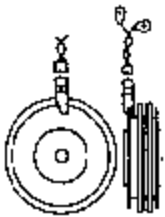
器件型号 Element type	厂名 Manufacturers	材料用途参数 Material Purpose Parameter	图号 Figure	国内外相似替换器件型号 Replace of similar type	备注 Notes	外形参考图 Reference shape
PSIF220-5	POS	370A, 500V, 0.15A, 3V	C-25			 <p>图 C 25</p>
PSIF220-6	POS	370A, 600V, 0.15A, 3V	C-25			
PSIF220-7	POS	370A, 700V, 0.15A, 3V	C-25			
PSIF220-8	POS	370A, 800V, 0.15A, 3V	C-25			
PSIF220-9	POS	370A, 900V, 0.15A, 3V	C-25			
PSIF220-10	POS	370A, 1kV, 0.15A, 3V	C-25			
PSIF220-12	POS	370A, 1.2kV, 0.15A, 3V	C-25			
PSIF220-16	POS	370A, 1.6kV, 0.15A, 3V	C-25			
PSIF220-18	POS	370A, 1.8kV, 0.15A, 3V	C-25			
PSIF220-20	POS	370A, 2kV, 0.15A, 3V	C-25			
PSIF220-22	POS	370A, 2.2kV, 0.15A, 3V	C-25			
PSIF220-24	POS	370A, 2.4kV, 0.15A, 3V	C-25			
PSIF220-26	POS	370A, 2.6kV, 0.15A, 3V	C-25			
PSIF300-1	POS	450A, 100V, 0.15A, 3V	C-25			
PSIF300-2	POS	450A, 200V, 0.15A, 3V	C-25			
PSIF300-3	POS	450A, 300V, 0.15A, 3V	C-25			
PSIF300-4	POS	450A, 400V, 0.15A, 3V	C-25			
PSIF300-5	POS	450A, 500V, 0.15A, 3V	C-25			
PSIF300-6	POS	450A, 600V, 0.15A, 3V	C-25			
PSIF300-7	POS	450A, 700V, 0.15A, 3V	C-25			
PSIF300-8	POS	450A, 800V, 0.15A, 3V	C-25			
PSIF300-9	POS	450A, 900V, 0.15A, 3V	C-25			
PSIF300-10	POS	450A, 1kV, 0.15A, 3V	C-25			
PSIF300-12	POS	450A, 1.2kV, 0.15A, 3V	C-25			
PSIF300-14	POS	450A, 1.4kV, 0.15A, 3V	C-25			
PSIF300-16	POS	450A, 1.6kV, 0.15A, 3V	C-25			
PSIF300-18	POS	450A, 1.8kV, 0.15A, 3V	C-25			
PSIF300-20	POS	450A, 2kV, 0.15A, 3V	C-25			

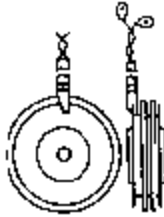

器件型号 Element type	厂名 Manufacturers	材料用途参数 Material Purpose Parameter	图号 Figure	国内外相似替换器件型号 Replace of similar type	备注 Notes	外形参考图 Reference shape
PSIF400-1	POS	550A, 100V, 0.15A, 3V	C-25			 <p>图 C-25</p>
PSIF400-2	POS	550A, 200V, 0.15A, 3V	C-25			
PSIF400-3	POS	550A, 300V, 0.15A, 3V	C-25			
PSIF400-4	POS	550A, 400V, 0.15A, 3V	C-25			
PSIF400-5	POS	550A, 500V, 0.15A, 3V	C-25			
PSIF400-6	POS	550A, 600V, 0.15A, 3V	C-25			
PSIF400-7	POS	550A, 700V, 0.15A, 3V	C-25			
PSIF400-8	POS	550A, 800V, 0.15A, 3V	C-25			
PSIF400-9	POS	550A, 900V, 0.15A, 3V	C-25			
PSIF400-10	POS	550A, 1kV, 0.15A, 3V	C-25			
PSIF400-12	POS	550A, 1.2kV, 0.15A, 3V	C-25			
PSIF400-14	POS	550A, 1.4kV, 0.15A, 3V	C-25			
PSIF400-16	POS	600A, 1.6kV, 0.15A, 3V	C-25			
PSIF400-18	POS	550A, 1.8kV, 0.15A, 3V	C-25			
PSIF500-1	POS	600A, 100V, 0.15A, 3V	C-25			
PSIF500-2	POS	600A, 200V, 0.15A, 3V	C-25			
PSIF500-3	POS	600A, 300V, 0.15A, 3V	C-25			
PSIF500-4	POS	600A, 400V, 0.15A, 3V	C-25			
PSIF500-5	POS	600A, 500V, 0.15A, 3V	C-25			
PSIF500-6	POS	600A, 600V, 0.15A, 3V	C-25			
PSIF500-7	POS	600A, 700V, 0.15A, 3V	C-25			
PSIF500-8	POS	600A, 800V, 0.15A, 3V	C-25			
PSIF500-9	POS	600A, 900V, 0.15A, 3V	C-25			
PSIF500-10	POS	600A, 1kV, 0.15A, 3V	C-25			
PSIF500-14	POS	600A, 1.4kV, 0.15A, 3V	C-25			
PSIF500-18	POS	600A, 1.8kV, 0.15A, 3V	C-25			
PSIF600-1	POS	650A, 100V, 0.15A, 3V	C-25			

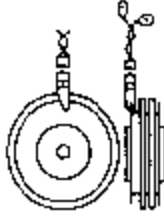
器件型号 Element type	厂名 Manufacturers	材料用途参数 Material Purpose Parameter	图号 Figure	国内外相似替换器件型号 Replace of similar type	备注 Notes	外形参考图 Reference shape
PSIF600-2	POS	650A, 200V, 0.15A, 3V	C-25			 图 C-25
PSIF600-3	POS	650A, 300V, 0.15A, 3V	C-25			
PSIF600-4	POS	650A, 400V, 0.15A, 3V	C-25			
PSIF600-5	POS	650A, 500V, 0.15A, 3V	C-25			
PSIF600-6	POS	650A, 600V, 0.15A, 3V	C-25			
PSIF600-7	POS	650A, 700V, 0.15A, 3V	C-25			
PSIF600-8	POS	650A, 800V, 0.15A, 3V	C-25			
PSIF600-9	POS	650A, 900V, 0.15A, 3V	C-25			
PSIF600-10	POS	650A, 1kV, 0.15A, 3V	C-25			
PSIG300-1	POS	490A, 100V, 0.15A, 3V	C-25			
PSIG300-2	POS	490A, 200V, 0.15A, 3V	C-25			
PSIG300-3	POS	490A, 300V, 0.15A, 3V	C-25			
PSIG300-4	POS	490A, 400V, 0.15A, 3V	C-25			
PSIG300-5	POS	490A, 500V, 0.15A, 3V	C-25			
PSIG300-6	POS	490A, 600V, 0.15A, 3V	C-25			
PSIG300-8	POS	490A, 800V, 0.15A, 3V	C-25			
PSIG300-9	POS	490A, 900V, 0.15A, 3V	C-25			
PSIG300-10	POS	490A, 1kV, 0.15A, 3V	C-25			
PSIG300-12	POS	490A, 1.2kV, 0.15A, 3V	C-25			
PSIG300-14	POS	490A, 1.4kV, 0.15A, 3V	C-25			
PSIG300-18	POS	490A, 1.6kV, 0.15A, 3V	C-25			
PSIG300-20	POS	490A, 2kV, 0.15A, 3V	C-25			
PSIG300-22	POS	490A, 2.2kV, 0.15A, 3V	C-25			
PSIG300-24	POS	490A, 2.4kV, 0.15A, 3V	C-25			
PSIG300-26	POS	490A, 2.6kV, 0.15A, 3V	C-25			
PSIG300-28	POS	490A, 2.8kV, 0.15A, 3V	C-25			
PSIG300-30	POS	490A, 3kV, 0.15A, 3V	C-25			

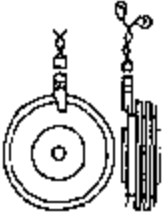

器件型号 Element type	厂名 Manufacturers	材料用途参数 Material Purpose Parameter	图号 Figure	国内外相似替换器件型号 Replace of similar type	备注 Notes	外形参考图 Reference shape
PSIG400-1	POS	600A, 100V, 0.15A, 3V	C-25			 <p>图 C-25</p>
PSIG400-2	POS	600A, 200V, 0.15A, 3V	C-25			
PSIG400-3	POS	600A, 300V, 0.15A, 3V	C-25			
PSIG400-4	POS	600A, 400V, 0.15A, 3V	C-25			
PSIG400-5	POS	600A, 500V, 0.15A, 3V	C-25			
PSIG400-6	POS	600A, 600V, 0.15A, 3V	C-25			
PSIG400-7	POS	600A, 700V, 0.15A, 3V	C-25			
PSIG400-8	POS	600A, 800V, 0.15A, 3V	C-25			
PSIG400-9	POS	600A, 900V, 0.15A, 3V	C-25			
PSIG400-10	POS	600A, 1kV, 0.15A, 3V	C-25			
PSIG400-14	POS	600A, 1.4kV, 0.15A, 3V	C-25			
PSIG400-16	POS	600A, 1.6kV, 0.15A, 3V	C-25			
PSIG400-18	POS	600A, 1.8kV, 0.15A, 3V	C-25			
PSIG400-20	POS	605A, 2kV, 0.15A, 3V	C-25			
PSIG400-22	POS	600A, 2.2kV, 0.15A, 3V	C-25			
PSIG400-24	POS	600A, 2.4kV, 0.15A, 3V	C-25			
PSIG400-26	POS	600A, 2.6kV, 0.15A, 3V	C-25			
PSIG500-1	POS	690A, 100V, 0.15A, 3V	C-25			
PSIG500-2	POS	690A, 200V, 0.15A, 3V	C-25			
PSIG500-3	POS	690A, 300V, 0.15A, 3V	C-25			
PSIG500-4	POS	690A, 400V, 0.15A, 3V	C-25			
PSIG500-5	POS	690A, 500V, 0.15A, 3V	C-25			
PSIG500-6	POS	690A, 600V, 0.15A, 3V	C-25			
PSIG500-7	POS	690A, 700V, 0.15A, 3V	C-25			
PSIG500-8	POS	690A, 800V, 0.15A, 3V	C-25			
PSIG500-9	POS	690A, 900V, 0.15A, 3V	C-25			
PSIG500-10	POS	690A, 1kV, 0.15A, 3V	C-25			
PSIG500-12	POS	690A, 1.2kV, 0.15A, 3V	C-25			

器件型号 Element type	厂名 Manufacturers	材料用途参数 Material Purpose Parameter	图号 Figure	国内外相似替换器件型号 Replace of similar type	备注 Notes	外形参考图 Reference shape
PSIG500-14	POS	690A, 1.4kV, 0.15A, 3V	C-25			 <p>图 C-25</p>
PSIG500-16	POS	690A, 1.6kV, 0.15A, 3V	C-25			
PSIG500-18	POS	690A, 1.8kV, 0.15A, 3V	C-25			
PSIG500-20	POS	690A, 2kV, 0.15A, 3V	C-25			
PSIG650-1	POS	785A, 100V, 0.15A, 3V	C-25			
PSIG650-2	POS	785A, 200V, 0.15A, 3V	C-25			
PSIG650-3	POS	785A, 300V, 0.15A, 3V	C-25			
PSIG650-4	POS	785A, 400V, 0.15A, 3V	C-25			
PSIG650-5	POS	785A, 500V, 0.15A, 3V	C-25			
PSIG650-6	POS	785A, 600V, 0.15A, 3V	C-25			
PSIG650-7	POS	785A, 700V, 0.15A, 3V	C-25			
PSIG650-8	POS	785A, 800V, 0.15A, 3V	C-25			
PSIG650-9	POS	785A, 900V, 0.15A, 3V	C-25			
PSIG650-10	POS	785A, 1kV, 0.15A, 3V	C-25			
PSIG650-12	POS	785A, 1.2kV, 0.15A, 3V	C-25			
PSIG650-14	POS	785A, 1.4kV, 0.15A, 3V	C-25			
PSIG650-16	POS	785A, 1.6kV, 0.15A, 3V	C-25			
PSIG850-1	POS	850A, 100V, 0.15A, 3V	C-25			
PSIG850-2	POS	850A, 200V, 0.15A, 3V	C-25			
PSIG850-3	POS	850A, 300V, 0.15A, 3V	C-25			
PSIG850-4	POS	850A, 400V, 0.15A, 3V	C-25			
PSIG850-5	POS	850A, 500V, 0.15A, 3V	C-25			
PSIG850-6	POS	850A, 600V, 0.15A, 3V	C-25			
PSIG850-7	POS	850A, 700V, 0.15A, 3V	C-25			
PSIG850-8	POS	850A, 800V, 0.15A, 3V	C-25			
PSIG850-9	POS	850A, 900V, 0.15A, 3V	C-25			
PSIG850-10	POS	850A, 1kV, 0.15A, 3V	C-25			

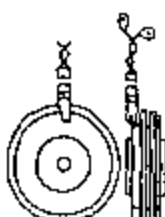

器件型号 Element type	厂名 Manufacturers	材料用途参数 Material Purpose Parameter	图号 Figure	国内外相似替换器件型号 Replace of similar type	备注 Notes	外形参考图 Reference shape
PSIG850-12	POS	850A, 1.2kV, 0.15A, 3V	C-25			 图 C-25
PSIG850-14	POS	850A, 1.4kV, 0.15A, 3V	C-25			
PSIG850-16	POS	850A, 1.6kV, 0.15A, 3V	C-25			
PSIG850-18	POS	850A, 1.8kV, 0.15A, 3V	C-25			
PSIG850-20	POS	850A, 2kV, 0.15A, 3V	C-25			
PSIG950-1	POS	950A, 100V, 0.15A, 3V	C-25			
PSIG950-2	POS	950A, 200V, 0.15A, 3V	C-25			
PSIG950-3	POS	950A, 300V, 0.15A, 3V	C-25			
PSIG950-4	POS	950A, 400V, 0.15A, 3V	C-25			
PSIG950-5	POS	950A, 500V, 0.15A, 3V	C-25			
PSIG950-6	POS	950A, 600V, 0.15A, 3V	C-25			
PSIG950-7	POS	950A, 700V, 0.15A, 3V	C-25			
PSIG950-8	POS	950A, 800V, 0.15A, 3V	C-25			
PSIG950-9	POS	950A, 900V, 0.15A, 3V	C-25			
PSIG950-10	POS	950A, 1kV, 0.15A, 3V	C-25			
PSIG950-12	POS	950A, 1.2kV, 0.15A, 3V	C-25			
PSIG950-16	POS	950A, 1.6kV, 0.15A, 3V	C-25			
PSIG950-18	POS	950A, 1.8kV, 0.15A, 3V	C-25			
PSIH800-1	POS	1kA, 100V, 0.3A, 3V	C-25			
PSIH800-2	POS	1kA, 200V, 0.3A, 3V	C-25			
PSIH800-3	POS	1kA, 300V, 0.3A, 3V	C-25			
PSIH800-4	POS	1kA, 400V, 0.3A, 3V	C-25			
PSIH800-5	POS	1kA, 500V, 0.3A, 3V	C-25			
PSIH800-6	POS	1kA, 600V, 0.3A, 3V	C-25			
PSIH800-7	POS	1kA, 700V, 0.3A, 3V	C-25			
PSIH800-8	POS	1kA, 800V, 0.3A, 3V	C-25			
PSIH800-9	POS	1kA, 900V, 0.3A, 3V	C-25			

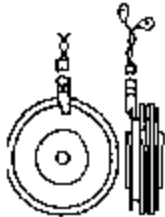
器件型号 Element type	厂名 Manufacturers	材料用途参数 Material Purpose Parameter	图号 Figure	国内外相似替换器件型号 Replace of similar type	备注 Notes	外形参考图 Reference shape
PSIH600-10	POS	1kA, 1kV, 0.3A, 3V	C-25			 <p>图 C-25</p>
PSIH600-12	POS	1kA, 1.2kV, 0.3A, 3V	C-25			
PSIH600-14	POS	1kA, 1.4kV, 0.3A, 3V	C-25			
PSIH600-16	POS	1kA, 1.6kV, 0.3A, 3V	C-25			
PSIH600-20	POS	1kA, 2kV, 0.3A, 3V	C-25			
PSIH600-22	POS	1kA, 2.2kV, 0.3A, 3V	C-25			
PSIH600-24	POS	1kA, 2.4kV, 0.3A, 3V	C-25			
PSIH600-26	POS	1kA, 2.6kV, 0.3A, 3V	C-25			
PSIH600-28	POS	1kA, 2.8kV, 0.3A, 3V	C-25			
PSIH600-30	POS	1kA, 3kV, 0.3A, 3V	C-25			
PSIH1000-1	POS	1.2kA, 100V, 0.3A, 3V	C-25			
PSIH1000-2	POS	1.2kA, 200V, 0.3A, 3V	C-25			
PSIH1000-3	POS	1.2kA, 300V, 0.3A, 3V	C-25			
PSIH1000-4	POS	1.2kA, 400V, 0.3A, 3V	C-25			
PSIH1000-5	POS	1.2kA, 500V, 0.3A, 3V	C-25			
PSIH1000-6	POS	1.2kA, 600V, 0.3A, 3V	C-25			
PSIH1000-7	POS	1.2kA, 700V, 0.3A, 3V	C-25			
PSIH1000-8	POS	1.2kA, 800V, 0.3A, 3V	C-25			
PSIH1000-9	POS	1.2kA, 900V, 0.3A, 3V	C-25			
PSIH1000 10	POS	1.2kA, 1kV, 0.3A, 3V	C-25			
PSIH1000-12	POS	1.2kA, 1.2kV, 0.3A, 3V	C-25			
PSIH1000-14	POS	1.2kA, 1.4kV, 0.3A, 3V	C-25			
PSIH1000-16	POS	1.2kA, 1.6kV, 0.3A, 3V	C-25			
PSIH1000-18	POS	1.2kA, 1.8kV, 0.3A, 3V	C-25			
PSIH1000-20	POS	1.2kA, 2kV, 0.3A, 3V	C-25			
PSIH1000-22	POS	1.2kA, 2.2kV, 0.3A, 3V	C-25			
PSIH1000-26	POS	1.2kA, 2.6kV, 0.3A, 3V	C-25			

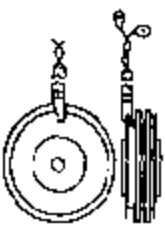

器件型号 Element type	厂名 Manufacturers	材料用途参数 Material Purpose Parameter	图号 Figure	国内外相似替换器件型号 Replace of similar type	备注 Notes	外形参考图 Reference shape
PSIH1200-1	POS	1.4kA, 100V, 0.3A, 3V	C-25			 <p>图 C-25</p>
PSIH1200-2	POS	1.4kA, 200V, 0.3A, 3V	C-25			
PSIH1200-3	POS	1.4kA, 300V, 0.3A, 3V	C-25			
PSIH1200-4	POS	1.4kA, 400V, 0.3A, 3V	C-25			
PSIH1200-5	POS	1.4kA, 500V, 0.3A, 3V	C-25			
PSIH1200-6	POS	1.4kA, 600V, 0.3A, 3V	C-25			
PSIH1200-7	POS	1.4kA, 700V, 0.3A, 3V	C-25			
PSIH1200-8	POS	1.4kA, 800V, 0.3A, 3V	C-25			
PSIH1200-9	POS	1.4kA, 900V, 0.3A, 3V	C-25			
PSIH1200-10	POS	1.4kA, 1kV, 0.3A, 3V	C-25			
PSIH1200-14	POS	1.4kA, 1.4kV, 0.3A, 3V	C-25			
PSIH1200-16	POS	1.4kA, 1.6kV, 0.3A, 3V	C-25			
PSIH1200-18	POS	1.4kA, 1.8kV, 0.3A, 3V	C-25			
PSIH1200-20	POS	1.4kA, 2kV, 0.3A, 3V	C-25			
PSIH1400-1	POS	1.7kA, 100V, 0.3A, 3V	C-25			
PSIH1400-2	POS	1.7kA, 200V, 0.3A, 3V	C-25			
PSIH1400-3	POS	1.7kA, 300V, 0.3A, 3V	C-25			
PSIH1400-4	POS	1.7kA, 400V, 0.3A, 3V	C-25			
PSIH1400-5	POS	1.7kA, 500V, 0.3A, 3V	C-25			
PSIH1400-6	POS	1.7kA, 600V, 0.3A, 3V	C-25			
PSIH1400-7	POS	1.7kA, 700V, 0.3A, 3V	C-25			
PSIH1400-8	POS	1.7kA, 800V, 0.3A, 3V	C-25			
PSIH1400-9	POS	1.7kA, 900V, 0.3A, 3V	C-25			
PSIH1400-10	POS	1.7kA, 1kV, 0.3A, 3V	C-25			
PSIH1400-12	POS	1.7kA, 1.2kV, 0.3A, 3V	C-25			
PSIH1400-14	POS	1.7kA, 1.4kV, 0.3A, 3V	C-25			
PSIH1400-16	POS	1.7kA, 1.6kV, 0.3A, 3V	C-25			
PSIH1400-18	POS	1.7kA, 1.8kV, 0.3A, 3V	C-25			

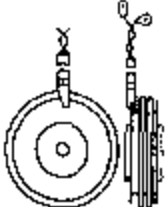
器件型号 Element type	厂名 Manufacturers	材料用途参数 Material Purpose Parameter	图号 Figure	国内外相似替换器件型号 Replace of similar type	备注 Notes	外形参考图 Reference shape
PSIH1600-1	POS	2kA, 100V, 0.3A, 3V	C-25			 图 C-25
PSIH1600-2	POS	2kA, 200V, 0.3A, 3V	C-25			
PSIH1600-3	POS	2kA, 300V, 0.3A, 3V	C-25			
PSIH1600-4	POS	2kA, 400V, 0.3A, 3V	C-25			
PSIH1600-5	POS	2kA, 500V, 0.3A, 3V	C-25			
PSIH1600-6	POS	2kA, 600V, 0.3A, 3V	C-25			
PSIH1600-7	POS	2kA, 700V, 0.3A, 3V	C-25			
PSIH1600-8	POS	2kA, 800V, 0.3A, 3V	C-25			
PSIH1600-9	POS	2kA, 900V, 0.3A, 3V	C-25			
PSIH1600-10	POS	2kA, 1kV, 0.3A, 3V	C-25			
PSIH1600-12	POS	2kA, 1.2kV, 0.3A, 3V	C-25			
PSIH1600-14	POS	2kA, 1.4kV, 0.3A, 3V	C-25			
PSIH1800-1	POS	2kA, 100V, 0.3A, 3V	C-25			
PSIH1800-2	POS	2kA, 200V, 0.3A, 3V	C-25			
PSIH1800-3	POS	2kA, 300V, 0.3A, 3V	C-25			
PSIH1800-4	POS	2kA, 400V, 0.3A, 3V	C-25			
PSIH1800-5	POS	2kA, 500V, 0.3A, 3V	C-25			
PSIH1800-6	POS	2kA, 600V, 0.3A, 3V	C-25			
PSIJ1600-1	POS	1.82kA, 100V, 0.3A, 3V	C-25			
PSIJ1600-2	POS	1.82kA, 200V, 0.3A, 3V	C-25			
PSIJ1600-3	POS	1.82kA, 300V, 0.3A, 3V	C-25			
PSIJ1600-4	POS	1.82kA, 400V, 0.3A, 3V	C-25			
PSIJ1600-6	POS	1.82kA, 600V, 0.3A, 3V	C-25			
PSIJ1600-7	POS	1.82kA, 700V, 0.3A, 3V	C-25			
PSIJ1600-8	POS	1.82kA, 800V, 0.3A, 3V	C-25			
PSIJ1600-9	POS	1.82kA, 900V, 0.3A, 3V	C-25			
PSIJ1600-10	POS	1.82kA, 1kV, 0.3A, 3V	C-25			

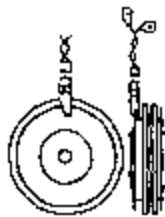

器件型号 Element type	厂名 Manufacturers	材料用途参数 Material Purpose Parameter	图号 Figure	国内外相似替换器件型号 Replace of similar type	备注 Notes	外形参考图 Reference shape
PSIJ1600-11	POS	1.82kA, 1.1kV, 0.3A, 3V	C-25			 图 C-25
PSIJ1600-12	POS	1.82kA, 1.2kV, 0.3A, 3V	C-25			
PSIJ1600-13	POS	1.82kA, 1.3kV, 0.3A, 3V	C-25			
PSIJ1600-14	POS	1.82kA, 1.4kV, 0.3A, 3V	C-25			
PSIJ1600-15	POS	1.82kA, 1.5kV, 0.3A, 3V	C-25			
PSIJ1600-16	POS	1.82kA, 1.6kV, 0.3A, 3V	C-25			
PSIJ1600-17	POS	1.82kA, 1.7kV, 0.3A, 3V	C-25			
PSIJ1600-18	POS	1.82kA, 1.8kV, 0.3A, 3V	C-25			
PSIJ1600-19	POS	1.82kA, 1.9kV, 0.3A, 3V	C-25			
PSIJ1600-20	POS	1.82kA, 2kV, 0.3A, 3V	C-25			
PSIJ1600-21	POS	1.82kA, 2.1kV, 0.3A, 3V	C-25			
PSIJ1600-22	POS	1.82kA, 2.2kV, 0.3A, 3V	C-25			
PSIJ1600-23	POS	1.82kA, 2.3kV, 0.3A, 3V	C-25			
PSIJ1600-24	POS	1.82kA, 2.4kV, 0.3A, 3V	C-25			
PSIJ1600-25	POS	1.82kA, 2.5kV, 0.3A, 3V	C-25			
PSIJ1600-26	POS	1.82kA, 2.6kV, 0.3A, 3V	C-25			
PSIJ1600-27	POS	1.82kA, 2.7kV, 0.3A, 3V	C-25			
PSIJ1600-28	POS	1.82kA, 2.8kV, 0.3A, 3V	C-25			
PSIJ1600-30	POS	1.82kA, 3kV, 0.3A, 3V	C-25			
PSIJ1600-31	POS	1.82kA, 3.1kV, 0.3A, 3V	C-25			
PSIJ1600-32	POS	1.82kA, 3.2kV, 0.3A, 3V	C-25			
PSIJ1600-33	POS	1.82kA, 3.3kV, 0.3A, 3V	C-25			
PSIJ1600-34	POS	1.82kA, 3.4kV, 0.3A, 3V	C-25			
PSIJ1600-35	POS	1.82kA, 3.5kV, 0.3A, 3V	C-25			
PSIJ1900-1	POS	2.12kA, 100V, 0.3A, 3V	C-25			
PSIJ1900-2	POS	2.12kA, 200V, 0.3A, 3V	C-25			
PSIJ1900-3	POS	2.12kA, 300V, 0.3A, 3V	C-25			
PSIJ1900-4	POS	2.12kA, 400V, 0.3A, 3V	C-25			

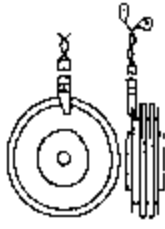
器件型号 Element type	厂名 Manufacturers	材料用途参数 Material Purpose Parameter	图号 Figure	国内外相似替换器件型号 Replace of similar type	备注 Notes	外形参考图 Reference shape
PSIJ1900-5	POS	2.12kA, 500V, 0.3A, 3V	C-25			 <p>图 C 25</p>
PSIJ1900-6	POS	2.12kA, 600V, 0.3A, 3V	C-25			
PSIJ1900-7	POS	2.12kA, 700V, 0.3A, 3V	C-25			
PSIJ1900-8	POS	2.12kA, 800V, 0.3A, 3V	C-25			
PSIJ1900-9	POS	2.12kA, 900V, 0.3A, 3V	C-25			
PSIJ1900-10	POS	2.12kA, 1kV, 0.3A, 3V	C-25			
PSIJ1900-12	POS	2.12kA, 1.2kV, 0.3A, 3V	C-25			
PSIJ1900-14	POS	2.12kA, 1.4kV, 0.3A, 3V	C-25			
PSIJ1900-16	POS	2.12kA, 1.6kV, 0.3A, 3V	C-25			
PSIJ1900-18	POS	2.12kA, 1.8kV, 0.3A, 3V	C-25			
PSIJ1900-20	POS	2.12kA, 2kV, 0.3A, 3V	C-25			
PSIJ1900-22	POS	2.12kA, 2.2kV, 0.3A, 3V	C-25			
PSIJ1900-24	POS	2.12kA, 2.4kV, 0.3A, 3V	C-25			
PSIJ1900-26	POS	2.12kA, 2.6kV, 0.3A, 3V	C-25			
PSIJ1900-28	POS	2.12kA, 2.8kV, 0.3A, 3V	C-25			
PSIJ1900-30	POS	2.12kA, 3kV, 0.3A, 3V	C-25			
PSIJ2200-1	POS	2.42kA, 100V, 0.3A, 3V	C-25			
PSIJ2200-2	POS	2.42kA, 200V, 0.3A, 3V	C-25			
PSIJ2200-3	POS	2.42kA, 300V, 0.3A, 3V	C-25			
PSIJ2200-4	POS	2.42kA, 400V, 0.3A, 3V	C-25			
PSIJ2200-5	POS	2.42kA, 500V, 0.3A, 3V	C-25			
PSIJ2200-6	POS	2.42kA, 600V, 0.3A, 3V	C-25			
PSIJ2200-7	POS	2.42kA, 700V, 0.3A, 3V	C-25			
PSIJ2200-8	POS	2.42kA, 800V, 0.3A, 3V	C-25			
PSIJ2200-9	POS	2.42kA, 900V, 0.3A, 3V	C-25			
PSIJ2200-10	POS	2.42kA, 1kV, 0.3A, 3V	C-25			
PSIJ2200-14	POS	2.42kA, 1.4kV, 0.3A, 3V	C-25			
PSIJ2200-16	POS	2.42kA, 1.6kV, 0.3A, 3V	C-25			



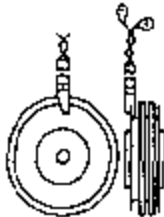

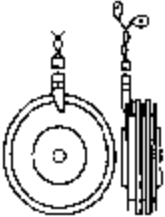
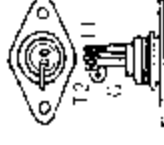

器件型号 Element type	厂名 Manufacturers	材料用途参数 Material Purpose Parameter	图号 Figure	国内外相似替换器件型号 Replace of similar type	备注 Notes	外形参考图 Reference shape
PSIJ2200-18	POS	2.42kA, 1.8kV, 0.3A, 3V	C-25			 图 C-25
PSIJ2200-20	POS	2.42kA, 2kV, 0.3A, 3V	C-25			
PSIJ2200-24	POS	2.42kA, 2.4kV, 0.3A, 3V	C-25			
PSIJ2200-26	POS	2.42kA, 2.6kV, 0.3A, 3V	C-25			
PSIJ2600-1	POS	2.87kA, 100V, 0.3A, 3V	C-25			
PSIJ2600-2	POS	2.87kA, 200V, 0.3A, 3V	C-25			
PSIJ2600-3	POS	2.87kA, 300V, 0.3A, 3V	C-25			
PSIJ2600-4	POS	2.87kA, 400V, 0.3A, 3V	C-25			
PSIJ2600-5	POS	2.87kA, 500V, 0.3A, 3V	C-25			
PSIJ2600-6	POS	2.87kA, 600V, 0.3A, 3V	C-25			
PSIJ2600-7	POS	2.87kA, 700V, 0.3A, 3V	C-25			
PSIJ2600-8	POS	2.87kA, 800V, 0.3A, 3V	C-25			
PSIJ2600-9	POS	2.87kA, 900V, 0.3A, 3V	C-25			
PSIJ2600-10	POS	2.87kA, 1kV, 0.3A, 3V	C-25			
PSIJ2600-12	POS	2.87kA, 1.2kV, 0.3A, 3V	C-25			
PSIJ2600-14	POS	2.87kA, 1.4kV, 0.3A, 3V	C-25			
PSIJ2600-16	POS	2.87kA, 1.6kV, 0.3A, 3V	C-25			
PSIJ2600-18	POS	2.87kA, 1.8kV, 0.3A, 3V	C-25			
PSIJ2600-20	POS	2.87kA, 2kV, 0.3A, 3V	C-25			
PSIJ3000-1	POS	3.3kA, 100V, 0.3A, 3V	C-25			
PSIJ3000-2	POS	3.3kA, 200V, 0.3A, 3V	C-25			
PSIJ3000-3	POS	3.3kA, 300V, 0.3A, 3V	C-25			
PSIJ3000-4	POS	3.3kA, 400V, 0.3A, 3V	C-25			
PSIJ3000-5	POS	3.3kA, 500V, 0.3A, 3V	C-25			
PSIJ3000-6	POS	3.3kA, 600V, 0.3A, 3V	C-25			
PSIJ3000-7	POS	3.3kA, 700V, 0.3A, 3V	C-25			
PSIJ3000-8	POS	3.3kA, 800V, 0.3A, 3V	C-25			

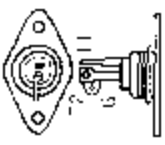
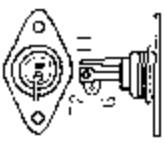
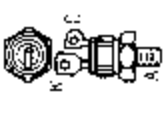
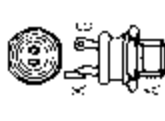
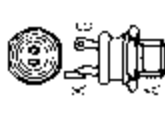
器件型号 Element type	厂名 Manufacturers	材料用途参数 Material Purpose Parameter	图号 Figure	国内外相似替换器型号 Replace of similar type	备注 Notes	外形参考图 Reference shape
PSIJ3000-9	POS	3.3kA, 900V, 0.3A, 3V	C-25			 图 C-25
PSIJ3000-10	POS	3.3kA, 1kV, 0.3A, 3V	C-25			
PSIJ3000-12	POS	3.3kA, 1.2kV, 0.3A, 3V	C-25			
PSIJ3000-14	POS	3.3kA, 1.4kV, 0.3A, 3V	C-25			
PSIJ3000-16	POS	3.3kA, 1.6kV, 0.3A, 3V	C-25			
PSIJ3000-18	POS	3.3kA, 1.8kV, 0.3A, 3V	C-25			
PSIJ3400-1	POS	3.77kA, 100V, 0.3A, 3V	C-25			
PSIJ3400-2	POS	3.77kA, 200V, 0.3A, 3V	C-25			
PSIJ3400-3	POS	3.77kA, 300V, 0.3A, 3V	C-25			
PSIJ3400-4	POS	3.77kA, 400V, 0.3A, 3V	C-25			
PSIJ3400-5	POS	3.77kA, 500V, 0.3A, 3V	C-25			
PSIJ3400-6	POS	3.77kA, 600V, 0.3A, 3V	C-25			
PSIJ3400-7	POS	3.77kA, 700V, 0.3A, 3V	C-25			
PSIJ3400-8	POS	3.77kA, 800V, 0.3A, 3V	C-25			
PSIJ3400-9	POS	3.77kA, 900V, 0.3A, 3V	C-25			
PSIJ3400-10	POS	3.77kA, 1kV, 0.3A, 3V	C-25			
PSIJ3400-12	POS	3.77kA, 1.2kV, 0.3A, 3V	C-25			
PSIJ3400-14	POS	3.77kA, 1.4kV, 0.3A, 3V	C-25			
PT010	HUT	10A, 50V, 0.05A, 2.5V		ECG5688, Q2010		 图 D-29
PT015	HUT	15A, 50V, 0.05A, 2.5V		ECG5688, S2015G		
PT030	HUT	30A, 50V, 0.1A, 2.5V	D-29	ECG5688		
PT040	HUT	40A, 50V, 0.1A, 2.5V	D-29	ECG5688		
PT08	HUT	8A, 50V, 0.05A, 2.5V		Q2008, 2N5567		
PT16	HUT	8A, 100V, 0.05A, 2.5V		Q2008, 2N5567		
PT28	HUT	8A, 200V, 0.05A, 2.5V		Q2008, 2N5568		
PT38	HUT	8A, 300V, 0.05A, 2.5V		Q4008, 2N5568		

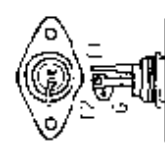

器件型号 Element type	厂名 Manufacturers	材料用途参数 Material Purpose Parameter	图号 Figure	国内外相似替换器件型号 Replace of similar type	备注 Notes	外形参考图 Reference shape
PT48	HUT	8A, 400V, 0.05A, 2.5V		Q4008, 2N5568		 图 D-29
PT58	HUT	8A, 500V, 0.05A, 2.5V		Q5008, T4101M		
PT68	HUT	8A, 600V, 0.05A, 2.5V		Q6008, T4101M		
PT110	HUT	10A, 100V, 0.05A, 2.5V		ECG5688, Q2010, 2N5567		 图 D-29
PT115	HUT	15A, 100V, 0.05A, 2.5V		ECG5688, Q2015G, 2N5571		
PT125	HUT	25A, 100V, 0.1A, 2.5V		ECG5688, Q2025G6, T6401B		
PT130	HUT	30A, 100V, 0.1A, 2.5V	D-29	ECG5688		
PT140	HUT	40A, 100V, 0.1A, 2.5V	D-29	ECG5688		
PT210	HUT	10A, 200V, 0.05A, 2.5V		ECG5688, Q2010, 2N5567		 图 F-47
PT215	HUT	15A, 200V, 0.05A, 2.5V		ECG5688, Q2015G, 2N5571		
PT225	HUT	25A, 200V, 0.1A, 2.5V		ECG5688, Q2025G6, T6401B		
PT230	HUT	30A, 200V, 0.1A, 2.5V	D-29	ECG5688		
PT240	HUT	40A, 200V, 0.1A, 2.5V	D-29	ECG5688		
PT260	HUT	60A, 200V, 0.1A, 3V	F-47	ECG5688		
PT310	HUT	10A, 300V, 0.05A, 2.5V		ECG5689, Q4010, 2N5568		 图 F-21
PT315	HUT	15A, 300V, 0.05A, 2.5V		ECG5689, Q4015G, 2N5572		
PT325	HUT	25A, 300V, 0.1A, 2.5V		ECG5689, Q4025G6, T6401D		
PT330	HUT	25A, 300V, 0.1A, 2.5V	D-29	ECG5689		
PT340	HUT	40A, 300V, 0.1A, 2.5V	D-29	ECG5689		
PT360	HUT	60A, 300V, 0.1A, 3V	F-21	ECG5689		
PT410	HUT	10A, 400V, 0.05A, 2.5V		ECG5689, Q4010, 2N5568		 图 F-21
PT415	HUT	15A, 400V, 0.05A, 2.5V		ECG5689, Q4015G, 2N5572		
PT425	HUT	25A, 400V, 0.1A, 2.5V		ECG5689, Q4025G6, T6401D		
PT430	HUT	30A, 400V, 0.1A, 2.5V	D-29	ECG5689		
PT440	HUT	40A, 400V, 0.1A, 2.5V	D-29	ECG5689		

器件型号 Element type	厂名 Manufacturers	材料用途参数 Material Purpose Parameter	图号 Figure	国内外相似替换器件型号 Replace of similar type	备注 Notes	外形参考图 Reference shape
PT460	HUT	60A, 400V, 0.1A, 3V	F-47			 图 F-47
PT510	HUT	10A, 500V, 0.05A, 2.5V		ECG116, Q5010, T4101M		 图 D-29
PT515	HUT	15A, 500V, 0.05A, 2.5V		ECG5690, Q5015G, T4100M		
PT525	HUT	25A, 500V, 0.1A, 2.5V		ECG116, Q5025G6, T6401M		
PT530	HUT	30A, 500V, 0.1A, 2.5V	D-29	ECG116		
PT540	HUT	40A, 500V, 0.1A, 2.5V	D-29	ECG116		
PT560	HUT	50A, 500V, 0.1A, 3V	F-21	ECG116		
PT610	HUT	10A, 600V, 0.05A, 2.5V		ECG5690, Q6010, T4101M		
PT615	HUT	15A, 600V, 0.05A, 2.5V		ECG5690, Q6015G, T4100M		
PT630	HUT	30A, 600V, 0.1A, 2.5V	D-29	ECG5690		 图 F-21
PT640	HUT	40A, 600V, 0.1A, 2.5V	D-29	ECG5690		 图 F-50
PT660	HUT	50A, 600V, 0.1A, 3V	F-47			 图 B-91
PT860	HUT	60A, 800V, 0.1A, 3V	F-47			
PT1060	HUT	60A, 1kV, 0.1A, 3V	F-47			
PTC658	MAL	15A, 600V, 0.02A, 1.5V	F-50			
PTC660	MAL	35A, 600V, 0.025A, 2V	F-50			
PTC665	MAL	15A, 600V, 0.05A, 2.5V	B-91			
PTC666	MAL	25A, 600V, 0.05A, 2.5V	F-50			
PTN1, N2	TSA	2A, 40V, 20 μA, 500V	B-36			
PWB60A30		MOD, 3 x SCR, 60A, 300V				
PWB60A40		MOD, 3 x SCR, 60A, 400V				
PWB80A30		MOD, 3 x SCR, 80A, 300V				



器件型号 Element type	厂名 Manufacturers	材料用途参数 Material Purpose Parameter	图号 Figure	国内外相似替换器件型号 Replace of similar type	备注 Notes	外形参考图 Reference shape
PWB80A40		MOD, 3 x SCR, 80A, 400V				
PWB100A30 PWB100A40		MOD, 3 x SCR, 100A, 300V MOD, 3 x SCR, 100A, 400V				
PWB130A30 PWB130A40		MOD, 3 x SCR, 130A, 300V MOD, 3 x SCR, 130A, 400V				
PWB200A30 PWB200A40		MOD, 3 x SCR, 200A, 300V MOD, 3 x SCR, 200A, 400V				

P类外形参考图索引



图 A-10



图 A-11



图 B-65



图 B-91

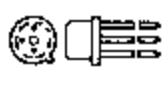

图 B-35

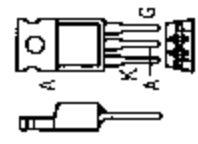

图 B-36



图 B-44

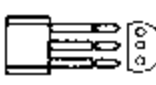

图 B-55

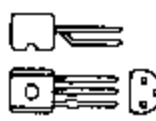

图 B-62

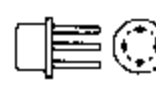

图 C-2



图 C-25



图 C-50

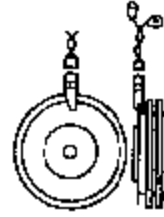

图 D-29

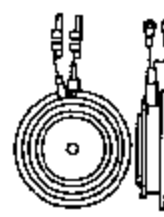

图 E-28

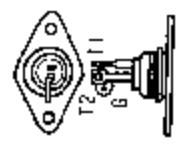

图 E-30

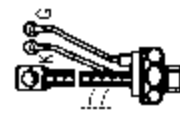

图 E-9

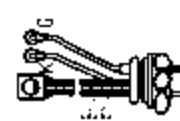

图 F-8

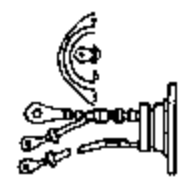

图 F-21





图 F-47

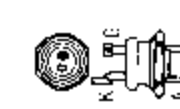

图 F-48



图 F-50

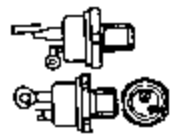

图 F-63



图 F-71

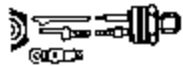

图 F-76



图 F-91



图 G-1

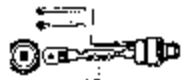

图 H-1



图 H-3

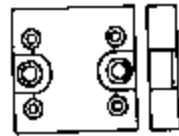

图 H-15



图 H-16

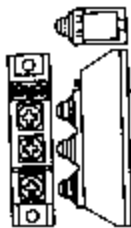

图 H-26

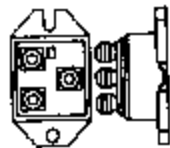

图 H-27



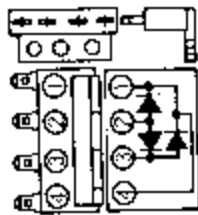



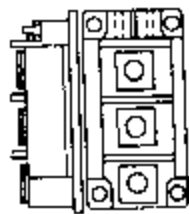

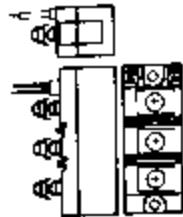
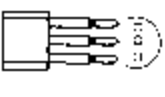
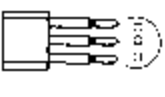
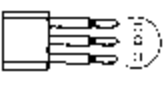
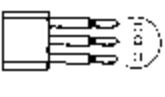

图 H-29

器件型号 Element type	厂名 Manufacturers	材料用途参数 Material Purpose Parameter	图号 Figure	国内外相似替换器件型号 Replace of similar type	备注 Notes	外形参考图 Reference shape
Q201E3	TCE	1A, 200V, 0.01A, 2V	B-36			
Q201E4	TCE	1A, 200V, 0.025A, 2.5V	B-36			
Q401E3	TCE	1A, 400V, 0.025A, 0.01V	B-36			
Q401E4	TCE	1A, 400V, 0.025A, 2.5V	B-36			
Q2001L3	TCE	SCR-D 1.6A, 200V, 0.01A, 2.5V	B-91	ECG5638, T2322B		
Q2001L4	TCE	SCR-D 1.6A, 200V, 0.025A, 2.5V	B-91	ECG5638, T2322B		
Q2001LT	TCE	1.6A, 200V	B-91	ECG5646		
Q2001M3	SCR-D	2.5A, 200V		12302PB		
Q2001M4	SCR-D	3A, 200V		SC136B		
Q2003L3	TCE	SCR-D 3A, 200V, 0.01A, 2.5V		ECG5638, 2N6071A		
Q2003L4	TCE	SCR-D 3A, 200V, 0.025A, 2.5V		ECG5638, 2N6071A		
Q2003LT	TCE	3A, 200V	B-91	ECG5646		
Q2003M3	TCE	SCR-D 3A, 200V, 0.01A, 2V		12302PB		
Q2003M4	TCE	SCR-D 3A, 200V, 0.025A, 2.5V		SC136B		
Q2003P3, P4	SCR-D	3A, 200V		12302PB, SC136B		
Q2004F31	TCE	SCR-D 4A, 200V, 0.01A, 2V		ECG5629, T2302PB		
Q2004F41	TCE	SCR-D 4A, 200V, 0.025A, 2V		ECG5629, SC136B		
Q2004FT1	TCE	4A, 200V	B-89			
Q2004L3	TCE	SCR-D 4A, 200V, 0.01A, 2V		ECG5638, 2N6071A		
Q2004L4	TCE	SCR-D 4A, 200V, 0.025A, 2.5V		ECG5645, 2N6071A		
Q2004LT	TCE	4A, 200V	B-91	ECG5646		
Q2006	TCE	6A, 200V, 0.05A, 2.5V	B-51			
Q2006A	TCE	6A, 200V, 0.05A, 2.5V	D-9	ECG5649		
Q2006AT	TCE	6A, 200V	D-9			

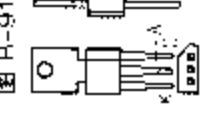
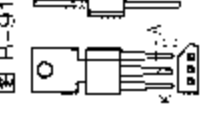
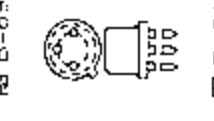
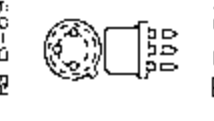
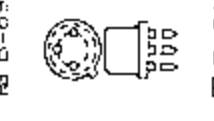
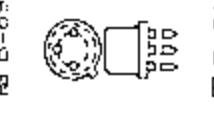
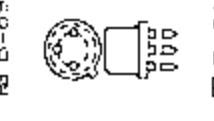
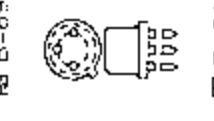
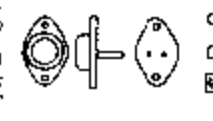
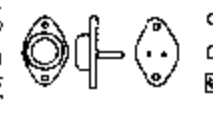
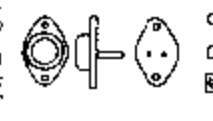
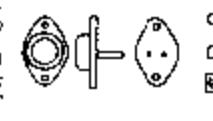
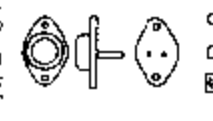

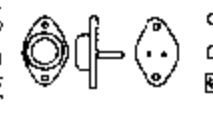







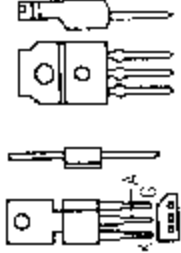
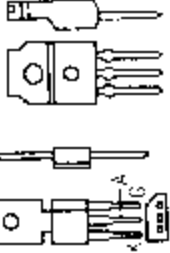
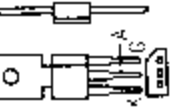
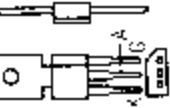
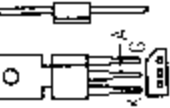
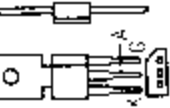
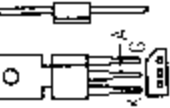
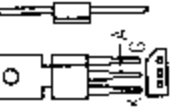
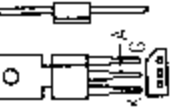
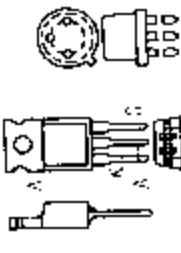
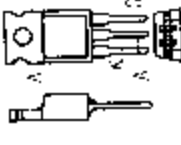
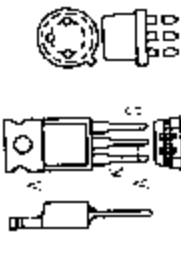
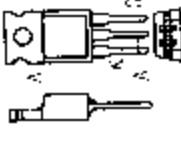
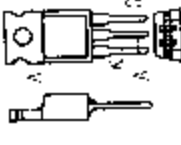
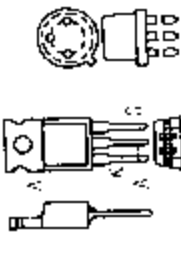
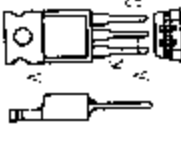
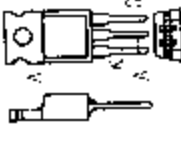
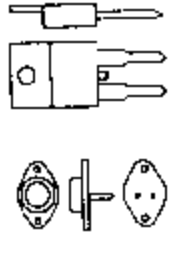
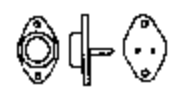
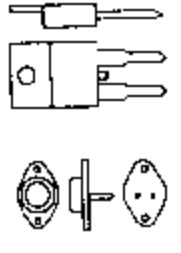
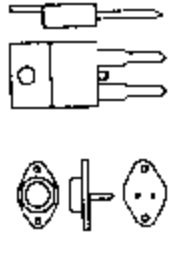
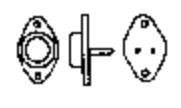
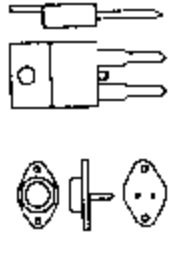
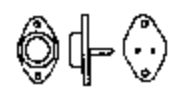
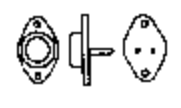
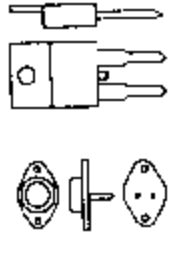

器件型号 Element type	厂名 Manufacturers	材料用途参数 Material Purpose Parameter	图号 Figure	国内外相似替换器件型号 Replace of similar type	备注 Notes	外形参考图 Reference shape
Q2006F31	TCE	SCR-D 3A, 200V	B-89	SC136B		
Q2006F41	TCE	SCR-D 6A, 200V, 0.025A, 2.5V	B-89	SC136B		
Q2006FT1	TCE	SCR-D 6A, 200V	B-14	12500B		
Q2006L4	TCE	SCR-D 6A, 200V	B-91	SC141B		
Q2006L5	TCE	SCR-D 6A, 200V, 0.05A, 2.5V	B-89	ECG5646		
Q2006LT	TCE	SCR-D 6A, 200V	B-14	T2500B		
Q2006R4	TCE	SCR-D 6A, 200V, 0.025A, 2.5V	B-14	T2500B		
Q2006T	TCE	SCR-D 6A, 200V	B-51			
Q2008	TCE	8A, 200V, 0.05A, 2.5V	B-51			
Q2008A, AT	TCE	8A, 200V, 0.05A, 2.5V	D-9	ECG5649		
Q2008F41	TCE	SCR-D 8A, 200V, 0.025A, 2.5V	B-9	T2800B		
Q2008FT1	TCE	SCR-D 8A, 200V	B-89	ECG5645, T2800B		
Q2008L4, L4A	TCE	SCR-D 8A, 200V, 0.025A, 2.5V	B-9	MAC218-4		
Q2008L5	TCE	SCR-D 8A, 200V, 0.05A, 2.5V	B-9	ECG5646		
Q2008LT	TCE	SCR-D 8A, 200V	B-91			
Q2008LTA	TCE	SCR-D 8A, 200V, 0.025A, 2.5V	B-89			
Q2008R4	TCE	SCR-D 8A, 200V, 0.025A, 3V	B-9	T2800B		
Q201E3		SCR-D 200V		MAC97-4		
Q201E4		SCR-D 0.6A, 200V		MAC97-4		
Q2010	TCE	10A, 200V, 0.05A, 2.5V	B-51			
Q2010A, AT	TCE	10A, 200V, 0.05A, 2.5V	D-9	ECG5649		
Q2010F41	TCE	SCR-D 10A, 200V, 0.04A, 2.5V	B-9	SC146B		
Q2010FT1	TCE	SCR-D 10A, 200V, 0.04A, 2.5V	B-89	ECG5645, SC146B, TAG480-200, 2N6346A		
Q2010L4	TCE	SCR-D 10A, 200V, 0.025A, 2.5V	B-9	SC146B		
Q2010L5	TCE	SCR-D 10A, 200V, 0.05A, 2.5V	B-9	SC146B		
Q2010LT	TCE	SCR-D 10A, 200V	B-91			

图 B-89 图 B-14

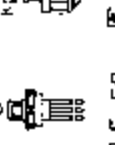







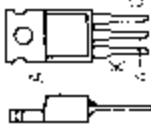
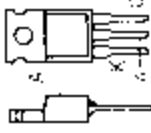
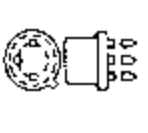
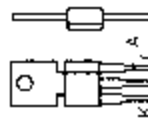
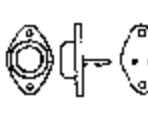
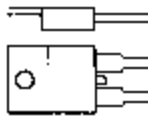

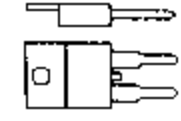
图 B-91 图 B-51

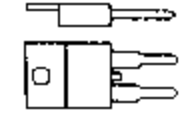
图 D-9 图 B-9

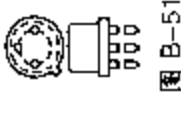
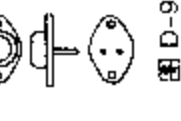
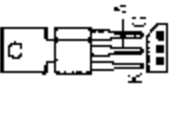
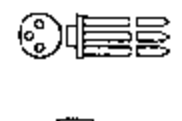
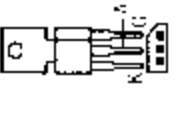
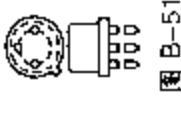
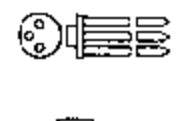
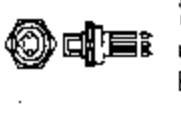
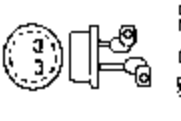
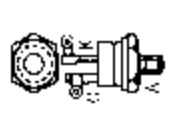
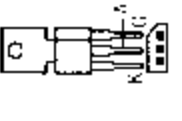
器件型号 Element type	厂名 Manufacturers	材料用途参数 Material Purpose Parameter	图号 Figure	国内外相似替换器件型号 Replace of similar type	备注 Notes	外形参考图 Reference shape
Q2010R4	TCE	10A, 200V, 0.025A, 3V				 图 B-51
Q2010T	TCE	10A, 200V	B-51			
Q2012L5	TCE	SCR-D 12A, 200V, 0.05A, 2.5V	B-91	2N6346A		 图 B-91
Q2012R5	TCE	SCR-D 12A, 200V, 0.05A, 2.5V	B-91	2N6346A		
Q2015	TCE	15A, 200V, 0.05A, 2.5V	B-51			 图 D-9
Q2015A	TCE	15A, 200V, 0.05A, 2.5V	D-9	ECG5649		
Q2015B	TCE	15A, 200V, 0.05A, 2.5V	F-58			 图 F-58
Q2015G, H	TCE	SCR-D 15A, 200V	C-85	SC250B, SC251B		
Q2015L5, LT	TCE	SCR-D 15A, 200V, 0.05A, 2.5V	B-91	ECG56004, SK3658, SK56004		 图 B-91
Q2015R5	TCE	SCR-D 15A, 200V, 0.05A, 2.5V	B-9	MAC15A4		
Q2025	TCE	SCR-D 25A, 200V, 0.05A, 2.5V	B-73	SC261B		 图 B-73
Q2025C	TCE	25A, 200V, 0.05A, 2.5V	D-9	ECG5679		
Q2025D	TCE	SCR-D 25A, 200V, 0.05A, 2.5V	F-50	ECG56022, SC260B3		 图 F-50
Q2025G	TCE	SCR-D 25A, 200V, 0.05A, 2.5V	B-73	ECG5688, MAC37-4, SC261B		
Q2025H	TCE	SCR-D 25A, 200V, 0.05A, 2.5V	F-50	ECG5693, MAC38-4, SC260B, SK3652, SK5693		 图 F-50
Q2025L5	TCE	25A, 200V, 0.05A, 2.5V	B-91	ECG5679, MAC525-4		
Q2025P	TCE	SCR-D 25A, 200V, 0.05A, 2.5V	G-18	MAC223-4		 图 G-18
Q2025R5	TCE	SCR-D 25A, 200V, 0.05A, 2.5V	B-91			
Q2025V6	TCE	25A, 200V, 0.08A, 2.5V	F-58			 图 F-58
Q2025Y6	TCE	25A, 200V, 0.08A, 2.5V	B-66			
Q2025Z6	TCE	25A, 200V, 0.08A, 2.5V	D-39			
Q2040	TCE	SCR-D 40A, 200V, 0.1A, 2.5V	B-73	T6401B		 图 B-73
Q2040C	TCE	40A, 200V, 0.1A, 2.5V	D-9	ECG5679		
Q2040D	TCE	SCR-D 40A, 200V, 0.1A, 2.5V	F-50	ECG56022, MAC40688, T6420B		 图 F-50
Q2040P	TCE	SCR-D 40A, 200V, 0.1A, 2.5V	G-18	MAC50 4		



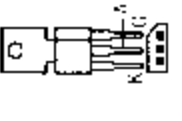





















器件型号 Element type	厂名 Manufacturers	材料用途参数 Material Purpose Parameter	图号 Figure	国内外相似替换器件型号 Replace of similar type	备注 Notes	外形参考图 Reference shape
Q4001L3	TCE	SCR-D 1.6A, 400V, 0.01A, 2.5V	B-91	ECG5638, T2327D		
Q4001L4, LT	TCE	SCR-D 1.6A, 400V, 0.025A, 2.5V	B-91	ECG5638, ECG5646, T2322D		
Q4001M3, M4		SCR-D 4A, 200V		SC136D, T2302PD		
Q4003L3	TCE	SCR-D 3A, 400V, 0.01A, 2.5V	B-91	ECG5638, 2N6073A		
Q4003L4, LT	TCE	SCR-D 3A, 400V, 0.025A, 2.5V	B-91	ECG5638, 2N6073A		
Q4003M3	TCE	SCR-D 3A, 400V, 0.01A, 2V	B-51	T2302PD		
Q4003M4	TCE	SCR-D 3A, 400V, 0.025A, 2.5V	B-51	SC136D		
Q4003P3, P4		SCR-D 3A, 400V		SC136D, T2302PD		
Q4004F31	TCE	SCR-D 4A, 400V, 0.01A, 2V	B-89	ECG5629, T2302PD		
Q4004F41, FT1	TCE	SCR-D 4A, 400V, 0.025A, 2V	B-89	ECG5629, SC136D		
Q4004L3	TCE	SCR-D 4A, 400V, 0.01A, 2V	B-89	ECG5638, 2N6073A		
Q4004L4, LT	TCE	SCR-D 4A, 400V, 0.025A, 2.5V	B-91	ECG5645, ECG5646, 2N6073A		
Q4006	TCE	6A, 400V, 0.05A, 2.5V	B-51			
Q4006A, AT	TCE	6A, 400V, 0.05A, 2.5V	D-9	FCG5649		
Q4006F41, FT1	TCE	SCR-D 6A, 400V, 0.025A, 2.5V	B-89	SC136D		
Q4006L4		SCR-D 6A, 400V		T2500D		
Q4006L5, LT	TCE	SCR-D 6A, 400V, 0.05A, 2.5V	B-91	ECG5646, SC141D		
Q4006R4	TCE	SCR-D 6A, 400V, 0.025A, 3V	B-9	T2500D		
Q4006T	TCE	6A, 400V	B-51			
Q4008	TCE	8A, 400V, 0.05A, 2.5V	B-51			
Q4008A, AT	TCE	8A, 400V, 0.05A, 2.5V	D-9	ECG5649		
Q4008F41	TCE	SCR-D 8A, 400V, 0.025A, 2.5V	B-9	T2800D		
Q4008FT1	TCE	8A, 400V	B-89			
Q4008L4A	TCE	SCR-D 8A, 400V, 0.025A, 2.5V	B-9	FCG5645, T2800D		
Q4008L5	TCE	SCR-D 8A, 400V, 0.05A, 2.5V	B-91	MAC218-6		











器件型号 Element type	厂名 Manufacturers	材料用途参数 Material Purpose Paramotor	图号 Figure	国内外相似替换器件型号 Replace of similar type	备注 Notes	外形参考图 Reference shape
Q4008R4	TCE	SCR-D 8A, 400V	B-9	T2800D		
Q4008LT	TCE	8A, 400V	B-91	ECG5646		
Q4008LTA	TCE	8A, 400V	B-91			
Q400E3	TCE	SCR-D 400V		MAC97-6		
Q400E4	TCE	SCR-D 0.6A, 400V		MAC97-6		
Q4010	TCE	10A, 400V, 0.05A, 2V	B-51	ECG5649		
Q4010A, AT	TCE	10A, 400V, 0.05A, 2V	D-9	SC146D		
Q4010F41, FT1	TCE	SCR-D 10A, 400V, 0.04A, 2V	B-89	ECG5645, SC146D, TAG480-400, 2N6347		
Q4010L4	TCE	SCR-D 10A, 400V, 0.025A, 2V	B-91	ECG5645, SC146D, TAG480-400, 2N6347		
Q4010L5, LT	TCE	SCR-D 10A, 400V, 0.05A, 2V	B-91	ECG5646, SC146D		
Q4010R4, T	TCE	SCR-D 10A, 400V, 0.025A, 3V	B-51	SC146D		
Q4012L5, R5	TCE	SCR-D 12A, 400V, 0.05A, 2.5V	B-91	2N6347A		
Q4015	TCE	15A, 400V, 0.05A, 2.5V	B-66	ECG5649		
Q4015A	TCE	15A, 400V, 0.05A, 2.5V	D-9	SC250D, SC251D		
Q4015B, G, H	TCE	15A, 400V, 0.05A, 2.5V	F-58	SK3659, SK56006, MAC15A6		
Q4015L5, LT, R5	TCE	SCR-D 15A, 400V, 0.05A, 2.5V	B-91			
Q4025, G	TCE	SCR-D 25A, 400V, 0.05A, 2.5V	B-73	ECG5689, MAC37-6, SC261D		
Q4025C	TCE	25A, 400V, 0.05A, 2.5V	D-9	ECG5679		
Q4025D, H	TCE	SCR-D 25A, 400V, 0.05A, 2.5V	F-50	ECG56024, ECG5695, MAC38-6, SC260D3, SC260D, SK3509, SK5695		
Q4025L5, R5	TCE	25A, 400V, 0.05A, 2.5V	B-91	MAC223-6		
Q4025P	TCE	SCR-D 25A, 400V, 0.05A, 2.5V	G-18	ECG5679, MAC525-6		
Q4025V6, Y6, Z6	TCE	25A, 400V, 0.08A, 2.5V				







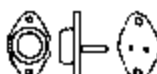
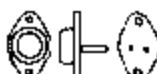
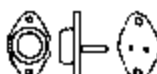
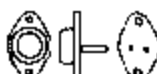
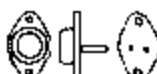
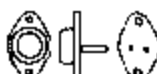
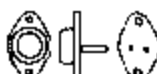
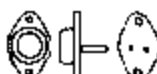
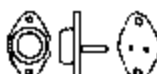
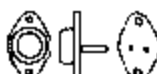
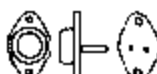
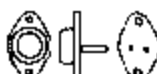
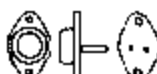







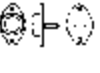

器件型号 Element type	厂名 Manufacturers	材料用途参数 Material Purpose Parameter	图号 Figure	国内外相似替换器件型号 Replace of similar type	备注 Notes	外形参考图 Reference shape
Q4040	TCE	SCR-D 40A, 400V, 0.1A, 2.5V	B-73	T6401D		
Q4040C	TCE	40A, 400V, 0.1A, 2.5V	D-9	ECG5679, T6420D		
Q4040D	TCE	40A, 400V, 0.1A, 2.5V	F-50	ECG56024, MAC40689, MAC50-6		
Q4040P	TCE	40A, 400V, 0.1A, 2.5V	G-18			
Q5004F41, FT1	TCE	SCR-D 4A, 500V, 0.025A, 2.5V	B-89	SC136E		
Q5004L4, LT	TCE	SCR-D 4A, 500V, 0.025A, 2.5V	B-91	ECG5645, ECG5646, 2N6074A		
Q5006	TCE	6A, 500V, 0.05A, 2.5V	B-51	ECG5649		
Q5006A, AT	TCE	6A, 500V, 0.05A, 2.5V	D-9	T2500E		
Q5006F41, FT1	TCE	SCR-D 6A, 500V, 0.025A, 2.5V	B-89	ECG5645, T2500E		
Q5006L4	TCE	SCR-D 6A, 500V, 0.025A, 2.5V	B-91	FCC5646, SC141E		
Q5006L5, LT	TCE	SCR-D 6A, 500V, 0.05A, 2.5V	B-91	T2500E		
Q5006R4	TCE	SCR-D 6A, 500V, 0.025A, 3V	B-9			
Q5006T	TCE	6A, 500V	B-51			
Q5008A, AT	TCE	8A, 500V, 0.05A, 2.5V	D-9	ECG5649		
Q5008F41, FT1	TCE	SCR-D 8A, 500V, 0.025A, 2.5V	B-89	T2800D		
Q5008L4, L4A	TCE	SCR-D 8A, 500V, 0.025A, 2.5V	B-91	ECG5645, T2800E		
Q5008L5	TCE	SCR-D 8A, 500V, 0.05A, 2.5V	B-91	MAC218-7		
Q5008LT, LTA	TCE	8A, 500V	B-89	ECG5646		
Q5008R4, T	TCE	SCR-D 8A, 500V, 0.025A, 3V	B-66	T2800E		
Q5010	TCE	10A, 500V, 0.05A, 2.5V	B-51	ECG5649		
Q5010A, AT	TCE	10A, 500V, 0.05A, 2.5V	D-9	SC146E		
Q5010F41, FT1	TCE	SCR-D 10A, 500V, 0.025A, 2.5V	B-89	ECG5645, MAC10-7, SC146E		
Q5010L4	TCE	SCR-D 10A, 500V, 0.025A, 2.5V	B-91	SC146E		
Q5010L5	TCE	SCR-D 10A, 500V, 0.05A, 2.5V	B-91	SC146E		
Q5010LT	TCE	10A, 500V	B-89	ECG5646		

器件型号 Element type	厂名 Manufacturers	材料用途参数 Material Purpose Parameter	图号 Figure	国内外相似替换器件型号 Replace of similar type	备注 Notes	外形参考图 Reference shape
Q5010R4, T	TCE	SCR-D 10A, 500V, 0.025A, 3V	B-51	SC146E		
Q5012L5, R5	TCE	SCR-D 12A, 500V, 0.05A, 2.5V	B-91	2N6348A		
Q5015	TCE	15A, 500V, 0.05A, 2.5V	B-51	ECG5649		
Q5015A	TCE	15A, 500V, 0.05A, 2.5V	D-9	SC251E		
Q5015B, G	TCE	15A, 500V, 0.05A, 2.5V	F-58	SC250E		
Q5015H, LT	SCR-D	15A, 500V	B-91	ECG56008, MAC15A7, SK3660, SK56008		
Q5015L5	TCE	15A, 500V, 0.05A, 2.5V	B-9	MAC15A7		
Q5015R5	TCE	15A, 500V, 0.05A, 2.5V	C-50			
Q5025	TCE	SCR-D 25A, 500V, 0.05A, 2.5V	B-51	SC261E		
Q5025C	TCE	25A, 500V, 0.05A, 2.5V	D-9	ECG5679		
Q5025D, H	TCE	25A, 500V, 0.05A, 2.5V	F-50	ECG56026, ECG5697, MAC38-7, SC260E, SK3522, SK5697		
Q5025G	TCE	SCR-D 25A, 500V, 0.05A, 2.5V	B-73	ECG5690, MAC37-7, SC261E		
Q5025L5, P	TCE	25A, 500V, 0.05A, 2.5V	B-91	ECG5679, MAC223-7, MAC225-7		
Q5025R5	TCE	SCR-D 25A, 500V, 0.05A, 2.5V	C-50	MAC223 7		
Q5025V6	TCE	25A, 500V, 0.08A, 2.5V	F-58			
Q5025Y6	TCE	25A, 500V, 0.08A, 2.5V	B-66			
Q5025Z6	TCE	25A, 500V, 0.08A, 2.5V	D-39			
Q5040	TCE	SCR-D 40A, 500V, 0.1A, 2.5V	B-73	T6401E		
Q5040C	TCE	40A, 500V, 0.1A, 2.5V	D-9	ECG5679		
Q5040D	TCE	SCR-D 40A, 500V, 0.1A, 2.5V	F-50	ECG56026, T6420E		
Q5040P	TCE	SCR-D 40A, 500V, 0.1A, 2.5V	G-18	MAC50-7		
Q6004F41, FT1	TCE	SCR-D 4A, 600V, 0.025A, 2.5V	B-89	SC136M		
Q6004L4, LT	TCE	SCR-D 4A, 600V, 0.025A, 2.5V	B-91	ECG5645, ECG5646, 2N6074A		



器件型号 Element type	厂名 Manufacturers	材料用途参数 Material Purpose Parameter	图号 Figure	国内外相似替换器件型号 Replace of similar type	备注 Notes	外形参考图 Reference shape
Q6006	TCE	6A, 600V, 0.05A, 2.5V	B-51			
Q6006A, AT	TCE	6A, 600V, 0.05A, 2.5V	D-9	ECG5649		
Q6006F41, F51, FT1, L5	TCE	SCR-D 6A, 600V, 0.05A, 2.5V	B-89	SC136M, SC141M		
Q6006LT, R5	TCE	SCR-D 6A, 600V, 0.05A, 2.5V	B-91	SC141M		
Q6006T	TCE	6A, 600V	B-51			
Q6008	TCE	8A, 600V, 0.05A, 2.5V	B-51			
Q6008A, AT	TCE	8A, 600V, 0.05A, 2.5V	D-9	ECG5649		
Q6008F51, FT1	TCE	SCR-D 8A, 600V, 0.05A, 2.5V	B-89	T2802M		
Q6008FT1	TCE	8A, 600V, 0.05A, 2.5V	B-89			
Q6008L5, L5A	TCE	SCR-D 8A, 600V, 0.05A, 2.5V	B-91	MAC218-8		
Q6008LT, LTA, R5	TCE	8A, 600V, 0.05A, 2.5V	B-91	ECG5646		
Q6008T	TCE	8A, 600V	B-51			
Q6010	TCE	10A, 600V, 0.05A, 2.5V	B-51			
Q6010A, AT	TCE	10A, 600V, 0.05A, 2.5V	D-9	ECG5649		
Q6010F51, FT1	TCE	SCR-D 10A, 600V, 0.05A, 2.5V	B-89	SC146M		
Q6010L5, LT, R5, RT	TCE	SCR-D 10A, 600V, 0.05A, 2.5V	B-91	ECG5646, SC146M		
Q6012L5, R5	TCE	SCR-D 12A, 600V, 0.05A, 2.5V	B-91	2N6348A		
Q6015	TCE	15A, 600V, 0.05A, 2.5V	B-51			
Q6015A	TCE	15A, 600V, 0.05A, 2.5V	D-9	ECG5649		
Q6015B	TCE	15A, 600V, 0.05A, 2.5V	F-58			
Q6015G		SCR-D 15A, 600V		SC251M		
Q6015H		SCR-D 15A, 600V		SC250M		
Q6015L5, LT	TCE	SCR-D 15A, 600V, 0.05A, 2.5V	B-91	ECG56008, MAC15A8		

器件型号 Element type	厂名 Manufacturers	材料用途参数 Material Purpose Parameter	图号 Figure	国内外相似替换器件型号 Replace of similar type	备注 Notes	外形参考图 Reference shape
Q6015R5	TCE	SCR-D 15A, 600V, 0.05A, 2.5V	C-50	MAC15AB		
Q6025	TCE	SCR-D 25A, 600V, 0.05A, 2.5V	B-51	SC261M		
Q6025D	TCE	SCR-D 25A, 600V, 0.05A, 2.5V	F-50	ECG56026, ECG5697, SC260M, SC261M3		
Q6025G	TCE	SCR-D 25A, 600V, 0.05A, 2.5V	D-29	ECG5690, SC261M		
Q6025H	TCE	SCR-D 25A, 600V, 0.05A, 2.5V	F-50	ECG5697		
Q6025L5	TCE	SCR-D 25A, 600V, 0.05A, 2.5V	B-91	MAC223-8		
Q6025P	TCE	SCR-D 25A, 600V, 0.05A, 2.5V	G-18	ECG5679, MAC225-8		
Q6025H5	ICE	SCR-D 25A, 600V, 0.05A, 2.5V	C-50	MAC223-8		
Q6025V6	TCE	SCR-D 25A, 600V, 0.08A, 2.5V	F-58			
Q6025Y6	TCE	SCR-D 25A, 600V, 0.08A, 2.5V	B-66			
Q6025Z6	TCE	SCR-D 25A, 600V, 0.08A, 2.5V	D-39			
Q6040	TCE	SCR-D 40A, 600V, 0.1A, 2.5V	B-73	T6400M		
Q6040C	TCE	SCR-D 40A, 600V, 0.1A, 2.5V	D-9	ECG5679		
Q6040D	TCE	SCR-D 40A, 600V, 0.1A, 2.5V	F-50	ECG56026, MAC40690, T6420M		
Q6040P	TCE	SCR-D 40A, 600V, 0.1A, 2.5V	G-18	MAC50-8		
Q8004L4	TCE	SCR-D 4A, 800V, 0.025A, 2.5V	B-89			
Q8010L5	TCE	SCR-D 10A, 800V, 0.05A, 3V	B-9	SC146N		
Q8010R5	TCE	SCR-D 10A, 800V, 0.05A, 3V	B-9	SC146N		
Q8012L5	TCE	SCR-D 12A, 800V, 0.05A, 2.5V	B-91	2N6349A		
Q8012R5	TCE	SCR-D 12A, 800V, 0.05A, 2.5V	B-91	2N6349A		
Q8015L5	TCE	SCR-D 15A, 800V, 0.05A, 3V		ECG56010, MAC15A10		
Q8015R5	TCE	SCR-D 15A, 800V, 0.05A, 2.5V	B-91	MAC15A10		

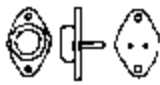
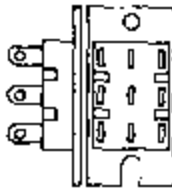
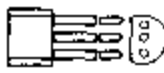
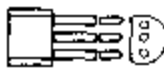

器件型号 Element type	厂名 Manufacturers	材料用途参数 Material Purpose Parameter	图号 Figure	国内外相似替换器件型号 Replace of similar type	备注 Notes	外形参考图 Reference shape
R5F400CP		6.4A, 400V, 0.05A	D-9			 图 D-9
R5F500CP		6.4A, 500V, 0.05A	D-9			
R5F600CP		6.4A, 600V, 0.05A	D-9			
R5F700CP		6.4A, 700V, 0.05A	D-9			
R5F800CP		6.4A, 800V, 0.05A	D-9			
R5F900CP		6.4A, 900V, 0.05A	D-9			
R15A	TCE	SCA 15A, 200V, 0.1A, 2.5V	H-12			 图 H-12
R15B	TCE	SCA 15A, 400V, 0.1A, 2.5V	H-12			
R15C	TCE	SCA 15A, 600V, 0.1A, 2.5V	H-12			
R15D	TCE	SCA 15A, 800V, 0.1A, 2.5V	H-12			
R15E	TCE	SCA 15A, 1kV, 0.1A, 2.5V	H-12			
R15F	TCE	SCA 15A, 1.2kV, 0.1A, 2.5V	H-12			
R25A	TCE	SCA 25A, 200V, 0.1A, 2.5V	H-12			 图 B-36
R25B	TCE	SCA 25A, 400V, 0.1A, 2.5V	H-12			
R25C	TCE	SCA 25A, 600V, 0.1A, 2.5V	H-12			
R25D	TCE	SCA 25A, 800V, 0.1A, 2.5V	H-12			
R25E	TCE	SCA 25A, 1kV, 0.1A, 2.5V	H-12			
R25F	TCE	SCA 25A, 1.2kV, 0.1A, 2.5V	H-12			
R40A2, A3	TCE	SCA 40A, 200V, 0.1A, 2.5V	H-12			 图 B-36
R40B2, B3	TCE	SCA 40A, 400V, 0.1A, 2.5V	H-12			
R40C2, C3	TCE	SCA 40A, 600V, 0.1A, 2.5V	H-12			
R40D2, D3	TCE	SCA 40A, 800V, 0.1A, 2.5V	H-12			
R40E2, E3	TCE	SCA 40A, 1kV, 0.1A, 2.5V	H-12			
R40F2, F3	TCE	SCA 40A, 1.2kV, 0.1A, 2.5V	H-12			
R0103AA	TCE	Tnac 0.64A, 100V, 0.005A	B-36	MAC92(A)-3, MAC95-3, Z0104BA, Z0104BB		

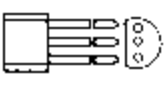
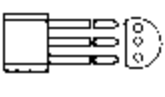
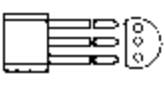
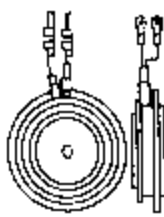
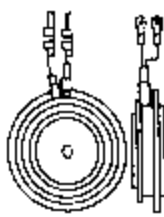

器件型号 Element type	厂名 Manufacturers	材料用途参数 Material Purpose Parameter	图号 Figure	国内外相似替换器件型号 Replace of similar type	备注 Notes	外形参考图 Reference shape
R0103BA	TCE	Triac 0.64A, 200V, 0.005A	B-36	MAC92(A)-4, MAC95-4, Z0104BA, Z0104BB		
R0103CA	TCE	Triac 0.64A, 300V, 0.005A	B-36	MAC92(A)-5, MAC95-5, Z0104DA, Z0104DB		
R0103DA	TCE	Triac 0.64A, 400V, 0.005A	B-36	MAC92(A)-6, MAC95-6, Z0104DA, Z0104DB		
R0106AA		Triac 0.6A, 100V, 0.01A	B-36	MAC91A-3, MAC94(A)-3		
R0106BA		Triac 0.6A, 200V, 0.01A	B-36	MAC91A-4, MAC94(A)-4		
R0106CA		Triac 0.6A, 300V, 0.01A	B-36	MAC91A-5, MAC94(A)-5		
R0106DA		Triac 0.6A, 400V, 0.01A	B-36	MAC91A-6, MAC94(A)-6		
R0107AA	TCE	Triac 0.6A, 100V, 0.01A	B-36	MAC92-3, MAC94-3, TAG91-3		
R0107BA	TCE	Triac 0.6A, 200V, 0.01A	B-36	MAC92-4, MAC94-4, TAG91-4		
R0107CA	TCE	Triac 0.6A, 300V, 0.01A	B-36	MAC92-5, MAC94-5, TAG91-5		
R0107DA	TCE	Triac 0.6A, 400V, 0.01A	B-36	MAC92-6, MAC94-6, TAG91-6		
R180CH02	TCE	900A, 200V, 0.3A, 3V				
R180CH04	TCE	900A, 400V, 0.3A, 3V				
R180CH06	TCE	900A, 600V, 0.3A, 3V				
R180CH08	TCE	900A, 800V, 0.3A, 3V				
R180CH10	TCE	900A, 1kV, 0.3A, 3V				
R190CH02	TCE	1kA, 200V, 0.3A, 3V	C-50			
R190CH04	TCE	1kA, 400V, 0.3A, 3V	C-50			
R190CH06	TCE	1kA, 600V, 0.3A, 3V	C-50			
R190CH08	WES	1kA, 800V, 0.3A, 3V	C-50			
R190CH10	WES	1kA, 1kV, 0.3A, 3V	C-50			
R190CH12	WES	1kA, 1.2kV, 0.3A, 3V	C-50			
R190CH14	WES	1kA, 1.4kV, 0.3A, 3V	C-50			
R200CH12	WES	1.1kA, 1.2kV, 0.3A, 3V	C-50			

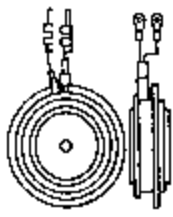
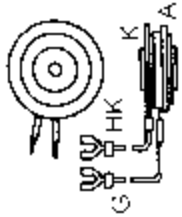
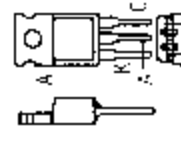
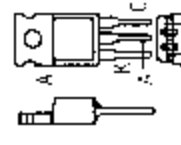

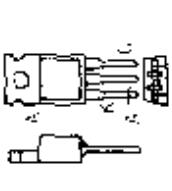
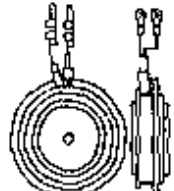
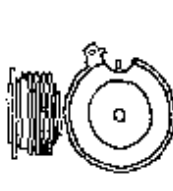
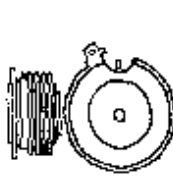
器件型号 Element type	厂名 Manufacturers	材料用途参数 Material Purpose Parameter	图号 Figure	国内外相似替换器件型号 Replace of similar type	备注 Notes	外形参考图 Reference shape
R200CH14	WES	1.1kA, 1.4kV, 0.3A, 3V	C-50			 图 C-50
R200CH16	WES	1.1kA, 1.6kV, 0.3A, 3V	C-50			
R200CH18	WES	1.1kA, 1.8kV, 0.3A, 3V	C-50			
R200CH20	WES	1.1kA, 2kV, 0.3A, 3V	C-50			
R200CH21	WES	1.1kA, 2.1kV, 0.3A, 3V	C-50			
R216CH02	WES	925A, 200V, 0.2A, 3V	C-70			 图 C-70
R216CH04	WES	925A, 400V, 0.2A, 3V	C-70			
R216CH06	WES	925A, 600V, 0.2A, 3V	C-70			
R216CH08	WES	925A, 800V, 0.2A, 3V	C-70			
R216CH10	WES	925A, 1kV, 0.2A, 3V	C-70			
R216CH12	WES	925A, 1.2kV, 0.2A, 3V	C-70			
R219CH02	WES	1.1kA, 200V, 0.3A, 3V	C-50			 图 B-91
R219CH04	WES	1.1kA, 400V, 0.3A, 3V	C-50			
R219CH06	WES	1.1kA, 600V, 0.3A, 3V	C-50			
R219CH08	WES	1.1kA, 800V, 0.3A, 3V	C-50			
R219CH10	WES	1.1kA, 1kV, 0.3A, 3V	C-50			
R219CH12	WES	1.1kA, 1.2kV, 0.3A, 3V	C-50			
R220CH02	WES	1.17kA, 200V, 0.3A, 3V	B-91			 图 B-91
R220CH04	WES	1.17kA, 400V, 0.3A, 3V	C-50			
R220CH06	WES	1.17kA, 600V, 0.3A, 3V	C-50			
R220CH08	WES	1.17kA, 800V, 0.3A, 3V	C-50			
R220CH10	WES	1.17kA, 1kV, 0.3A, 3V	C-50			
R220CH12	WES	1.17kA, 1.2kV, 0.3A, 3V	C-50			
R240CH06	WES	1.2kA, 600V, 0.3A, 3V	C-50			

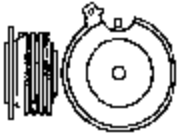
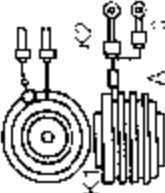

器件型号 Element type	厂名 Manufacturers	材料用途参数 Material Purpose Parameter	图号 Figure	国内外相似替换器型号 Replace of similar type	备注 Notes	外形参考图 Reference shape
R250CH02	WES	1.31kA, 200V, 0.2A, 3V	B-91			 图 B-91
R250CH06	WES	1.31kA, 600V, 0.3A, 3V	B-91			
R250CH08	WES	1.31kA, 800V, 0.3A, 3V	B-91			
R250CH10	WES	1.31kA, 1kV, 0.3A, 3V	B-91			
R250CH12	WES	1.31kA, 1.2kV, 0.3A, 3V	C-50			
R250CH14	WES	1.31kA, 1.4kV, 0.3A, 3V	B-91			
R270CH02	WES	1.2kA, 200V, 0.3A, 3V	C-50			 图 C-50
R270CH04	WES	1.2kA, 400V, 0.3A, 3V	C-50			
R270CH06	WES	1.2kA, 600V, 0.3A, 3V	C-50			
R270CH08	WES	1.2kA, 800V, 0.3A, 3V	C-50			
R305CH15	WES	1.32kA, 1.5kV, 0.3A, 3V	C-11			 图 C-11
R305CH16	WES	1.32kA, 1.6kV, 0.3A, 3V	C-11			
R305CH18	WES	1.32kA, 1.8kV, 0.3A, 3V	C-11			
R325CH02	WES	1.52kA, 200V, 0.3A, 3V	C-11			 图 C-11
R325CH04	WES	1.52kA, 400V, 0.3A, 3V	C-11			
R325CH06	WES	1.52kA, 600V, 0.3A, 3V	C-11			
R325CH08	WES	1.52kA, 800V, 0.3A, 3V	C-11			
R325CH10	WES	1.52kA, 1kV, 0.3A, 3V	C-11			
R325CH12	WES	1.52kA, 1.2kV, 0.3A, 3V	C-11			
R325CH14	WES	1.52kA, 1.4kV, 0.3A, 3V	C-11			
R350CH02	WES	1.51kA, 200V, 0.3A, 3V	C-11			
R350CH04	WES	1.51kA, 400V, 0.3A, 3V	C-11			
R350CH06	WES	1.51kA, 600V, 0.3A, 3V	C-11			
R350CH08	WES	1.51kA, 800V, 0.3A, 3V	C-11			
R350CH10	WES	1.51kA, 1kV, 0.3A, 3V	C-11			

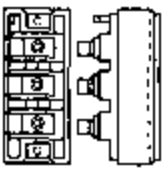
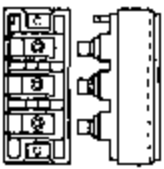

器件型号 Element type	厂名 Manufacturers	材料用途参数 Material Purpose Parameter	图号 Figure	国内外相似替换器件型号 Replace of similar type	备注 Notes	外形参考图 Reference shape
R350CH12	WES	1.51kA, 1.2kV, 0.3A, 3V	C-11			
R355CH02	WES	1.62kA, 200V, 0.3A, 3V	C-11			
R355CH04	WES	1.62kA, 400V, 0.3A, 3V	C-11			
R355CH06	WES	1.62kA, 600V, 0.3A, 3V	C-11			
R355CH08	WES	1.62kA, 800V, 0.3A, 3V	C-11			
R355CH10	WES	1.62kA, 1kV, 0.3A, 3V	C-11			
R355CH12	WES	1.62kA, 1.2kV, 0.3A, 3V	C-11			
R395CH12	WES	2.14kA, 1.2kV, 0.3A, 3V	C-11			
R395CH14	WES	2.14kA, 1.4kV, 0.3A, 3V	C-11			
R395CH15	WES	2.14kA, 1.5kV, 0.3A, 3V	C-11			
R395CH16	WES	2.14kA, 1.6kV, 0.3A, 3V	C-11			
R395CH18	WES	2.14kA, 1.8kV, 0.3A, 3V	C-11			
R400CH02	WES	1.87kA, 200V, 0.3A, 3V	C-11			
R400CH04	WES	1.87kA, 400V, 0.3A, 3V	C-11			
R400CH06	WES	1.87kA, 600V, 0.3A, 3V	C-11			
R400CH08	WES	1.87kA, 800V, 0.3A, 3V	C-11			
R400CH10	WES	1.87kA, 1kV, 0.3A, 3V	C-60			
R400CH12	WES	1.87kA, 1.2kV, 0.3A, 3V	C-11			
RCR70BY4	MIT	60A, 200V, 0.15A, 3V	E-22			
RCR70BY6	MIT	60A, 300V, 0.15A, 3V	E-22			
RCR70BY8	MIT	60A, 400V, 0.15A, 3V	E-22			
RCR70BY10	MIT	60A, 500V, 0.15A, 3V	E-22			
RCR70BY12	MIT	60A, 600V, 0.15A, 3V	E-22			
RCR150BX12	MIT	150A, 600V, 0.2A, 3V	E-22			

器件型号 Element type	厂名 Manufacturers	材料用途参数 Material Purpose Parameter	图号 Figure	国内外相似替换器型号 Replace of similar type	备注 Notes	外形参考图 Reference shape
RCR150BX16	MIT	RCT 150A, 800V, 0.2A, 3V	E-22			 图 E-22
RCR150BX20	MIT	RCT 150A, 1kV, 0.2A, 3V	E-22			
RCR150BX24	MIT	RCT 150A, 1.2kV, 0.2A, 3V	E-22			
RCR150BY4	MIT	RCT 150A, 200V, 0.2A, 3V	E-22			 图 H-13
RCR150BY6	MIT	RCT 150A, 300V, 0.2A, 3V	E-22			
RCR150BY8	MIT	RCT 150A, 400V, 0.2A, 3V	E-22			
RCR150BY10	MIT	RCT 150A, 500V, 0.2A, 3V	E-22			
RCR150BY12	MIT	RCT 150A, 600V, 0.2A, 3V	E-22			
RCR150BY16	MIT	RCT 150A, 800V, 0.2A, 3V	E-22			
RCR300BX12	MIT	RCT 250A, 600V, 0.25A, 3V	E-22			
RCR300BX16	MIT	RCT 250A, 800V, 0.25A, 3V	E-22			
RCR300BX20	MIT	RCT 250A, 1kV, 0.25A, 3V	F-22			
RCR300BX24	MIT	RCT 250A, 960V	E-22			
RCR300BY4	MIT	RCT 250A, 200V, 0.25A, 3V	E-22			 图 H-13
RCR300BY6	MIT	RCT 250A, 300V, 0.25A, 3V	E-22			
RCR300BY8	MIT	RCT 250A, 400V, 0.25A, 3V	E-22			
RCR300BY10	MIT	RCT 250A, 500V, 0.25A, 3V	E-22			
RCR300BY12	MIT	RCT 250A, 600V, 0.25A, 3V	E-22			
RCR300BY16	MIT	RCT 250A, 800V, 0.25A, 3V	E-22			
RR15F200	AEG	SCB 25A, 200V, 0.08A, 2.7V	H-13			
RR15F400	AEG	SCR 25A, 400V, 0.08A, 2.7V	H-13			
RR15F600	AEG	SCB 25A, 600V, 0.08A, 2.7V	H-13			
RR15F800	AEG	SCB 25A, 800V, 0.08A, 2.7V	H-13			
RR15F900	AEG	SCB 25A, 900V, 0.08A, 2.7V	H-13			
RR15F1000	AEG	SCB 25A, 1kV, 0.08A, 2.7V	H-13			

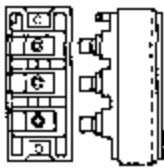

器件型号 Element type	厂名 Manufacturers	材料用途参数 Material Purpose Parameter	图号 Figure	国内外相似替换器件型号 Replace of similar type	备注 Notes	外形参考图 Reference shape
RR15F1100	AEG	SCB 25A, 1.1kV, 0.08A, 2.7V	H-13			 图 H-13
RR15F1200	AEG	SCB 25A, 1.2kV, 0.08A, 2.7V	H-13			
RTC0803		50Hz-Thy 0.25A, 30V, 2 μ A	B-62			 图 B-62
RTC0806		50Hz-Thy 0.25A, 60V, 2 μ A	B-62			
RTC0810		50Hz-Thy 0.25A, 100V, 2 μ A	B-62			
RTC0815		50Hz-Thy 0.25A, 150V, 2 μ A	B-62			
RTC0820		50Hz-Thy 0.25A, 200V, 2 μ A	B-62			
RTD0203		50Hz-Thy 1.6A, 30V, 100 μ A	B-62			
RTD0206		50Hz-Thy 1.6A, 60V, 100 μ A	B-62			
RTD0210		50Hz-Thy 1.6A, 100V, 100 μ A	B-62			
RTD0220		50Hz-Thy 1.6A, 200V, 100 μ A	B-62			
RTD0230		50Hz-Thy 1.6A, 300V, 100 μ A	B-62			
RTD0240		50Hz-Thy 1.6A, 400V, 100 μ A	B-62			
RTD0203-1 ...0240-1		50Hz-Thy =RTD0203...0240: 5 μ A	B-62			
RTD0203-2 ...0240-2		50Hz-Thy -RTD0203...0240: 10 μ A	B-62			
RTD0203-3 ...0240-3		50Hz-Thy -RTD0203...0240: 250 μ A	B-62			
RTD0301		50Hz-Thy 1A, 15V, 200 μ A	B-62	TAG615-100, 2N2322, 2N2323...2N2329		
RTD0303		50Hz-Thy 1A, 30V, 200 μ A	B-62	TAG615-100, 2N2323...2N2329		
RTD0306		50Hz-Thy 1A, 60V, 200 μ A	B-62	TAG615-100, 2N2324...2N2329		
RTD0310		50Hz-Thy 1A, 100V, 200 μ A	B-62	TAG615-100, 2N2324...2N2329		
RTD0315		50Hz-Thy 1A, 150V, 200 μ A	B-62	TAG615-200, 2N2325...2N2329		
RTD0320		50Hz-Thy 1A, 200V, 200 μ A	B-62	TAG615-200, 2N2326...2N2329		

器件型号 Element type	厂名 Manufacturers	材料用途参数 Material Purpose Parameter	图号 Figure	国内外相似替换器件型号 Replace of similar type	备注 Notes	外形参考图 Reference shape
RTD0330	50Hz-Thy	1A, 300V, 200 μ A	B-62	TAG615-400, 2N2328, 2N2329		 图 B-62
RTD0340	50Hz-Thy	1A, 400V, 200 μ A	B-62	TAG615-400, 2N2329		
RTD0350	50Hz-Thy	1A, 500V, 200 μ A	B-62	TAG615 600		
RTD0401	50Hz-Thy	1A, 15V, 100 μ A	B-62			
RTD0403	50Hz-Thy	1A, 30V, 100 μ A	B-62			
RTD0406	50Hz-Thy	1A, 60V, 100 μ A	B-62			
RTD0410	50Hz-Thy	1A, 100V, 100 μ A	B-62			
RTD0415	50Hz-Thy	1A, 150V, 100 μ A	B-62			
RTD0420	50Hz-Thy	1A, 200V, 100 μ A	B-62			
RTD0430	50Hz-Thy	1A, 300V, 100 μ A	B-62			
RTD0440	50Hz-Thy	1A, 400V, 100 μ A	B-62			
RTD2103	50Hz-Thy	1A, 30V, 0.01A	B-62	BTX30-50, S2600B, TAG612-100, T1N100A		
RTD2106	50Hz-Thy	1A, 60V, 0.01A	B-62	BTX30-100, S2600B, TAG612-100, T1N100A		
RTD2110	50Hz-Thy	1A, 100V, 0.01A	B-62	BTX30-100, S2600B, TAG612-100, T1N100A		
RTD2120	50Hz-Thy	1A, 200V, 0.01A	B-62	BTX30-200, S2600B, TAG612-200, T1N200A		
RTD2130	50Hz-Thy	1A, 300V, 0.01A	B-62	BTX30-300, S2600D, TAG612-400, T1N300A		
RTD2140	50Hz-Thy	1A, 400V, 0.01A	B-62	BTX30-400, S2600D, TAG612-400, T1N400A		
RTED0302	50Hz-Thy	3.2A, 20V, 0.015A	B-62	S2620B		
RTED0305	50Hz-Thy	3.2A, 50V, 0.015A	B-62	S2620B		
RTED0310	50Hz-Thy	3.2A, 100V, 0.015A	B-62	S2620B		
RTED0320	50Hz-Thy	3.2A, 200V, 0.015A	B-62	S2620B		
RTED0330	50Hz Thy	3.2A, 300V, 0.015A	B-62	S2620D		
RTED0340	50Hz-Thy	3.2A, 400V, 0.015A	B-62	S2620D		
RTED0350	50Hz-Thy	3.2A, 500V, 0.015A	B-62	S2620M		
RTF0101	50Hz-Thy	1A, 15V, 200 μ A	B-62	TAG615-100, 2N2322...2N2329		



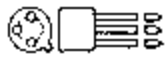

器件型号 Element type	厂名 Manufacturers	材料用途参数 Material Purpose Parameter	图号 Figure	国内外相似替换器件型号 Replace of similar type	备注 Notes	外形参考图 Reference shape
RTF0103		50Hz-Thy 1A, 30V, 200 μ A	B-62	TAG615-100, 2N2323...2N2329		 图 B-62
RTF0106		50Hz-Thy 1A, 60V, 200 μ A	B-62	TAG615-100, 2N2324...2N2329		
RTF0110		50Hz-Thy 1A, 100V, 200 μ A	B-62	TAG615-100, 2N2324...2N2329		
RTF0115		50Hz-Thy 1A, 150V, 200 μ A	B-62	TAG615-200, 2N2325...2N2329		
RTF0120		50Hz-Thy 1A, 200V, 200 μ A	B-62	TAG615-200, 2N2326...2N2329		
RTF0125		50Hz-Thy 1A, 250V, 200 μ A	B-62	TAG615-400, 2N2327...2N2329		
RTF0130		50Hz-Thy 1A, 300V, 200 μ A, 0.005A	B-62	TAG615-400, 2N2328, 2N2329		
RTF0135		50Hz-Thy 1A, 350V, 200 μ A, 0.005A	B-62	TAG615-400, 2N2329		
RTF0140		50Hz-Thy 1A, 400V, 200 μ A, 0.005A	B-62	TAG615-400, 2N2329		
RTF0201...0240		50Hz-Thy =RTF0101...0140: 0.001A	B-62	MCR1906..., TAG1..., TAG2..., TAG614...		
RTF0301...0340		50Hz-Thy =RTF0101...0140: 0.002A	B-62	TAG615..., 2N2322...2N2329		
RTF0401...0440		50Hz-Thy =RTF0101...0140: 100 μ A	B-62			
RTF0501...0540		50Hz-Thy =RTF0101...0140: 20 μ A	B-62	2N2322A...2N2329A, 2N6322...6337		
RTF0601...0640		50Hz-Thy =RTF0101...0140: 20 μ A	B-62	2N2322A...2N2329A, 2N6322...6337		
RTGC0101		GTO-Thy 0.25A, 15V, 500 μ A	B-62			
RTGC0103		GTO-Thy 0.25A, 30V, 500 μ A	B-62			
RTGC0106		GTO-Thy 0.25A, 60V, 500 μ A	B-62			
RTGC0110		GTO-Thy 0.25A, 100V, 500 μ A	B-62			
RTGC0115		GTO-Thy 0.25A, 150V, 500 μ A	B-62			
RTGC0120		GTO-Thy 0.25A, 200V, 500 μ A	B-62			
RTGC0125		GTO-Thy 0.25A, 250V, 500 μ A	B-62			

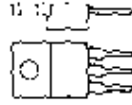

器件型号 Element type	厂名 Manufacturers	材料 Material	用途 Purpose	参数 Parameter	图号 Figure	国内外相似替换器件型号 Replace of similar type	备注 Notes	外形参考图 Reference shape
RTGD00101		GTO-Thy	0.5A, 15V, 500 μ A		B-62			 图 B-62
RTGD00103		GTO-Thy	0.5A, 30V, 500 μ A		B-62			
RTGD00106		GTO-Thy	0.5A, 60V, 500 μ A		B-62			
RTGD00110		GTO-Thy	0.5A, 100V, 500 μ A		B-62			
RTGD00115		GTO-Thy	0.5A, 150V, 500 μ A		B-62			
RTGD00120		GTO-Thy	0.5A, 200V, 500 μ A		B-62			
RTGD00125		GTO-Thy	0.5A, 250V, 500 μ A		B-62			
RTGD00130		GTO-Thy	0.5A, 300V, 500 μ A		B-62			
RTJ0103		50Hz-Thy	0.4A, 30V, 100 μ A		B-35			
RTJ0103-1		50Hz-Thy	0.4A, 30V, 2 μ A		B-35			
RTJ0103-2		50Hz-Thy	0.4A, 30V, 5 μ A		B-35			
RTJ0106		50Hz-Thy	0.4A, 60V, 100 μ A		B-35			
RTJ0106 1		50Hz-Thy	0.4A, 60V, 2 μ A		B-35			
RTJ0106-2		50Hz-Thy	0.4A, 60V, 5 μ A		B-35			
RTJ0110		50Hz-Thy	0.4A, 100V, 100 μ A		B-35			
RTJ0110-1		50Hz-Thy	0.4A, 100V, 2 μ A		B-35			
RTJ0110-2		50Hz-Thy	0.4A, 100V, 5 μ A		B-35			
RTJ0120		50Hz-Thy	0.4A, 200V, 100 μ A		B-35			
RTJ0120-1		50Hz-Thy	0.4A, 200V, 2 μ A		B-35			
RTJ0120-2		50Hz-Thy	0.4A, 200V, 5 μ A		B-35			
RTJ0130		50Hz-Thy	0.4A, 300V, 100 μ A		B-35			
RTJ0130-1		50Hz-Thy	0.4A, 300V, 2 μ A		B-35			
RTJ0130-2		50Hz-Thy	0.4A, 300V, 5 μ A		B-35			
RTJ0140		50Hz-Thy	0.4A, 400V, 100 μ A		B-35			
RTJ0140-1		50Hz-Thy	0.4A, 400V, 2 μ A		B-35			
RTJ0140-2		50Hz-Thy	0.4A, 400V, 5 μ A		B-35			
RTJ0203		50Hz-Thy	0.5A, 30V, 0.001A		B-35	BRY55-30, BT149Г, TAG70D, TAG72D		

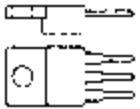

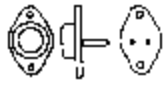
器件型号 Element type	厂名 Manufacturers	材料用途参数 Material Purpose Parameter	图号 Figure	国内外相似替换器件型号 Replace of similar type	备注 Notes	外形参考图 Reference shape
RTJ0206	50Hz-Thy	0.5A, 60V, 0.001A	B-35	BRY55-60, BT149A, TAG70D, TAG72D		 图 B-35
RTJ0210	50Hz-Thy	0.5A, 100V, 0.001A	B-35	BRY55-100, BT149A, TAG70D, TAG72D		
RTJ0215	50Hz-Thy	0.5A, 150V, 0.001A	B-35	BRY55-200, BT149B, TAG70D, TAG72D		
RTJ0220	50Hz-Thy	0.5A, 200V, 0.001A	B-35	BRY55-200, BT149B, TAG70D, TAG72D		
RTJ0230	50Hz-Thy	0.5A, 300V, 0.001A	B-35	BRY55-300, BT149D, TAG70D, TAG72D		
RTJ0501	50Hz-Thy	0.8A, 15V, 20 μ A	B-35			 图 B-11
RTJ0503	50Hz-Thy	0.8A, 30V, 20 μ A	B-35			
RTJ0506	50Hz-Thy	0.8A, 60V, 20 μ A	B-35			
RTJ0510	50Hz-Thy	0.8A, 100V, 20 μ A	B-35			
RTJ0515	50Hz-Thy	0.8A, 150V, 20 μ A	B-35			
RTJ0520	50Hz-Thy	0.8A, 200V, 20 μ A	B-35			
RTJ0525	50Hz-Thy	0.8A, 250V, 20 μ A	B-35			
RTJ0530	50Hz-Thy	0.8A, 300V, 20 μ A	B-35			
RTL0605	50Hz-Thy	6A, 50V, 0.05A	B-11	BS1D1026, BT152-400R, 2N6400...2N6405		
RTL0610	50Hz-Thy	6A, 100V, 0.05A	B-11	BS1D1026, BT152-400R, 2N6401...2N6405		
RTL0620	50Hz-Thy	6A, 200V, 0.05A	B-11	BS1D1026, BT152-400R, 2N6402...2N6405		
RTL0640	50Hz-Thy	6A, 400V, 0.05A	B-11	BS1D1026, BT152-400R, 2N6403...2N6405		
RTL0660	50Hz-Thy	6A, 600V, 0.05A	B-11	BS1D1040, BT152-600R, 2N6404, 2N6405		
RTL0805	50Hz-Thy	8A, 50V, 0.05A	B-11	BS1D1026, BT152-400R, 2N6504, 2N6506, 2N6506, 2N6507, 2N6508, 2N6509		
RTL0810	50Hz-Thy	8A, 100V, 0.05A	B-11	BS1D1026, BT152-400R, 2N6505, 2N6506, 2N6507, 2N6508, 2N6509		
RTL0820	50Hz-Thy	8A, 200V, 0.05A	B-11	BS1D1026, BT152-400R, 2N6506, 2N6507, 2N6508, 2N6509		
RTL0840	50Hz-Thy	8A, 400V, 0.05A	B-11	BS1D1026, BT152-400R, 2N6507, 2N6508, 2N6509		
RTL0860	50Hz-Thy	8A, 600V, 0.05A	B-11	BS1D1040, BT152-600R, 2N6508, 2N6509		

器件型号 Element type	厂名 Manufacturers	材料用途参数 Material Purpose Parameter	图号 Figure	国内外相似替换器件型号 Replacc of similar type	备注 Notes	外形参考图 Reference shape
RTL1005		50Hz-Thy 10A, 50V, 0.05A	B-11	BSID1026M, BT152-400R, 2N6504, 2N6505, 2N6506, 2N6507, 2N6508, 2N6509		 图 B-11
RTL1010		50Hz-Thy 10A, 100V, 0.05A	B-11	BSID1026M, BT152-100R, 2N6505, 2N6506, 2N6508, 2N6509		
RTL1020		50Hz-Thy 10A, 200V, 0.05A	B-11	BSID1026M, BT152-400R, 2N6506, 2N6507, 2N6509		
RTL1030		50Hz-Thy 10A, 300V, 0.05A	B-11	BSID1026M, BT152-400R, 2N6507, 2N6508, 2N6509		
RTL1040		50Hz-Thy 10A, 400V, 0.05A	B-11	BSID1026M, BT152-400R, 2N6507, 2N6508, 2N6509		
RTL1050		50Hz-Thy 10A, 500V, 0.05A	B-11	BSID1033M, BT152-500R, 2N6508, 2N6509		
RTL1060		50Hz-Thy 10A, 600V, 0.05A	B-11	BSID1040M, BT152-600R, 2N6508, 2N6509		
RTL1510		50Hz Thy 15A, 100V, 0.1A	B-11	MCR69-3, 2N6504, 2N6505, 2N6506, 2N6507, 2N6508, 2N6509		 图 F-55
HIL1520		50Hz Thy 15A, 200V, 0.1A	B-11	2N6505, 2N6506, 2N6507, 2N6508, 2N6509		
RTL1540		50Hz-Thy 15A, 400V, 0.1A	B-11	2N6507, 2N6508, 2N6509		
RTL1560		50Hz-Thy 15A, 600V, 0.1A	B-11	2N6508, 2N6509		
RTL1610		50Hz-Thy 16A, 100V, 0.05A	B-11	MCR69-3, 2N6504, 2N6505, 2N6506, 2N6507, 2N6508, 2N6509		 图 D-9
RTL1620		50Hz-Thy 16A, 200V, 0.05A	B-11	2N6505, 2N6506, 2N6507, 2N6508, 2N6509		
RTL1640		50Hz-Thy 16A, 400V, 0.05A	B-11	2N6507, 2N6508, 2N6509		
RTL1660		50Hz-Thy 16A, 600V, 0.05A	B-11	2N6508, 2N6509		
RTM1005...1060		50Hz-Thy =RTL1005...1060: Iso	B-11			
RTN0805...0860		50Hz-Thy =RTL0805...0860	F-55	BTW42/..., CS13..., TAG9N..., TAG15 ...		
RTR0305		50Hz-Thy 5A, 50V, 0.02A	D-9	BSIC0506, TAG671-100, TAG676-100		
RTR0310		50Hz-Thy 5A, 100V, 0.02A	D-9	BSIC0506, TAG671-100, TAG676-100		

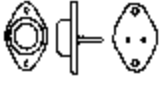
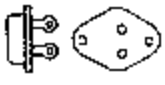

器件型号 Element type	厂名 Manufacturer's	材料用途参数 Material Purpose Parameter	图号 Figure	国内外相似替换器件型号 Replace of similar type	备注 Notes	外形参考图 Reference shape
RTR0320		50Hz-Thy 5A, 200V, 0.02A	D-9	B5IC0513, TAG671-200, TAG676-200		 图 D-9
RTR0330		50Hz-Thy 5A, 300V, 0.02A	D-9	B5IC0526, TAG671-300, TAG676-300		
RTR0340		50Hz-Thy 5A, 400V, 0.02A	D-9	B5IC0526, TAG671-400, TAG676-400		
RTR0350		50Hz-Thy 5A, 500V, 0.02A	D-9	B5IC0533, TAG671-500, TAG676-500		
RTR0360		50Hz-Thy 5A, 600V, 0.02A	D-9	B5IC0540, TAG671-600, TAG676-600		
RTR0605...0660		50Hz-Thy =RTL0605...0660	D-9	TAG675-...		
RTR1005...1060		50Hz-Thy =RTL1005...1060	D-9			
RTS0605...0660		50Hz-Thy =RTL0605...0660	D-14	B5IE40...M		 图 D-14
RTS1005...1060		50Hz-Thy =RTL1005...1060	D-14	B5IE40...M		
RTS1610...1660		50Hz-Thy =RTL1610...1660	D-14	B5IE40...M		
RTS2505		50Hz-Thy 25A, 50V, 0.05A	D-14			
RTS2510		50Hz-Thy 25A, 100V, 0.05A	D-14			
RTS2520		50Hz-Thy 25A, 200V, 0.05A	D-14			
RTS2540		50Hz-Thy 25A, 400V, 0.05A	D-14			
RTS2560		50Hz-Thy 25A, 600V, 0.05A	D-14			
RTT2505...2560		50Hz-Thy =RTS2505...2560	F-55	BTW48/..., CS23-..., T24N..., TAG24N...		 图 F-55
RTU0605...0660		50Hz-Thy =RTL0605...0660	F-55	BTW39/..., CS13..., TAG9N..., TAG15-...		
RTU0710		50Hz-Thy 25A, 100V, 0.05A	F-55	BTW48-200, CS23-02, T24N200, TAG24N400		
RTU0720		50Hz-Thy 25A, 200V, 0.05A	F-55	BTW48-200, CS23-02, T24N200, TAG24N400		
RTU0730		50Hz-Thy 25A, 300V, 0.05A	F-55	BTW48-400, CS23-04, T24N400, TAG24N400		

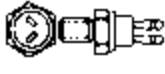
器件型号 Element type	厂名 Manufacturers	材料用途参数 Material Purpose Parameter	图号 Figure	国内外相似替换器件型号 Heplace of similar type	备注 Notes	外形参考图 Reference shape
RTU0740		50Hz-Thy 25A, 400V, 0.05A	F-55	BTW48-400, CS23-04, T24N400, TAG24N400		
RTU0750		50Hz-Thy 25A, 500V, 0.05A	F-55	BTW48-500, CS23-06, T24N600, TAG24N600		
RTU0760		50Hz-Thy 25A, 600V, 0.05A	F-55	BTW48-600, CS23-06, T24N600, TAG24N600		
RTU1005...1060		50Hz-Thy =RTL1005...1060	F-55	TAG9N..., TAG15-..., 2N1842...2N1850		
RTU1610...1660		50Hz-Thy =RTL1610...1660	F-55	BTW39/..., BTW47/..., TAG14N...		
RTU2505...2560		50Hz-Thy =RTS2505...2560	F-55	BTW48/..., CS23-..., T24N-..., TAG24N...		
RTV0102		50Hz-Thy 10A, 25V, 0.05A	F-55	TAG9N400, TAG14N400, TAG15-100		
RTV0105		50Hz-Thy 10A, 50V, 0.05A	F-55	TAG9N400, TAG14N400, TAG15-100		
RTV0110		50Hz-Thy 10A, 100V, 0.05A	F-55	TAG9N400, TAG14N400, TAG15-100		
RTV0120		50Hz-Thy 10A, 200V, 0.05A	F-55	TAG9N400, TAG14N400, TAG15-200		
RTV0130		50Hz-Thy 10A, 300V, 0.05A	F-55	TAG9N400, TAG14N400, TAG15-400		
RTV0140		50Hz-Thy 10A, 400V, 0.05A	F-55	TAG9N400, TAG14N400, TAG15-400		
RTV0150		50Hz-Thy 10A, 500V, 0.05A	F-55	TAG9N600, TAG14N600, TAG15-500		
RTV0160		50Hz-Thy 10A, 600V, 0.05A	F-55	TAG9N600, TAG14N600, TAG15-600		
RTV0202		50Hz-Thy 16A, 25V, 0.05A	F-55	BTW40-200R, BTW92-200R, T17N200		
RTV0205		50Hz-Thy 16A, 50V, 0.05A	F-55	BTW40-200R, BTW92-200R, T17N200		
RTV0210		50Hz-Thy 16A, 100V, 0.05A	F-55	BTW40-200R, BTW92-200R, T17N200		
RTV0220		50Hz-Thy 16A, 200V, 0.05A	F-55	BTW40-200R, BTW92-200R, T17N200		
RTV0230		50Hz-Thy 16A, 300V, 0.05A	F-55	BTW40-400R, BTW92-400R, T17N400		
RTV0240		50Hz-Thy 16A, 400V, 0.05A	F-55	BTW40-400R, BTW92-400R, T17N400		
RTV0250		50Hz-Thy 16A, 500V, 0.05A	F-55	BTW40-600R, BTW92-600R, T17N600		
RTV0260		50Hz-Thy 16A, 600V, 0.05A	F-55	BTW40-600R, BTW92-600R, T17N600		
RTV0302		50Hz-Thy 16A, 25V, 0.025A	F-55	BSIE4126N, C230U		



器件型号 Element type	厂名 Manufacturers	材料用途参数 Material Purpose Parameter	图号 Figure	国内外相似替换器件型号 Replace of similar type	备注 Notes	外形参考图 Reference shape
RTV0305	50Hz Thy	16A, 50V, 0.025A	F-55	BSIE4126N, C230F		 图 F-55
RTV0310	50Hz-Thy	16A, 100V, 0.025A	F-55	BSIE4126N, C230A		
RTV0320	50Hz-Thy	16A, 200V, 0.025A	F-55	BSIE4126N, C230B		
RTV0330	50Hz-Thy	16A, 300V, 0.025A	F-55	BSIE4126N, C230C		
RTV0340	50Hz-Thy	16A, 400V, 0.025A	F-55	BSIE4126N, C230D		
RTV0350	50Hz-Thy	16A, 500V, 0.025A	F-55	BSIE4133N, C230E		
RTV0360	50Hz-Thy	16A, 600V, 0.025A	F-55	BSIE4140N, C230M		
RTV0402...0460	50Hz-Thy	=RTV0102...0160	F-55	RTV0102...0160		
RTV0502...0560	50Hz-Thy	=RTV0202...0260	F-55	RTV0202...0260		
RTV0602...0660	50Hz-Thy	=RTV0302...0360	F-55	RTV0302...0360		

Q~R 类外形参考图索引



图 B-9



图 B-11

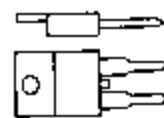

图 B-14

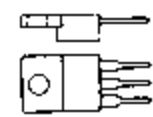

图 B-35

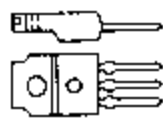

图 B-36



图 B-51

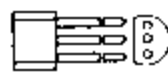

图 B-62



图 B-66



图 B-73

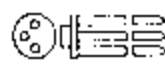

图 B-89



图 B-91

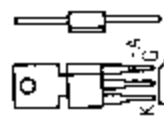

图 C-11

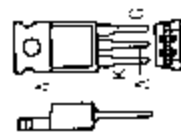

图 C-50

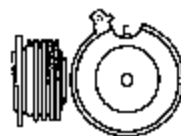

图 C-60

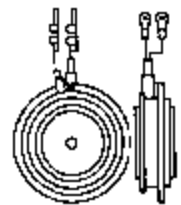

图 C-70

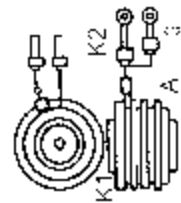

图 C-85

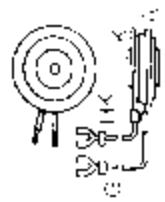

图 D-9

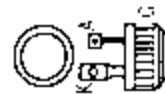

图 D-14

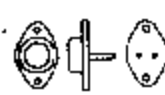

图 D-29



图 D-39

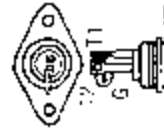

图 E-22

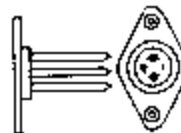

图 F-50



图 F-55



图 F-58

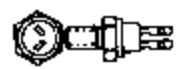

图 G-18



图 H-12



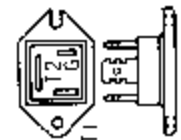

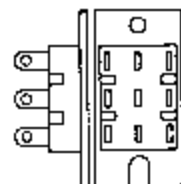

图 H-13

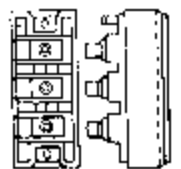
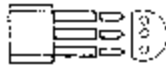
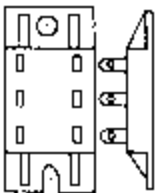

器件型号 Element type	厂名 Manufacturers	材料用途参数 Material Purpose Parameter	图号 Figure	国内外相似替换器件型号 Replace of similar type	备注 Notes	外形参考图 Reference shape
S1B	HUT	0.8A, 200V, 200 μ A, 0.8V	B-36	ECG116, EC-103B, SK3017B/117		 图 B-36
S1D	HUT	0.8A, 400V, 200 μ A, 0.8V	B-36	ECG125, EC-103D, SK303		
S1M	HUT	0.8A, 600V, 200 μ A, 0.8V	B-36	ECG5406		
S1N	HUT	0.8A, 800V, 200 μ A, 0.8V	B-36			
S1Y	HUT	0.8A, 30V, 200 μ A, 0.8V	B-36	ECG5400, EC-103Y		
S1YY	HUT	0.8A, 60V, 200 μ A, 0.8V	B-36	ECG5401, EC-103YY		
S08	HUT	8A, 50V, 0.025A, 2V				
S010	HUT	10A, 50V, 0.025A, 2V				
S18	HUT	8A, 100V, 0.025A, 2V		ECG116		
S020	HUT	20A, 50V, 0.025A, 2V				
S025	HUT	25A, 50V, 0.025A, 2V				
S28	HUT	8A, 200V, 0.025A, 2V		ECG125		
S031E	TCE	1A, 30V, 0.01A, 1.5V	B-36			 图 H-25
S035	HUT	35A, 50V, 0.025A, 2V				
S38	HUT	8A, 300V, 0.025A, 2V		ECG5870		
S48	HUT	8A, 400V, 0.025A, 2V		ECG116		
S58	HUT	8A, 500V, 0.025A, 2V		ECG5886		
S61, 62, 63, 64,	GTN	55A, 0.04A, 2.5V	H-25			
S66, 67, 68, 69	GTN, HUT	55A, 0.11A, 3V	H-25			
S75, 76, 77, 78,	GTN	60A, 0.11A, 3V	H-25			
79	SCA					

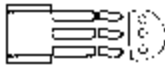

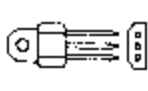

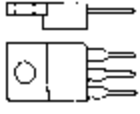
器件型号 Element type	厂名 Manufacturers	材料用途参数 Material Purpose Parameter	图号 Figure	国内外相似替换器件型号 Replace of similar type	备注 Notes	外形参考图 Reference shape
S85, 86, 87, 88, 89	GTN	SCA 75A, 0.11A, 3V	H-25			
S95, 96, 97, 98, 99	GTN	SCA 110A, 0.125A, 3V	H-25			
S101E	TCE	1A, 100V, 0.01A, 1.5V	B-36			
S106A1, A2	HUT	4A, 100V, 200 μA, 0.8V	B-89	BRX61, ECG5454, SK6754, SK5454, T106A1, T106A2		
S106B1	HUT	4A, 200V, 200 μA, 0.8V	B-89	BRX62, ECG5455, SK3597, SK5455, T106B1		
S106B2	HUT	4A, 200V, 200 μA, 0.8V	B-97	T106B2		
S106C1, C2	HUT	4A, 300V, 200 μA, 0.8V	B-97	ECG5457, T106C1, T106C2		
S106D1	HUT	4A, 400V, 200 μA, 0.8V	B-89	ECG5457, T106D1		
S106D2	HUT	4A, 400V, 200 μA, 0.8V	B-97	T106D2		
S106E1	HUT	4A, 500V, 200 μA, 0.8V	B-89			
S106E2	HUT	4A, 500V, 200 μA, 0.8V	B-97			
S106F1	HUT	4A, 50V, 200 μA, 0.8V	B-89	ECG5453, SK6753, SK5453, T106F1		
S106F2	HUT	4A, 50V, 200 μA, 0.8V	B-97	T106F2		
S106M1	HUT	4A, 600V, 200 μA, 0.8V	B-89			
S106M2	HUT	4A, 600V, 200 μA, 0.8V	B-97			
S106N1, N2	HUT	4A, 800V, 200 μA, 0.8V	B-89			
S106P1, P2	HUT	4A, 1kV, 200 μA, 0.8V	B-89			
S106Y1	HUT	4A, 30V, 200 μA, 0.8V	B-89	SK6752, SK5452, T106Y1		
S106Y2	HUI	4A, 30V, 200 μA, 0.8V	B-97	T106Y2		
S107A		50Hz-Thy 2.55A, 100V	B-96	C106A, C107A		
S107B		50Hz-Thy 2.55A, 200V	B-98	C106B, C107B		
S107C		50Hz-Thy 2.55A, 300V	B-98	C106C, C107C		
S107D		50Hz-Thy 2.55A, 400V	B-98	C106D, C107D		

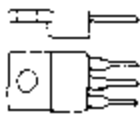
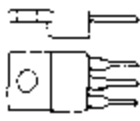
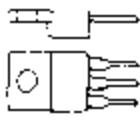
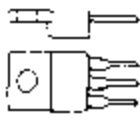
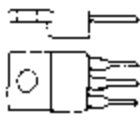
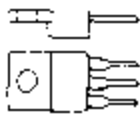
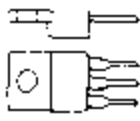
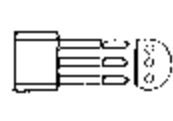
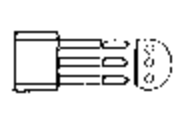
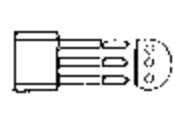
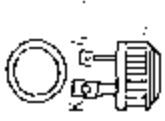
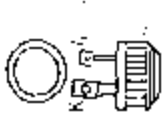
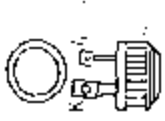
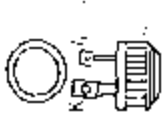
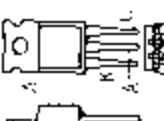
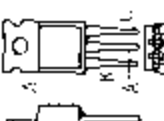
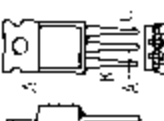
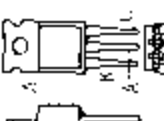
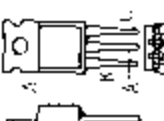
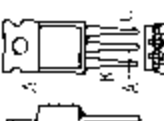
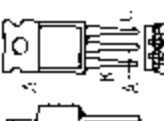
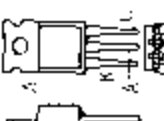
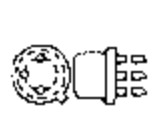
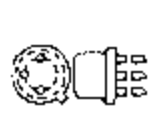
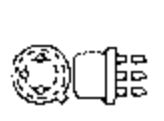

器件型号 Element type	厂名 Manufacturers	材料用途参数 Material Purpose Parameter	图号 Figure	国内外相似替换器件型号 Replace of similar type	备注 Notes	外形参考图 Reference shacc
S107E		50Hz-Thy 2.55A, 500V	B-98	C106E, C107E		 图 B-98
S107F		50Hz-Thy 2.55A, 50V	B-98	C106F, C107F		
S107M		50Hz-Thy 2.4A, 600V, 500 μ A, 0.8V	B-98	C106M, C107M		
S107Q		50Hz-Thy 2.4A, 15V, 500 μ A, 0.8V	B-98	C106Q, C107Q		
S107A1	HUT	4A, 100V, 500 μ A, 0.8V	B-89	ECG5454, SK6754, SK5454, T107A1		 图 B-89
S107A2	HUT	4A, 100V, 500 μ A, 0.8V	B-97	T107A2		
S107B1	HUT	4A, 200V, 500 μ A, 0.8V	B-89	ECG5455, SK3597, SK5455, T107B1		
S107B2	HUT	4A, 200V, 500 μ A, 0.8V	B-97	T107B2		
S107C1	HUT	4A, 300V, 500 μ A, 0.8V	B-89	ECG5457, T107C1		
S107C2	HUT	4A, 300V, 500 μ A, 0.8V	B-97	T107C2		
S107D1	HUT	4A, 400V, 500 μ A, 0.8V	B-89	ECG5457, T107D1		
S107D2	HUT	4A, 400V, 500 μ A, 0.8V	B-97	T107D2		
S107E1	HUT	4A, 500V, 500 μ A, 0.8V	B-89			
S107E2	HUT	4A, 500V, 500 μ A, 0.8V	B-97			
S107F1	HUT	4A, 50V, 500 μ A, 0.8V	B-89	ECG5453, SK6753, SK5453, T107F1		
S107F2	HUT	4A, 50V, 500 μ A, 0.8V	B-97	T107F2		
S107M1	HUT	4A, 600V, 500 μ A, 0.8V	B-89			
S107M2	HUT	4A, 600V, 500 μ A, 0.8V	B-97			
S107N1, N2	HUT	4A, 800V, 500 μ A, 0.8V	B-89			
S107P1, P2	HUT	4A, 1kV, 500 μ A, 0.8V	B-89			
S107Y1	HUT	4A, 30V, 500 μ A, 0.8V	B-89	ECG5452, SK6752, SK5452, T107Y1		
S107Y2	HUT	4A, 30V, 500 μ A, 0.8V	B-97	T107Y2		
S110	HUT	10A, 100V, 0.025A, 2V		SK9010, SK5809		 图 B-11
S120	HUT	20A, 100V, 0.025A, 2V				
S122A, A1	GES, GTC	50Hz-Thy 8A, 100V, 0.025A, 1.5V	B-11	C122A, C122A1		
S122B, B1	GES, GTC	50Hz-Thy 8A, 200V, 0.025A, 1.5V	B-11	C122B, C122B1		

器件型号 Element type	厂名 Manufacturers	材料用途参数 Material Purpose Parameter	图号 Figure	国内外相似替换器件型号 Replace of similar type	备注 Notes	外形参考图 Reference shape
S122C	GES, GTC	50Hz-Thy 8A, 300V, 0.025A, 1.5V	B-11	C122C, C122C1		
S122D	GES, GTC	50Hz-Thy 8A, 400V, 0.025A, 1.5V	B-11	C122D		
S122D1, E	GES, GTC	50Hz-Thy 8A, 500V, 0.025A, 1.5V	B-11	C122D1, C122E		
S122E1		8A, 600V	B-11	C122E1		
S122F, F1	GES, GTC	50Hz-Thy 8A, 50V, 0.025A, 1.5V	B-11	C122F, C122F1		
S122M	GFS, GTC	50Hz-Thy 8A, 600V, 0.025A, 1.5V	B-11	C122M, C122M1		
S122N1, S1		8A, 800V	B-11	C122N1, C122S1		
S125	HUT	25A, 100V, 0.025A, 2V				
S135	HUT	35A, 100V, 0.025A, 2V				
S201E	TCE	1A, 200V, 0.01A, 1.5V	B-36			
S210	HUT	10A, 200V, 0.025A, 2V		EGG125, SK3033		
S220	HUT	20A, 200V, 0.025A, 2V		EGG116, SK3311		
S225	HUT	25A, 200V	C-85			
S235	HUT	35A, 200V, 0.025A, 2V		EGG118, SK3016		
S0301L	TCE	1.6A, 30V, 0.01A, 1.5V	B-91			
S0301LS1	TCE	1.6A, 30V, 50 μA, 0.8V				
S0301LS2	TCE	1.6A, 30V, 200 μA, 0.8V				
S0301LS3	TCE	1.6A, 30V, 500 μA, 0.8V				
S0301M	TCE	1.6A, 30V, 50 μA, 1.5V	B-51	SK3953, SK5412		
S0301MS1	TCE	1.6A, 30V, 50 μA, 0.8V	B-51			
S0301MS2	TCE	1.6A, 30V, 200 μA, 0.8V	B 51			
S0301MS3	TCE	1.6A, 30V, 500 μA, 0.8V	B-51	MCR1906-1		
S0303L	TCE	3A, 30V, 0.01A, 1.5V		ECG5417		
S0303LS1	TCE	3A, 30V, 50 μA, 0.8V	B-91	ECG5426		
S0303LS2	TCE	3A, 30V, 200 μA, 0.8V	B-91	MCR106-1, ECG5426		

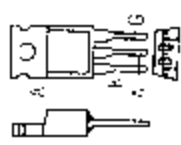
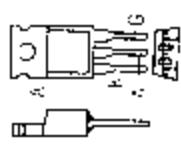
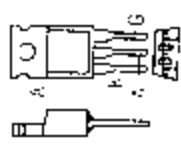
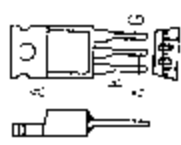
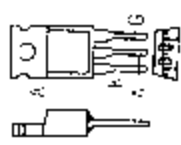
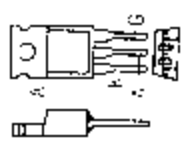
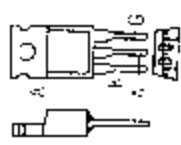
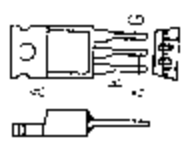
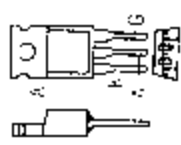
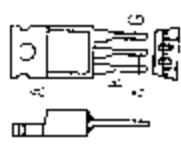
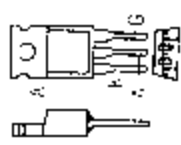
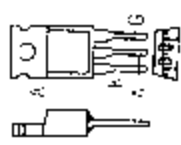
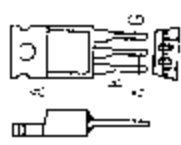
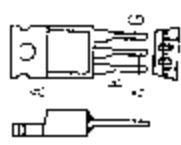
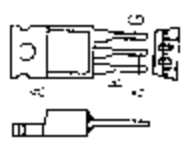
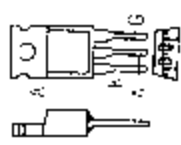
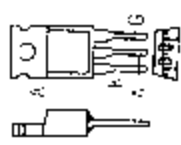
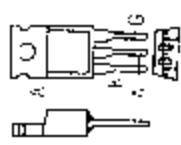
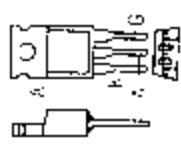
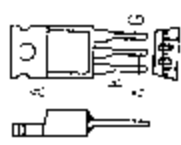
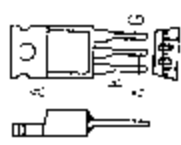
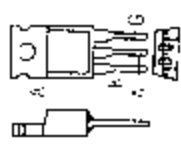

器件型号 Element type	厂名 Manufacturers	材料用途参数 Material Purpose Parameter	图号 Figure	国内外相似替换器件型号 Replace of similar type	备注 Notes	外形参考图 Reference shape
S0303LS90	TCE	3A, 30V, 500 μ A, 0.8V	B-91	MCR106-1, ECG5426		 图 B-91
S0303M	TCE	3A, 30V, 0.01A, 1.5V	B-51	ECG5408		
S0303MS1	TCE	3A, 30V, 50 μ A, 1.5V	B-51			
S0303MS2	TCE	3A, 30V, 200 μ A, 0.8V	B-51			
S0303MS3	TCE	3A, 30V, 500 μ A, 0.8V	B-51			
S0304F1	TCE	4A, 30V, 0.01A, 1.5V	B-91	ECG5452		
S0306F1	TCF	6A, 30V, 0.015A, 1.5V	B-91			 图 B-51
S0306FS21	TCE	6A, 30V, 200 μ A, 0.8V	B-89	ECG5517, SK3685, SK5461		
S0306FS31	TCE	6A, 30V, 500 μ A, 0.8V	B-89	ECG5426		
S0306L	TCE	6A, 30V, 0.015A, 1.5V	B-91			
S0306LS2	TCE	6A, 30V, 200 μ A, 0.8V	B-91			
S0306LS3	TCE	6A, 30V, 500 μ A, 0.8V	B-91			
S0308F1	TCE	8A, 30V, 0.015A, 1.5V	B-89	ECG5417, SK3685, SK5461		 图 B-59
S0308FS21	TCE	8A, 30V, 200 μ A, 0.8V	B-89	ECG5426		
S0308FS31	TCE	8A, 30V, 500 μ A, 0.8V	B-89	ECG5426		
S0308L	TCE	8A, 30V, 0.015A, 1.5V	B-91			
S0308LS2	TCE	8A, 30V, 200 μ A, 0.8V	B-91			
S0308LS3	TCE	8A, 30V, 500 μ A, 0.8V	B-91			
S0308R	TCE	8A, 30V, 0.015A, 1.5V	B-91			
S0310F1	TCE	8A, 30V, 0.015A, 1.5V	B-89			 图 B-59
S0310FS21	TCE	10A, 30V, 200 μ A, 0.8V	B-89	ECG5417		
S0310FS31	TCE	10A, 30V, 500 μ A, 0.8V	B-89	ECG5426		
S0310L	TCE	10A, 30V, 0.015A, 1.5V	B-91	ECG5426		
S0310LS2	TCE	10A, 30V, 200 μ A, 0.8V	B-91			
S0310LS3	TCE	10A, 30V, 500 μ A, 0.8V	B-91			
S310	HUT	10A, 300V, 0.025A, 2V				

器件型号 Element type	厂名 Manufacturers	材料用途参数 Material Purpose Parameter	图号 Figure	国内外相似替换器件型号 Replace of similar type	备注 Notes	外形参考图 Reference snapp
S0312L, R	TCE	12A, 30V, 0.02A, 1.5V	B-91			
S0315G, L	TCE	15A, 30V, 0.02A, 1.5V	B-91	ECG5514, ECG5550		
S0315H	TCE	15A, 30V, 0.02A, 1.5V	F-50	ECG5501		
S0316R	TCE	16A, 30V, 0.03A, 1.5V	B-91			
S0320L	TCE	20A, 30V, 0.025A, 2V	B-91	ECG5550		
S320	HUT	20A, 300V, 0.025A, 2V				
S0325	TCE	25A, 30V, 0.025A, 2V	B-73			
S0325C	TCE	25A, 30V, 0.025A, 2V	D-28	ECG5534, MCR649-1		
S0325D	TCE	25A, 30V, 0.025A, 2V	F-50	ECG5562		
S0325G	TCE	25A, 30V, 0.025A, 2V	B-73	ECG5517, MCR3835-1		
S0325H	TCE	25A, 30V, 0.025A, 2V	F-50	ECG5521, SK6621, SK5521		
S0325R	TCE	25A, 30V, 0.03A, 1.5V	B-91			
S325	HUT	25A, 300V, 0.025A, 2V				
S0335, C	TCE	35A, 30V, 0.025A, 2V	B-73	ECG5534		
S0335D	TCE	35A, 30V, 0.025A, 2V	F-50	ECG5562		
S0335G	TCE	35A, 30V, 0.025A, 2V	B-73	ECG5517, MCR3835-1, SK3615, SK5517		
S0335H	TCE	35A, 30V, 0.025A, 2V	F-50	ECG5541, MCR3935-1, SK5515, SK6615		
S335	HUT	35A, 300V, 0.025A, 2V				
S401E	TCE	1A, 400V, 0.01A, 1.5V	B-36			
S0402BH	TAG	2.6A, 200V, 200 μA, 2V	B-89			
S0402DH	TAG	2.6A, 400V, 200 μA, 2V	B-89			
S0402MH	TAG	2.6A, 600V, 200 μA, 2V	B-89			



器件型号 Element type	厂名 Manufacturers	材料用途参数 Material Purpose Parameter	图号 Figure	国内外相似替换器件型号 Replace of similar type	备注 Notes	外形参考图 Reference shape
S0402NH	TAG	2.6A, 800V, 200 μ A, 2V	B-89			
S0405BH	TAG	2.6A, 200V, 0.005A, 2V	B-89			
S0405DH	TAG	2.6A, 400V, 0.005A, 2V	B-89			
S0405MH	TAG	2.6A, 600V, 0.005A, 2V	B-89			
S0405NH	TAG	2.6A, 800V, 0.005A, 2V	B-89			
S0406BH		50A, 200V	B-9			
S0406DH		50A, 400V	B-9			
S0406MH		50A, 600V	B-9			
S0406NH		50A, 800V	B-9			
S0407BH	TAG	2.6A, 200V, 0.01A, 2V	B-89			
S0407DH	TAG	2.6A, 400V, 0.01A, 2V	B-89			
S0407MH	TAG	2.6A, 600V, 0.01A, 2V	B-89			
S0407NH	TAG	2.6A, 800V, 0.01A, 2V	B-89			
S0410BH	TAG	2.6A, 200V, 0.025A, 2V	B-89			
S0410DH	TAG	2.6A, 400V, 0.025A, 2V	B-89			
S0410MH	TAG	2.6A, 600V, 0.025A, 2V	B-89			
S0410NH	TAG	2.6A, 800V, 0.025A, 2V	B-89			
S410	HUT	10A, 400V, 0.025A, 2V		ECG5874		
S0417BH		50A, 200V	B-9			
S0417DH		50A, 400V	B-9			
S0417MH		50A, 600V	B-9			
S0417NH		50A, 800V	B-9			
S420	HUT	20A, 400V, 0.025A, 2V		ECG5874		
S425	HUT	25A, 400V, 0.025A, 2V		ECG5882		
S435	HUT	35A, 400V, 0.025A, 2V				



图 B-89



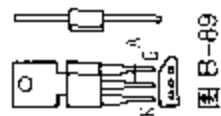

图 R-9

器件型号 Element type	厂名 Manufacturers	材料用途参数 Material Purpose Parameter	图号 Figure	国内外相似替换器件型号 Replace of similar type	备注 Notes	外形参考图 Reference shape
S0501L	TCE	1.6A, 50V, 0.01A, 1.5V	B-91	ECG5417		 图 B-91
S0501LS1	TCE	1.6A, 50V, 50 μA, 0.8V		ECG5426		
S0501LS2	TCE	1.6A, 50V, 200 μA, 0.8V		CCG5426		
S0501LS3	TCE	1.6A, 50V, 500 μA, 0.8V		ECG5426, SK3953, SK5412		
S0501M	TCE	1.6A, 50V, 0.01A, 1.5V	B-51	ECG5408		
S0501MS1	TCE	1.6A, 50V, 50 μA, 0.8V	B-51			
S0501MS2	TCE	1.6A, 50V, 200 μA, 0.8V	B-51			
S0501MS3	TCE	1.6A, 50V, 500 μA, 0.8V	B-51	MCR1906-2		
S0503L	TCE	3A, 50V, 0.01A, 1.5V	B-91	ECG5417		
S0503LS1	TCE	3A, 50V, 50 μA, 0.8V	B-91	ECG5426		
S0503LS2	TCE	3A, 50V, 200 μA, 0.8V	B-91	ECG5426, MCR106-2		
S0503LS3	TCE	3A, 50V, 500 μA, 0.8V	B-91	ECG5426, SK3953, SK5412		
S0503M	TCE	3A, 50V, 0.01A, 1.5V	B-51	ECG5408		
S0503MS1	TCE	3A, 50V, 50 μA, 0.8V	B-51			
S0503MS2	TCE	3A, 50V, 200 μA, 0.8V	B-51			
S0503MS3	TCE	3A, 50V, 500 μA, 0.8V	B-51			
S0504F1	TCE	4A, 50V, 0.01A, 1.5V	B-91	ECG5453		 图 B-89
S0506F1	TCE	6A, 50V, 0.015A, 1.5V	B-91			
S0506FS21	TCE	6A, 50V, 200 μA, 0.8V	B-89			
S0506FS31	TCE	6A, 50V, 500 μA, 0.8V	B-89			
S0506L	TCE	6A, 50V, 0.015A, 1.5V	B-91	ECG5417, SK3685, SK5461		
S0506LS2	TCE	6A, 50V, 200 μA, 0.8V	B-91	ECG5426		
S0506LS3	TCE	6A, 50V, 500 μA, 0.8V	B-91	ECG5426		
S0508F1	TCE	8A, 50V, 0.015A, 1.5V	B-89			
S0508FS21	TCE	8A, 50V, 200 μA, 0.8V	B-89			
S0508FS31	TCE	5.1A, 50V, 500 μA, 0.8V	B-89			

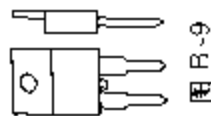
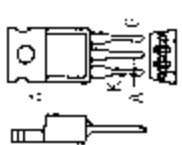
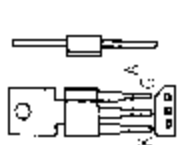
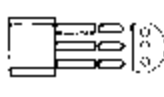

器件型号 Element type	厂名 Manufacturers	材料用途参数 Material Purpose Parameter	图号 Figure	国内外相似替换器件型号 Replace of similar type	备注 Notes	外形参考图 Reference shape
S0508L	TCE	8A, 50V, 0.015A, 1.5V	B-91	ECG5417, SK3685, SK5461		
S0508LS2	TCE	8A, 50V, 200 μA, 0.8V	B-91	ECG5426		
S0508LS3	TCE	8A, 50V, 500 μA, 0.8V	B-91	ECG5426		
S0508R	TCE	8A, 50V, 0.015A, 1.5V	B-91			
S0510F1	TCE	8A, 50V, 0.015A, 1.5V	B-89			
S0510FS21	TCE	10A, 50V, 200 μA, 0.8V	B-89			
S0510FS31	TCE	10A, 50V, 500 μA, 0.8V	B-89			
S0510L	TCE	10A, 50V, 0.015A, 1.5V	B-91	ECG5417		
S0510LS2	TCE	10A, 50V, 200 μA, 0.8V	B-91	ECG5417		
S0512L, R	TCE	12A, 50V, 0.02A, 1.5V	B-91			
S0515G, L	TCE	15A, 50V, 0.02A, 1.5V	B-91	ECG5414, ECG5550, SK3613, SK5514		
S0515H	TCE	15A, 50V, 0.02A, 1.5V	F-50	ECG5501		
S0516R	TCE	16A, 50V, 0.03A, 1.5V	C-50			
S0520L	TCE	20A, 50V, 0.025A, 2V	B-91	ECG5550		
S520	HUT	20A, 500V, 0.025A, 2V				
S0525, G	ICE	25A, 50V, 0.025A, 2V	B-73	ECG5517, MCR3835-2		
S0525C	TCE	25A, 50V, 0.025A, 2V	D-28	ECG5534, MCR649-2		
S0525D, H	TCE	25A, 50V, 0.025A, 2V	F-50	ECG5521, ECG5562, MCR3935-2		
S0525R	TCE	25A, 50V, 0.03A, 1.5V	B-91			
S525	HUT	25A, 500V, 0.025A, 2V				
S0535, C, G	TCE	35A, 50V, 0.025A, 2V	B-73	ECG5517, ECG5534, MCR3835-2		
S0535D, H	TCE	35A, 50V, 0.025A, 2V	F-50	C228F3, ECG5541, ECG5562 MCR3935-2, SK5515, SK6615		



器件型号 Element type	厂名 Manufacturers	材料用途参数 Material Purpose Parameter	图号 Figure	国内外相似替换器件型号 Replace of similar type	备注 Notes	外形参考图 Reference shape
S535	HUT	35A, 500V, 0.025A, 2V				
S542	GTN	25A, 500V, 0.04A, 2.5V				
S551	GTN	25A, 300V, 0.04A, 2.5V				
S552	GTN	25A, 500V, 0.04A, 2.5V				
S601E	TCE	1A, 600V, 0.01A, 1.5V	B-36			
S602BH	TAG	50Hz-Thy 3.8A, 200V, 200 μA	B-89	TAG623-200, TAG628-200, TAG633-200		
S602DH	TAG	50Hz-Thy 3.8A, 400V, 200 μA	B-91	TAG623-400, TAG628-400, TAG633-400		
S602MH	TAG	50Hz-Thy 3.8A, 600V, 200 μA	B-91	TAG623-600, TAG628-600, TAG633-600		
S602NH	TAG	50Hz-Thy 3.8A, 800V, 200 μA	B-91	TAG623-800, TAG628-800, TAG633-800		
S605BH	TAG	50Hz-Thy 3.8A, 200V, 0.005A	B-91	TAG626-200, TAG627-200, T3.5N200		
S605DH	TAG	50Hz-Thy 3.8A, 400V, 0.005A	B-91	TAG626-400, TAG627-400, T3.5N400		
S605MH	IAG	50Hz-Thy 3.8A, 600V, 0.005A	B-91	TAG626-600, TAG627-600, T3.5N600		
S605NH	TAG	50Hz-Thy 3.8A, 800V, 0.005A	B-91	TAG626-800, TAG627-800, T3.5N800		
S606BH		60A, 200V	B-9			
S606DH		60A, 400V	B-9			
S606MH		60A, 600V	B-9			
S606NH		60A, 800V	B-9			
S607BH	TAG	3.8A, 200V, 0.01A	B-91	TAG626-200, TAG627-200, T3.5N200		
S607DH	TAG	3.8A, 400V, 0.01A	B-91	TAG626-400, TAG627-400, T3.5N400		
S607MH	TAG	3.8A, 600V, 0.01A	B-91	TAG626-600, TAG627-600, T3.5N600		
S607NH	TAG	3.8A, 800V, 0.01A	B-91	TAG626-800, TAG627-800, T3.5N800		
S610BH	TAG	50Hz-Thy 3.8A, 200V, 0.025A	B-91	CS6-02, TAG625-200, TIC116B		
S610DH	TAG	50Hz-Thy 3.8A, 400V, 0.025A	B-9	CS6-04, TAG625-400, TIC116D		
S610MH	TAG	50Hz-Thy 3.8A, 600V, 0.025A	B-91	CS6-06, TAG625-600, TIC116M		

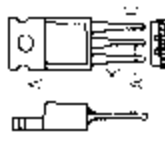
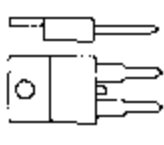

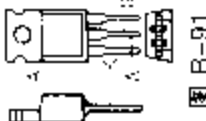
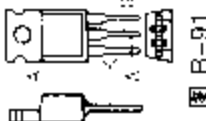
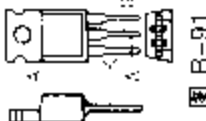
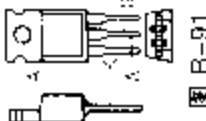
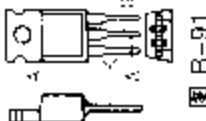
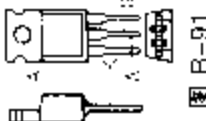
器件型号 Element type	厂名 Manufacturers	材料用途参数 Material Purpose Parameter	图号 Figure	国内外相似替换器件型号 Replace of similar type	备注 Notes	外形参考图 Reference shape
S0610NH	TAG	50Hz-Thy 3.8A, 800V, 0.025A	B-91	CS6-08, TAG625-800, TIC116N		 图 B-91  图 B-9
S610	HUT	10A, 600V, 0.025A, 2V				
S611F	GTN	SCA 42A, 350V, 0.11A, 3V				
S612F	GTN	SCA 42A, 500V, 0.11A, 3V				
S613F	GTN	SCA 42A, 800V, 0.11A, 3V				
S614F	GTN	SCA 42A, 1.2kV, 0.11A, 3V				
S0617BH		60A, 200V	B-9			
S0617DH		60A, 400V	B-9			
S0617MH		60A, 600V	B-9			
S0617NH		60A, 800V	B-9			
S620	HUT	20A, 600V, 0.025A, 2V				
S622F	GTN	SCA 42A, 500V, 0.11A, 3V				
S625	HUT	25A, 600V, 0.025A, 2V				
S635	HUT	35A, 600V, 0.025A, 2V				
S641	GTN	42.5A, 300V, 0.11A, 3V		SK3505, SK5547		
S642	GTN	42.5A, 500V, 0.11A, 3V				
S651	GTN	55A, 300V, 0.11A, 3V				
S652	GTN	55A, 500V, 0.11A, 3V				
S653	GTN	SCA 55A, 800V, 0.11A, 3V				
S0802BH	TAG	50Hz-Thy 5.1A, 200V, 200 μ A, 2V	B-91			
S0802DH	TAG	50Hz-Thy 5.1A, 400V, 200 μ A, 2V	B-91			

器件型号 Element type	厂名 Manufacturers	材料用途参数 Material Purpose Parameter	图号 Figure	国内外相似替换器件型号 Replace of similar type	备注 Notes	外形参考图 Reference shape
S0802MH	TAG	50Hz-Thy 5.1A, 600V, 200 μ A, 2V	B-91			
S0802NH	TAG	50Hz-Thy 5.1A, 800V, 200 μ A, 2V	B-91			
S0805BH	TAG	50Hz-Thy 5.1A, 200V, 0.005A, 2V	B-91	TAG661-200, TAG662-200, T3.5N200		
S0805DH	TAG	50Hz-Thy 5.1A, 400V, 0.005A, 2V	B-91	TAG661-400, TAG662-400, T3.5N400		
S0805MH	TAG	50Hz-Thy 5.1A, 600V, 0.005A, 2V	B-91	TAG661-600, TAG662-600, T3.5N600		
S0805NH	TAG	50Hz-Thy 5.1A, 800V, 0.005A, 2V	B-91	TAG661-800, TAG662-800, T3.5N800		
S0806BH		80A, 200V	B-9			
S0806DH		80A, 400V	B-9			
S0806MH		80A, 600V	B-9			
S0806NH		80A, 800V	B-9			
S0807BH	TAG	50Hz-Thy 5.1A, 200V, 0.01A, 2V	B-91	TAG661-200, TAG662-200, T3.5N200		
S0807DH	TAG	50Hz-Thy 5.1A, 400V, 0.01A, 2V	B-91	TAG661-400, TAG662-400, T3.5N400		
S0807MH	TAG	50Hz-Thy 5.1A, 600V, 0.01A, 2V	B-91	TAG661-600, TAG662-600, T3.5N600		
S0807NH	TAG	50Hz-Thy 5.1A, 800V, 0.01A, 2V	B-91	TAG661-800, TAG662-800, T3.5N800		
S0810BH	TAG	50Hz-Thy 5.1A, 200V, 0.025A, 2V	B-91	CS6-02, TAG660-200, TIC116B		
S0810DH	TAG	50Hz-Thy 5.1A, 400V, 0.025A, 2V	B-91	CS6-04, TAG660-400, TIC116D		
S0810MH	TAG	50Hz-Thy 5.1A, 600V, 0.025A, 2V	B-91	CS6-06, TAG660-600, TIC116M		
S0810NH	TAG	50Hz-Thy 5.1A, 800V, 0.025A, 2V	B-91	CS6-08, TAG660-800, TIC116N		
S0817BH		80A, 200V	B-9			
S0817DH		80A, 400V	B-9			
S0817MH		80A, 600V	B-9			
S0817NH		80A, 800V	B-9			
S1001L	TCE	1.6A, 100V, 0.01A, 1.5V	B-91	ECC5417, MCR106-3		

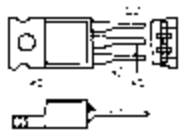



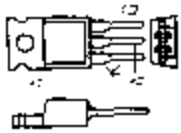
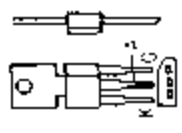
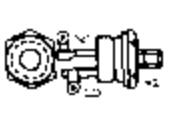

器件型号 Element type	厂名 Manufacturers	材料用途参数 Material Purpose Parameter	图号 Figure	国内外相似替换器件型号 Replace of similar type	备注 Notes	外形参考图 Reference stage
S1001LS1	TCE	1.6A, 100V, 50 μ A, 0.8V		ECG5426, MCR106-3		
S1001LS2	TCE	1.6A, 100V, 200 μ A, 0.8V		ECG5426, MCR106-3		
S1001LS3	TCE	1.6A, 100V, 200 μ A, 0.8V		ECG5426, SK3954, SK5414, MCR106-3		
S1001M	TCE	1.6A, 100V, 0.01A, 1.5V	B-91	ECG5408, SK3577, 2N1596		
S1001MS1	TCE	1.6A, 100V, 50 μ A, 0.8V	B-51	2N4214		
S1001MS2	TCE	1.6A, 100V, 200 μ A, 0.8V	B-51	2N2324		
S1001MS3	TCE	1.6A, 100V, 200 μ A, 0.8V	B-51	MCR1906-3, MCR1906-3		
S1003L	TCE	3A, 100V, 0.01A, 1.5V	B-91	ECG5417, MCR106-3		
S1003LS1	TCE	3A, 100V, 50 μ A, 0.8V	B-91	ECG5426, MCR106-3		
S1003LS2, S3	TCE	3A, 100V, 200 μ A, 0.8V	B-91	ECG5426, MCR106-3		
S1003MS1	TCE	3A, 100V, 50 μ A, 0.8V	B-51			
S1003MS2	TCE	3A, 100V, 200 μ A, 0.8V	B-51	2N6238		
S1003MS3	TCE	3A, 100V, 200 μ A, 0.8V	B-51	2N6238		
S1004F1	TCE	4A, 100V, 0.01A, 1.5V	B-91			
S1005BH	TAG	50Hz-Thy 6.4A, 200V, 0.005A, 2V	B-91	TAG666-200, TG667-200		
S1005DH	TAG	50Hz-Thy 6.4A, 400V, 0.005A, 2V	B-91	TAG666-400, TG667-400		
S1005MH	TAG	50Hz-Thy 6.4A, 600V, 0.005A, 2V	B-91	TAG666-600, TG667-600		
S1005NH	TAG	50Hz-Thy 6.4A, 800V, 0.005A, 2V	B-91	TAG666-800, TG667-800		
S1006BH		100A, 200V	B-9			
S1006DH		100A, 400V	B-9			
S1006F1	TCE	6A, 100V, 0.015A, 1.5V	B-91			
S1006FS21	TCE	6A, 100V, 200 μ A, 0.8V	B-89	MCR72-3		
S1006FS31	TCE	6A, 100V, 500 μ A, 0.8V	B-89	MCR72-3		
S1006L	TCE	6A, 100V, 0.015A, 1.5V	B-91	ECG5417, SK3686, SK5462, S2800A		
S1006LS2	TCE	6A, 100V, 200 μ A, 0.8V	B-91	ECG5426, MCR72-3		
S1006LS3		8A, 100V	B-9			
S1006MH		100A, 600V	B-9			
S1006NH		100A, 800V	B-9			

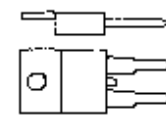
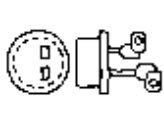
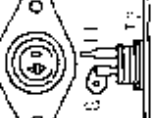

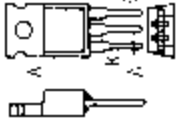
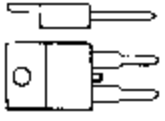
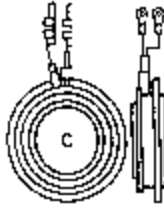
器件型号 Element type	厂名 Manufacturers	材料用途参数 Material Purpose Parameter	图号 Figure	国内外相似替换器件型号 Heplace of similar type	备注 Notes	外形参考图 Reference shape
S1007BH	TAG	50Hz-Thy 6.4A, 200V, 0.01A, 2V	B-91	TAG666-200, TG667-200		 图 B-91
S1007DH	TAG	50Hz-Thy 6.4A, 400V, 0.01A, 2V	B-91	TAG666-400, TG667-400		
S1007MH	TAG	50Hz-Thy 6.4A, 600V, 0.01A, 2V	B-91	TAG666-600, TG667-600		
S1007NH	TAG	50Hz-Thy 6.4A, 800V, 0.01A, 2V	B-91	TAG666-800, TG667-800		
S1008F1	TCE	8A, 100V, 0.015A, 1.5V	B-89	MCR3000-3		 图 B-89
S1008F3		5A, 50V		MCR3000-3		
S1008FS21	TCE	8A, 100V, 200 μA, 0.8V	B-89	MCR72-3		
S1008FS31	TCE	8A, 100V, 500 μA, 0.8V	B-89	MCR72-3		
S1008L	TCE	8A, 100V, 0.015A, 1.5V	B-91	ECG5417, MCR3000-3, SK3686, SK5462		
S1008LS2	TCE	8A, 100V, 200 μA, 0.8V	B-89	ECG5426, MCR72-3		
S1008LS3	TCE	8A, 100V, 500 μA, 0.8V	B-91	ECG5426, MCR72-3		
S1008R	TCE	8A, 100V, 0.015A, 1.5V	B-91	S2800A		
S1010BH	TAG	50Hz-Thy 6.4A, 200V, 0.025A, 2V	B-91	TAG665-200, TIC126-200, T7.5N200		 图 F-50
S1010DH	TAG	50Hz-Thy 6.4A, 400V, 0.025A, 2V	B-91	TAG665-400, TIC126-400, T7.5N400		
S1010F1	TCE	8A, 100V, 0.015A, 1.5V	B-89	2N6395		
S1010FS21	TCE	10A, 100V, 200 μA, 0.8V	B-89			
S1010FS31	TCE	10A, 100V, 500 μA, 0.8V	B-89			
S1010L	TCE	10A, 100V, 0.015A, 1.5V	B-91	2N6395		
S1010LS2	TCE	10A, 100V, 200 μA, 0.8V	B-89			
S1010LS3	TCE	10A, 100V, 500 μA, 0.8V	B-91			
S1010MH	TAG	50Hz-Thy 6.4A, 600V, 0.025A, 2V	B-91	TAG665-600, TIC126-600, T7.5N600		
S1010NH	TAG	50Hz-Thy 6.4A, 800V, 0.025A, 2V	B-91	TAG665-800, TIC126-800, T7.5N800		
S1012L, R	TCE	12A, 100V, 0.02A, 1.5V	B-91	2N6395		
S1015G, L	TCE	15A, 100V, 0.02A, 1.5V	B-91	ECG5502, ECG5514, SK3513, SK5514, 2N6401		
S1015H	TCE	15A, 100V, 0.02A, 1.5V	F-50	ECG5502		

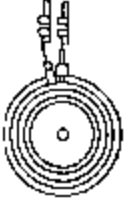

器件型号 Element type	厂名 Manufacturers	材料用途参数 Material Purpose Parameter	图号 Figure	国内外相似替换器件型号 Replace of similar type	备注 Notes	外形参考图 Reference shape
S1016R	TCE	16A, 100V, 0.03A, 1.5V	B-91	2N6401		
S1017BH		16A, 200V	B-9			
S1017DH		16A, 400V	B-9			
S1017MH		16A, 600V	B-9			
S1017NH		16A, 800V	B-9			
S1020L	TCE	20A, 100V, 0.025A, 2V	B-91	ECG5502, 2N6505		
S1025	TCE	25A, 100V, 0.025A, 2V	B-73			
S1025C	TCE	25A, 100V, 0.025A, 2V	D-28	MCR649-3, ECG5534		
S1025D	TCE	25A, 100V, 0.025A, 2V	F-50	ECG5562		
S1025G	TCE	25A, 100V, 0.025A, 2V	B-73	MCR3818-3, SK3615, SK5517		
S1025H	TCE	25A, 100V, 0.025A, 2V	D-28	MCR3896, SK6622, SK5522, ECG5522		
S1025R	TCE	25A, 100V, 0.03A, 1.5V	B-91			
S1035, C, G	TCE	35A, 100V, 0.025A, 2V	B-73	ECG5517, ECG5534, MCR3870, SK3615, SK5517, 2N3870		
S1035D	TCE	35A, 100V, 0.025A, 2V	F-50	C228A3, ECG5542, ECG5562, SK5515, SK6615, 2N3870		
S1035H	TCE	35A, 100V, 0.025A, 2V		ECG5542, SK5515, SK6615,		
S1205BH	TAG	50Hz-Thy 7.7A, 200V, 0.005A, 2V	B-91			
S1205DH	TAG	50Hz-Thy 7.7A, 400V, 0.005A, 2V	B-91			
S1205MH	TAG	50Hz-Thy 7.7A, 600V, 0.005A, 2V	B-91			
S1205NH	TAG	50Hz-Thy 7.7A, 800V, 0.005A, 2V	B-91			
S1206BH		120A, 200V	B-9			
S1206DH		120A, 400V	B-9			
S1206MH		120A, 600V	B-9			
S1206NH		120A, 800V	B-9			
S1207BH	TAG	50Hz-Thy 7.7A, 200V, 0.01A, 2V	B-91			
S1207DH	TAG	50Hz-Thy 7.7A, 400V, 0.01A, 2V	B-91			

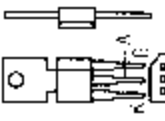
器件型号 Element type	厂名 Manufacturers	材料用途参数 Material Purpose Parameter	图号 Figure	国内外相似替换器件型号 Replace of similar type	备注 Notes	外形参考图 Reference shape
S1207MH	TAG	50Hz-Thy 7.7A, 600V, 0.01A, 2V	B-91			 图 B-91
S1207NH	TAG	50Hz-Thy 7.7A, 800V, 0.01A, 2V	B-91			
S1210BH	TAG	50Hz-Thy 7.7A, 200V, 0.025A, 2V	B-91	TAG680-200, TIC126-200, T7.5N200		
S1210DH	IAG	50Hz-Thy 7.7A, 400V, 0.025A, 2V	B-91	TAG680-400, TIC126-400, T7.5N400		
S1210MH	TAG	50Hz-Thy 7.7A, 600V, 0.025A, 2V	B-91	TAG680-600, TIC126-600, T7.5N600		
S1210NH	TAG	50Hz-Thy 7.7A, 800V, 0.025A, 2V	B-91	TAG680-800, TIC126-800, T7.5N800		
S1217BH		120A, 200V	B-9			 图 B-9
S1217DH		120A, 400V	B-9			
S1217MH		120A, 600V	B-9			
S1217NH		120A, 800V	B-9			
S1610BH	TAG	50Hz-Thy 10A, 200V, 0.025A, 2V	C-50	CS15-02, T9.5N200		 图 C-50
S1610DH	TAG	50Hz-Thy 10A, 400V, 0.025A, 2V	B-91	CS15-01, T9.5N400		
S1610MH	TAG	50Hz-Thy 10A, 600V, 0.025A, 2V	B-91	CS15-06, T9.5N600		
S1610NH	TAG	50Hz-Thy 10A, 800V, 0.025A, 2V	B-91	CS15-08, T9.5N800		
S1612BH	TAG	50Hz-Thy 10A, 200V, 0.05A, 2V	B-91	BS1D1026M, BT152-400R, 2N6506		 图 S
S1612DH	TAG	50Hz-Thy 10A, 400V, 0.05A, 2V	B-91	BS1D1026M, BT152-400R, 2N6507		
S1612MH	TAG	50Hz-Thy 10A, 600V, 0.05A, 2V	B-91	BS1D1040M, BT152-600R, 2N6508		
S1612NH	TAG	50Hz-Thy 10A, 800V, 0.05A, 2V	B-91	BS1D1053M, BT152-800R, 2N6509		
S1616BH		160A, 200V	B-9			 图 S
S1616DH		160A, 400V	B-9			
S1616MH		160A, 600V	B-9			
S1616NH		160A, 800V	B-9			
S2001L	TCE	1.6A, 200V, 0.01A, 1.5V	B-91	EGG5417, MCR106-4		

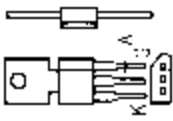
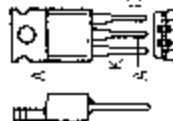
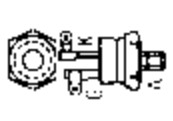
器件型号 Element type	厂名 Manufacturers	材料用途参数 Material Purpose Parameter	图号 Figure	国内外相似替换器件型号 Replace of similar type	备注 Notes	外形参考图 Reference shape
S2001LS1	TCE	1.6A, 200V, 50 μ A, 0.8V		ECG5426, MCR106-4		 图 C-50
S2001LS2	TCE	1.6A, 200V, 200 μ A, 0.8V		ECG5426, MCR106-4		
S2001LS3	TCE	1.6A, 200V, 500 μ A, 0.8V	C-50	ECG5426, MCR106-4, SK3954, SK5414		
S2001M	TCE	1.6A, 200V, 0.01A, 1.5V	B-51	ECG5408, SK3577, 2N1597		
S2001MS1	TCE	1.6A, 200V, 50 μ A, 0.8V	B-51	2N4216		
S2001MS2	TCE	1.6A, 200V, 200 μ A, 0.8V	B-51	2N2326		
S2001MS3	TCE	1.6A, 200V, 500 μ A, 0.8V	B-51	MCR1906-4		
S2003L	TCE	3A, 200V, 0.01A, 1.5V	B-91	ECG5417, MCR106-4		
S2003LS1	TCE	3A, 200V, 50 μ A, 0.8V	B-91	ECG5426, MCR106-4		
S2003LS2	TCE	3A, 200V, 200 μ A, 0.8V		ECG5426, MCR106-4		
S2003LS3	TCE	3A, 200V, 500 μ A, 0.8V		ECG5426, MCR106-4, SK3954, SK5414		
S2003M	TCE	3A, 200V, 0.01A, 1.5V	B-51	ECG5408, SK3503		 图 B-51
S2003MS1	TCE	3A, 200V, 50 μ A, 0.8V	B-51			
S2003MS2	TCE	3A, 200V, 200 μ A, 0.8V	B-51	2N6239		
S2003MS3	TCE	3A, 200V, 500 μ A, 0.8V	B-51	2N6239		
S2004F1	TCE	4A, 200V, 0.01A, 1.5V	B-91	ECG5455		
S2006F1	TCE	6A, 200V, 0.015A, 1.5V	B-91			
S2006FS21	TCE	6A, 200V, 200 μ A, 0.8V	B-89	MCR72-4		
S2006FS31	TCE	6A, 200V, 500 μ A, 0.8V	B-89	MCR72-4		
S2006L	TCE	6A, 200V, 0.015A, 1.5V	B-91	ECG5417, SK3502, SK5513, S2800B		
S2006LS2	TCE	6A, 200V, 200 μ A, 0.8V	B-91	ECG5426, MCR72-4		
S2006LS3	TCE	6A, 200V, 500 μ A, 0.8V	B-91	ECG5426, MCR72-4		 图 B-89
S2008F1	TCE	8A, 200V, 0.015A, 1.5V	B-89			
S2008F3		5.1A, 200V		2N4442		
S2008FS21	TCE	8A, 200V, 200 μ A, 0.8V	B-89	MCR72-4		



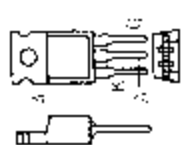
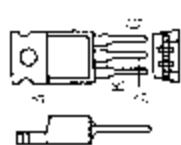
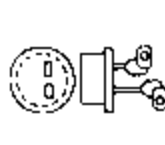

器件型号 Element type	厂名 Manufacturers	材料 用途 参数 Material Purpose Parameter	图号 Figure	国内外相似替换器件型号 Replace of similar type	备注 Notes	外形参考图 Reference shape
S2008FS31	TCE	8A, 200V, 500 μ A, 0.8V	B-89	MCR72-4		 图 B-89
S2008L	TCE	8A, 200V, 0.015A, 1.5V	B-91	ECG5417, SK3572, SK5463		
S2008LS2	TCE	8A, 200V, 200 μ A, 0.8V	B-91	ECG5426, MCR72-4		
S2008LS3	TCE	8A, 200V, 500 μ A, 0.8V	B-91	ECG5426, MCR72-4		
S2008F	TCE	8A, 200V, 0.015A, 1.5V	B-91	S2800B		
S2010F-1	ICE	8A, 200V, 0.015A, 1.5V	B-89			 图 B-91
S2010FS21	TCE	10A, 200V, 200 μ A, 0.8V	B-89			
S2010FS31	TCE	10A, 200V, 500 μ A, 0.8V	B-89			
S2010L	TCE	10A, 200V, 0.015A, 1.5V	B-91	ECG5417, 2N6396		
S2010LS2	TCE	10A, 200V, 200 μ A, 0.8V	B-91	ECG5426		
S2010LS3	TCE	10A, 200V, 500 μ A, 0.8V	B-91	ECG5426		
S2012BH	TCE	50Hz-Thy 13A, 200V, 0.05A, 2.5V	B-91	2N6506		 图 B-91
S2012DH	TCE	50Hz-Thy 13A, 400V, 0.05A, 2.5V	B-91	2N6507		
S2012L	TCE	12A, 200V, 0.02A, 1.5V	B-91	2N6396		
S2012MH	TCE	50Hz-Thy 13A, 600V, 0.05A, 2.5V	B-91	2N6508		
S2012NH	TCE	50Hz-Thy 13A, 800V, 0.05A, 2.5V	B-91	2N6509		
S2012R	TCE	12A, 200V, 0.02A, 1.5V	B-91	2N6396		
S2014BH	TCE	50Hz-Thy 13A, 200V, 0.075A, 2.5V	B-91			 图 F-50
S2014DH	TCE	50Hz-Thy 13A, 400V, 0.075A, 2.5V	B-91			
S2014MH	TCE	50Hz-Thy 13A, 600V, 0.075A, 2.5V	B-91			
S2014NH	TCE	50Hz-Thy 13A, 800V, 0.075A, 2.5V	B-91			
S2015G	TCE	15A, 200V, 0.02A, 1.5V	B-91	ECG5514, SK3613, SK5514		
S2015H	TCE	15A, 200V, 0.02A, 1.5V	F-50	ECG5504		
S2015L	TCE	15A, 200V, 0.02A, 1.5V	B-91	ECG5552, 2N6402		
S2016R	TCE	16A, 200V, 0.03A, 1.5V	B-91	2N6402		

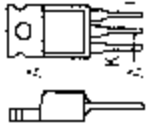

元件型号 Element type	厂名 Manufacturers	材料用途参数 Material Purpose Parameter	图号 Figure	国内外相似替换器件型号 Replace of similar type	备注 Notes	外形参考图 Reference shape
S2020L	TCE	20A, 200V, 0.025A, 2V	B-91	ECG5552, 2N6506		
S2025	TCE	25A, 200V, 0.025A, 2V	B-73	ECG5920		
S2025C	TCE	25A, 200V, 0.025A, 2V	D-28	MCR649-4, ECG5534		
S2025D	TCE	25A, 200V, 0.025A, 2V	F-50	ECG5562		
S2025G	TCE	25A, 200V, 0.025A, 2V	B-73	ECG5517, MCR3818-4, SK3615, SK5517, 2N3871		
S2025H	TCE	25A, 200V, 0.025A, 2V	F-50	ECG5524, MCR3897, SK3505, SK5524, SK5547, SK6624, 2N3897		
S2025R	TCE	15A, 200V, 0.03A, 1.5V	B-91			
S2035	TCE	35A, 200V, 0.025A, 2V	B-73	ECG5920		
S2035C	TCE	35A, 200V, 0.025A, 2V	B-73	ECG5534		
S2035D	TCE	35A, 200V, 0.025A, 2V	F-50	ECG5562		
S2035G	TCE	35A, 200V, 0.025A, 2V	B-73	ECG5517, MCR3871, SK3615, SK5517		
S2035H	TCE	35A, 200V, 0.025A, 2V	F-50	ECG5543, MCR3897, SK3505, SK5547		
S2060A	RCA	50Hz-Thy 2.75A, 100V, 200 μ A, 0.8V	B-91	ECG5437, SK3570, S1006LS2, TAG623-100, TAG633-100, TIC106A, 2N6238		
S2060B	RCA	50Hz-Thy 2.75A, 200V, 200 μ A, 0.8V	B-91	ECG5437, SK3570, S2006LS2, TAG623-200, TAG633-200, TIC106B, 2N6239		
S2060C	RCA	50Hz-Thy 2.75A, 300V, 200 μ A, 0.8V	B-91	ECG5437, MCR106-5, SK3557, S1006LS2, TAG623-300, TAG633-300, TIC106C		
S2060D	RCA	50Hz-Thy 2.75A, 400V, 200 μ A, 0.8V	B-91	ECG5438, S4006LS2, SK3557, TAG623-400, TAG633-400, TIC106D, 2N6240		
S2060E	RCA	50Hz-Thy 2.75A, 500V, 200 μ A, 0.8V	B-91	ECG5438, MCR106-7, SK3571, TAG623-500, TAG633-500, TIC106E		
S2060F	RCA	50Hz-Thy 2.75A, 50V, 200 μ A, 0.8V	B-91	ECG5437, SK3685, SK5461, S0506LS2, TAG633-100, TIC106F, TIC106M, 2N6237		

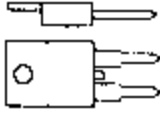
器件型号 Element type	厂名 Manufacturers	材料用途参数 Material Purpose Parameter	图号 Figure	国内外相似替换器件型号 Replace of similar type	备注 Notes	外形参考图 Reference shape
S2060M	RCA	50Hz-Thy 2.75A, 600V, 200 μ A, 0.8V	B-91	ECG5438, SK3571, TAG623-600, TAG633-600, TIC106M, 2N6241		 图 B-91
S2060Q	RCA	50Hz-Thy 2.75A, 15V, 200 μ A, 0.8V	B-91	ECG5437, SK3685, SK5461, S0306LS2, TAG623-100, TAG633-100, TIC106Y, 2N6236		
S2060Y	RCA	50Hz-Thy 2.75A, 30V, 200 μ A, 0.8V	B-91	ECG5437, SK3685, SK5461, TAC623-100, TAG633-100, TIC106Y, 2N6237		
S2061A...Y	RCA	50Hz-Thy =S2060A...Y: 0.0005A	B-91	TAG623... , TAG631... , TIC106A...Y, 2N6238		
S2062A...Y		50Hz-Thy =S2060A...Y: 0.002A		TAG625... , TIC106A...Y, TIC108A...Y, 2N6238		
S2400A	SST	50Hz-Thy 3.3A, 100V, 0.015A	B-50	ECG128, SK3024, SK128, S2620B, TAG607-100		
S2400B	SST	50Hz-Thy 3.3A, 200V, 0.015A	B-50	ECG128, S2006L, S2620B, TAG607-200		
S2400D	SST	50Hz-Thy 3.3A, 400V, 0.015A	B-50	S2620D, S4006L, TAG607-400		
S2400M		50Hz-Thy 3.3A, 600V, 0.015A	B-62	S2620M, TAG607-600		
S2512BK	TAG	130A, 200V, 0.05A, 2V	D-16			
S2512DK	TAG	130A, 400V, 0.05A, 2V	D-16			
S2512MK	TAG	130A, 600V, 0.05A, 2V	D-16			
S2512NK	TAG	130A, 800V, 0.05A, 2V	D-16			
S2514BH		250A, 200V	B-9			
S2514BK	TAG	130A, 200V, 0.075A, 2V	D-16			
S2514DH		250A, 400V	B-9			
S2514DK	TAG	130A, 400V, 0.075A, 2V	D-16			
S2514MH		250A, 600V	B-9			
S2514MK	TAG	130A, 600V, 0.075A, 2V	D-16			
S2514NH		250A, 800V	B-9			
S2514NK	TAG	130A, 800V, 0.075A, 2V	D-16			
S2516BH		250A, 200V	B-9			

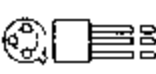
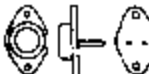

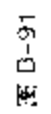
器件型号 Element type	厂名 Manufacturers	材料用途参数 Material Purpose Parameter	图号 Figure	国内外相似替换器件型号 Replace of similar type	备注 Notes	外形参考图 Reference shape
S2516DH		250A, 400V	B-9			
S2516MH		250A, 600V	B-9			
S2516NH		250A, 800V	B-9			
S2600B	RCA	50Hz-Thy 1A, 200V, 0.015A	B-51	C122B1, ECG5408, S2006L, TAG606-200, TAG607-200, TAG612-200		 图 B-9
S2600D	RCA	50Hz-Thy 1A, 400V, 0.015A	B-51	C122D1, ECG5409, S4006L, TAG606-400, TAG607-400, TAG612-400		
S2600M		50Hz-Thy 1A, 600V, 0.015A	B-62	C122M1, TAG606-600, TAG607-600, TAG612-600		
S2600N		50Hz-Thy 1A, 800V, 0.015A	B-62	TAG606-800, TAG607-800, TAG612-800		
S2610B...N		50Hz-Thy =S2600B...N: 2.2A		S2600B, TAG606..., TAG607...		 图 B-51
S2620B...N		50Hz-Thy =S2600B...N: 4.25A	B-62	S2800...		 图 B-62
S2700B		50Hz-Thy 3.2A, 200V, 0.015A	D-9	2N3228		
S2700D		50Hz Thy 3.2A, 400V, 0.015A	D-9	2N3525		
S2700M		50Hz-Thy 3.2A, 600V, 0.015A	D-9	2N4101		
S2710B		50Hz-Thy 3.2A, 200V, 0.015A	D-9	S2800B, 2N3228		
S2710D		50Hz-Thy 3.2A, 400V, 0.015A	D-9	S2800D, 2N3525		
S2710M		50Hz-Thy 3.2A, 600V, 0.015A	D-9	S2800M, 2N4101		 图 D-9
S2800A	RCA	50Hz-Thy 6.8A, 100V, 0.015A	B-91	ECG5462, S1008L, TAG665-100, TIC126A, T7.5N400		
S2800A #	MOT	8A, 100V, 0.015A, 1.5V	B-91			
S2800B	MOT, RCA	50Hz-Thy 6.8A, 200V, 0.015A	B-91	ECG5463, S2008L, TAG665-200, TIC126B, T7.5N400		 图 D-91

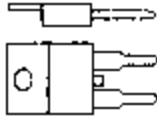
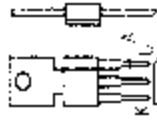
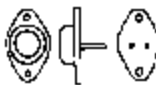
器件型号 Element type	厂名 Manufacturers	材料用途参数 Material Purpose Parameter	图号 Figure	国内外相似替换器件型号 Replace of similar type	备注 Notes	外形参考图 Reference shape
S2800C	RCA	50Hz-Thy 6.8A, 300V, 0.015A	B-91	ECG5465, S4008L, TAG665-400, TIC126C, T7.5N400		 图 B-91
S2800D	RCA	50Hz-Thy 6.8A, 400V, 0.015A	B-91	ECG5465, S4008L, TAG665-400, TIC126D, T7.5N400		
S2800E	RCA	50Hz-Thy 6.8A, 500V, 0.015A	B-91	S6008L, TAG665-500, TIC126E, T7.5N600		
S2800F	RCA	50Hz-Thy 6.8A, 50V, 0.015A	B-91	ECG5461, S0508L, TAG665-100, TIC126F		
S2800M	RCA	50Hz-Thy 6.8A, 600V, 0.015A	B-91	S6008L, TAG665-600, TIC126M, T7.5N800		
S2800N	RCA	50Hz-Thy 6.8A, 800V, 0.015A	B-91	TAG665-800, TIC126N, T7.5N800		
S2800S	RCA	50Hz-Thy 6.8A, 700V, 0.015A	B-91	ECG5468, TAG665-700, TIC126S, T7.5N700		
S3014BH		320A, 800V	B-9			 图 B-9
S3014DH		320A, 1kV	B-9			
S3014MH		320A, 1.2kV	B-9			
S3016BH		320A, 800V	B-9			
S3016DH		320A, 1kV	B-9			
S3016MH		320A, 1.2kV	B-9			 图 B-9
S3060A	RCA	SCR-H 1.8A, 100V, 0.002A	B-89			
S3060B	RCA	SCR-H 1.8A, 200V, 0.002A	B-89			
S3060D	RCA	SCR-H 1.8A, 400V, 0.002A	B-89			
S3060F	RCA	SCR-H 1.8A, 50V, 0.002A	B-89			
S3060M	RCA	SCR-H 1.8A, 600V, 0.002A	B-89			 图 D-9
S3700B	RCA	SCR-H 3.2A, 200V, 0.04A	D-9	ECG5351, S2006L, BRW27S/200, TAG670S-200, T3S400		
S3700D	RCA	SCR-H 3.2A, 400V, 0.04A	D-9	ECG5351, S4006L, BRW27S/400, TAG670S-400, T3S400		



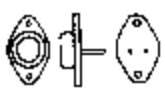

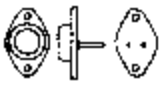
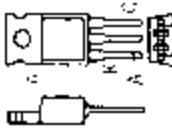
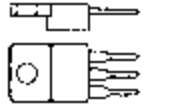
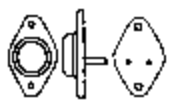
器件型号 Element type	厂名 Manufacturers	材料用途参数 Material Purpose Parameter	图号 Figure	国内外相似替换器件型号 Replace of similar type	备注 Notes	外形参考图 Reference shape
S3700M	RCA	SCR-H 3.2A, 600V, 0.04A	D-9	ECG3351, S6006L, B1W27S/600, TAG670S-600, T3S600		 图 D-9
S3701M S3702S(SF)		SCR-H 5A, 600V, 0.035A SCR-H TV-HA, 3.2A, 700V, 0.045A	D-9 D-9	BS1CC0146R, S6080C, TD3F700H, TD4F700R, TU3F800H TD3F800H, TD4F800H		
S3703SF		SCR-H TV-HA, 3.2A, 750V, 0.032A	D-9			
S3704A S3704B S3704D S3704M S3704S		SCR-H 3.2A, 100V, 0.04A SCR-H 3.2A, 200V, 0.04A SCR-H 3.2A, 400V, 0.04A SCR-H 3.2A, 600V, 0.04A SCR-H 3.2A, 700V, 0.04A	D-9 D-9 D-9 D-9 D-9	BS1CC0126R, S3702S, TD3F400R, TD4F400R BS1CC0126R, S3702S, TD3F400R, TD4F400R BS1CC0126R, S3702S, TD3F400R, TD4F400R BS1CC0140R, S3702S, TD3F600R, TD4F600R BS1CC0146R, S3702S, TD3F700R, TD4F700R		
S3705M	RCA	SCR-H 3.2A, 600V, 0.032A, 4V	D-9	BS1CC0140H, ECG230, S6006L, TD3F600H, TU3F600H		
S3706E	RCA	SCR-H 3.2A, 500V, 0.045A, 4V	D-9	BS1CC0133R, ECG231, S6006L, TD3F500R, TD4F500R		
S3706M S3707SF		SCR H 3.2A, 600V, 0.045A, 4V SCR-H 3.2A, 750V	D-9 D-9	BS1CC0140R, TD3F600R, TD4F600R BS1CC0153H, TD3F800H, TD4F800H, TU3F800H		
S3714A S3714B S3714D S3714M S3714S		SCR-H 3.2A, 100V, 0.04A SCR-H 3.2A, 200V, 0.04A SCR-H 3.2A, 400V, 0.04A SCR-H 3.2A, 600V, 0.04A SCR-H 3.2A, 700V, 0.04A	D-9 D-9 D-9 D-9 D-9	S3704A S3704B S3704D S3704M S3704S		
S3900D		ITR HV-HA, 3.2A, 400V, 0.045A, <math><4.2\mu\text{s}</math>	D-9	BS1CC0126R, S6087A, TD3F400R, TD4F400R		

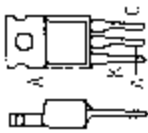
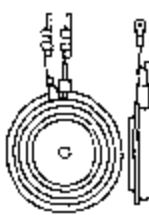
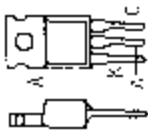
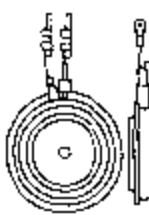
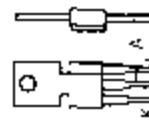
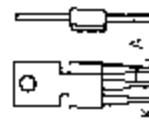
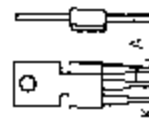

器件型号 Element type	厂名 Manufacturers	材料用途参数 Material Purpose Parameter	图号 Figure	国内外相似替换器件型号 Replace of similar type	备注 Notes	外形参考图 Reference shape
S3800E	ITR	HV-HA, 3.2A, 500V, 0.04A, <2.4 μ s	D-9	BSIC00146R, S6087B, TD3F500R, TD4F500R		 图 D-9
S3800EF	ITR	=S3800D: 550V	D-9	BSIC00140R, S6087A, TD3F600R, TD4F600R		
S3800M	ITR	=S3800D: 600V	D-9	BSIC00140R, S6087A, TD3F600R, TD4F600R		
S3800MF	ITR	=S3800E: 650V	D-9	BSIC00146R, S6087B, TD3F700R, TD4F700R		
S3800S	ITR	=S3800D: 700V	D-9	BSIC00146R, S6087A, TD3F700R, TD4F700R		
S3800SF	ITR	=S3800E: 750V	D-9	BSIC00153R, S6087B, TD3F800R, TD4F800R		
S3900E	RCA	5A, 500V, 0.04A, <2.4 μ s	B-91	BSIC00233H, ECG310P, 17088		 图 B-9
S3900MF	RCA	=S3900E: 650V	B-91	BSIC00246H, ECG310P, 17088		
S3900S	RCA	=S3900E: 700V	B-91	BSIC00246H, ECG310P, 17088		
S3900SF	RCA	=S3900E: 750V	B-91	BSIC00253H, ECG310P, 17088		
S3901M	RCA	5A, 600V, 0.045A, 4V, <4.2 μ s	B-91	BSIC00240H, ECG308P, 17089		
S3901MF	RCA	=S3901E: 650V	B-91	BSIC00246H, ECG308P, 17089		
S3901S	RCA	=S3901E: 700V	B-91	BSIC00246H, ECG308P, 17089		
S3902DF		TV-HA, 5A, 450V, 0.04A, 3 μ s	B-11	BSIC00233H, S3900E, 17088		
S3903MF		TV-HA, 5A, 650V, 0.045A, 5 μ s	B-11	BSIC00246R, S3901MF, 17089		
S4000A		50Hz-Thy 8A, 100V, 0.04A	D-10	2N3666		 图 B-11
S4000B		50Hz-Thy 8A, 200V, 0.04A	D-10	2N3669		
S4000D		50Hz-Thy 8A, 400V, 0.04A	D-10	2N3670		
S4000M		50Hz-Thy 8A, 600V, 0.04A	D-10	2N4103		
S4001L	TCE	1.6A, 400V, 0.01A, 1.5V	B-91	ECG5418, MCR106-6		 图 D-10
S4001LS1	TCE	1.6A, 400V, 50 μ A, 0.8V	B-91	ECG5426, MCR106-6		
S4001LS2	TCE	1.6A, 400V, 200 μ A, 0.8V	B-91	ECG5426, MCR106-6		
S4001LS3	TCE	1.6A, 400V, 500 μ A, 0.8V	B-91	ECG5426, MCR106-6		
S4001M	TCE	1.6A, 400V, 0.01A, 1.5V	B-51	ECG5409, 2N1599		

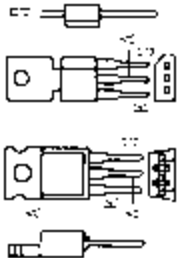
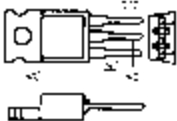
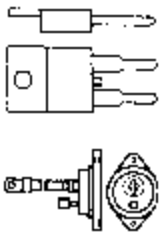
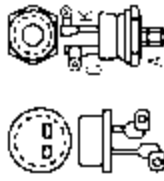

器件型号 Element type	厂名 Manufacturers	材料用途参数 Material Purpose Parameter	图号 Figure	国内外相似替换器件型号 Replace of similar type	备注 Notes	外形参考图 Reference shape
S4001MS1	TCE	1.6A, 400V, 50 μ A, 0.8V	B-51	2N4219		 图 B-51
S4001MS2	TCE	1.6A, 400V, 200 μ A, 0.8V	B-51	2N2329		
S4001MS3	TCE	1.6A, 400V, 500 μ A, 0.8V	B-51	MCR106-6, MCR1906-6		
S4003L	TCE	3.0A, 400V, 0.01A, 1.5V	B-91	EGG5418, MCR106-6		 图 B-91
S4003LS1	TCE	3.0A, 400V, 50 μ A, 0.8V	B-91	EGG5426, MCR106-6		
S4003LS2	TCE	3.0A, 400V, 200 μ A, 0.8V	B-91	EGG5426, MCR106-6		
S4003LS3	TCE	3.0A, 400V, 500 μ A, 0.8V	B-91	EGG5426, MCR106-6		 图 C-50
S4003M	TCE	3.0A, 400V, 0.01A, 1.5V	B-51	EGG5409		
S4003MS1	TCE	3.0A, 400V, 50 μ A, 0.8V	B-51	2N6240		
S4003MS2	TCE	3.0A, 400V, 200 μ A, 0.8V	B-51	2N6240		 图 B-91
S4003MS3	TCE	3.0A, 400V, 500 μ A, 0.8V	B-51	2N6240		
S4004F1	TCE	4A, 400V, 0.01A, 1.5V	B-91	EGG5457		
S4006B	TCE	5A, 400V		MCR729-6		 图 C-50
S4006F1	TCE	6A, 400V, 0.015A, 1.5V	C-50	MCR72-6		
S4006FS21	TCE	6A, 400V, 200 μ A, 0.8V	B-89	MCR72-6		
S4006FS31	TCE	6A, 400V, 500 μ A, 0.8V	B-89	MCR72-6		 图 B-89
S4006L	TCE	6A, 400V, 0.015A, 1.5V	C-50	EGG5418, S2800D		
S4006LS2	TCE	6A, 400V, 200 μ A, 0.8V	B-91	EGG5426, MCR72-6		
S4006LS3	TCE	6A, 400V, 500 μ A, 0.8V	B-91	EGG5426, MCR72-6		 图 B-89
S4008F1	TCE	8A, 400V, 0.015A, 1.5V	C-50	2N4443		
S4008F3	TCE	8A, 400V		2N4443		
S4008FS21	TCE	8A, 400V, 200 μ A, 0.8V	B-89	MCR72-6		 图 B-89
S4008FS31	TCE	8A, 400V, 500 μ A, 0.8V	B-89	MCR72-6		
S4008L	TCE	8A, 400V, 0.015A, 1.5V	B-91	EGG5418, MCR3000-6, SK3687, SK5465		
S4008LS2	TCE	8A, 400V, 200 μ A, 0.8V	B-91	EGG5426, MCR72-6		

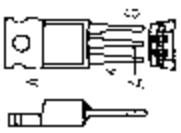
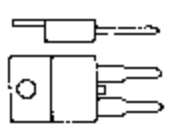
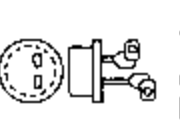
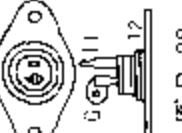
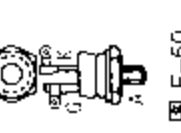
器件型号 Element type	厂名 Manufacturers	材料用途参数 Material Purpose Parameter	图号 Figure	国内外相似替换器件型号 Replace of similar type	备注 Notes	外形参考图 Reference shape
S4008LS3	TCE	8A, 400V, 500 μ A, 0.8V	B-91	ECG5426, MCR72-6		 图 B-91 图 B-89
S4008R	TCE	8A, 400V, 0.015A, 1.5V	B-91	S2800D		
S4010F1	TCE	8A, 400V, 0.015A, 1.5V	B-89			
S4010FS21	TCE	6.4A, 400V, 200 μ A, 0.8V	B-89			 图 B-91
S4010FS31	TCE	6.4A, 400V, 500 μ A, 0.8V	B-89	ECG5418, 2N6397		
S4010L	TCE	10A, 400V, 0.015A, 1.5V	B-91	ECG5426		
S4010LS2	TCE	10A, 400V, 200 μ A, 0.8V	B-91	ECG5426		
S4010LS3	TCE	10A, 400V, 500 μ A, 0.8V	B-91	ECG5426		
S4012BK	TAG	21A, 200V, 0.05A, 2V	D-16			 图 D-16 图 B-9
S4012DK	TAG	21A, 400V, 0.05A, 2V	D-16			
S4012L	TCE	12A, 400V, 0.02A, 1.5V	B-91	2N6397		
S4012MK	TAG	21A, 600V, 0.05A, 2V	D-16			
S4012NK	TAG	21A, 800V, 0.05A, 2V	D-16			
S4012R	TCE	12A, 400V, 0.02A, 1.5V	B-91	2N6397		
S4014BH		380A, 200V	B-9			 图 B-73 图 F-50
S4014BK	TAG	21A, 200V, 0.075A, 2V	D-16			
S4014DH		380A, 400V	B-9			
S4014DK	TAG	21A, 400V, 0.075A, 2V	D-16			
S4014MH		380A, 600V	B-9			
S4014MK	TAG	21A, 600V, 0.075A, 2V	D-16			
S4014NH		380A, 800V	B-9			
S4014NK	TAG	21A, 800V, 0.075A, 2V	D-16			
S4015G	TCE	15A, 400V, 0.02A, 1.5V	B-73	ECG5515		
S4015H	TCE	15A, 400V, 0.02A, 1.5V	F-50	ECG5507		
S4015L	TCE	15A, 400V, 0.02A, 1.5V	B-91	ECG5554, 2N6403		

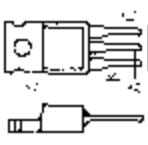
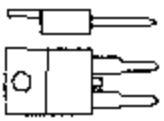
器件型号 Element type	厂名 Manufacturers	材料用途参数 Material Purpose Parameter	图号 Figure	国内外相似替换器件型号 Replace of similar type	备注 Notes	外形参考图 Reference shape
S4016R	TCE	16A, 400V, 0.03A, 1.5V	B-91	2N6403		
S4016BH		380A, 200V	B-9			
S4016DH		380A, 400V	B-9			
S4016MH		380A, 600V	B-9			
S4016NH		380A, 800V	B-9			
S4020L	TCE	20A, 400V, 0.025A, 2V	B-91	2N6507		
S4025	TCE	25A, 400V, 0.025A, 2V	B-73			
S4025C	TCE	25A, 400V, 0.025A, 2V	D-28	MCR649-6, ECG5534		
S4025D	CEG	25A, 400V, 0.025A, 2V	F-50	ECG5564		
S4025G	TCE	25A, 400V, 0.025A, 2V	B-73	ECG5518, 2N3872		
S4025H	TCE	25A, 400V, 0.025A, 2V	F-50	SK5527, SK6627, 2N3898		
S4025R	CEG	25A, 400V, 0.03A, 1.5V	B-91			
S4035	TCE	35A, 400V, 0.025A, 2V	B-73	ECG5534		
S4035C	TCE	35A, 400V, 0.025A, 2V	B-73	ECG5564		
S4035D	TCE	35A, 400V, 0.025A, 2V	F-50	ECG5518, 2N3872		
S4035G	TCE	35A, 400V, 0.025A, 2V	B-73	ECG5545, SK3505, SK5547, 2N3898		
S4035H	TCE	35A, 400V, 0.025A, 2V	F-50			
S4060A	TCE	50Hz-Thy 10A, 100V, 200 μA, 1.5V	B-91			
S4060B	RCA	50Hz-Thy 10A, 200V, 200 μA, 1.5V	B-91			
S4060C	RCA	50Hz-Thy 10A, 300V, 200 μA, 1.5V	B-91			
S4060D	HCA	50Hz-Thy 10A, 400V, 200 μA, 1.5V	B-91			
S4060E	RCA	50Hz-Thy 10A, 500V, 200 μA, 1.5V	B-91			
S4060F	RCA	50Hz-Thy 10A, 50V, 200 μA, 1.5V	B-91			
S4060M	RCA	50Hz-Thy 10A, 600V, 200 μA, 1.5V	B-91			
S4060N	RCA	50Hz-Thy 10A, 800V, 200 μA, 1.5V	B-91			





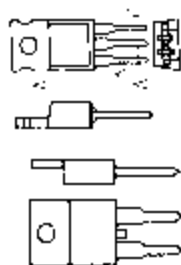
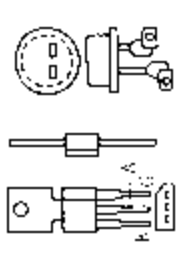
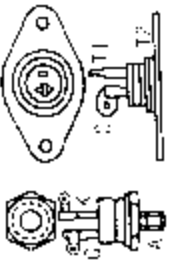
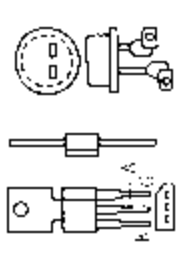
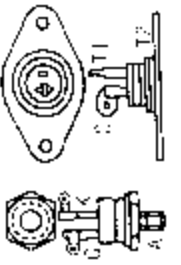
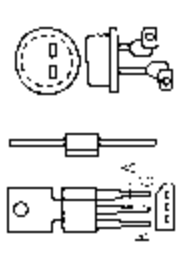
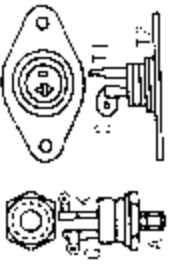

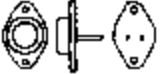
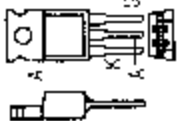
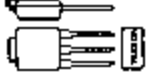
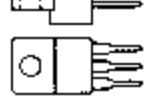
器件型号 Element type	厂名 Manufacturers	材料用途参数 Material Purpose Parameter	图号 Figure	国内外相似替换器件型号 Replace of similar type	备注 Notes	外形参考图 Reference shape
S4060S	RCA	50Hz-Thy 10A, 700V, 200 μ A, 1.5V	B-91			 图 R-91
S4060U	RCA	50Hz-Thy 10A, 25V, 200 μ A, 1.5V	B-91			
S5008L		8A, 600V	B-9	MCR218-8		
S5210B		SCR-H 6.3A, 200V, 0.04A	F-55	C234B, MCR1718-4, TAG15S-200		 图 B-9
S5210D		SCR-H 6.3A, 400V, 0.04A	F-55	C234D, MCR1718-6, TAG15S-400		
S5210M		SCR-H 6.3A, 600V, 0.04A	F-55	C234M, MCR1718-8, TAG15S-600		
S5800B	RCA	SCR-H 3.2A, 200V, 0.05A, 2.5V	B-91	CSF11-02		 图 F-55
S5800C	RCA	SCR-H 3.2A, 300V, 0.05A, 2.5V	B-91	CSF11-04		
S5800D	RCA	SCR-H 3.2A, 400V, 0.05A, 2.5V	B-91	CSF11-04		
S5800E	RCA	SCR-H 3.2A, 500V, 0.05A, 2.5V	B-91	CSF11-06		
S5800M		SCR-H 3.2A, 600V, 0.05A	B-11	CSF11-06		
S5800N		SCR-H 3.2A, 800V, 0.05A	B-11	CSF11-08		
S5800S		SCR-H 3.2A, 700V, 0.05A	B-11	CSF11-08		
S5801B...S		SCR-H =S5800B...S	B-11	S5800B...S		
S5802B...S		SCR-H =S5800B...S	B-11	S5800B...S		
S6000C		50Hz-Thy 12A, 400V, 0.03A	B-9	2N6397		
S6000E		50Hz-Thy 12A, 600V, 0.03A	B-9	2N6398		
S6000S		50Hz-Thy 12A, 800V, 0.03A	B-9	2N6399		
S6001L, M	TCG	1.6A, 600V, 0.01A, 1.5V	B-91	ECG5410, ECG5419, MCR106-8		
S6003L	TCG	3A, 600V, 0.01A, 1.5V	B-91	ECG5419, MCR106 8		
S6003M	TCG	3A, 600V, 0.01A, 1.5V	B-51	ECG5410		
S6004F1	TCG	4A, 600V, 0.01A, 1.5V	B-91	ECG5457		
S6006F1, L	TCG	6A, 600V, 0.015A, 1.5V	B-91	ECG5419, SK3503, S2600M		

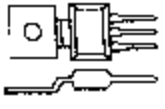
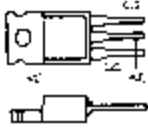
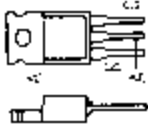
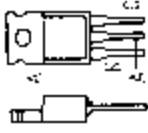
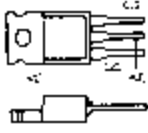
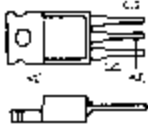
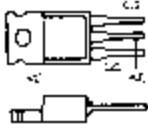
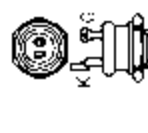
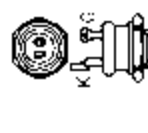
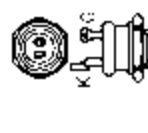
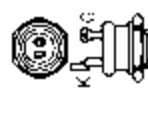
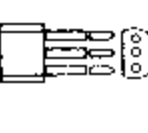
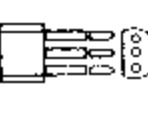
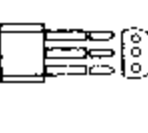
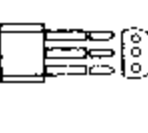

器件型号 Element type	厂名 Manufacturers	材料用途参数 Material Purpose Parameter	图号 Figure	国内外相似替换器件型号 Replace of similar type	备注 Notes	外形参考图 Reference shape
S6008F, F3		8A, 600V	B-9	MCR218-8		 图 B-9
S6008F1		10A, 600V	B-9	S2800M		
S6008L, R	TCG	8A, 600V, 0.015A, 1.5V	B-91	ECG5419, S2800M		
S6010F1	TCG	8A, 600V, 0.015A, 1.5V	B-89			 图 B-89
S6010L	TCG	10A, 600V, 0.015A, 1.5V	B-91	ECG5418, 2N6398		
S6012L	TCG	12A, 600V, 0.02A, 1.5V	B-91	2N6398		 图 B-91
S6012R	TCG	12A, 600V, 0.02A, 1.5V	B-91	2N6398		
S6015G	TCG	15A, 600V, 0.02A, 1.5V	B-73	ECG5516, SK6616, SK5516		 图 B-89
S6015H	TCG	15A, 600V, 0.02A, 1.5V	F-50	ECG5529, SK6629, SK5529		
S6015L	TCG	15A, 600V, 0.02A, 1.5V	B-91	ECG5556		
S6016R	TCG	16A, 600V, 0.03A, 1.5V	B-91			
S6020		12A, 600V	B-9	2N6398		 图 F-50
S6020L	TCG	20A, 600V, 0.025A, 2V	B-91			
S6025	TCG	25A, 600V, 0.035A, 2V	B-73			 图 B-89
S6025C	TCG	25A, 600V, 0.035A, 2V	D-28	ECG5534		
S6025D	TCG	25A, 600V, 0.035A, 2V	F-50	ECG5566, MCR230M3		
S6025H	TCG	25A, 600V, 0.035A, 2V	F-50	ECG5529, SK629, SK5529, 2N3899, 2N690		
S6025R	TCG	25A, 600V, 0.03A, 1.5V	B-91			
S6035, G	TCG	35A, 600V, 0.035A, 2V	B-73	2N3873		 图 F-50
S6035C	TCG	35A, 600V, 0.035A, 2V	D-28	ECG5534		
S6035D	TCG	35A, 600V, 0.035A, 2V	B-91	C228M3, ECG5566, 2N3873		
S6035H	TCG	35A, 600V, 0.035A, 2V	F-50	ECG5547, SK3505, SK5547, 2N3899		



器件型号 Element type	厂名 Manufacturers	材料用途参数 Material Purpose Parameter	图号 Figure	国内外相似替换器件型号 Replace of similar type	备注 Notes	外形参考图 Reference shape
S6080A	TOS	SCR-H 3.2A, 700V, 0.045A, 4V, 0.1A	D-9	BSIC00146R, ECG231, SK3857, SK231, TD3F700R, TD4F700R		 图 D-9
S6080B	TOS	SCR-H 3.2A, 750V, 0.03A, 4V, 0.1A	D-9	BSIC00153H, ECG231, SK3042/230, TU3F900H, TD3F800R, TD4F800R		
S6080C	TOS	SCR-H 3.2A, 800V, 0.04A, 4V, 0.1A	D-9	BSIC00153R, TD3F800R, TD4F800R		
S6087A(AG)		TV-HA, 5A, 700V, 0.045A, 0.1A	D-9	BSIC00146R, TD3F700R, TD4F700R		
S6087B		TV-HA, 5A, 750V, 0.03A, 0.1A	D-9	BSIC00153H, TD3F800H, TD4F800H		
S6087F, J		TV-HA, 5A, 700V, 0.1A	D-9	BSIC00153H, TD3F800H, TD4F800H		
S6089	TOS	SCR-H 3A, 400V, 0.04A, 3V	D-9	BTW27S/400R, ECG230, SK3042/230, S3700D, T3S400MPC		 图 B-91
S6095	TOS	4.7A, 400V, 0.05A, 3V, 0.12A	B-91	BT153, CSF0.7-0.4, S5800D		
S6098	TOS	SCR-H 2.5A, 400V, 0.05A, 3V, 0.12A	B-78	S6111		
S6100C		50Hz-Thy 16A, 400V	B-9	2N6403		
S6100E		50Hz-Thy 16A, 500V	B-11	2N6404		
S6100S		50Hz-Thy 16A, 800V	B-9	2N6405		
S6111	TOS	SCR-H 4A, 400V, 0.05A, 3V	B-78			 图 B-78
S6131D		Triac 10A, 200V, 0.06A	B-11	MAC15-4, SC146B, TIC236B, TW9N400		
S6131G		Triac 10A, 400V, 0.06A	B-11	MAC15-6, SC146D, TIC236D, TW9N400		
S6132A		ITR TV-HA, 3.2A, 700V, 0.045A	D-9	BSIC00146R, S6087A, TD3F700R, TD4F700R		
S6132B		ITR TV-HA, 3.2A, 500V, 0.03A	D-9	BSIC00133H, S6087B, TD3F500H, TD4F500H		
S6134A		SCR-H TV-HA, 3.2A, 700V, 0.045A	D-9	BSIC00146R, S6080C, TD3F700R, TD4F700R		
S6134B		SCR-H TV-HA, 3.2A, 500V, 0.03A	D-9	BSIC00133H, S3705M, TD3F500H, TD4F500H		 图 B-11

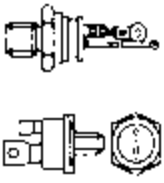
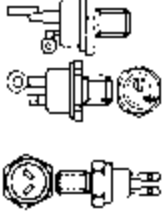
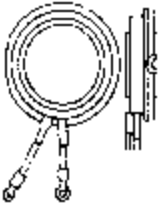

器件型号 Element type	厂名 Manufacturers	材料用途参数 Material Purpose Parameter	图号 Figure	国内外相似替换器件型号 Hoplace of similar type	备注 Notes	外形参考图 Reference shape
S6146, G	TOS	SCR-H 1.3A, 400V, 0.05A, 3V	B-21	BS1C0726T, S6098, S6111		 图 B-21
S6192F	TOS	SCR-H 3A, 300V, 0.04A, 1.8V	B-91	RT153, S5800C, TAG650S-400		 图 B-91
S6192G	TOS	SCR-H 3A, 400V, 0.04A, 1.8V	B-91	BT153, S5800D, TAG650S-400		 图 B-91
S6200A	MOT, RCA	50Hz-Thy 12.5A, 100V, 0.015A, 2V	C-85	BS1D4026MM, C232A, ECG5514, SK3613, SK5514, S1025G		 图 B-91
S6200B	MOT, RCA	50Hz-Thy 12.5A, 200V, 0.015A, 2V	C-85	BS1D4026MM, C232B, ECG5514, MCR6200D, SK3613, SK5514, S2025G		 图 B-91
S6200D	MOT, RCA	50Hz-Thy 12.5A, 400V, 0.015A	C-85	BS1D4026MM, C232D, MCR6200M		 图 B-91
S6200M	MOT, RCA	50Hz-Thy 12.5A, 600V, 0.015A, 2V	C-85	BS1D4040MM, C232M, ECG5516, SK6616, SK5516, S6025G		 图 B-91
S6210A	MOT, RCA	20A, 100V, 0.015A, 2V	F-21	SK3579, SK5504, S1025H		 图 F-21
S6210B	MOT, RCA	20A, 200V, 0.015A, 2V	F-21	SK3579, SK5504, S2025H		 图 F-21
S6210D	MOT, RCA	20A, 400V, 0.015A, 2V	F-21	SK3580, SK5507, S4025H		 图 F-21
S6210M	MOT, RCA	20A, 600V, 0.015A, 2V	F-21	SK3504, SK5508, S6025H		 图 F-21
S6220A	MOT, RCA	20A, 100V, 0.015A, 2V	F-57	S1025V		 图 F-57
S6220B	MOT, RCA	20A, 200V, 0.015A, 2V	F-57	S1025V		 图 F-57
S6220D	MOT, RCA	20A, 400V, 0.015A, 2V	F-57	S4025V		 图 F-57
S6220M	MOT, RCA	20A, 600V, 0.015A, 2V	F-57	S6025V		 图 F-57
S6370		1A, 400V	B-36			 图 B-36
S6400N		50Hz-Thy 25A, 800V, 0.04A	D-14	MCR65-10		 图 D-14
S6410N		50Hz-Thy 25A, 800V, 0.04A	F-55	C35N, MCR3935-10, TAG35-800, 2N5205		 图 F-55
S6420A	RCA	50Hz-Thy 22A, 100V, 0.04A, 2V	F-49	ECG5562, MCR65-3, S1035D, 2N6171		 图 F-49
S6420B	RCA	50Hz-Thy 22A, 200V, 0.04A, 2V	F-49	ECG5562, MCR65 4, SK3655, SK5562, 2N6172		 图 F-49

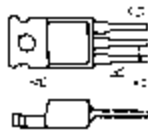
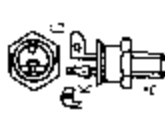

器件型号 Element type	厂名 Manufacturers	材料用途参数 Material Purpose Parameter	图号 Figure	国内外相似替换器件型号 Replace of similar type	备注 Notes	外形参考图 Reference shape
S6420D	RCA	50Hz Thy 22A, 400V, 0.04A, 2V	F-49	MCR65-6, S4035D, 2N6173		
S6420M	RCA	50Hz-Thy 22A, 600V, 0.04A, 2V	F-49	ECG5566, MCR65-8, SK3657, SK5568, 2N6174		
S6420N		50Hz-Thy 35A, 800V, 0.04A	E-8	MCR65-10		
S6431M		50Hz-Thy 35A, 600V, 0.08A	F-55	BTW48-400, TAG24N600, T17N600, T24N600		
S6493M	RCA	50Hz-Thy 35A, 600V, 0.08A, 2V	F-48	BTW48-600, S6035H, TAG24N600, T17N600, T24N600		
S6744		1A, 400V	C-35			
S6785G		3A, 400V				
S6903G		20A, 400V	B-9			
S6903J		20A, 600V	B-9			
S7310B	RCA	SCR-H 25A, 200V, 0.08A, 3V	F-48	T24F200B, T24F200C		
S7310C	RCA	SCR-H 25A, 300V, 0.08A, 3V	F-48	T24F400B, T24F400C		
S7310D	RCA	SCR-H 25A, 400V, 0.08A, 3V	F-48	T24F400B, T24F400C		
S7310E	RCA	SCR-H 25A, 500V, 0.08A, 3V	F-48	T24F600B, T24F600C		
S7310M	RCA	SCR-H 25A, 600V, 0.08A, 3V	F-48	T24F600B, T24F600C		
S7310N	RCA	SCR-H 25A, 800V, 0.08A, 3V	F-48	T24F800B, T24F800C		
S7410M	RCA	25A, 600V, 0.18A, 3V	F-48	ECG5360		
S7412M	RCA	25A, 600V, 0.18A, 3V	F-48	ECG5360		
S7502		50Hz-Thy 0.3A, 250V, 200 μA	B-35	BRY55-300, MCR100-5, TAG70D, TAG72D		
S7503		50Hz-Thy 0.3A, 300V, 200 μA	B-35	BRY55-300, MCR100-5, TAG70D, TAG72D		

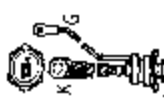

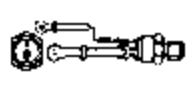

器件型号 Element type	厂名 Manufacturers	材料用途参数 Material Purpose Parameter	图号 Figure	国内外相似替换器件型号 Replace of similar type	备注 Notes	外形参考图 Reference shape
S8015L	TCE	15A, 800V, 0.03A, 2V	B-91	ECG5558, 2N6405		
S8016R	TCE	16A, 800V, 0.03A, 1.5V	B-91	2N6405		
S8020L	TCE	20A, 800V, 0.03A, 2V	B-91	ECG5558, 2N6509		
S8025R	TCE	25A, 800V, 0.03A, 1.5V	B-91	2N6509		
SC10C20	SEM	10A, 200V, 0.04A, 3V	D-19			
SC10C30	SEM	10A, 300V, 0.04A, 3V	D-19			
SC10C40	SEM	10A, 400V, 0.04A, 3V	D-19			
SC10C50	SEM	10A, 500V, 0.04A, 3V	D-19			
SC10C60	SEM	10A, 600V, 0.04A, 3V	D-19			
SC10C80	SEM	10A, 800V, 0.04A, 3V	D-19			
SC10C100	SEM	10A, 1kV, 0.04A, 3V	D-19			
SC10C120	SEM	10A, 1.2kV, 0.04A, 3V	D-19			
SC16C10J	SEM	16A, 100V, 0.05A, 3V	F-36			
SC16C20, 20J	SEM	16A, 200V, 0.05A, 3V	F-36			
SC16C30	SEM	16A, 300V, 0.04A, 3V	F-36			
SC16C30J	SEM	16A, 300V, 0.05A, 3V	F-36			
SC16C40	SEM	16A, 400V, 0.04A, 3V	F-36			
SC16C40J	SEM	16A, 400V, 0.05A, 3V	F-36			
SC16C50	SEM	16A, 500V, 0.04A, 3V	F-36			
SC16C50J	SEM	16A, 500V, 0.05A, 3V	F-36			
SC16C60	SEM	16A, 600V, 0.04A, 3V	F-36			
SC16C60J	SEM	16A, 600V	F-36			
SC16C80	SEM	16A, 800V, 0.04A, 3V	F-36			
SC16C100	SEM	16A, 1kV, 0.04A, 3V	F-36			
SC16C120	SEM	16A, 1.2kV, 0.04A, 3V	F-88			

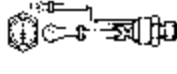
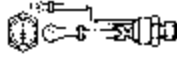
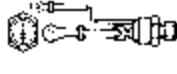
器件型号 Element type	厂名 Manufacturers	材料用途参数 Material Purpose Parameter	图号 Figure	国内外相似替换器件型号 Replace of similar type	备注 Notes	外形参考图 Reference shape
SC20C10J	SEM	SCR-H 20A, 100V, 0.07A, 3V	F-36			 图 F-36
SC20C20	SEM	SCR-H 20A, 200V, 0.05A, 3V	F-36			
SC20C20J	SEM	SCR-H 20A, 200V, 0.07A, 3V	F-36			
SC20C30, 30J	SEM	SCR-H 20A, 300V, 0.05A, 3V	F-36			
SC20C40, 40H	SEM	SCR-H 20A, 400V, 0.05A, 3V	F-36			
SC20C40J		SCR-H 20A, 400V	F-36			
SC20C50, 50H	SEM	SCR-H 20A, 500V, 0.05A, 3V	F-36			
SC20C50J		SCR-H 20A, 500V	F-36			
SC20C60	SEM	SCR-H 20A, 600V, 0.05A, 3V	F-36			
SC20C60H		SCR-H 20A, 600V	F-36			
SC20C60J		SCR-H 20A, 600V	F-36			
SC20C70	SEM	RCT 20A, 700V, 0.12A, 2.2V	F-36			
SC20C70H		SCR-H 20A, 700V	F-36			
SC20C80	SEM	SCR-H 20A, 800V, 0.05A, 3V	F-36			
SC20C90	SEM	RCT 20A, 900V, 0.12A, 2.2V	F-36			
SC20C100	SEM	SCR-H 20A, 1KV, 0.05A, 3V	F-36			
SC20C120	SEM	SCR-H 20A, 1.2KV, 0.05A, 3V	F-36			
SC30C10J		SCR-H 30A, 100V	F-36			 图 F-64
SC30C20	SEM	SCR-H 30A, 200V, 0.05A, 3V	F-64			
SC30C20J		SCR-H 30A, 200V	F-36			
SC30C30	SEM	SCR-H 30A, 300V, 0.05A, 3V	F-64			
SC30C30J		SCR-H 30A, 300V	F-36			
SC30C40	SEM	SCR-H 30A, 400V, 0.05A, 3V	F-64			
SC30C40J		SCR-H 30A, 400V	F-36			
SC30C50	SEM	SCR-H 30A, 500V, 0.05A, 3V	F-64			
SC30C50J		SCR-H 30A, 500V	F-36			
SC30C60	SEM	SCR-H 30A, 600V, 0.05A, 3V	F-64			
SC30C60J		SCR-H 30A, 600V	F-36			

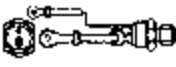
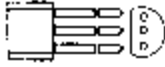

器件型号 Element type	厂名 Manufacturers	材料用途参数 Material Purpose Parameter	图号 Figure	国内外相似替换器件型号 Replace of similar type	备注 Notes	外形参考图 Reference shape
SC30C80	SEM	SCR-H 30A, 800V, 0.05A, 3V	F-64			 图 F-64
SC30C100	SEM	SCR-H 30A, 1kV, 0.05A, 3V	F-64			
SC30C120	SEM	SCR-H 30A, 1.2kV, 0.05A, 3V	F-36			
SC40-80		40A, 800V	B-36			 图 F-64
SC40-100		40A, 1kV	B-36			
SC40-120		40A, 1.2kV	B-36			
SC40C20	SEM	40A, 200V, 0.07A, 3V	F-27			 图 F-64
SC40C30	SEM	40A, 300V, 0.07A, 3V	F-27			
SC40C40	SFM	40A, 400V, 0.07A, 3V	F-27			
SC40C50	SEM	40A, 500V, 0.07A, 3V	F-27			
SC40C60	SEM	40A, 600V, 0.07A, 3V	F-27			
SC40C80	SEM	40A, 800V, 0.07A, 3V	F-27			
SC40C100	SEM	40A, 1kV, 0.07A, 3V	F-27			
SC40C120	SEM	40A, 1.2kV, 0.07A, 3V	F-27			
SC50C20		50A, 200V				
SC50C30		50A, 300V				
SC50C40		50A, 400V				
SC50C50		50A, 500V				
SC50C60		50A, 600V				
SC50C80		50A, 800V				
SC50C100		50A, 1kV				
SC50C120		50A, 1.2kV				
SC70C20	SEM	70A, 200V, 0.07A, 3V	F-64			 图 F-64
SC70C30	SEM	70A, 300V, 0.07A, 3V	F-64			
SC70C40	SEM	70A, 400V, 0.07A, 3V	F-64			
SC70C50	SEM	70A, 500V, 0.07A, 3V	F-64			

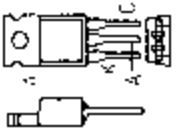
器件型号 Element type	厂名 Manufacturers	材料用途参数 Material Purpose Parameter	图号 Figure	国内外相似替换器件型号 Replace of similar type	备注 Notes	外形参考图 Reference shape
SC70C60	SEM	70A, 600V, 0.07A, 3V	F-64			 图 F-64
SC70C80	SEM	70A, 800V, 0.07A, 3V	F-64			
SC70C100	SEM	70A, 1kV, 0.07A, 3V	F-64			
SC70C120	SEM	70A, 1.2kV, 0.07A, 3V	F-64			
SC70C-10L	SCR-H	70A, 100V	F-64			
SC70C-20L	SCR-H	70A, 200V	F-64			
SC70C-30L	SCR-H	70A, 300V	F-64			
SC70C-40L	SCR-H	70A, 400V	F-64			
SC70C-50L	SCR-H	70A, 500V	F-64			
SC70C-60L	SCR-H	70A, 600V	F-64			
SC92A	GES	0.8A, 100V, 0.01A, 2V	B-36	MAC97A2		
SC92B	GES	0.8A, 200V, 0.01A, 2V	B-36	MAC97A4		
SC92D	GES	0.8A, 400V, 0.01A, 2V	B-36	MAC97A6		 图 B-36
SC92F	GES	0.8A, 50V, 0.01A, 2V	B-36	MAC97A1		
SC100C20	SEM	100A, 200V, 0.1A, 3V	F-76			
SC100C30	SEM	100A, 300V, 0.1A, 3V	F-76			
SC100C40	SEM	100A, 400V, 0.1A, 3V	F-76			
SC100C50	SEM	100A, 500V, 0.1A, 3V	F-76			
SC100C60	SEM	100A, 600V, 0.1A, 3V	F-76			
SC100C80	SEM	100A, 800V, 0.1A, 3V	F-76			
SC100C100	SEM	100A, 1kV, 0.1A, 3V	F-76			
SC100C120	SEM	100A, 1.2kV, 0.1A, 3V	F-76			 图 F-76
SC126A	SEL	12A, 100V, 0.025A	B-91			
SC126B	SEL	12A, 200V, 0.025A	B-91			
SC126C	SEL	12A, 300V, 0.025A	B-91			
SC126D	SEL	12A, 400V, 0.025A	B-91			 图 B-91



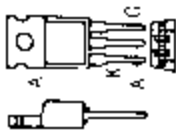
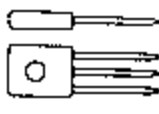
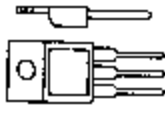

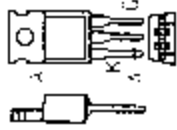
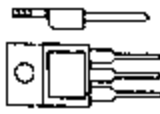
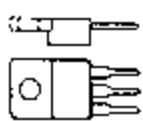
器件型号 Element type	厂名 Manufacturers	材料用途参数 Material Purpose Parameter	图号 Figure	国内外相似替换器件型号 Replace of similar type	备注 Notes	外形参考图 Reference shape
SC126E	SEL	12A, 500V, 0.025A	B-91			 图 B-91
SC126F	SEL	12A, 50V, 0.025A	B-91			
SC126M	SEL	12A, 600V, 0.025A	B-91			
SC129B		SCR-D 25A, 200V		MAC223-4		
SC129D		SCR-D 25A, 400V		MAC223-6		 图 B-6
SC129E		SCR-D 25A, 500V		MAC223-7		
SC129M		SCR-D 25A, 600V		MAC223-8		
SC136B	MOT, NEC	SCR-D 3A, 200V, 0.025A, 2V	B-6	Q2004F4, SC136B, TAG96B, 2N6071, 2N6072, 2N6073, 2N6074, 2N6075		
SC136C	MOT	SCR-D 3A, 300V, 0.025A, 2V	B-6	SC136C, TAG96C, 2N6072, 2N6073, 2N6074, 2N6075		
SC136D	MOT, NEC	SCR-D 3A, 400V, 0.025A, 2V	B-6	Q4004F4, SC136D, TAG96D, 2N6073, 2N6074, 2N6075		
SC136E	MOT	SCR-D 3A, 500V, 0.025A, 2V	B-6	SC136E, TAG96E, 2N6074, 2N6075		
SC136M	MOT	SCR-D 3A, 600V, 0.025A, 2V	B-6	SC136M, TAG96M, 2N6075		
SC140B	GES, NJS	6A, 200V, 0.05A, 2.5V	B-91	ECG5645, Q2006L		 图 B-10
SC140B3, B5, B6	GES	6.5A, 200V, 0.05A, 2.5V	B-10			
SC140D	GES, NJS	6A, 400V, 0.05A, 2.5V	B-91	ECG5645, Q4006L		
SC140D3, D5, D6	GES	6.5A, 400V, 0.05A, 2.5V	B-10			
SC140E	GES, NJS	6A, 500V, 0.05A, 2.5V	B-91	ECG5645, Q5006L		
SC140E3, E5, E6	GES	6.5A, 500V, 0.05A, 2.5V	B-10			
SC140M	GES, NJS	6A, 600V, 0.05A, 2.5V	B-91	ECG5645, Q6006L		
SC140M3, M5, M6	GES	6.5A, 600V, 0.05A, 2.5V	B-10			
SC141B	ASI, GES	SCR-D 6A, 200V, 0.05A, 2.5V	B-91	BS7-02A, ECG56004, MAC216-4, Q2006L, SC141B, SC141B1, SK3658, SK56004, T2801B, TW7N400		

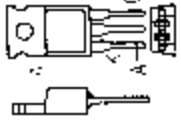
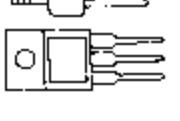

器件型号 Element type	厂名 Manufacturers	材料用途参数 Material Purpose Parameter	图号 Figure	国内外相似替换器件型号 Replace of similar type	备注 Notes	外形参考图 Reference shape
SC141D	ASI, GES	SCR-D 6A, 400V, 0.05A, 2.5V	B-91	BS7-04A, ECG5635, MAC216-6, Q4006L4, SC141D, SC141D1, SK3659, SK56006, T2801D, TW7N400		 图 B-91
SC141E	ASI, GES	SCR-D 6A, 500V, 0.05A, 2.5V	B-91	BS7-05A, ECG56008, MAC216-7, Q5006L, SC141E, SC141E1, SK3660, SK56006, T2801E, TW7N600		
SC141M	ASI, GES	SCR-D 6A, 600V, 0.05A, 2.5V	B-91	BS7-06A, ECG5637, MAC216-8, Q6006L, SC141M, SC141M1, T2801M, TW7N600		
SC141N		Triac 5A, 800V, 0.05A, 2.5V		BTA20N, BTA21N, T2801N, TW7N800		
SC142B	GES, NEC	8A, 200V, 0.05A, 2.5V	B-91	ECG5645, Q2008L		
SC142B3, B5, B6	GES	8A, 200V, 0.05A, 2.5V	B-10			
SC142D	GFS, NEC	8A, 400V, 0.05A, 2.5V	B-91	ECG5645, Q4008L		
SC142D3, D5, D6	GES	8A, 400V, 0.05A, 2.5V	B-10			
SC142E	GES, NEC	8A, 500V, 0.05A, 2.5V	B-91	ECG5645, Q5008L		
SC142E3, E5, E6	GES	8A, 500V, 0.05A, 2.5V	B-10			
SC143B	ASI, GES	SCR-D 8A, 200V, 0.05A, 2.5V	B-91	BT158, BT400, MAC222-4, MAC218A4, Q2008L, T2806B, TIC226B		 图 B-10
SC143D	ASI, GES	SCR-D 8A, 400V, 0.05A, 2.5V	B-91	BT158, BT400, MAC222-6, MAC218A6, Q4008L, T2806D, TIC226D		
SC143E	ASI, GES	SCR-D 8A, 500V, 0.05A, 2.5V	B-91	BT158, BT600, MAC222-7, MAC218A7, Q5008L, T2806E, TIC226E		
SC143F		Triac 8A, 600V, 0.05A, 2.5V	B-11			
SC143M	ASI, GES	SCR-D 8A, 600V, 0.05A, 2.5V	B-91	MAC218A4, Q6008L		 图 B-11
SC146B	ASI, GES	SCR-D 10A, 200V, 0.05A, 2.5V	B-91	ECG5633, Q2010L4, SC146B, SC146B1, SK3938, SK5633, TAG250-200, TIC236B, T2800B, TW9N400, TXD10K40M, 2N6342, 2N6343, 2N6344, 2N6345		

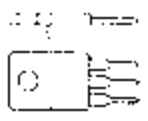
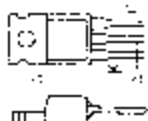
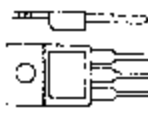

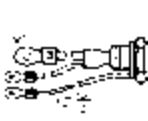
器件型号 Element type	厂名 Manufacturers	材料用途参数 Material Purpose Parameter	图号 Figure	国内外相似替换器件型号 Replace of similar type	备注 Notes	外形参考图 Reference snacc
SC145D	ASI, GES	SCR-D 10A, 400V, 0.05A, 2.5V	B-91	ECG5635, Q4010L4, SC146D, SC146D1, TW9N400, TXD10K40M, 2N6343, 2N6344, 2N6345		 图 B-91
SC146E	ASI, GES	SCR-D 10A, 500V, 0.05A, 2.5V	D-91	Q6010L4ECG5637, SC146E, SC146F1, SK3939, SK5636, TAG250-500, T2800E, TIC236E, TW9N500, TXD10K50M, 2N6344, 2N6345		
SC146M	ASI, GES	SCR-D 10A, 600V, 0.05A, 2.5V	B-91	ECG5637, Q6010L4, SC146M, SC146M1, TW9N500, TXD10K50M, 2N6344, 2N6345		
SC147B	GES, NJS	10A, 200V, 0.05A, 2.5V	B-91	ECG123AP, Q2010L, SK3938, SK5633, TAG480-200		
SC147B3, B5, B6	GES	10A, 200V, 0.05A, 2.5V	B-10			
SC147D	GES, NJS	10A, 400V, 0.05A, 2.5V	B-91	ECG5645, Q4010L, SK3933, SK5635, TAG480-400		
SC147D3, D5, D6	GES	10A, 400V, 0.05A, 2.5V	B-10			
SC147E	GES, NJS	10A, 500V, 0.05A, 2.5V	B-91	ECG5645, Q5010L, SK3939, SK5636, TAG480-506		
SC147E3, E5, E6	GES	10A, 500V, 0.05A, 2.5V	B-10			
SC147M	GES, NJS	10A, 600V, 0.05A, 2.5V	B-91	ECG5645, Q6010L		
SC147M3, M5, M6	GES	10A, 600V, 0.05A, 2.5V	B-10			
SC148B	GES	12A, 200V, 0.05A, 2.5V	B-10	ECG123AP		
SC148D	GES	12A, 400V, 0.05A, 2.5V	B-10			
SC148E	GES	12A, 500V, 0.05A, 2.5V	B-10			
SC148M	GES	12A, 600V, 0.05A, 2.5V	B-10			
SC149B	ASI, GES	SCR-D 12A, 200V, 0.05A, 2.5V	B-91	ECG56004, Q2015L, 2N6342A, TIC236B, TW11N400, 2N6342A, 2N6343A, 2N6344A, 2N6345A		 图 B-10
SC149C	ASI, GES	SCR-D 0.1A, 64V	B-91	ECG56006, Q4015L, 3DG120D		
SC149D	ASI, GES	SCR-D 12A, 400V, 0.05A, 2.5V	B-91	ECG56006, Q4015L, SK3659, SK56006, TAG255-400, TIC236D, TW11N400, 2N6343A, 2N6344A, 2N6345A		

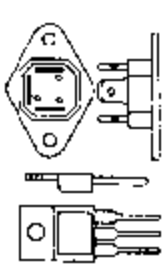

器件型号 Element type	厂名 Manufacturers	材料用途参数 Material Purpose Parameter	图号 Figure	国内外相似替换器件型号 Replace of similar type	备注 Notes	外形参考图 Reference shape
SC149F	NEC	Triac 12A, 500V, 0.05A, 2.5V	B-11	TIC236E, TW11N600, 2N6344A, 2N6345A		 图 B-11:  图 B-91:  图 D-10:  图 F-79:  图 E-22:
SC149F	ASL, GES	SCR-D 12A, 600V, 0.05A, 2.5V	B-91	ECG56008, Q6015L, SK3660, SK56008, TAG255-600, TIC236M, TW11N600, 2N6344A, 2N6345A		
SC150B	GES	150A, 200V, 0.05A, 2.5V	B-10			
SC150C20	GES	SCR-D 150A, 200V, 0.1A, 3V	F-79			
SC150C30	GES	SCR-D 150A, 300V, 0.1A, 3V	F-79			
SC150C40	GES	SCR-D 150A, 400V, 0.1A, 3V	F-79			
SC150C40J	GES	150A, 400V, 0.1A, 3V	E-22			
SC150C50	GES	SCR-D 150A, 500V, 0.1A, 3V	F-79			
SC150C60	GES	SCR-D 150A, 600V, 0.1A, 3V	F-79			
SC150C80	GES	SCR-D 150A, 800V, 0.1A, 3V	F-79			
SC150C100	GES	SCR-D 150A, 1kV, 0.1A, 3V	F-79			
SC150C120	GES	SCR-D 150A, 1.2kV, 0.1A, 3V	F-79			
SC150C200		SCR-H 150A, 200V	F-79			
SC150C300		SCR-H 150A, 300V	F-79			
SC150C400		SCR-H 150A, 400V	F-79			
SC150C500		SCR-H 150A, 500V	F-79			
SC150D	GES	15A, 400V, 0.05A, 2.5V	B-10	ECG56004, MAC15-4, Q2015L, SK3938, SK5633, T6001B, TAG280-200, TIC246B, TXE10L20		
SC150E	GES	15A, 500V, 0.05A, 2.5V	B-10	ECG56006, MAC15-6, Q4015L, SK3659, SK56006, TAG280-400, TIC256D, TXE10L40, T6001D		
SC150M	GES	15A, 600V, 0.05A, 2.5V	B-10	ECG56008, MAC15-8, Q5015L, MAC15-7, SK3939, SK5636, TAG280-500, TIC246E,		
SC151B	GES, NEC	SCR-D 15A, 200V, 0.05A	B-10			
SC151D	GES, NEC	SCR-D 15A, 400V, 0.05A	B 10			
SC151E	GES, NEC	SCR-D 15A, 500V, 0.05A	B-10			

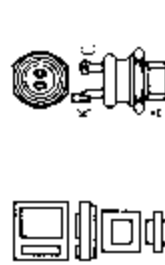
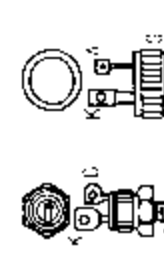

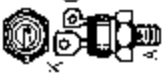



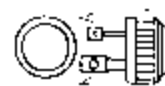







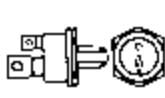
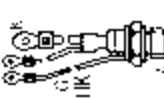

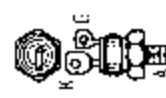
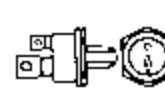

器件型号 Element type	厂名 Manufacturers	材料用途参数 Material Purpose Parameter	图号 Figure	国内外相似替换器件型号 Replace of similar type	备注 Notes	外形参考图 Reference shape
SC151M1	GES, NEC	SCR-D 15A, 600V, 0.05A	B-10	MAC1508, Q6015L, MAC15-8, SK3660, SK56008, T6001M, TAG280-600, TIC27M, TIC245M, TXE10L60		 图 B-10 图 D-31
SC160B	GES	25A, 200V, 0.05A, 2.5V	D-31	EGG56014, MCA525-4, SK3992		
SC160D	GES	25A, 400V, 0.05A, 2.5V	D-31	EGG56014, MCA525-6, Q4025D		
SC160E	GES	25A, 500V, 0.05A, 2.5V	D-31	MCA525-7		
SC160M	GES	25A, 600V, 0.05A, 2.5V	D-31	Q6025D		
SC201CS2	TCE	1.6A, 200V, 200 μA, 0.8V	A-10			
SC204BS2	TCE	4A, 200V, 200 μA, 0.8V	A-10			
SC210BS2	TCE	10A, 200V, 200 μA, 0.8V	A-10			
SC240B	ASI, GES	SCR-D 6A, 200V, 0.05A, 2.5V	F-21	EGG5673, Q2015B, T4121B, 2N5569		 图 A-10 图 F-21
SC240B2	ASI, GES	6A, 200V, 0.05A, 2.5V	F-47	Q2015B, T4121B		
SC240D	ASI, GES	SCR-D 6A, 400V, 0.05A, 2.5V	F-21	EGG5675, Q4015B, T4121D, 2N5570		
SC240D2	GES	6A, 400V, 0.05A, 2.5V	F-47	EGG56024, Q4015B, T4121D		
SC240E	ASI, GES	SCR-D 6A, 500V, 0.05A, 2.5V	F-21	EGG5677, Q5015B, T4111M, T4121E		
SC240E2	GES	6A, 500V, 0.05A, 2.5V	F-47	EGG56026, Q5015B, T4121M		
SC240M	ASI, GES	SCR-D 6A, 600V, 0.05A, 2.5V	F-21	EGG5677, Q6015B, T4121M		
SC241B	ASI, GES	SCR D 6A, 200V, 0.05A, 2.5V	C-85	EGG5688, Q2006, T4121B, 2N5567		 图 F-47 图 C-85
SC241D	SCR-D	10A, 400V		T4101D		
SC241E	ASI, GES	SCR-D 6A, 500V, 0.05A, 2.5V	C-85	EGG5690, Q5006, T4101E, T4101M		
SC241M	ASI, GES	SCR-D 6A, 600V, 0.05A, 2.5V	C-85	EGG5690, Q6006, T4101M		
SC245B	ASI, GES	10A, 200V, 0.05A, 2.5V	F-21	BS10-02A, ECG5673, SK3520, SK5577, T4110E, T4111E, TXD99A20		
SC245B2	GES	10A, 200V, 0.05A, 2.5V	F-47			

器件型号 Element type	厂名 Manufacturers	材料用途参数 Material Purpose Parameter	图号 Figure	国内外相似替换器件型号 Replacc of similar type	备注 Notes	外形参考图 Reference shape
SC245D	ASI, GES	10A, 400V, 0.05A, 2.5V	F-21	BS10-04A, ECG5675, Q4015B, 2N5570, T4110E, T4111E, TXD99A40 ECG56024		 图 F-21
SC245D2	GES	10A, 400V, 0.05A, 2.5V	F-47	ECG56024		
SC245E	ASI, GES	10A, 500V, 0.05A, 2.5V	F-21	BS10-05A, ECG5677, Q5015B, T4111M, T4110E, T4111E, TXD99A50 ECG56026		
SC245E2	GES	10A, 500V, 0.05A, 2.5V	F-47	ECG56026		
SC245M	ASI, GES	10A, 600V, 0.05A, 2.5V	F-21	BS10-06A, ECG5677, Q6015B, T4110M, T4111M, TXD99A60, T4111M		
SC246B	ASI, GES	10A, 200V, 0.05A, 2.5V	C-85	ECG5688, Q2010, 2N5567		
SC246D	ASI, GES	10A, 400V, 0.05A, 2.5V	C-85	ECG5689, Q4010, 2N5568		
SC246E	ASI, GES	10A, 500V, 0.05A, 2.5V	C-85	ECG5690, Q5010, T4101M		
SC246M	ASI, GES	10A, 600V, 0.05A, 2.5V	C-85	ECG5690, Q6010		 图 F-47
SC250B	ASI, GES	SCR-D 15A, 200V, 0.05A, 2.5V	F-21	ECG5673, SC250B, SK3520, SK5677, Q2015H, TXD98A20, TXE99A20, TW18N400, 2N5573		
SC250B2	GES	10A, 200V, 0.05A, 2.5V	F-47	ECG56022, 2N5573 SC250B2		
SC250B3	GES	15A, 200V				
SC250C20		150A, 1.2KV				
SC250C20		250A, 200V				
SC250C30		250A, 300V				
SC250C40		250A, 400V				
SC250D	ASI, GES	SCR-D 15A, 400V, 0.05A, 2.5V	F-21	ECG5675, Q4015H, SC250D, SK3520, SK5677, TW18N400, TXE99A40, TXD98A40, 2N5574		
SC250D2	GES	10A, 400V, 0.05A, 2.5V	F-47	ECG56024 SC250D3		
SC250D3	GES	15A, 400V				
SC250E	ASI, GES	SCR-D 15A, 500V, 0.05A, 2.5V	F-21	ECG5677, Q5015H, SK3520/5677, T4110M, TW18N500, TXD98A50, TXE99A50		
SC250E2	GES	10A, 500V, 0.05A, 2.5V	F-47	ECG56026		
SC250E3	GES	SCR-D 15A, 500V				

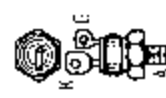
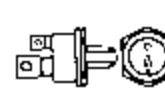

器件型号 Element type	厂名 Manufacturers	材料用途参数 Material Purpose Parameter	图号 Figure	国内外相似替换器件型号 Replace of similar type	备注 Notes	外形参考图 Reference shape
SC250M	ASI, GES	SCR-D 15A, 200V, 0.05A, 2.5V	F-21	Q6015H, TW18N600, TXD98A60, TXE99A60		 图 F-21
SC251B	ASI, GES	SCR-D 15A, 200V, 0.05A, 2.5V	C-85	ECG5688, Q2015G, 2N5571		
SC251D	ASI, GES	SCR-D 15A, 400V, 0.05A, 2.5V	C-85	ECG5689, Q4015G, 2N5572		
SC251E	ASI, GES	SCR-D 15A, 500V, 0.05A, 2.5V	C-85	ECG5690, Q5015G, T4100M		
SC251M	ASI, GES	SCR-D 15A, 600V, 0.05A, 2.5V	C-85	FCG5690, Q6015G		
SC260B	ASI, GES	SCR-D 15A, 200V, 0.05A, 2.5V	F-47	ECG5693, Q2025H, T6411B, TXE99A20, 2N6160, 2N6161, 2N6162		
SC260B2, B3	GES	SCR-D 25A, 200V, 0.05A, 2.5V	F-47	ECG56022		
SC260D, D2, D3	ASI, GES	SCR-D 25A, 400V, 0.05A, 2.5V	F-47	ECG5695, Q2025H, T6411D, TXE99A40, 2N6161, 2N6162, ECG56024, SC260D3		
SC260E, E2, E3	ASI, GES	SCR-D 25A, 500V, 0.05A, 2.5V	F-47	ECG5697, Q5025H, T6411E, TXE99A50, 2N6162, ECG56026, SC260E3		 图 C-85
SC260M, M2, M3	ASI, GES	SCR-D 25A, 600V, 0.05A, 2.5V	F-47	ECG5697, Q6025H, T6411M, TXE99A60, 2N6162, ECG56026		
SC261B	ASI, GES	25A, 200V, 0.05A, 2.5V	F-47	ECG5688, Q2025G		
SC261D	ASI, GES	25A, 400V, 0.05A, 2.5V	F-47	ECG5689, Q4025G		
SC261E	ASI, GES	25A, 500V, 0.05A, 2.5V	F-47	ECG5690, Q5025G		
SC261M	ASI, GES	25A, 600V, 0.05A, 2.5V	F-47	ECG5690, Q6025G		
SC265B, B2, B3	GES	SCR-D 40A, 200V, 0.15A, 2.5V	F-47	ECG5693, Q2040D, 2N5444, ECG56022		
SC265D, D2, D3	GES	SCR-D 40A, 400V, 0.15A, 2.5V	F-47	ECG5695, Q4040D, 2N5445, ECG56024		
SC265E	GES	SCR-D 40A, 600V, 0.15A, 2.5V	F-47	ECG5697, Q5040D		
SC265E2	GES	SCR-D 40A, 600V, 0.15A, 2.5V	F-47	ECG56026		
SC265E3	GES	SCR-D 40A, 600V, 0.15A, 2.5V	F-47	ECG56026		
SC265M	GES	SCR-D 40A, 800V, 0.15A, 2.5V	F-47	ECG56026, ECG5697, Q6040D, 2N5446		
SC265M2	GES	SCR-D 40A, 800V, 0.15A, 2.5V	F-47	ECG56026		
SC265M3	GES	SCR-D 40A, 800V, 0.15A, 2.5V	F-47	ECG56026		 图 F-47

器件型号 Element type	厂名 Manufacturers	材料用途参数 Material Purpose Parameter	图号 Figure	国内外相似替换器件型号 Replace of similar type	备注 Notes	外形参考图 Reference shape
SC266B	GES, NJS	SCR-D 40A, 200V, 0.15A, 2.5V	F-47	ECG5688, Q2040, 2N5441		
SC266D	GES, NJS	SCR-D 40A, 400V, 0.15A, 2.5V	F-47	ECG5689, Q4040		
SC266E	GES, NJS	SCR-D 40A, 600V, 0.15A, 2.5V	F-47	ECG5690, Q5040		
SC266F		SCR-D 40A, 500V	F-47	T6400E		
SC266M	GES, NJS	SCR-D 40A, 800V, 0.15A, 2.5V	F-47	ECG5690, Q6040, 2N5443		
SC300C20	SEM	300A, 200V, 0.1A, 3V	F-49			
SC300C30	SEM	300A, 300V, 0.1A, 3V	E-22			
SC300C40	SEM	300A, 400V, 0.1A, 3V	E-22			
SC300C50	SEM	300A, 500V, 0.1A, 3V	E-22			
SC300C60	SEM	300A, 600V, 0.1A, 3V	E-22			
SC300C80	SEM	300A, 800V, 0.1A, 3V	E-22			
SC300C100	SEM	300A, 1kV, 0.1A, 3V	E-22			
SC300C120	SEM	300A, 1.2kV, 0.2A, 3V	E-22			
SC401CS2	TCE	1.6A, 400V, 200 μA, 0.8A	A-10			
SC404BS2	TCE	4A, 400V, 200 μA, 0.8A	A-10			
SC410BS2	TCE	10A, 400V, 200 μA, 0.8A	A-10			
SC500C-20		500A, 200V				
SC500C-30		500A, 300V				
SC500C-40		500A, 400V				
SC500C-50		500A, 500V				
SC500C-60		500A, 600V				
SCF1500B20	SEM	1.5kA, 200V, 0.3A, 3V	C-39			
SCF1500B30	SEM	1.5kA, 300V, 0.3A, 3V	C-39			
SCF1500B40	SEM	1.5kA, 400V, 0.3A, 3V	C-39			
SCF1500B50	SEM	1.5kA, 500V, 0.3A, 3V	C-39			







器件型号 Element type	厂名 Manufacturers	材料用途参数 Material Purpose Parameter	图号 Figure	国内外相似替换器件型号 Replace of similar type	备注 Notes	外形参考图 Reference shape
SCF1500B60	SEM	1.5kA, 600V, 0.3A, 3V	C-39			
SF0R1B41		50Hz-Thy 0.1A, 100V, 200 μA	B-35	BRY-100, MCR100-3, TAG70D		
SF0R1D41		50Hz-Thy 0.1A, 200V, 200 μA	B-35	BRY-200, MCR100-4, TAG70D		
SF0R1G41		50Hz-Thy 0.1A, 400V, 200 μA	B-35	BRY-400, MCR100-6, TAG70D		
SF0R1A42		50Hz-Thy 0.1A, 50V	B-36			
SF0R1B42	TOS	50Hz-Thy 0.1A, 100V, 200 μA, 0.8V	B-36			
SF0R1D42	TOS	50Hz-Thy 0.1A, 200V, 200 μA, 0.8V	B-36			
SF0R1G42	TOS	50Hz-Thy 0.1A, 400V, 200 μA, 0.8V	B-36			
SF0R3B42		50Hz-Thy 0.3A, 100V, 200 μA	B-36	BRY-100, MCR100-2, TAG70D		
SF0R3D42	TOS	50Hz-Thy 0.3A, 200V, 200 μA, 0.8V	B-36	BRY-200, MCR100-4, TAG70D		
SF0R3G42	TOS	50Hz-Thy 0.3A, 400V, 200 μA, 0.8V	B-36	BRY-400, MCR100-6, TAG70D		
SF0R3J42	TOS	50Hz-Thy 0.3A, 600V, 200 μA, 0.8V	B-36			
SF0R3642		25.5A, 1kV, 0.1A, 1.4V				
SF0R5B43		0.5A, 100V	B-36			
SF0R5D43		0.5A, 200V	B-36			
SF0R5G43		0.5A, 400V	B-36			
SF0R5J43		0.5A, 600V	B-36			
SF1R3...		1.3A, 100-150V, 200 μA	B-98	C106-..., TAG106-...		
SF1B12	TOS	1A, 100V, 0.001A, 0.8V	B-51	SK3503, TAG2-100, TAG614-100		
SF1D12	TOS	1A, 200V, 0.001A, 0.8V	B-51	SK3503, TAG2-200, TAG614-200		
SF1D42C		1A, 200V				
SF1G12	TOS	1A, 400V, 0.001A, 0.8V	B-51	SK3503, TAG2-400, TAG614-400		
SF1G42C		1A, 400V				
SF2B41	TOS	50Hz-Thy 2A, 100V, 200 μA, 0.8V	B-21	TAG633-100, ECC5454, TAG623-100, TIC106A		

图 C-39



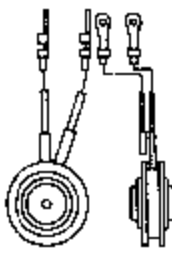
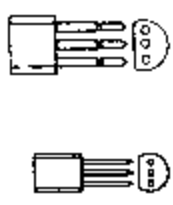
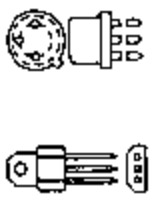
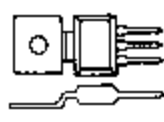
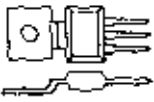
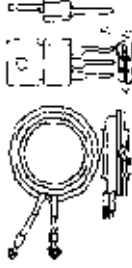

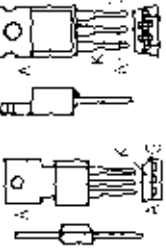

图 B-35 图 B-36



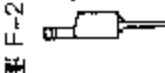

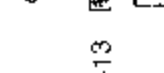
图 D-98 图 B-51





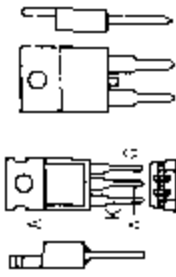
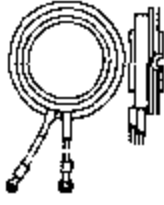
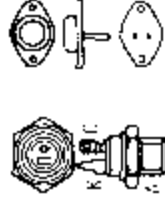

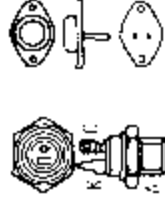















图 B-21

器件型号 Element type	厂名 Manufacturers	材料用途参数 Material Purpose Parameter	图号 Figure	国内外相似替换器件型号 Replace of similar type	备注 Notes	外形参考图 Reference shape
SF2D41	TOS	50Hz-Thy 2A, 200V, 200 μ A, 0.8V	B-21	TAG633-200, ECG5455, TAG623-200, TIC106B		 图 B-21  图 B-88  图 B-35  图 B-89  图 B-87  图 B-91
SF2G41	TOS	50Hz-Thy 2A, 400V, 200 μ A, 0.8V	B-21	TAG633-400, ECG5457, TAG623-400, TIC106D		
SF2J41	TOS	50Hz-Thy 2A, 600V, 200 μ A, 0.8V	C-35	TAG633-600, TAG623-600, TIC106M		
SF2R5B42	TOS	2.5A, 100V, 500 μ A, 1V	B-88			
SF2R5D42	TOS	2.5A, 200V, 500 μ A, 1V	B-88			
SF2R5G42	TOS	2.5A, 400V, 500 μ A, 1V	B-88			
SF3B14		4.7A, 100V, 0.015A, 1.5V	D-9	BSIC0506, TAG671-100, TAG676-100, 2N4101		
SF3B41		3A, 100V, 0.2A, 1.5V	B-9	BT152-400R, BT152-600R, BT152-800R		
SF3B42	TOS	3A, 100V, 0.2A, 1.5V	B-87			
SF3D14		4.7A, 200V, 0.025A, 1.5V	D-9	BSIC0513, ECG5463, TAG671-200, TAG676-200, 2N4101		
SF3D41	TOS	4.7A, 200V, 0.04A, 1.5V	B-91	BT152-400R, BT152-600R, BT152-800R		
3F3D41A		3A, 200V				
SF3D42	TOS	3A, 200V, 200 μ A, 0.8V	B-21			
SF3D42C		3A, 200V				
SF3G14		4.7A, 400V, 0.025A, 1.5V	D-9	BSIC0526, TAG671-400, TAG676-100, 2N4101		
SF3G41	TOS	4.7A, 400V, 0.04A, 1.5V	B-91	BT152-400R, BT152-600R, BT152-800R, SK3687, SK5465		
SF3G41A		3A, 400V				
SF3G42	TOS	3A, 400V, 200 μ A, 0.8V	B-21			
SF3G42C		3A, 400V	B-15			
SF3G48		3A, 400V	C-35			
SF3GZ47		3A, 400V				
SF3J41	TOS	4.7A, 600V, 0.04A, 1.5V	B-91	BT152-400R, BT152-600R, BT152-800R, ECG5466		
SF3J41A		3A, 600V				
SF3J42	TOS	3A, 600V, 200 μ A, 0.8V	B-21			
SF3J48		3A, 600V	C-35			
SF3JZ47		3A, 600V				
SF3L42		3A, 600V	B-15			



器件型号 Element type	厂名 Manufacturers	材料用途参数 Material Purpose Parameter	图号 Figure	国内外相似替换器件型号 Replace of similar type	备注 Notes	外形参考图 Reference shape
SF5B13	TOS	5A, 100V, 0.04A, 2V	F-27	ECG5482		
SF5B14		7.8A, 100V, 0.027A, 1.5V	D-9	BSIC0506, TAG671-100, TAG676-100		
SF5B41	TOS	5A, 100V, 0.04A, 1.5V	B-91	BSID1026, BSID1033M, BSID16, BT152-400R, BT152-600R, BT152-800R, ECG5462		
SF5B42	TOS	5A, 100V, 200 μA, 0.8V	B-91	ECG5483		
SF5D13	TOS	5A, 200V, 0.04A, 2V	F-27	BSIC0513, TAG671-200, TAG676-200		
SF5D14		5A, 200V, 0.04A	D-13	BSID1026, BSID1033M, BT152-400R, BT152-600R, BT152-800R, ECG5463		
SF5D41	TOS	5A, 200V, 0.04A, 1.5V	B-91			
SF5D41A		5A, 200V	B-91			
SF5D42	TOS	5A, 200V, 200 μA, 0.6V	B-91			
SF5F13		5A, 300V	F-38			
SF5G13	TOS	5A, 400V, 0.04A, 2V	F-38	BSIC0526, TAG671-400, TAG676-400		
SF5G14		7.8A, 400V, 0.027A, 1.5V	D-9	BSID1026, BSID1033M, BT152-400R, BT152-600R, BT152-800R, ECG5465		
SF5G41	TOS	5A, 400V, 0.04A, 1.5V	B-91			
SF5G41A		5A, 400V	B-9			
SF5G42	TOS	5A, 400V, 200 μA, 0.8V	B-91			
SF5G48		5A, 400V	C-35	ECG5487		
SF5GZ47		5A, 400V		ECG5487		
SF5J13	TOS	5A, 600V, 0.04A, 2V	F-27	BSID1026, BSID1033M, ECG5466, BT152-400R, BT152-600R, BT152-800R, ECG5466		
SF5J41	TOS	5A, 600V, 0.04A, 1.5V	B-91			
SF5J41A		5A, 600V	B-9			
SF5J42	TOS	5A, 600V, 200 μA, 0.8V	B-91			
SF5J48		5A, 600V	C-35			
SF5JZ47		5A, 600V, 0.04A, 2V	B-18			

器件型号 Element type	厂名 Manufacturers	材料用途参数 Material Purpose Parameter	图号 Figure	国内外相似替换器件型号 Replace of similar type	备注 Notes	外形参考图 Reference shape
SF8B41	TOS	8A, 100V, 0.04A, 1.5V	B-91	BSID1026, BSID1033M, BT152-400R, ECG5462		 图 B-91 图 B-9
SF8D41	TOS	8A, 200V, 0.04A, 1.5V	B-91	BSID1026, BSID1033M, BT152-400R, ECG5463		
SF8G41	TOS	8A, 400V, 0.04A, 1.5V	B-91	BSID1026, BSID1033, BSID1026M, BSID1033M, BT152-600R, ECG5465		
SF8G41A		8A, 400V	B-9			 图 C-35
SF8G48		8A, 400V	C-35			
SF8GZ47		8A, 400V				
SF8J41	TOS	8A, 600V, 0.04A, 1.5V	B-91	BSID1040, BSID1040M, BSID1046, BSID1046M, BT152-800H, ECG5466		 图 F-23 图 D-9
SF8J41A		8A, 600V	B-9			
SF8J48		8A, 600V	C-35			
SF8JZ47		8A, 600V				
SF10B13	TOS	10A, 100V, 0.08A, 3.5V	F-23	ECG5502		 图 F-23 图 D-9
SF10B14		15A, 100V, 0.027A, 1.5V	D-9			
SF10B41	TOS	10A, 100V, 0.01A, 2V	B-91	ECG5504		
SF10D13	TOS	10A, 200V, 0.08A, 3.5V	F-38			 图 F-23 图 D-9
SF10D14		15A, 100V, 0.027A, 1.5V	D-9			
SF10D41	TOS	10A, 200V, 0.04A, 2V	B-91			
SF10D41A		10A, 200V				
SF10F13		10A, 300V	F-38			
SF10G13	TOS	10A, 400V, 0.08A, 3.5V	F-23	ECG5507		 图 F-38
SF10G14		15A, 400V, 0.027A, 1.5V	D-9			
SF10G41	TOS	10A, 400V, 0.04A, 2V	B-91			
SF10G41A		2 x SCR, 400V, 10A	B-9			
SF10G48		10A, 400V	C-35			
SF10GZ47		2 x SCR, 10A, 400V				
SF10J13	TOS	10A, 600V, 0.08A, 3.5V	F-23	EC5509		 图 F-23
SF10J41	TOS	10A, 600V, 0.04A, 2V	B-91			

器件型号 Element type	厂名 Manufacturers	材料用途参数 Material Purpose Parameter	图号 Figure	国内外相似替换器件型号 Replace of similar type	备注 Notes	外形参考图 Reference shape
SF10J41A		10A, 600V	C-35			
SF10J4B		10A, 600V	B-9			
SF10JZ41A		2 x SCR, 10A, 600V				图 C-35
SF10JZ47		2 x SCR, 10A, 600V				
SF10L13	TOS	15.7A, 800V, 0.08A, 3.5V	F-23	ECG5531		
SF10N13	TOS	15.7A, 1kV, 0.08A, 3.5V	F-23			
SF16B13	TOS	16A, 100V, 0.04A, 3V	F-23	ECG5522		
SF16B14	TOS	16A, 100V, 0.04A, 3V	D-9	ECG5522, 2N4103		
SF16D13	TOS	16A, 200V, 0.04A, 3V	F-23	ECG5524		图 B-9
SF16D14	TOS	16A, 200V, 0.04A, 3V	D-9	ECG5552, 2N4103		
SF16F13	TOS	16A, 300V	F-38			
SF16G13	TOS	16A, 400V, 0.04A, 3V	F-23	ECG5527		
SF16G14	TOS	16A, 400V, 0.04A, 3V	D-9	ECG5554, 2N4103		
SF16GZ51		16A, 440V				
SF16J13	TOS	16A, 600V, 0.04A, 3V	F-23	ECG5529		
SF16J2H1		2 x SCR, 19A, 220V				图 F-23
SF16J6S1		2 x SCR, 18A, 220V				
SF16JZ51		17A, 220V				
SF16L13	TOS	16A, 800V, 0.04A, 3V	F-23	ECG5531		
SF16J4B1		4 x SCR, 17A, 220V				
SF16L6A1		6 x SCR, 25A, 220V				
SF16N13	TOS	16A, 1kV, 0.04A, 3V	F-23			图 D-9
SF16Q13	TOS	16A, 1.2kV, 0.04A, 3V	F-23			
SF16Q2H2		2 x SCR, 18A, 440V				
SF16Q6S2		2 x SCR, 18A, 440V				
SF25D13	TOS	25A, 200V, 0.05A, 3V	F-23			
SF25F13	TOS	25A, 300V, 0.05A, 3V	F-23			图 F-38

器件型号 Element type	厂名 Manufacturers	材料用途参数 Material Purpose Parameter	图号 Figure	国内外相似替换器型号 Replace of similar type	备注 Notes	外形参考图 Reference shape
SF25G13	TOS	25A, 400V, 0.05A, 3V	F-23			
SF25GZ51		25A, 400V				
SF25J13	TOS	25A, 600V, 0.05A, 3V	F-23			
SF25JZ51		25A, 600V				
SF25L13	TOS	25A, 800V, 0.05A, 3V	F-23			
SF25N13	TOS	25A, 1.0KV, 0.05A, 3V	F-23			
SF25Q13	TOS	25A, 1.2KV, 0.05A, 3V	F-23			
SF30D13	TOS	47A, 200V, 0.1A, 3V	F-23			
SF30F13	TOS	47A, 300V, 0.1A, 3V	F-23			
SF30G13	TOS	47A, 400V, 0.1A, 3V	F-23			
SF30J13	TOS	47A, 600V, 0.1A, 3V	F-23			
SF30J2H1		2 x SCR, 44A, 220V				
SF30J6S1		2 x SCR, 39A, 220V				
SF30L13	TOS	47A, 800V, 0.1A, 3V	F-23			
SF30L4B1		4 x SCR, 36A, 220V				
SF30L6A1		6 x SCR, 54A, 220V				
SF30N13	TOS	47A, 1KV, 0.1A, 3V	F-23			
SF30Q13	TOS	47A, 1.2KV, 0.1A, 3V	F-23			
SF30Q2H2		2 x SCR, 44A, 440V				
SF30Q6S2		2 x SCR, 39A, 440V				
SF50D13	TOS	79A, 200V, 0.1A, 3V	F-23			
SF50DL27		500A, 800V	C-39			
SF50DN27		500A, 1KV	C-39			
SF50DQ27		500A, 1.2KV	C-39			
SF50DR27		500A, 1.3KV	C-39			
SF50F13	TOS	79A, 300V, 0.1A, 3V	F-23			
SF50G12		79A, 400V, 0.1A, 3V	F-59			



图 C-39



图 F-59

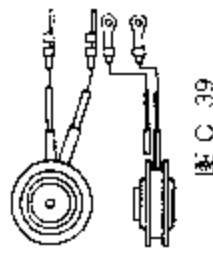

器件型号 Element type	厂名 Manufacturers	材料用途参数 Material Purpose Parameter	图号 Figure	国内外相似替换器件型号 Replace of similar type	备注 Notes	外形参考图 Reference shape
SF50G13	TOS	79A, 400V, 0.1A, 3V	F-23			
SF50J12		79A, 600V, 0.1A, 3V	F-59			
SF50J13	TOS	79A, 600V, 0.1A, 3V	F-23			
SF50J2H1		2 x SCR, 57A, 220V				
SF50J6S1		2 x SCR, 55A, 220V				
SF50L12		79A, 800V, 0.1A, 3V	F-59			
SF50L13	TOS	79A, 800V, 0.1A, 3V	F-38			
SF50L4R1		4 x SCR, 50A, 440V				
SF50L6A1		4 x SCR, 75A, 440V				
SF50N12		79A, 1kV, 0.1A, 3V	F-59			
SF50N13	TOS	79A, 1kV, 0.1A, 3V	F-38			
SF50Q13	TOS	79A, 1.2kV, 0.1A, 3V	F-38			
SF50Q2H2		57A, 440V				
SF50Q2S2		2 x SCR, 55A, 440V				
SF50J27		500A, 1.2kV				
SF50R12		79A, 1.3kV, 0.1A, 3V	F-59			
SF80D11	TOS	126A, 200V, 0.15A, 3V	F-76	ECG5570		
SF80D15	TOS	=SF80D11	F-76	ECG5570		
SF80G11	TOS	126A, 400V, 0.15A, 3V	F-76	ECG5572		
SF80G15	TOS	=SF80G11	F-76	ECG5572		
SF80G41A		8A, 400V	B-9			
SF80J11, 15		126A, 600V, 0.15A, 3V	F-76	ECG5572		
SF80J2H1		2 x SCR, 8A, 220V				
SF80J41A		8A, 600V	B-9			
SF80J6S1		4 x SCR, 70A, 220V				
SF80JZ47		8A, 600V				
SF80L11		126A, 800V, 0.15A, 3V	F-76			
SF80L13		80A, 800V				



图 F-23



图 F-59

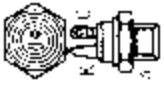



图 F-38









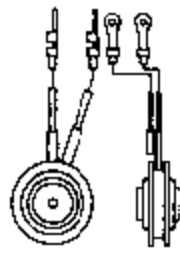









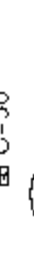





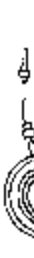



图 F-76







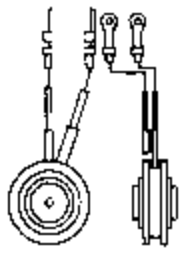

图 B-9

器件型号 Element type	厂名 Manufacturers	材料用途参数 Material Purpose Parameter	图号 Figure	国内外相似替换器型号 Replace of similar type	备注 Notes	外形参考图 Reference shape
SF80L4B1	SCB	4 x SCR, 70A, 220V				 图 F-76
SF80L6A1	SCB	6 x SCR, 105A, 220V	F-76			
SF80N11		126A, 1kV, 0.15A, 3V				
SF80N13		80A, 1kV	F-76			
SF80R11		126A, 1.3kV, 0.15A, 3V				
SF80R13		80A, 1.3kV				
SF80U11		126A, 1.6kV, 0.15A, 3V	F-76			
SF80U13		80A, 1.6kV				
SF80U4B2	SCB	4 x SCR, 70A, 440V				
SF80U6A2	SCB	6 x SCR, 105A, 440V				
SF80Z47		8A, 400V				 图 C-43
SF80Q13		80A, 1.2kV				
SF80Q2H2	SCB	2 x SCR, 93A, 440V				
SF80Q6S2	SCB	2 x SCR, 88A, 440V				
SF100G21	TOS	100A, 400V, 0.15A, 3V	C-43	ECG5591		
SF100J21	TOS	100A, 600V, 0.15A, 3V	C-43	ECG5591		
SF100L27	TOS	100A, 800V, 0.15A, 3V	C-39			
SF100N27	TOS	100A, 1kV, 0.15A, 3V	C-39			
SF100Q27	TOS	100A, 1.2kV, 0.15A, 3V	C-39			
SF100R27		100A, 1.3kV	C-39			
SF100U27		100A, 1.6kV	C-39			
SF150B27	TOS	150A, 100V, 0.15A, 3V	C-39			 图 C-39
SF150D27	TOS	150A, 200V, 0.15A, 3V	C-39			
SF150G15	TOS	235A, 400V, 0.15A, 3V	F-76	ECG5582		
SF150G27	TOS	150A, 400V, 0.15A, 3V	C-39			
SF150J15	TOS	235A, 600V, 0.15A, 3V	F-76	ECG5582		
SF150J27	TOS	150A, 600V, 0.15A, 3V	C-39			

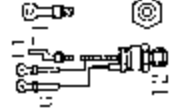
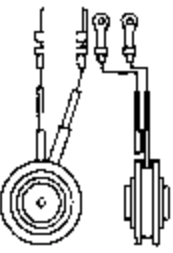

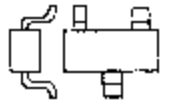
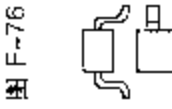

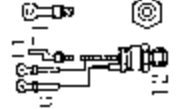
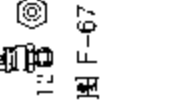
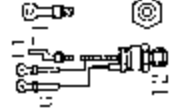
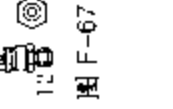
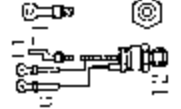
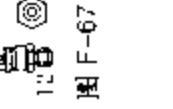

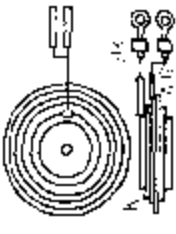
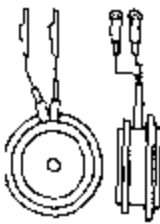
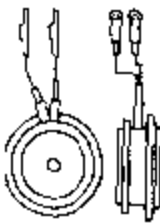
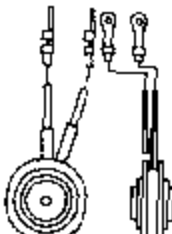
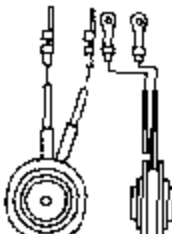
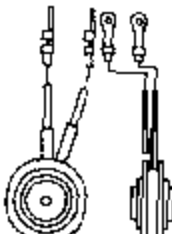
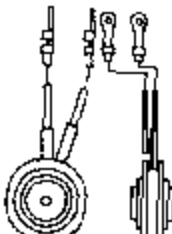
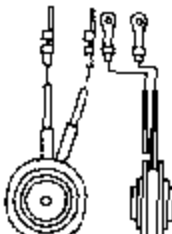
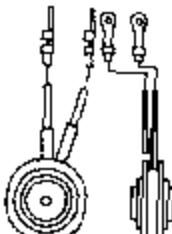
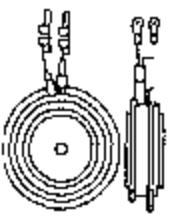
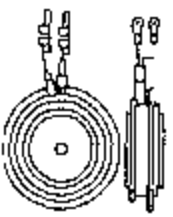
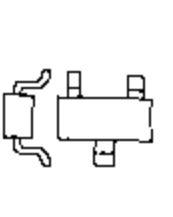
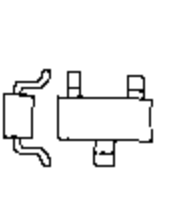
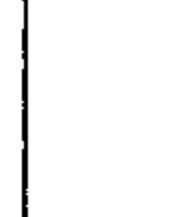
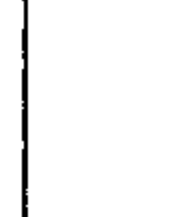
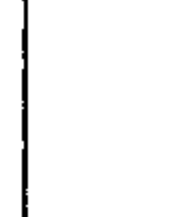
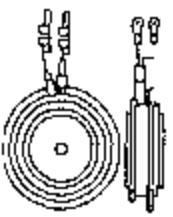
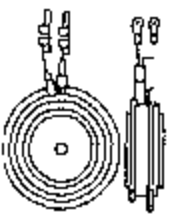
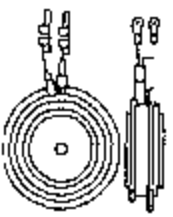
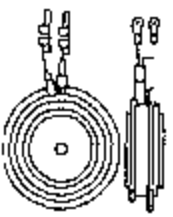
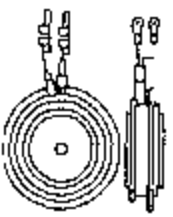
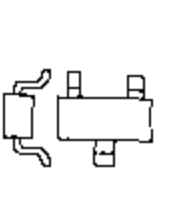
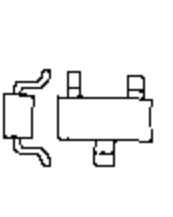
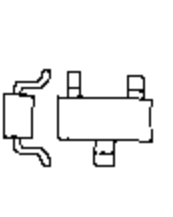

器件型号 Element type	厂名 Manufacturers	材料用途参数 Material Purpose Parameter	图号 Figure	国内外相似替换器件型号 Replace of similar type	备注 Notes	外形参考图 Reference shape
SF150J2H1		SCB 2 x SCR, 155A, 220V				
SF150J6S1		SCB 2 x SCR, 140A, 220V				
SF150L13	TOS	236A, 800V, 0.15A, 3V	F-67			
SF150L27		1.5kA, 800V	C-50			
SF150N13	TOS	236A, 1kV, 0.15A, 3V	F-67			
SF150Q13		150A, 1.2kV	F-67			
SF150Q27		1.5kA, 1.2kV	C-50			
SF150Q2H2		SCB 2 x SCR, 133A, 440V				
SF150Q692		SCB 2 x SCR, 140A, 440V				
SF150R13	TOS	236A, 1.3kV, 0.15A, 3V	F-67			
SF150T15		150A, 600V	F-84			
SF150U13	TOS	236A, 1.6kV, 0.15A, 3V	F-67			
SF150U4B3		SCB 4 x SCR, 116A, 440V				
SF150U6A2		SCB 6 x SCR, 174A, 440V				
SF250G21	TOS	250A, 400V, 0.15A, 3V	C-43			
SF250J21	TOS	250A, 600V, 0.15A, 3V	C-43			
SF250L21		250A, 800V	C-44			
SF250L27		250A, 800V				
SF250N21		250A, 1kV	C-44			
SF250N27		250A, 1kV				
SF250Q21		250A, 1.2kV	C-44			
SF250Q27		250A, 1.2kV				
SF250R21		250A, 1.3kV	C-44			
SF250R27		250A, 1.3kV				
SF250U21		250A, 1.6kV	C-44			
SF250U27		250A, 1.6kV				
SF300B27	TOS	300A, 100V, 0.15A, 3V	C-39			

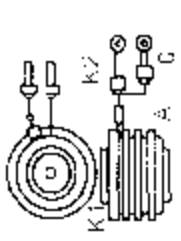
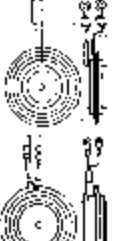
器件型号 Element type	厂名 Manufacturers	材料用途参数 Material Purpose Parameter	图号 Figure	国内外相似替换器型号 Replace of similar type	备注 Notes	外形参考图 Reference shape
SF300D27	TOS	300A, 200V, 0.15A, 3V	C-39			
SF300G11	TOS	470A, 400V, 0.26A, 3.5V	F-76			
SF300G15	TOS	470A, 400V, 0.2A, 3V	F-76			
SF300G27	TOS	300A, 400V, 0.15A, 3V	C-39			
SF300HX22	IOS	300A, 5kV, 0.25A, 2.5V	G-2			
SF300HX28		300A, 5kV	G-2			
SF300J11		470A, 600V, 0.25A, 3.5V	F-76			
SF300J15	TOS	470A, 600V, 0.2A, 3V	F-76	ECG5587		
SF300J27	TOS	300A, 600V, 0.15A, 3V	C-39			
SF300J2H1		2 x SCR, 44A, 220V				
SF300J6S1		2 x SCR, 39A, 220V				
SF300L11		470A, 600V, 0.26A, 3.5V	F-76			
SF300L13	TOS	470A, 800V, 0.26A, 3.5V	F-67			
SF300L4B1		4 x SCR, 160A, 220V				
SF300L6A1		6 x SCR, 160A, 220V				
SF300N13	TOS	470A, 1kV, 0.26A, 3.5V	F-67			
SF300Q11		300A, 1.2kV, 0.26A, 3.5V	F-76			
SF300Q13	TOS	470A, 1.2kV, 0.26A, 3.5V	F-67			
SF300Q2H2		2 x SCR, 244A, 440V				
SF300Q6S2		2 x SCR, 39A, 440V				
SF300QB		300A, 1.2kV	G-2			
SF300R13	TOS	470A, 1.3kV, 0.26A, 3.5V	F-67			
SF300S11		300A, 1.4kV, 0.26A, 3.5V	F-76			
SF300U11		470A, 1.6kV, 0.26A, 3.5V	F-76			
SF300U13		300A, 1.6kV	G-2			
SF300U4B2		4 x SCR, 160A, 440V				
SF300U62A		6 x SCR, 240A, 440V				
SF3H42 (LC2)		3A, 400V				

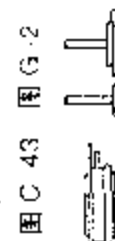

器件型号 Element type	厂名 Manufacturers	材料用途参数 Material Purpose Parameter	图号 Figure	国内外相似替换器件型号 Replace of similar type	备注 Notes	外形参考图 Reference snape
SF350						
SF350FXH26	TOS	350A, 3.5kV 350A, 3.5kV, 0.25A, 2.5V	C-61 C-61			
SF400G26	TOS	400A, 400V, 0.26A, 3.5V	C-43			
SF400U26	TOS	400A, 600V, 0.26A, 3.5V	C-43			
SF400L27	TOS	400A, 800V, 0.15A, 3V	C-39			
SF400N27	TOS	400A, 1kV, 0.15A, 3V	C-39			
SF400Q27	TOS	400A, 1.2kV, 0.15A, 3V	C-39			
SF400R27	TOS	400A, 1.3kV, 0.15A, 3V	C-39			
SF400U26	TOS	400A, 1.6kV, 0.26A, 3.5V	C-43			
SF400U27	TOS	400A, 1.6kV, 0.15A, 3V	C-39			
SF400Y26		500A, 2kV				
SF500B27	TOS	500A, 100V, 0.15A, 3V	C-39			
SF500D27	TOS	500A, 200V, 0.15A, 3V	C-39			
SF500EX25	TOS	500A, 2.5kV, 0.25A, 2.5V	C-50			
SF500EX26	TOS	500A, 2.5kV, 0.25A, 2.5V	C-61			
SF500EX28		500A, 2.5kV	G-2			
SF500EX29		500A, 2.5kV	G-2			
SF500EY26		500A, 2.5kV	G-2			
SF500G27	TOS	500A, 400V, 0.15A, 3V	C-39			
SF500J27	TOS	500A, 600V, 0.15A, 3V	C-39			
SF500L27	TOS	500A, 800V, 0.2A, 3V	C-43			
SF500N27	TOS	500A, 1kV, 0.2A, 3V	C-43			
SF500Q27		500A, 1.2kV				
SF500R27	TOS	500A, 1.3kV, 0.2A, 3V	C-43			
SF500U26	TOS	500A, 1.6kV, 0.25A, 2.5V	C-50			
SF500U26	TOS	500A, 1.6kV, 0.25A, 2.5V	C-43			
SF500U27	TOS	500A, 1.6kV, 0.2A, 3V	C-43			

器件型号 Element type	厂名 Manufacturers	材料用途参数 Material Purpose Parameter	图号 Figure	国内外相似替换器型号 Replace of similar type	备注 Notes	外形参考图 Reference shape
SF500X25		500A, 2kV	C-60			
SF500EX25		500A, 2kV				
SF500EX26		500A, 2.5kV				
SF500Y25	TOS	500A, 2kV, 0.25A, 2.5V	C-50			
SF500Y26	TOS	500A, 2kV, 0.25A, 2.5V	C-61			
SF600B27	TOS	600A, 100V, 0.2A, 3V	C-43			
SF600D27	TOS	600A, 200V, 0.2A, 3V	C-43			
SF600G27	TOS	600A, 400V, 0.2A, 3V	C-43			
SF600J27	TOS	600A, 600V, 0.2A, 3V	C-43			
SF800GX21		800A, 4kV	G-2			
SF800GX22		800A, 4kV	G-2			
SF800J23		800A, 600V, 0.32A, 4V	C-10			
SF800J25	TOS	1.25kA, 600V, 0.32A, 4V	B-8	ECG5598		
SF800J26	TOS	800A, 600V, 0.32A, 4V	C-61			
SF800L23		800A, 800V, 0.32A, 4V	C-10			
SF800L25	TOS	1.25kA, 600V, 0.32A, 4V	C-59	ECG5599		
SF800L26	TOS	800A, 800V, 0.32A, 4V	C-61			
SF800N23		800A, 1kV, 0.32A, 4V	C-10			
SF800N25	TOS	1.25kA, 1kV, 0.32A, 4V	C-59	ECG5599		
SF800N26		800A, 1kV	G-2			
SF800R23		800A, 1.3kV, 0.32A, 4V	C-10			
SF800R25		800A, 1.6kV	G-2			
SF800R26		800A, 1.6kV	G-2			
SF800U25	TOS	1.25kA, 1.6kV, 0.32A, 4V	C-59			
SF800U26	TOS	800A, 1.6kV, 0.32A, 4V	C-61			
SF800U28		800A, 1.6kV	G-2			
SF800U29		800A, 1.6kV	G-2			
SF1000EX24	TOS	1kA, 2.5kV, 0.45A, 3.5V	C-55			





器件型号 Element type	厂名 Manufacturers	材料用途参数 Material Purpose Parameter	图号 Figure	国内外相似替换器件型号 Replace of similar type	备注 Notes	外形参考图 Reference shape
SF1000GX21		1kA, 4kV				
SF1000GX23		1kA, 4kV	A-8			
SF1500EX21		2.5kA, 2.5kV				
SF1500EX24	TOS	2.35kA, 2.5kV, 0.45A, 3.5V	C-55			
SF1500EX25		1.5kA, 2.5kV	A-8			
SF1500G27	TOS	1.5kA, 400V, 0.25A, 3.5V	C-55			
SF1500GX21	TOS	2.3kA, 4kV, 0.4A, 3.5V	C-44			
SF1500GX22		1.5kA, 4kV	A-9			
SF1500J27	TOS	1.5kA, 600V, 0.25A, 3.5V	C-55			
SF1500L27	TOS	1.5kA, 800V, 0.25A, 3.5V	C-55			
SF1500Q27	TOS	1.5kA, 1.2kV, 0.25A, 3.5V	C-55			
SF1500U27		1.6kV				
SF2500FX21		3.93kA, 2.5kV, 0.25A, 2.5V	C-44			
SF2500EX22	TOS	2.5kA, 2.5kV	A-9			
SF3000GX21		4.71kA, 4kV, 0.3A, 3V	C-43			
SF3000GX22	TOS	3kA, 4kV	A-12			
SFR16L4BB1		2 x SCR+2 x D, 17A, 220V				
SFR16L6P1		3 x SCR+4 x D, 25A, 220V				
SFR30L4BB1		2 x SCR+2 x D, 38A, 220V				
SFR30L6P1		3 x SCR+4 x D, 25A, 220V				
SFR50L4BB1		2 x SCR+2 x D, 52A, 220V				
SFR50L6P1		3 x SCR+4 x D, 25A, 220V				

图 C-43 图 A-12

器件型号 Element type	厂名 Manufacturers	材料用途参数 Material Purpose Parameter	图号 Figure	国内外相似替换器件型号 Replace of similar type	备注 Notes	外形参考图 Reference shape
SFR80L4BB1	SCB	2 x SCR+2 x D, 70A, 220V				 图 C-43
SFR80L6P1	SCB	3 x SCR+4 x D, 105A, 220V				
SFR80U4BB2	SCB	2 x SCR+2 x D, 70A, 440V				
SFR1501BB2	SCB	2 x SCR+2 x D, 116A, 410V				 图 B-51
SFR150L4BB1	SCB	2 x SCR+2 x D, 116A, 220V				
SFR150L6P1	SCB	3 x SCR+4 x D, 174A, 220V				
SFR300L4BB1	SCB	2 x SCR+2 x D, 160A, 220V				
SFR300L6P1	SCB	3 x SCR+4 x D, 240A, 220V				
SFR300U4BB2	SCB	2 x SCR+2 x D, 160A, 440V	C-43			
SFR2500EX21		2KA, 2.5KV				
SFS2326		1A, 200V, 200 μA, 0.8V	B-51			 图 G-10
SFS2327		1A, 250V, 200 μA, 0.8V	B-51			
SFS2328		1A, 300V, 200 μA, 0.8V	B-51			
SFS2329		1A, 400V, 200 μA, 0.8V	B-51			
SG16AA20		16A, 200V, 0.04A, 3V	G-10			 图 G-10
SG16AA30		16A, 300V, 0.04A, 3V	G-10			
SG16AA40	MOD	16A, 400V, 0.04A, 3V	G-10			
SG16AA50		16A, 500V, 0.04A, 3V	G-10			
SG16AA60	MOD	16A, 600V, 0.04A, 3V	G-10			
SG25AA20		25A, 200V, 0.04A, 3V	G-10			
SG25AA30		25A, 300V, 0.04A, 3V	G-10			
SG25AA40	MOD	25A, 400V, 0.04A, 3V	G-10			
SG25AA50		25A, 500V, 0.04A, 3V	G-10			
SG25AA60	MOD	25A, 600V, 0.04A, 3V	G-10			

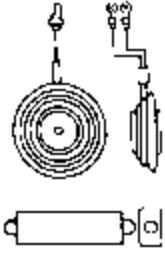
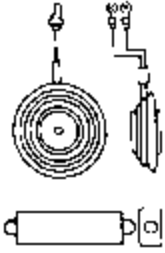
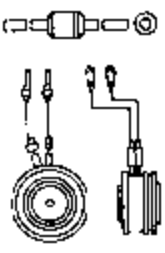
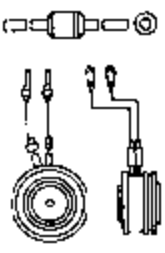
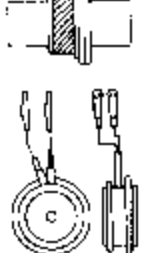
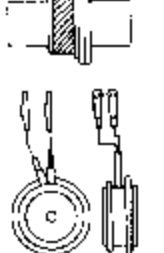
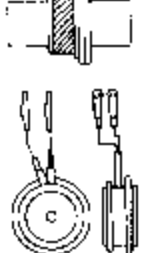
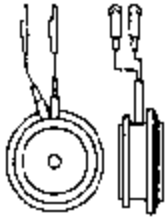

器件型号 Element type	厂名 Manufacturers	材料用途参数 Material Purpose Parameter	图号 Figure	国内外相似替换器件型号 Replace of similar type	备注 Notes	外形参考图 Reference shape
SG200J21	TOS	GTO 140A, 600V, 0.4A, 2V	C-56			
SG400EX22		SCR-GC 2.5kV, 400A				
SG400R22		SCR-GC 1.3kV, 400A				
SG400U22		SCR-GC 1.6kV, 400A				
SG400W22		SCR GC 1.8kV, 400A				
SG500FXF21		SCR-GC 3.3kV, 500A				
SG500FXF22		SCR-GC 3.3kV, 500A				
SG500GXH21		SCH-GC 4.5kV, 500A				
SG500GXH22		SCR-GC 4.5kV, 500A				
SG600EX21	TOS	GTO 400A, 2.5kV, 0.35A, 2V	C-58			
SG600EX26		SCR-GC 600A, 2.5kV	C-58			
SG600GXH26		SCR-GC 600A, 4.5kV				
SG600GXH29		600A, 4.5kV				
SG600J21	TOS	GTO 400A, 600V, 0.35A, 2V	C-58			
SG600R21	TOS	GTO 400A, 1.3kV, 0.35A, 2V	C-58			
SG700EX22		SCR-GC 700A, 2.5kV				
SG700R22		SCR-GC 700A, 1.3kV				
SG700U22		SCR-GC 700A, 1.6kV				
SG700W22		SCR-GC 700A, 1.8kV				
SG800EX21	TOS	GTO 400A, 2.5kV, 0.35A, 1V	C-58			
SG800EX24		800A, 2.5kV				
SG800FXF21		SCR-GC 800A, 3.3kV				
SG800FXF22		SCR-GC 800A, 3.3kV				

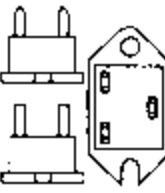
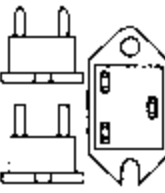

图 C-56



图 C-58

器件型号 Element type	厂名 Manufacturers	材料用途参数 Material Purpose Parameter	图号 Figure	国内外相似替换器件型号 Replace of similar type	备注 Notes	外形参考图 Reference shape
SG800GXH21, 22, 24		SCR-GC 800A, 4.5KV				
SG800J21	TOS	GTO 400A, 600V, 0.35A, 2V	C-58			
SG800F21	TOS	GTO 400A, 1.3KV, 0.35A, 2V	C-58			
SG800R24		SCR-GC 800A, 1.3KV				
SG800U24		SCR-GC 800A, 1.3KV				
SG800W24		SCR-GC 800A, 1.8KV				
SG1000R22	TOS	GTO 250A, 1.3KV, 0.35A, 2V	C-58			
SG1000EX23		SCR-GC 1KA, 2.5KV				
SG1000EX26		SCR-GC 1KA, 2.5KV				
SG1000GXH26		SCR-GC 1KA, 4.5KV				
SG1000R23		SCR-GC 1KA, 1.3KV				
SG1000U23		SCR-GC 1KA, 1.6KV				
SG1000W23		SCR-GC 1KA, 1.8KV				
SG1200EX21	TOS	GTO 700A, 2.5KV, 1A, 3.5V	C-44			
SG1200EX23		SCR-GC 1.2KA, 2.5KV				
SG1200EX24		SCR-GC 1.2KA, 2.5KV				
SG1200R23		SCR-GC 1.2KA, 1.3KV				
SG1200U23		SCR-GC 1.2KA, 1.6KV				
SG1200W23		SCR-GC 1.2KA, 1.8KV				
SG1400EX21	TOS	GTO 700A, 2.5KV, 1.2A, 3.5V	C-44			
SG1500EX24		1.5KA, 2.5KV				
SG1500FXF22		SCR-GC 1.5KA, 3.3KV				
SG1500GXH21		SCR-GC 1.5KA, 4.5KV				
SG1500GXH22		SCR-GC 1.5KA, 4.5KV				

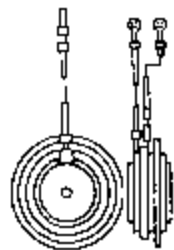

图 C-58

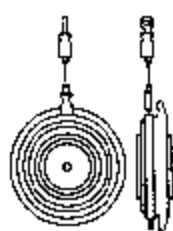





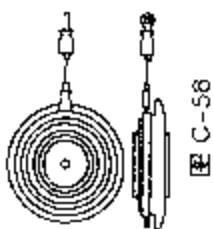



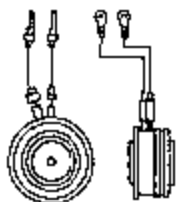
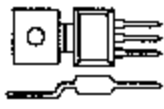
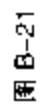



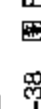

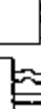

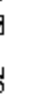

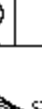
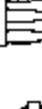
图 C-44

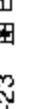

器件型号 Element type	厂名 Manufacturers	材料用途参数 Material Purpose Parameter	图号 Figure	国内外相似替换器件型号 Replace of similar type	备注 Notes	外形参考图 Reference shape
SG1500R22	SCR-GC	1.5kA, 1.3kV				
SG1500U22	SCR-GC	1.5kA, 1.6kV				
SG1500W22	SCR-GC	1.5kA, 1.8kV, 0.35A				
SG2000EX22, 24, 26	SCR-GC	2kA, 2.5kV				
SG2000FXF21	SCR-GC	2kA, 3.3kV				
SG2000GXH21	SCR GC	2kA, 4.5kV				
SG2000GXH26	SCR-GC	2kA, 2.5kV				
SG2000R22	SCR-GC	2kA, 1.3kV				
SG2000R24	SCR-GC	2kA, 1.3kV				
SG2000U22	SCR-GC	2kA, 1.6kV				
SG2000U24	SCR-GC	2kA, 1.6kV				
SG2000W22	SCR-GC	2kA, 1.8kV				
SG2000W24	SCR-GC	2kA, 1.8kV				
SG2200FXF24	SCR-GC	2.2kA, 3.3kV				
SG2200GXH24	SCR-GC	2.2kA, 4.5kV				
SG2500EX24	SCR-GC	2.5kA, 2.5kV				
SG2500FXF21	SCR-GC	2.5kA, 3.3kV				
SG2500FXF22	SCR-GC	2.5kA, 3.3kV				
SG2500GXH21, 22, 24, 25	SCR-GC	2.5kA, 4.5kV				
SG2700EX22	SCR-GC	2.7kA, 2.5kV				
SG2700R22	SCR-GC	2.7kA, 1.3kV				
SG2700U22	SCR-GC	2.7kA, 1.6kV				
SG2700W22	SCR-GC	2.7kA, 1.8kV				

器件型号 Element type	厂名 Manufacturers	材料用途参数 Material Purpose Parameter	图号 Figure	国内外相似替换器件型号 Replace of similar type	备注 Notes	外形参考图 Reference shape
SG3000EX24	SCR-GC	3kA, 1.25kV				
SG3000GXH24	SCR-GC	3kA, 4.5kV				
SG3000GXH24G	SCR-GC	3kA, 4.5kV				
SG3000GXH29	SCR-GC	3kA, 4.5kV				
SG3000JX24	SCR-GC	3kA, 6kV				
SG4000FX26		4kA, 4.5kV				
SG4000FX26C		4kA, 4.5kV				
SG4000GXH26	SCR-GC	4kA, 4.5kV				
SG4000GXH26G	SCR-GC	4kA, 4.5kV				
SG4000GXH28		4kA, 4.5kV				
SG4000GXH29G		4kA, 4.5kV				
SG4000JX26		4kA, 6kV				
SH2B41	TOS	SCR-H	2A, 100V, 0.0015A, 0.8V	R-21	S2061A, TIC108A	
SH2D41	TOS	SCR-H	2A, 200V, 0.0015A, 0.8V	B-21	S2061B, TIC108B	
SH2G41	TOS	SCR H	2A, 400V, 0.0015A, 0.8V	B 21	S2061D, TIC108D	
SH5B13	TOS	SCR-H	5A, 100V, 0.04A, 2V	F-38		
SH5D13	TOS	SCR-H	5A, 200V, 0.04A, 2V	F-27		
SH5E13	TOS	SCR-H	5A, 300V	F-38		
SH5G13	TOS	SCR-H	5A, 400V, 0.04A, 3V	F-38		
SH5G41LC2	TOS	SCR-H	0.8A, 400V, 0.05A, 1.5V	B-32		
SH5G41CL(2)		SCR-HS	400V	B-9		
SH5H13	TOS	SCR-H	5A, 500V	F-38		
SH5J12U	TOS	SCR-H	5A, 600V, 0.04A, 3V	F-23		
SH5J13	TOS	SCR-H	5A, 600V, 0.04A, 3V	F-27		
SH6G41	TOS		1.2A, 400V, 0.05A, 1.5V	B-20		





器件型号 Element type	厂名 Manufacturers	材料用途参数 Material Purpose Parameter	图号 Figure	国内外相似替换器件型号 Replace of similar type	备注 Notes	外形参考图 Reference shape
SH16B13	TOS	SCR-H 16A, 100V, 0.05A, 3V	F-23			 图 F-23
SH16B14		16A, 200V, 0.04A, 3V				
SH16D13	TOS	SCR-H 16A, 200V, 0.05A, 3V	F-23			
SH16D14		16A, 200V, 0.04A, 3V				
SH16F13		SCR-H 16A, 300V	F-38			
SH16G13	TOS	SCR-H 16A, 400V, 0.05A, 3V	F-23			
SH16H13		SCR-H 16A, 500V	F-38			
SH16J13	TOS	SCR-H 16A, 600V, 0.05A, 3V	F-23			
SH30D11		30A, 200V, 0.1A, 3V	F-59			
SH30D13A	TOS	SCR-H 47A, 200V, 0.1A, 3V	F-23			
SH30F11		30A, 300V, 0.1A, 3V	F-59			
SH30F13A	TOS	SCR-H 47A, 300V, 0.1A, 3V	F-23			
SH30G11		30A, 400V, 0.1A, 3V	F-59			
SH30G13A	TOS	SCR-H 47A, 400V, 0.1A, 3V	F-23			
SH30H11		30A, 500V, 0.1A, 3V	F-59			
SH30H13A	TOS	SCR-H 47A, 500V, 0.1A, 3V	F-23			
SH30J11		30A, 600V, 0.1A, 3V	F-59			
SH30J13A	TOS	SCR-H 47A, 600V, 0.1A, 3V	F-23			
SH30L11		30A, 800V, 0.1A, 3V	F-59			
SH30L13A	TOS	SCR-H 47A, 800V, 0.1A, 3V	F-23			
SH50D13A	TOS	SCR-H 79A, 200V, 0.1A, 3V	F-23			
SH50F13A	TOS	SCR-H 79A, 300V, 0.1A, 3V	F-23			
SH50G13A	TOS	SCR-H 79A, 400V, 0.1A, 3V	F-23			
SH50H13A	TOS	SCR-H 79A, 500V, 0.1A, 3V	F-23			
SH50J13A	TOS	SCR-H 79A, 600V, 0.1A, 3V	F-23			
SH50L13A	TOS	SCR-H 79A, 800V, 0.1A, 3V	F-23			



图 F-38

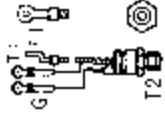

图 F-59

器件型号 Element type	厂名 Manufacturers	材料用途参数 Material Purpose Parameter	图号 Figure	国内外相似替换器件型号 Replace of similar type	备注 Notes	外形参考图 Reference shape
SH80D11		126A, 200V, 0.15A, 3V	F-76			 <p>图 F-76</p>
SH80D13A	TOS	SCR-H 126A, 200V, 0.15A, 3V	F-67			
SH80F11		126A, 300V, 0.15A, 3V	F-76			
SH80F13A	TOS	SCR-H 126A, 300V, 0.15A, 3V	F-67			
SH80G11		126A, 400V, 0.15A, 3V	F-76			
SH80G13A		80A, 800V	F-67			
SH80H11		126A, 500V, 0.15A, 3V	F-76			
SH80J11		126A, 600V, 0.15A, 3V	F-76			
SH80J13A	TOS	SCR-H 126A, 600V, 0.15A, 3V	F-67			
SH80L11		126A, 800V, 0.15A, 3V	F-76			
SH80L13A	TOS	SCR-H 126A, 800V, 0.15A, 3V	F-67			
SH100D21A	TOS	SCR-H 100A, 200V, 0.15A, 3V	C-43			 <p>图 F-67</p>
SH100F21A	TOS	SCR-H 100A, 300V, 0.15A, 3V	C-43			
SH100G21A	TOS	SCR-H 100A, 400V, 0.15A, 3V	C-43			
SH100J21A	TOS	SCR-H 100A, 600V, 0.15A, 3V	C-43			
SH100L21A	TOS	SCR-H 100A, 800V, 0.15A, 3V	C-43			
SH100N21D	TOS	SCR-H 100A, 1kV, 0.15A, 3V	C-43			
SH100Q21D	TOS	SCR-H 100A, 1.2kV, 0.15A, 3V	C-43			
SH100H21U	TOS	SCR-H 100A, 1.3kV, 0.15A, 3V	C-43			
SH100U21D	TOS	SCR-H 100A, 1.6kV	C-44			
SH150D11		235A, 200V, 0.15A, 3V	F-76			
SH150D13A	TOS	SCR-H 236A, 200V, 0.15A, 3V	F-67			
SH150F11		235A, 300V, 0.15A, 3V	F-76			
SH150F13A	TOS	SCR-H 236A, 300V, 0.15A, 3V	F-67			
SH150G11		235A, 400V, 0.15A, 3V	F-76			
SH150G13A	TOS	SCR-H 236A, 400V, 0.15A, 3V	F-67			
SH150H11		235A, 500V, 0.15A, 3V	F-76			





器件型号 Element type	厂名 Manufacturers	材料用途参数 Material Purpose Parameter	图号 Figure	国内外相似替换器件型号 Replace of similar type	备注 Notes	外形参考图 Reference shape
SH150J11	TOS	235A, 600V, 0.15A, 3V	F-76			
SH150J13A	TOS	236A, 600V, 0.15A, 3V	F-67			
SH150L11	TOS	235A, 800V, 0.15A, 3V	F-76			
SH150L13A	TOS	236A, 800V, 0.15A, 3V	F-67			
SH200D21A	TOS	200A, 200V, 0.15A, 3V	C-43			
SH200F21A	TOS	200A, 300V, 0.15A, 3V	C-43			
SH200G21A	TOS	200A, 400V, 0.15A, 3V	C-43			
SH200J21A	TOS	200A, 600V, 0.15A, 3V	C-43			
SH200L21A	TOS	200A, 800V, 0.15A, 3V	C-43			
SH200N21D	TOS	200A, 1kV, 0.15A, 3V	C-43			
SH200Q21D	TOS	200A, 1.2kV, 0.15A, 3V	C-43			
SH200R21D	TOS	200A, 1.3kV, 0.15A, 3V	C-43			
SH200U21D	TOS	200A, 1.6kV, 0.15A, 3V	C-43			
SH300D11	TOS	470A, 200V, 0.26A, 3.5V	F-76			
SH300D13A	TOS	470A, 200V, 0.26A, 3.5V	F-67			
SH300F11	TOS	470A, 300V, 0.26A, 3.5V	F-76			
SH300F13A	TOS	470A, 300V, 0.26A, 3.5V	F-67			
SH300G11	TOS	470A, 400V, 0.26A, 3.5V	F-76			
SH300G13A	TOS	470A, 400V, 0.26A, 3.5V	F-67			
SH300H11	TOS	470A, 500V, 0.26A, 3.5V	F-76			
SH300J11	TOS	470A, 600V, 0.26A, 3.5V	F-76			
SH300J13A	TOS	470A, 600V, 0.26A, 3.5V	F-67			
SH300J23A	TOS	470A, 600V, 0.3A, 3.5V	C-61			
SH300J26	TOS	470A, 600V, 0.2A, 3V	C-61			
SH300L11	TOS	470A, 800V, 0.26A, 3.5V	F-76			
SH300L13A	TOS	470A, 800V, 0.26A, 3.5V	F-67			

图 F-76



图 F-67

图 C-43

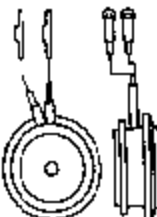



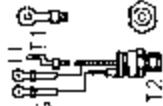



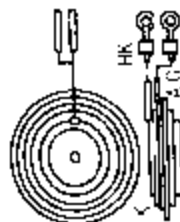
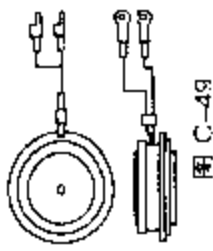
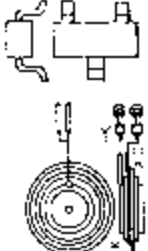
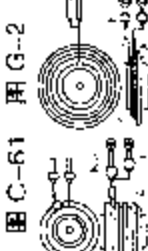
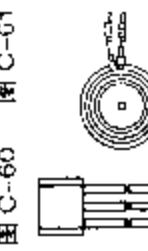
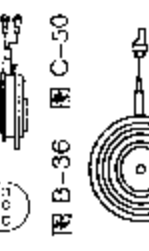
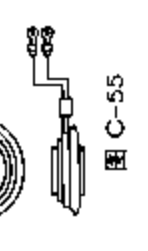
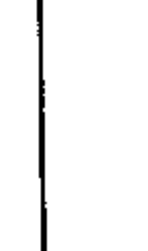

图 C-61

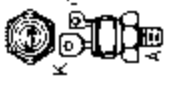
器件型号 Element type	厂名 Manufacturers	材料用途参数 Material Purpose Parameter	图号 Figure	国内外相似替换器件型号 Replace of similar type	备注 Notes	外形参考图 Reference shape
SH400D21A		SCR-H 400A, 200V	C-49			
SH400EX26C	TOS	SCR-H 400A, 2.5kV, 0.35A, 3.5V	C-61			
SH400EX29C		SCR-HS 400A, 1.25kV	G-2			
SH400F21A	TOS	SCR-H 400A, 300V, 0.26A, 3.5V	C-49			
SH400G21A	TOS	SCR-H 400A, 400V, 0.26A, 3.5V	C-49			
SH400J21A	TOS	SCR-H 400A, 600V, 0.26A, 3.5V	C-49			
SH400L21A	TOS	SCR-H 400A, 800V, 0.26A, 3.5V	C-49			
SH400I 23		630A, 800V, 0.26A, 3.5V	C-60			
SH400L25B	TOS	SCR-H 630A, 800V, 0.26A, 3.5V	C-49			
SH400N21D	TOS	SCR-H 400A, 1kV, 0.26A, 3.5V	C-49			
SH400N23		630A, 1kV, 0.26A, 3.5V	C-60			
SH400N25B	TOS	SCR-H 630A, 1kV, 0.26A, 3.5V	C-49			
SH400Q21D		400A, 1.2kV	C-49			
SH400H21D	TOS	SCR-H 400A, 1.3kV, 0.26A, 3.5V	C-49			
SH400R23		630A, 1.3kV, 0.26A, 3.5V	C-60			
SH400R25B	TOS	SCR-H 630A, 1.3kV, 0.26A, 3.5V	C-60			
SH400R26B	TOS	SCR-H 628A, 1.3kV, 0.26A, 3.5V	C-61			
SH400R28B		400A, 1.3kV	G-2			
SH400R29B		400A, 1.3kV	G-2			
SH400U21D	TOS	SCR-H 400A, 1.6kV, 0.26A, 3.5V	C-49			
SHOR3D42		SCR-HS 0.3A, 220V	B-36			
SHR150R22	TOS	RCT 150A, 1.3kV, 0.2A, 3V	C-50			
SHR300J26	TOS	RCT 470A, 600V, 0.2A, 3V	C-61			
SHR400EX24		SCR-N 400A, 1.25kV	C-50			
SHR400R21		SCR-N 630A, 1.3kV	C-55			
SHR400R22		SCR-N 400A, 2.5kV	C-50			
SHR1000EX21		SCR-N 1.57kA, 2.5kV	C-50			









器件型号 Element type	厂名 Manufacturers	材料用途参数 Material Purpose Parameter	图号 Figure	国内外相似替换器件型号 Replace of similar type	备注 Notes	外形参考图 Reference shape
SIPS010	HUT	10A, 50V, 0.025A, 2V	F-53	ECG5562, S0510B		 F-53
SIPS020	HUT	20A, 50V, 0.025A, 1.5V	F-53	ECG5562, S0520L		
SIPS025	HUT	25A, 50V, 0.025A, 2V	F-53	ECG5562, S0525B		
SIPS035	HUT	35A, 50V, 0.025A, 2V	F-53	ECG5562, S0535H		
SIPS08	HUT	8A, 50V, 0.025A, 2V	F-53	S0508B		 F-47
SIPS18	HUT	8A, 100V, 0.025A, 2V	F-53	ECG5562, S1008B		
SIPS28	HUT	8A, 200V, 0.025A, 2V	F-53	ECG5562, S2008B		
SIPS38	HUT	8A, 300V, 0.025A, 2V	F-53	ECG5564, S3008B		
SIPS48	HUT	8A, 400V, 0.025A, 2V	F-53	ECG5564, S4008B		
SIPS58	HUT	8A, 500V, 0.025A, 2V	F-53	ECG5566, S5008B		
SIPS68	HUT	8A, 600V, 0.025A, 2V	F-53	ECG5566, S6008B		
SIPS110	HUT	10A, 100V, 0.025A, 2V	F-53	ECG5562, S1010B		
SIPS120	HUT	20A, 100V, 0.025A, 1.5V	F-53	ECG5562, S1020L		
SIPS125	HUT	25A, 100V, 0.025A, 2V	F-53	ECG5562, S1025B		
SIPS135	HUT	35A, 100V, 0.025A, 2V	F-53	ECG5562, S1035H		
SIPS210	HUT	10A, 200V, 0.025A, 2V	F-53	ECG5562, S2010B		 F-53
SIPS220	HUT	20A, 200V, 0.025A, 1.5V	F-47	ECG5562, S2020L		
SIPS225	HUT	25A, 200V, 0.025A, 2V	F-53	ECG5562, S2025B		
SIPS235	HUT	35A, 200V, 0.025A, 2V	F-53	ECG5562, S2035H		
SIPS310	HUT	10A, 300V, 0.025A, 2V	F-53	ECG5564, S3010B		 F-53
SIPS320	HUT	20A, 300V, 0.025A, 1.5V	F-53	ECG5564, S3020L		
SIPS325	HUT	25A, 300V, 0.025A, 2V	F-53	ECG5564, S3025B		
SIPS335	HUT	35A, 300V, 0.025A, 2V	F-53	ECG5564, S3035H		
SIPS410	HUT	10A, 400V, 0.025A, 2V	F-53	ECG5564, S4010B		



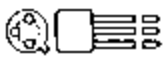

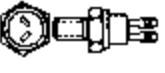
器件型号 Element type	厂名 Manufacturers	材料用途参数 Material Purpose Parameter	图号 Figure	国内外相似替换器件型号 Replace of similar type	备注 Notes	外形参考图 Reference shape
SIPS420	HUT	20A, 400V, 0.025A, 1.5V	F-53	ECG5564, S4020L		
SIPS425	HUT	25A, 400V, 0.025A, 2V	F-53	ECG5564, S4025B		
SIPS435	HUT	35A, 400V, 0.025A, 2V	F-53	ECG5564, S4035H		
SIPS510	HUT	10A, 500V, 0.025A, 2V	F-53	ECG5566, S5010B		
SIPS520	HUT	20A, 500V, 0.025A, 1.5V	F-53	ECG5566, S5020L		
SIPS525	HUT	25A, 500V, 0.025A, 2V	F-53	ECG5566, S5025B		
SIPS535	HUT	35A, 500V, 0.025A, 2V	F-53	ECG5566, S5035H		
SIPS610	HUT	10A, 600V, 0.025A, 2V	F-53	ECG5566, S6010B		
SIPS625	HUT	25A, 600V, 0.025A, 2V	F-53	ECG5566, S6025B		
SIPS635	HUT	35A, 600V, 0.025A, 2V	F-53	ECG5566, S6035H		
SIPT010	HUT	10A, 50V, 0.05A, 2.5V	F-53			
SIPT015	HUT	15A, 50V, 0.05A, 2.5V	F-53	ECG56022, Q2025V6		
SIPT025	HUT	25A, 50V, 0.1A, 2.5V	F-53	ECG56022		
SIPT030	HUT	30A, 50V, 0.1A, 2.5V	F-53	ECG56022		
SIPT040	HUT	40A, 50V, 0.1A, 2.5V	F-53	ECG56022		
SIPT08	HUT	8A, 50V, 0.05A, 2.5V	F-53			
SIPT16	HUT	8A, 100V, 0.05A, 2.5V	F-53			
SIPT28	HUT	8A, 200V, 0.05A, 2.5V	F-53			
SIPT38	HUT	8A, 300V, 0.05A, 2.5V	F-53			
SIPT48	HUT	8A, 400V, 0.05A, 2.5V	F-53			
SIPT58	HUT	8A, 500V, 0.05A, 2.5V	F-53			
SIPT58	HUT	8A, 600V, 0.05A, 2.5V	F-53			
SIPT110	HUT	10A, 100V, 0.05A, 2.5V	F-53			
SIPT115	HUT	15A, 100V, 0.05A, 2.5V	F-53			

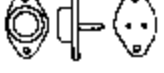
器件型号 Element type	厂名 Manufacturers	材料用途参数 Material Purpose Parameter	图号 Figure	国内外相似替换器件型号 Replace of similar type	备注 Notes	外形参考图 Reference shape
SIPT125	HUT	25A, 100V, 0.1A, 2.5V	F-53	ECG56022, Q2025V6		 图 F-53
SIPT130	HUT	30A, 100V, 0.1A, 2.5V	F-53	ECG56022		
SIPT140	HUT	40A, 100V, 0.1A, 2.5V	F-53	ECG56022		
SIPT210	HUT	10A, 200V, 0.05A, 2.5V	F-53			
SIPT215	HUT	15A, 200V, 0.05A, 2.5V	F-53			
SIPT225	HUT	25A, 200V, 0.1A, 2.5V	F-53	ECG56022, Q2025V6		
SIPT230	HUT	30A, 200V, 0.1A, 2.5V	F-53	ECG56022		
SIPT240	HUT	40A, 200V, 0.1A, 2.5V	F-53	ECG56022		
SIPT310	HUT	10A, 300V, 0.05A, 2.5V	F-53			
SIPT315	HUT	15A, 300V, 0.05A, 2.5V	F-53			
SIPT325, 330	HUT	25A, 300V, 0.1A, 2.5V	F-53	ECG56024, Q4025V6		
SIPT340	HUT	40A, 300V, 0.1A, 2.5V	F-53	ECG56024		
SIPT410	HUT	10A, 400V, 0.05A, 2.5V	F-53			
SIPT415	HUT	15A, 400V, 0.05A, 2.5V	F-53			
SIPT425	HUT	25A, 400V, 0.1A, 2.5V	F-53	ECG56024, Q4025V6		
SIPT430	HUT	30A, 400V, 0.1A, 2.5V	F-53	ECG56024		
SIPT440	HUT	40A, 400V, 0.1A, 2.5V	F-53	ECG56024		
SIPT510	HUT	10A, 500V, 0.05A, 2.5V	F-53			
SIPT515	HUT	15A, 500V, 0.05A, 2.5V	F-53			
SIPT525	HUT	25A, 500V, 0.1A, 2.5V	F-53	ECG56026, Q5025V6		
SIPT530	HUT	30A, 500V, 0.1A, 2.5V	F-53	ECG56026		
SIPT540	HUT	40A, 500V, 0.1A, 2.5V	F-53	ECG56026		
SIPT610	HUT	10A, 600V, 0.05A, 2.5V	F-53			
SIPT615	HUT	15A, 600V, 0.05A, 2.5V	F-53			



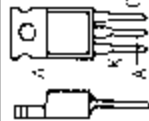
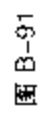

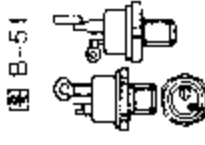





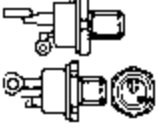











器件型号 Element type	厂名 Manufacturers	材料用途参数 Material Purpose Parameter	图号 Figure	国内外相似替换器件型号 Replace of similar type	备注 Notes	外形参考图 Reference shape
SIPT625	HUT	25A, 600V, 0.1A, 2.5V	F-53	ECG56026, Q6025V6		 图 F-53
SIPT630	HUT	30A, 600V, 0.1A, 2.5V	F-53	ECG56026		
SIPT640	HUT	40A, 600V, 0.1A, 2.5V	F 53	ECG56026		
SISC122C		6A, 300V		C122C1		
SISC122D		8A, 400V		C122D1		
SISC122E		8A, 500V		C122E1		
SISC122M		8A, 600V		C122M1		
SISC122N		8A, 600V		C122N1		
SISC141C		SCR-D 6A, 300V		SC141C		
SISC141D		SCR-D 6A, 400V		SC141D		
SISC141E		SCR-D 6A, 500V		SC141E		
SISC141M		SCR-D 6A, 600V		SC141M		
SISC141N		SCR-D 6A, 600V		SC141N		
SISC141S		SCR-D 6A, 600V		SC141S		
SISC143C		SCR-D 8A, 300V		MAC218-5		
SISC143D		SCR-D 8A, 400V		MAC218-6		
SISC143E		SCR-D 8A, 500V		MAC218-7		
SISC143M		SCR-D 8A, 600V		MAC218-8		
SISC143N		SCR-D 8A, 600V		MAC218-10		
SISC143S		SCR-D 8A, 700V		MAC218-9		
SISC146C		SCR-D 10A, 300V		SC146C		
SISC146D		SCR-D 10A, 400V		SC146D		
SISC146E		SCR-D 10A, 500V		SC146E		
SISC146M, N, S		SCR-D 10A, 600V		SC146M, SC146N, SC146S		

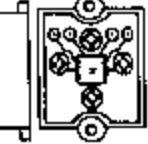
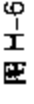

器件型号 Element type	厂名 Manufacturers	材料用途参数 Material Purpose Parameter	图号 Figure	国内外相似替换器件型号 Replace of similar type	备注 Notes	外形参考图 Reference shape
SISC149C, D	SCR-D	12A, 400V		2N6347A		
SISC149E, M	SCR-D	12A, 600V		2N6348A		
SISC149N, S	SCR-D	12A, 800V		2N6349A		
SIT0.8/50...400	50Hz-Thy	0.8A, 50-400V, 0.01A	B-62	BTX30... S2600... TAG612... T1N...		
SIT4/50...400	50Hz-Thy	4A, 50-600V, 0.02A	F-55	BSID41... C230... T6N...C, T8N...C		
SIT14/50...400	50Hz-Thy	14A, 50-400V, 0.05A	D-35			
SIT18/50...600	50Hz-Thy	18A, 50-600V, 0.05A	D-35			
SIT20/50...400	50Hz-Thy	20A, 50-400V, 0.05A	F-55	BTW40... BSIE41...M, CS16... T17N...		
SIT30/50...600	50Hz-Thy	30A, 50-600V, 0.1A	D-35			
SIT50/50...600	50Hz-Thy	50A, 50-600V, 0.1A	D-35			
SIT80/50...400	50Hz-Thy	80A, 50-400V, 0.05A	F-55			
SIT95/50...600	50Hz-Thy	95A, 50-600V, 0.08A	D-35			
SIT180/50...600	50Hz-Thy	180A, 50-600V, 0.4A	D-35			
SK3042-RT	RCA	5A, 600V, 0.03A, 4V	D-9			
SK3196-RT	RCA	5A, 750V, 0.04A, 4V	D-9			
SK3296-RT	RCA	5A, 1.2kV, 0.12A, 1.5V	D-9			

器件型号 Element type	厂名 Manufacturers	材料用途参数 Material Purpose Parameter	图号 Figure	国内外相似替换器件型号 Replace of similar type	备注 Notes	外形参考图 Reference shape
SK3442-RT	RCA	8A, 850V, 0.03A, 2.5V	B-91			
SK3502-RT	RCA	5A, 200V, 0.015A, 2V	D-9			
SK3503-RT	RCA	7A, 600V, 0.015A, 1.5V	B-51			
SK3504-RT	RCA	20A, 600V, 0.015A, 2V	F-48			
SK3505-RT	RCA	35A, 600V, 0.04A, 2V	F-48			
SK3507-RT	RCA	15A, 400V, 0.08A, 2.5V	D-9			
SK3508-RT	RCA	15A, 400V, 0.08A, 2.5V	F-48			
SK3509-RT	RCA	40A, 400V, 0.08A, 2.5V	F-48			
SK3519-RT	RCA	2.5A, 600V, 0.01A, 2.2V	B-51			
SK3520-RT	RCA	15A, 600V, 0.08A, 2.5V	F-48			
SK3521-RT	RCA	30A, 600V, 0.08A, 2.5V	F-48			
SK3522-RT	RCA	40A, 600V, 0.08A, 2.5V	F-48			
SK3527-RT	RCA	12.5A, 600V, 0.04A, 2V	D-9			
SK3532-RT	RCA	6A, 450V, 0.05A, 4V	B-71			
SK3533-RT	RCA	8A, 400V, 0.06A, 2.5V	B-91			
SK3557-RT	RCA	4A, 400V, 200 μA, 0.8V	B-91			
SK3558-RT	RCA	10A, 400V, 0.015A, 1.5V	B-91			
SK3570-RT	RCA	4A, 200V, 200 μA, 0.8V	B-91			
SK3571-RT	RCA	4A, 600V, 200 μA, 0.8V	B-91			
SK3574-RT	RCA	16A, 200V, 0.03A, 1.5V	B-91			
SK3575-RT	RCA	16A, 400V, 0.03A, 1.5V	B-91			
SK3576-RT	RCA	16A, 600V, 0.03A, 1.5V	B-91			
SK3577-RT	RCA	7A, 200V, 0.015A, 1.5V	B-51			
SK3578-RT	RCA	7A, 400V, 0.015A, 1.5V	B-51			
SK3579-RT	RCA	7A, 400V, 0.015A, 1.5V	B-51			

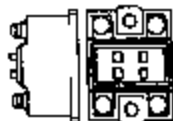
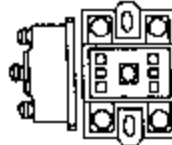

器件型号 Element type	厂名 Manufacturers	材料用途参数 Material Purpose Parameter	图号 Figure	国内外相似替换器件型号 Replace of similar type	备注 Notes	外形参考图 Reference shape
SK3579-RT	RCA	2A, 200V, 0.015A, 2V	F-48			
SK3580-RT	RCA	20A, 400V, 0.015A, 2V	F-48			
SK3581-RT	RCA	35A, 200V, 0.04A, 2V	F-48			
SK3582-RT	RCA	35A, 400V, 0.04A, 2V	F-48			
SK3597-RT	RCA	4A, 200V, 200 μA, 0.8V	B-85			
SK3598-RT	RCA	4A, 400V, 200 μA, 0.8V	B-85			
SK3611-RT	RCA	15A, 200V, 0.03A, 2.5V	D-9			
SK3612-RT	RCA	6A, 200V, 0.025A, 2.2V	D-9			
SK3613-RT	RCA	20A, 200V, 0.015A, 2.4V				
SKAT28F06CP	SEK	45A, 500V	F-47			
SKAT28F08CP	SEK	45A, 800V	F-47			
SKAT28F10CP	SEK	45A, 1kV	F-47			
SKAT28F11CP	SEK	45A, 1.1kV	F-47			
SKAT28F12CP	SEK	45A, 1.2kV	F-47			
SKB33-02	SEK	60V, 0.1A, 3V	H-6			
SKB33-08	SEK	250V, 0.1A, 3V	H-6			
SKB33-10	SEK	300V, 0.1A, 3V	H-6			
SKB33-12	SEK	380V, 0.1A, 3V	H-6			
SKBH28-04		28A, 400V, 0.1A, 2V				
SKBH28-08		28A, 800V, 0.1A, 2V				
SKBH28-12		28A, 1.2kV, 0.1A, 2V				
SKBH28-14		28A, 1.4kV, 0.1A, 2V				
SKRH28-16		28A, 1.6kV, 0.1A, 2V				

器件型号 Element type	厂名 Manufacturers	材料用途参数 Material Purpose Parameter	图号 Figure	国内外相似替换器件型号 Replace of similar type	备注 Notes	外形参考图 Reference shape
SKBT28-04		28A, 400V, 0.1A, 2V				
SKBT28-08		28A, 800V, 0.1A, 2V				
SKBT28-12		28A, 1.2kV, 0.1A, 2V				
SKBT28-14		28A, 1.4kV, 0.1A, 2V				
SKBT28-16		28A, 1.6kV, 0.1A, 2V				
SKBT40-04	SEK	46A, 400V, 0.15A, 3V	H-7			 图 H-7
SKBT40-08	SEK	46A, 800V, 0.15A, 3V	H-7			
SKBT40-12	SEK	46A, 1.2kV, 0.15A, 3V	H-7			
SKBT40-16	SEK	46A, 1.6kV, 0.15A, 3V	H-7			
SKBZ28-04		28A, 400V, 0.1A, 2V				
SKBZ28-08		28A, 800V, 0.1A, 2V				
SKBZ28-12		28A, 1.2kV, 0.1A, 2V				
SKBZ28-14		28A, 1.4kV, 0.1A, 2V				
SKBZ28-16		28A, 1.6kV, 0.1A, 2V				
SKCH28-04		28A, 400V, 0.1A, 2V				
SKCH28-08		28A, 800V, 0.1A, 2V				
SKCH28-12		28A, 1.2kV, 0.1A, 2V				
SKCH28-14		28A, 1.4kV, 0.1A, 2V				
SKCH28-16		28A, 1.6kV, 0.1A, 2V				
SKCH40-04	SEK	46A, 400V, 0.15A, 3V	H-7			 图 H-8
SKCH40-08	SEK	46A, 800V, 0.15A, 3V	H-7			
SKCH40-12	SEK	46A, 1.2kV, 0.15A, 3V	H-7			
SKCH40-16	SEK	46A, 1.6kV, 0.15A, 3V	H-7			
SKDT60-04	SEK	61A, 400V, 0.15A, 3V	H-8			

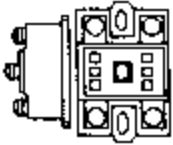
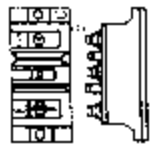
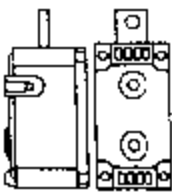
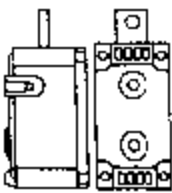
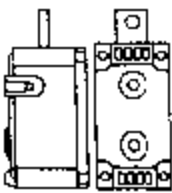
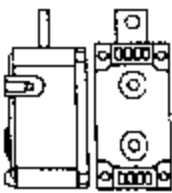

器件型号 Element type	厂名 Manufacturers	材料用途参数 Material Purpose Parameter	图号 Figure	国内外相似替换器件型号 Replace of similar type	备注 Notes	外形参考图 Reference shape
SKDT60-06	SEK	SCB 61A, 800V, 0.15A, 3V	H-8			 图 H-8
SKDT60-12	SEK	SCB 61A, 1.2kV, 0.15A, 3V	H-8			
SKDT60-16	SEK	SCB 61A, 1.6kV, 0.15A, 3V	H-8			
SKDT100-04	SEK	SCB 98A, 400V, 0.15A, 3V	H-8			 图 H-17
SKDT100-08	SEK	SCB 98A, 800V, 0.15A, 3V	H-8			
SKDT100-12	SEK	SCB 98A, 1.2kV, 0.15A, 3V	H-8			
SKDT100-16	SEK	SCB 98A, 1.6kV, 0.15A, 3V	H-8			
SKFH40-08	SEK	SCA 40A, 800V, 0.15A, 3V	H-17			 图 H-10
SKFH40-10	SEK	SCA 40A, 1kV, 0.15A, 3V	H-17			
SKFH40-12	SEK	SCA 40A, 1.2kV, 0.15A, 3V	H-17			
SKFH56-12D		60A, 1.2kV, 0.15A, 3V				
SKFH60-10	SEK	SCA 60A, 1kV, 0.15A, 3V	H-17			 图 H-10
SKFH60-12	SEK	SCA 60A, 1.2kV, 0.15A, 3V	H-17			
SKFH110-04	SEK	SCA 110A, 400V, 0.25A, 4V	H-10			
SKFH110-06	SEK	SCA 110A, 800V, 0.25A, 4V	H-10			
SKFH110-10	SEK	SCA 110A, 1kV, 0.25A, 4V	H-10			
SKFH150-06DS		150A, 600V				 图 H-10
SKFH150-08DS		150A, 800V				
SKFH150-09DS		150A, 900V				
SKFH150-10DS		150A, 1kV				
SKFL40-08	SEK	SCA 40A, 800V, 0.15A, 3V	H-17			 图 H-10
SKFL40-10	SEK	SCA 40A, 1kV, 0.15A, 3V	H-17			

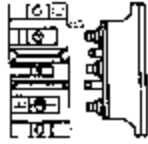
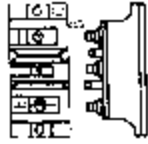
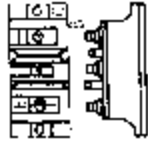
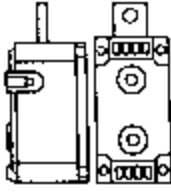
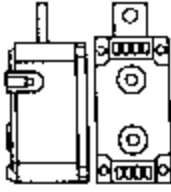
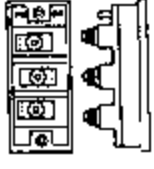
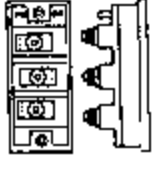
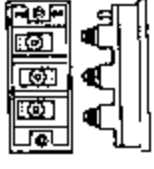
器件型号 Element type	厂名 Manufacturers	材料用途参数 Material Purpose Parameter	图号 Figure	国内外相似替换器件型号 Replace of similar type	备注 Notes	外形参考图 Reference shape
SKFL40-12	SEK	SCA 40A, 1.2kV, 0.15A, 3V	H-17			
SKFL60-10	SEK	SCA 60A, 1kV, 0.15A, 3V	H-17			
SKFL60-12	SEK	SCA 60A, 1.2kV, 0.15A, 3V	H-17			
SKFL110-04	SEK	SCA 110A, 400V, 0.25A, 4V	H-10			
SKFL110-08	SEK	SCA 110A, 800V, 0.25A, 4V	H-10			
SKFL110-10	SEK	SCA 110A, 1kV, 0.25A, 4V	H-10			
SKFT10-06	SEK	SCA 10A, 600V, 0.15A, 3V	H-19			
SKFT10-08	SEK	SCA 10A, 800V, 0.15A, 3V	H-19			
SKFT10-10	SEK	SCA 10A, 1kV, 0.15A, 3V	H-19			
SKFT10-12	SEK	SCA 10A, 1.2kV, 0.15A, 3V	H-19			
SKFT20-06	SEK	SCA 20A, 600V, 0.15A, 3V	H-17			
SKFT20-08	SEK	SCA 20A, 800V, 0.15A, 3V	H-17			
SKFT20-10	SEK	SCA 20A, 1kV, 0.15A, 3V	H-17			
SKFT20-12	SEK	SCA 20A, 1.2kV, 0.15A, 3V	H-17			
SKFT30-06	SEK	SCA 30A, 600V, 0.2A, 3V	H-17			
SKFT30-08	SEK	SCA 30A, 800V, 0.2A, 3V	H-17			
SKFT30-10	SEK	SCA 30A, 1kV, 0.2A, 3V	H-17			
SKFT30-12	SEK	SCA 30A, 1.2kV, 0.2A, 3V	H-17			
SKFT40-08	SEK	SCA 40A, 800V, 0.15A, 3V	H-17			
SKFT40-10	SEK	SCA 40A, 1kV, 0.15A, 3V	H-17			
SKFT40-12	SEK	SCA 40A, 1.2kV, 0.15A, 3V	H-17			
SKFT60-08	SEK	SCA 60A, 800V, 0.15A, 3V	H-17			

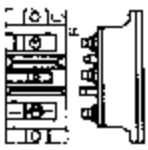
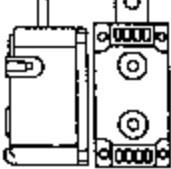
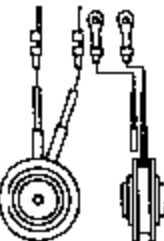
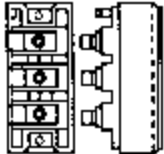
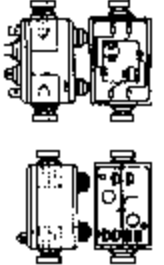
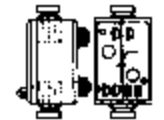
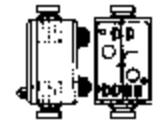

器件型号 Element type	厂名 Manufacturers	材料用途参数 Material Purpose Parameter	图号 Figure	国内外相似替换器件型号 Replace of similar type	备注 Notes	外形参考图 Reference shape
SKFT60-10	SEK	SCA 60A, 1kV, 0.15A, 3V	H-17			
SKFT60-12	SEK	SCA 60A, 1.2kV, 0.15A, 3V	H-17			
SKFT110-04	SEK	SCA 110A, 400V, 0.25A, 4V	H-10			 图 H-10
SKFT110-08	SEK	SCA 110A, 800V, 0.25A, 4V	H-10			
SKFT110-10	SEK	SCA 110A, 1kV, 0.25A, 4V	H-10			
SKFT110-12	SEK	SCA 110A, 1.2kV, 0.25A, 4V	C-39			
SKFT110-14	SEK	SCA 110A, 1.4kV, 0.25A, 4V	H-13			
SKIT540-08	SEK	460A, 800V, 0.25A, 5V	H-5			 图 H-5
SKIT540-12	SEK	850A, 1.2kV, 0.25A, 5V	H-5			
SKIT540-14	SEK	850A, 1.4kV, 0.25A, 5V	H-5			
SKIT540-16	SEK	850A, 1.6kV, 0.25A, 5V	H-5			
SKIT650-08	SEK	580A, 800V, 0.25A, 5V	H-5			 图 C-39
SKIT650-12	SEK	1.07kA, 1.2kV, 0.25A, 5V	H-5			
SKIT650-14	SEK	1.07kA, 1.4kV, 0.25A, 5V	H-5			
SKIT650-16	SEK	1.07kA, 1.6kV, 0.25A, 5V	H-5			
SKIW250-08	SEK	SCA 250A, 800V, 0.2A, 3V	H-4			 图 H-13
SKIW250-14	SEK	SCA 250A, 1.4kV, 0.2A, 3V	H-4			
SKIW500-08	SEK	SCA 500A, 800V, 0.2A, 3V	H-4			 图 H-4
SKIW500-12	SEK	SCA 500A, 1.2kV, 0.2A, 3V	H-4			
SKIW500-14	SEK	SCA 500A, 1.4kV, 0.2A, 3V	H-4			
SKIW700-08	SEK	SCA 700A, 800V, 0.2A, 3V	H-4			 图 H-5
SKIW700-12	SEK	SCA 700A, 1.2kV, 0.2A, 3V	H-4			
SKIW700-14	SEK	SCA 700A, 1.4kV, 0.2A, 3V	H-4			

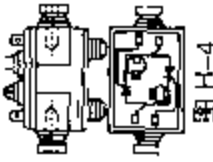
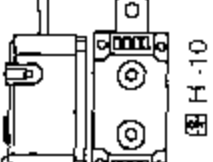
器件型号 Element type	厂名 Manufacturers	材料用途参数 Material Purpose Parameter	图号 Figure	国内外相似替换器件型号 Replace of similar type	备注 Notes	外形参考图 Reference shape
SKW700-16	SEK	SCA 700A, 1.6KV, 0.2A, 3V	H-4			 图 H-4
SKIW900-08	SEK	SCA 900A, 800V, 0.2A, 3V	H-4			
SKIW900-12	SEK	SCA 900A, 1.2KV, 0.2A, 3V	H-4			
SKIW900-14	SEK	SCA 900A, 1.4KV, 0.2A, 3V	H-4			
SKIW900-16	SEK	SCA 900A, 1.6KV, 0.2A, 3V	H-4			
SKKD201-08	SEK	SCA 200A, 800V	H-10			
SKKD201-12	SEK	SCA 200A, 1.2KV	H-10			
SKKD201-16	SEK	SCA 200A, 1.6KV	H-10			 图 H-10
SKKH15-02	SEK	17.5A, 200V, 0.1A, 3V	H-19			
SKKH15-04	SEK	SCA 15A, 400V, 0.1A, 3V	H-19			
SKKH15-04D	SEK	17A, 400V, 0.1A, 3V	H-19			
SKKH15-06	SEK	SCA 15A, 600V, 0.1A, 3V	H-19			
SKKH15-06D	SEK	17A, 600V, 0.1A, 3V	H-19			
SKKH15-08	SEK	SCA 15A, 800V, 0.1A, 3V	H-19			
SKKH15-08D	SEK	17A, 800V, 0.1A, 3V	H-19			
SKKH15-12	SEK	SCA 15A, 1.2KV, 0.1A, 3V	H-19			
SKKH15-12D	SEK	17A, 1.2KV, 0.1A, 3V	H-19			
SKKH15-14	SEK	SCA 15A, 1.4KV, 0.1A, 3V	H-19			
SKKH15-14D	SEK	17A, 1.4KV, 0.1A, 3.5V	H-19			
SKKH15-16	SEK	SCA 15A, 1.6KV, 0.1A, 3V	H-19			
SKKH15-16D	SEK	17A, 1.6KV, 0.1A, 3V	H-19			
SKKH26-04	SEK	SCA 25A, 400V, 0.15A, 3V	H-17			
SKKH26-06	SEK	SCA 25A, 600V, 0.15A, 3V	H-17			
SKKH26-08	SEK	SCA 25A, 800V, 0.15A, 3V	H-17			
SKKH26-12	SEK	SCA 25A, 1.2KV, 0.15A, 3V	H-17			



器件型号 Element type	厂名 Manufacturers	材料用途参数 Material Purpose Parameter	图号 Figure	国内外相似替换器件型号 Replace of similar type	备注 Notes	外形参考图 Reference shape
SKKH26-14	SEK	SCA 25A, 1.4kV, 0.15A, 3V	H-17			 <p>图 H-17</p>
SKKH26-16	SEK	SCA 25A, 1.6kV, 0.15A, 3V	H-17			
SKKH41-04	SEK	SCA 40A, 400V, 0.15A, 3V	H-17			
SKKH41-06	SEK	SCA 40A, 600V, 0.15A, 3V	H-17			
SKKH41-08	SEK	SCA 40A, 800V, 0.15A, 3V	H-17			
SKKH41-12	SEK	SCA 40A, 1.2kV, 0.15A, 3V	H-17			
SKKH41-14	SEK	SCA 40A, 1.4kV, 0.15A, 3V	H-17			
SKKH41-16	SEK	SCA 40A, 1.6kV, 0.15A, 3V	H-17			
SKKH56-04	SEK	SCA 55A, 400V, 0.15A, 3V	H-29			
SKKH56-06	SEK	SCA 55A, 600V, 0.15A, 3V	H-17			
SKKH56-08	SEK	SCA 55A, 800V, 0.15A, 3V	H-17			
SKKH56-12	SEK	SCA 55A, 1.2kV, 0.15A, 3V	H-17			
SKKH56-14	SEK	SCA 55A, 1.4kV, 0.15A, 3V	H-17			
SKKH56-16	SEK	SCA 55A, 1.6kV, 0.15A, 3V	H-17			
SKKH71-04	SEK	SCA 70A, 400V, 0.15A, 3V	H-17			
SKKH71-06	SEK	SCA 70A, 600V, 0.15A, 3V	H-17			
SKKH71-08	SEK	SCA 70A, 800V, 0.15A, 3V	H-17			
SKKH71-12	SEK	SCA 70A, 1.2kV, 0.15A, 3V	H-17			
SKKH71-14	SEK	SCA 70A, 1.4kV, 0.15A, 3V	H-17			
SKKH71-16	SEK	SCA 70A, 1.6kV, 0.15A, 3V	H-17			
SKKH91-04	SEK	SCA 90A, 400V, 0.15A, 3V	H-29			
SKKH91-06	SEK	SCA 90A, 600V, 0.15A, 3V	H-17			
SKKH91-08	SEK	SCA 90A, 800V, 0.15A, 3V	H-17			
SKKH91-12	SEK	SCA 90A, 1.2kV, 0.15A, 3V	H-17			
SKKH91-14	SEK	SCA 90A, 1.4kV, 0.15A, 3V	H-17			

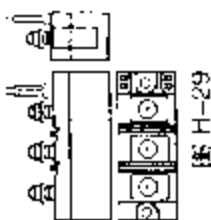

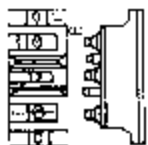
器件型号 Element type	厂名 Manufacturers	材料用途参数 Material Purpose Parameter	图号 Figure	国内外相似替换器件型号 Replace of similar type	备注 Notes	外形参考图 Reference shape
SKKH91-16	SEK	SCA 90A, 1.6kV, 0.15A, 3V	H-17			
SKKH105-04D		106A, 400V				
SKKH105-08D		106A, 800V, 0.15A, 3V				
SKKH105-12E		106A, 1.2kV, 0.15A, 3V				
SKKH105-14E		106A, 1.4kV, 0.15A, 3V				
SKKH105-16E		106A, 1.6kV, 0.15A, 3V				
SKKH131-08	SEK	SCA 143A, 800V, 0.2A, 3V	H-10			
SKKH131-12	SEK	SCA 143A, 1.2kV, 0.2A, 3V	C-39			
SKKH131-14	SEK	SCA 143A, 1.4kV, 0.2A, 3V	H-10			
SKKH131-16	SEK	SCA 143A, 1.6kV, 0.2A, 3V	C-39			
SKKH132-12E		130A, 1.2kV, 0.2A, 2V				
SKKH132-14E		130A, 1.4kV, 0.2A, 2V				
SKKH132-16E		130A, 1.6kV, 0.2A, 2V				
SKKH132-18E		130A, 1.8kV, 0.2A, 2V				
SKKH161-08	SEK	SCA 160A, 800V, 0.2A, 3V	H-10			
SKKH161-12	SEK	SCA 160A, 1.2kV, 0.2A, 3V	C-39			
SKKH161-14	SEK	SCA 160A, 1.4kV, 0.2A, 3V	C-39			
SKKH161-16	SEK	SCA 160A, 1.6kV, 0.2A, 3V	C-39			
SKKH250-12E		250A, 1.2kV, 0.2A, 3V				
SKKH250-14E		250A, 1.4kV, 0.2A, 3V				
SKKH250-16E		250A, 1.6kV, 0.2A, 3V				
SKKH250-18E		250A, 1.8kV, 0.2A, 3V				
SKKL41-04	SEK	SCA 40A, 400V, 0.15A, 3V	H-17			
SKKL41-06	SEK	SCA 40A, 600V, 0.15A, 3V	H-17			



图 C-39



图 H-10



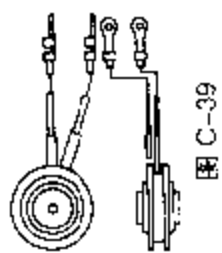



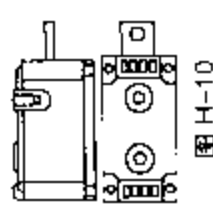

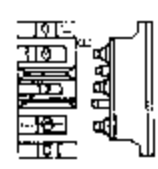
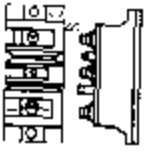
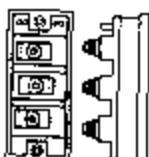

图 H-17

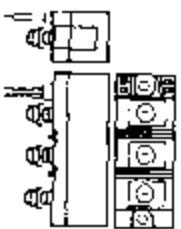
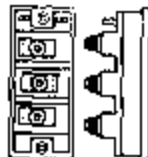

器件型号 Element type	厂名 Manufacturers	材料用途参数 Material Purpose Parameter	图号 Figure	国内外相似替换器件型号 Replace of similar type	备注 Notes	外形参考图 Reference shape
SKKL41-08	SEK	SCA 40A, 800V, 0.15A, 3V	H-17			 图 H-17
SKKL41-12	SEK	SCA 40A, 1.2kV, 0.15A, 3V	H-17			
SKKL41-14	SEK	SCA 40A, 1.4kV, 0.15A, 3V	H-17			
SKKL41-16	SEK	SCA 40A, 1.6kV, 0.15A, 3V	H-17			
SKKL56-04	SEK	SCA 55A, 400V, 0.15A, 3V	H-17			 图 H-19
SKKL56-06	SEK	SCA 55A, 600V, 0.15A, 3V	H-17			
SKKL56-08	SEK	SCA 55A, 800V, 0.15A, 3V	H-17			
SKKL56-12	SEK	SCA 55A, 1.2kV, 0.15A, 3V	H-17			
SKKL56-14	SEK	SCA 55A, 1.4kV, 0.15A, 3V	H-17			
SKKL56-16	SEK	SCA 55A, 1.6kV, 0.15A, 3V	H-17			
SKKL71-06	SEK	SCA 70A, 600V, 0.15A, 3V	H-17			 图 H-17
SKKL71-08	SEK	SCA 70A, 800V, 0.15A, 3V	H-17			
SKKL71-12	SEK	SCA 70A, 1.2kV, 0.15A, 3V	H-17			
SKKL71-14	SEK	SCA 70A, 1.4kV, 0.15A, 3V	H-17			
SKKL71-16	SEK	SCA 70A, 1.6kV, 0.15A, 3V	H-17			
SKKL91-04	SEK	SCA 90A, 400V, 0.15A, 3V	H-17			
SKKL91-06	SEK	SCA 90A, 600V, 0.15A, 3V	H-17			 图 H-19
SKKL91-08	SEK	SCA 90A, 800V, 0.15A, 3V	H-17			
SKKL91-12	SEK	SCA 90A, 1.2kV, 0.15A, 3V	H-17			
SKKL91-14	SEK	SCA 90A, 1.4kV, 0.15A, 3V	H-17			
SKKL91-16	SEK	SCA 90A, 1.6kV, 0.15A, 3V	H-17			
SKKL131-14	SEK	SCA 143A, 2kV, 0.2A, 3V	H-17			
SKKT15-02	SEK	17.5A, 200V, 0.1A, 3V	H-19			 图 H-19
SKKT15-04	SEK	17.5A, 400V, 0.1A, 3V	H-19			

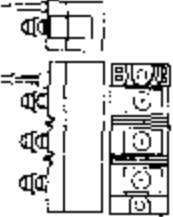
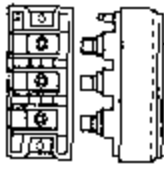
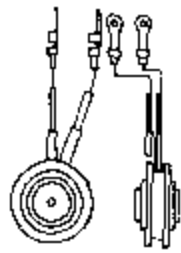

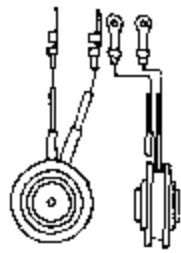

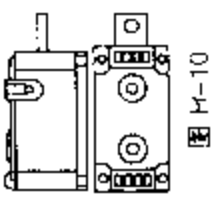
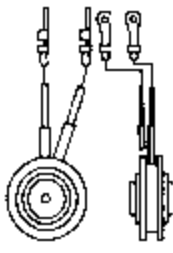
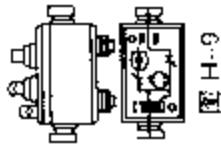
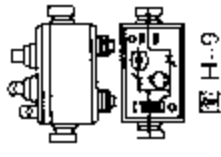
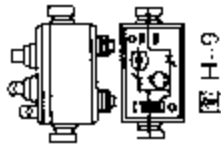
器件型号 Element type	厂名 Manufacturers	材料用途参数 Material Purpose Parameter	图号 Figure	国内外相似替换器件型号 Repace of similar type	备注 Notes	外形参考图 Reference shape
SKKT15-04D	SEK	SCA 17A, 400V, 0.1A, 3V	H-29			 图 H-29
SKKT15-06	SEK	SCA 17A, 600V, 0.1A, 3V	H-29			
SKKT15-08	SEK	17.5A, 800V, 0.1A, 3V	H-19			
SKKT15-08D	SEK	SCA 17A, 800V, 0.1A, 3V	H-19			
SKKT15-14D	SEK	SCA 17A, 1.4kV, 0.1A, 3V	H-19			
SKKT15-16	SEK	SCA 15A, 1.6kV, 0.1A, 3V	H-19			
SKKT19-06	SEK	SCA 25A, 600V, 0.15A, 3V	H-29			 图 H-29
SKKT19-08	SEK	SCA 25A, 800V, 0.15A, 3V	H-29			
SKKT19-12	SEK	SCA 25A, 1.2kV, 0.15A, 3V	H-29			
SKKT19-14	SEK	SCA 25A, 1.4kV, 0.15A, 3V	H-29			
SKKT19-16	SEK	SCA 25A, 1.6kV, 0.15A, 3V	H-29			
SKKT26-04	SEK	SCA 32A, 400V, 0.15A, 3V	H-29			
SKKT26-06	SEK	SCA 25A, 600V, 0.15A, 3V	H-29			
SKKT26-12	SEK	SCA 32A, 1.2kV, 0.15A, 3V	H-29			
SKKT26-14	SEK	SCA 32A, 1.4kV, 0.15A, 3V	H-29			
SKKT26-16	SEK	SCA 32A, 1.6kV, 0.15A, 3V	H-29			
SKKT41-04	SEK	SCA 48A, 400V, 0.15A, 3V	H-29			 图 H-19
SKKT41-06	SEK	SCA 48A, 600V, 0.15A, 3V	H-29			
SKKT41-08	SEK	SCA 48A, 800V, 0.15A, 3V	H-29			
SKKT41-12	SEK	SCA 48A, 1.2kV, 0.15A, 3V	H-29			
SKKT41-14	SEK	SCA 48A, 1.4kV, 0.15A, 3V	H-29			
SKKT41-16	SEK	SCA 48A, 1.6kV, 0.15A, 3V	H-29			
SKKT56-04	SEK	SCA 60A, 400V, 0.15A, 3V	H-29			 图 H-19
SKKT56-06	SEK	SCA 60A, 600V, 0.15A, 3V	H-29			
SKKT56-08	SEK	SCA 60A, 800V, 0.15A, 3V	H-29			

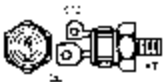
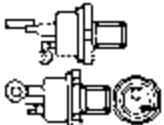

器件型号 Element type	厂名 Manufacturers	材料用途参数 Material Purpose Parameter	图号 Figure	国内外相似替换器件型号 Replace of similar type	备注 Notes	外形参考图 Reference shape
SKKT56-12	SEK	SCA 60A, 1.2kV, 0.15A, 3V	H-29			 图 H-29
SKKT56-14	SEK	SCA 60A, 1.4kV, 0.15A, 3V	H-29			
SKKT56-16	SEK	SCA 60A, 1.6kV, 0.15A, 3V	H-29			
SKKT71-08	SEK	SCA 80A, 800V, 0.15A, 3V	H-29			
SKKT71-12	SEK	SCA 80A, 1.2kV, 0.15A, 3V	H-29			 图 H-13
SKKT71-14	SEK	SCA 80A, 1.4kV, 0.15A, 3V	H-29			
SKKT71-16	SEK	SCA 80A, 1.6kV, 0.15A, 3V	H-29			
SKKT91-02	SEK	SCA 90A, 200V, 0.15A, 3V	H-29			
SKKT91-04	SEK	SCA 90A, 400V, 0.15A, 3V	H-29			 图 C-39
SKKT91-06	SEK	SCA 90A, 600V, 0.15A, 3V	H-29			
SKKT91-08	SEK	SCA 90A, 800V, 0.15A, 3V	H-29			
SKKT91-12	SEK	SCA 90A, 1.2kV, 0.15A, 3V	H-29			
SKKT91-14	SEK	SCA 90A, 1.4kV, 0.15A, 3V	H-29			
SKKT91-16	SEK	SCA 90A, 1.6kV, 0.15A, 3V	H-29			
SKKT105-08D		106A, 800V, 0.15A, 3V				
SKKT105-12E		106A, 1.2kV, 0.15A, 3V				
SKKT105-14E		106A, 1.4kV, 0.15A, 3V				
SKKT105-16E		106A, 1.6kV, 0.15A, 3V				
SKKT130-04	SEK	SCA 220A, 400V, 0.2A, 3V	H-13			 H-10
SKKT130-06	SEK	SCA 220A, 600V, 0.2A, 3V	H-13			
SKKT130-08	SEK	SCA 220A, 800V, 0.2A, 3V	H-13			
SKKT130-12	SEK	SCA 220A, 1.2kV, 0.2A, 3V	H-13			
SKKT130-16	SEK	SCA 220A, 1.6kV, 0.2A, 3V	H-13			
SKKT131-08	SEK	SCA 143A, 800V, 0.2A, 3V	H-10			 图 C-39
SKKT131-12	SEK	SCA 143A, 1.2kV, 0.2A, 3V	C-39			

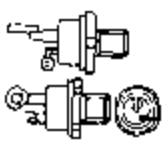

器件型号 Element type	厂名 Manufacturers	材料用途参数 Material Purpose Parameter	图号 Figure	国内外相似替换器件型号 Replace of similar type	备注 Notes	外形参考图 Reference shape
SKKT131-14	SEK	SCA 143A, 1.4kV, 0.2A, 3V	H-10			 图 H-10
SKKT131-16	SEK	SCA 143A, 1.6kV, 0.2A, 3V	C-39			
SKKT132-08D		130A, 800V, 0.2A, 2V				
SKKT132-12E		130A, 1.2kV, 0.2A, 2V				
SKKT132-14E		130A, 1.4kV, 0.2A, 2V				
SKKT132-16E		130A, 1.6kV, 0.2A, 2V				
SKKT132-18E		130A, 1.8kV, 0.2A, 2V				
SKKT162-08D		136A, 800V, 0.2A, 2V				 图 C-39
SKKT162-12E		136A, 1.2kV, 0.2A, 2V				
SKKT162-14E		136A, 1.4kV, 0.2A, 2V				
SKKT162-16E		136A, 1.6kV, 0.2A, 2V				
SKKT162-18E		136A, 1.8kV, 0.2A, 2V				
SKKT210-08D		210A, 800V, 0.2A, 3V				 图 H-9
SKKT210-12E		210A, 1.2kV, 0.2A, 3V				
SKKT210-14E		210A, 1.4kV, 0.2A, 3V				
SKKT210-16E		210A, 1.6kV, 0.2A, 3V				
SKKT210-18E		210A, 1.8kV, 0.2A, 3V				
SKLT220-08	SEK	SCA 350A, 800V, 0.2A, 3V	H-9			 图 H-9
SKLT220-12	SEK	SCA 350A, 1.2kV, 0.2A, 3V	H-9			
SKLT220-14	SEK	SCA 350A, 1.4kV, 0.2A, 3V	H-9			
SKLT220-16	SEK	SCA 350A, 1.6kV, 0.2A, 3V	H-9			
SKKT250-08D		250A, 800V, 0.2A, 3V				 图 H-9
SKKT250-12E		250A, 1.2kV, 0.2A, 3V				
SKKT250-14E		250A, 1.4kV, 0.2A, 3V				
SKKT250-16E		250A, 1.6kV, 0.2A, 3V				



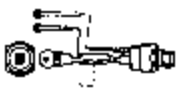

器件型号 Element type	厂名 Manufacturers	材料用途参数 Material Purpose Parameter	图号 Figure	国内外相似替换器件型号 Replace of similar type	备注 Notes	外形参考图 Reference shape
SKKT250-18E		250A, 1.8kV, 0.2A, 3V				
SKNH19-12D		18A, 1.2kV, 0.15A, 3V				
SKNH26-08D		25A, 800V, 0.15A, 3V				
SKNH26-12D		25A, 1.2kV, 0.15A, 3V				
SKT10-02	SEK	30A, 200V, 0.05A, 3V	F-47			 图 F-47
SKT10-04	SEK	30A, 400V, 0.05A, 3V	F-47			
SKT10-06	SEK	30A, 600V, 0.05A, 3V	F-47			
SKT10-08	SEK	30A, 800V, 0.05A, 3V	F-47			
SKT10-10	SEK	30A, 1kV, 0.05A, 3V	F-47			
SKT10-12	SEK	30A, 1.2kV, 0.05A, 3V	F-47			
SKT12F02	SEK	23A, 200V, 0.1A, 3V	F-48			 图 F-48
SKT12F04	SEK	12A, 400V, 0.1A, 3V	F-48			
SKT12F06	SEK	12A, 600V, 0.1A, 3V	F-48			
SKT12F08	SEK	12A, 800V, 0.1A, 3V	F-48			
SKT12F10	SEK	12A, 1kV, 0.1A, 3V	F-48			
SKT12F12	SEK	12A, 1.2kV, 0.1A, 3V	F-48			
SKT16-02	SEK	40A, 200V, 0.08A, 3V	F-48			
SKT16-04	SEK	40A, 400V, 0.08A, 3V	F-48			
SKT16-06	SEK	40A, 600V, 0.08A, 3V	F-48			
SKT16-08	SEK	40A, 800V, 0.08A, 3V	F-48			
SKT16-10	SEK	40A, 1kV, 0.08A, 3V	F-48			
SKT16-12	SEK	40A, 1.2kV, 0.08A, 3V	F-48			
SKT16-14	SEK	40A, 1.4kV, 0.08A, 3V	F-48			
SKT16-16	SEK	40A, 1.6kV, 0.08A, 3V	F-48			

器件型号 Element type	厂名 Manufacturers	材料用途参数 Material Purpose Parameter	图号 Figure	国内外相似替换器件型号 Replace of similar type	备注 Notes	外形参考图 Reference shape
SKT16F02	SEK	16A, 200V, 0.1A, 3V	F-48			 图 F-48
SKT16F04	SEK	16A, 400V, 0.1A, 3V	F-48			
SKT16F06	SFK	16A, 600V, 0.1A, 3V	F-48			
SKT16F08	SEK	16A, 800V, 0.1A, 3V	F-48			
SKT16F10	SEK	16A, 1kV, 0.1A, 3V	F-48			
SKT16F12	SEK	30A, 1.2kV, 0.1A, 3V	F-48			
SKT24-02	SEK	50A, 200V, 0.08A, 3V	F-48			 图 F-47
SKT24-04	SEK	50A, 400V, 0.08A, 3V	F-48			
SKT24-06	SEK	50A, 600V, 0.08A, 3V	F-48			
SKT24-08	SEK	50A, 800V, 0.08A, 3V	F-48			
SKT24-10	SEK	50A, 1kV, 0.08A, 3V	F-48			
SKT24-12	SEK	50A, 1.2kV, 0.08A, 3V	F-48			
SKT24-14	SEK	50A, 1.4kV, 0.08A, 3V	F-48			 图 F-21
SKT24-16	SEK	50A, 1.6kV, 0.08A, 3V	F-48			
SKT25F04	SEK	GTO 25A, 400V, 0.15A, 4V	F-47			
SKT25F08	SEK	GTO 25A, 800V, 0.15A, 4V	F-47			
SKT25F10	SEK	GTO 25A, 1kV, 0.15A, 4V	F-47			
SKT25F12	SEK	GTO 25A, 1.2kV, 0.15A, 4V	F-47			
SKT40-02	SEK	63A, 200V, 0.1A, 3V	F-21			
SKT40-04	SEK	63A, 400V, 0.1A, 3V	F-21			
SKT40-06	SEK	63A, 600V, 0.1A, 3V	F-21			
SKT40-08	SEK	63A, 800V, 0.1A, 3V	F-21			
SKT40-10	SEK	63A, 1kV, 0.1A, 3V	F-21			
SKT40-12	SEK	63A, 1.2kV, 0.1A, 3V	F-21			
SKT40-14	SEK	63A, 1.4kV, 0.1A, 3V	F-21			
SKT40-16	SEK	63A, 1.6kV, 0.1A, 3V	F-21			

器件型号 Element type	厂名 Manufacturers	材料用途参数 Material Purpose Parameter	图号 Figure	国内外相似替换器件型号 Replace of similar type	备注 Notes	外形参考图 Reference shape
SKT45F02	SEK	54A, 200V, 0.15A, 5V	F-91			 图 F-91
SKT45F04	SEK	54A, 400V, 0.15A, 5V	F-91			
SKT45F06	SEK	54A, 600V, 0.15A, 5V	F-91			
SKT45F08	SEK	54A, 800V, 0.15A, 5V	F-91			
SKT45F10	SEK	54A, 1kV, 0.15A, 5V	F-91			
SKT45F12	SEK	54A, 1.2kV, 0.15A, 5V	F-91			
SKT50-02	SEK	45A, 200V, 0.15A, 3V	F-21			 图 F-21
SKT50-04	SEK	45A, 400V, 0.15A, 3V	F-21			
SKT50-06	SEK	45A, 600V, 0.15A, 3V	F-21			
SKT50-08	SEK	45A, 800V, 0.15A, 3V	F-21			
SKT50-10	SEK	45A, 1kV, 0.15A, 3V	F-21			
SKT50-12	SEK	45A, 1.2kV, 0.15A, 3V	F-21			
SKT50-14	SEK	45A, 1.4kV, 0.15A, 3V	F-21			
SKT50-16	SEK	45A, 1.6kV, 0.15A, 3V	F-21			
SKT55-02	SEK	110A, 200V, 0.15A, 3V	F-91			 图 F-71
SKT55-04	SEK	110A, 400V, 0.15A, 3V	F-91			
SKT55-06	SEK	110A, 600V, 0.15A, 3V	F-91			
SKT55-08	SEK	110A, 800V, 0.15A, 3V	F-91			
SKT55-10	SEK	110A, 1kV, 0.15A, 3V	F-91			
SKT55-12	SEK	110A, 1.2kV, 0.15A, 3V	F-91			
SKT55-16	SEK	110A, 1.6kV, 0.15A, 3V	F-91			
SKT70F02	SEK	70A, 200V, 0.15A, 5V	F-71			
SKT70F04	SEK	70A, 400V, 0.15A, 5V	F-71			
SKT70F06	SEK	70A, 600V, 0.15A, 5V	F-71			
SKT70F08	SEK	70A, 800V, 0.15A, 5V	F-91			
SKT70F10	SEK	70A, 1kV, 0.15A, 5V	F-91			

器件型号 Element type	厂名 Manufacturers	材料用途参数 Material Purpose Parameter	图号 Figure	国内外相似替换器件型号 Replace of similar type	备注 Notes	外形参考图 Reference shape
SKT70F12	SEK	70A, 1.2kV, 0.15A, 5V	F-71			 图 F-71
SKT80-02	SEK	135A, 200V, 0.15A, 3V	F-91			
SKT80-04	SEK	135A, 400V, 0.15A, 3V	F-91			
SKT80-06	SEK	135A, 600V, 0.15A, 3V	F-91			
SKT80-08	SEK	135A, 800V, 0.15A, 3V	F-91			
SKT80-10	SEK	135A, 1kV, 0.15A, 3V	F-91			
SKT80-12	SEK	135A, 1.2kV, 0.15A, 3V	F-91			
SKT80-16	SEK	135A, 1.6kV, 0.15A, 3V	F-91			
SKT100-02	SEK	170A, 200V, 0.15A, 3V	F-91			
SKT100-04	SEK	170A, 400V, 0.15A, 3V	F-91			
SKT100-06	SEK	170A, 600V, 0.15A, 3V	F-91			
SKT100-08	SEK	170A, 800V, 0.15A, 3V	F-91			
SKT100-10	SEK	170A, 1kV, 0.15A, 3V	F-91			
SKT100-12	SEK	170A, 1.2kV, 0.15A, 3V	F-91			
SKT100-16	SEK	170A, 1.6kV, 0.15A, 3V	F-91			
SKT110F02	SEK	110A, 200V, 0.2A, 5V	F-91			
SKT110F04	SEK	110A, 400V, 0.2A, 5V	F-91			
SKT110F06	SEK	110A, 600V, 0.2A, 5V	F-91			
SKT110F08	SEK	110A, 800V, 0.2A, 5V	F-91			
SKT110F10	SEK	110A, 1kV, 0.2A, 5V	F-91			
SKT110F12	SEK	110A, 1.2kV, 0.2A, 5V	F-91			 图 F-91
SKT130-02	SEK	220A, 200V, 0.2A, 3V	F-91			
SKT130-04	SEK	220A, 400V, 0.2A, 3V	F-91			
SKT130-06	SEK	220A, 600V, 0.2A, 3V	F-91			
SKT130-08	SEK	220A, 800V, 0.2A, 3V	F-91			

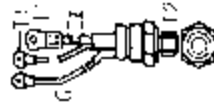

器件型号 Element type	厂名 Manufacturers	材料用途参数 Material Purpose Parameter	图号 Figure	国内外相似替换器件型号 Replace of similar type	备注 Notes	外形参考图 Reference shape
SKT130-12	SEK	220A, 1.2kV, 0.2A, 3V	F-91			 图 F-91
SKT130-14	SEK	220A, 1.4kV, 0.2A, 3V	F-91			
SKT130-16	SEK	220A, 1.6kV, 0.2A, 3V	F-91			
SKT160-02	SEK	280A, 200V, 0.2A, 3V	F-91			 图 F-91
SKT160-04	SEK	280A, 400V, 0.2A, 3V	F-91			
SKT160-06	SEK	280A, 600V, 0.2A, 3V	F-91			
SKT160-08	SEK	280A, 800V, 0.2A, 3V	F-91			
SKT160-10	SEK	280A, 1kV, 0.2A, 3V	F-91			
SKT160-12	SEK	280A, 1.2kV, 0.2A, 3V	F-91			
SKT160-14	SEK	280A, 1.4kV, 0.2A, 3V	F-91			
SKT160-16	SEK	280A, 1.6kV, 0.2A, 3V	F-91			
SKT170/02	SEK	170A, 200V, 0.25A, 3V	F-71			 图 F-71
SKT170/04	SEK	170A, 400V, 0.25A, 3V	F-71			
SKT170/06	SEK	170A, 600V, 0.25A, 3V	F-71			
SKT170/08	SEK	170A, 800V, 0.25A, 3V	E-30			
SKT170/10	SEK	170A, 1kV, 0.25A, 3V	E-30			
SKT170/12	SEK	170A, 1.2kV, 0.25A, 2.5V	E-30			
SKT215-02	SEK	375A, 200V, 0.25A, 3V	F-71			
SKT215-04	SEK	375A, 400V, 0.25A, 3V	F-71			
SKT215-06	SEK	375A, 600V, 0.25A, 3V	F-71			
SKT215-08	SEK	375A, 800V, 0.25A, 3V	F-71			
SKT215-10	SEK	375A, 1kV, 0.25A, 3V	F-71			
SKT215-12	SEK	375A, 1.2kV, 0.25A, 3V	F-71			
SKT215-14	SEK	375A, 1.4kV, 0.25A, 3.5V	F-71			
SKT215-16	SEK	375A, 1.6kV, 0.25A, 3V	F-71			

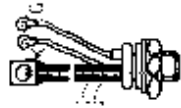
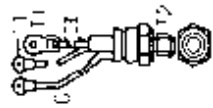
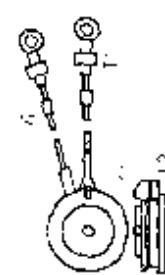

器件型号 Element type	厂名 Manufacturers	材料用途参数 Material Purpose Parameter	图号 Figure	国内外相似替换器件型号 Replace of similar type	备注 Notes	外形参考图 Reference shape
SKT220-02	SEK	220A, 200V, 0.25A, 3V	E-30			 图 E-30
SKT220-04	SEK	220A, 400V, 0.25A, 3V	E-30			
SKT220-06	SEK	220A, 600V, 0.25A, 3V	E-30			
SKT220-08	SEK	220A, 800V, 0.25A, 3V	F-71			
SKT220-10	SEK	220A, 1kV, 0.25A, 3V	E-30			
SKT220-12	SEK	220A, 1.2kV, 0.25A, 3V	E-30			
SKT220/02	SEK	450A, 200V, 0.25A, 3V	F-71			
SKT220/04	SEK	450A, 400V, 0.25A, 3V	F-71			
SKT220/06	SEK	450A, 600V, 0.25A, 3V	F-71			
SKT220/08	SEK	450A, 800V, 0.25A, 3V	F-71			
SKT230-02	SEK	600A, 200V, 0.15A, 3V	C-62			 图 F-71
SKT230-04	SEK	600A, 400V, 0.15A, 3V	C-62			
SKT230-06	SEK	600A, 600V, 0.15A, 3V	C-62			
SKT230-08	SEK	600A, 800V, 0.15A, 3V	C-62			
SKT230-10	SEK	600A, 1kV, 0.15A, 3V	C-62			
SKT230-12	SEK	600A, 1.2kV, 0.15A, 3V	C-62			
SKT230-14	SEK	600A, 1.4kV, 0.15A, 3V	C-62			
SKT230-16	SEK	600A, 1.6kV, 0.15A, 3V	C-62			
SKT240-04	SEK	240A, 400V, 0.2A, 3V	C-62			 图 C-62
SKT240-08	SEK	240A, 800V, 0.2A, 3V	C-62			
SKT240-14	SEK	240A, 1.4kV, 0.2A, 3V	C-62			
SKT240-16	SEK	240A, 1.6kV, 0.2A, 3V	C-62			
SKT240F04	SEK	GTO 240A, 400V, 0.25A, 4V	C-62			
SKT240F08	SEK	GTO 240A, 800V, 0.25A, 4V	C-62			
SKT240F10	SEK	GTO 240A, 1kV, 0.25A, 4V	C-62			
SKT240F12	SEK	GTO 240A, 1.2kV, 0.25A, 4V	C-62			

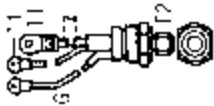
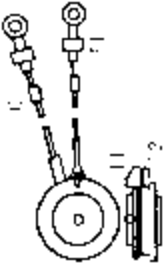

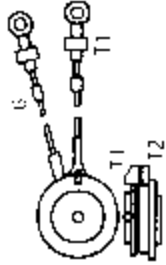
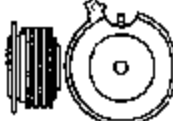
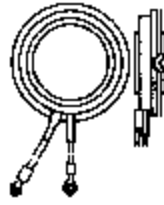
器件型号 Element type	厂名 Manufacturers	材料用途参数 Material Purpose Parameter	图号 Figure	国内外相似替换器件型号 Replace of similar type	备注 Notes	外形参考图 Reference shape	
SKT250-02	SEK	450A, 200V, 0.25A, 3V	F-71			 <p>图 F-71</p>	
SKT250-04	SEK	450A, 400V, 0.25A, 3V	F-71				
SKT250-06	SEK	450A, 600V, 0.25A, 3V	F-71				
SKT250-08	SEK	450A, 800V, 0.25A, 3V	F-71				
SKT250-10	SEK	450A, 1kV, 0.25A, 3V	F-71				
SKT250-12	SEK	450A, 1.2kV, 0.25A, 3V	F-71				
SKT250-14	SEK	450A, 1.4kV, 0.25A, 3V	F-71				
SKT250-16	SEK	450A, 1.6kV, 0.25A, 3V	F-71				
SKT290F04	SEK	GTO	C-62				
SKT290F08	SEK	GTO	C-62				
SKT290F10	SEK	GTO	C-62				
SKT290F12	SEK	GTO	C-62				
SKT300-02	SEK	550A, 200V, 0.25A, 3V	F-71				 <p>图 C-62</p>
SKT300-04	SEK	550A, 400V, 0.25A, 3V	F-71				
SKT300-06	SEK	550A, 600V, 0.25A, 3V	F-71				
SKT300-08	SEK	550A, 800V, 0.25A, 3V	F-71				
SKT300-10	SEK	550A, 1kV, 0.25A, 3V	F-71				
SKT300-12	SEK	550A, 1.2kV, 0.25A, 3V	F-71				
SKT300-14	SEK	550A, 1.4kV, 0.25A, 3V	F-71				
SKT300-16	SEK	550A, 1.6kV, 0.25A, 3V	F-71				
SKT330-02	SEK	750A, 200V, 0.15A, 3V	C-62				
SKT330-04	SEK	750A, 400V, 0.15A, 3V	C-62				
SKT330-06	SEK	750A, 600V, 0.15A, 3V	C-62				
SKT330-08	SEK	750A, 800V, 0.15A, 3V	C-62				
SKT330-10	SEK	750A, 1kV, 0.15A, 3V	C-62				
SKT330-12	SEK	750A, 1.2kV, 0.15A, 3V	C-62				

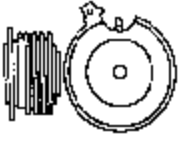

器件型号 Element type	厂名 Manufacturers	材料用途参数 Material Purpose Parameter	图号 Figure	国内外相似替换器件型号 Replace of similar type	备注 Notes	外形参考图 Reference shape
SKT330-14	SEK	750A, 1.4kV, 0.15A, 3V	C-62			 <p>图 C-62</p>
SKT330-16	SEK	750A, 1.6kV, 0.15A, 3V	C-62			
SKT340-04	SEK	340A, 400V, 0.2A, 3V	C-62			
SKT340-08	SEK	340A, 600V, 0.2A, 3V	C-62			
SKT340-14	SEK	340A, 1.4kV, 0.2A, 3V	C-62			
SKT340-16	SEK	340A, 1.6kV, 0.2A, 3V	C-62			
SKT350F08	SEK	GTO	C-11			 <p>图 C-11</p>
SKT350F10	SEK	GTO	C-11			
SKT350F12	SEK	GTO	C-11			
SKT400F04	SEK	400A, 400V, 0.25A, 5V	C-35			 <p>图 C-35</p>
SKT400F06	SEK	400A, 600V, 0.25A, 5V	C-35			
SKT400F08	SEK	400A, 800V, 0.25A, 5V	C-35			
SKT400F10	SEK	400A, 1kV, 0.25A, 5V	C-35			
SKT400F12	SEK	400A, 1.2kV, 0.25A, 5V	C-35			
SKT400F14	SEK	400A, 1.4kV, 0.25A, 5V	C-35			
SKT410F12	SEK	410A, 1.2kV, 0.35A, 3.5V	C-11			
SKT430F06	SEK	GTO	C-11			
SKT430F08	SEK	GTO	C-11			
SKT430F10	SEK	GTO	C-11			
SKT450-02	SEK	1.1kA, 200V, 0.25A, 5V	C-11			
SKT450-04	SEK	1.1kA, 400V, 0.25A, 5V	C-11			
SKT450-06	SEK	1.1kA, 600V, 0.25A, 5V	C-11			
SKT450-08	SEK	1.1kA, 800V, 0.25A, 5V	C-11			

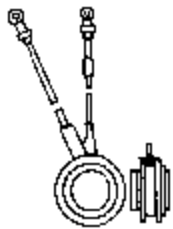

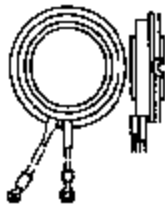
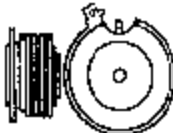
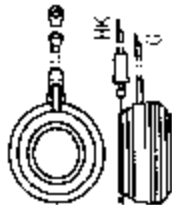

器件型号 Element type	厂名 Manufacturers	材料用途参数 Material Purpose Parameter	图号 Figure	国内外相似替换器件型号 Replace of similar type	备注 Notes	外形参考图 Reference shape
SKT450-10	SEK	1.1kV, 1kV, 0.25A, 5V	C-11			 图 C-11
SKT450-12	SEK	1.1kV, 1.2kV, 0.25A, 5V	C-11			
SKT450-16	SEK	1.1kV, 1.6kV, 0.25A, 5V	C-11			
SKT450-18	SEK	1.1kV, 1.8kV, 0.25A, 5V	C-11			
SKT450-22	SEK	1.1kV, 2.2kV, 0.25A, 5V	C-11			
SKT450-24	SEK	1.1kV, 2.4kV, 0.25A, 5V	C-11			
SKT490-04	SEK	490A, 400V, 0.25A, 3V	C-11			 图 C-35
SKT490-06	SEK	490A, 600V, 0.25A, 3V	C-11			
SKT490-08	SEK	490A, 800V, 0.25A, 3V	C-11			
SKT490-12	SEK	490A, 1.2kV, 0.25A, 3V	C-11			
SKT490-14	SEK	490A, 1.4kV, 0.25A, 3V	C-11			
SKT490-16	SEK	490A, 1.6kV, 0.25A, 3V	C-11			
SKT490-18	SEK	490A, 1.8kV, 0.25A, 3V	C-11			
SKT500-04	SEK	500A, 400V, 0.15A, 3V	C-35			
SKT500-06	SEK	500A, 600V, 0.15A, 3V	C-35			
SKT500-10	SEK	500A, 1kV, 0.15A, 3V	C-35			 图 C-32
SKT500-12	SEK	500A, 1.2kV, 0.15A, 3V	C-35			
SKT500-14	SEK	500A, 1.4kV, 0.15A, 3V	C-35			
SKT500-16	SEK	500A, 1.6kV, 0.15A, 3V	C-35			
SKT500-18	SEK	500A, 1.8kV, 0.15A, 3V	C-35			
SKT510F06	SEK	GTO 510A, 600V, 0.25A, 4V	C-32			
SKT510F08	SEK	GTO 510A, 800V, 0.25A, 4V	C-32			
SKT510F10	SEK	GTO 510A, 1.1kV, 0.25A, 4V	C-32			
SKT510F12	SEK	GTO 510A, 1.2kV, 0.25A, 4V	C-32			
SKT520F04	SEK	520A, 400V, 0.35A, 3.5V	C-11			

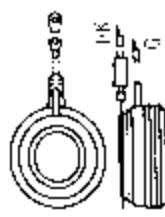

器件型号 Element type	厂名 Manufacturers	材料用途参数 Material Purpose Parameter	图号 Figure	国内外相似替换器件型号 Replace of similar type	备注 Notes	外形参考图 Reference shape	
SKT600-04C	SEK	600A, 400V, 0.15A, 3V	C-35			 图 C-35	
SKT600-04D	SEK	600A, 400V, 0.2A, 3.5V	C-35				
SKT600-06C	SEK	600A, 600V, 0.15A, 3V	C-35				
SKT600-08C	SEK	600A, 800V, 0.15A, 3V	C-35				
SKT600-08D	SEK	600A, 800V, 0.2A, 3.5V	C-35				
SKT600-10C	SEK	600A, 1kV, 0.15A, 3V	C-35				
SKT600-12D	SEK	600A, 1.2kV, 0.2A, 3.5V	C-35				
SKT600-12E	SEK	600A, 1.2kV, 0.2A, 3.5V	C-35				
SKT600-14E	SEK	600A, 1.4kV, 0.2A, 3.5V	C-35				
SKT600-16C	SEK	600A, 1.6kV, 0.15A, 3V	C-35				
SKT600-16D	SEK	600A, 1.6kV, 0.2A, 3.5V	C-35				
SKT600-16E	SEK	600A, 1.6kV, 0.2A, 3.5V	C-35				
SKT600-18C	SEK	600A, 1.8kV, 0.15A, 3V	C-35				
SKT630-02	SEK	1.4kA, 200V, 0.25A, 5V	C-11				 图 C-11
SKT630-04	SEK	1.4kA, 400V, 0.25A, 5V	C-11				
SKT630-06	SEK	1.4kA, 600V, 0.25A, 5V	C-11				
SKT630-08	SEK	1.4kA, 800V, 0.25A, 5V	C-11				
SKT630-12	SEK	1.4kA, 1.2kV, 0.25A, 5V	C-11				
SKT630-14	SEK	1.4kA, 1.4kV, 0.25A, 5V	C-11				
SKT760-04	SEK	760A, 400V, 0.2A, 3.5V	C-35				
SKT760-08	SEK	760A, 800V, 0.2A, 3.5V	C-35				
SKT760-14	SEK	760A, 1.4kV, 0.2A, 3.5V	C-35				
SKT760-16	SEK	760A, 1.6kV, 0.2A, 3.5V	C-35			 图 C-20	
SKT1000-04	SEK	1kA, 400V, 0.15A, 5V	C-20				
SKT1000-06	SEK	1kA, 600V, 0.15A, 5V	C-20				
SKT1000-08	SEK	1kA, 800V, 0.15A, 5V	C-20				

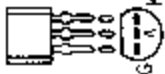
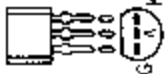

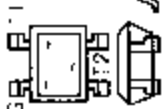
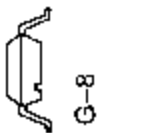

器件型号 Element type	厂名 Manufacturers	材料用途参数 Material Purpose Parameter	图号 Figure	国内外相似替换器件型号 Replace of similar type	备注 Notes	外形参考图 Reference shape
SKT1000-10	SEK	1kA, 1kV, 0.15A, 5V	C-20			 图 C-20
SKT1000-12	SEK	1kA, 1.2kV, 0.15A, 5V	C-20			
SKT1000-14	SEK	1kA, 1.4kV, 0.15A, 5V	C-20			
SKT1000-16	SEK	1kA, 1.6kV, 0.15A, 5V	C-20			
SKT1000-18	SEK	1kA, 1.8kV, 0.15A, 5V	C-20			
SKW1000-12		1kA, 1.2kV, 0.2A, 3.5V				
SKW1000-14		1kA, 1.4kV, 0.2A, 3.5V				
SKW1000-16		1kA, 1.6kV, 0.2A, 3.5V				
SKW1200-12		1.2kA, 1.2kV, 0.2A, 3.5V				
SKW1200-14		1.2kA, 1.4kV, 0.2A, 3.5V				
SKW1200-16		1.2kA, 1.6kV, 0.2A, 3.5V				
SKW1450-12		1.4kA, 1.2kV, 0.2A, 3.5V				
SKW1450-14		1.4kA, 1.4kV, 0.2A, 3.5V				
SKW1450-16		1.4kA, 1.6kV, 0.2A, 3.5V				
SKW1700-12		1.7kA, 1.2kV, 0.2A, 3.5V				
SKW1700-14		1.7kA, 1.4kV, 0.2A, 3.5V				
SKW1700-16		1.7kA, 1.6kV, 0.2A, 3.5V				
SL136-2	Triac	4A, 200V, 0.04A	B-98	Z0410		 图 B-98
SL136-3	Triac	4A, 300V, 0.04A	B-98	Z0410		
SL136-4	Triac	4A, 400V, 0.04A	B-98	Z0410		
SL136-5	Triac	4A, 500V, 0.04A	B-98	Z0410		
SL136-6	Triac	4A, 600V, 0.04A	B-98	Z0410		
SL136-7	Triac	4A, 700V, 0.04A	B-98	Z0410		

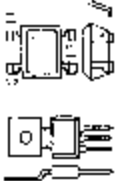
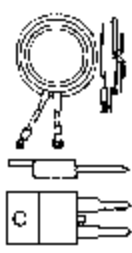
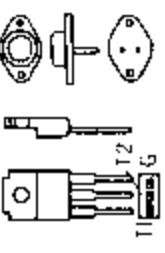
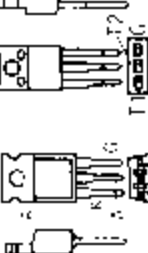
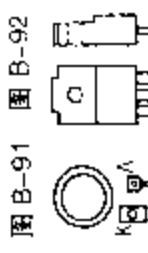



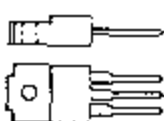

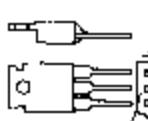
器件型号 Element type	厂名 Manufacturers	材料用途参数 Material Purpose Parameter	图号 Figure	国内外相似替换器件型号 Replace of similar type	备注 Notes	外形参考图 Reference shape
SL1500GX22	SCR-L	1.5kA, 4kV				 图 B-36
SL1500GX23	Triac	1.5kA, 4kV				
SL2500JX21	SCR-L	2.5kA, 6kV				
SL3000GX22	SCR-L	3kA, 4kV				 图 B-36
SL3000GX23	Triac	3kA, 4kV				
SM08G43	Triac	0.8A, 400V	B-36			
SM0R5B42	TOS	SCR-D 0.5A, 100V, 0.03A, 2.3V	B-36	TAG200-100, T2303A, TAG208-100		 图 B-43
SM0R5D42	TOS	SCR-D 0.5A, 200V, 0.03A, 2.3V	B-36	TAG200-200, T2303B, TAG208-200		
SM0R5G42	TOS	SCR-D 0.5A, 400V, 0.03A, 2.3V	B-36	TAG200-400, T2303D, TAG208-400		
SM1D43		1A, 200V	B-43			 图 B-21
SM1F43A1		1A, 300V	B-43			
SM1G43	Triac	1A, 400V	B-36			
SM1G43A1	Triac	1A, 400V	B-43			 图 B-21
SM1I43	Triac	1A, 600V	B-36			
SM2B41	TOS	SCR-D 2A, 100V, 0.015A, 2.3V	B-21	ECG5629, SK3533, SK5635, TAG231-200, TAG220-100, TAG225-100		
SM2D41	TOS	SCR-D 2A, 200V, 0.015A, 2.3V	B-21	ECG5629, SK3632, SK5624, TAG231-200, TAG220-200, TAG225-200		 图 G-8
SM2D44		2A, 200V	G-8			
SM2G41	TOS	SCR-D 2A, 400V, 0.015A, 2.3V	B-21	ECG5629, SK3533, SK5635, TAG231-400, TAG220-400, TAG225-400		
SM2G44		2A, 400V	G-8			



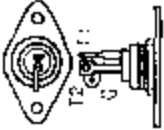
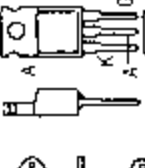
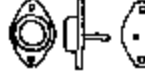
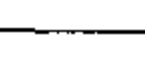
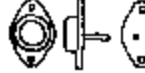
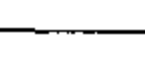
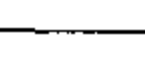
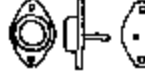
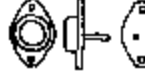
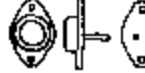
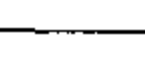
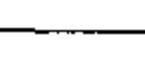
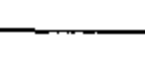
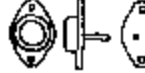
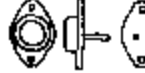
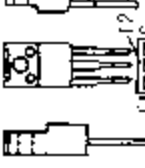
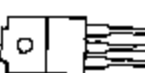
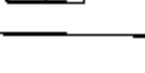
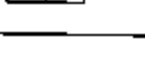
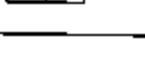
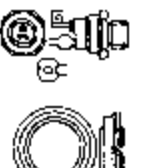



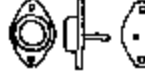



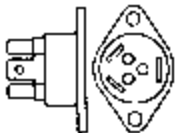

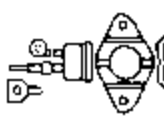

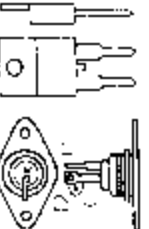
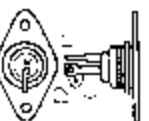
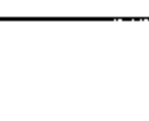

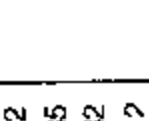
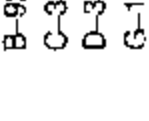
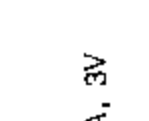
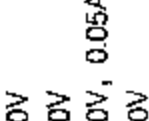
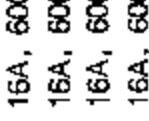

器件型号 Element type	厂名 Manufacturers	材料 Material	用途 Purpose	参数 Parameter	图号 Figure	国内外相似替换器件型号 Replace of similar type	备注 Notes	外形参考图 Reference shape
SM3B41	TOS	SCR-D	3A, 100V, 0.03A, 2.3V	B-21	TAG231-200, TAG220-100, TAG225-100		图 B-21 图 G-8	
SM3D41	TOS	SCR-D	3A, 200V, 0.03A, 2.3V	B-21	TAG231-200, TAG220-200, TAG225-200		图 B-9 图 C-35	
SM3G41	TOS	SCR-D	3A, 400V, 0.03A, 2.3V	B-21	TAG231-400, TAG220-400, TAG225-400		图 B-99 图 D-9	
SM3G44			3A, 400V	G-8				
SM3G45, A		Triac	3A, 400V	B-9				
SM3G48		Triac	3A, 400V	C-35				
SM3GZ46, A		Triac	3A, 400V	B-99				
SM3GZ47		Triac	3A, 400V	B-21	TAG231-600, TAG220-600, TAG225-600			
SM3J41	TOS	SCR-D	3A, 600V, 0.03A, 2.3V	B-21				
SM3J44			3A, 600V	G-8				
SM3J45, A		Triac	3A, 600V	B-9				
SM3J48		Triac	3A, 600V	C-35				
SM3JZ46, A		Triac	3A, 600V	B-99				
SM3JZ47		Triac	3A, 600V	B-99				
SM6B14	TOS	SCR-D	6A, 100V, 0.075A, 3V	D-9	ECG5632, TAG260-100, TAG265-100, T4700B		图 B-99 图 D-9	
SM6D14	TOS	SCR-D	6A, 200V, 0.075A, 3V	D-9	ECG5633, TAG260-200, TAG265-200, T4700B		图 B-91 图 B-92	
SM6D45	TOS	SCR-D	6A, 200V, 0.05A, 2V	B-91			图 B-91 图 B-92	
SM6D45A			6A, 200V, 0.05A, 2V	B-92				
SM6DZ45A			6A, 200V, 0.03A, 1.5V	C-85				
SM6DZ46	TOS	SCR-D	6A, 200V, 0.05A, 2V	B-13				
SM6DZ46A			6A, 200V, 0.05A, 3V	B-99				
SM6G14	TOS	SCR-D	6A, 400V, 0.075A, 3V	D-9	ECG5633		图 C-85 图 B-13	
SM6G44			6A, 400V	G-8				
SM6G45	TOS	SCR-D	6A, 400V, 0.05A, 2V	B-91				
SM6G45A	TOS	SCR-D	6A, 400V, 0.03A, 1.5V	B-91				
SM6G48		Triac	6A, 600V	C-35				
SM6G48A		Triac	6A, 400V	C-35				

器件型号 Element type	厂名 Manufacturers	材料用途参数 Material Purpose Parameter	图号 Figure	国内外相似替换器件型号 Replace of similar type	备注 Notes	外形参考图 Reference shape
SM6GZ46	TOS	6A, 400V, 0.05A, 2V	B-13			
SM6GZ46A	TOS	6A, 400V, 0.03A, 1.5V	B-13			
SM6GZ47, A		Triac	B-92			图 B-13
SM6J44		6A, 400V	G-8			
SM6J45, A		6A, 600V	B-92			
SM6J48, A		6A, 600V	C-35			图 B-92 图 G-8
SM6JZ46, A		6A, 600V	B-99			图 C-35 图 D-99
SM6JZ47, A		6A, 600V	B-92			
SM8D41		SCR-D	B-90	MAC222-4, TIC226B, T2802B		
SM8D45	TOS	8A, 200V, 0.05A	B-91			
SM8D45A	TOS	8A, 200V, 0.05A, 2V	B-91			
SM8CZ46	TOS	8A, 200V, 0.03A, 1.5V	B-13			
SM8DZ46A	TOS	8A, 200V, 0.05A, 2V	B-13			
SM8G41	TOS	8A, 200V, 0.03A, 1.5V	B-13			
SM8C45	TOS	8A, 400V, 0.05A, 3V	B-91	ECG5633, MAC222-6, TIC226D, T2802D		
SM8G45A	TOS	8A, 400V, 0.05A, 2V	B-91			
SM8G48		SCR-D	B-91			
SM8G48A		Triac	C-35			
SM8GZ46	TOS	8A, 400V	B-13			
SM8GZ46A	TOS	8A, 400V, 0.05A, 2V	B-13			
SM8GZ47, A		8A, 400V, 0.03A, 1.5V	B-92			图 B-92 图 B-90
SM8J41	TOS	8A, 400V	B-91			
SM8J45	TOS	8A, 600V, 0.05A, 3V	B-91			
SM8J45A	TOS	8A, 600V, 0.05A, 2V	B-91			
SM8J48, A		SCR-D	B-91			
SM8JZ46		Triac	C-35			
SM8JZ46A	TOS	8A, 600V, 0.03A, 1.5V	B-13			
SM8JZ47, A	TOS	8A, 600V, 0.05A, 2V	B-13			
		8A, 600V, 0.03A, 1.5V	B-92			图 B-91
		8A, 600V	B-92			
		Triac	B-92			

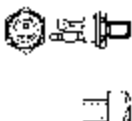

器件型号 Element type	厂名 Manufacturers	材料用途参数 Material Purpose Parameter	图号 Figure	国内外相似替换器件型号 Replace of similar type	备注 Notes	外形参考图 Reference shape
SM10D10		SCR-D 10A, 200V, 0.075A	D-29	TAG265-200, T4700B		
SM10D14	TOS	SCR-D 10A, 200V, 0.075A, 3V	D-9			
SM10G10	TOS	SCR-D 10A, 400V, 0.075A	D-28	TAG255-400, T4700D		
SM10G14	TOS	SCR-D 10A, 400V, 0.075A, 3V	D-9			
SM12D41	TOS	SCR-D 12A, 200V, 0.05A, 3V	B-91	BTA23-B, BT138-200, TAC255-200		
SM12D45	TOS	12A, 200V, 0.05A, 2V	B-91			
SM12D45A	TOS	12A, 200V, 0.03A, 1.5V	B-91			
SM12DZ46	TOS	12A, 200V, 0.05A, 2V	B-13			
SM12DZ46A	TOS	12A, 200V, 0.03A, 1.5V	B-13			
SM12G41	TOS	SCR-D 12A, 400V, 0.05A, 3V	B-91	BTA23-D, BT138-400, TAG255-400		
SM12G45	TOS	12A, 400V, 0.05A, 2V	B-91			
SM12G45A	TOS	SCR-D 12A, 400V, 0.03A, 1.5V	B-91			
SM12G48A	TOS	Triac 12A, 400V	B-91			
SM12GZ46	TOS	12A, 400V, 0.05A, 2V	B-13			
SM12GZ46A	TOS	12A, 400V, 0.03A, 1.5V	B-13			
SM12GZ47. A	TOS	Triac 12A, 400V	B-92			
SM12J41	TOS	SCR-D 12A, 600V, 0.05A, 3V	B-91	BTA23-M, BT138-600, TA11-600		
SM12J45	TOS	12A, 600V, 0.05A, 2V	B-91			
SM12J45	TOS	12A, 600V, 0.05A, 2V	B-91			
SM12J45A	TOS	SCR-D 12A, 600V, 0.03A, 1.5V	B-91			
SM12J48A	TOS	Triac 12A, 600V	C-35			
SM12JZ46	IOS	12A, 600V, 0.05A, 2V	B-13			
SM12JZ46A	TOS	12A, 600V, 0.03A, 1.5V	B-13			
SM12JZ47. A	TOS	12A, 600V	B-92			
SM16D12	TOS	SCR-D 16A, 200V, 0.075A, 3V	F-15			
SM16D14	TOS	SCR-D 16A, 200V, 0.05A, 3V	D-9			
SM16D16	TOS	SCR-D 16A, 200V, 0.05A, 3V	B-88	T4700B		



器件型号 Element type	厂名 Manufacturers	材料用途参数 Material Purpose Parameter	图号 Figure	国内外相似替换器件型号 Replace of similar type	备注 Notes	外形参考图 Reference shape
SM16DZ41	TOS	16A, 200V, 0.05A, 3V	D-32			
SM16G12	TOS	SCR-D 16A, 400V, 0.075A, 3V	D-17			
SM16G14	TOS	SCR-D 16A, 400V, 0.05A, 3V	D-9			
SM16G16	TOS	SCR-D 16A, 400V, 0.05A, 3V	D-29	T4700D		
SM16G45, A		Triac 16A, 600V	B-9			
SM16G48, A		Triac 16A, 400V	C-35			
SM16G45A		16A, 400V	B-92			
SM16GZ41	TOS	16A, 400V, 0.05A, 3V	D-32			
SM16GZ42, A		16A, 400V	G-12			
SM16GZ47, A		SCR-D 16A, 400V	D-29	T4700M		
SM16GZ51		SCR-D 16A, 400V	B-92			
SM16J16		SCR-D 16A, 600V	C-35			
SM16J45, A		Triac 16A, 600V	D-32			
SM16J48, A		Triac 16A, 600V	G-12			
SM16JZ41	TOS	16A, 600V, 0.05A, 3V	D-32			
SM16JZ42, A		16A, 600V	G-12			
SM16JZ47, A		16A, 600V				
SM16JZ51		SCR-D 16A, 600V				
SM25DZ41	TOS	25A, 200V, 0.05A, 3V	D-32			
SM25GZ41	TOS	25A, 400V, 0.05A, 3V	D-32			
SM25GZ42, 51		25A, 400V	G-12			
SM25JZ41	TOS	25A, 600V, 0.05A, 3V	D-32			
SM25JZ42, 51		25A, 600V	G-12			
SM30D11		SCR-D 30A, 200V	F-38			
SM30D12	TOS	SCR-D 30A, 200V, 0.075A, 3V	D-17			
SM30G11, 12		SCR-D 30A, 450V	F-38			

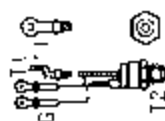
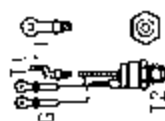
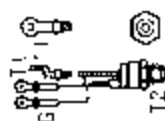
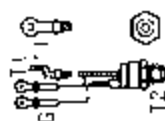
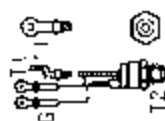
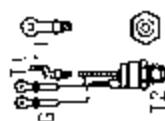

器件型号 Element type	厂名 Manufacturers	材料用途参数 Material Purpose Parameter	图号 Figure	国内外相似替换器件型号 Replace of similar type	备注 Notes	外形参考图 Reference shape
SM80G13	SCR-D	80A, 400V	F-67			 T2 F-67
SM80J13	SCR-D	80A, 600V	F-67			
SM80Q13	SCR-D	80A, 1.2kV	F-67			
SM150G13	SCR-D	150A, 400V	F-67			 T2 F-67
SM150J13	SCR-D	150A, 600V	F-67			
SM150Q13	SCR-D	150A, 1.2kV	F-67			
SN20C40	SEM	20A, 400V, 0.12A, 2.2V				 T2 F-67
SN20C50	SEM	20A, 500V, 0.12A, 2.2V				
SN20C60	SEM	20A, 600V, 0.12A, 2.2V				
SN20C80	SEM	20A, 800V, 0.12A, 2.2V				
SN050	SEL	0.5A, 30V, 0.005A	B-51			 T2 F-67
SN051	SEL	0.5A, 100V, 0.005A	B-51			
SN052	SEL	0.5A, 200V, 0.005A, 1V	B-51			
SN100	SEL	1A, 30V, 0.005A	B-51			 T2 F-67
SN101	SEL	1A, 100V, 0.005A	B-51			
SN102	SEL	1A, 200V, 0.005A	B-51			
SN103	SEL	1A, 300V, 0.005A	B-51			
SN104	SEL	1A, 400V, 0.005A	B-51			
SN105	SEL	1.6A, 500V, 0.001A	B-51			
SN106	SEL	1.6A, 600V, 0.001A	B-51			
SN200	SEL	2A, 30V, 0.02A	B-51			 T2 F-67
SN202	SEL	2A, 200V, 0.02A	B-51			
SN203	SFI	2A, 300V, 0.02A	B-51			
SN204	SEL	2A, 400V, 0.02A	B-51			



B-51





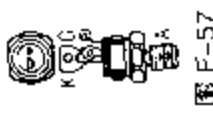

器件型号 Element type	厂名 Manufacturers	材料用途参数 Material Purpose Parameter	图号 Figure	国内外相似替换器件型号 Replace of similar type	备注 Notes	外形参考图 Reference shape
SN205	SEL	3.2A, 500V, 0.02A	B-51			 图 B-51
SN206	SEL	3.2A, 600V, 0.02A	B-51			
SN500	SEL	5A, 30V, 0.05A	D-9			 图 D-9
SN501	SEL	5A, 100V, 0.05A	D-9			
SN502	SEL	5A, 200V, 0.05A	D-9			
SN503	SEL	5A, 300V, 0.05A	D-9			
SN504	SEL	5A, 400V, 0.05A	D-9			
SN505	SEL	5A, 500V, 0.05A	D-9			
SN506	SEL	5A, 600V, 0.05A	D-9			
SN800	SEL	5A, 30V, 0.05A	D-9			
SN801	SEL	5A, 100V, 0.05A	D-9			
SN802	SEL	5A, 200V, 0.05A	D-9			
SN803	SEL	5A, 300V, 0.05A	D-9			
SN804	SEL	5A, 400V, 0.05A	D-9			
SN805	SEL	5A, 500V, 0.05A	D-9			
SN806	SEL	5A, 600V, 0.05A	D-9			
SO301L, LS1, LS2, LS3		4A, 60V		MCR106-2		
SO301M		1.6A, 5V		2N1595		
SO301MS1		1.6A, 45V		2N4212		
SO301MS2		1.6A, 25V		2N2322		
SO301MS3		1.6A, 25V		MCR1906-2		
SO303L		4A, 60V		MCR106-2		
SO303LS1		4A, 60V		MCR106-2		
SO303LS2		4A, 30V		MCR106-1		
SO303LS3		4A, 30V		MCR106-1		



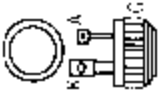

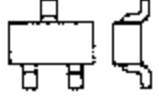





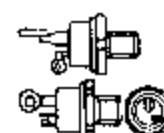
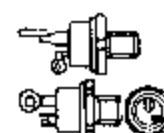

器件型号 Element type	厂名 Manufacturers	材料用途参数 Material Purpose Parameter	图号 Figure	国内外相似替换器件型号 Replace of similar type	备注 Notes	外形参考图 Reference shape
SO303MS2		2.6A, 30V		2N6236		
SO303MS3		2.6A, 30V		2N6236		
SO306FS21		8A, 25V		MCR72-1		
SO306FS31		8A, 25V		MCR72-1		
SO306L		8A, 25V		S2800F		
SO306LS2		8A, 50V		MCR72-2		
SO306LS3		8A, 50V		MCR72-2		
SO308F1		8A, 25V		MCR3000-1		
SO308F3		8A, 25V		MCR3000-1		
SO308FS4		25V		MCR72-1		
SO308FS21		8A, 50V		MCR72-2		
SO308FS31		25V		MCR72-1		
SO308L		8A, 25V				
SO308LS2		8A, 50V		MCR72-2		
SO308LS3		8A, 50V		MCR72 1		
SO308R		8A, 25V				
SO310F1		12A, 50V		2N6394		
SO310L		12A, 50V		2N6394		
SO312L, R		12A, 50V		2N6394		
SO315H		10A, 50V		2N1843		
SO315L, R		10A, 50V		2N6400		
SO320L		16A, 50V		2N6504		
SO325D		25A, 50V		C230F3		
SO325H		16A, 35V		2N681		
SO325R		16A, 50V		2N6504		
SO335D		35A, 50V		C228F		
SO335G, H		35A, 25V		MCR3835-1		



器件型号 Element type	厂名 Manufacturers	材料用途参数 Material Purpose Parameter	图号 Figure	国内外相似替换器件型号 Heplace of similar type	备注 Notes	外形参考图 Reference shape
SO501L, LS1, LS2, LS3		2.55A, 60V		MCR106 2		 图 F-57
SO501M		1.6A, 50V		2N1595		
SO501MS1		1.6A, 50V		2N4213		
SO501MS2		0.45A, 50V		2N2323		
SO501MS3		1.6A, 50V		MCR1906-1		
SO503L, LS1, LS2, LS3		2.55A, 60V		MCR106-2		
SO503MS2		2.6A, 50V		2N6237		
SO503MS3		2.6A, 50V		2N6237		
SO505FS21		8A, 50V		MCR72-2		
SO505FS31		8A, 50V		MCR72 2		
SO506L		8A, 50V		MCR72-2		
SO506LS2		8A, 50V		MCR72-2		
SO506LS3		8A, 50V		2N4441		
SO506F1, F3		5.1A, 50V		MCR72-2		
SO508FS31		8A, 50V		MCR72-2		
SO508L		8A, 50V		MCR72-2		
SO508LS2		8A, 50V		MCR72-2		
SO508LS3		8A, 50V		MCR72-2		
SO508R		8A, 50V		MCR72-2		
SO508RS21		8A, 50V		MCR72-2		
SO510L		12A, 50V		MCR72-2		
SO512L, R		12A, 50V		2N6394		
SO515L, R		10A, 50V		2N6394		
SO520L		16A, 50V		2N6400		
SO525D		25A, 50V		2N6504		
SO525H		16A, 75V		C230F3		
SO535D		35A, 200V	F-57	2N682		
				C228A3		





器件型号 Element type	厂名 Manufacturers	材料用途参数 Material Purpose Parameter	图号 Figure	国内外相似替换器件型号 Replace of similar type	备注 Notes	外形参考图 Reference shape
SO535G		35A, 100V	C-85	2N3870		
SO802BH		8A, 200V	B-9	MCR72-4		
SO802DH	8A, 400V			MCR72-6		
SO802NH	8A, 800V			MCR72-10		
SOBRY55-30	THE	0.3A, 30V, 200 μA, 0.8V	G-1			
SOBRY55-60	THE	0.3A, 60V, 200 μA, 0.8V	G-1			
SOBRY55-100	THE	0.3A, 100V, 200 μA, 0.8V	G-1			
SOBRY55-200	THE	0.3A, 200V, 200 μA, 0.8V	G-1			
SPS010	HUT	10A, 50V, 0.025A, 2V	F-21	ECG5491, SK6791, SK5491		
SPS020	HUT	20A, 50V, 0.025A, 2V	F-21	ECG5521, SK6621, SK5521		
SPS025	HUT	25A, 50V, 0.025A, 2V	F-21	S0525H		
SPS035	HUT	35A, 50V, 0.025A, 2V	F-21	ECG5541, SK6615, SK5515, S0535H		
SPS08	HUT	8A, 50V, 0.025A, 2V	F-21	ECG5491, SK6791, SK5491, S0506H, S6210A		
SPS18	HUT	8A, 100V, 0.025A, 2V	F-21	ECG5491, S1008L		
SPS28	HUT	8A, 200V, 0.025A, 2V	F-21	ECG5492, SK6792, SK5492, S6210B		
SPS38	HUT	8A, 300V, 0.025A, 2V	F-21	SK6794, SK549, S6210D		
SPS48	HUT	8A, 400V, 0.025A, 2V	F-21	ECG5494, S4008L		
SPS58	HUT	8A, 500V, 0.025A, 2V	F-21	FCG5496, SK6796, SK5496, S6210M		
SPS68	HUT	8A, 600V, 0.025A, 2V	F-21	ECG5495, S6008L		
SPS110	HUT	10A, 100V, 0.025A, 2V	F-21	ECG5491, SK6791, SK5491		
SPS120	HUT	20A, 100V, 0.025A, 2V	F-21	ECG5522, S1020L		
SPS125	HUT	25A, 100V, 0.025A, 2V	F-21	S1025H		
SPS135	HUT	35A, 100V, 0.025A, 2V	F-21	ECG5542, SK6615, SK5515, S1035H		

器件型号 Element type	厂名 Manufacturers	材料用途参数 Material Purpose Parameter	图号 Figure	国内外相似替换器件型号 Replace of similar type	备注 Notes	外形参考图 Reference shape
SPS210	HUT	10A, 200V, 0.025A, 2V	F-21	ECG5542, SK6792, SK5492		 图 F-21
SPS220	HUT	20A, 200V, 0.025A, 2V	F-21	S2020L		
SPS225	HUT	25A, 200V, 0.025A, 2V	F-48	S2025H		
SPS235	HUT	35A, 200V, 0.025A, 2V	F-21	ECG5543, S2035H		
SPS310	HUT	10A, 300V, 0.025A, 2V	F-21	ECG5494, SK6794, SK5494		 图 F-21
SPS320	HUT	20A, 300V, 0.025A, 2V	F-21	ECG5527, S3020L		
SPS325	HUT	25A, 300V, 0.025A, 2V	F-21	S3025H		
SPS335	HUT	35A, 300V, 0.025A, 2V	F-21	ECG5545, S3035H		
SPS410	HUT	10A, 400V, 0.025A, 2V	F-21	ECG5494, SK6794, SK5494		 图 F-21
SPS420	HUT	20A, 400V, 0.025A, 2V	F-21	ECG5527, S4020L		
SPS425	HUT	25A, 400V, 0.025A, 2V	F-21	S4025H		
SPS435	HUT	35A, 400V, 0.025A, 2V	F-21	ECG5545, S4035H		
SPS510	HUT	10A, 500V, 0.025A, 2V	F-21	ECG5496, SK6796, SK5496		 图 F-48
SPS520	HUT	20A, 500V, 0.025A, 2V	F-21	ECG5529, S5020L		
SPS525	HUT	25A, 500V, 0.025A, 2V	F-21	S5025H		
SPS535	HUT	35A, 500V, 0.025A, 2V	F-21	ECG5547, S5035H		
SPS610	HUT	10A, 600V, 0.025A, 2V	F-21	ECG5496, SK6796, SK5496		 图 F-48
SPS620	HUT	20A, 600V, 0.025A, 2V	F-21	ECG5529, S6020L		
SPS625	HUT	25A, 600V, 0.025A, 2V	F-21	S6025H		
SPS635	HUT	35A, 600V, 0.025A, 2V	F-21	S6035H		
SPT08	HUT	8A, 50V, 0.05A, 2.5V	F-21	ECG5673, Q2008B		 图 S
SPT010	HUT	10A, 50V, 0.05A, 2.5V	F-21	ECG5673, Q2010B		
SPT015	HUT	15A, 50V, 0.05A, 2.5V	F-21	Q2015H		

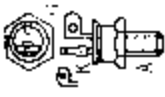
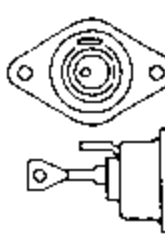
器件型号 Element type	厂名 Manufacturers	材料用途参数 Material Purpose Parameter	图号 Figure	国内外相似替换器件型号 Replace of similar type	备注 Notes	外形参考图 Reference shape
SPT025	HUT	25A, 50V, 0.1A, 2.5V	F-21	ECG5681, Q2025H6, T6411B		 图 F-21
SPT030	HUT	30A, 50V, 0.1A, 2.5V	F-21	ECG5693, SK3652, SK5693		
SPT040	HUT	40A, 50V, 0.1A, 2.5V	F-21	ECG5693, SK3652, SK5693		
SPT18	HUT	8A, 100V, 0.05A, 2.5V	F-21	ECG5673, Q2006H, 2N5569		 图 F-21
SPT28	HUT	8A, 200V, 0.05A, 2.5V	F-21	ECG5673, Q2006H, 2N5569		
SPT38	HUT	8A, 300V, 0.05A, 2.5V	F-21	ECG5675, Q4006H		
SPT48	HUT	8A, 400V, 0.05A, 2.5V	F-21	ECG5675, Q4006H		
SPT58	HUT	8A, 500V, 0.05A, 2.5V	F-21	ECG5677, Q5006H		
SPT68	HUT	8A, 600V, 0.05A, 2.5V	F-21	ECG5677, Q6006H		
SPT115	HUT	15A, 100V, 0.05A, 2.5V	F-21	ECG5673, Q2015H, 2N5573		 图 F-47
SPT125	HUT	25A, 100V, 0.1A, 2.5V	F-21	ECG5682, Q2025H6, T6411B		
SPT130	HUT	30A, 100V, 0.1A, 2.5V	F-21	ECG5693, SK3652, SK5693, T6411B		
SPT140	HUT	40A, 100V, 0.1A, 2.5V	F-21	ECG5693, SK3652, SK5693, 2N5444		
SPT210	HUT	10A, 200V, 0.05A, 2.5V	F-21	ECG5673, Q2010H, 2N5569		 图 F-47
SPT215	HUT	15A, 200V, 0.05A, 2.5V	F-21	ECG5673, Q2015H, 2N5573		
SPT225	HUT	25A, 200V, 0.1A, 2.5V	F-21	ECG5683, Q2025H6, T6411B		
SPT230	HUT	30A, 200V, 0.1A, 2.5V	F-21	ECG5693, SK3652, SK5693, T6411B		
SPT240	HUT	40A, 200V, 0.1A, 2.5V	F-21	ECG5693, SK3652, SK5693, 2N5444		 图 F-47
SPT260	HUT	60A, 200V, 0.1A, 3V	F-47			
SPT310	HUT	10A, 300V, 0.05A, 2.5V	F-21	ECG5675, Q4010H, 2N5570		
SPT315	HUT	15A, 300V, 0.05A, 2.5V	F-21	ECG5675, Q4015H, 2N5574		
SPT325	HUT	25A, 300V, 0.1A, 2.5V	F-21	ECG5685, Q4025H6, T6411D		 图 F-47
SPT330	HUT	30A, 300V, 0.1A, 2.5V	F-21	ECG5695, SK3509, SK5695, T6411D		
SPT340	HUT	40A, 300V, 0.1A, 2.5V	F-21	ECG5695, SK3509, SK5695, 2N5445		

器件型号 Element type	厂名 Manufacturers	材料用途参数 Material Purpose Parameter	图号 Figure	国内外相似替换器件型号 Replace of similar type	备注 Notes	外形参考图 Reference shape
SPT360	HUT	50A, 300V, 0.1A, 3V	F-47			
SPT410	HUT	10A, 400V, 0.05A, 2.5V	F-21	ECG5675, Q4010H, 2N5570		
SPT415	HUT	15A, 400V, 0.05A, 2.5V	F-21	ECG5675, Q4015H, 2N5574		
SPT425	HUT	25A, 400V, 0.1A, 2.5V	F-21	ECG5685, Q4025H6, T6411D		
SPT430	HUT	30A, 400V, 0.1A, 2.5V	F-21	ECG5695, SK3509, SK5695, T6411D		
SPT440	HUT	40A, 400V, 0.1A, 2.5V	F-21	ECG5695, SK3509, SK5695, 2N5445		
SPT460	HUT	60A, 400V, 0.1A, 3V	F-47			
SPT510	HUT	10A, 500V, 0.05A, 2.5V	F-21	ECG5677, Q5010H, T4111M		
SPT515	HUT	15A, 500V, 0.05A, 2.5V	F-21	ECG5677, Q5015H, T4110M		
SPT525	HUT	25A, 500V, 0.1A, 2.5V	F-21	ECG5687, SK3521, SK5686, Q5025H6, T6411M		
SPT530	HUT	30A, 500V, 0.1A, 2.5V	F-21	ECG5697, SK3522, SK5697, T6411M		
SPT540	HUT	40A, 500V, 0.1A, 2.5V	F-21	ECG5697, SK3522, SK5697, 2N5446		
SPT560	HUT	60A, 500V, 0.1A, 3V	F-47			
SPT610	HUT	10A, 600V, 0.05A, 2.5V	F-21	ECG5677, Q6010H, T4111M		
SPT615	HUT	15A, 600V, 0.05A, 2.5V	F-21	ECG5677, Q6015H, T4110M		
SPT625	HUT	25A, 600V, 0.1A, 2.5V	F-21	ECG5697, Q6025H6, T6411M		
SPT630	HUT	30A, 600V, 0.1A, 2.5V	F-21	ECG5697, SK3522, SK5697, T6411M		
SPT660	HUT	60A, 600V, 0.1A, 3V	F-47			
SPT1060	HUT	60A, 1kV, 0.1A, 3V	F-47			
SROR5G43		0.5A, 400V	B-36			
SSG16C20, D	SEM	SCR-D 16A, 200V, 0.05A, 3V	D-19			
SSG16C20Y	SEM	SCR-D 16A, 200V, 0.05A, 3V	D-23			
SSG16C30, D	SEM	SCR-D 16A, 300V, 0.05A, 3V	D-19			

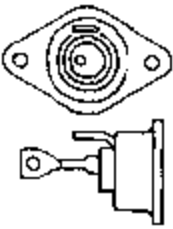
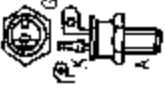

器件型号 Element type	厂名 Manufacturers	材料用途参数 Material Purpose Parameter	图号 Figure	国内外相似替换器件型号 Replace of similar type	备注 Notes	外形参考图 Reference shape	
SSG16C30Y	SEM	SCR-D 16A, 300V, 0.05A, 3V	D-23			 图 D-23	
SSG16C40, D	SEM	SCR-D 16A, 400V, 0.05A, 3V	D-19				
SSG16C40Y	SEM	SCR-D 16A, 400V, 0.05A, 3V	D-23				
SSG16C50, D	SFM	SCR-D 16A, 500V, 0.05A, 3V	D-19				
SSG16C50Y	SEM	SCR-D 16A, 500V, 0.05A, 3V	D-23				
SSG16C60, D	SEM	SCR-D 16A, 600V, 0.05A, 3V	D-19				
SSG16C60Y	SEM	SCR-D 16A, 600V, 0.05A, 3V	D-23				
SSG16C80, D	SEM	SCR-D 16A, 800V, 0.05A, 3V	D-19				
SSG16C80Y	SEM	SCR-D 16A, 800V, 0.05A, 3V	D-23				
SSG16C100, D	SEM	SCR-D 16A, 1kV, 0.05A, 3V	D-19				
SSG16C100Y	SEM	SCR-D 16A, 1kV, 0.05A, 3V	D-23				
SSG16C120, D	SEM	SCR-D 16A, 1.2kV, 0.05A, 3V	D-19				
SSG16C120Y	SEM	SCR-D 16A, 1.2kV, 0.05A, 3V	D-23				
SSG25C20	SFM	SCR-D 25A, 200V, 0.07A, 3V	F-36				 图 D-19
SSG25C20Y	SEM	SCR-D 25A, 200V	D-23				
SSG25C30	SEM	SCR-D 25A, 300V, 0.07A, 3V	F-36				
SSG25C30Y	SEM	SCR-D 25A, 300V	D-23				
SSG25C40	SEM	SCR-D 25A, 400V, 0.07A, 3V	F-36				
SSG25C40Y	SEM	SCR-D 25A, 400V	D-23				
SSG25C50	SEM	SCR-D 25A, 500V, 0.07A, 3V	F-36				
SSG25C50Y	SEM	SCR-D 25A, 500V	D-23				
SSG25C60	SEM	SCR-D 25A, 600V, 0.07A, 3V	F-36				
SSG25C60Y	SEM	SCR-D 25A, 600V	D-23				
SSG25C80	SEM	SCR-D 25A, 800V, 0.07A, 3V	F-36				
SSG25C80Y	SEM	SCR-D 25A, 800V	D-23				
SSG25C100	SEM	SCR-D 25A, 1kV, 0.07A, 3V	F-36				
SSG25C100Y	SEM	SCR-D 25A, 1kV	D-23				
SSG25C120	SEM	SCR-D 25A, 1.2kV, 0.07A, 3V	F-36			 图 F-36	

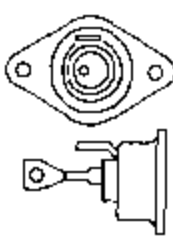
器件型号 Element type	厂名 Manufacturers	材料用途参数 Material Purpose Parameter	图号 Figure	国内外相似替换器件型号 Replace of similar type	备注 Notes	外形参考图 Reference shape
SSG25C120Y	SCR-D	25A, 1.2kV	D-23			
SSG35C20	SEM	SCR-D 35A, 200V, 0.07A, 3V	F-38			
SSG35C20Y	SEM	SCR-D 35A, 200V, 0.05A, 3V	D-23			
SSG35C30	SEM	SCR-D 35A, 300V, 0.07A, 3V	F-38			
SSG35C30Y	SEM	SCR-D 35A, 300V, 0.05A, 3V	D-23			
SSG35C40	SEM	SCR-D 35A, 400V	F-38			
SSG35C40Y	SEM	SCR-D 35A, 400V, 0.05A, 3V	D-23			
SSG35C50	SEM	SCR-D 35A, 500V, 0.07A, 3V	F-38			
SSG35C50Y	SEM	SCR-D 35A, 500V, 0.05A, 3V	D-23			
SSG35C60	SEM	SCR-D 35A, 600V, 0.07A, 3V	F-38			
SSG35C60Y	SEM	SCR-D 35A, 600V, 0.05A, 3V	D-23			
SSG35C80	SEM	SCR-D 35A, 800V, 0.07A, 3V	F-38			
SSG35C100	SEM	SCR-D 35A, 1kV, 0.07A, 3V	F-38			
SSG35C120	SEM	SCR-D 35A, 1.2kV, 0.07A, 3V	F-38			
SSG45C20	SEM	SCR-D 45A, 200V, 0.07A, 3V	F-38			
SSG45C30	SEM	SCR-D 45A, 300V, 0.07A, 3V	F-38			
SSG45C40	SEM	SCR-D 45A, 400V, 0.07A, 3V	F-38			
SSG45C50	SEM	SCR-D 45A, 500V, 0.07A, 3V	F-38			
SSG45C60	SEM	SCR-D 40A, 600V, 0.07A, 3V	F-38			
SSG45C80	SEM	SCR-D 45A, 800V, 0.07A, 3V	F-38			
SSG45C100	SEM	SCR-D 45A, 1kV, 0.07A, 3V	F-38			
SSG45C120	SEM	SCR-D 45A, 1.2kV, 0.07A, 3V	F-38			
SSG50C20	SEM	SCR-D 50A, 200V, 0.1A, 3V	F-27			
SSG50C30	SEM	SCR-D 50A, 300V, 0.1A, 3V	F-27			
SSG50C40	SEM	SCR-D 50A, 400V, 0.1A, 3V	F-27			
SSG50C50	SEM	SCR-D 50A, 500V, 0.1A, 3V	F-27			
SSG50C60	SEM	SCR-D 50A, 600V, 0.1A, 3V	F-27			



图 D-23



图 F-38



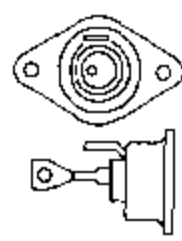







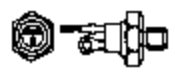
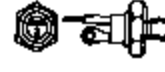
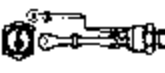
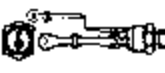
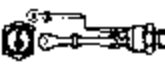
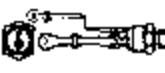
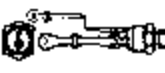
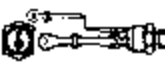
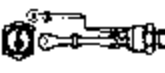
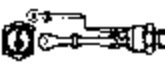
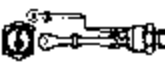

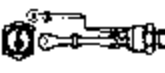
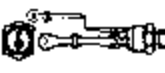
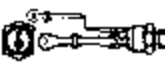













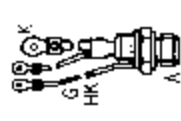

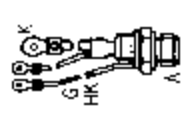
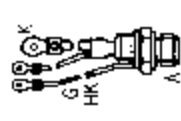
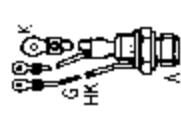
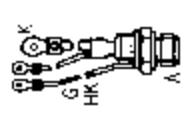
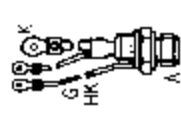
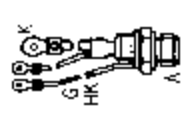
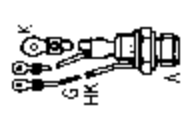
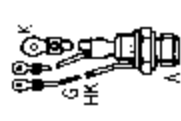
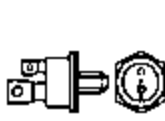





图 F-27



器件型号 Element type	厂名 Manufacturers	材料用途参数 Material Purpose Parameter	图号 Figure	国内外相似替换器件型号 Replace of similar type	备注 Notes	外形参考图 Reference shape
SSG50C80	SEM	SCR-D 50A, 800V, 0.1A, 3V	F-27			
SSG50C100	SEM	SCR-D 50A, 1kV, 0.1A, 3V	F-27			
SSG50C120	SEM	SCR-D 50A, 1.2kV, 0.15A, 3V	F-27			
SSG70C20	SEM	SCR-D 70A, 200V, 0.1A, 3V	F-64			
SSG70C30	SEM	SCR-D 70A, 300V, 0.1A, 3V	F-64			
SSG70C40	SEM	SCR-D 70A, 400V, 0.1A, 3V	F-64			
SSG70C50	SEM	SCR-D 500V, 0.1A, 3V	F-64			
SSG70C100	SEM	SCR-D 70A, 1kV, 0.1A, 3V	F-64			
SSG70C120	SEM	SCR-D 1.2kV, 0.1A, 3V	F-64			
SSG70D20	SEM	SCR-D 70A, 200V, 0.1A, 3V	F-64			
SSG70D30	SEM	SCR-D 70A, 300V, 0.1A, 3V	F-49			
SSG70D40	SEM	SCR-D 70A, 400V, 0.1A, 3V	F-64			
SSG70D50	SEM	SCR-D 70A, 500V, 0.1A, 3V	F-64			
SSG70D60	SEM	SCR-D 70A, 600V, 0.1A, 3V	F-64			
SSG100C20	SEM	SCR-D 100A, 200V, 0.1A, 3V	F-79			
SSG100C30	SEM	SCR-D 100A, 300V, 0.1A, 3V	F-79			
SSG100C40	SEM	SCR-D 100A, 400V, 0.1A, 3V	F-79			
SSG100C50	SEM	SCR-D 100A, 500V, 0.1A, 3V	F-79			
SSG100C60	SEM	SCR-D 100A, 600V, 0.1A, 3V	F-79			
SSG100C80	SEM	SCR-D 100A, 800V, 0.1A, 3V	F-79			
SSG100C100	SEM	SCR-D 100A, 1kV, 0.1A, 3V	F-79			
SSG100C120	SEM	SCR-D 100A, 1.2kV, 0.2A, 3V	F-79			
SSG150C20	SEM	SCR-D 150A, 200V, 0.15A, 3V	F-76			
SSG150C30	SEM	SCR-D 150A, 300V	F-76			
SSG150C40	SEM	SCR-D 150A, 400V, 0.15A, 3V	F-76			
SSG150C50	SEM	SCR-D 150A, 500V, 0.15A, 3V	F-76			
SSG150C60	SEM	SCR-D 100A, 600V, 0.4A, 3V	E-22			
SSG150C80	SEM	SCR-D 100A, 800V, 0.4A, 3V	E-22			

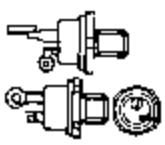
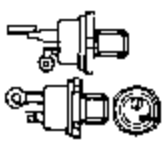
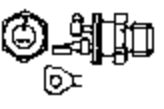

器件型号 Element type	厂名 Manufacturers	材料 Material	用途 Purpose	参数 Parameter	图号 Figure	国内外相似替换器件型号 Replace of similar type	备注 Notes	外形参考图 Reference shape
SSG150C100	SFM	SCR-D	100A, 1kV, 0.4A, 3V	E-22				 图 E-22
SSG150C120	SEM	SCR-D	100A, 1.2kV, 0.4A, 3V	F-76				 图 F-76
SSG300C20	SEM	SCR-D	300A, 200V, 0.4A, 3V	E-22				 图 E-22
SSG300C30	SEM	SCR-D	300A, 300V, 0.3A, 3V	F-49				 图 F-49
SSG300C40	SEM	SCR-D	300A, 400V, 0.4A, 3V	E-22				 图 E-22
SSG300C50	SEM	SCR-D	300A, 500V, 0.4A, 3V	E-22				 图 E-22
SSG300C60	SEM	SCR-D	300A, 600V, 0.4A, 3V	E-22				 图 E-22
SSG300C80	SEM	SCR-D	300A, 800V, 0.4A, 3V	E-22				 图 E-22
SSG300C100	SEM	SCR-D	300A, 1kV, 0.4A, 3V	E-22				 图 E-22
SSG300C120	SEM	SCR-D	300A, 1.2kV, 0.4A, 3V	E-22				 图 E-22
STA203A		SCR-D	1A, 400V					 图 F-49
ST2	AMR, GES	DAC	2A, 3.6V, 28V	F-1	ECG6408, GT32			 图 F-1
ST4	GES	SAT	0.175A, 9V, 14V, 10V	B-33				 图 B-33
ST018S02P	SIS		18A, 200V, 0.1A, 2.5V	F-48				 图 F-48
ST018S04P	SIS		18A, 400V, 0.1A, 2.5V	F-48				 图 F-48
ST018S06P	SIS		18A, 600V, 0.1A, 2.5V	F-48				 图 F-48
ST018S08P	SIS		18A, 800V, 0.1A, 2.5V	F-48				 图 F-48
ST018S10P	SIS		18A, 1kV, 0.1A, 2.5V	F-48				 图 F-48
ST018S12P	SIS		18A, 1.2kV, 0.1A, 2.5V	F-48				 图 F-48
ST022S02P	SIS		22A, 200V, 0.1A, 2.5V	F-48				 图 F-48
ST022S04P	SIS		22A, 400V, 0.1A, 2.5V	F-48				 图 F-48
ST022S06P	SIS		22A, 600V, 0.1A, 2.5V	F-48				 图 F-48
ST022S08P	SIS		22A, 800V, 0.1A, 2.5V	F-48				 图 F-48

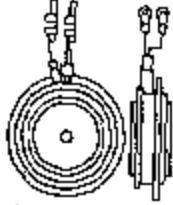
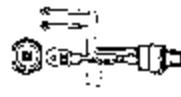

器件型号 Element type	厂名 Manufacturers	材料用途参数 Material Purpose Parameter	图号 Figure	国内外相似替换器件型号 Replace of similar type	备注 Notes	外形参考图 Reference shape
ST022S10P	SIS	22A, 1kV, 0.1A, 2.5V	F-48			 图 F-48
ST022S12P	SIS	22A, 1.2kV, 0.1A, 2.5V	F-48			
ST022S14P	SIS	22A, 1.4kV, 0.1A, 2.5V	F-8			
ST022S15P	SIS	22A, 1.5kV, 0.1A, 2.5V	F-48			
ST025S02P	SIS	28A, 200V, 0.1A, 2.5V	F-48			 图 F-48
ST025S04P	SIS	28A, 400V, 0.1A, 2.5V	F-48			
ST025S06P	SIS	28A, 600V, 0.1A, 2.5V	F-48			
ST025S08P	SIS	28A, 800V, 0.1A, 2.5V	F-48			
ST025S10P	SIS	28A, 1kV, 0.1A, 2.5V	F-48			
ST025S12P	SIS	28A, 1.2kV, 0.1A, 2.5V	F-48			
ST025S14P	SIS	28A, 1.4kV, 0.1A, 2.5V	F-48			
ST025S15P	SIS	28A, 1.5kV, 0.1A, 2.5V	F-48			
ST040S02P	SIS	40A, 200V, 0.1A, 2.5V	F-21			 图 F-21
ST040S04P	SIS	40A, 400V, 0.1A, 2.5V	F-21			
ST040S06P	SIS	40A, 600V, 0.1A, 2.5V	F-21			
ST040S08P	SIS	40A, 800V, 0.1A, 2.5V	F-21			
ST040S10P	SIS	40A, 1kV, 0.1A, 2.5V	F-21			
ST040S12P	SIS	40A, 1.2kV, 0.1A, 2.5V	F-21			
ST040S14P	SIS	40A, 1.4kV, 0.1A, 2.5V	F-21			
ST040S15P	SIS	40A, 1.5kV, 0.1A, 2.5V	F-21			
ST043S02PFL	SIS	40A, 200V, 0.1A, 2.5V	F-21			 图 F-21
ST043S04PFL	SIS	40A, 400V, 0.1A, 2.5V	F-21			
ST043S06PFL	SIS	40A, 600V, 0.1A, 2.5V	F-21			
ST043S08PFL	SIS	40A, 800V, 0.1A, 2.5V	F-21			
ST043S10PFL	SIS	40A, 1kV, 0.1A, 2.5V	F-21			
ST043S12PFL	SIS	40A, 1.2kV, 0.1A, 2.5V	F-21			

器件型号 Element type	厂名 Manufacturers	材料用途参数 Material Purpose Parameter	图号 Figure	国内外相似替换器件型号 Replace of similar type	备注 Notes	外形参考图 Reference shape	
ST050S02P	SIS	50A, 200V, 0.1A, 2.5V	F-21			 <p>图 F-21</p>	
ST050S04P	SIS	50A, 400V, 0.1A, 2.5V	F-21				
ST050S06P	SIS	50A, 600V, 0.1A, 2.5V	F-21				
ST050S08P	SIS	50A, 800V, 0.1A, 2.5V	F-21				
ST050S10P	SIS	50A, 1kV, 0.1A, 2.5V	F-21				
ST050S12P	SIS	50A, 1.2kV, 0.1A, 2.5V	F-21				
ST050S14P	SIS	50A, 1.4kV, 0.1A, 2.5V	F-21				
ST050S15P	SIS	50A, 1.5kV, 0.1A, 2.5V	F-21				
ST053S02PFN	SIS	50A, 200V, 0.1A, 2.5V	F-21				
ST053S04PFN	SIS	50A, 400V, 0.1A, 2.5V	F-21				
ST053S06PFN	SIS	50A, 600V, 0.1A, 2.5V	F-21				
ST053S08PFN	SIS	50A, 800V, 0.1A, 2.5V	F-21				
ST063C02CFN	SIS	160A, 200V, 0.2A, 3V	C-50				 <p>图 C-50</p>
ST063C04CFN	SIS	160A, 400V, 0.2A, 3V	C-50				
ST063C06CFN	SIS	160A, 600V, 0.2A, 3V	C-50				
ST063C08CFN	SIS	160A, 800V, 0.2A, 3V	C-50				
ST063C10CFN	SIS	160A, 1kV, 0.2A, 3V	C-50				
ST063C12CFN	SIS	160A, 1.2kV, 0.2A, 3V	C-50				
ST063S02PFN	SIS	60A, 200V, 0.2A, 3V	F-91				
ST063S04PFN	SIS	60A, 400V, 0.2A, 3V	F-91				
ST063S06PFN	SIS	60A, 600V, 0.2A, 3V	F-91				
ST063S08PFN	SIS	60A, 800V, 0.2A, 3V	F-91				
ST063S10PFN	SIS	60A, 1kV, 0.2A, 3V	F-91				
ST063S12PFN	SIS	60A, 1.2kV, 0.2A, 3V	F-91				
ST073C08CFK	SIS	175A, 600V, 0.2A, 3V	C-50			 <p>图 F-91</p>	
ST073C08CFK	SIS	175A, 800V, 0.2A, 3V	C-50				

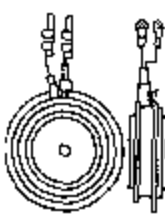

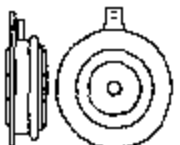
器件型号 Element type	厂名 Manufacturers	材料用途参数 Material Purpose Parameter	图号 Figure	国内外相似替换器件型号 Replace of similar type	备注 Notes	外形参考图 Reference shape
ST073C10CFK	SIS	175A, 1kV, 0.2A, 3V	C-50			 图 C-50
ST073C12CFK	SIS	175A, 1.2kV, 0.2A, 3V	C-50			
ST073S06PFK	SIS	70A, 600V, 0.2A, 3V	F-91			
ST073S08PFK	SIS	70A, 800V, 0.2A, 3V	F-91			
ST073S10PFK	SIS	70A, 1kV, 0.2A, 3V	F-91			
ST073S12PFK	SIS	70A, 1.2kV, 0.2A, 3V	F-91			
ST080S02P	SIS	80A, 200V, 0.15A, 3V	F-91			 图 F-91
ST080S04P	SIS	80A, 400V, 0.15A, 3V	F-91			
ST080S06P	SIS	80A, 600V, 0.15A, 3V	F-91			
ST080S08P	SIS	80A, 800V, 0.15A, 3V	F-91			
ST080S10P	SIS	80A, 1kV, 0.15A, 3V	F-91			
ST080S12P	SIS	80A, 1.2kV, 0.15A, 3V	F-91			
ST080S15P	SIS	80A, 1.5kV, 0.15A, 3V	F-91			
ST083C02CFN	SIS	190A, 200V, 0.2A, 3V	C-50			
ST083C02CF0		410A, 200V	C-10			
ST083C04CFN	SIS	190A, 400V, 0.2A, 3V	C-50			
ST083C04CF0		410A, 400V	C-10			
ST083C06CFN	SIS	190A, 600V, 0.2A, 3V	C-50			
ST083C06CF0		410A, 600V	C-10			
ST083C08CF0		410A, 800V	C-10			
ST083C10CF0		410A, 1kV	C-10			
ST083C12CF0		410A, 1.2kV	C-10			
ST083S02PFN	SIS	80A, 200V, 0.2A, 3V	C-50			 图 C-10
ST083S02PF0		135A, 200V	E-28			
ST083S04PFN	SIS	80A, 400V, 0.2A, 3V	C-50			
ST083S04PF0		135A, 400V	E-28			
ST083S06PFN	SIS	80A, 600V, 0.2A, 3V	C-50			



图 E-28







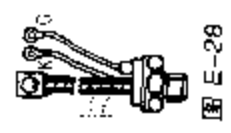
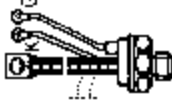
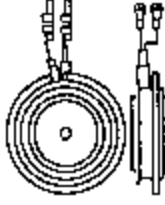
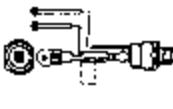
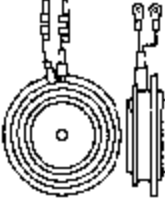
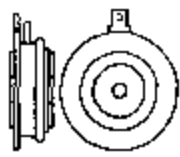
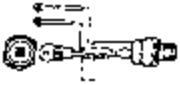
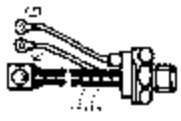
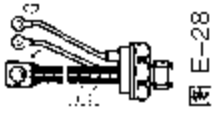
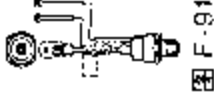
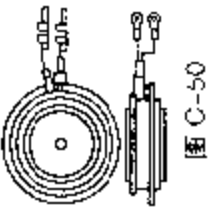
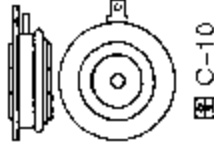





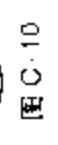

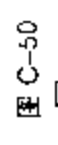

器件型号 Element type	厂名 Manufacturers	材料用途参数 Material Purpose Parameter	图号 Figure	国内外相似替换器件型号 Replace of similar type	备注 Notes	外形参考图 Reference shape
ST083S06PF.0		135A, 600V	E-28			 图 E-28
ST083S08PF.0		135A, 800V	E-28			
ST083S10PF.0		135A, 1kV	E-28			
ST083S12PF.0		135A, 1.2kV	E-28			
ST090C02C	SIS	225A, 200V, 0.15A, 3V	C-50			 图 C-50
ST090C04C	SIS	225A, 400V, 0.15A, 3V	C-50			
ST090C06C	SIS	225A, 600V, 0.15A, 3V	C-50			
ST090C08C	SIS	225A; 800V, 0.15A, 3V	C-50			
ST090C10C	SIS	225A, 1kV, 0.15A, 3V	C-50			
ST090C12C	SIS	225A, 1.2kV, 0.15A, 3V	C-50			
ST090C14C	SIS	225A, 1.4kV, 0.15A, 3V	C-50			
ST090C15C	SIS	225A, 1.5kV, 0.15A, 3V	C-50			
ST090S02P	SIS	90A, 200V, 0.15A, 3V	F-91			
ST090S04P	SIS	90A, 400V, 0.15A, 3V	F-91			
ST090S06P	SIS	90A, 600V, 0.15A, 3V	F-91			
ST090S08P	SIS	90A, 800V, 0.15A, 3V	F-91			
ST090S10P	SIS	90A, 1kV, 0.15A, 3V	F-91			
ST090S15P	SIS	90A, 1.5kV, 0.15A, 3V	F-91			
ST093C06CFK	SIS	220A, 600V, 0.2A, 3V	C-50			 图 F-91
ST093C08CFK	SIS	220A, 800V, 0.2A, 3V	C-50			
ST093C10CFK	SIS	220A, 1kV, 0.2A, 3V	C-50			
ST093C12CFK	SIS	220A, 1.2kV, 0.2A, 3V	C-50			
ST093S06PPK	SIS	95A, 600V, 0.2A, 3V	F-91			
ST093S12PPK	SIS	95A, 1.2kV, 0.2A, 3V	F-91			
ST103C02CFN	SIS	240A, 200V, 0.2A, 3V	C-50			
ST103C02CF.0		500A, 200V	C-10			





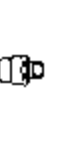
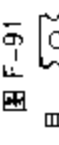
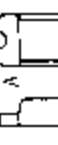
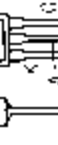
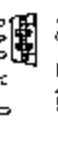
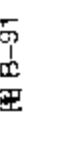





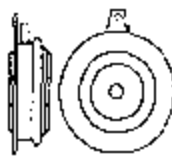

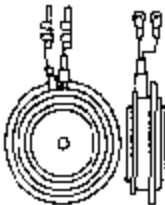
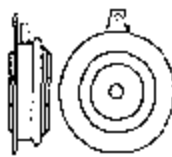

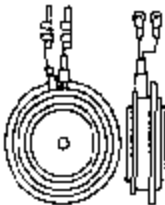

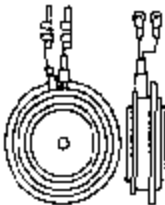

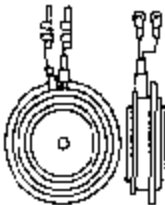

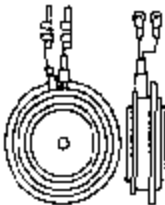

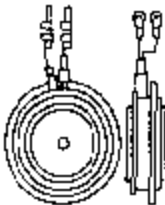

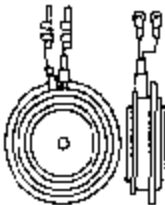

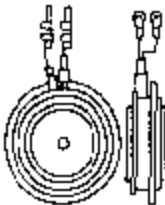
器件型号 Element type	厂名 Manufacturers	材料 Material	用途 Purpose	参数 Parameter	图号 Figure	国内外相似替换器件型号 Replace of similar type	备注 Notes	外形参考图 Reference shape
ST103C04CFN	SIS			240A, 400V, 0.2A, 3V	C-50			 图 C-50
ST103C04CF.0	SIS			500A, 400V	C-10			
ST103C06CFN	SIS			240A, 600V, 0.2A, 3V	C-50			
ST103C06CF.0	SIS			500A, 600V	C-10			
ST103C08CF.0	SIS			500A, 800V	C-10			
ST103S02PFN	SIS			105A, 200V, 0.2A, 3V	F-91			 图 C-10
ST103S02PF.0	SIS			165A, 200V	E-28			
ST103S04PFN	SIS			105A, 400V, 0.2A, 3V	F-91			
ST103S04PF.0	SIS			165A, 400V	E-28			
ST103S06PFN	SIS			105A, 600V, 0.2A, 3V	F-91			
ST103S06PF.0	SIS			165A, 600V	E-28			 图 F-91
ST103S08PF.0	SIS			165A, 800V	E-28			
ST110C02C	SIS			255A, 200V, 0.15A, 3V	C-50			
ST110C02C0	SIS			500A, 200V	C-10			
ST110C04C	SIS			255A, 400V, 0.15A, 3V	C-50			
ST110C04C0	SIS			500A, 400V	C-10			
ST110C06C	SIS			255A, 600V, 0.15A, 3V	C-50			
ST110C06C0	SIS			500A, 600V	C-10			
ST110C08C	SIS			255A, 800V, 0.15A, 3V	C-50			
ST110C08C0	SIS			500A, 800V	C-10			
ST110C10C	SIS			255A, 1kV, 0.15A, 3V	C-50			
ST110C10C0	SIS			500A, 1kV	C-10			
ST110C12C0	SIS			500A, 1.2kV	C-10			
ST110C14C	SIS			255A, 1.4kV, 0.15A, 3V	C-50			
ST110C14C0	SIS			500A, 1.4kV	C-10			
ST110C15C	SIS			255A, 1.5kV, 0.15A, 3V	C-50			
ST110C16C0	SIS			500A, 1.6kV	C-10			 图 E-28
ST110S02P	SIS			110A, 200V, 0.15A, 3V	F-91			



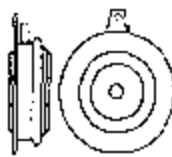

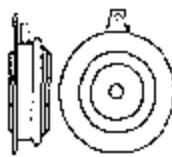

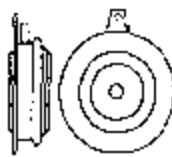





器件型号 Element type	厂名 Manufacturers	材料用途参数 Material Purpose Parameter	图号 Figure	国内外相似替换器件型号 Replace of similar type	备注 Notes	外形参考图 Reference shape
ST110S02P0V	SIS	175A, 200V	E-28			
ST110S04P	SIS	110A, 400V, 0.15A, 3V	F-91			
ST110S04P0V	SIS	175A, 400V	E-28			
ST110S06P	SIS	110A, 600V, 0.15A, 3V	F-91			
ST110S06P0V	SIS	175A, 600V	E-28			
ST110S08P	SIS	110A, 800V, 0.15A, 3V	F-91			
ST110S08P0V	SIS	175A, 800V	E-28			
ST110S10P	SIS	110A, 1kV, 0.15A, 3V	F-91			
ST110S10P0V	SIS	175A, 1kV	E-28			
ST110S12P	SIS	110A, 1.2kV, 0.15A, 3V	F-91			
ST110S12P0V	SIS	175A, 1.2kV	E-28			
ST110S14P0	SIS	175A, 1.4kV	E-28			
ST110S15P	SIS	110A, 1.5kV, 0.15A, 3V	F-91			
ST110S16P0	SIS	175A, 1.6kV	E-28			
ST163C02CFN	SIS	305A, 200V, 0.2A, 3V	C-50			
ST163C04CFN	SIS	305A, 400V, 0.2A, 3V	C-50			
ST163C06CFN	SIS	305A, 600V, 0.2A, 3V	C-50			
ST163C08CFN	SIS	305A, 800V, 0.2A, 3V	C-50			
ST163C10CFN	SIS	305A, 1kV, 0.2A, 3V	C-50			
ST163C12CFN	SIS	305A, 1.2kV, 0.2A, 3V	C-50			
ST163S02PFN	SIS	160A, 200V, 0.2A, 3V	F-91			
ST163S04PFN	SIS	160A, 400V, 0.2A, 3V	F-91			
ST163S06PFN	SIS	160A, 600V, 0.2A, 3V	F-91			
ST163S08PFN	SIS	160A, 800V, 0.2A, 3V	F-91			
ST163S10PFN	SIS	160A, 1kV, 0.2A, 3V	F-91			
ST163S12PFN	SIS	160A, 1.2kV, 0.2A, 3V	F-91			
ST173C02CF.0		610A, 200V	C-10			



器件型号 Element type	厂名 Manufacturers	材料 Material	用途 Purpose	参数 Parameter	图号 Figure	国内外相似替换器件型号 Replace of similar type	备注 Notes	外形参考图 Reference shape
ST173C04CF.0				610A, 400V	C-10			
ST173C06CF.0				610A, 600V	C-10			
ST173C06CFK	SIS			330A, 600V, 0.2A, 3V	C-50			
ST173C08CF.0				610A, 800V	C-10			
ST173C08CFK	SIS			330A, 800V, 0.2A, 3V	C-50			
ST173C10CF.0				610A, 1kV	C-10			
ST173C10CFK	SIS			330A, 1kV, 0.2A, 3V	C-50			
ST173C12CF.0				610A, 1.2kV	C-10			
ST173S06PF.0				275A, 600V	E-30			
ST173S06PFK	SIS			175A, 600V, 0.2A, 3V	F-91			
ST173S08PF.0				275A, 800V	E-30			
ST173S08PFK	SIS			175A, 800V, 0.2A, 3V	F-91			
ST173S10PF.0				275A, 1kV	E-30			
ST173S10PFK	SIS			175A, 1kV, 0.2A, 3V	F-91			
ST173S12PF.0				275A, 1.2kV	E-30			
ST180C02C	SIS			350A, 200V, 0.15A, 3V	B-91			
ST180C02C0				660A, 200V	C-10			
ST180C04C	SIS			350A, 400V, 0.15A, 3V	B-91			
ST180C04C0				660A, 400V	C-10			
ST180C06C	SIS			350A, 600V, 0.15A, 3V	B-91			
ST180C06C0				660A, 600V	C-10			
ST180C08C	SIS			350A, 800V, 0.15A, 3V	B-91			
ST180C08C0				660A, 800V	C-10			
ST180C10C	SIS			350A, 1kV, 0.15A, 3V	C-50			
ST180C10C0				660A, 1kV	C-10			
ST180C12C	SIS			350A, 1.2kV, 0.15A, 3V	C-50			
ST180C12C0				660A, 1.2kV	C-10			
ST180C14C	SIS			350A, 1.4kV, 0.15A, 3V	C-50			



器件型号 Element type	厂名 Manufacturers	材料用途参数 Material Purpose Parameter	图号 Figure	国内外相似替换器件型号 Replace of similar type	备注 Notes	外形参考图 Reference shape
ST180C14C0	SIS	660A, 1.4kV	C-10			
ST180C15C	SIS	350A, 1.5kV, 0.15A, 3V	C-50			
ST180C16C0	SIS	660A, 1.6kV	C-10			图 C-10
ST180C18C0	SIS	660A, 1.8kV	C-10			
SI180C20C0	SIS	660A, 2kV	C-10			图 C-50
ST180S02P	SIS	180A, 200V, 0.15A, 3V	F-91			
ST180S02P0V	SIS	314A, 200V	E-30			
ST180S04P	SIS	180A, 400V, 0.15A, 3V	F-91			
ST180S04P0V	SIS	314A, 400V	E-30			
ST180S06P	SIS	180A, 600V, 0.15A, 3V	F-91			
ST180S06P0V	SIS	314A, 600V	E-30			
ST180S08P	SIS	180A, 800V, 0.15A, 3V	F-91			
ST180S08P0V	SIS	314A, 800V	E-30			
ST180S10P	SIS	180A, 1kV, 0.15A, 1.5V	F-91			
ST180S10P0V	SIS	314A, 1kV	E-30			
ST180S12P	SIS	180A, 1.2kV, 0.15A, 3V	F-91			
ST180S12P0V	SIS	314A, 1.2kV	E-30			
ST180S14P	SIS	180A, 1.4kV, 0.15A, 3V	F-91			
ST180S14P0V	SIS	314A, 1.4kV	E-30			
ST180S15P	SIS	180A, 1.5kV, 0.15A, 3V	F-91			
ST180S16P0V	SIS	314A, 1.6kV	E-30			
ST180S18P0V	SIS	314A, 1.8kV	E-30			
ST180S20P0V	SIS	314A, 2kV	E-30			
ST183C02CF.0	SIS	690A, 200V	C-10			
ST183C02CFN	SIS	338A, 200V, 0.2A, 3V	C-50			
ST183C04CF.0	SIS	690A, 400V	C-10			
ST183C04CFN	SIS	338A, 400V, 0.2A, 3V	C-50			
ST183C06CF.0	SIS	690A, 600V	C-10			

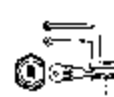

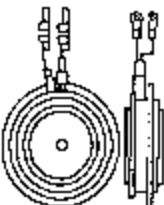
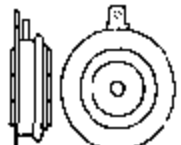

器件型号 Element type	厂名 Manufacturers	材料用途参数 Material Purpose Parameter	图号 Figure	国内外相似替换器件型号 Replace of similar type	备注 Notes	外形参考图 Reference shape
ST183C06CHN	SIS	338A, 600V, 0.2A, 3V	C-50			
ST183C08CF.0		690A, 800V	C-10			
ST183S02PF.0		306A, 200V	E-30			
ST183S02PFN	SIS	183A, 200V, 0.2A, 3V	F-91			
ST183S04PF.0		306A, 400V	E-30			
ST183S04PFN	SIS	183A, 400V, 0.2A, 3V	F-91			
ST183S06PF.0		306A, 600V	E-30			
ST183S06PFN	SIS	183A, 600V, 0.2A, 3V	F-91			
ST183S08PF.0		306A, 800V	E-30			
ST200C02C	SIS	385A, 200V, 0.15A, 3V	C-50			
ST200C04C	SIS	385A, 400V, 0.15A, 3V	C-50			
ST200C06C	SIS	385A, 600V, 0.15A, 3V	C-50			
ST200C08C	SIS	385A, 800V, 0.15A, 3V	C-50			
ST200C10C	SIS	385A, 1kV, 0.15A, 3V	C-50			
ST200C12C	SIS	385A, 1.2kV, 0.15A, 3V	C-50			
ST200C14C	SIS	385A, 1.4kV, 0.15A, 3V	C-50			
ST200C15C	SIS	385A, 1.5kV, 0.15A, 3V	C-50			
ST200S02P	SIS	200A, 200V, 0.15A, 3V	F-91			
ST200S04P	SIS	200A, 400V, 0.15A, 3V	F-91			
ST200S06P	SIS	200A, 600V, 0.15A, 3V	F-91			
ST200S08P	SIS	200A, 800V, 0.15A, 3V	F-91			
ST200S10P	SIS	200A, 1kV, 0.15A, 3V	F-91			
ST200S12P	SIS	200A, 1.2kV, 0.15A, 3V	F-91			
ST200S14P	SIS	200A, 1.4kV, 0.15A, 3V	F-91			
ST200S15P	SIS	200A, 1.5kV, 0.15A, 3V	F-91			
ST203C04CF.0		700A, 400V	C-10			
ST203C06CF.0		700A, 600V	C-10			

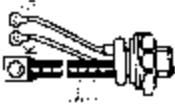
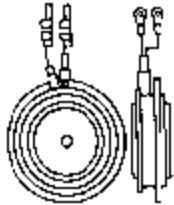
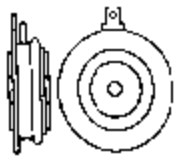
器件型号 Element type	厂名 Manufacturers	材料用途参数 Material Purpose Parameter	图号 Figure	国内外相似替换器件型号 Replace of similar type	备注 Notes	外形参考图 Reference shape
ST203C06CFK	SIS	370A, 600V, 0.2A, 3V	C-50			 图 C-50
ST203C08CF.0	SIS	700A, 800V	C-10			
ST203C08CFK	SIS	370A, 800V, 0.2A, 3V	C-50			
ST203C10CF.0	SIS	700A, 1kV	C-10			
ST203C10CFK	SIS	370A, 1kV, 0.2A, 3V	C-50			
ST203C12CF.0	SIS	700A, 1.2kV	C-10			
ST203C12CFK	SIS	370A, 1.2kV, 0.2A, 3V	C-50			
ST203S06PF.0	SIS	320A, 600V	E-30			
ST203S06PFK	SIS	205A, 600V, 0.2A, 3V	F-91			
ST203S08PF.0	SIS	320A, 800V	E-30			
ST203S08PFK	SIS	205A, 800V, 0.2A, 3V	F-91			
ST203S10PF.0	SIS	320A, 1kV	E-30			
ST203S10PFK	SIS	205A, 1kV, 0.2A, 3V	F-91			
ST203S12PF.0	SIS	320A, 1.2kV	E-30			
ST203S12PFK	SIS	205A, 1.2kV, 0.2A, 3V	F-91			
ST223C02CF.0	SIS	745A, 200V	C-10			 图 C-10
ST223C02CFN	SIS	390A, 200V, 0.2A, 3V	C-50			
ST223C04CF.0	SIS	745A, 400V	C-10			
ST223C04CFN	SIS	390A, 400V, 0.2A, 3V	C-50			
ST223C06CF.0	SIS	745A, 600V	C-10			
ST223C06CFN	SIS	390A, 600V, 0.2A, 3V	C-50			
ST223C08CF.0	SIS	745A, 800V	C-10			
ST223S02PF.0	SIS	345A, 200V	E-30			
ST223S02PFN	SIS	220A, 200V, 0.2A, 3V	F-91			
ST223S04PF.0	SIS	345A, 400V	E-30			
ST223S04PFN	SIS	220A, 400V, 0.2A, 3V	F-91			
ST223S06PF.0	SIS	345A, 600V	E-30			
ST223S06PFN	SIS	220A, 600V, 0.2A, 3V	F-91			



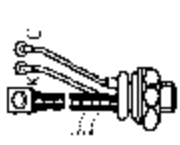
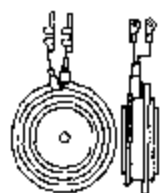
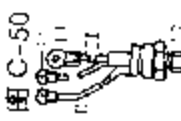
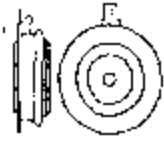
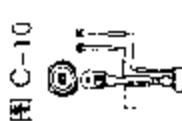





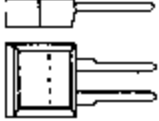
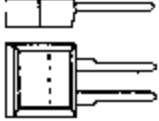
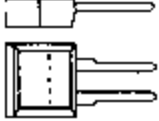
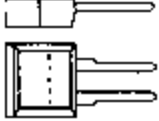
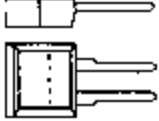
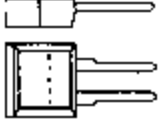
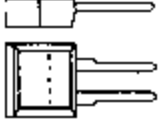
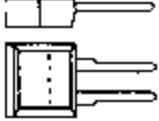
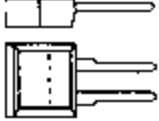

器件型号 Element type	厂名 Manufacturers	材料用途参数 Material Purpose Parameter	图号 Figure	国内外相似替换器件型号 Replace of similar type	备注 Notes	外形参考图 Reference shape	
ST23S08PF.0		345A, 800V	E-30			 图 E-30	
ST230C02C	SIS	410A, 200V, 0.15A, 3V	C-50			 图 C-50	
ST230C02C0		780A, 200V	C-10				
ST230C04C	SIS	410A, 400V, 0.15A, 3V	C-50				
ST230C04C0		780A, 400V	C-10				
ST230C06C	SIS	410A, 600V, 0.15A, 3V	C-50				
ST230C06C0		780A, 600V	C-10				
ST230C08C	SIS	410A, 800V, 0.15A, 3V	C-50				
ST230C08C0		780A, 800V	C-10				
ST230C10C	SIS	410A, 1kV, 0.15A, 3V	C-50				
ST230C10C0		780A, 1kV	C-10				
ST230C12C	SIS	410A, 1.2kV, 0.15A, 3V	C-50				
ST230C12C0		780A, 1.2kV	C-10				
ST230C14C	SIS	410A, 1.4kV, 0.15A, 3V	C-50				
ST230C14C0		780A, 1.4kV	C-10				
ST230C16C0		780A, 1.6kV	C-10			 图 C-10	
ST230S02P	SIS	230A, 200V, 0.15A, 3V	F-91				
ST230S02P0V		361A, 200V	E-30				
ST230S04P	SIS	230A, 400V, 0.15A, 3V	F-91				
ST230S04P0V		361A, 400V	E-30				
ST230S06P	SIS	230A, 600V, 0.15A, 3V	F-91				
ST230S06P0V		361A, 600V	E-30				
ST230S08P	SIS	230A, 800V, 0.15A, 3V	F-91				
ST230S08P0V		361A, 800V	E-30				
ST230S10P	SIS	230A, 1kV, 0.15A, 3V	F-91				
ST230S10P0V		361A, 1kV	E-30				
ST230S14P	SIS	230A, 1.4kV, 0.15A, 3V	F-91				
ST230S14P0V		361A, 1.4kV	E-30				 图 F-91







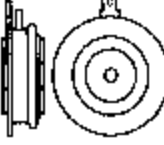
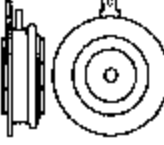
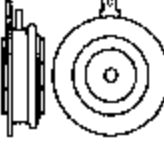
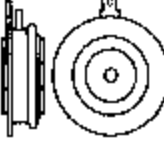
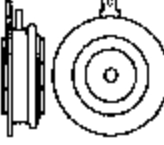
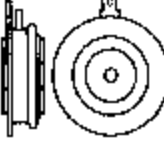
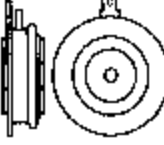
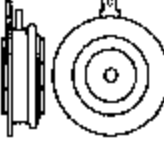
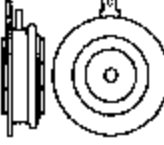
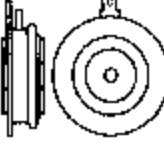
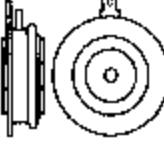





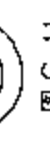
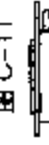



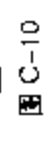

器作型号 Element type	厂名 Manufacturers	材料用途参数 Material Purpose Parameter	图号 Figure	国内外相似替换器件型号 Replace of similar type	备注 Notes	外形参考图 Reference shape
ST230S16P0V		361A, 1.6kV	E-30			 图 E-30
ST260C02C	SIS	550A, 200V, 0.2A, 3V	C-50			
ST260C04C	SIS	550A, 400V, 0.2A, 3V	C-50			
ST260C06C	SIS	550A, 600V, 0.2A, 3V	C-50			
ST260C08C	SIS	550A, 800V, 0.2A, 3V	C-50			
ST260C10C	SIS	550A, 1kV, 0.2A, 3V	C-50			
ST260C12C	SIS	550A, 1.2kV, 0.25A, 3V	C-50			
ST260C14C	SIS	550A, 1.4kV, 0.2A, 3V	C-50			
ST260C15C	SIS	550A, 1.5kV, 0.2A, 3V	C-50			
ST260S02P	SIS	260A, 200V, 0.2A, 3V	F-71			 图 F-71
ST260S04P	SIS	260A, 400V, 0.2A, 3V	F-71			
ST260S06P	SIS	260A, 600V, 0.2A, 3V	F-71			
ST260S08P	SIS	260A, 800V, 0.2A, 3V	F-71			
ST260S14P	SIS	260A, 1.4kV, 0.2A, 3V	F-71			
ST260S15P	SIS	260A, 1.5kV, 0.2A, 3V	F-71			
ST280C02C	SIS	505A, 200V, 0.15A, 3V	C-50			
ST280C02C0		960A, 200V	C-10			
ST280C04C	SIS	505A, 400V, 0.15A, 3V	C-50			
ST280C04C0		960A, 400V	C-10			
ST280C06C	SIS	505A, 600V, 0.15A, 3V	C-50			 图 C-10
ST280C06C0		960A, 600V	C-10			
ST280CH02C0		1.13kA, 200V	C-10			
ST280CH04C0		1.13kA, 400V	C-10			
ST280CH06C0		1.13kA, 600V	C-10			
ST280S02P	SIS	280A, 200V, 0.15A, 3V	F-91			 图 F-91
ST280S02P0V		440A, 200V	E-30			
ST280S04P	SIS	280A, 400V, 0.15A, 3V	F-91			

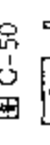
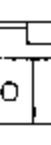
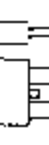
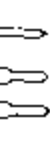
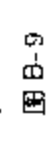

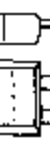
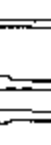
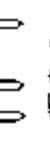
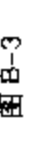







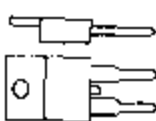

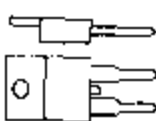
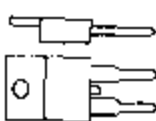
器件型号 Element type	厂名 Manufacturers	材料用途参数 Material Purpose Parameter	图号 Figure	国内外相似替换器件型号 Replace of similar type	备注 Notes	外形参考图 Reference shape
ST280S04P0V		440A, 400V	E-30			
ST280S06P	SIS	280A, 600V, 0.15A, 3V	F-91			
ST280S06P0V		440A, 600V	E-30			
ST300C02C	SIS	650A, 200V, 0.2A, 3V	C-50			
ST300C02C0		1.29kA, 200V	C-10			
ST300C02L0		1.15kA, 200V	B-3			
ST300C04C	SIS	650A, 400V, 0.2A, 3V	C-50			
ST300C04C0		1.29kA, 400V	C-10			
ST300C04L0		1.15kA, 400V	B-3			
ST300C06C	SIS	650A, 600V, 0.2A, 3V	C-50			
ST300C06C0		1.29kA, 600V	C-10			
ST300C06L0		1.15kA, 600V	B-3			
ST300C08C	SIS	650A, 800V, 0.2A, 3V	C-50			
ST300C08C0		1.29kA, 800V	C-10			
ST300C08L0		1.15kA, 800V	B-3			
ST300C10C	SIS	650A, 1kV, 0.2A, 3V	C-50			
ST300C10C0		1.29kA, 1kV	C-10			
ST300C10L0		1.15kA, 1kV	B-3			
ST300C12C0		1.29kA, 1.2kV	C-10			
ST300C12L0		1.15kA, 1.2kV	B-3			
ST300C14C	SIS	650A, 1.4kV, 0.2A, 3V	C-50			
ST300C14C0		1.29kA, 1.4kV	C-10			
ST300C15C	SIS	650A, 1.5kV, 0.2A, 3V	C-50			
ST300C16C0		1.29kA, 1.6kV	C-10			
ST300C16L0		1.15kA, 1.6kV	B-3			
ST300C18C0		1.29kA, 1.8kV	C-10			
ST300C18L0		1.15kA, 1.8kV	B-3			
ST300C20C0		1.29kA, 2kV	C-10			

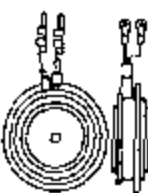
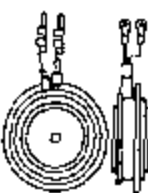
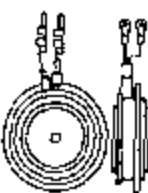
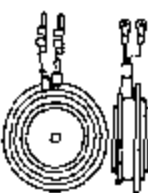
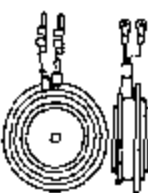
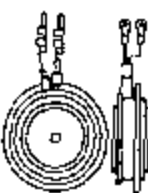
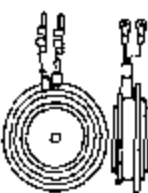
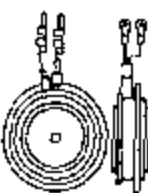
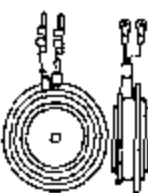
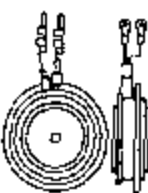
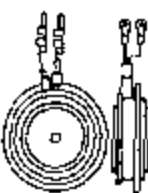
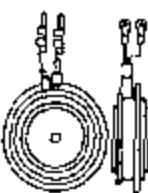
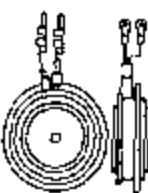
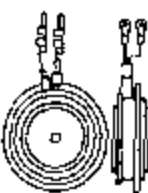
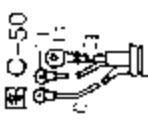

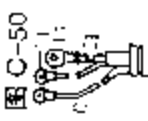

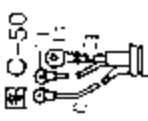









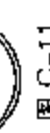
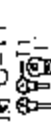

器件型号 Element type	厂名 Manufacturers	材料用途参数 Material Purpose Parameter	图号 Figure	国内外相似替换器件型号 Replace of similar type	备注 Notes	外形参考图 Reference shape
ST300C20L0		1.15kA, 2kV	B-3			
ST300S02P	SIS	300A, 200V, 0.2A, 3V	F-71			
ST300S02P0		470A, 200V	B-3			
ST300S04P	SIS	300A, 400V, 0.2A, 3V	F-71			
ST300S04P0		470A, 400V	F-71			
ST300S06P	SIS	300A, 600V, 0.2A, 3V	F-71			
ST300S06P0		470A, 600V	F-71			
ST300S08P	SIS	300A, 800V, 0.2A, 3V	F-71			
ST300S08P0		470A, 800V	F-71			
ST300S10P	SIS	300A, 1kV, 0.2A, 3V	F-71			
ST300S10P0		470A, 1kV	F-71			
ST300S12P	SIS	300A, 1.2kV, 0.2A, 3V	F-71			
ST300S12P0		470A, 1.2kV	F-71			
ST300S14P	SIS	300A, 1.4kV, 0.2A, 3V	F-71			
ST300S14P0		470A, 1.4kV	F-71			
ST300S15P	SIS	300A, 1.5kV, 0.2A, 3V	F-71			
ST300S16P0		470A, 1.5kV	F-71			
ST300S18P0		470A, 1.8kV				
ST300S20P0		470A, 2kV				
ST303C02CF.0		1.18kA, 200V	C-10			
ST303C02LF.0		995A, 200V	C-11			
ST303C04CF.0		1.18kA, 400V	C-10			
ST303C04LF.0		995A, 400V	C-11			
ST303C06CF.0		1.18kA, 600V	C-10			
ST303C06LF.0		995A, 600V	C-11			
ST303C08CF.0		1.18kA, 800V	C-10			
ST303C08LF.0		995A, 800V	C-11			
ST303C10CF.0		1.18kA, 1kV	C-10			



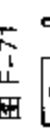
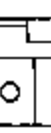
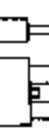
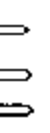
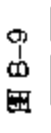

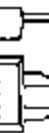
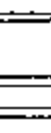
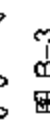
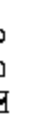
器件型号 Element type	厂名 Manufacturers	材料用途参数 Material Purpose Parameter	图号 Figure	国内外相似替换器件型号 Replace of similar type	备注 Notes	外形参考图 Reference shape
ST303C10LF.0		995A, 1kV	C-11			
ST303C12CF.0		1.18kA, 1.2kV	C-10			
ST303C12LF.0		995A, 1.2kV	C-11			
ST303S02PF.0		471A, 200V				
ST303S04PF.0		471A, 400V				
ST303S06PF.0		471A, 600V				
ST303S08PF.0		471A, 800V				
ST303S10PF.0		471A, 1kV				
ST303S12PF.0		471A, 1.2kV				
ST330C02C	SIS	720A, 200V, 0.2A, 3V	C-50			
ST330C02C0		1.42kA, 200V	B-9			
ST330C02L0		1.23kA, 200V	B-3			
ST330C04C	SIS	720A, 400V, 0.2A, 3V	C-50			
ST330C04C0		1.42kA, 400V	B-9			
ST330C04L0		1.23kA, 400V	B-3			
ST330C06C	SIS	720A, 600V, 0.2A, 3V	C-50			
ST330C06C0		1.42kA, 600V	B-9			
ST330C06L0		1.23kA, 600V	B-3			
ST330C08C	SIS	720A, 800V, 0.2A, 3V	C-50			
ST330C08C0		1.42kA, 800V	B-9			
ST330C08L0		1.23kA, 800V	B-3			
ST330C10C	SIS	720A, 1kV, 0.2A, 3V	C-50			
ST330C10C0		1.42kA, 1kV	B-9			
ST330C10L0		1.23kA, 1kV	B-3			
ST330C12C	SIS	720A, 1.2kV, 0.2A, 3V	C-50			
ST330C12C0		1.42kA, 1.2kV	B-9			
ST330C12L0		1.23kA, 1.2kV	B-3			
ST330C14C	SIS	720A, 1.4kV, 0.2A, 3V	C-50			

器件型号 Element type	厂名 Manufacturers	材料用途参数 Material Purpose Parameter	图号 Figure	国内外相似替换器件型号 Replace of similar type	备注 Notes	外形参考图 Reference shape
ST330C14C0		1.42kV, 1.4kV	B-9			
ST330C14L0		1.23kV, 1.4kV	B-3			
ST330C15C	SIS	720A, 1.5kV, 0.2A, 3V	C-50			
ST330C16C0		1.42kV, 1.6kV	B-9			
ST330C16L0		1.23kV, 1.6kV	B-3			
ST330S02P	SIS	330A, 200V, 0.2A, 3V	F-71			
ST330S02P0		520A, 200V				
ST330S04P	SIS	330A, 400V, 0.2A, 3V	F-71			
ST330S04P0		520A, 400V				
ST330S06P	SIS	330A, 600V, 0.2A, 3V	F-71			
ST330S06P0		520A, 600V				
ST330S08P	SIS	330A, 800V, 0.2A, 3V	F-71			
ST330S08P0		520A, 800V				
ST330S10P	SIS	330A, 1kV, 0.2A, 3V	F-71			
ST330S10P0		520A, 1kV				
ST330S12P	SIS	330A, 1.2kV, 0.2A, 3V	F 71			
ST330S12P0		520A, 1.2kV				
ST330S14P0		520A, 1.4kV				
ST330S16P0		520A, 1.6kV				
ST333C02CFN	SIS	720A, 200V, 0.2A, 3V	C-50			
ST333C02CF.0		1.425kV, 200V	C-10			
ST333C02LF.0		1.23kV, 200V	C-11			
ST333C04CFN	SIS	720A, 400V, 0.2A, 3V	C-50			
ST333C04CF.0		1.425kV, 400V	C-10			
ST333C04LF.0		1.23kV, 400V	C-11			
ST333C06CFN	SIS	720A, 600V, 0.2A, 3V	C-50			
ST333C06CF.0		1.425kV, 600V	C-10			
ST333C06LF.0		1.23kV, 600V	C-11			





器件型号 Element type	厂名 Manufacturers	材料用途参数 Material Purpose Parameter	图号 Figure	国内外相似替换器件型号 Replace of similar type	备注 Notes	外形参考图 Reference shape
ST333C08CF.0		1.425kA, 800V	C-10			
ST333C08LF.0		1.23kA, 800V	C-11			
ST333S02PFN	SIS	330A, 200V, 0.2A, 3V	F-71			
ST333S02PF.0		518A, 200V				
ST333S04PFN	SIS	330A, 400V, 0.2A, 3V	F-71			
ST333S04PF.0		518A, 400V				
ST333S06PFN	SIS	330A, 600V, 0.2A, 3V	F-71			
ST333S06PF.0		518A, 600V				
ST380C02C0		1.9kA, 200V	B-9			
ST380C04C0		1.9kA, 400V	B-9			
ST380C06C0		1.9kA, 600V	B-9			
ST380CH02C0		2.22kA, 200V	B-9			
ST380CH04C0		2.22kA, 400V	B-9			
ST380CH06C0		2.22kA, 600V				
ST700C04L0		1.857kA, 400V	B-3			
ST700C06L0		1.857kA, 600V	B-3			
ST700C08L0		1.857kA, 800V	B-3			
ST700C10L0		1.857kA, 1kV	B-3			
ST700C12L0		1.857kA, 1.2kV	B-3			
ST700C14L0		1.857kA, 1.4kV	B-3			
ST700C16L0		1.857kA, 1.6kV	B-3			
ST700C18L0		1.857kA, 1.8kV	B-3			
ST700C20L0		1.857kA, 2kV	B-3			
ST700C22L0		1.857kA, 2.2kV	B-3			
ST730C04L0		2kA, 400V	B-3			
ST730C06L0		2kA, 600V	B-3			

器件型号 Element type	厂名 Manufacturer's	材料用途参数 Material Purpose Parameter	图号 Figure	国内外相似替换器型号 Replace of similar type	备注 Notes	外形参考图 Reference shape
ST730C08L0		2kA, 800V	B-3			
ST730C10L0		2kA, 1kV	B-3			
ST730C12L0		2kA, 1.2kV	B-3			
ST730C14L0		2kA, 1.4kV	B-3			
ST730C16L0		2kA, 1.6kV	B-3			
ST730C18L0		2kA, 1.8kV	B-3			
ST733C02LF.0		1.875kA, 200V	C-11			 图 B-3
ST733C04LF.0		1.875kA, 400V	C-11			
ST733C06LF.0		1.875kA, 600V	C-11			
ST780C02L0		2.7kA, 200V	B-3			
ST780C04L0		2.7kA, 400V	B-3			
ST780C06L0		2.7kA, 600V	B-3			
ST1200C04K0		3.08kA, 400V				 图 C-11
ST1200C06K0		3.08kA, 600V				
ST1200C08K0		3.08kA, 800V				
ST1200C10K0		3.08kA, 1kV				
ST1200C12K0		3.08kA, 1.2kV				
ST1200C14K0		3.08kA, 1.4kV				
ST1200C16K0		3.08kA, 1.6kV				
ST1200C18K0		3.08kA, 1.8kV				
ST1200C20K0		3.08kA, 2kV				
ST1230C04K0		2.31kA, 400V				
ST1230C06K0		2.31kA, 600V				
ST1230C08K0		2.31kA, 800V				
ST1230C10K0		2.31kA, 1kV				

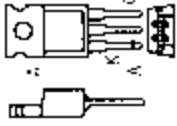

器件型号 Element type	厂名 Manufacturers	材料用途参数 Material Purpose Parameter	图号 Figure	国内外相似替换器件型号 Replace of similar type	备注 Notes	外形参考图 Reference shape
ST1230C12K0		2.31kA, 1.2kV				
ST1230C14K0		2.31kA, 1.4kV				
ST1230C16K0		2.31kA, 1.6kV				
ST1280C02K0		2.3kA, 200V				
ST1280C04K0		2.3kA, 400V				
ST1280C06K0		2.3kA, 600V				
ST1280C08K0		2.3kA, 800V				
ST1900C45R0		3.5kA, 4.5kV				
ST1900C46R0		3.5kA, 4.6kV				
ST1900C48R0		3.5kA, 4.8kV				
ST1900C50R0		3.5kA, 5kV				
ST1900C52R0		3.5kA, 5.2kV				
ST2100C35H0		3.85kA, 3.5kV				
ST2100C36R0		3.85kA, 3.6kV				
ST2100C38R0		3.85kA, 3.8kV				
ST2100C40R0		3.85kA, 4kV				
ST2100C42R0		3.85kA, 4.2kV				
ST2100C44R0		3.85kA, 4.4kV				
ST2100C45R0		3.85kA, 4.5kV				
ST2600C20R0		4.8kA, 2kV				
ST2600C22R0		4.8kA, 2.2kV				
ST2600C24R0		4.8kA, 2.4kV				
ST2600C26R0		4.8kA, 2.6kV				
ST2600C28R0		4.8kA, 2.8kV				
ST2600C30R0		4.8kA, 3kV				

器件型号 Element type	厂名 Manufacturers	材料用途参数 Material Purpose Parameter	图号 Figure	国内外相似替换器件型号 Replace of similar type	备注 Notes	外形参考图 Reference shape
ST3230C10R0 ST3230C12R0 ST3230C14R0 ST3230C16R0 ST3230C18R0		5.95kA, 1kV 5.95kA, 1.2kV 5.95kA, 1.4kV 5.95kA, 1.6kV 5.95kA, 1.8kV				
STY504	SEL	4A, 50V, 0.05A	B-91			 图 B-D1
STY2004 STY3004 STY4004 STY5004 STY6004	SEL	4A, 200V, 0.05A 4A, 300V, 0.05A 4A, 400V, 0.05A 4A, 500V, 0.05A 4A, 600V, 0.05A	B-91 B-91 B-91 B-91 B-91			
SWT681 SWT682 SWT683 SWT685 SWT687 SWT688 SWT689 SWT690	SWT	16A, 25V, 0.075A, 2.5V 16A, 50V, 0.075A, 2.5V 16A, 100V, 0.075A, 2.5V 16A, 200V, 0.075A, 2.5V 16A, 300V, 0.075A, 2.5V 16A, 400V, 0.075A, 2.5V 16A, 500V, 0.075A, 2.5V 16A, 600V, 0.075A, 2.5V	F-21 F-21 F-21 F-21 F-21 F-21 F-21 F-21			 图 F-21
SWT5573 SWT5574	SWT	15A, 200V, 0.075A, 2.5V 15A, 400V, 0.075A, 2.5V	F-21 F-21			



S 类外形参考图索引



图 A-8



图 A-9

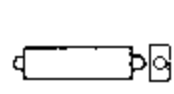

图 A-10

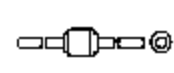

图 A-12



图 B-3

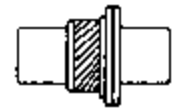

图 B-6

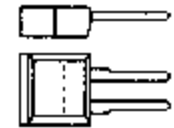

图 B-8

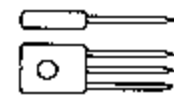

图 B-9

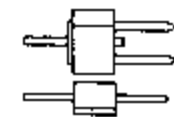

图 B-10

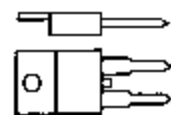

图 B-11

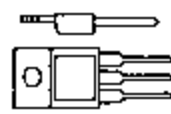

图 B-13

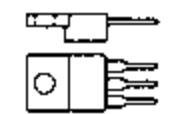

图 B-15

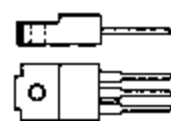

图 B-18

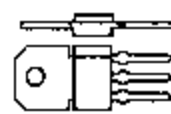

图 B-20

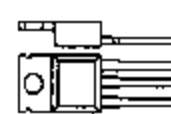

图 B-21

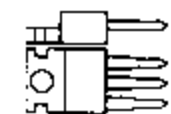

图 B-32

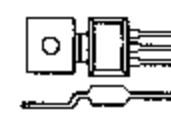

图 B-33

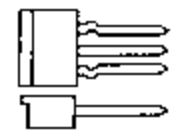

图 B-35

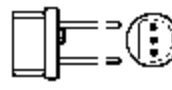

图 B-36



图 B-43



图 B-50



图 B-51

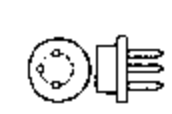

图 B-62



图 B-71

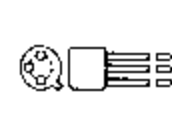

图 B-73



图 B-78



图 B-85



图 B-87



图 B-88

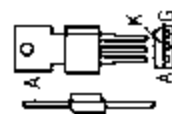

图 B-89

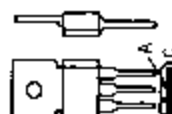

图 B-90

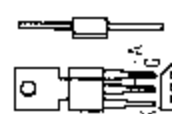

图 B-91

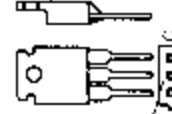

图 B-92

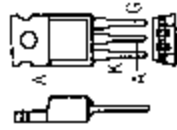

图 B-97

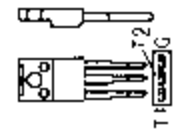

图 B-98

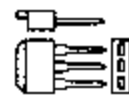

图 B-99



图 C-10

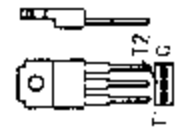

图 C-11



图 C-20



图 C-32

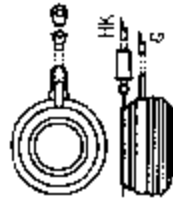

图 C-35

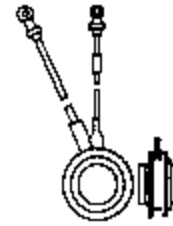

图 C-39



图 C-43

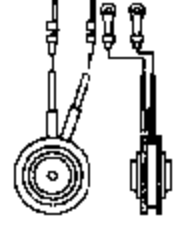

图 C-44

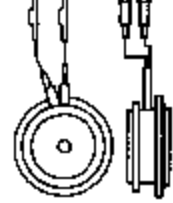

图 C-49

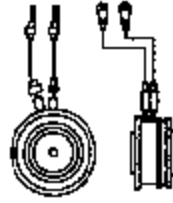

图 C-50

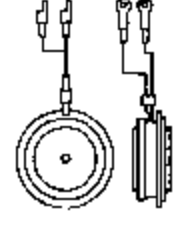

图 C-55

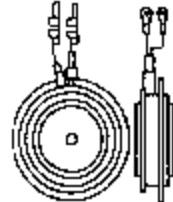

图 C-56

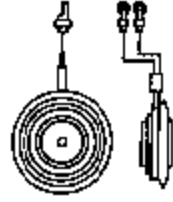

图 C-58

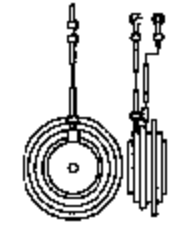

图 C-59

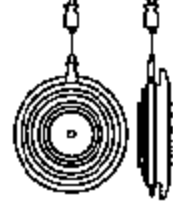

图 C-60

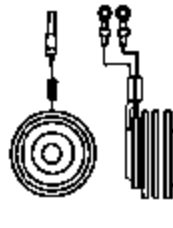

图 C-61

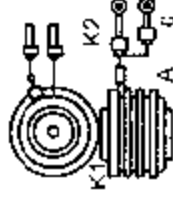

图 C-62

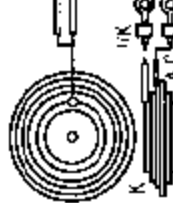

图 C-85

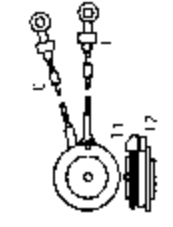

图 D-9

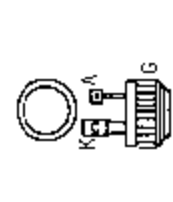

图 D-10

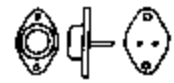

图 D-13

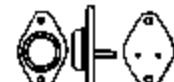

图 D-14

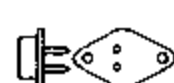

图 D-16



图 D-17



图 D-19



图 D-23





图 D-28

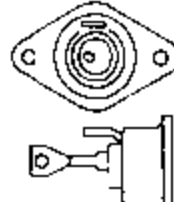

图 D-29

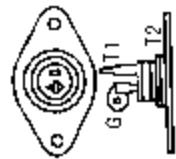

图 D-31

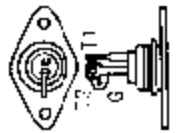

图 D-32

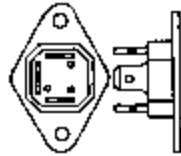

图 D-35

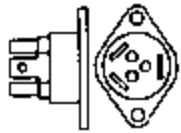

图 E-22

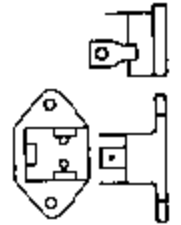

图 E-8



图 E-28



图 E-30

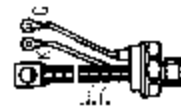

图 F-1

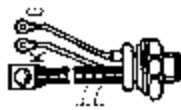

图 F-8



图 F-15



图 F-23



图 F-21



图 F-27



图 F-36



图 F-38



图 F-47



图 F-48



图 F-49

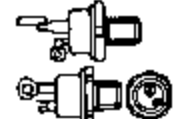

图 F-53

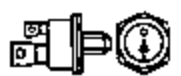

图 F-50

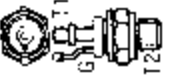

图 F-55



图 F-57



图 F-59



图 F-64



图 F-67

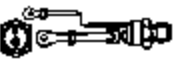

图 F-71

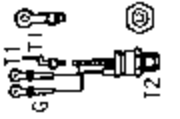

图 F-76



图 F-79



图 F-84



图 F-88



图 F-91



图 G-1



图 G-2

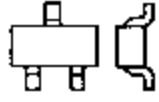

图 G-8

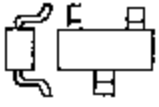

图 G-10

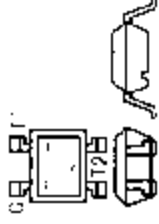

图 G-12

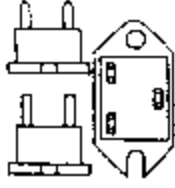

图 H-4

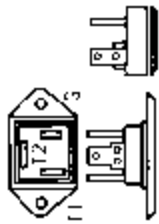

图 H-5

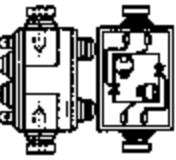

图 H-6

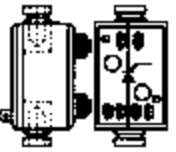

图 H-7

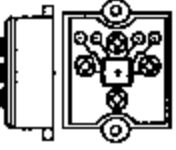

图 H-8

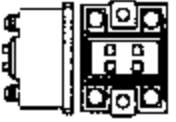

图 H-9

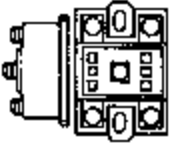

图 H-10

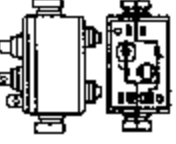

图 H-13

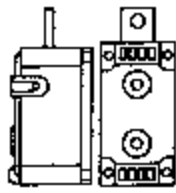

图 H-17

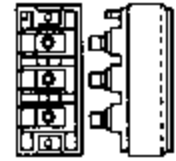

图 H-19

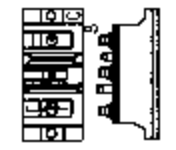

图 H-25



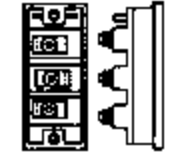



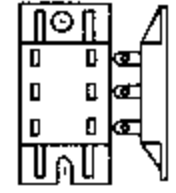



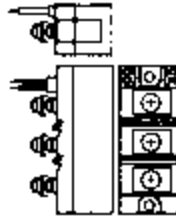
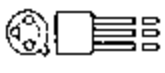







图 H-29



器件型号 Element type	厂名 Manufacturers	材料用途参数 Material Purpose Parameter	图号 Figure	国内外相似替换器件型号 Replace of similar type	备注 Notes	外形参考图 Reference shape
T0.8N/06...5	ITT	50Hz-Thy 0.8A, 60-500V, 0.01A	B-62	BTX30..., S2600..., TAG612..., T1N...		
T0.8N/50...500	AEG	50Hz-Thy 0.8A, 50-500V, 0.01A	B-62	BTX30..., S2600..., TAG612..., T1N...		
T1N/100...600A		50Hz-Thy 1A, 100-600V, 0.01A	B-62	BTX30..., S2600..., TAG612..., TAG613...		
T1A6C		Triac 1A, 600V, 0.01A	B-47	MAC95A, MAC96A		
T3A6CI		Triac =T3A6CP: Iso				
T3A6CP		Triac 3A, 600V, 0.05A	B-11	BT136-600, TAG230-600, TAG231-600, TXC10H60		
T3N/50...600C...		50Hz-Thy 3A, 50-600V, 0.02A	F-55	BSiD41..., S6210..., T6N...C, T8N...C		
T3S/400...700M...		SCR-H 5.1A, 400-700V, 0.05A	D-9	TAG661S..., TAG670S..., TAG675S...		
T3.5N/400...800F...		50Hz-Thy 5A, 400-800V, 0.01A	B-11	TAG661..., TAG662..., TAG666...		
T4.5N/50...400C...		50Hz-Thy 4.5A, 50-400V, 0.02A	F-55	BSiD41..., S2610..., T6N...C, T8N...C		
T5A6CI		Triac =T5A6CP: Iso	B-11	TAC420-600		
T5A6CP		Triac 5A, 600V, 0.05A	B-11	TAG230-600, TAG231-600, TXC10H60M		
T6F/100...800C...		SCR-H 6A, 100-800V, 0.04A	F-55	TAG15S..., T12F...		
T6F/100...800H...		SCR-H =T6F/...C	C-1	TAG15S..., T12F...		
T6F/100...800P...		SCR-H =T6F/...C	C-1	TAG15S..., T12F...		
T6N/100...800C...		50Hz-Thy 6A, 100-800V, 0.02A	F-55	BSiD41..., BSiD41...M, T8N...C, T10N...C		
T6N/100...800H...		50Hz-Thy 6A, 100-800V, 0.02A	D-14	BSiD40..., BSiD41...M, T8N...H, T10N...H		
T6N/100...800P...		50Hz-Thy 6A, 100-800V, 0.02A	D-14	BSiD40..., BSiD41...M, T8N...H, T10N...H		
T6.5N/100...900		50Hz-Thy 6.5A, 100-900V, 0.015A				

器件型号 Element type	厂名 Manufacturers	材料用途参数 Material Purpose Parameter	图号 Figure	国内外相似替换器件型号 Replace of similar type	备注 Notes	外形参考图 Reference shape
T7N100...700F...		50Hz-Thy 7A, 100-700V, 0.02A	B-11	TAG680-..., TAG681-..., TIC126-..., T7.5N...		
T7SH0140B4	WES	400A, 100V, 0.15A, 3V	C-32			
T7SH0145B4	WES	450A, 100V, 0.15A, 3V	C-32			
T7SH0160B4	WES	600A, 100V, 0.15A, 3V	C-32			
T7SH0240B4	WES	400A, 200V, 0.15A, 3V	C-32			
T7SH0245B4	WES	450A, 200V, 0.15A, 3V	C-32			
T7SH0260B4	WES	600A, 200V, 0.15A, 3V	C-32			
T7SH0340B4	WES	400A, 300V, 0.15A, 3V	C-32			
T7SH0345B4	WES	450A, 300V, 0.15A, 3V	C-32			
T7SH0360B4	WES	600A, 300V, 0.15A, 3V	C-32			
T7SH0440B4	WES	400A, 400V, 0.15A, 3V	C-32			
T7SH0445B4	WES	450A, 400V, 0.15A, 3V	C-32			
T7SH0460B4	WES	600A, 400V, 0.15A, 3V	C-32			
T7SH0540B4	WES	400A, 500V, 0.15A, 3V	C-32			
T7SH0545B4	WES	450A, 500V, 0.15A, 3V	C-32			
T7SH0560B4	WES	600A, 500V, 0.15A, 3V	C-32			
T7SH0640B4	WES	400A, 600V, 0.15A, 3V	C-32			
T7SH0645B4	WES	450A, 600V, 0.15A, 3V	C-32			
T7SH0740B4	WES	400A, 700V, 0.15A, 3V	C-32			
T7SH0745B4	WES	450A, 700V, 0.15A, 3V	C-32			
T7SH0760B4	WES	600A, 700V, 0.15A, 3V	C-32			
T7SH0840B4	WES	400A, 800V, 0.15A, 3V	C-32			
T7SH0845B4	WES	450A, 800V, 0.15A, 3V	C-32			
T7SH0860B4	WES	600A, 800V, 0.15A, 3V	C-32			
T7SH0940B4	WES	400A, 900V, 0.15A, 3V	C-32			
T7SH0945B4	WES	450A, 900V, 0.15A, 3V	C-32			
T7SH1040B4	WES	400A, 1KV, 0.15A, 3V	C-32			
T7SH1045B4	WES	450A, 1KV, 0.15A, 3V	C-32			

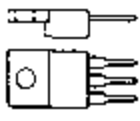

图 B-11



图 C-32



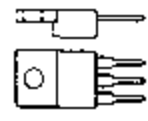

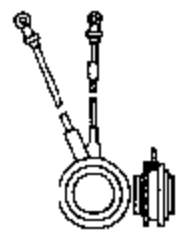
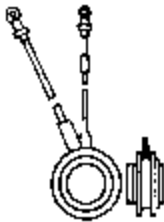
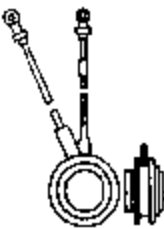

器件型号 Element type	厂名 Manufacturers	材料用途参数 Material Purpose Parameter	图号 Figure	国内外相似替换器件型号 Replace of similar type	备注 Notes	外形参考图 Reference shape
T7SH1140B4	WES	400A, 1.1kV, 0.15A, 3V	C-32			 <p>图 C-32</p>
T7SH1145B4	WES	450A, 1.1kV, 0.15A, 3V	C-32			
T7SH1240B4	WES	400A, 1.2kV, 0.15A, 3V	C-32			
T7SH1245B4	WES	450A, 1.2kV, 0.15A, 3V	C-32			
T7SH014034, 44, 54, 74, 84	WES	400A, 100V, 0.15A, 3V	C-32			
T7SH014534, 44, 54	WES	450A, 100V, 0.15A, 3V	C-32			
T7SH016044, 54, 64	WES	600A, 100V, 0.15A, 3V	C-32			
T7SH024034, 44, 54, 64	WES	400A, 200V, 0.15A, 3V	C-32			
T7SH024534, 44, 54	WES	450A, 200V, 0.15A, 3V	C-32			
T7SH025064, 74, 84	WES	500A, 200V, 0.15A, 3V	C-32			
T7SH026044, 54, 64	WES	600A, 200V, 0.15A, 3V	C-32			
T7SH034034, 44, 54, 64, 74, 84	WES	400A, 300V, 0.15A, 3V	C-32			
T7SH034534, 44, 54	WES	450A, 300V, 0.15A, 3V	C-32			
T7SH035064, 74, 84	WES	500A, 300V, 0.15A, 3V	C-32			
T7SH036044	WES	600A, 300V, 0.15A, 3V	C-32			
T7SH036054	WES	500A, 300V, 0.15A, 3V	C-32			
T7SH036064	WES	600A, 300V, 0.15A, 3V	C-32			

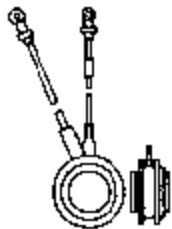
器件型号 Element type	厂名 Manufacturers	材料用途参数 Material Purpose Parameter	图号 Figure	国内外相似替换器件型号 Replace of similar type	备注 Notes	外形参考图 Reference shape
T7SH044034, 44, 54, 64, 74, 84	WES	400A, 400V, 0.15A, 3V	C-32			 图 C-32
T7SH044534, 44, 54	WES	450A, 400V, 0.15A, 3V	C-32			
T7SH045064, 74, 84	WES	500A, 400V, 0.15A, 3V	C-32			
T7SH046044, 54, 64	WES	600A, 400V, 0.15A, 3V	C-32			
T7SH054034, 44, 54, 64, 74, 84	WES	400A, 500V, 0.15A, 3V	C-32			
T7SH054534, 44, 54	WES	450A, 500V, 0.15A, 3V	C-32			
T7SH055064, 74, 84	WES	500A, 500V, 0.15A, 3V	C-32			
T7SH056044	WES	600A, 500V, 0.15A, 3V	C-32			
T7SH056054	WES	500A, 500V, 0.15A, 3V	C-32			
T7SH056064	WES	600A, 500V, 0.15A, 3V	C-32			
T7SH064034, 44, 54, 64, 74, 84	WES	400A, 600V, 0.15A, 3V	C-32			
T7SH064534, 44, 54	WES	450A, 600V, 0.15A, 3V	C-32			
T7SH065084	WES	500A, 600V, 0.15A, 3V	C-32			
T7SH066044	WES	600A, 600V, 0.15A, 3V	C-32			
T7SH066054	WES	500A, 600V, 0.15A, 3V	C-32			
T7SH066064	WES	600A, 600V, 0.15A, 3V	C-32			
T7SH074034, 44, 54, 64, 74, 84	WES	400A, 700V, 0.15A, 3V	C-32			

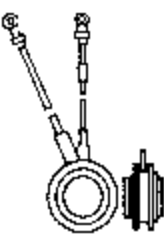

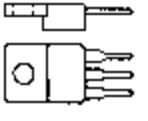
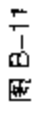
器件型号 Element type	厂名 Manufacturers	材料用途参数 Material Purpose Parameter	图号 Figure	国内外相似替换器件型号 Replace of similar type	备注 Notes	外形参考图 Reference shape
T7SH074534, 44, 54	WES	450A, 700V, 0.15A, 3V	C-32			 <p>图 C-32</p>
T7SH075064, 74, 84	WES	500A, 700V, 0.15A, 3V	C-32			
T7SH076044, 54, 64	WES	600A, 700V, 0.15A, 3V	C-32			
T7SH084034, 44, 54, 64, 74, 84	WES	400A, 800V, 0.15A, 3V	C-32			
T7SH084534, 44, 54	WES	450A, 800V, 0.15A, 3V	C-32			
T7SH085064, 74, 84	WES	500A, 800V, 0.15A, 3V	C-32			
T7SH086044	WES	600A, 700V, 0.15A, 3V	C-32			
T7SH086054	WES	500A, 800V, 0.15A, 3V	C-32			
T7SH086064	WES	600A, 800V, 0.15A, 3V	C-32			
T7SH094034, 44, 54, 64, 74, 84	WES	400A, 900V, 0.15A, 3V	C-32			
T7SH094534, 44, 54	WES	450A, 900V, 0.15A, 3V	C-32			
T7SH104034, 44, 54, 64, 74, 84	WES	400A, 1kV, 0.15A, 3V	C-32			
T7SH104534, 44, 54	WES	450A, 1kV, 0.15A, 3V	C-32			
T7SH114034, 44, 54, 64, 74, 84	WES	400A, 1.1kV, 0.15A, 3V	C-32			
T7SH114534, 44, 54	WES	450A, 1.1kV, 0.15A, 3V	C-32			

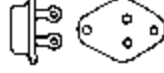
器件型号 Element type	厂名 Manufacturers	材料用途参数 Material Purpose Parameter	图号 Figure	国内外相似替换器件型号 Replace of similar type	备注 Notes	外形参考图 Reference snapc
T7SH124034, 44, 54, 64, 74, 84	WES	400A, 1.2KV, 0.15A, 3V	C-32			
T7SH124534, 44, 54	WES	450A, 1.2KV, 0.15A, 3V	C-32			
T7.5N/400...800F...		50Hz-Thy 9A, 400-800V, 0.025A	B-11	CS15..., TIC126..., T9.5N...		 图 C-32
T8A6CI		Triac =T8A6CP: Iso	B-11	TAG425-600, TAG426-600, TAG451-600, TAG452-600		
T8A6CP		Triac 8A, 600V, 0.05A	B-11	BT137-600, MAC222A-B, T2800M		 图 B-11
T8F100...800C...		SCR-H 8A, 100-800V, 0.04A	F-55	TAG15S..., T12F...		 图 F-55
T8F100...800H...		SCR-H =T8F/...C	D-14			
T8F100...800P...		SCR-H =T8F/...C	D-14			
T8F100COB, COE, COC		SCR-H 8A, 100V	F-55	TAG15S100, T12F100CCB		
T8F100HOB, HOE, HOC, POB, POE, POC		SCR-H 8A, 100V	D-14			
T8F200COB, COE, COC		SCR-H 8A, 200V	F-55	TAG15S200, T12F200CCB		
T8F200HOB, HOE, HOC, POB, POE, POC		SCR-H 8A, 200V	D-14			 图 D-14
T8F300COB, COE, COC		SCR-H 8A, 300V	F-55	TAG15S300, T12F300CCB		



器件型号 Element type	厂名 Manufacturers	材料用途参数 Material Purpose Parameter	图号 Figure	国内外相似替换器件型号 Repiace of similar type	备注 Notes	外形参考图 Reference shape
T8F300HOB, HOE, HOC, POB, POE, POC	SCR-H	8A, 300V	D-14			
T8F400COB, COE, COC	SCR-H	8A, 400V	F-55	TAG15S400, T12F400CCB		
T8F400HOB, HOE, HOC, POB, POE, POC	SCR-H	8A, 400V	D-14			
T8F500COB, COE, COC	SCR-H	8A, 500V	F-55	TAG15S500, T12F500CCB		
T8F500HOB, HOE, HOC, POB, POE, POC	SCR-H	8A, 500V	D-14			
T8F600COB, COE, COC	SCR-H	8A, 600V	F-55	TAG15S600, T12F600CCB		
T8F600HOB, HOE, HOC, POB, POE, POC	SCR-H	8A, 600V	D-14			
T8F700COB, COE, COC	SCR-H	8A, 700V	F-55	TAG15S700, T12F700CCB		
T8F700HOB, HOE, HOC, POB, POE, POC	SCR-H	8A, 700V	D-14			











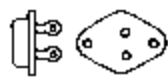





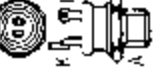



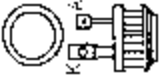

图 D-14









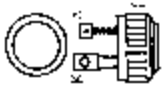
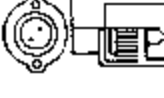

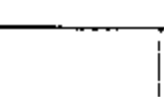

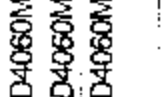
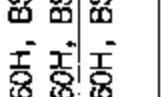
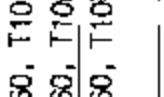
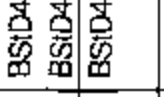
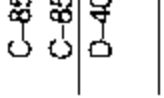
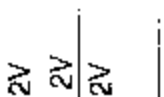
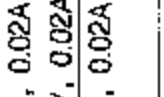
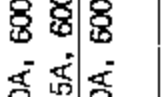
图 F-55

器件型号 Element type	厂名 Manufacturers	材料 Material	用途 Purpose	参数 Parameter	图号 Figure	国内外相似替换器件型号 Replace of similar type	备注 Notes	外形参考图 Reference shape
T8F800COB, COF, COC	SCR-H	8A, 800V			F-55	TAG15S800, T12F800CCB		
T8F800HOB, HOE, HOC, POB, POE, POC	SCR-H	8A, 800V			D-14			 图 F-55 
T8F900COB, COE, COC	SCR-H	8A, 900V			F-55	TAG15S900, T12F900CCB		
T8F900HOB, HOE, HOC, POB, POE, POC	SCR-H	8A, 900V			D-14			 图 D-14
T8N100COB	AEG	10A, 100V, 0.02A, 2V			F-21	BSID41100, T10N100C, BSID41100M		
T8N100COE	AEG	10A, 100V, 0.02A, 2V			F-21	BSID41100, T10N100C, BSID41100M		
T8N100COC	AEG	16A, 100V, 0.02A, 2V			F-21	BSID41100, T10N100C, BSID41100M		
T8N100HOB	AEG	10A, 100V, 0.02A, 2V			C-85	BSID40100, T10N100H, BSID40100M		
T8N100HOE	AEG	10A, 100V, 0.02A, 2V			C-85	BSID40100, T10N100H, BSID40100M		
T8N100HOC	AEG	9.5A, 100V, 0.02A, 2V			C-85	BSID40100, T10N100H, BSID40100M		
T8N100POB, POE	AEG	10A, 100V, 0.02A, 2V			D-40	BSID40100, T10N100H, BSID40100M		
T8N200COB	AEG	10A, 200V, 0.02A, 2V			F-21	BSID4120, T10N20C, BSID4120M		
T8N200COE	AEG	10A, 200V, 0.02A, 2V			F-21	BSID4120, T10N20C, BSID4120M		
T8N200COC	AEG	16A, 200V, 0.02A, 2V			F-21	BSID4120, T10N20C, BSID4120M		
T8N200HOB	AEG	10A, 200V, 0.02A, 2V			C-85	BSID4020, T10N20H, BSID4020M		
T8N200HOE	AEG	10A, 200V, 0.02A, 2V			C-85	BSID4020, T10N20H, BSID4020M		
T8N200HOC	AEG	9.5A, 200V, 0.02A, 2V			C-85	BSID4020, T10N20H, BSID4020M		
T8N200POB, POE, POC	AEG	10A, 200V, 0.02A, 2V			D-40	BSID4020, T10N20H, BSID4020M		

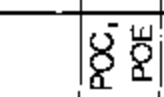

器件型号 Element type	厂名 Manufacturers	材料用途参数 Material Purpose Parameter	图号 Figure	国内外相似替换器件型号 Replace of similar type	备注 Notes	外形参考图 Reference shape	
T8N300COB	AEG	10A, 300V, 0.02A, 2V	F-21	BSiD4130, T10N30C, BSiD4130M		 图 F-21	
T8N300COE	AEG	10A, 300V, 0.02A, 2V	F-21	BSiD4130, T10N30C, BSiD4130M			
T8N300COC	AEG	16A, 300V, 0.02A, 2V	F-21	BSiD4130, T10N30C, BSiD4130M			
T8N300HOB	AFG	10A, 300V, 0.02A, 2V	C-85	BSiD4030, T10N30H, BSiD4030M			
T8N300HOE	AEG	10A, 300V, 0.02A, 2V	C-85	BSiD4030, T10N30H, BSiD4030M			
T8N300HOC	AEG	9.5A, 300V, 0.02A, 2V	C-85	BSiD4030, T10N30H, BSiD4030M			
T8N300POB, POC, POE	AEG	10A, 300V, 0.02A, 2V	D-40	BSiD4030, T10N30H, BSiD4030M			
T8N400COB	AEG	10A, 400V, 0.02A, 2V	F-21	BSiD4140, T10N40C, BSiD4140M			 图 C-85
T8N400COE	AEG	10A, 400V, 0.02A, 2V	F-21	BSiD4140, T10N40C, BSiD4140M			
T8N400COC	AEG	16A, 400V, 0.02A, 2V	F-21	BSiD4140, T10N40C, BSiD4140M			
T8N400HOB	AEG	10A, 400V, 0.02A, 2V	C-85	BSiD4040, T10N40H, BSiD4040M			
T8N400HOE	AEG	10A, 400V, 0.02A, 2V	C-85	BSiD4040, T10N40H, BSiD4040M			
T8N400HOC	AFG	9.5A, 400V, 0.02A, 2V	C-85	BSiD4040, T10N40H, BSiD4040M			
T8N400POB	AEG	10A, 400V, 0.02A, 2V	D-40	BSiD4040, T10N40H, BSiD4040M			
T8N400POC	AEG	10A, 400V, 0.02A, 2V	D-40	BSiD4040, T10N40H, BSiD4040M			
T8N400POE	AEG	10A, 400V, 0.02A, 2V	D-40	BSiD4040, T10N40H, BSiD4040M			
T8N500COB	AEG	10A, 500V, 0.02A, 2V	F-21	BSiD4150, T10N50C, BSiD4150M		 图 D-40	
T8N500COE	AEG	10A, 500V, 0.02A, 2V	F-21	BSiD4150, T10N50C, BSiD4150M			
T8N500COC	AEG	16A, 500V, 0.02A, 2V	F-21	BSiD4150, T10N50C, BSiD4150M			
T8N500HOB	AEG	10A, 500V, 0.02A, 2V	C-85	BSiD4050, T10N50H, BSiD4050M			
T8N500HOE	AEG	9.5A, 500V, 0.02A, 2V	C-85	BSiD4050, T10N50H, BSiD4050M			
T8N500HOC	AEG	10A, 500V, 0.02A, 2V	D-40	BSiD4050, T10N50H, BSiD4050M			
T8N500POB	AEG	10A, 500V, 0.02A, 2V	D-40	BSiD4050, T10N50H, BSiD4050M			
T8N600COB	AEG	10A, 600V, 0.02A, 2V	F-21	BSiD4160, T10N60C, BSiD4160M			
T8N600COE	AEG	10A, 600V, 0.02A, 2V	F-21	BSiD4160, T10N60C, BSiD4160M			
T8N600COC	AEG	16A, 600V, 0.02A, 2V	F-21	BSiD4160, T10N60C, BSiD4160M			

器件型号 Element type	厂名 Manufacturers	材料用途参数 Material Purpose Parameter	图号 Figure	国内外相似替换器件型号 Replace of similar type	备注 Notes	外形参考图 Reference snapc
T8N600HOB	AEG	10A, 600V, 0.02A, 2V	C-85	BSID4060, T10N60H, BSID4060M		
T8N600HOE	AEG	10A, 600V, 0.02A, 2V	C-85	BSID4060, T10N60H, BSID4060M		
T8N600HOC	AEG	9.5A, 600V, 0.02A, 2V	C-85	BSID4060, T10N60H, BSID4060M		
T8N600POB, POC, POE	AEG	10A, 600V, 0.02A, 2V	D-40	BSID4060, T10N60H, BSID4060M		
T8N700COB	AEG	10A, 700V, 0.02A, 2V	F-21	BSID4170, T10N70C, BSID4170M		
T8N700COE	AEG	10A, 700V, 0.02A, 2V	F-21	BSID4170, T10N70C, BSID4170M		
T8N700COE	AEG	16A, 700V, 0.02A, 2V	F-21	BSID4170, T10N70C, BSID4170M		
T8N700HOB	AEG	10A, 700V, 0.02A, 2V	C-85	BSID4070, T10N70H, BSID4070M		
T8N700HOE	AEG	10A, 700V, 0.02A, 2V	C-85	BSID4070, T10N70H, BSID4070M		
T8N700HOC	AEG	9.5A, 700V, 0.02A, 2V	C-85	BSID4070, T10N70H, BSID4070M		
T8N700POB, POC, POE	AEG	10A, 700V, 0.02A, 2V	D-40	BSID4070, T10N70H, BSID4070M		
T8N800COB, COE, COE	AEG	10A, 800V, 0.02A, 2V	F-21	BSID4180, T10N80C, BSID4180M		
T8N800HOB, HOC, HOE	AEG	10A, 800V, 0.02A, 2V	C-85	BSID4080, T10N80H, BSID4080M		
T8N800POB, POC, POE	AEG	10A, 800V, 0.02A, 2V	D-40	BSID4080, T10N80H, BSID4080M		
T8N100...800C...		50Hz-Thy 8A, 100-800V, 0.02A, 0.06A	F-55	BSID41..., BSID41...M, T10N...C		
T8N100...800H...		50Hz-Thy =T8N...C	D-14	BSID41..., BSID41...M, T10N...H		
T8N100...800P...		50Hz-Thy =T8N...C	D-14	BSID41..., BSID41...M, T10N...H		
T9G0060803DH	WES	800A, 600V, 0.2A, 3V	C-47			
T9G0061003DH	WES	1.6kA, 600V, 0.2A, 3V	C-47			
T9G0061203DH	WES	1.9kA, 600V, 0.2A, 3V	C-47			

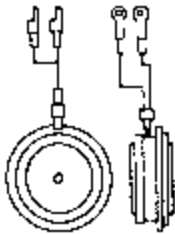

器件型号 Element type	厂名 Manufacturers	材料用途参数 Material Purpose Parameter	图号 Figure	国内外相似替换器件型号 Replace of similar type	备注 Notes	外形参考图 Reference shape
T9G0080803DH	WES	800A, 600V, 0.2A, 3V	C-47			 <p>图 C-47</p>
T9G0081003DH	WES	1.6kA, 800V, 0.2A, 3V	C-47			
T9G0100803DH	WES	800A, 1kV, 0.2A, 3V	C-47			
T9G0101203DH	WES	1.9kA, 1kV, 0.2A, 3V	C-47			
T9G0120803DH	WES	1.25kA, 1.2kV, 0.2A, 3V	C-47			
T9G0121003DH	WES	1.6kA, 1.2kV, 0.2A, 3V	C-47			
T9G0121203DH	WES	1.9kA, 1.2kV, 0.2A, 3V	C-47			
T9G0140803DH	WES	1.25kA, 1.4kV, 0.2A, 3V	C-47			
T9G0141003DH	WES	1.6kA, 1.4kV, 0.2A, 3V	C-47			
T9G0141203DH	WES	1.9kA, 1.4kV, 0.2A, 3V	C-47			
T9G0160803DH	WES	1.25kA, 1.6kV, 0.2A, 3V	C-47			
T9G0161003DH	WES	1.6kA, 1.6kV, 0.2A, 3V	C-47			
T9G0161203DH	WES	1.9kA, 1.6kV, 0.2A, 3V	C-47			
T9GH0608C2DH, K2DH	WES	1.25kA, 600V, 0.3A, 3V	C-47			
T9GH0609C2DH, K2DH	WES	1.4kA, 600V, 0.3A, 3V	C-47			
T9GH0610B2DH	WES	1.57kA, 600V, 0.3A, 3V	C-47			
T9GH0611K2DH	WES	1.72kA, 600V, 0.3A, 3V	C-47			
T9GH0808C2DH, K2DH	WES	1.25kA, 800V, 0.3A, 3V	C-47			
T9GH0809C2DH, K2DH	WES	1.4kA, 800V, 0.3A, 3V	C-47			
T9GH0810B2DH		1.57kA, 800V, 0.3A, 3V	C-47			

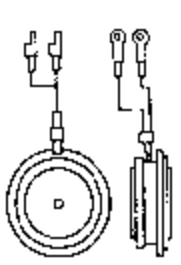
器件型号 Element type	厂名 Manufacturers	材料用途参数 Material Purpose Parameter	图号 Figure	国内外相似替换器件型号 Replace of similar type	备注 Notes	外形参考图 Reference shape
T9GH1008C2DH, K2DH	WES	1.25kA, 1kV, 0.3A, 3V	C-47			 图 C-47
T9GH1009C2DH, K2DH	WES	1.4kA, 1kV, 0.3A, 3V	C-47			
T9GH1010B2DH	WES	1.57kA, 1kV, 0.3A, 3V	C-47			
T9GH1010K2DH	WES	1.72kA, 1kV, 0.3A, 3V	C-47			
T9GH1208 C2DH, K2DH	WES	1.25kA, 1.2kV, 0.3A, 3V	C-47			
T9GH1210B2DH	WES	1.57kA, 1.2kV, 0.3A, 4V	C-47			
T9GH1211K2DH	WES	1.72kA, 1.2kV, 0.3A, 3V	C-47			
T9GH1408 C2DH, K2DH	WES	1.25kA, 1.4kV, 0.3A, 3V	C-47			
T9GH1409C2DH	WES	1.4kA, 1.4kV, 0.3A, 3V	C-47			
T9GH1508C2DH, K2DH	WES	1.25kA, 1.5kV, 0.3A, 3V	C-47			
T9GH1509C2DH, K2DH	WES	1.4kA, 1.5kV, 0.3A, 3V	C-47			
T9GH1608C2DH, K2DH	WES	1.25kA, 1.6kV, 0.3A, 3V	C-47			
T9GH1609C2DH, K2DH	WES	1.4kA, 1.6kV, 0.3A, 3V	C-47			
T9GH1706C2DH, K2DH	WES	1.25kA, 1.7kV, 0.3A, 3V	C-47			

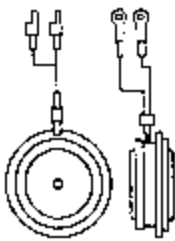

器件型号 Element type	厂名 Manufacturers	材料用途参数 Material Purpose Parameter	图号 Figure	国内外相似替换器件型号 Replace of similar type	备注 Notes	外形参考图 Reference shape
T9GH1709C2DH, K2DH	WES	1.4kA, 1.7kV, 0.3A, 3V	C-47			 图 C-47
T9GH1909K2DH, C2DH	WES	1.4kA, 1.9kV, 0.3A, 3V	C-47			
T9GH2009C2DH, K2DH	WES	1.4kA, 2kV, 0.3A, 3V	C-47			
T9GH2108C2DH, K2DH	WES	1.25kA, 2.1kV, 0.3A, 3V	C-47			
T9GH2109C2DH, K2DH	WES	1.4kA, 2.1kV, 0.3A, 3V	C-47			
T9GH2209C2DH, K2DH	WES	1.4kA, 2.2kV, 0.3A, 3V	C-47			
T9GH060842DH	WES	1.25kA, 600V, 0.3A, 3V	C-47			
T9GH060922DH	WES	1.4kA, 600V, 0.3A, 3V	C-47			
T9GH061022DH, 32DH, 42DH, 52DH	WES	1.57kA, 600V, 0.3A, 3V	C-47			
T9GH080842DH	WES	1.25kA, 800V, 0.3A, 3V	C-47			
T9GH080942DH	WES	1.4kA, 800V, 0.3A, 3V	C-47			
T9GH081022DH, 32DH, 42DH, 52DH	WES	1.57kA, 800V, 0.3A, 3V	C-47			
T9GH100842DH	WES	1.25kA, 1kV, 0.3A, 3V	C-47			

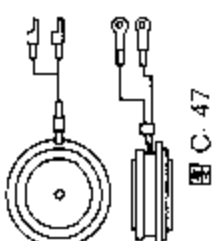
器件型号 Element type	厂名 Manufacturers	材料用途参数 Material Purpose Parameter	图号 Figure	国内外相似替换器作型号 Replace of similar type	备注 Notes	外形参考图 Reference shape
T9GH100922DH, 42DH	WES	1.4kA, 1kV, 0.3A, 3V	C-47			 <p>图 C-47</p>
T9GH101022DH, 32D, 42DH, 52DH, 62DH	WES	1.57kA, 1kV, 0.3A, 3V	C-47			
T9GH120842DH	WES	1.25kA, 1.2kV, 0.3A, 3V	C-47			
T9GH121022DH, 32DH, 42DH, 52DH	WES	1.57kA, 1.2kV, 0.3A, 3V	C-47			
T9GH121122DH	WES	1.72kA, 1.2kV, 0.3A, 3V	C-47			
T9GH140842DH	WES	1.25kA, 1.4kV, 0.3A, 3V	C-47			
T9GH140922DH	WES	1.4kA, 1.4kV, 0.3A, 3V	C-47			
T9GH150842DH	WES	1.25kA, 1.5kV, 0.3A, 3V	C-47			
T9GH150922DH, 42DH	WES	1.4kA, 1.5kV, 0.3A, 3V	C-47			
T9GH160842DH	WES	1.25kA, 1.6kV, 0.3A, 3V	C-47			
T9GH160922DH, 42DH	WES	1.4kA, 1.6kV, 0.3A, 3V	C-47			
T9GH170842DH	WES	1.25kA, 1.7kV, 0.3A, 3V	C-47			
T9GH170922DH, 42DH	WES	1.4kA, 1.7kV, 0.3A, 3V	C-47			
T9GH180922DH, 42DH	WES	1.4kA, 1.8kV, 0.3A, 3V	C-47			





器件型号 Element type	厂名 Manufacturers	材料用途参数 Material Purpose Parameter	图号 Figure	国内外相似替换器件型号 Replace of similar type	备注 Notes	外形参考图 Reference shape
T9GH190822DH, 32DH, 42DH	WES	1.25kA, 1.9kV, 0.3A, 3V	C-47			
T9GH190922DH, 32DH, 42DH	WES	1.4kA, 1.9kV, 0.3A, 3V	C-47			
T9GH200922DH, 32DH, 42DH	WES	1.4kA, 2kV, 0.3A, 3V	C-47			
T9GH210822DH, 32DH, 42DH	WES	1.25kA, 2.1kV, 0.3A, 3V	C-47			
T9GH210922DH, 32DH, 42DH	WES	1.4kA, 2.1kV, 0.3A, 3V	C-47			
T9GH220922DH, 32DH, 42DH	AES	1.4kA, 2.2kV, 0.3A, 3V	C-47			
T9N100...700F...		50Hz-Thy 9A, 100-700V, 0.02A	B-11	CS15..., T9.5N...		
T9.5N/400...600F...		50Hz-Thy 11A, 400-800V, 0.025A	B-11	CS15...		
T9.5N/400FOB	WES	11A, 400V, 0.025A, 2V	B-91			
T9.5N/600FOB	WES	11A, 600V, 0.025A, 2V	B-91			
T9.5N/700FOB	WES	11A, 700V, 0.025A, 2V	B-91			
T9.5N/800FOB	WES	11A, 800V, 0.025A, 2V	B-91			
T10N100COB	AEG	12.7A, 100V, 0.02A, 2V	F-21			
T10N100COE	AEG	12.7A, 100V, 0.02A, 2V	F-21			
T10N100COC	AEG	20A, 100V, 0.02A, 2V	F-21			

图 C-47



图 D-11

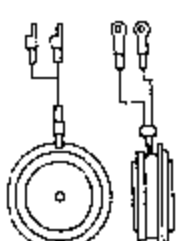
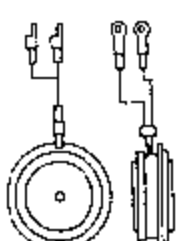
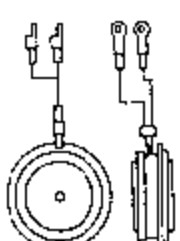
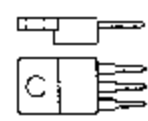

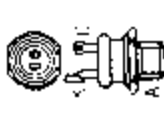
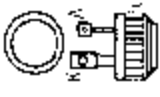
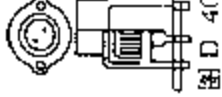
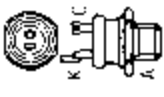

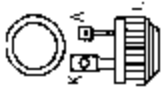

图 B-91

图 F-21

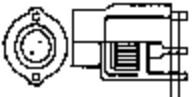

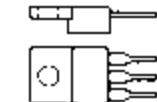

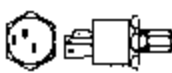
器件型号 Element type	厂名 Manufacturers	材料用途参数 Material Purpose Parameter	图号 Figure	国内外相似替换器件型号 Replace of similar type	备注 Notes	外形参考图 Reference shape
T10N100HOB, HOE, HOC	AEG	12.7A, 100V, 0.02A, 2V	C-85			 图 C-85
T10N100POB, POE, POC	AEG	12.7A, 100V, 0.02A, 2V	D-40			 图 D-40
T10N200COB, COE	AEG	12.7A, 200V, 0.02A, 2V	F-21			
T10N200COC	AEG	20A, 200V, 0.02A, 2V	F-21			
T10N200HOB	AEG	12.7A, 200V, 0.02A, 2V	C-85			
T10N200HOC	AEG	12A, 200V, 0.02A, 2V	C-85			
T10N200POC, POE	AEG	12.7A, 200V, 0.02A, 2V	D-40			
T10N300COB	AEG	12.7A, 300V, 0.02A, 2V	F-21			
T10N300HOC	AEG	12A, 300V, 0.02A, 2V	C-85			
T10N300HOE	AEG	12.7A, 300V, 0.02A, 2V	C-85			
T10N300POB, POC, POE	AEG	12.7A, 300V, 0.02A, 2V	D-40			
T10N400COB	AEG	12.7A, 400V, 0.02A, 2V	F-21			
T10N400COE	AEG	12.7A, 400V, 0.02A, 2V	F-21			
T10N400COC	AEG	20A, 400V, 0.02A, 2V	F-21			
T10N400HOB	AEG	12.7A, 400V, 0.02A, 2V	C-85			
T10N400HOE	AEG	12.7A, 400V, 0.02A, 2V	C-85			
T10N400HOC	AEG	12A, 400V, 0.02A, 2V	C-85			 图 F-21
T10N400POB, POC, POE	AEG	12.7A, 400V, 0.02A, 2V	D-40			
T10N500COB	AEG	12.7A, 500V, 0.02A, 2V	F-21			
T10N500COE	AEG	12.7A, 500V, 0.02A, 2V	F-21			
T10N500COC	AEG	20A, 500V, 0.02A, 2V	F-21			

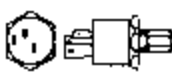



器件型号 Element type	厂名 Manufacturers	材料用途参数 Material Purpose Parameter	图号 Figure	国内外相似替换器件型号 Replace of similar type	备注 Notes	外形参考图 Reference shape
T10N500HOB	AEG	12.7A, 500V, 0.02A, 2V	C-85			 图 C-85
T10N500HOE	AEG	12.7A, 500V, 0.02A, 2V	C-85			
T10N500HOC	AEG	12A, 500V, 0.02A, 2V	C-85			
T10N500POB, POC, POE	AEG	12.7A, 400V, 0.02A, 2V	D-40			
T10N600COB	AEG	12.7A, 600V, 0.02A, 2V	F-21			 图 D-40
T10N600COE	AEG	12.7A, 600V, 0.02A, 2V	F-21			
T10N600COC	AEG	20A, 600V, 0.02A, 2V	F-21			
T10N600HOB	AEG	12.7A, 600V, 0.02A, 2V	C-85			
T10N600HOE	AEG	12.7A, 600V, 0.02A, 2V	C-85			
T10N600HOC	AEG	12A, 600V, 0.02A, 2V	C-85			
T10N600POB, POC, POE	AEG	12.7A, 600V, 0.02A, 2V	D-40			
T10N700COB	AEG	12.7A, 700V, 0.02A, 2V	F-21			 图 G-21
T10N700COE	AEG	12.7A, 700V, 0.02A, 2V	F-21			
T10N700COC	AEG	20A, 700V, 0.02A, 2V	F-21			
T10N700HOB	AEG	12.7A, 700V, 0.02A, 2V	C-85			
T10N700HOE	AEG	12.7A, 700V, 0.02A, 2V	C-85			
T10N700HOC	AEG	12A, 700V, 0.02A, 2V	C-85			
T10N700POB, POC, POE	AEG	12.7A, 700V, 0.02A, 2V	D-40			
T10N800COB, COE, COE	AEG	12.7A, 800V, 0.02A, 2V	F-21			
T10N800HOB, HOC, HOE	AEG	12.7A, 800V, 0.02A, 2V	C-85			

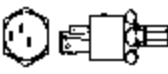

器件型号 Element type	厂名 Manufacturers	材料用途参数 Material Purpose Parameter	图号 Figure	国内外相似替换器件型号 Replace of similar type	备注 Notes	外形参考图 Reference shape
T10N800POB, POC, POE	AEG	12.7A, 800V, 0.02A, 2V	D-40			 图 D-40  图 F-55
T10N100...900C...		50Hz-Thy 10A, 100~900V, 0.025A	F-55			
T10N100...900H...		50Hz-Thy =T10N/...C	D-14			
T10N100...900P...		50Hz-Thy =T10N/...C	D-14			
T12A6CI		Triac =T12A6CP; Iso	B-11	TAG480-600, TAG481-600		
T12A6CP		Triac 12A, 600V, 0.05A	B-11	BTA23M, TAG255-600, TAG257-600, TXD101H60P		
T12F100CCB	AEG	16A, 100V, 0.05A, 2V	F-21			
T12F100CDB	AEG	16A, 100V, 0.05A, 2V	F-21			  图 D-14  图 B-11
T12F100CCC, CCL, CCM, CDC, CDL, CDM	AEG	19A, 100V, 0.05A, 2V	F-21			
T12F100RCB, RCC, RCL, RCM, RDB, RDC, RDL, RDM	AEG	19A, 100V, 0.05A, 2V	F-56			
T12F200CCB	AEG	16A, 200V, 0.05A, 2V	F-21			
T12F200CDB	AEG	16A, 200V, 0.05A, 2V	F-21			  图 F-21
T12F200CCC, CCL, CCM, CDC, CDL, CDM	AEG	19A, 200V, 0.05A, 2V	F-21			
T12F200RCB, RCC, RCL, RCM, RDB, RDC, RDL, RDM	AEG	19A, 200V, 0.05A, 2V	F-56			 图 F-21  图 F-56
T12F300CCB, CDB	AEG	16A, 300V, 0.05A, 2V	F-21			

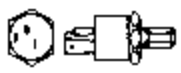

器件型号 Element type	厂名 Manufacturers	材料用途参数 Material Purpose Parameter	图号 Figure	国内外相似替换器件型号 Replace of similar type	备注 Notes	外形参考图 Reference shape
T12F300CCC, CCL, CCM, CDC, CDL, CDM	AEG	19A, 300V, 0.05A, 2V	F-21			 图 F-21
T12F300RCB, RCC, RCL, RCM, RDB, RDC, RDL, RDM	AEG	19A, 300V, 0.05A, 2V	F-56			
T12F400CCB, CDB	AEG	16A, 400V, 0.05A, 2V	F-21			 图 F-21
T12F400CC, CCL, CCM, CDC, CDL, CDM	AEG	19A, 400V, 0.05A, 2V	F-21			
T12F400RCB, RCC, RCL, RCM	AEG	19A, 400V, 0.05A, 2V	F-56			
T12F500CCB	AEG	16A, 500V, 0.05A, 2V	F-21			 图 F-56
T12F500CDB	AEG	16A, 500V, 0.05A, 2V	F-21			
T12F500CCC, CCL, CCM, CDC, CDL, CDM	AEG	19A, 500V, 0.05A, 2V	F-21			
T12F500RCB, RCC, RCL, RCM, RDB, RDC, RDL, RDM	AEG	19A, 500V, 0.05A, 2V	F-56			
T12F600CCB	AEG	16A, 600V, 0.05A, 2V	F-21			 图 F-21
T12F600CDB	AEG	16A, 600V, 0.05A, 2V	F-21			
T12F600CCC, CCL, CCM, CDC, CDL, CDM	AEG	19A, 600V, 0.05A, 2V	F-21			



器件型号 Element type	厂名 Manufacturers	材料用途参数 Material Purpose Parameter	图号 Figure	国内外相似替换器件型号 Replace of similar type	备注 Notes	外形参考图 Reference shape
T12F600RCB, RCC, RCL, RCM, RDB, RDC, RDL, RDM	AEG	19A, 600V, 0.05A, 2V	F-56			 图 F-56
T12F700CCB	AEG	16A, 700V, 0.05A, 2V	F-21			
T12F700CUB	AEG	16A, 700V, 0.05A, 2V	F-21			
T12F700CCC, CCL, CCM, CDD, CDL, CDM	AEG	19A, 700V, 0.05A, 2V	F-21			
T12F700RCB, RCC, RCL, RCM, RDB, RDC, RDL, RDM	AEG	19A, 700V, 0.05A, 2V	F-56			
T12F800CCB, CDB	AEG	16A, 800V, 0.05A, 2V	F-21			
T12F800CC, CCL, CCM, CDC, CDL, CDM	AEG	19A, 800V, 0.05A, 2V	F-21			 图 F-21
T12F800RCB, RCC, RCL, RCM, RDB, RDC, RDL, RDM	AEG	19A, 800V, 0.05A, 2V	F-56			
T12F900CCB, CCL, CCM, CDB, CDC, CDL, CDM	AEG	19A, 900V, 0.05A, 2V	F-21			
T12F900RCB, RCC, RCL, RCM, RDB, RDC, RDL, DDM	AEG	19A, 900V, 0.05A, 2V	F-56			



器件型号 Element type	厂名 Manufacturers	材料用途参数 Material Purpose Parameter	图号 Figure	国内外相似替换器件型号 Replacc of similar type	备注 Notes	外形参考图 Reference shape
T12F1000CCB, CCO, CCL, CCM, CDB, CDC, CDL, CDM	AEG	19A, 1kV, 0.05A, 2V	F-21			 图 F-21
T12F1000RCB, RCG, RCL, RCM, RDB, RDC, RDL, RDM	AEG	19A, 1kV, 0.05A, 2V	F-56			
T12F1200CDB, CDC, CDL, CDM	AEG	19A, 1.2kV, 0.05A, 2V	F-21			
T12F1200RDB, RDC, RDL, RDM	AEG	19A, 1.2kV, 0.05A, 2V	F-56			
T12F100...1200C...		SCR-H 12A, 0.1~1.2kV, 0.05A	F-55			
T12N100...1200C...		50Hz-Thy 12A, 0.1~1.2kV, 0.04A	F-55	2N5204...2N5207		
T12N100COB T12N100COC	AEG AEG	15A, 100V, 0.04A, 2V 15A, 100V, 0.04A, 2V	F-21 F-21	SK6642, SK5542 2N5204, 2N5205, 2N5206, 2N5207		 图 F-56
T12N200COB T12N200COC	AEG AEG	15A, 200V, 0.04A, 2V 15A, 200V, 0.04A, 2V	F-21 F-21	2N5204, 2N5205, 2N5206, 2N5207 2N5204, 2N5205, 2N5206, 2N5207		 图 F-55
T12N300COB T12N300COC	AEG AEG	15A, 300V, 0.04A, 2V 15A, 300V, 0.04A, 2V	F-21 F-21	2N5204, 2N5205, 2N5206, 2N5207 2N5204, 2N5205, 2N5206, 2N5207		
T12N400COB T12N400COC	AEG AEG	15A, 400V, 0.04A, 2V 15A, 400V, 0.04A, 2V	F-21 F-21	2N5204, 2N5205, 2N5206, 2N5207 2N5204, 2N5205, 2N5206, 2N5207		

器件型号 Element type	厂名 Manufacturers	材料用途参数 Material Purpose Parameter	图号 Figure	国内外相似替换器件型号 Replace of similar type	备注 Notes	外形参考图 Reference shaoc
T12N500COB	AEG	15A, 500V, 0.04A, 2V	F-21	2N5204, 2N5205, 2N5206, 2N5207		 图 F-21
T12N500COC	AEG	15A, 500V, 0.04A, 2V	F-21	2N5204, 2N5205, 2N5206, 2N5207		
T12N600COB	AEG	15A, 600V, 0.04A, 2V	F-21	2N5204, 2N5205, 2N5206, 2N5207		
T12N600COC	AEG	15A, 600V, 0.04A, 2V	F-21	2N5204, 2N5205, 2N5206, 2N5207		
T12N600COE	AEG	19A, 600V, 0.04A, 2V	F-21	2N5204, 2N5205, 2N5206, 2N5207		
T12N700COB	AEG	15A, 700V, 0.04A, 2V	F-21	2N5204, 2N5205, 2N5206, 2N5207		
T12N700COC	AEG	15A, 700V, 0.04A, 2V	F-21	2N5204, 2N5205, 2N5206, 2N5207		
T12N700COE	AEG	19A, 700V, 0.04A, 2V	F-21	2N5204, 2N5205, 2N5206, 2N5207		
T12N800COB	AEG	15A, 800V, 0.04A, 2V	F-21	2N5204, 2N5205, 2N5206, 2N5207		
T12N800COC	AEG	15A, 800V, 0.04A, 2V	F-21	2N5204, 2N5205, 2N5206, 2N5207		
T12N800COE	AEG	19A, 800V, 0.04A, 2V	F-21	2N5204, 2N5205, 2N5206, 2N5207		
T12N900COB	AEG	15A, 900V, 0.04A, 2V	F-21	2N5204, 2N5205, 2N5206, 2N5207		
T12N900COC	AEG	15A, 900V, 0.04A, 2V	F-21	2N5204, 2N5205, 2N5206, 2N5207		
T12N900COE	AEG	19A, 900V, 0.04A, 2V	F-21	2N5204, 2N5205, 2N5206, 2N5207		
T12N1000COB	AEG	15A, 1kV, 0.04A, 2V	F-21	2N5204, 2N5205, 2N5206, 2N5207		
T12N1000COC	AEG	15A, 1kV, 0.04A, 2V	F-21	2N5204, 2N5205, 2N5206, 2N5207		
T12N1000COE	AEG	19A, 1kV, 0.04A, 2V	F-21	2N5204, 2N5205, 2N5206, 2N5207		
T12N1100COB, COC, COE	AEG	19A, 1.1kV, 0.04A, 2V	F-21	2N5204, 2N5205, 2N5206, 2N5207		
T12N1200COB, COC, COE	AFG	19A, 1.2kV, 0.04A, 2V	F-21	2N5204, 2N5205, 2N5206, 2N5207		

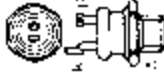
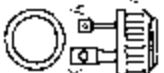



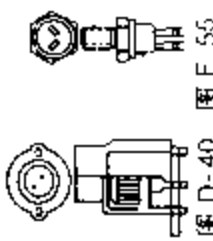
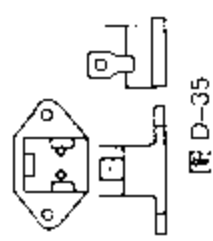
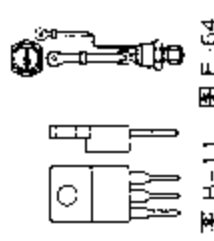
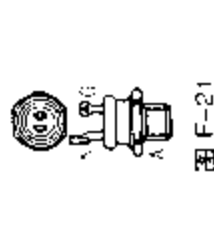

器件型号 Element type	厂名 Manufacturers	材料用途参数 Material Purpose Parameter	图号 Figure	国内外相似替换器型号 Replace of similar type	备注 Notes	外形参考图 Reference shape
T12.2N200COB, COE, COE	AEG	19A, 200V, 0.04A, 2V	F-21			
T12.2N200HOB, HOE	AEG	19A, 200V, 0.04A, 2V	C-85			
T12.2N200POB, POE, POE	AEG	19A, 200V, 0.04A, 2V	D-40			
T12.2N400COE, COE	AEG	19A, 400V, 0.04A, 2V	F-21			
T12.2N400HOB, HOC, HOE	AEG	19A, 400V, 0.04A, 2V	C-85			
T12.2N400POB, POE, POE	AEG	19A, 400V, 0.04A, 2V	D-40			
T12.2N600COE, COE	AEG	19A, 600V, 0.04A, 2V	F-21			
T12.2N600HOB, HOC	AEG	19A, 600V, 0.04A, 2V	C-85			
T12.2N700COB, COE, COE	AEG	19A, 700V, 0.04A, 2V	F-21			
T12.2N700HOB, HOC, HOE	AEG	19A, 700V, 0.04A, 2V	C-85			
T12.2N700POB, POE, POE	AEG	19A, 700V, 0.04A, 2V	D-40			
T12.2N800COB, COE, COE	AEG	19A, 800V, 0.04A, 2V	F-21			
T12.2N800HOB, HOC	AEG	19A, 800V, 0.04A, 2V	C-85			

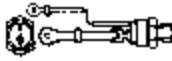
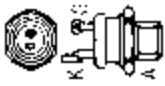

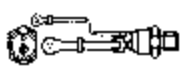
器件型号 Element type	厂名 Manufacturers	材料用途参数 Material Purpose Parameter	图号 Figure	国内外相似替换器型号 Replace of similar type	备注 Notes	外形参考图 Reference shape
T122N800POB, POC, POE	AEG	19A, 800V, 0.04A, 2V	D-40			 图 D-40 图 F-55
T14F100...900C...		SCR-H 14A, 100-900V, 0.05A	F-55			
T14F100...900E...		SCR-H =T14F/...C	D-35			
T14N100...900E...		50Hz-Thy =T14N/...F	B-11			
T14N400...800F...		50Hz-Thy 16A, 400-800V, 0.05A	B-11			
T15F200BCB, BCL, BCM, BEB, BEC, BEL, BEM, BFB, BFC, BFL, BFM	AEG	22.5A, 200V, 0.1A, 1.4V	F-64			 图 D-35
T15F200BCC	AEG	15A, 200V, 0.1A, 1.4V	F-21			
T15F200CCB, CCL, CCM, CEB, CEC, CEL, CEM, CFB, CFC, CFL, CFM	AEG	22.5A, 200V, 0.1A, 1.4V	F-21			 图 B-11 图 F-64
T15F200CCC	AEG	15A, 200V, 0.1A, 1.4V	F-21			
T15F400BCB, BCL, BCM, BEB, BEC, BEL, BEM, BFB, BFC, BFL, BFM	AEG	22.5A, 400V, 0.1A, 1.4V	F-61			
T15F400BCC	AEG	15A, 400V, 0.1A, 1.4V	F-21			 图 F-21
T15F400CCB, CCL, CCM, CEB, CEC, CEL, CEM, CFB, CFC, CFL, CFM	AEG	22.5A, 400V, 0.1A, 1.4V	F-21			
T15F400CCC	AEG	15A, 400V, 0.1A, 1.4V	F-21			

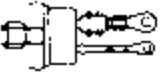



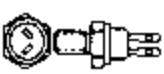

器件型号 Element type	厂名 Manufacturers	材料用途参数 Material Purpose Parameter	图号 Figure	国内外相似替换器件型号 Replace of similar type	备注 Notes	外形参考图 Reference shape
T15F600BCB, BCL, BCM, BEB, BEC, BEL, BEM, BFB, BFC, BFL, BFM	AEG	22.5A, 600V, 0.1A, 1.4V	F-64			 图 F-64
T15F600BCC	AEG	15A, 600V, 0.1A, 1.4V	F-21			
T15F600CCB, CCL, CCM, CEB, CEC, CEL, CEM, CFB, CFC, CFL, CFM	AEG	22.5A, 600V, 0.1A, 1.4V	F-21			 图 F-21
T15F600CCC	AEG	15A, 600V, 0.1A, 1.4V	F-21			
T15F800BCB, BCL, BCM, BEB, BEC, BEL, BEM, BFB, BFC, BFL, BFM	AEG	22.5A, 800V, 0.1A, 1.4V	F-64			
T15F800BCC	AEG	15A, 800V, 0.1A, 1.4V	F-21			
T15F800CCB, CCL, CCM, CEB, CEC, CEL, CEM, CFB, CFC, CFL, CFM	AEG	22.5A, 800V, 0.1A, 1.4V	F-21			
T15F800CCC	AEG	15A, 800V, 0.1A, 1.4V	F-21			
T15F900BFB, BFC, BFL, BFM	AEG	22.5A, 900V, 0.1A, 1.4V	F-64			
T15F900CFB, CFC, CFL, CFM	AEG	22.5A, 900V, 0.1A, 1.4V	F-21			
T15F1000BEC	AEG	15A, 1kV, 0.1A, 1.4V	F-21			
T15F1000CEC	AEG	15A, 1kV, 0.1A, 1.4V	F-21			

器件型号 Element type	厂名 Manufacturers	材料用途参数 Material Purpose Parameter	图号 Figure	国内外相似替换器件型号 Replace of similar type	备注 Notes	外形参考图 Reference shape
T15F1000BFB, BFC, BFL, BFM	AEG	22.5A, 1kV, 0.1A, 1.4V	F-64			 图 F-64
T15F1000CFB, CFC, CFL, CFM	AEG	22.5A, 1kV, 0.1A, 1.4V	F-21			 图 F-21
T15F1100BFB, BFC, BFL, BFM	AEG	22.5A, 1.1kV, 0.1A, 1.4V	F-64			
T15F1100CFB, CFC, CFL, CFM	AEG	22.5A, 1.1kV, 0.1A, 1.4V	F-21			
T15F1200BEC	AEG	15A, 1.2kV, 0.1A, 1.4V	F-21			
T15F1200CEC	AEG	15A, 1.2kV, 0.1A, 1.4V	F-21			
T15F1200BFB, BFC, BFL, BFM	AEG	22.5A, 1.2kV, 0.1A, 1.4V	F-64			
T15F1200CFB, CFC, CFL, CFM	AEG	22.5A, 1.2kV, 0.1A, 1.4V	F-21			
T15F200...1300B... T15F200...1300C...	SCR-H SCR-H	15A, 0.2~1.3kV, 0.1A =T15F/...B	E-7 F-55	BSIF04..., T20F...B BSIF04..., T20F...C		 图 E-7
T15.1N100COB, COC	AEG	19A, 1.2kV, 0.05A, 2V	F-21	SK6642, SK5542		 图 E-7
T15.1N200COB, COC	AEG	18A, 200V, 0.04A, 2V	F-21			
T15.1N300COB, COC	AEG	18A, 300V, 0.04A, 2V	F-21			
T15.1N400COB, COC	AEG	18A, 400V, 0.04A, 2V	F-21			

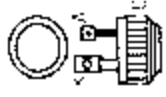
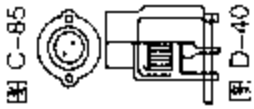
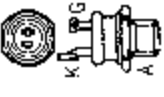

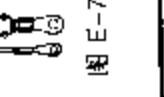
器件型号 Element type	厂名 Manufacturers	材料 Material	用途 Purpose	参数 Parameter	图号 Figure	国内外相似替换器件型号 Replace of similar type	备注 Notes	外形参考图 Reference shape
T15.1N500COB, COC	AEG			18A, 500V, 0.04A, 2V	F-21			 图 F-21
T15.1N600COB, COC	AEG			18A, 600V, 0.04A, 2V	F-21			
T15.1N600COE	AEG			19A, 600V, 0.05A, 2V	F-21			
T15.1N700COB, COC	AEG			18A, 700V, 0.04A, 2V	F-21			
T15.1N700COE	AEG			19A, 700V, 0.05A, 2V	F-21			
T15.1N800COB, COC	AEG			18A, 800V, 0.04A, 2V	F-21			
T15.1N900COB, COC	AEG			18A, 900V, 0.04A, 2V	F-21			 图 F-55
T15.1N900COE	AEG			19A, 900V, 0.05A, 2V	F-21			
T15.1N1000COC	AEG			18A, 1KV, 0.04A, 2V	F-21			
T15.1N1000COE	AEG			19A, 1KV, 0.05A, 2V	F-21			
T15.1N1100COB, COC, COE	AEG			19A, 1.1KV, 0.05A, 2V	F-21			 图 C-85
T15.1N/100 ...1200C...			50Hz-Try	15A, 0.1~1.2kV, 0.05A	F-55	BTW92...H, TAG16N..., T17N...		
T15.2N200COB, COC, COE	AEG			19A, 200V, 0.05A, 2V	F-21			
T15.2N200HOB, HOC, HOE	AEG			19A, 200V, 0.05A, 2V	C-85			
T15.2N200POB, POC, POE	AEG			19A, 200V, 0.05A, 2V	D-40			 图 D-40

器件型号 Element type	厂名 Manufacturers	材料用途参数 Material Purpose Parameter	图号 Figure	国内外相似替换器件型号 Replace of similar type	备注 Notes	外形参考图 Reference shape
T15.2N400 HOB, HOC, HOE	AEG	19A, 400V, 0.05A, 2V	C-85			
T15.2N400 POB, POC, POE	AEG	19A, 400V, 0.05A, 2V	D-40			
T15.2N600 COB, COC, COE	AEG	19A, 600V, 0.05A, 2V	F-21			
T15.2N600 HOB, HOC, HOE	AEG	19A, 600V, 0.05A, 2V	C-85			
T15.2N600 POB, POC, POE	AEG	19A, 600V, 0.05A, 2V	D-40			
T15.2N700 COB, COC, COE	AEG	19A, 700V, 0.05A, 2V	F-21			
T15.2N700 HOB, HOC, HOE	AEG	19A, 700V, 0.05A, 2V	C-85			
T15.2N700 POB, POC, POE	AEG	19A, 700V, 0.05A, 2V	D-40			
T15.2N800 COB, COC, COE	AEG	19A, 800V, 0.05A, 2V	F-21			
T15.2N800 HOB, HOC, HOF	AEG	19A, 800V, 0.05A, 2V	C-85			
T15.2N800 POB, POC, POE	AEG	19A, 800V, 0.05A, 2V	D-40			
T15N/200...1300C... T15N/200...1300E...		50Hz-Thy 15A, 0.2-1.3kV, 0.1A 50Hz-Thy =T15N...C	F-55 E-7	BTV24/..., T16N...C, T25N...C T16N...B, T25N...B		



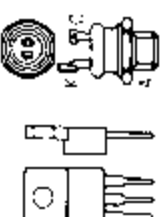
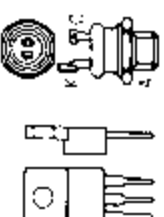
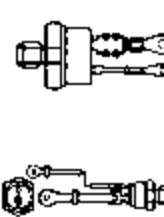
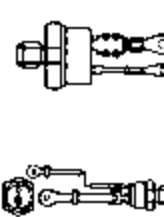
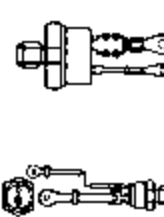
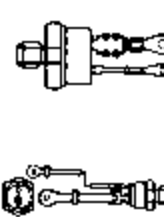
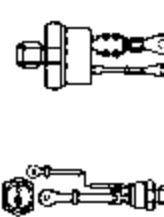
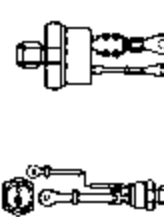
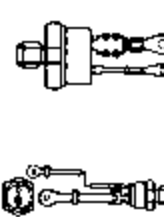
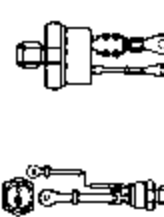
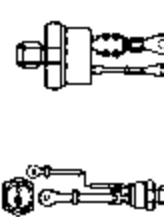
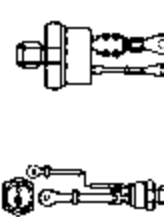
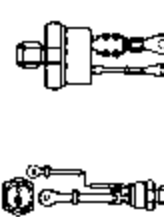
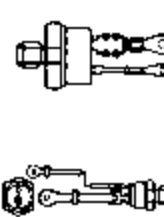
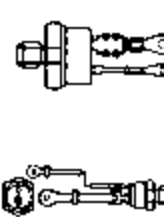
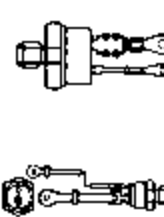
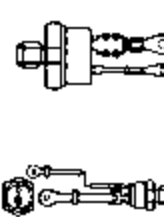
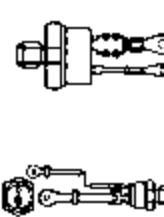
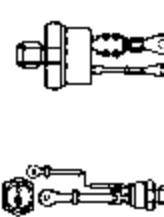
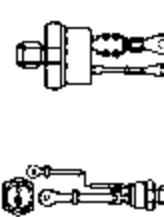
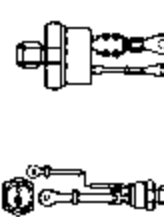
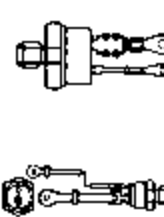
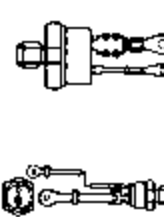
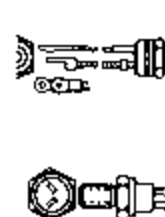
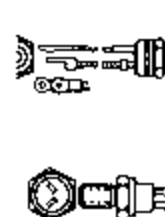
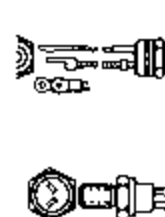
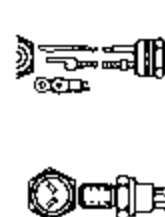
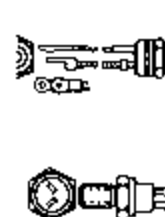

器件型号 Element type	厂名 Manufacturers	材料用途参数 Material Purpose Parameter	图号 Figure	国内外相似替换器件型号 Replace of similar type	备注 Notes	外形参考图 Reference shape
T16ACI		Triac =T16ACP	B-11			
T16ACP		Triac 16A, 600V, 0.05A	B-11	BT139-600, MAC15A-6, TAG280-600, TAG281-600		
T16N400BOC	AEG	16A, 400V, 0.12A, 1.4V	F-21			
T16N400BOF	AEG	22.5A, 400V, 0.12A, 1.4V	F-64			
T16N600BOC	AEG	16A, 600V, 0.12A, 1.4V	F-21			
T16N600BOF	AEG	22.5A, 600V, 0.12A, 1.4V	F-64			
T16N800COC	AEG	16A, 800V, 0.12A, 1.4V	F-21			
T16N1000BOC	AEG	16A, 1KV, 0.12A, 1.4V	F-21			
T16N1000COF	AEG	16A, 1KV, 0.12A, 1.4V	F-21			
T16N1000BOC	AEG	22.5A, 1KV, 0.12A, 1.4V	F-64			
T16N1100BOC	AEG	22.5A, 1.1KV, 0.12A, 1.4V	F-64			
T16N1100BOF	AEG	22.5A, 1.1KV, 0.12A, 1.4V	F-64			
T16N1100COF	AEG	22.5A, 1.1KV, 0.12A, 1.4V	F-21			
T16N1100COC	AEG	22.5A, 1.1KV, 0.12A, 1.4V	F-21			
T16N1200BOC	AEG	16A, 1.2KV, 0.12A, 1.4V	F-21			
T16N1200COF	AEG	16A, 1.2KV, 0.12A, 1.4V	F-21			
T16N1200COC	AEG	16A, 1.2KV, 0.12A, 1.4V	F-21			
T16N1200BOF	AEG	22.5A, 1.2KV, 0.12A, 1.4V	F-64			
T16N1400BOC	AEG	16A, 1.4KV, 0.12A, 1.4V	F-21			
T16N1400COF	AEG	16A, 1.4KV, 0.12A, 1.4V	F-21			
T16N1600BOC	AEG	16A, 1.6KV, 0.12A, 1.4V	F-21			
T16N1600COF	AEG	16A, 1.6KV, 0.12A, 1.4V	F-21			
T16N1600COC	AEG	16A, 1.6KV, 0.12A, 1.4V	F-21			
T16N400...1600B...		50Hz-Thy 16A, 0.4~1.6KV, 0.12A	E-7	T25N...B		
T16N400...1600C...		50Hz-Thy =T16N...B	F-55	T25N...C		
T17F200B	AEG	SCR-H 22.5A, 200V, 0.06A, 2.7V, 0.15A	F-63	T24F200B		
T17F200C	AEG	SCR-H 22.5A, 200V, 0.06A, 2.7V, 0.15A	F-21	T24F200C		
T17F400B	AEG	SCR-H 22.5A, 400V, 0.06A, 2.7V, 0.15A	F-63	T24F400B		



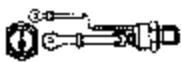
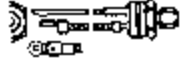
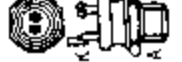

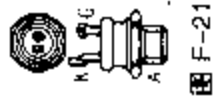
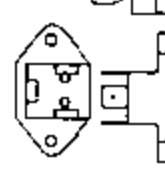
器件型号 Element type	厂名 Manufacturers	材料用途参数 Material Purpose Parameter	图号 Figure	国内外相似替换器件型号 Replace of similar type	备注 Notes	外形参考图 Reference shape
T17F400C	AEG	SCR-H 22.5A, 400V, 0.08A, 2.7V, 0.15A	F-21	T24F400C		
T17F600B	AEG	SCR-H 22.5A, 600V, 0.08A, 2.7V, 0.15A	F-63	T24F600B		
T17F600C	AEG	SCR-H 22.5A, 600V, 0.08A, 2.7V, 0.15A	F-21	T24F600C		
T17F800B	AEG	SCR-H 22.5A, 800V, 0.08A, 2.7V, 0.15A	F-63	T24F800B		
T17F800C	AEG	SCR-H 22.5A, 800V, 0.08A, 2.7V, 0.15A	F-21	T24F800C		
T17F900B	AEG	SCR-H 22.5A, 900V, 0.08A, 2.7V, 0.15A	F-63	T24F900B		
T17F900C	AEG	SCR-H 22.5A, 900V, 0.08A, 2.7V, 0.15A	F-21	T24F900C		
T17F1000B	AEG	SCR-H 22.5A, 1kV, 0.08A, 2.7V, 0.15A	F-63	T24F1000B		
T17F1000C	AEG	SCR-H 22.5A, 1kV, 0.08A, 2.7V, 0.15A	F-21	T24F1000C		
T17F1100B	AEG	SCR-H 22.5A, 1.1kV, 0.08A, 1.4V, 0.15A	F-63	T24F1100B		
T17F1100C	AEG	SCR-H 22.5A, 1.1kV, 0.08A, 1.4V, 0.15A	F-21	T24F1100C		
T17F1200B	AEG	SCR-H 22.5A, 1.2kV, 0.08A, 2.7V, 0.15A	F-63	T24F1200B		
T17F1200C	AEG	SCR-H 22.5A, 1.2kV, 0.08A, 2.7V, 0.15A	F-21	T24F1200C		
T17N200...1400B...		50Hz-Thy 17A, 0.2-1.4kV, 0.08A	E-7	CS23..., TAG24N..., T24N...B		
T17N200...1400C...		50Hz-Thy =T17N...B	F-55	CS23..., TAG24N..., T24N...C		
T17N200BOB, BOC, BOE	AEG	35A, 200V, 0.08A, 2.7V	F-64			
T17N200BOF	AEG	35A, 200V, 0.08A, 2.7V	F-63			
T17N200COB, COC, COE, COF	AEG	35A, 200V, 0.08A, 2.7V	F-21			
T17N400BOB, BOC, BOE	AEG	35A, 400V, 0.08A, 2.7V	F-64			
T17N400BOF	AEG	35A, 400V, 0.08A, 2.7V	F-63			
T17N400COB, COC, COE, COF	AEG	35A, 400V, 0.08A, 2.7V	F-21			
T17N600BOB	AEG	35A, 600V, 0.08A, 2.7V	F-64			

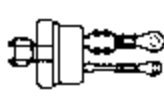
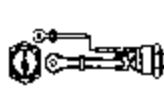



器件型号 Element type	厂名 Manufacturers	材料用途参数 Material Purpose Parameter	图号 Figure	国内外相似替换器件型号 Replace of similar type	备注 Notes	外形参考图 Reference shape
T17N600BOC	AEG	35A, 600V, 0.08A, 2.7V	F-64			 图 F-64
T17N600BOF	AEG	35A, 600V, 0.08A, 2.7V	F-63			
T17N600COB, COC, COE, COF	AEG	35A, 600V, 0.08A, 2.7V	F-21			
T17N800BOB, BOC, BOE	AEG	35A, 800V, 0.08A, 2.7V	F-64			
T17N800BOF	AEG	35A, 800V, 0.08A, 2.7V	F-63			
T17N900BOB, BOC, BOE, BOF	AEG	35A, 900V, 0.08A, 2.7V	F-64			 图 F-63
T17N900COB, COC, COE, COF	AEG	35A, 900V, 0.08A, 2.7V	F-21			
T17N1000BOB, BOC, BOE	AEG	35A, 1kV, 0.08A, 2.7V	F-64			
T17N1000BOF	AEG	35A, 1kV, 0.08A, 2.7V	F-63			
T17N1000COB, COC, COE, COF	AEG	35A, 1kV, 0.08A, 2.7V	F-21			
T17N1100BOB, BOC, BOE, BOF	AEG	35A, 1.1kV, 0.08A, 2.7V	F-64			 图 F-21
T17N1100COB, COC, COE, COF	AEG	35A, 1.2kV, 0.08A, 2.7V	F-64			
T17N1200BOB, BOC, BOE	AEG	35A, 1.2kV, 0.08A, 2.7V	F-63			
T17N1200BOF	AEG	35A, 1.2kV, 0.08A, 2.7V	F-21			
T17N1200COB, COC, COE, COF	AEG	35A, 1.2kV, 0.08A, 2.7V	F-21			
T17N1400BOB, BOC, BOE, BOF	AEG	35A, 1.4kV, 0.08A, 2.7V	F-64			

器件型号 Element type	厂名 Manufacturers	材料用途参数 Material Purpose Parameter	图号 Figure	国内外相似替换器件型号 Replace of similar type	备注 Notes	外形参考图 Reference shape
T17N1400COB, COE, COE, COF	AEG	35A, 1.4kV, 0.08A, 2.7V	F-21			
T18F/100...900C...		SCR-H 18A, 100~900V, 0.05A	F-55			
T18F/100...900E...		SCR-H =T18F/...C	D-35			
T18N/100...900E...		50Hz-Thy 18A, 100~900V, 0.05A	D-35			
T20F/200...1200B...		SCR-H 20A, 0.2~1.2kV, 0.1A, <12μs	E-7			
T20F/200...1200C...		SCR-H =T20F/...B	F-55			
T20F200BCB, BCL, BCM, BEB, BEC, BEL, BEM, BFB, BFC, BFL, BFM	AEG	25.5A, 200V, 0.1A, 1.4V	F-64			
T20F200BCC	AEG	20A, 200V, 0.1A, 1.4V	F-21			
T20F200CCC	AEG	20A, 200V, 0.1A, 1.4V	F-21			
T20F200CCL, CCM, CEB, CEC, CEL, CEM, CFB, CFC, CFL, CFM	AEG	25.5A, 200V, 0.1A, 1.4V	F-21			
T20F400BCB, BCL, BCM, BEB, BEC, BEL, BEM, BFB, BFC, BFL, BFM	AEG	25.5A, 400V, 0.1A, 1.4V	F-64			
T20F400BCC	AEG	20A, 400V, 0.1A, 1.4V	F-21			
T20F400CCC	AEG	20A, 400V, 0.1A, 1.4V	F-21			

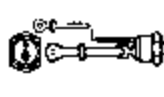
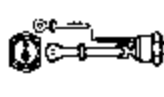
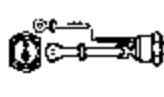
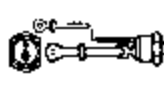
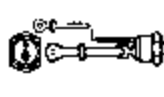
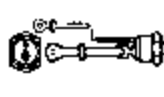

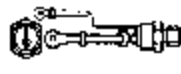
器件型号 Element type	厂名 Manufacturers	材料用途参数 Material Purpose Parameter	图号 Figure	国内外相似替换器件型号 Replace of similar type	备注 Notes	外形参考图 Reference shape
T20F400CCB, CCL, CCM, CEB, CEC, CEL, CEM, CFB, CFC, CFL, CFM	AEG	25.5A, 400V, 0.1A, 1.4V	F-21			
T20F600CB, BCL, BCM, BEB, BEC, BFL, BEM, BFB, BFC, BFL, BFM	AEG	25.5A, 600V, 0.1A, 1.4V	F-64			
T20F600BCC	AEG	20A, 600V, 0.1A, 1.4V	F-21			
T20F600CCC	AEG	20A, 600V, 0.1A, 1.4V	F-21			
T20F800CCB, CCL, CCM, CEB, CEC, CEL, CEM, CFB, CFC, CFL, CFM	AEG	25.5A, 600V, 0.1A, 1.4V	F-21			
T20F800CB, BCL, BCM, BEB, BEC, BEL, BFM, BFB, BFC, BFL, BFM	AEG	25.5A, 800V, 0.1A, 1.4V	F-64			
T20F800BCC	AEG	20A, 800V, 0.1A, 1.4V	F-21			
T20F800CCC	AEG	20A, 800V, 0.1A, 1.4V	F-21			
T20F800CCB, CCL, CCM, CEB, CEC, CEL, CEM, CFB, CFC, CFL, CFM	AEG	25.5A, 800V, 0.1A, 1.4V	F-21			
T20F900B	AEG	25.5A, 900V, 0.1A, 1.4V	F-64			
T20F900C	AEG	25.5A, 900V, 0.1A, 1.4V	F-21			

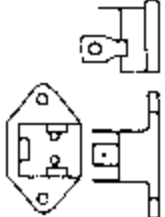
器件型号 Element type	厂名 Manufacturers	材料用途参数 Material Purpose Parameter	图号 Figure	国内外相似替换器件型号 Replace of similar type	备注 Notes	外形参考图 Reference shape
T20F1000BCB, BCC, BCL, BOM, BEB, BEL, BEM, BFB, BFC, BFL, BFM	AEG	25.5A, 1kV, 0.1A, 1.4V	F-64			 图 F-64
T20F1000BEC	AEG	20A, 1kV, 0.1A, 1.4V	F-21			
T20F1000CEC	AEG	20A, 1kV, 0.1A, 1.4V	F-21			
T20F1000CCB, OCC, CCL, CCM, CEB, CEL, CEM, CFB, CFC, CFM	AEG	25.5A, 1kV, 0.1A, 1.4V	F-21			 图 F-21
T20F1100B	AEG	25.5A, 1.1kV, 0.1A, 1.4V	F-64			
T20F1100C	AEG	25.5A, 1.1kV, 0.1A, 1.4V	F-21			
T20F1200BCB, BCC, BCL, BCM, BEB, BEL, BEM, BFB, BFC, BFL, BFM	AEG	25.5A, 1.2kV, 0.1A, 1.4V	F-64			 图 F-55
T20F1200BEC	AEG	20.0A, 1.2kV, 0.1A, 1.4V	F-21			
T20F1200CEC	AEG	20.0A, 1.2kV, 0.1A, 1.4V	F-21			
T20F1200CCB, OCC, CCL, COM, CEB, CEL, CEM, CFB, CFC, CFL, CFM	AEG	25.5A, 1.2kV, 0.1A, 1.4V	F-21			 图 D-35
T22N400...1300C...		50Hz-Thy 22A, 0.4-1.3kV, 0.1A	F-55	BT24/..., T25N...C		
T22N400...1300E...		50Hz-Thy =T22N/...C	D-35			

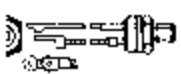
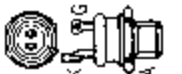

器件型号 Element type	厂名 Manufacturers	材料用途参数 Material Purpose Parameter	图号 Figure	国内外相似替换器件型号 Replacc of similar type	备注 Notes	外形参考图 Reference shape	
T24F200D	AEG	SCR-H 25.5A, 200V, 0.08A, 2.7V	F-63			 图 F-63	
T24F200C	AEG	SCR-H 25.5A, 200V, 0.08A, 2.7V	F-21				
T24F400B	AEG	SCR-H 25.5A, 400V, 0.08A, 2.7V	F-63				
T24F400C	AEG	SCR-H 25.5A, 400V, 0.08A, 2.7V	F-21				
T24F600B	AEG	SCR-H 25.5A, 600V, 0.08A, 2.7V	F-63				
T24F600C	AEG	SCR-H 25.5A, 600V, 0.08A, 2.7V	F-21				
T24F800B	AEG	SCR-H 25.5A, 800V, 0.08A, 2.7V	F-63				
T24F800C	AEG	SCR-H 25.5A, 800V, 0.08A, 2.7V	F-21				
T24F900B	AEG	SCR-H 25.5A, 900V, 0.08A, 2.7V	F-63				
T24F900C	AEG	SCR-H 25.5A, 900V, 0.08A, 2.7V	F-21				
T24F1000B	AEG	SCR-H 25.5A, 1kV, 0.08A, 2.7V	F-63				
T24F1000C	AEG	SCR-H 25.5A, 1kV, 0.08A, 2.7V	F-21				
T24F1100B	AEG	SCR-H 25.5A, 1.1kV, 0.08A, 2.7V	F-63				
T24F1200B	AEG	SCR-H 25.5A, 1.2kV, 0.08A, 2.7V	F-63				
T24N100BOF	AEG	SCR-H 25.5A, 1.1kV, 0.08A, 2.7V	F-64				 图 F-21
T24N100COB	AEG	SCR-H 25.5A, 1.1kV, 0.08A, 2.7V	F-21				
T24N200BOB, BOC, BOE	AEG	SCR-H 25.5A, 200V, 0.08A, 2.7V	F-64				
T24N200BOF	AEG	SCR-H 40A, 200V, 0.08A, 2.7V	F-63				
T24N200COB, COC, COE	AEG	SCR-H 25.5A, 200V, 0.08A, 2.7V	F-21				
T24N200COF	AEG	SCR-H 40A, 200V, 0.08A, 2.7V	F-21				
T24N400BOB, BOC, BOE	AEG	SCR-H 25.5A, 400V, 0.08A, 2.7V	F-64				
T24N400BOF	AEG	SCR-H 40A, 400V, 0.08A, 2.7V	F-63				







图 F-64

器件型号 Element type	厂名 Manufacturers	材料用途参数 Material Purpose Parameter	图号 Figure	国内外相似替换器件型号 Replace of similar type	备注 Notes	外形参考图 Reference shape
T24N400COB, COE COE	AEG	SCR-H 25.5A, 400V, 0.08A, 2.7V	F-21			 图 F-21
T24N400COF	AEG	SCR-H 40A, 400V, 0.08A, 2.7V	F-21			
T24N600BOB, BOC, BOE	AEG	SCR-H 25.5A, 600V, 0.08A, 2.7V	F-64			
T24N600BOF	AEG	SCR-H 40A, 600V, 0.08A, 2.7V	F-63			
T24N600COB, COC, COE	AEG	SCR-H 25.5A, 600V, 0.08A, 2.7V	F-21			
T24N600COF	AEG	SCR-H 40A, 600V, 0.08A, 2.7V	F-21			
T24N800BOB, BOC, BOE	AEG	SCR H 25.5A, 800V, 0.08A, 2.7V	F-64			
T24N800COB, COE, COF	AEG	SCR-H 25.5A, 800V, 0.08A, 2.7V	F-21			 图 F-64
T24N800COF	AEG	SCR-H 40A, 800V, 0.08A, 2.7V	F-21			
T24N900BOB, BOC, BOE	AEG	SCR-H 25.5A, 900V, 0.08A, 2.7V	F-64			
T24N900BOF	AEG	SCR-H 40A, 900V, 0.08A, 2.7V	F-64			
T24N900COB, COE, COF	AEG	SCR-H 25.5A, 900V, 0.08A, 2.7V	F-21			 图 F-63
T24N1000BOB, BOC, BOE	AEG	SCR-H 25.5A, 1kV, 0.08A, 2.7V	F-64			
T24N1000BOF	AEG	SCR-H 40A, 1kV, 0.08A, 2.7V	F-63			
T24N1000COB, COC, COE	AEG	SCR-H 25.5A, 1kV, 0.08A, 2.7V	F-21			
T24N1000COF	AEG	SCR-H 40A, 1kV, 0.08A, 2.7V	F-21			
T24N1100BOB, BOC, BOE	AEG	SCR-H 25.5A, 1.1kV, 0.08A, 2.7V	F-64			

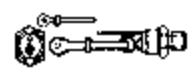

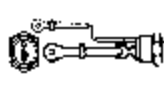

器件型号 Element type	厂名 Manufacturers	材料用途参数 Material Purpose Parameter	图号 Figure	国内外相似替换器件型号 Replace of similar type	备注 Notes	外形参考图 Reference shape
T24N1100COC, COE, COF	AEG	SCR-H 25.5A, 1.1kV, 0.08A, 2.7V	F-64			 图 F-64
T24N1200BOB, BOC, BOE	AEG	SCR-H 25.5A, 1.2kV, 0.08A, 2.7V	F-64			
T24N1200BOF	AEG	SCR-H 40A, 1.2kV, 0.08A, 2.7V	F-63			
T24N1200COR, COC, COE	AEG	SCR-H 25.5A, 1.2kV, 0.08A, 2.7V	F-21			
T24N1200COF	AEG	SCR-H 40A, 1.2kV, 0.08A, 2.7V	F-21			
T24N1400BOB, BOC, BOE, BOF	AEG	SCR-H 25.5A, 1.4kV, 0.08A, 2.7V	F-64			
T24N1400COB, COC, COE, COF	AEG	SCR-H 25.5A, 1.4kV, 0.08A, 2.7V	F-21			
T25N400BOC	AEG	50Hz-Thy 25A, 400V, 0.12A, 1.4V	F-64			
T25N400COC	AEG	50Hz-Thy 25A, 400V, 0.12A, 1.4V	F-64			
T25N400COF	AEG	50Hz-Thy 32A, 400V, 0.12A, 1.4V	F-21			
T25N600BOC	AEG	50Hz-Thy 25A, 600V, 0.12A, 1.4V	F-64			
T25N600COC	AEG	50Hz-Thy 25A, 600V, 0.12A, 1.4V	F-64			
T25N600COF	AEG	50Hz-Thy 32A, 600V, 0.12A, 1.4V	F-21			
T25N800BOC	AEG	50Hz-Thy 25A, 800V, 0.12A, 1.4V	F-64			
T25N800COC	AEG	50Hz-Thy 25A, 800V, 0.12A, 1.4V	F-64			
T25N800COF	AEG	50Hz-Thy 32A, 800V, 0.12A, 1.4V	F-21			
T25N1000BOC	AEG	50Hz-Thy 25A, 1kV, 0.12A, 1.4V	F-21			
T25N1000COC	AEG	50Hz-Thy 25A, 1kV, 0.12A, 1.4V	F-64			
T25N1000COF	AEG	50Hz-Thy 32A, 1kV, 0.12A, 1.4V	F-64			
T25N1100BOC	AEG	50Hz-Thy 32A, 1.1kV, 0.12A, 1.4V	F-64			



图 F-21

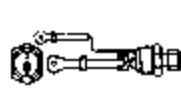
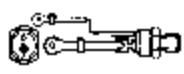

器件型号 Element type	厂名 Manufacturers	材料用途参数 Material Purpose Parameter	图号 Figure	国内外相似替换器件型号 Replace of similar type	备注 Notes	外形参考图 Reference shape
T25N1100BOF	AEG	50Hz-Thy 32A, 1.1kV, 0.12A, 1.4V	F-64			 图 F-64
T25N1100COC	AEG	50Hz-Thy 32A, 1.1kV, 0.12A, 1.4V	F-21			
T25N1100COF	AEG	50Hz-Thy 32A, 1.1kV, 0.12A, 1.4V	F-21			
T25N1200BOC	AEG	50Hz-Thy 25A, 1.2kV, 0.12A, 1.4V	F-64			 图 F-21
T25N1200COC	AEG	50Hz-Thy 25A, 1.2kV, 0.12A, 1.4V	F-64			
T25N1200COF	AEG	50Hz-Thy 32A, 1.2kV, 0.12A, 1.4V	F-21			
T25N1400BOC	AEG	50Hz-Thy 25A, 1.4kV, 0.12A, 1.4V	F-64			 图 F-55
T25N1400COC	AEG	50Hz-Thy 25A, 1.4kV, 0.12A, 1.4V	F-64			
T25N1400COF	AEG	50Hz-Thy 32A, 1.4kV, 0.12A, 1.4V	F-21			
T25N1600BOC	AEG	50Hz-Thy 25A, 1.6kV, 0.12A, 1.4V	F-64			 图 D-35
T25N1600COC	AEG	50Hz-Thy 25A, 1.6kV, 0.12A, 1.4V	F-64			
T25N1600COF	AEG	50Hz-Thy 32A, 1.6kV, 0.12A, 1.4V	F-21			
T30F100...900C...		SCR-H 30A, 100-900V, 0.1A, <15μs	F-55			
T30F100...900E...		SCR-H =T30F/B	D-35			
T31F200BDB, BDC, BDL, BDM, BEB, BEL, BEM, BGB, BGC, BGL, BGM	AEG	38A, 200V, 0.15A, 1.4V	F-64			
T31F200BEC	AEG	31A, 200V, 0.15A, 1.4V	F-64			
T31F400BDB, BDC, BDL, BDM, BEB, BEL, BEM, BGB, BGC, BGL, BGM	AEG	38A, 400V, 0.15A, 1.4V	F-64			

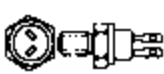
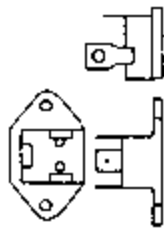
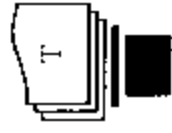

器件型号 Element type	厂名 Manufacturers	材料 Material	用途 Purpose	参数 Parameter	图号 Figure	国内外相似替换器件型号 Replace of similar type	备注 Notes	外形参考图 Reference shape
T31F400BEC	AEG	31A,	400V,	0.15A, 1.4V	F-64			
T31F600BDB, BDC, BDL, BDM, BEB, BEL, BEM, BGB, BGC, BGL, BGM	AEG	38A,	600V,	0.15A, 1.4V	F-64			
T31F600BEC	AEG	31A,	600V,	0.15A, 1.4V	F-64			
T31F800BDB, BDC, BDL, BDM	AEG	38A,	800V,	0.15A, 1.4V	F-64			
T31F900BFB, BFL, BFM, BGB, BGC, BGL, BGM	AEG	38A,	900V,	0.15A, 1.4V	F-64			
T31F1000BFB, BFL, BFM, BGB, BGC, BGL, BGM	AEG	38A,	1kV,	0.15A, 1.4V	F-64			
T31F1000BFC	AEG	31A,	1kV,	0.15A, 1.4V	F-64			
T31F1100BFB, BFL, BFM, BGB, BCC, BGL, BGM	AEG	38A,	1.1kV,	0.15A, 1.4V	F-64			
T31F1200BFB, BGB, BGC, BGL, BGM	AEG	38A,	1.2kV,	0.15A, 1.4V	F-64			
T31F1200BFC, BFL, BFM	AEG	31A,	1.2kV,	0.15A, 1.4V	F-64			
T31F1300BFB, BFL, BFM, BGB, BGC, BGL, BGM	AEG	38A,	1.3kV,	0.15A, 1.4V	F-64			

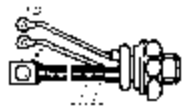
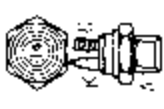

图 F-64

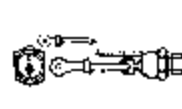
器件型号 Element type	厂名 Manufacturers	材料用途参数 Material Purpose Parameter	图号 Figure	国内外相似替换器件型号 Replace of similar type	备注 Notes	外形参考图 Reference shape
T31F1300BFC	AEG	45A, 1.3kV, 0.15A, 1.4V	E-30			 图 E-30
T32F200	AEG	38A, 200V, 0.12A, 2.9V	F-23			
T32F400	AEG	38A, 400V, 0.12A, 2.9V	F-23			
T32F600	AEG	38A, 600V, 0.12A, 2.9V	F-23			
T32F800	AEG	38A, 800V, 0.12A, 2.9V	F-23			
T32N200C	AEG	38A, 200V, 0.12A, 2.9V	F-21			
T32N400C	AEG	38A, 400V, 0.12A, 2.9V	F-21			
T32N600C	AEG	38A, 600V, 0.12A, 2.9V	F-21			 图 F-21
T32N800C	AEG	38A, 800V, 0.12A, 2.9V	F-21			
T35N1000BOC	AEG	35A, 1kV, 0.12A, 1.4V	F-64			
T35N1000BOF	AEG	51A, 1kV, 0.12A, 1.4V	F-64			
T35N1100BOC	AEG	51A, 1.1kV, 0.12A, 1.4V	F-21			
T35N1100BOF	AEG	51A, 1.1kV, 0.12A, 1.4V	F-64			 图 F-21
T35N1200BOC	AEG	35A, 1.2kV, 0.12A, 1.4V	F-64			
T35N1200BOF	AEG	51A, 1.2kV, 0.12A, 1.4V	F-64			
T35N1400BOC	AEG	51A, 1.4kV, 0.12A, 1.4V	F-64			
T35N1400BOF	AEG	51A, 1.4kV, 0.12A, 1.4V	F-64			
T35N1600BOC	AEG	35A, 1.6kV, 0.12A, 1.4V	E-30			
T35N1600BOF	AEG	51A, 1.6kV, 0.12A, 1.4V	F-64			
T35N1800BOC	AEG	35A, 1.8kV, 0.12A, 1.4V	E-30			
T35N1800BOF	AEG	51A, 1.8kV, 0.12A, 1.4V	F-64			 图 E-30
T40F200	AEG	41.5A, 200V, 0.12A, 2.9V	F-23			
T40F400	AEG	41.5A, 400V, 0.12A, 2.9V	F-23			
T40F600	AEG	41.5A, 600V, 0.12A, 2.9V	F-23			
T40F800	AEG	41.5A, 800V, 0.12A, 2.9V	F-23			



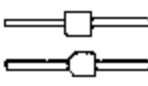
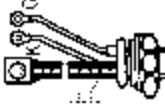
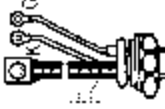

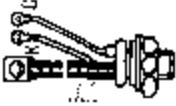
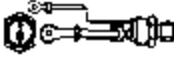
器件型号 Element type	厂名 Manufacturers	材料用途参数 Material Purpose Parameter	图号 Figure	国内外相似替换器件型号 Replace of similar type	备注 Notes	外形参考图 Reference shape
T40N200	AEG	41.5A, 200V, 0.12A, 2.9V	F-21			 图 F-21
T40N400	AEG	41.5A, 400V, 0.12A, 2.9V	F-21			
T40N600	AEG	41.5A, 600V, 0.12A, 2.9V	F-21			
T40N800	AEG	41.5A, 800V, 0.12A, 2.9V	F-21			
T40R06220200, 300, 400	WES	FLD 35A, 600V, 650V, 40V	A-7			 图 A-7
T40R08220200, 300, 400	WES	FLD 35A, 800V, 850V, 40V	A-7			
T40R10220200, 300, 400	WES	FLD 35A, 1kV, 1kV, 40V	A-7			
T45F200BD, BG, BEB, BEL, BEM	WES	50A, 200V, 0.15A, 1.4V	E-30			
T45F200BEC	WES	45A, 200V, 0.15A, 1.4V	E-30			 图 E-30
T45F400RD, RG, BEB, BEL, BEM	WES	50A, 400V, 0.15A, 1.4V	E-30			
T45F400BEC	WES	45A, 400V, 0.15A, 1.4V	E-30			
T45F600BD	WES	50A, 600V, 0.15A, 1.4V	E-30			
T45F600BG	WES	50A, 600V, 0.15A, 1.4V	E-30			 图 E-30
T45F800BD, BG, BEB, BEL, BEM	AEG	50A, 800V, 0.15A, 1.4V	E-30			
T45F800BEC	AEG	45A, 800V, 0.15A, 1.4V	E-30			
T45F900BF	AEG	50A, 900V, 0.15A, 1.4V	E-30			
T45F900RG	AEG	50A, 900V, 0.15A, 1.4V	E-30			

器件型号 Element type	厂名 Manufacturers	材料用途参数 Material Purpose Parameter	图号 Figure	国内外相似替换器件型号 Replace of similar type	备注 Notes	外形参考图 Reference shape
T45F1000BFB, BFL, BFM	AEG	50A, 1kV, 0.15A, 1.4V	E-30			 图 E-30
T45F1000BFC	AEG	45A, 1kV, 0.15A, 1.4V	E-30			
T45F1100BF	AEG	50A, 1.1kV, 0.15A, 1.4V	E-30			 图 F-64
T45F1100BG	AEG	50A, 1.1kV, 0.15A, 1.4V	E-30			
T45F1200BFB, BFL, BFM	AEG	50A, 1.2kV, 0.15A, 1.4V	E-30			
T45F1200BFC	AEG	45A, 1.2kV, 0.15A, 1.4V	E-30			
T45F1200BG	AEG	50A, 1.2kV, 0.15A, 1.4V	E-30			
T45F1300BFB, BFL, BFM, BGB, BGC, BGL, BGM	AEG	50A, 1.3kV, 0.15A, 1.4V	E-30			
T45N400BOC	AEG	51A, 400V, 0.12A, 1.4V	F-64			
T45N400BOF	AEG	51A, 400V, 0.12A, 1.4V	F-64			
T45N600BOC	AEG	51A, 600V, 0.12A, 1.4V	F-64			
T45N600BOF	AEG	51A, 600V, 0.12A, 1.4V	F-64			
T45N800BOC	AEG	51A, 800V, 0.12A, 1.4V	F-64			
T45N800BOF	AEG	51A, 800V, 0.12A, 1.4V	F-64			
T45N1000BOC	AEG	51A, 1kV, 0.12A, 1.4V	F-64			
T45N1000BOF	AEG	51A, 1kV, 0.12A, 1.4V	F-64			
T45N1100BOC	AEG	51A, 1.1kV, 0.12A, 1.4V	F-64			
T45N1100BOF	AEG	51A, 1.1kV, 0.12A, 1.4V	F-64			
T45N1200BOC	AEG	51A, 1.2kV, 0.12A, 1.4V	F-64			
T45N1200BOF	AEG	51A, 1.2kV, 0.12A, 1.4V	F-64			
T45N1400BOF	AEG	51A, 1.4kV, 0.12A, 1.4V	F-64			
T45N1500BOF	AEG	51A, 1.5kV, 0.12A, 1.4V	F-64			
T45N1600BOC	AEG	51A, 1.6kV, 0.12A, 1.4V	F-64			

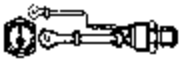
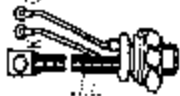

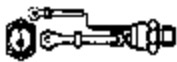
器件型号 Element type	厂名 Manufacturers	材料用途参数 Material Purpose Parameter	图号 Figure	国内外相似替换器件型号 Replace of similar type	备注 Notes	外形参考图 Reference shape
T45N1600BOF	AEG	51A, 1.6kV, 0.12A, 1.4V	F-64			 图 F-64
T45N1700BOF	AEG	51A, 1.7kV, 0.12A, 1.4V	F-64			
T45N1800BOC	AEG	51A, 1.8kV, 0.12A, 1.4V	F-64			
T45N1800BOF	AEG	51A, 1.8kV, 0.12A, 1.4V	F-64			
T50AC40	INR	50A, 400V, 0.5A, 2.5V				 图 E-30
T50AC40A	INR, INJ	50A, 400V, 0.2A, 2V				
T50AC60	INR	50A, 600V, 0.5A, 2.5V				
T50AC60A	INR, INJ	50A, 600V, 0.2A, 2V				
T50AC80	INR	50A, 800V, 0.5A, 2.5V				
T50AC80A	INR, INJ	50A, 800V, 0.2A, 2V				
T50AC100	INR	50A, 1kV, 0.5A, 2.5V				
T50AC100A	INR, INJ	50A, 1kV, 0.2A, 2V				
T50AC120	INR	50A, 1.2kV, 0.5A, 2.5V				
T50AC120A	INR, INJ	50A, 1.2kV, 0.2A, 2V				
T51N400BOC	AEG	50A, 400V, 0.15A, 1.4V	E-30			
T51N400BOF	AEG	102A, 400V, 0.15A, 1.4V	F-64			
T51N400EOC	AEG	50A, 400V, 0.15A, 1.4V	E-30			
T51N600BOC	AEG	50A, 600V, 0.15A, 1.4V	E-30			
T51N600BOF	AEG	102A, 600V, 0.15A, 1.4V	F-64			
T51N600EOC	AEG	50A, 600V, 0.15A, 1.4V	E-30			
T51N800BOC	AEG	50A, 800V, 0.15A, 1.4V	E-30			
T51N800BOF	AEG	102A, 800V, 0.15A, 1.4V	F-64			
T51N800EOC	AEG	50A, 800V, 0.15A, 1.4V	E-30			
T51N1000BOC	AEG	50A, 1kV, 0.15A, 1.4V	E-30			

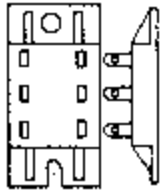
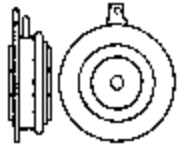
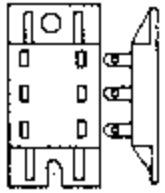
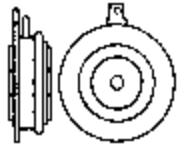
器件型号 Element type	厂名 Manufacturers	材料用途参数 Material Purpose Parameter	图号 Figure	国内外相似替换器件型号 Replace of similar type	备注 Notes	外形参考图 Reference shape
T51N1000BOF	AEG	102A, 1kV, 0.15A, 1.4V	F-64			 图 F-64
T51N1000EOC	AEG	50A, 1kV, 0.15A, 1.4V	E-30			
T51N1100BOC	AEG	102A, 1.1kV, 0.15A, 1.4V	F-64			 图 E-30
T51N1100BOF	AEG	102A, 1.1kV, 0.15A, 1.4V	F-64			
T51N1100EOC	AEG	102A, 1.1kV, 0.15A, 1.4V	E-30			
T51N1200BOC	AEG	50A, 1.2kV, 0.15A, 1.4V	E-30			 图 H-25
I51N1200BOF	AEG	102A, 1.2kV, 0.15A, 1.4V	F-64			
T51N1200EOC	AEG	50A, 1.2kV, 0.15A, 1.4V	E-30			
T51N1400BOC	AEG	50A, 1.4kV, 0.15A, 1.4V	E-30			 图 C-10
T51N1400EOC	AEG	50A, 1.4kV, 0.15A, 1.4V	E-30			
T51N1600BOC	AEG	50A, 1.6kV, 0.15A, 1.4V	E-30			 图 H-25
T51N1600BOF	AEG	102A, 1.6kV, 0.15A, 1.4V	F-64			
T51N1600EOC	AEG	50A, 1.6kV, 0.15A, 1.4V	E-30			
T51N1800BOC	AEG	50A, 1.8kV, 0.15A, 1.4V	E-30			 图 C-10
T51N1800BOF	AEG	102A, 1.8kV, 0.15A, 1.4V	F-64			
T51N1800EOC	AEG	50A, 1.8kV, 0.15A, 1.4V	E-30			
T51, 52, 53, 54, 55, 56, 57, 58, 59	GTN	SCA 25A, 0.04A, 2.5V	H-25			
T61, 62, 63, 64, 65, 66, 67, 68, 69	GTN	SCA 55A, 0.11A, 3V	H-25			
T62FD6130200	WES	FLD 200A, 600V, 750V, 10V	C-10			



器件型号 Element type	厂名 Manufacturers	材料用途参数 Material Purpose Parameter	图号 Figure	国内外相似替换器件型号 Replace of similar type	备注 Notes	外形参考图 Reference shape
T62R06130300	WES	FLD 200A, 600V, 750V, 10V	C-10			
T62R08130200	WES	FLD 200A, 800V, 950V, 10V	C-10			
T62R08130300	WES	FLD 200A, 800V, 950V, 10V	C-10			
T62R10130200	WES	FLD 200A, 1kV, 1.1kV, 10V	C-10			
T62R10130300	WES	FLD 300A, 1kV, 1.1kV, 10V	C-10			
T70R1A10		MOD, 70A, 100V				
T70R1A20		MOD, 70A, 200V				
T70R1A30		MOD, 70A, 300V				
T70R1A40		MOD, 70A, 400V				
T70R1A60		MOD, 70A, 600V				
T70R1A80		MOD, 70A, 800V				
T70R1A100		MOD, 70A, 1kV				
T70R1A120		MOD, 70A, 1.2kV				
T71N400BOC	AEG	70A, 400V, 0.15A, 1.4V	E-30			
T71N400BOF	AEG	127A, 400V, 0.15A, 1.4V	F-64			
T71N400EOC	AEG	70A, 400V, 0.15A, 1.4V	E-30			
T71N600BOC	AEG	70A, 600V, 0.15A, 1.4V	E-30			
T71N600BOF	AEG	127A, 600V, 0.15A, 1.4V	F-64			
T71N600EOC	AEG	70A, 600V, 0.15A, 1.4V	E-30			
T71N800BOC	AEG	70A, 800V, 0.15A, 1.4V	E-30			
T71N800BOF	AEG	127A, 800V, 0.15A, 1.4V	F-64			
T71N800FOC	AEG	70A, 800V, 0.15A, 1.4V	E-30			
T71N1000BOC	AEG	70A, 1kV, 0.15A, 1.4V	E-30			
T71N1000BOF	AEG	127A, 1kV, 0.15A, 1.4V	F-64			

图 C-10

图 E-30

图 F-64

器件型号 Element type	厂名 Manufacturers	材料用途参数 Material Purpose Parameter	图号 Figure	国内外相似替换器型号 Replace of similar type	备注 Notes	外形参考图 Reference shape
T71N1000EOC	AEG	70A, 1kV, 0.15A, 1.4V	E-30			
T71N1100BOC	AEG	127A, 1.1kV, 0.15A, 1.4V	F-64			
T71N1100BOF	AEG	127A, 1.1kV, 0.15A, 1.4V	F-64			
T71N1100EOC	AEG	127A, 1.1kV, 0.15A, 1.4V	E-30			
T71N1100EOF	AEG	127A, 1.1kV, 0.15A, 1.4V	E-30			
T71N1200BOC	AEG	70A, 1.2kV, 0.15A, 1.4V	E-30			
T71N1200BOF	AEG	127A, 1.2kV, 0.15A, 1.4V	F-64			
T71N1200EOC	AEG	70A, 1.2kV, 0.15A, 1.4V	E-30			
T71N1400BOC	AEG	70A, 1.4kV, 0.15A, 1.4V	E-30			
T71N1400EOC	AEG	70A, 1.4kV, 0.15A, 1.4V	E-30			
T71N1600BOC	AEG	70A, 1.6kV, 0.15A, 1.4V	E-30			
T71N1600BOF	AEG	127A, 1.6kV, 0.15A, 1.4V	F-64			
T71N1800BOC	AEG	70A, 1.8kV, 0.15A, 1.4V	E-30			
T71N1800BOF	AEG	127A, 1.8kV, 0.15A, 1.4V	F-64			
T71N1800EOC	AEG	70A, 1.8kV, 0.15A, 1.4V	E-30			
T72F200BB	AEG	127A, 200V, 0.15A, 2V	E-30			
T72F200BD	AEG	127A, 200V, 0.15A, 2V	E-30			
T72F400BB, BBL, BBM	AEG	127A, 400V, 0.15A, 2V	E-30			
T72F400BBC	AEG	200A, 400V, 0.15A, 2V	E-30			
T72F400BD	AEG	127A, 400V, 0.15A, 2V	E-30			

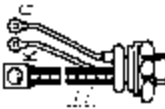
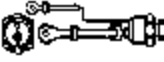

图 E-30



图 F-64



器件型号 Element type	厂名 Manufacturers	材料用途参数 Material Purpose Parameter	图号 Figure	国内外相似替换器件型号 Replace of similar type	备注 Notes	外形参考图 Reference shape
T72F600BBB, RBL, BBM	AEG	127A, 600V, 0.15A, 2V	E-30			 图 E-30
T72F600BBC	AEG	200A, 600V, 0.15A, 2V	E-30			
T72F600BD	AEG	127A, 600V, 0.15A, 2V	E-30			
T72F600BBB, BBL, BBM	AEG	127A, 800V, 0.15A, 2V	E-30			 图 C-47
T72F800BBC	AEG	200A, 800V, 0.15A, 2V	E-30			
T72F800BD	AEG	127A, 800V, 0.15A, 2V	E-30			
T72H0135B4DN	WES	350A, 100V, 0.15A, 3V	C-47			
T72H0145B4DN	WES	700A, 100V, 0.15A, 3V	C-47			
T72H0148B4DN	WES	750A, 100V, 0.15A, 3V	C-47			
T72H0245B4DN	WES	700A, 200V, 0.15A, 3V	C-47			
T72H0248B4DN	WES	750A, 200V, 0.15A, 3V	C-47			
T72H0335B4DN	WES	350A, 300V, 0.15A, 3V	C-47			
T72H0345B4DN	WES	700A, 300V, 0.15A, 3V	C-47			
T72H0348B4DN	WES	750A, 300V, 0.15A, 3V	C-47			
T72H0435B4DN	WES	350A, 400V, 0.15A, 3V	C-47			
T72H0445B4DN	WES	700A, 400V, 0.15A, 3V	C-47			
T72H0448B4DN	WES	750A, 400V, 0.15A, 3V	C-47			
T72H0535B4DN	WES	350A, 500V, 0.15A, 3V	C-47			
T72H0545B4DN	WES	700A, 500V, 0.15A, 3V	C-47			
T72H0548B4DN	WES	750A, 500V, 0.15A, 3V	C-47			
T72H0635B4DN	WES	350A, 600V, 0.15A, 3V	C-47			

器件型号 Element type	厂名 Manufacturers	材料用途参数 Material Purpose Parameter	图号 Figure	国内外相似替换器件型号 Replace of similar type	备注 Notes	外形参考图 Reference shape
T72H0645B4DN	WES	700A, 600V, 0.15A, 3V	C-47			 图 C-17
T72H0648B4DN	WES	750A, 600V, 0.15A, 3V	C-47			
T72H0735B4DN	WES	350A, 700V, 0.15A, 3V	C-47			
T72H0745B4DN	WES	700A, 700V, 0.15A, 3V	C-47			 图 C-17
T72H0748B4DN	WES	750A, 700V, 0.15A, 3V	C-47			
T72H0835B4DN	WES	350A, 800V, 0.15A, 3V	C-47			
T72H0845B4DN	WES	700A, 800V, 0.15A, 3V	C-47			 图 C-17
T72H0848B4DN	WES	750A, 800V, 0.15A, 3V	C-47			
T72H0935B4DN	WES	350A, 900V, 0.15A, 3V	C-47			
T72H0945B4DN	WES	700A, 900V, 0.15A, 3V	C-47			 图 C-17
T72H1035B4DN	WES	350A, 1kV, 0.15A, 3V	C-47			
T72H1045B4DN	WES	700A, 1kV, 0.15A, 3V	C-47			
T72H1145B4DN	WES	700A, 1.1kV, 0.15A, 3V	C-47			 图 C-35
T72H1235B4D	WES	350A, 1.2kV, 0.15A, 3V	C-47			
T72H1245B4D	WES	700A, 1.2kV, 0.15A, 3V	C-47			
T72H013534, 44, 54	WES	350A, 100V, 0.15A, 3V	C-47			 图 C-35
T72H013564, 74, 84	WES	550A, 100V, 0.15A, 3V	C-35			
T72H014064, 74, 84	WES	625A, 100V, 0.15A, 3V	C-47			
T72H014534, 44, 54	WES	700A, 100V, 0.15A, 3V	C-47			
T72H014844	WES	750A, 100V, 0.15A, 3V	C-47			
T72H014854	WES	750A, 100V, 0.15A, 3V	C-47			

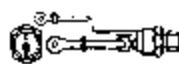
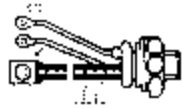
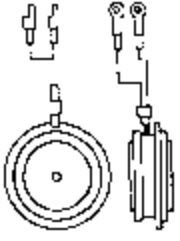
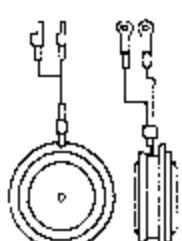
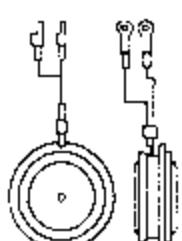
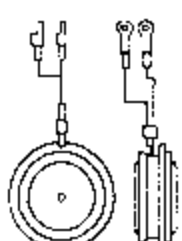
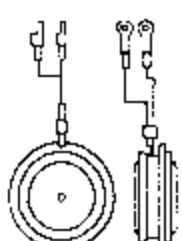
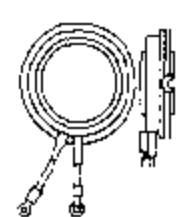
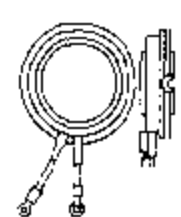

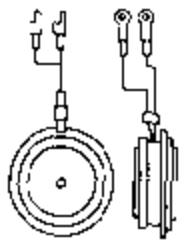
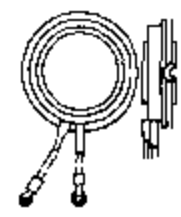

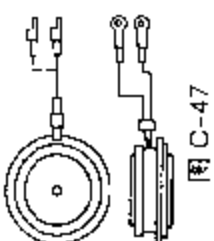
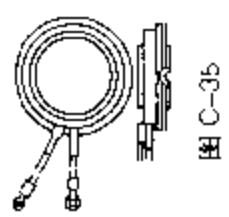
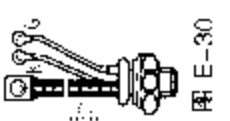

器件型号 Element type	厂名 Manufacturers	材料用途参数 Material Purpose Parameter	图号 Figure	国内外相似替换器件型号 Replace of similar type	备注 Notes	外形参考图 Reference shape
T72H023634, 44, 54	WES	350A, 200V, 0.15A, 3V	C-47			 <p>图 C-47</p>  <p>图 C-35</p>
T72H023664, 74, 84	WES	550A, 200V, 0.15A, 3V	C-35			
T72H024064, 74, 84	WES	625A, 200V, 0.15A, 3V	C-47			
T72H024534, 44	WES	700A, 200V, 0.15A, 3V	C-47			
T72H024854	WES	750A, 200V, 0.15A, 3V	C-47			
T72H033634, 44, 54	WES	350A, 300V, 0.15A, 3V	C-47			
T72H033664, 74, 84	WES	550A, 300V, 0.15A, 3V	C-35			
T72H034064, 74, 84	WES	625A, 300V, 0.15A, 3V	C-47			
T72H034534, 44, 54	WES	700A, 300V, 0.15A, 3V	C-47			
T72H034844, 54	WES	750A, 300V, 0.15A, 3V	C-47			
T72H043634, 44, 54	WES	350A, 400V, 0.15A, 3V	C-47			
T72H043664, 74, 84	WES	550A, 400V, 0.15A, 3V	C-35			
T72H044064, 74, 84	WES	625A, 400V, 0.15A, 3V	C-47			
T72H044534, 44, 54	WES	700A, 400V, 0.15A, 3V	C-47			
T72H044844, 54	WES	750A, 400V, 0.15A, 3V	C-47			
T72H053634, 44, 54	WES	350A, 500V, 0.15A, 3V	C-47			
T72H053664, 74, 84	WES	550A, 500V, 0.15A, 3V	C-35			
T72H054064, 74, 84	WES	625A, 500V, 0.15A, 3V	C-47			
T72H054534, 44, 54	WES	700A, 500V, 0.15A, 3V	C-47			
T72H054844, 54	WES	750A, 500V, 0.15A, 3V	C-47			
T72H063634, 44, 54	WES	350A, 600V, 0.15A, 3V	C-47			
T72H063664, 74, 84	WES	550A, 600V, 0.15A, 3V	C-35			
T72H064064, 74, 84	WES	625A, 600V, 0.15A, 3V	C-47			
T72H064534, 44, 54	WES	700A, 600V, 0.15A, 3V	C-47			
T72H064844, 54	WES	750A, 600V, 0.15A, 3V	C-47			
T72H072554	WES	400A, 700V, 0.15A, 3V	C-47			

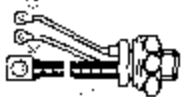
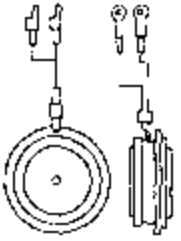

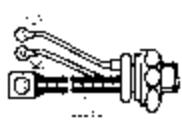
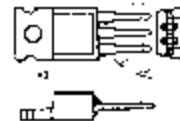
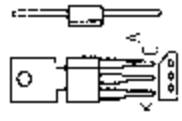



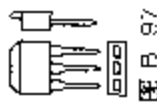

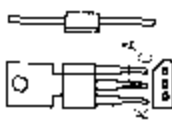

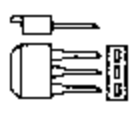
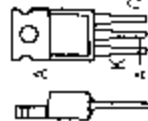
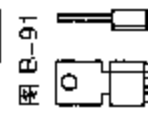
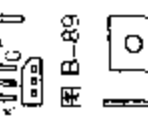
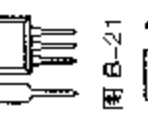
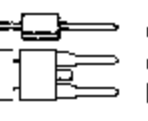



器件型号 Element type	厂名 Manufacturers	材料用途参数 Material Purpose Parameter	图号 Figure	国内外相似替换器件型号 Replace of similar type	备注 Notes	外形参考图 Reference shape
T72H073534, 44, 54	WES	350A, 700V, 0.15A, 3V	C-47			 <p>图 C-47</p>
T72H073564, 74	WES	550A, 700V, 0.15A, 3V	C-35			
T72H074064, 74, 84	WES	625A, 700V, 0.15A, 3V	C-47			
T72H074534, 44, 54	WES	700A, 700V, 0.15A, 3V	C-47			
T72H074844, 54	WES	750A, 700V, 0.15A, 3V	C-47			
T72H083534, 44, 54	WES	350A, 800V, 0.15A, 3V	C-47			 <p>图 C-35</p>
T72H084064, 74, 84	WES	625A, 800V, 0.15A, 3V	C-47			
T72H084534, 44, 54	WES	700A, 800V, 0.15A, 3V	C-47			
T72H084844, 54	WES	750A, 800V, 0.15A, 3V	C-47			
T72H093534, 44, 54	WES	350A, 900V, 0.15A, 3V	C-47			
T72H093564, 74, 84	WES	550A, 900V, 0.15A, 3V	C-35			
T72H094534, 44, 54	WES	700A, 900V, 0.15A, 3V	C-47			
T72H103534	WES	550A, 1kV, 0.15A, 3V	C-47			 <p>图 E-30</p>
T72H103544, 54	WES	350A, 1kV, 0.15A, 3V	C-47			
T72H103564, 74, 84	WES	550A, 1kV, 0.15A, 3V	C-35			
T72H104534, 44, 54	WES	700A, 1kV, 0.15A, 3V	C-47			
T72H113544	WES	550A, 1.1kV, 0.15A, 3V	C-47			
T72H113564, 74, 84	WES	550A, 1.1kV, 0.15A, 3V	C-35			
T72H114534, 44, 54	WES	700A, 1.1kV, 0.15A, 3V	C-47			
T72H123534, 44, 54	WES	350A, 1.2kV, 0.15A, 3V	C-47			
T72H123564, 74, 84	WES	550A, 1.2kV, 0.15A, 3V	C-35			
T72H124534, 44, 54	WES	700A, 1.2kV, 0.15A, 3V	C-47			
T72H124564, 74, 84	WES	700A, 1.2kV, 0.15A, 3V	C-35			
T80F900	AEG	127A, 900V, 0.15A, 2V	F-30			





器件型号 Element type	厂名 Manufacturers	材料用途参数 Material Purpose Parameter	图号 Figure	国内外相似替换器件型号 Replace of similar type	备注 Notes	外形参考图 Reference shape	
T80F1000	AEG	127A, 1kV, 0.15A, 2V	E-30			 图 E-30	
T80F1100	AEG	127A, 1.1kV, 0.15A, 2V	E-30				
T80F1300	AEG	127A, 1.3kV, 0.15A, 2V	E-30				
T90R1A10		MOD, 90A, 100V					
T90R1A20		MOD, 90A, 200V					
T90R1A40		MOD, 90A, 400V					
T90R1A60		MOD, 90A, 600V					
T90R1A80		MOD, 90A, 800V					
T90R1A100		MOD, 90A, 1kV					
T90R1A120		MOD, 90A, 1.2kV					
T99N400BOF	AEG	140A, 400V, 0.15A, 1.4V	E-30				 图 C-47
T99N400EOF	AEG	140A, 400V, 0.15A, 1.4V	E-30				
T99N600BOF	AEG	140A, 600V, 0.15A, 1.4V	F-30				
T99N600EOF	AEG	140A, 600V, 0.15A, 1.4V	E-30				
T99N800BOF	AEG	140A, 800V, 0.15A, 1.4V	E-30				
T99N800EOF	AEG	140A, 800V, 0.15A, 1.4V	E-30				
T99N1000BOF	AEG	140A, 1kV, 0.15A, 1.4V	E-30				
T99N1000EOF	AEG	140A, 1kV, 0.15A, 1.4V	E-30				
T99N1100BOF	AEG	140A, 1.1kV, 0.15A, 1.4V	E-30				
T99N1100EOF	AEG	140A, 1.1kV, 0.15A, 1.4V	C-47				
T99N1200BOF	AEG	140A, 1.2kV, 0.15A, 1.4V	E-30				
T99N1200EOF	AEG	140A, 1.2kV, 0.15A, 1.4V	E-30				
T99N1300BOF	AEG	140A, 1.3kV, 0.15A, 1.4V	E-30				
T99N1300EOF	AEG	140A, 1.3kV, 0.15A, 1.4V	E-30				
T99N1500BOF	AEG	140A, 1.5kV, 0.15A, 1.4V	E-30				
T99N1500EOF	AEG	140A, 1.5kV, 0.15A, 1.4V	E-30				
T99N1600BOF	AEG	140A, 1.6kV, 0.15A, 1.4V	E-30				



器件型号 Element type	厂名 Manufacturers	材料 Material	用途 Purpose	参数 Parameter	图号 Figure	国内外相似替换器件型号 Replace of similar type	备注 Notes	外形参考图 Reference shape
T99N1600EOF	AEG	140A	1.6kV	0.15A, 1.4V	E-30			
T99N1700BOF	AEG	140A	1.7kV	0.15A, 1.4V	E-30			
T99N1700EOF	AEG	140A	1.7kV	0.15A, 1.4V	E-30			
T99N1800BOF	AEG	140A	1.8kV	0.15A, 1.4V	E-30			
T99N1800EOF	AEG	140A	1.8kV	0.15A, 1.4V	E-30			
T102F200BB	AEG	140A	200V	0.15A, 2V	E-30			
T102F200BD	AEG	140A	200V	0.15A, 2V	E-30			
T102F400BBB, BBL, BBM	AEG	140A	400V	0.15A, 2V	E-30			
T102F400BBC	AEG	220A	400V	0.15A, 2V	E-30			
T102F400BD	AEG	140A	400V	0.15A, 2V	E-30			
T102F600BBB, BBL, BBM	AEG	140A	600V	0.15A, 2V	E-30			
T102F600BBC	AEG	220A	600V	0.15A, 2V	E-30			
T102F600BD	ALG	140A	600V	0.15A, 2V	E-30			
T102F800BBB, BBL, BBM	AEG	140A	800V	0.15A, 2V	E-30			
T102F800BBC	AEG	220A	800V	0.15A, 2V	E-30			
T102F800BD	AEG	140A	800V	0.15A, 2V	E-30			
T106A1	TCE	4A	100V	200 μA, 0.8V	B-91	C106A, ECG5454		
T106A1SC	HUT	3A	100V	0.004A, 2.2V	B-89	ECG5629		
T106A1SD	HUT	3A	100V	0.005A, 2.2V	B-89	ECG5629		
T106A1SG	HUT	3A	100V	0.01A, 2.2V	B-89	ECG5629		
T106A1SH	HUT	3A	100V	0.025A, 2.2V	B-89	ECG5629		

器件型号 Element type	厂名 Manufacturers	材料用途参数 Material Purpose Parameter	图号 Figure	国内外相似替换器件型号 Replace of similar type	备注 Notes	外形参考图 Reference shape	
T106A1SS	HUT	3A, 100V, 0.003A, 2.2V	B-97	ECG5629		 图 B-97	
T106A2SC	HUT	3A, 100V, 0.004A, 2.2V	B-97	ECG5629			
T106A2SD	HUT	3A, 100V, 0.005A, 2.2V	B-97	ECG5629			
T106A2SG	HUT	3A, 100V, 0.01A, 2.2V	B-97	ECG5629			
T106A2SH	HUT	3A, 100V, 0.025A, 2.2V	B-97	ECG5629			
T106A2SS	HUT	3A, 100V, 0.003A, 2.2V	B-97	ECG5629			
T106B1	TCE	4A, 200V, 200 μ A, 0.8V	B-91	ECG5455, T106B		 图 B-91	
T106B1SC	HUT	3A, 200V, 0.004A, 2.2V	B-89	ECG5629			
T106B1SD	HUT	3A, 200V, 0.005A, 2.2V	B-89	ECG5629			
T106B1SG	HUT	3A, 200V, 0.01A, 2.2V	B-89	ECG5629			
T106B1SH	HUT	3A, 200V, 0.025A, 2.2V	B-89	ECG5629			
T106B1SS	HUT	3A, 200V, 0.003A, 2.2V	B-89	ECG5629			
T106B2SC	HUT	3A, 200V, 0.004A, 2.2V	B-97	ECG5629			
T106B2SD	HUT	3A, 200V, 0.005A, 2.2V	B-97	ECG5629			
T106B2SG	HUT	3A, 200V, 0.01A, 2.2V	B-97	ECG5629			
T106B2SH	HUT	3A, 200V, 0.025A, 2.2V	B-97	ECG5629			
T106B2SS	HUT	3A, 200V, 0.003A, 2.2V	B-97	ECG5629			
T106C1	TCE	4A, 300V, 200 μ A, 0.8V	B-91	ECG5457, T106C			 图 B-89
T106C1SC	HUT	3A, 300V, 0.004A, 2.2V	B-89	ECG5629			
T106C1SD	HUT	3A, 300V, 0.005A, 2.2V	B-89	ECG5629			
T106C1SG	HUT	3A, 300V, 0.01A, 2.2V	B-89	ECG5629			
T106C1SH	HUT	3A, 300V, 0.025A, 2.2V	B-89	ECG5629			
T106C1SS	HUT	3A, 300V, 0.003A, 2.2V	B-89	ECG5629			
T106C2SC	HUT	3A, 300V, 0.004A, 2.2V	B-97	ECG5629			
T106C2SD	HUT	3A, 300V, 0.005A, 2.2V	B-97	ECG5629			
T106C2SG	HUT	3A, 300V, 0.01A, 2.2V	B-97	ECG5629			
T106C2SH	HUT	3A, 300V, 0.025A, 2.2V	B-97	ECG5629			

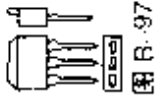
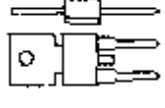
器件型号 Element type	厂名 Manufacturers	材料用途参数 Material Purpose Parameter	图号 Figure	国内外相似替换器件型号 Replace of similar type	备注 Notes	外形参考图 Reference shape
T106C2SS	HUT	3A, 300V, 0.003A, 2.2V	B-97	ECG5629		
T106D1	TCE	4A, 400V, 200 μA, 0.8V	B-91	ECG5457, T106D		
T106D1SC	HUT	3A, 400V, 0.004A, 2.2V	B-89	ECG5629		
T106D1SD	HUT	3A, 400V, 0.005A, 2.2V	B-89	ECG5629		
T106D1SG	HUT	3A, 400V, 0.01A, 2.2V	B-89	ECG5629		
T106D1SH	HUT	3A, 400V, 0.025A, 2.2V	B-89	ECG5629		
T106D1SS	HUT	3A, 400V, 0.003A, 2.2V	B-89	ECG5629		
T106D2SC	HUT	3A, 400V, 0.004A, 2.2V	B-97	ECG5629		
T106D2SD	HUT	3A, 400V, 0.005A, 2.2V	B-97	ECG5629		
T106D2SG	HUT	3A, 400V, 0.01A, 2.2V	B-21	ECG5629		
T106D2SH	HUT	3A, 400V, 0.025A, 2.2V	B-97	ECG5629		
T106D2SS	HUT	3A, 400V, 0.003A, 2.2V	B-97	ECG5629		
T106E1	TCE	4A, 500V, 200 μA, 0.8V	B-91	T106E		
T106E1SC	HUT	3A, 500V, 0.004A, 2.2V	B-89			
T106E1SD	HUT	3A, 500V, 0.005A, 2.2V	B-89			
T106E1SG	HUT	3A, 500V, 0.01A, 2.2V	B-89			
T106E1SH	HUT	3A, 500V, 0.025A, 2.2V	B-89			
T106E1SS	HUT	3A, 500V, 0.003A, 2.2V	B-89			
T106E2SC	HUT	3A, 500V, 0.004A, 2.2V	B-97			
T106E2SD	HUT	3A, 500V, 0.005A, 2.2V	B-97			
T106E2SG	HUT	3A, 500V, 0.01A, 2.2V	B-97			
T106E2SH	HUT	3A, 500V, 0.025A, 2.2V	B-97			
T106E2SS	HUT	3A, 500V, 0.003A, 2.2V	B-97			
T106F1	TCE	4A, 50V, 200 μA, 0.8V	B-7	ECG5453, T106F		
T106F1SC	HUT	3A, 50V, 0.004A, 2.2V	B-89	ECG5629		
T106F1SD	HUT	3A, 50V, 0.005A, 2.2V	B-89	ECG5629		

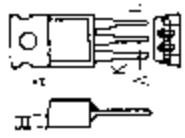
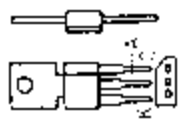
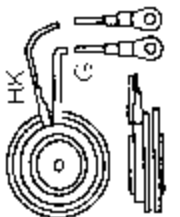
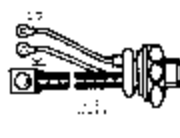

器件型号 Element type	厂名 Manufacturers	材料用途参数 Material Purpose Parameter	图号 Figure	国内外相似替换器件型号 Replace of similar type	备注 Notes	外形参考图 Reference shape
T106F1SG	HUT	3A, 50V, 0.01A, 2.2V	B-89	ECG5629		 图 B-89
T106F1SH	HUT	3A, 50V, 0.025A, 2.2V	B-89	ECG5629		
T106F1SS	HUT	3A, 50V, 0.003A, 2.2V	B-89	ECG5629		
T106F2SC	HUT	3A, 50V, 0.004A, 2.2V	B-97	ECG5629		
T106F2SD	HUT	3A, 50V, 0.005A, 2.2V	B-97	ECG5629		
T106F2SG	HUT	3A, 50V, 0.01A, 2.2V	B-97	ECG5629		
T106F2SH	HUT	3A, 50V, 0.025A, 2.2V	B-97	ECG5629		
T106F2SS	HUT	3A, 50V, 0.003A, 2.2V	B-97	ECG5629		
T106M1	TCE	4A, 600V, 200 μ A, 0.8V	B-89	T106M		
T106M1SC	HUT	3A, 600V, 0.004A, 2.2V	B-89			
T106M1SD	HUT	3A, 600V, 0.005A, 2.2V	B-89			 图 B-97
T106M1SG	HUT	3A, 600V, 0.01A, 2.2V	B-89			
T106M1SH	HUT	3A, 600V, 0.025A, 2.2V	B-89			
T106M1SS	HUT	3A, 600V, 0.003A, 2.2V	B-89			
T106M2SC	HUT	3A, 600V, 0.004A, 2.2V	B-97			
T106M2SD	HUT	3A, 600V, 0.005A, 2.2V	B-97			
T106M2SG	HUT	3A, 600V, 0.01A, 2.2V	B-97			 图 B-7
T106M2SH	HUT	3A, 600V, 0.025A, 2.2V	B-97			
T106M2SS	HUT	3A, 600V, 0.003A, 2.2V	B-97			
T106Q1	TCE	4A, 15V, 200 μ A, 0.8V	B-7	T106Y		
T106Y1	TCE	4A, 30V, 200 μ A, 0.8V	B-91	T106F		 图 B-91
T107A1	TCE	4A, 100V, 500 μ A, 0.8V	B-91	C106A, ECG5454		
T107B1	TCE	4A, 200V, 500 μ A, 0.8V	B-91	C106B, ECG5455		
T107C1	TCE	4A, 300V, 500 μ A, 0.8V	B-91	C106C, ECT5457		
T107D1	TCE	4A, 400V, 500 μ A, 0.8V	B-91	C106D, ECT5457		
T107E1	TCE	4A, 500V, 500 μ A, 0.8V	B-91	C106E		

器件型号 Element type	厂名 Manufacturers	材料用途参数 Material Purpose Parameter	图号 Figure	国内外相似替换器件型号 Replace of similar type	备注 Notes	外形参考图 Reference shape
T107F1	TCE	4A, 50V, 500 μ A, 0.8V	B-91	C106F, ECT5453		 图 B-91
T107M1	TCE	4A, 600V, 500 μ A, 0.8V	B-89	C106M		
T107Q1	TCE	4A, 15V, 500 μ A, 0.8V	B-89	C106Y, ECT5452		
T107Y1	TCE	4A, 30V, 500 μ A, 0.8V	B-91	C106F, ECT5452		
T108A1, 1A	HUT	4A, 100V, 0.05A, 2.5V	B-89			 图 B-89
T108B1, 1A	HUT	4A, 200V, 0.05A, 2.5V	B-89			
T108C1, 1A	HUT	4A, 300V, 0.05A, 2.5V	B-89			
T108D1, 1A	HUT	4A, 400V, 0.05A, 2.5V	B-89			
T108E1, 1A	HUT	4A, 500V, 0.05A, 2.5V	B-89			
T108F1, 1A	HUT	4A, 50V, 0.05A, 2.5V	B-89			
T108F900	AEG	140A, 900V, 0.15A, 1.4V	C-67			 图 C-67
T108F1000	AEG	140A, 1KV, 0.15A, 1.4V	C-67			
T108F1100	AEG	140A, 1.1KV, 0.15A, 1.4V	C-67			
T108F1200	AEG	140A, 1.2KV, 0.15A, 1.4V	C-67			
T108M1	HUT	4A, 600V, 0.05A, 2.5V	B-89			 图 E-30
T120F900	AEG	152A, 900V, 0.15A, 2V	E-30			
T120F1000	AEG	152A, 1KV, 0.15A, 2V	E-30			
T120F1100	AEG	152A, 1.1KV, 0.15A, 2V	E-30			
T120F1200	AEG	152A, 1.2KV, 0.15A, 2V	E-30			
T120F1300	AEG	152A, 1.3KV, 0.15A, 2V	E-30			
T128F600	AEG	128A, 600V, 0.15A, 2V	C-67			 T
T128F800	AEG	128A, 800V, 0.15A, 2V	C-67			
T128F1000	AEG	128A, 1KV, 0.15A, 2V	C-67			
T128F1100	AEG	128A, 1.1KV, 0.15A, 2V	C-67			

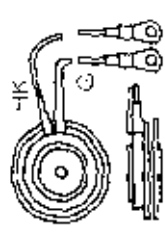
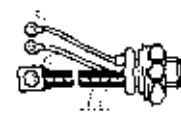
器件型号 Element type	厂名 Manufacturers	材料用途参数 Material Purpose Parameter	图号 Figure	国内外相似替换器件型号 Replace of similar type	备注 Notes	外形参考图 Reference shape
T128F1200	AEG	128A, 1.2kV, 0.15A, 2V	C-67			 图 C-67
T128F1300	AEG	128A, 1.3kV, 0.15A, 2V	C-67			
T130N600	AEG	190A, 600V, 0.15A, 1.4V	E-30			 图 E-30
T130N800	AEG	190A, 800V, 0.15A, 1.4V	E-30			
T130N1000	AEG	190A, 1kV, 0.15A, 1.4V	E-30			
T130N1200	AEG	190A, 1.2kV, 0.15A, 1.4V	E-30			
T130N1400	AEG	190A, 1.4kV, 0.15A, 1.4V	E-30			
T130N1600	AEG	190A, 1.6kV, 0.15A, 1.4V	E-30			
T130N1800	AEG	190A, 1.8kV, 0.15A, 1.4V	E-30			
T160N400	AEG	190A, 400V, 0.15A, 1.4V	E-30			
T160N600	AEG	190A, 600V, 0.15A, 1.4V	E-30			
T160N800	AEG	190A, 800V, 0.15A, 1.4V	E-30			
T160N1000	AEG	190A, 1kV, 0.15A, 1.4V	E-30			
T160N1100	AEG	190A, 1.1kV, 0.15A, 1.4V	E-30			
T160N1200	AEG	190A, 1.2kV, 0.15A, 1.4V	E-30			
T160N1600	AEG	190A, 1.6kV, 0.15A, 1.4V	E-30			
T160N1800	AEG	190A, 1.8kV, 0.15A, 1.4V	E-30			
T175N2000	AEG	255A, 2kV, 0.2A, 2V	E-30			
T175N2200	AEG	230A, 2.2kV, 0.2A, 2V				
T175N2600EOC	AEG	230A, 2.6kV, 0.2A, 2V				
T175N2600EOF	AEG	255A, 2.6kV, 0.2A, 2V	E-30			
T178F200T	AEG	178A, 200V, 0.2A, 2V	C-67			
T178F400T	AEG	178A, 400V, 0.2A, 2V	C-67			
T178F500T	AEG	178A, 500V, 0.2A, 2V	C-67			
T178F600T	AEG	178A, 600V, 0.2A, 2V	C-67			

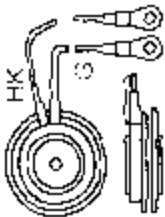
器件型号 Element type	厂名 Manufacturers	材料用途参数 Material Purpose Parameter	图号 Figure	国内外相似替换器件型号 Replace of similar type	备注 Notes	外形参考图 Reference shape
T178N400TOC	AEG	178A, 400V, 0.15A, 1.4V	C-67			 <p>图 C-67</p>
T178N400TOF	AEG	190A, 400V, 0.15A, 1.4V	C-67			
T178N600TOC	AEG	178A, 600V, 0.15A, 1.4V	C-67			
T178N600TOF	AEG	190A, 600V, 0.15A, 1.4V	C-67			
T178N800TOC	AEG	178A, 800V, 0.15A, 1.4V	C-67			
T178N800TOF	AEG	190A, 800V, 0.15A, 1.4V	C-67			
T178N1000TOC	AEG	178A, 1kV, 0.15A, 1.4V	C-67			
T178N1000TOF	AEG	190A, 1kV, 0.15A, 1.4V	C-67			
T178N1100TOC	AEG	178A, 1.1kV, 0.15A, 1.4V	C-67			
T178N1100TOF	AEG	190A, 1.1kV, 0.15A, 1.4V	C-67			
T178N1200TOC	AEG	178A, 1.2kV, 0.15A, 1.4V	C-67			
T178N1200TOF	AEG	190A, 1.2kV, 0.15A, 1.4V	C-67			
T178N1600TOC	AEG	178A, 1.6kV, 0.15A, 1.4V	C-67			
T178N1600TOF	AEG	190A, 1.6kV, 0.15A, 1.4V	C-67			
T178N1800TOC	AEG	178A, 1.8kV, 0.15A, 1.4V	C-67			
T178N1800TOF	AEG	190A, 1.8kV, 0.15A, 1.4V	C-67			
T178S400ECB, ECL, ECM	AEG	178A, 400V, 1A, 1.5V				
T178S400ECC	AEG	400A, 400V, 1A, 1.5V				
T178S400ED	AEG	178A, 400V, 1A, 1.5V				
T178S400EE	AEG	178A, 400V, 1A, 1.5V				
T178S600ECB, ECL, ECM	AEG	178A, 600V, 1A, 1.5V				
T178S600ECC	ALG	400A, 600V, 1A, 1.5V				
T178S600ED	AEG	178A, 600V, 1A, 1.5V				
T178S600EE	AEG	178A, 600V, 1A, 1.5V				

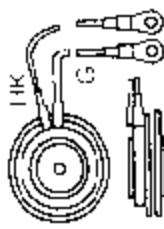

器件型号 Element type	厂名 Manufacturers	材料用途参数 Material Purpose Parameter	图号 Figure	国内外相似替换器件型号 Replace of similar type	备注 Notes	外形参考图 Reference shape
T178S800ECB, ECL, ECM	AEG	178A, 800V, 1A, 1.5V				
T178S800ECC	AEG	400A, 800V, 1A, 1.5V				
T178S800ED	AEG	178A, 800V, 1A, 1.5V				
T178S800EE	AEG	178A, 800V, 1A, 1.5V				
T178S900ECB, ECL, ECM	AEG	178A, 900V, 1A, 1.5V				
T178S900ECC	AEG	400A, 900V, 1A, 1.5V				
T178S900ED	AEG	178A, 900V, 1A, 1.5V				
T178S900EE	AEG	178A, 900V, 1A, 1.5V				
T178S1000ECB, ECL, ECM	AEG	178A, 1KV, 1A, 1.5V				
T178S1000ECC	AEG	400A, 1KV, 1A, 1.5V				
T178S1000ED	AEG	178A, 1KV, 1A, 1.5V				
T178S1000FF	AEG	178A, 1KV, 1A, 1.5V				
T178S1100ECB, ECL, ECM	AEG	178A, 1.1KV, 1A, 1.5V				
T178S1100ECC	AEG	400A, 1.1KV, 1A, 1.5V				
T178S1100ED	AEG	178A, 1.1KV, 1A, 1.5V				
T178S1100EE	AEG	178A, 1.1KV, 1A, 1.5V				
T178S1200ECB, ECL, ECM	AEG	178A, 1.2KV, 1A, 1.5V				
T178S1200ECC	AEG	400A, 1.2KV, 1A, 1.5V				
T178S1200ED	AEG	178A, 1.2KV, 1A, 1.5V				
T178S1200EF	AEG	178A, 1.2KV, 1A, 1.5V				

器件型号 Element type	厂名 Manufacturers	材料用途参数 Material Purpose Parameter	图号 Figure	国内外相似替换器件型号 Replace of similar type	备注 Notes	外形参考图 Reference shape
T188F600T	AEG	188A, 600V, 0.15A, 2V	C-67			 图 C-67
T188F800TE, TF	AEG	188A, 800V, 0.15A, 2V	C-67			
T188F800TSB, TSL, TSM	AEG	188A, 800V, 0.15A, 2V	C-67			
T188F800TSC	AEG	254A, 800V, 0.15A, 2V	C-67			
T188F1000T	AEG	188A, 1kV, 0.15A, 2V	C-67			
T188F1100T	AEG	188A, 1.1kV, 0.15A, 2V	C-67			
T188F1200T	AEG	188A, 1.2kV, 0.15A, 2V	C-67			
T188F1300T	AEG	188A, 1.3kV, 0.15A, 2V	C-67			
T188F1400T	AEG	188A, 1.4kV, 0.15A, 2V	C-67			
T195F200EE, EF, ESB, ESL, ESM	AEG	195A, 200V, 0.25A, 2.2V				
T195F200ESC	AEG	287A, 200V, 0.25A, 2.2V				
T195F400EE, EF, ESB, ESL, ESM	AEG	195A, 400V, 0.25A, 2.2V				
T195F400ESC	AEG	287A, 400V, 0.25A, 2.2V				
T195F600EE, EF, ESB, ESL, ESM	AEG	195A, 600V, 0.25A, 2.2V				
T195F600ESC	AEG	287A, 600V, 0.25A, 2.2V				
T195F800EE, EF, ESB, ESL, ESM	AEG	195A, 800V, 0.25A, 2.2V				
T195F800ESC	AEG	287A, 800V, 0.25A, 2.2V				

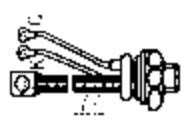
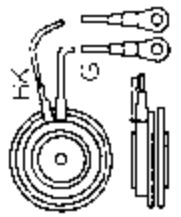

器件型号 Element type	厂名 Manufacturers	材料用途参数 Material Purpose Parameter	图号 Figure	国内外相似替换器件型号 Replace of similar type	备注 Notes	外形参考图 Reference shape
T195F100EE, EF, ESB, ESL, ESM	AEG	195A, 1kV, 0.25A, 2.2V				 图 E-30
T195F100ESC	AEG	287A, 1kV, 0.25A, 2.2V				
T195F1100EE, EF, ESB, ESL, ESM	AEG	195A, 1.1kV, 0.25A, 2.2V				 图 C-67
T195F1100ESC	AEG	287A, 1.1kV, 0.25A, 2.2V				
T195F1200ESC	AEG	287A, 1.2kV, 0.25A, 2.2V				
T195F1300EE, EF, ESB	AEG	195A, 1.3kV, 0.25A, 2.2V				
T195F1300 ESL, ESM	AEG	195A, 1.3kV, 0.25A, 2.2V				
T195F1300ESC	AEG	287A, 1.3kV, 0.25A, 2.2V				
T210N200	AEG	210A, 200V, 0.15A, 1.4V	E-30			
T210N400	AEG	210A, 400V, 0.15A, 1.4V	E-30			
T210N600	AEG	210A, 600V, 0.15A, 1.4V	E-30			
T210N700	AEG	210A, 700V, 0.15A, 1.4V	E-30			
T218N400	AEG	255A, 400V, 0.15A, 1.4V	C-67			
T218N600	AEG	255A, 600V, 0.15A, 1.4V	C-67			
T218N800	AEG	255A, 800V, 0.15A, 1.4V	C-67			
T218N1000	AEG	255A, 1kV, 0.15A, 1.4V	C-67			
T218N1100	AEG	255A, 1.1kV, 0.15A, 1.4V	C-67			
T218N1400	AEG	255A, 1.4kV, 0.15A, 1.4V	C-67			
T218N1600	AEG	255A, 1.8kV, 0.15A, 1.4V	C-67			
T221N400EOC	AEG	260A, 400V, 0.2A, 2V				
T221N400EOF	AEG	265A, 400V, 0.2A, 2V	E-30			
T221N600EOC	AEG	260A, 600V, 0.2A, 2V				

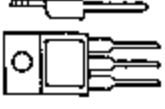
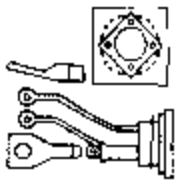
器件型号 Element type	厂名 Manufacturers	材料用途参数 Material Purpose Parameter	图号 Figure	国内外相似替换器件型号 Replace of similar type	备注 Notes	外形参考图 Reference shape
T221N600EOF	AEG	285A, 600V, 0.2A, 2V	E-30			 图 E-30
T221N800EOC	AEG	260A, 800V, 0.2A, 2V	E-30			
T221N800EOF	AEG	285A, 800V, 0.2A, 2V	E-30			
T221N1000EOC	AEG	260A, 1kV, 0.2A, 2V	B-10			
T221N1000EOF	AEG	285A, 1kV, 0.2A, 2V	E-30			
T221N1100EOC	AEG	285A, 1.1kV, 0.2A, 2V	E-30			
T221N1100EOF	AEG	285A, 1.1kV, 0.2A, 2V	E-30			
T221N1400FOC	AEG	260A, 1.4kV, 0.2A, 2V	E-30			
T221N1400EOF	AEG	285A, 1.4kV, 0.2A, 2V	E-30			
T221N1600EOC	AEG	260A, 1.6kV, 0.2A, 2V	E-30			 图 B-10
T221N1600EOF	AEG	285A, 1.6kV, 0.2A, 2V	E-30			
T235N1600EOC	AEG	280A, 1.6kV, 0.2A, 2V	E-30			
T270N2000EO*	AEG	650A, 2kV, 0.25A, 1.5V	E-30			
T270N2200 EOF	AEG	650A, 2.2kV, 0.25A, 1.5V	E-30			 图 E-16
T270N2400EOF	AEG	650A, 2.4kV, 0.25A, 1.5V	E-30			
T270N2600EOF	AEG	650A, 2.6kV, 0.25A, 1.5V	E-30			
T290F110E	AEG	350A, 1.1kV, 0.25A, 2.2V	E-16			
T290F200E	AEG	350A, 200V, 0.25A, 2.2V	E-16			
T290F400E	AEG	350A, 400V, 0.25A, 2.2V	E-16			
T290F600E	AEG	350A, 600V, 0.25A, 2.2V	E-16			
T290F800C	AEG	350A, 800V, 0.25A, 2.2V	E-16			
T290F900E	AEG	350A, 900V, 0.25A, 2.2V	E-16			
T290F1000E	AEG	350A, 1kV, 0.25A, 2.2V	E-16			
T290F1100E	AEG	350A, 1.1kV, 0.25A, 2.2V	E-16			
T290F1200E	AEG	350A, 1.2kV, 0.25A, 2.2V	E-16			
T290F1300E	AEG	350A, 1.3kV, 0.25A, 2.2V	E-16			



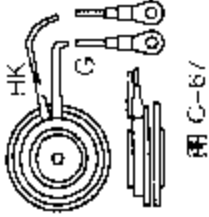

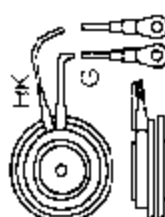
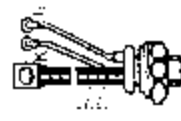
器件型号 Element type	厂名 Manufacturers	材料 用途 参数 Material Purpose Parameter	图号 Figure	国内外相似替换器件型号 Replace of similar type	备注 Notes	外形参考图 Reference shape
T308F200T	AEG	308A, 200V, 0.2A, 2V	C-67			 图 C-67
T308F400TCB, TCL, TCM	AEG	308A, 400V, 0.2A, 2V	C-67			
T308F400TCC	AEG	318A, 400V, 0.2A, 2V	C-67			
T308F400TD	AEG	308A, 400V, 0.2A, 2V	C-67			
T308F400TE	AEG	308A, 400V, 0.2A, 2V	C-67			
T308F500TCB, TCL, TCM	AEG	308A, 500V, 0.2A, 2V	C-67			
T308F500TCC	AEG	318A, 500V, 0.2A, 2V	C-67			
T308F500TD	AEG	308A, 500V, 0.2A, 2V	C-67			
T308F500TE	AEG	308A, 500V, 0.2A, 2V	C-67			
T308F600T	AEG	308A, 600V, 0.2A, 2V	C-67			
T308S200T	AEG	298A, 200V, 1.2A, 1.6V	C-67			
T308S400T	AEG	298A, 400V, 1.2A, 1.6V	C-67			
T308S600T	AEG	298A, 600V, 1.2A, 1.6V	C-67			
T308S800T	AEG	298A, 800V, 1.2A, 1.6V	C-67			
T308S900T	AEG	298A, 900V, 1.2A, 1.6V	C-67			
T308S1000T	AEG	298A, 1kV, 1.2A, 1.6V	C-67			
T308S1100T	AEG	298A, 1.1kV, 1.2A, 1.6V	C-67			
T308S1200T	AEG	298A, 1.2kV, 1.2A, 1.6V	C-67			
T310N2000 TOF	AEG	550A, 2kV, 0.2A, 2.0V	C-67			
T310N2200 TOF	AEG	550A, 2.2kV, 0.2A, 2.0V	C-67			
T310N2400 TOF	AEG	550A, 2.4kV, 0.2A, 2.0V	C-67			
T310N2600 TOF	AEG	550A, 2.6kV, 0.2A, 2.0V	C-67			

器件型号 Element type	厂名 Manufacturers	材料用途参数 Material Purpose Parameter	图号 Figure	国内外相似替换器件型号 Replace of similar type	备注 Notes	外形参考图 Reference shape	
T318F600TE, TF, TSB, TSL, TSM	AEG	318A, 600V, 0.25A, 2.2V	C-67			 图 C-67	
T318F600TSC	AEG	446A, 600V, 0.25A, 2.2V	C-67				
T318F800TE, TF, TSB, TSL, TSM	AEG	318A, 800V, 0.25A, 2.2V	C-67				
T318F800TSC	AEG	446A, 800V, 0.25A, 2.2V	C-67				
T318F1000T	AEG	318A, 1kV, 0.25A, 2.2V	C-67				
T318F1100T	AEG	318A, 1.1kV, 0.25A, 2.2V	C-67				
T318F1200T	AEG	318A, 1.2kV, 0.25A, 2.2V	C-67				
T318F1300T	AEG	318A, 1.3kV, 0.25A, 2.2V	C-67				
T345N400EOC, EOF	AEG	345A, 400V, 0.2A, 2V	E-30				 图 E-30
T345N600EOC	AEG	440A, 600V, 0.2A, 2V	E-30				
T345N600EOF	AEG	345A, 600V, 0.2A, 2V	E-30				
T345N800EOC	AEG	440A, 800V, 0.2A, 2V	E-30				
T345N800EOF	AEG	345A, 800V, 0.2A, 2V	E-30				
T345N1000EOC	AEG	440A, 1kV, 0.2A, 2V	E-30				
T345N1000EOF	AEG	345A, 1kV, 0.2A, 2V	E-30				
T345N1100EOC, EOF	AEG	345A, 1.1kV, 0.2A, 2V	E-30				
T345N1200EOC	AEG	440A, 1.2kV, 0.2A, 2V	E-30				
T345N1400EOC	AEG	440A, 1.4kV, 0.2A, 2V	E-30				
T345N1400EOF	AEG	345A, 1.4kV, 0.2A, 2V	E-30				
T345N1500EOC	AEG	440A, 1.5kV, 0.2A, 2V	E-30				
T345N1600EOC, EOF	AEG	345A, 1.6kV, 0.2A, 2V	E-30				
T358N200TOF	AEG	408A, 200V, 0.15A, 1.4V	C-67				

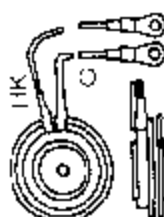

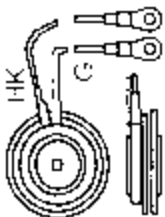
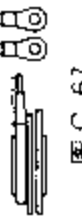
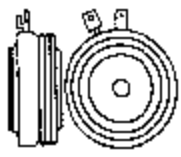
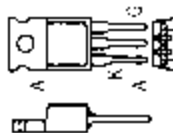
器件型号 Element type	厂名 Manufacturers	材料用途参数 Material Purpose Parameter	图号 Figure	国内外相似替换器件型号 Replace of similar type	备注 Notes	外形参考图 Reference shape
T358N400TOF	AEG	408A, 400V, 0.15A, 1.4V	C-67			 <p>图 C-67</p>
T358N600TOF	AEG	408A, 600V, 0.15A, 1.4V	C-67			
T358N700TOF	AEG	408A, 700V, 0.15A, 1.4V	C-67			
T388N400TOF	AEG	465A, 400V, 0.2A, 2V	C-67			
T388N600TOF	AEG	465A, 600V, 0.2A, 2V	C-67			
T388N800TOF	AEG	465A, 800V, 0.2A, 2V	C-67			
T388N1000TOF	AEG	465A, 1kV, 0.2A, 2V	C-67			
T388N1100TOF	AEG	465A, 1.1kV, 0.2A, 2V	C-67			
T388N1200TOF	AEG	465A, 1.2kV, 0.2A, 2V	C-67			
T388N1400TOF	AEG	465A, 1.4kV, 0.2A, 2V	C-67			
T408F600TE, TF, TSB, TSL, TSM	AEG	408A, 600V, 0.25A, 2.2V	C-67			
T408F600TSC	AEG	477A, 600V, 0.25A, 2.2V	C-67			
T408F800TL, TF, TSB, TSL, TSM	AEG	408A, 800V, 0.25A, 2.2V	C-67			
T408F800TSC	AEG	477A, 800V, 0.25A, 2.2V	C-67			
T408F1000TE, TF, TSB, TSL, TSM	AEG	408A, 1kV, 0.25A, 2.2V	C-67			
T408F1000TSC	AEG	477A, 1kV, 0.25A, 2.2V	C-67			
T408F1100TE, TF, TSB, TSL, SM	AEG	408A, 1.1kV, 0.25A, 2.2V	C-67			
T408F1100TSC	AEG	477A, 1.1kV, 0.25A, 2.2V	C-67			
T408F1200TE	AEG	408A, 1.2kV, 0.25A, 2.2V	C-67			
T408F1200TF	AEG	408A, 1.2kV, 0.25A, 2.2V	C-67			

器件型号 Element type	厂名 Manufacturers	材料用途参数 Material Purpose Parameter	图号 Figure	国内外相似替换器件型号 Replace of similar type	备注 Notes	外形参考图 Reference shape
T408F1300TE, TF, TSL, TSM		408A, 1.3kV, 0.25A, 2.2V	C-67			
T408F1300TSC	AEG	477A, 1.3kV, 0.25A, 2.2V	C-67			 图 C-67
T470S1600T	AEG	470A, 1.6kV, 0.25A, 2.2V	C-8			
T470S1800T	AEG	470A, 1.8kV, 0.25A, 2.2V	C-8			
T470S2000T	AEG	470A, 2kV, 0.25A, 2.2V	C-8			
T0505BH	AGS	SCR-D 5A, 200V, 0.005A, 2.5V, 0.015A	B-91	TAG222-200, TAG227-200		
T0505DH	AGS	5A, 400V, 0.005A, 2.5V, 0.015A	B-91	TAG222-400, TAG227-400, TXC18D40M		 图 C-8
T0505MH	AGS	5A, 600V, 0.005A, 2.5V, 0.015A	B-91	TAG222-600, TAG227-600, TXC18D60M		
T0505NH	AGS	5A, 800V, 0.005A, 2.5V, 0.015A	B-91	TAG222-800, TAG227-800, IXC18D80M		
T508N400	AEG	508A, 400V, 0.2A, 2.0V	C-67			
T508N600	AEG	508A, 600V, 0.2A, 2.0V	C-67			
T508N800	AEG	508A, 800V, 0.2A, 2.0V	C-67			
T508N1000	AEG	508A, 1kV, 0.2A, 2.0V	C-67			
T508N1100	AEG	508A, 1.1kV, 0.2A, 2.0V	C-67			
T508N1200	AEG	508A, 1.2kV, 0.2A, 2.0V	C-67			
T508N1400	AEG	508A, 1.4kV, 0.2A, 2.0V	C-67			
T508N1600	AEG	508A, 1.6kV, 0.2A, 2.0V	C-67			
T0509BH	AGS	5A, 200V, 0.01A, 2.5V	B-91	MAC228A-200, TAG221-200, TAG232-200		
T0509DH	AGS	5A, 400V, 0.01A, 2.5V	B-91	MAC228A-400, TAG221-400, TAG232-400		
T0509MH	AGS	5A, 600V, 0.01A, 2.5V	B-91	MAC228A-600, TAG221-600, TAG232-600		
T0509NH	AGS	5A, 800V, 0.01A, 2.5V	B-91	MAC228A-800, TAG221-800, TAG232-800		 图 B-91
T0510BH	SCR-D	5A, 200V, 0.025A	B-11	TAG220-200, TAG225-200, TAG231-200		
T0510DH	SCR-D	5A, 400V, 0.025A	B-11	TAG220-400, TAG225-400, TAG231-400		 图 B-11

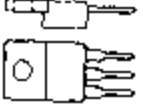
器件型号 Element type	厂名 Manufacturers	材料用途参数 Material Purpose Parameter	图号 Figure	国内外相似替换器件型号 Replace of similar type	备注 Notes	外形参考图 Reference shape
T0510MH	SCR-D	5A, 600V, 0.025A	B-11	TAG220-600, TAG225-600, TAG231-600		
T0510NH	SCR-D	5A, 800V, 0.025A	B-11	TAG220-800, TAG225-800, TAG231-800		图 B-11
T0512BH	TAS	5A, 200V, 0.05A, 2.5V	B-91	TAC224-200, TAG230-200		
T0512DH	TAS	5A, 400V, 0.05A, 2.5V	B-91	TAC224-400, TAG230-400, TCX10H40M		
T0512MH	TAS	5A, 600V, 0.05A, 2.5V	B-91	TAC224-600, TAG230-600, TCX10H60M		
T0512NH	TAS	5A, 800V, 0.05A, 2.5V	B-91	TAC224-800, TAG230-800, TCX10H80M		
T512F	GTN	25A, 500V, 0.04A, 3V				
T513F	GTN	25A, 800V, 0.04A, 3V				
T514F	GTN	25A, 1.2kV, 0.04A, 3V				
T520S600T	AEG	520A, 600V, 0.25A, 2.2V	C-13			
T520S800T	AEG	520A, 800V, 0.25A, 2.2V	C-13			
T520S1000T	AEG	520A, 1kV, 0.25A, 2.2V	C-13			
T520S1100T	AEG	520A, 1.1kV, 0.25A, 2.2V	C-13			
T520S1200T	AEG	520A, 1.2kV, 0.25A, 2.2V	C-13			
T520S1300T	AEG	520A, 1.3kV, 0.25A, 2.2V	C-13			
T520S1400T	AEG	520A, 1.4kV, 0.25A, 2.2V	C-13			
T521N800TOC	AEG	521A, 800V, 0.3A, 2.2V	C-8			
T521N800TOF	AEG	800A, 800V, 0.3A, 2.2V	C-8			
T521N1000TOC, TOF	AEG	521A, 1kV, 0.3A, 2.2V	C-8			
T521N1400TOC, TOF	AEG	521A, 1.4kV, 0.3A, 2.2V	C-8			
T521N1600TOC, TOF	AEG	521A, 1.6kV, 0.3A, 2.2V	C-8			



图 B-91



图 C-13



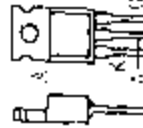

图 C-8

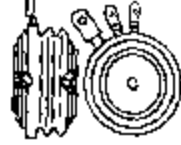
器件型号 Element type	厂名 Manufacturers	材料用途参数 Material Purpose Parameter	图号 Figure	国内外相似替换器件型号 Replace of similar type	备注 Notes	外形参考图 Reference shape
T521N1800TOC, TOF	AEG	521A, 1.8kV, 0.3A, 2.2V	C-8			 图 C-8
T522F	GTN	SCA 25A, 500V, 0.04A, 3V				
T541	GTN	25A, 300V, 0.04A, 2.5V				
T542	GTN	25A, 500V, 0.04A, 2.5V				
T542-6	GTN	SCA 25A, 600V, 0.04A, 3V				
T551	GTN	25A, 300V, 0.04A, 2.5V				
T552	GTN	25A, 500V, 0.04A, 2.5V				
T600F800T	AEG	600A, 600V, 0.25A, 2.2V	C-8			
T600F800T	AEG	600A, 800V, 0.25A, 2.2V	C-8			
T600F1000T	AEG	600A, 1kV, 0.25A, 2.2V	C-8			
T600F1100T	AEG	600A, 1.1kV, 0.25A, 2.2V	C-8			
T600F1200T	AEG	600A, 1.2kV, 0.25A, 2.2V	C-8			
T600F1300T	AEG	600A, 1.3kV, 0.25A, 2.2V	B-32			 图 B-32
T0605BH	TAG	SCR-D 6A, 200V, 0.005A, 2.5V	B-91	TAG222-200, TAG227-200		
T0605DH	TAG	SCR-D 6A, 400V, 0.005A, 2.5V	B-91	TAG222-400, TAG227-400, TCX18D40M		
T0605MH	TAG	SCR-D 6A, 600V, 0.005A, 2.5V	B-91	TAG222-600, TAG227-600, TCX18D60M		
T0605NH	TAG	SCR-D 6A, 800V, 0.005A, 2.5V	B-91	TAG222-800, TAG227-800, TCX18D80M		 图 B-91
T0609BH	TAG	SBS 6A, 200V, 0.01A, 2.5V	B-91	TAG221-200, TAG226-200		
T0609DH	TAG	SBS 6A, 400V, 0.01A, 2.5V	B-91	TAG221-400, TAG226-400, TCX18G40M		
T0609MH	TAG	SBS 6A, 600V, 0.01A, 2.5V	B-91	TAG221-600, TAG226-600, TCX18G60M		
T0609NH	TAG	SBS 6A, 800V, 0.01A, 2.5V	B-91	TAG221-800, TAG226-800, TCX18G80M		 图 B-11
T0610BH, BJ	SCR-D	6A, 200V, 0.005A, 2.5V, 0.05A	B-11	TAG220-200, TAG225-200, TAG257-200, TAG421-200, TAC426-NH200, TAG452-200		

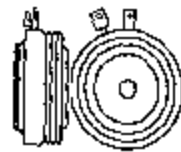
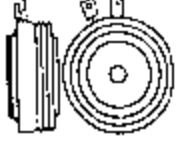
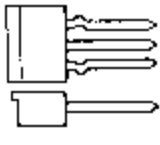
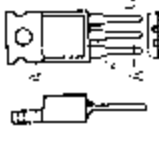
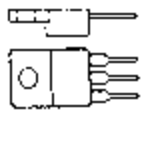
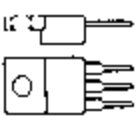
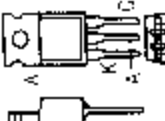
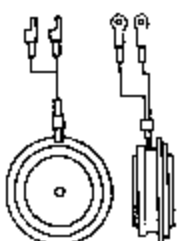
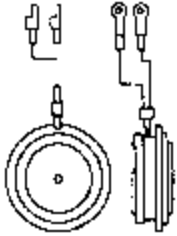

器件型号 Element type	厂名 Manufacturers	材料用途参数 Material Purpose Parameter	图号 Figure	国内外相似替换器件型号 Replace of similar type	备注 Notes	外形参考图 Reference shape
T0610DH, DU	SCR-D	6A, 400V, 0.005A, 2.5V, 0.05A B-11	B-11	TAG220-400, TAG225-400, TAG257-400, TAG421-400, TAG426-NH400, TAG452-400		 图 B-11
T0610MH, MU	SCR-D	6A, 600V, 0.005A, 2.5V, 0.05A B-11	B-11	TAG220-600, TAG225-600, TAG257-600, TAG421-600, TAG426-NH600, TAG452-600		
T0610NH, NU	SCR-D	6A, 600V, 0.005A, 2.5V, 0.05A B-11	B-11	TAG220-800, TAG225-800, TAG257-800, TAG421-800, TAG426-NH800, TAG452-800		
T0612BH, BU	TAG	6A, 200V, 0.05A, 2.5V	B-91	TAG420-200, TAG4256-200, TAG451-200		
T0612BJ, BU	TAG	6A, 400V, 0.05A, 2.5V	B-91	TAG420-400, TAG4256-400, TAG451-400		
T0612MH, MU	TAG	6A, 600V, 0.05A, 2.5V	B-91	TAG420-600, TAG4256-600, TAG451-600		
T0612NH, NU	TAG	6A, 800V, 0.05A, 2.5V	B-91	TAG420-800, TAG4256-800, TAG451-800		
T611F	GTN	42A, 350V, 0.11A, 3V				
T612F	GTN	42A, 500V, 0.11A, 3V				
T613F	GTN	42A, 800V, 0.11A, 3V				 图 B-91
T625N3600	AEG	625A, 3.6kV, 0.3A, 2.5V	C-47			
T625N3800	AEG	625A, 3.8kV, 0.3A, 2.5V	C-47			
T625N4000	AEG	625A, 4.0kV, 0.3A, 2.5V	C-47			
T625N4200	AEG	625A, 4.2kV, 0.3A, 2.5V	C-47			
T625N4400	AEG	625A, 4.4kV, 0.3A, 2.5V	C-47			
T630S1600T	AEG	630A, 1.6kV, 0.25A, 2.2V	C-47			
T630S1800T	AEG	630A, 1.8kV, 0.25A, 2.2V	C-47			
T630S1800TMC	AEG	960A, 1.8kV, 0.25A, 2.2V	C-47			
T630S2000T	AEG	630A, 2kV, 0.25A, 2.2V	C-47			
T630S2000TMC	AEG	960A, 2kV, 0.25A, 2.2V	C-47			 图 C-47
T651	GTN	55A, 350V, 0.11A, 3V				

器件型号 Element type	厂名 Manufacturers	材料用途参数 Material Purpose Parameter	图号 Figure	国内外相似替换器件型号 Replace of similar type	备注 Notes	外形参考图 Reference shape
T652	GTN	SCA 55A, 500V, 0.11A, 3V				 图 C-47
T653	GTN	SCA 55A, 800V, 0.11A, 3V				
T670F1600TK, TN, TMB, TML, TMM	AEG	670A, 1.6kV, 0.25A, 2.2V	C-47			 图 C-67
T670F1600TMC	AEG	1.5kA, 1.6kV, 0.25A, 2.2V	C-47			
T670F1800TK, TN, TMB, TNL, TMM	AEG	670A, 1.8kV, 0.25A, 2.2V	C-47			
T670F1800TMC	AEG	1.5kA, 1.8kV, 0.25A, 2.2V	C-47			
T670F2000TK, TN, TMB TML, TMM,	AEG	670A, 2kV, 0.25A, 2.2V	C-47			
T670F2000TMC	AEG	1.5kA, 2kV, 0.25A, 2.2V	C-47			
T671N3000TOF	AEG	1.5kA, 3.0kV, 0.3A, 1.5V	C-47			
T671N3200TOF	AEG	1.5kA, 3.2kV, 0.3A, 1.5V	C-47			
T671N3400TOF	AEG	1.5kA, 3.4kV, 0.3A, 1.5V	C-47			
T671N3600TOF	AEG	1.5kA, 3.6kV, 0.3A, 1.5V	C-47			
T698F200T	AEG	698A, 200V, 0.2A, 2V	C-67			
T698F400T	AEG	698A, 400V, 0.2A, 2V	C-67			
T698F500T	AEG	698A, 500V, 0.2A, 2V	C-67			
T698F600T	AEG	698A, 600V, 0.2A, 2V	C-67			
T700N1800	AEG	1.5kA, 1.8kV, 0.3A, 1.5V	C-47			
T700N2000	AEG	1.5kA, 2kV, 0.3A, 1.5V	C-47			
T700N2200	AEG	1.5kA, 2.2kV, 0.3A, 1.5V	C-47			
T700N2400	AEG	1.5kA, 2.4kV, 0.3A, 1.5V	C-47			
T700N2600	AEG	1.5kA, 2.6kV, 0.3A, 1.5V	C-47			



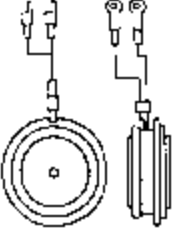
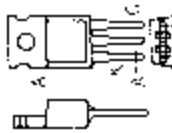

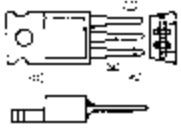
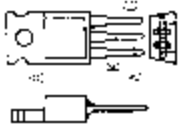
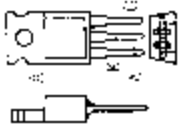
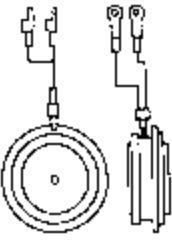
器件型号 Element type	厂名 Manufacturers	材料用途参数 Material Purpose Parameter	图号 Figure	国内外相似替换器件型号 Replace of similar type	备注 Notes	外形参考图 Reference shape
T760F2000TTB, TC, TL, TM, UB, UL, UM	AEG	760A, 2kV, 0.25A, 2.2V	C-47			 <p>图 C 47</p>
T760F2000TUC	AEG	1.27kA, 2kV, 0.25A, 2.2V	C-47			
T760F2200TTB, TC, TL, TM, UB, UL, UM	AEG	760A, 2.2kV, 0.25A, 2.2V	C-47			
T760F2400TTB, TC, TL, TM, UB, UL, UM	AEG	760A, 2.4kV, 0.25A, 2.2V	C-47			 <p>图 B-91</p>
T760F2400TUC	AEG	1.27kA, 2.4kV, 0.25A, 2.2V	C-47			
T0805BH	TAG	8A, 200V, 0.005A, 2.2V	B-91	TAG227-200		
T0805DH	TAG	8A, 400V, 0.005A, 2.2V	B-91	TAG227-400		
T0805MH	TAG	8A, 600V, 0.005A, 2.2V	B-91	TAG227-600		
T0805NH	TAG	8A, 800V, 0.005A, 2.2V	B-91	TAG227-800		
T0809BH	TAG	8A, 200V, 0.01A, 2.2V	B-91	MAC228A-200, TAG226-200		
T0809DH	TAG	8A, 400V, 0.01A, 2.2V	B-91	MAC228A-400, TAG226-400		
T0809MH	TAG	8A, 600V, 0.01A, 2.2V	B-91	MAC228A-600, TAG226-600		
T0809NH	TAG	8A, 800V, 0.01A, 2.2V	B-91	MAC228A-800, TAG226-800		
T0810BH, BJ	TAG	SCR-D 8A, 200V, 0.025A, 2.5V	B-91	TAG225-200, TAG257-200, TAG426-200, TAG452-200, TAG457-200		
T0810DH, DJ	TAG	SCR-D 8A, 400V, 0.025A, 2.5V	B-91	TAG225-400, TAG257-400, TAG426-400, TAG452-400, TAG457-400		
T0810MH, MJ	TAG	SCR-D 8A, 600V, 0.025A, 2.5V	B-91	TAG225-600, TAG257-600, TAG426-600, TAG452-600, TAG457-600		

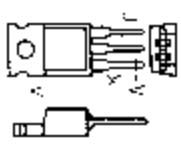
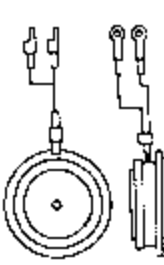

器件型号 Element type	厂名 Manufacturers	材料用途参数 Material Purpose Parameter	图号 Figure	国内外相似替换器件型号 Replace of similar type	备注 Notes	外形参考图 Reference shape
T0810NH, NU	TAG	SCR-D 8A, 800V, 0.025A, 2.5V	B-91	TAG225-800, TAG257-800, TAG426-800, TAG452-800, TAG457-800		
T0812BH, BJ	TAG	SCR-D 8A, 200V, 0.05A, 2.5V	B-91	TAG224-200, TAG250-200, TAG425-200, TAG451-200, TAG456-200, TXD10H-200		
T0812DH, DJ	TAG	SCR-D 8A, 400V, 0.05A, 2.5V	B-91	TAG224-400, TAG250-400, TAG425-400, TAG451-400, TAG456-400, TXD10H-400		
T0812MH, MJ	TAG	SCR-D 8A, 600V, 0.05A, 2.5V	B-91	TAG224-600, TAG250-600, TAG425-600, TAG451-600, TAG456-600, TXD10H-600		
T0812NH, NU	TAG	SCR-D 8A, 800V, 0.05A, 2.5V	B-91	TAG224-800, TAG250-800, TAG425-800, TAG451-800, TAG456-800, TXD10H-800		
T0813BJ	TAG	8A, 200V, 0.05A, 2.5V	B-91	TAG425-200, TAG451-200, TAG456-200		
T0813DJ	TAG	8A, 400V, 0.05A, 2.5V	B-91	TAG425-400, TAG451-400, TAG456-400		
T0813MJ	TAG	8A, 600V, 0.05A, 2.5V	B-91	TAG425-600, TAG451-600, TAG456-600		
T0813NJ	TAG	8A, 800V, 0.05A, 2.5V	B-91	TAG425-800, TAG451-800, TAG456-800		
T860N3000	AEG	860A, 3.0kV, 0.25A, 2V	C-47			
T860N3200	AEG	860A, 3.2kV, 0.25A, 2V	C-47			
T860N3400	AEG	860A, 3.4kV, 0.25A, 2V	C-47			
T860N3600	AEG	860A, 3.6kV, 0.25A, 2V	C-47			
T1010BH, BJ	TAG	SCR-D 10A, 200V, 0.025A, 2.5V	B-91	TAG252-200, TAG257-200, TAG457-200		
T1010DH, DJ	TAG	SCR-D 10A, 400V, 0.025A, 2.5V	B-91	TAG252-400, TAG257-400, TAG457-400		
T1010MH, MJ	TAG	SCR-D 10A, 600V, 0.025A, 2.5V	B-91	TAG252-600, TAG257-600, TAG457-600		
T1010NH, NU	TAG	SCR-D 10A, 800V, 0.025A, 2.5V	B-91	TAG252-800, TAG257-800, TAG457-800		
T1012BH, BJ	TAG	SCR-D 10A, 200V, 0.05A, 2.5V	B-91	MAC210A4, TAG250-200, TAG251-200, TAG456-200, TAG490-200, TAG481-200		

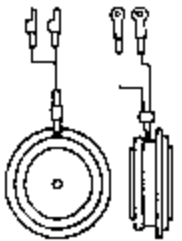

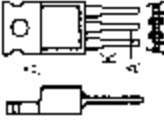



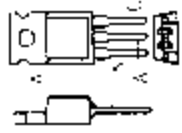
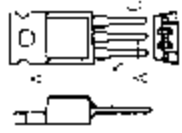

器件型号 Element type	厂名 Manufacturers	材料用途参数 Material Purpose Parameter	图号 Figure	国内外相似替换器件型号 Replace of similar type	备注 Notes	外形参考图 Reference shape
T1012DH, DJ	TAG	SCR-D 10A, 100V, 0.05A, 2.5V	B-91	MAC210A6, TAG250-400, TAG251-400, TAG456-400, TAG480-400, TAG481-400, TXD10H40M		 图 B-91
T1012MH, MJ	TAG	SCR-D 10A, 600V, 0.05A, 2.5V	B-91	MAC210A8, TAG250-600, TAG251-600, TAG456-600, TAG480-600, TAG481-600, TXD10H60M		
T1012NH, NJ	TAG	SCR-D 10A, 800V, 0.05A, 2.5V	B-91	MAC210A10, TAG250-800, TAG251-800, TAG456-800, TAG480-800, TAG481-800, TXD10H80M		
T1013BH, BJ	TAG	SCR-D 10A, 200V, 0.05A, 2.5V	B-91	MAC210A4, TAG250-200, TAG251-200, TAG456-200, TAG480-200, TAG481-200		
T1013DH, DJ	TAG	SCR-D 10A, 400V, 0.05A, 2.5V	B-91	MAC210A6, TAG250-400, TAG251-400, TAG456-400, TAG480-400, TAG481-400, TXD10H40M		
T1013MH, MJ	TAG	SCR-D 10A, 600V, 0.05A, 2.5V	B-91	MAC210A8, TAG250-600, TAG251-600, TAG456-600, TAG480-600, TAG481-600, TXD10H60M		
T1013NH, NJ	TAG	SCR-D 10A, 800V, 0.05A, 2.5V	B-91	TAG250-800, TAG251-800, TAG456-800, TAG480-800, TAG481-800, TXD10H80M		
T1050N2000	AEG	1kA, 2kV, 0.25A, 2V	C-47			 图 C-47
T1050N2200	AEG	1kA, 2.2kV, 0.25A, 2V	C-47			
T1050N2400	AEG	1kA, 2.4kV, 0.25A, 2V	C-47			
T1050N2600	AEG	1kA, 2.6kV, 0.25A, 2V	C-47			
T1050N2800	AEG	1kA, 2.8kV, 0.25A, 2V	C-47			
T1050S600	AEG	1.05kA, 600V, 0.25A, 2.2V	C-47			
T1050S800	AEG	1.05kA, 800V, 0.25A, 2.2V	C-47			
T1050S1000	AEG	1.05kA, 1kV, 0.25A, 2.2V	C-47			
T1050S1100	AEG	1.05kA, 1.1kV, 0.25A, 2.2V	C-47			











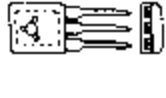

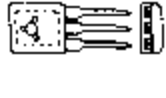

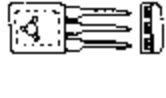

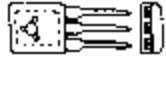

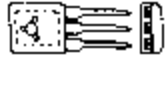

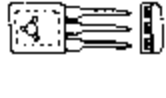
器件型号 Element type	厂名 Manufacturers	材料用途参数 Material Purpose Parameter	图号 Figure	国内外相似替换器件型号 Replace of similar type	备注 Notes	外形参考图 Reference shape
T1050S1200	AEG	1.05kV, 1.2kV, 0.25A, 2.2V	C-47			 <p>图 C-47</p>
T1050S1300	AEG	1.05kV, 1.3kV, 0.25A, 2.2V	C-47			
T1145A0		1.6A, 50V, 0.1A	B-55	2N1595		
T1145A1		1.6A, 100V, 0.1A	B-55	2N1596		
T1145A2		1.6A, 200V, 0.1A	B-55	2N1597		
T1145A3		1.6A, 300V, 0.1A	B-55	2N1598		
T1145A4		1.6A, 400V, 0.1A	B-55	2N1599		
T1200N1200	AFG	1.2kV, 1.2kV, 0.25A, 2V	C-47			 <p>图 B-55</p>
T1200N1400	AEG	1.2kV, 1.4kV, 0.25A, 2V	C-47			
T1200N1600	AEG	1.2kV, 1.6kV, 0.25A, 2V	C-47			
T1200N1800	AEG	1.2kV, 1.8kV, 0.25A, 2V	C-47			
T1210BH	TAG	12A, 200V, 0.025A, 2.5V	B-91	TAG257-200		 <p>图 B-91</p>
T1210DH	TAG	12A, 400V, 0.025A, 2.5V	B-91	TAG257-400		
T1210MH	TAG	12A, 600V, 0.025A, 2.5V	B-91	TAG257-600		
T1210NH	TAG	12A, 800V, 0.025A, 2.5V	B-91	TAG257-800		
T1212BH, BJ	TAG	SCR-D 12A, 200V, 0.05A, 2.5V	B-91	BT138-200, TAG255-200, TAG256-200, TAG480-200, TAG481-200		
T1212DH, DJ	TAG	SCR-D 12A, 400V, 0.05A, 2.5V	B-91	BT138-400, TAG255-400, TAG256-400, TAG480-400, TAG481-400		
T1212MH, MJ	TAG	SCR-D 12A, 600V, 0.05A, 2.5V	B-91	BT138-600, TAG255-600, TAG256-600, TAG480-600, TAG481-600		
T1212NH, NJ	TAG	SCR-D 12A, 800V, 0.05A, 2.5V	B-91	BT138-800, TAG255-800, TAG256-800, TAG480-800, TAG481-800		
T1213BH, BJ	TAG	SCR-D 12A, 200V, 0.05A, 2.5V	B-91	MAC212A4, TAG255-200, TAG256-200, TAG480-200, TAG481-200		

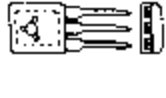

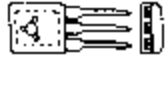
器件型号 Element type	厂名 Manufacturers	材料用途参数 Material Purpose Parameter	图号 Figure	国内外相似替换器件型号 Replace of similar type	备注 Notes	外形参考图 Reference shape
T1213DH, DJ	TAG	SCR-D 12A, 400V, 0.05A, 2.5V	B-91	BT138-400, MAC212A6, TAG255-400, TAG256-400, TAG480-400, TAG481-400		 图 B-91
T1213MH, MJ	TAG	SCR-D 12A, 600V, 0.05A, 2.5V	B-91	BT138-600, MAC212A8, TAG255-600, TAG480-600, TAG481-600		
T1213NH, NJ	TAG	SCR-D 12A, 800V, 0.05A, 2.5V	B-91	BT138-800, MAC212A10, TAG255-800, TAG480-800, TAG481-800		
T1512BJ	TAG	SCR-D 15A, 200V, 0.05A, 2.5V	B-91			 图 B-91
T1512DJ	TAG	SCR-D 15A, 400V, 0.05A, 2.5V	B-91			
T1512MJ	TAG	SCR-D 15A, 600V, 0.05A, 2.5V	B-91			
T1512NJ	TAG	SCR-D 15A, 800V, 0.05A, 2.5V	B-91			
T1513BJ	TAG	SCR-D 15A, 200V, 0.05A, 2.5V	B-91			
T1513DJ	TAG	SCR-D 15A, 400V, 0.05A, 2.5V	B-91			
T1513MJ	TAG	SCR-D 15A, 600V, 0.05A, 2.5V	B-91			
T1513NJ	TAG	SCR-D 15A, 800V, 0.05A, 2.5V	B-91			
T1612BH	TAG	SCR-D 16A, 200V, 0.05A, 2.5V	B-91	BT139-200, MAC15A4, MAC15A 200		 图 B-51
T1612DH	TAG	SCR-D 16A, 400V, 0.05A, 2.5V	B-91	BT139-400, MAC15A6, MAC15A-400, TAG280 400		
T1612MH	TAG	SCR-D 16A, 600V, 0.05A, 2.5V	B-91	BT139-600, MAC15A8, MAC15A-600, TAG280-600		
T1612NH	TAG	SCR-D 16A, 800V, 0.05A, 2.5V	B-91	BT139-800, MAC15A10, MAC15A-800, TAG280-800		
T1613BH	TAG	SCR-D 16A, 200V, 0.05A, 2.5V	B-91	BT139-200, MAC15A-200, TAG280-200		
T1613DH	TAG	SCR-D 16A, 400V, 0.05A, 2.5V	B-91	BT139-400, MAC15A-400, TAG280-400		
T1613MH	TAG	SCR-D 16A, 600V, 0.05A, 2.5V	B-91	BT139-600, MAC15A-600, TAG280-600		
T1613NH	TAG	SCR-D 16A, 800V, 0.05A, 2.5V	B-91	BT139-800, MAC15A-800, TAG280-800		
T2300A	RCA	SCR-D 2.5A, 100V, 0.003A, 2.2V	B-51	L1003M3, SK3506, SK5642, TAG207-100, T2320A, T2300PA, T2300PA5, Z0402B		
T2300B	RCA	SCR-D 2.5A, 200V, 0.003A, 2.2V	B-51	L2003M3, SK3506, SK5642, TAG207-200, T2300PB, T2300PB5, T2320B, Z0402B		

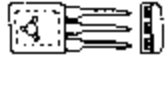
器件型号 Element type	厂名 Manufacturers	材料用途参数 Material Purpose Parameter	图号 Figure	国内外相似替换器件型号 Replace of similar type	备注 Notes	外形参考图 Reference shape
T2300C	RCA	SCR-D 2.5A, 300V, 0.003A, 2.2V	B-62	T2320C, T2300PC, ZD402D		 图 B-62
T2300D	RCA	SCR-D 2.5A, 400V, 0.003A, 2.2V	B-51	L4003M3, SK3506, SK5642, TAG207-400. T2300PD5, T2320D, ZD402D T2320E, T2300PE, ZD402M		
T2300E	RCA	SCR-D 2.5A, 500V, 0.003A, 2.2V	B-62	L2003M3, T2300PF5		 图 B-51
T2300F	RCA	SCR-D 2.5A, 50V, 0.003A, 2.2V	B-51	T2320M, ZD402M, T2300PM		
T2300M		2.5A, 600V, 0.003A, 2.2V	B-62	T2320N, ZD402N, T2300PN		 图 B-6
T2300N		2.5A, 800V, 0.003A, 2.2V	B-62	T2320A, ZD402B		
T2300PA	MOT	2.5A, 100V, 0.003A, 2.2V	B-6	T2320B, ZD402B		 图 B-51
T2300PB	MOT	2.5A, 200V, 0.003A, 2.2V	B-6	T2320C, ZD402D		
T2300PC	MOT	2.5A, 300V, 0.003A, 2.2V	B-6	T2320D, ZD402D		 图 B-6
T2300PD	MOT	2.5A, 400V, 0.003A, 2.2V	B-6	T2320E, ZD402E		
T2300PE	MOT	2.5A, 500V, 0.003A, 2.2V	B-6	T2320F		 图 B-6
T2300PF	MOT	2.5A, 50V, 0.003A, 2.2V	B-6	T2320M, ZD402M		
T2300PM	MOT	2.5A, 600V, 0.003A, 2.2V	B-6	T2320N, ZD402N		 图 B-6
T2300PN	MOT	2.5A, 800V, 0.003A, 2.2V	B-81	L1003M3, SK3506, SK5642, TAG205-100, T2301PA, T2301PA5, T2327A, ZD405B		
T2301A	RCT	SCR-D 2.5A, 100V, 0.004A, 2.2V	B-51	L2003M3, SK3506, SK5642, T2301PB, T2301PB5, TAG205-200, T2327B, ZD405B		 图 B-31
T2301B	HCI	SCR-D 2.5A, 200V, 0.004A, 2.2V	B-51	T2301PC, T2327C, ZD405D		
T2301C		SCR-D 2.5A, 300V, 0.004A	B-23	L4003M3, SK3506, SK5642, TAG205 400.		 图 B-31
T2301D	RCT	SCR-D 2.5A, 400V, 0.004A, 2.2V	B-51	T2301PD5, T2327D, ZD405D		
T2301F		SCR-D 2.5A, 500V, 0.004A	B-23	T2301PE, T2327E, ZD405M		 图 B-31
T2301F	RCT	SCR-D 2.5A, 50V, 0.004A, 2.2V	B-51	L2003M3, T2301PF, T2301PF5, T2327F		
T2301M		SCR-D 2.5A, 600V, 0.004A	B-23	T2301PM, T2327M, ZD405M		 图 B-31
T2301N	MOT	SCR-D 2.5A, 800V, 0.004A, 2.2V	B-62	T2301PN, T2327N, ZD405N		
T2301PA	MOT	2.5A, 100V, 0.004A, 2.2V	B-6	TAG222100, TAG233, T2301PA, TXC18D, ZD405B		 图 B-23
T2301PB	MOT	2.5A, 200V, 0.004A, 2.2V	B-6	TAG222200, TAG233, T2301PB, TXC18D, ZD405B		
T2301PC	MOT	2.5A, 300V, 0.004A, 2.2V	B-6	TAG222300, TAG233, T2301PC, TXC18D, ZD405D		

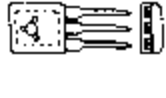

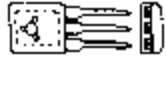
器件型号 Element type	厂名 Manufacturers	材料用途参数 Material Purpose Parameter	图号 Figure	国内外相似替换器件型号 Replace of similar type	备注 Notes	外形参考图 Reference shape
T2301PD	MOT	SCR-D 2.5A, 400V, 0.004A, 2.2V	B-6	TAG222400, TAG233, T2301PD, TXC18D, ZD405D		 图 B-6
T2301PE	MOT	SCR-D 2.5A, 500V, 0.004A, 2.2V	B-6	TAG222500, TAG233, T2301PE, TXC18D		 图 B-81
T2301PF	MOT	SCR-D 2.5A, 50V, 0.004A, 2.2V	B-6	TAG22250, TAG233, T2301PF, TXC18D, ZD405M		 图 B-6
T2301PM	MOT	SCR-D 2.5A, 600V, 0.004A, 2.2V	B-6	TAG222600, TAG233, T2301PM, TXC18D, ZD405M		 图 B-81
T2301PN	MOT	SCR-D 2.5A, 800V, 0.004A, 2.2V	B-81	TAG222800, TAG233, TXC18D, ZD405N		 图 B-6
T2302A	RCA	Triac 2.5A, 100V, 0.01A, 2.2V	B-11	L1003M3, SK3583, SK5641, TAG203-100, T2302PA, T2322, ZD409B		 图 B-81
T2302B	RCA	Triac 2.5A, 200V, 0.01A, 2.2V	B-11	L2003M3, SK3583, SK5641, TAG203-200, T2302PB5, T2302PB, T2322, ZD409B		 图 B-6
T2302C		Triac 2.5A, 300V, 0.01A	B-23	T2302PC, T2322, ZD409D, 2N6073		 图 B-81
T2302D	RCA	Triac 2.5A, 400V, 0.01A, 2.2V	B-11	L4003M3, SK3506, SK5642, TAG203-400, T2302PD, T2322, ZD409D, 2N6073		 图 B-6
T2302E		Triac 2.5A, 500V, 0.01A	B-23	T2302PE, T2322, 2N6071		 图 B-81
T2302F	RCA	Triac 2.5A, 50V, 0.01A, 2.2V	B-51	L2003M4, T2302PF, T2322, 2N6071		 图 B-6
T2302M	RCA	Triac 2.5A, 600V, 0.01A, 2.2V	B-62	T2302PM, T2322, ZD409M		 图 B-81
T2302N	RCA	Triac 2.5A, 800V, 0.01A, 2.2V	B-62	T2302PN, T2322, ZD409N		 图 B-6
T2302PA	MOT	Triac 2.5A, 100V, 0.01A, 2.2V	B-6	TAG221-100, TAG232-100, T2302PB, ZD409B		 图 B-81
T2302PB	MOT	Triac 2.5A, 200V, 0.01A, 2.2V	B-6	TAG221-200, TAG232-200, T2302PC, ZD409B		 图 B-6
T2302PC	MOT	Triac 2.5A, 300V, 0.01A, 2.2V	B-6	TAG221-300, TAG232-300, TXC18G40, T2302PD, ZD409D		 图 B-81
T2302PD	MOT	Triac 2.5A, 400V, 0.01A, 2.2V	B-6	TAG221-400, TAG232-400, T2302PE, TXC18G50, ZD409M		 图 B-6
T2302PE	MOT	Triac 2.5A, 500V, 0.01A, 2.2V	B-6	TAG221-500, TAG232-500, T2302PF, ZD409M		 图 B-81
T2302PF	MOT	Triac 2.5A, 50V, 0.01A, 2.2V	B-6	TAG221-600, TAG232-600, T2302PM, TXC18G60, ZD409M		 图 B-6
T2302PM	MOT	Triac 2.5A, 600V, 0.01A, 2.2V	B-6	TAG221-800, TAG232-800, T2302PN, TXC18G80, ZD409N		 图 B-81
T2302PN		Triac 2.5A, 800V, 0.01A, 2.2V	B-6	TAG221-100, TAG220-100, TAG231-200		 图 B-6
T2303A		Triac 2.5A, 100V, 0.04A	B-62	TAG208-100, TAG220-100, TAG231-200		 图 B-62

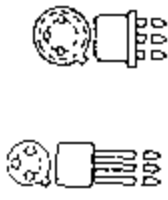
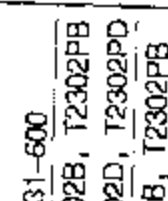
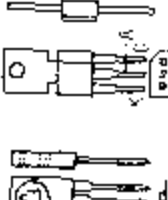
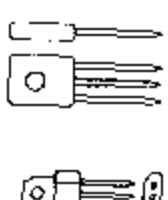

器件型号 Element type	厂名 Manufacturers	材料用途参数 Material Purpose Parameter	图号 Figure	国内外相似替换器件型号 Replace of similar type	备注 Notes	外形参考图 Reference shape
T2303B	Triac	2.5A, 200V, 0.04A	B-62	TAG208-200, TAG220-100, TAG231-200	 图 B-62 图 B-51	
T2303D	Triac	2.5A, 400V, 0.04A	B-62	TAG208-400, TAG220-400, TAG231-400		
T2303F	Triac	2.5A, 50V, 0.04A	B-51	L2003M4, SC136A, TAG208-100, TAG220-100, TAG231-200		
T2303M	Triac	2.5A, 800V, 0.04A	B-62	TAG208-600, TAG220-600, TAG231-600	 图 B-62 图 B-51	
T2304B	Triac	0.5A, 200V, 0.01A	B-23	TAG201-100, TAG202A-100, T2302B, T2302PB		
T2304D	Triac	0.5A, 400V, 0.01A	B-23	TAG201-400, TAG202A-400, T2302D, T2302PD		
T2305B	Triac	0.5A, 200V, 0.04A	B-23	TAG200-200, TAG208-200, T2303B, T2302PB		
T2305D	Triac	0.5A, 400V, 0.04A	B-23	TAG200-400, TAG208-400, T2303D, T2302PD		
T2306A...N	Triac	=T2300A...N: 0.045A	B-23	TAG220... , TAG225... , TAG231... , TIC201...		
T2310A...N	Triac	=T2300A...N: 1.9A	B-62	T2300... , T2300P... , T2320... , Z0402...	 图 B-23 图 B-89	
T2311A...N	Triac	=T2301A...N: 1.9A	B-62	T2301... , T2301P... , T2327... , Z0405...		
T2312A...N	Triac	=T2302A...N: 1.9A	B-62	T2302... , T2302P... , T2322... , Z0409...		
T2313A...M	Triac	=T2303A...M: 1.9A	B-62	SC136A, T2303... , T2323... , TAG231... , Z0410...		
T2316A...N	Triac	=T2300A...N: 1.9A, 0.045A	B-62	TAG220... , TAG231... , TIC201...	 图 B-98 图 B-6	
T2320A	RCA	Triac	B-89	L2004F31, T2300PB, Z0402B		
T2320B	RCA	Triac	B-89	L2004F31, T2300PB, Z0402B		
T2320C		Triac	B-98	T2300PC, Z0402D		
T2320D	RCA	Triac	B-89	L4004F31, T2300PD, Z0402D		
T2320E	RCA	Triac	B-89	L4004F31, T2300PE, Z0402M		
T2320F	RCA	Triac	B-89	L2004F31, T2300PF, Z0402B		
T2320M		Triac	B-98	T2300PM, Z0402M		
T2320N		Triac	B-98	T2300PN, Z0402N		
T2322A	RCA	SCR-D	B-6	L2004F71, TAG232-100, T2302PA, T2322A, Z0409B		

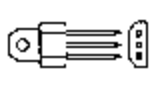
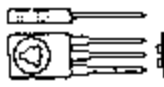

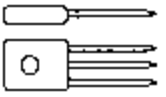
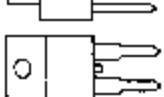
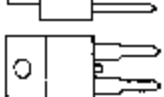
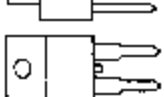
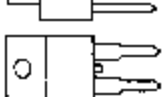
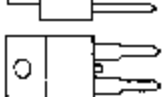
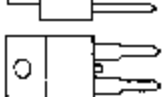
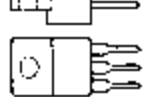
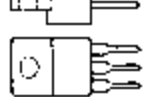
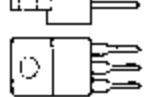
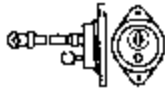
器件型号 Element type	厂名 Manufacturers	材料用途参数 Material Purpose Parameter	图号 Figure	国内外相似替换器件型号 Replace of similar type	备注 Notes	外形参考图 Reference shape
T2322B	RCA	SCR-D 2.5A, 200V, 0.01A, 2.2V	B-6	L2004F71, TAG232-200, T2302PB, T2322B, Z0409B		 图 B-6
T2322C	RCA	SCR-D 2.5A, 300V, 0.01A, 2.2V	B-6	L4004F71, TAG232-300, T2302PC, TXC18G, T2322B, Z0409B		
T2322D	RCA	SCR-D 2.5A, 400V, 0.01A, 2.2V	B-6	L4004F71, TAG232-400, TXC18G40, T2302PD, Z0409D		 图 B-96
T2322E	RCA	SCR-D 2.5A, 500V, 0.01A, 2.2V	B-6	TAG232-500, TXC18G-50, T2302PE, Z0409M		
T2322F	RCA	SCR-D 2.5A, 50V, 0.01A, 2.2V	B-6	L2004F71, TAG232-500, T2302PF		 图 B-23
T2322M	HCA	SCR-D 2.5A, 600V, 0.01A, 2.2V	B-6	TAG232 800, TXC18G-60, T2302PM, Z0409M		
T2322N		SCR-D 2.5A, 800V, 0.01A, 2.2V	B-98	TAG232-800, TXC18G-80, T2302PN, Z0409M		
T2323A	RCA	SCR-D 2.5A, 100V, 0.04A, 2.2V	B-6	L2004F91, TAG220-100, TAG225-100, TAG231-100, Z0410B		
T2323B	RCA	SCR-D 2.5A, 200V, 0.04A, 2.2V	B-6	L2004F91, TAG220-200, TAG225-200, TAG231-200, Z0410B		
T2323C	RCA	SCR-D 2.5A, 300V, 0.04A, 2.2V	B-6	L4004F91, TAG220-300, TAG225-300, TAG231-300, Z0410D		
T2323D	RCA	SCR-D 2.5A, 400V, 0.025A, 2.2V	B-6	L4004F91, TAG220-400, TAG225-400, TAG231-400, Z0410D		
T2323E	RCA	SCR-D 2.5A, 500V, 0.04A, 2.2V	B-6	TAG220-500, TAG225-500, TAG231-500, Z0410M		
T2323F	RCA	SCR-D 2.5A, 50V, 0.04A, 2.2V	B-6	L2004F91, TAG220-100, TAG225-100, TAG231-100, Z0410M		
T2323M	RCA	SCR-D 2.5A, 600V, 0.04A, 0.03A	B-23	TAG220-600, TAG225-600, TAG231-600, Z0410M		
T2323N	RCA	SCR-D 2.5A, 800V, 0.04A, 0.03A	B-23	TAG220-600, TAG225-600, TAG231-600, Z0410M		
T2327A	RCA	Triac 2.5A, 100V, 0.005A, 2.2V	B-6	L2004F51, TAG222-100, TAG233-100, Z0405B		
T2327B	RCA	Triac 2.5A, 200V, 0.005A, 2.2V	B-6	L2004F51, TAG222-200, TAG233-200, Z0405B		
T2327C	RCA	Triac 2.5A, 300V, 0.005A, 2.2V	B-6	L4004F51, TAG222-300, TAG233-300, Z0405D		
T2327D	RCA	Triac 2.5A, 400V, 0.005A, 2.2V	B-6	L4004F51, TAG222-400, TAG233-40, Z0405D		

器件型号 Element type	厂名 Manufacturers	材料用途参数 Material Purpose Parameter	图号 Figure	国内外相似替换器件型号 Replace of similar type	备注 Notes	外形参考图 Reference shape
T2327E	RCA	Triac 2.5A, 500V, 0.005A, 2.2V	B-6	TAG222-500, TAG233-500, TXC18D-50, ZD405M		 图 B-6
T2327F	RCA	Triac 2.5A, 50V, 0.005A, 2.2V	B-6	L2004F51, TAG222-100, TAG233-50, TXC18D-60		
T2500A		Triac 6A, 100V	B-9			 图 B-9
T2500B		Triac 6A, 200V, 0.06A	B-9	MAC222A-4, TAG224-200, TXC10H40M		
T2500BFP		Triac 6A, 250V	B-9			 图 B-9
T2500C		Triac 6A, 300V	B-9	MAC222A-6, Q4006L4, SK3659, SK56006, TAG220-400, TAG224-400, TXC10H40M		
T2500D	ASL, MOT	Triac 6A, 400V, 0.01A, 2.5V	B-91			 图 B-9
T2500DFP		Triac 6A, 450V	B-9			
T2500E		Triac 6A, 500V	B-9			 图 B-9
T2500M	MOT	Triac 6A, 600V, 0.06A, 2.5V	B-91	MAC222A-8, Q6006L4, TAG224-600, TXC10H60M		
T2500MFP		Triac 6A, 650V	B-91			 图 B-9
T2500N	MOT	Triac 6A, 800V, 0.06A, 2.5V	B-91	MAC222A-10, TAG224-800, TXC10H60M		
T2500NFP		Triac 6A, 850V	B-91			 图 B-9
T2500S		Triac 6A, 1kV	B-9			
T2506B	RCA	SCR-D 6A, 200V, 0.045A, 2.5V	B-91	MAC222-4, TIC226B, TW7N200		 图 B-11
T2506C		6A, 300V, 0.025A, 2.5V	B-11	MAC222-5, TIC226C, TW7N300		
T2506D	RCA	6A, 400V, 0.045A, 2.5V	B-91	MAC222-6, TIC226D, TW7N400, TXC10K40M		 图 B-11
T2506E		6A, 500V, 0.025A, 2.5V	B-11	MAC222-7, TIC226E, TW7N500, TXC10K50M		
T2506M		6A, 600V, 0.045A, 2.5V	B-11	MAC222-8, TIC226M, TW7N600, TXC10K60M		 图 B-11
T2506N		6A, 800V, 0.045A, 2.5V	B-11	MAC222-10, TIC226N, TW7N800, TXC10K80M		
T2512BH	TAG	SCR-D 25A, 200V, 0.05A, 2.5V	B-91	MCA223A4		 图 D-16
T2512BK	TAG	=T2512BH	D-16	TAG740-200, TAG741-200		
T2512DH	TAG	SCR-D 25A, 400V, 0.05A, 2.5V	B-91	MCA223A6		
T2512DK	TAG	=T2512DH	D-16	TAG740-400, TAG741-400		

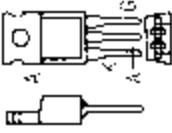

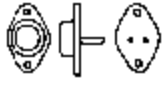

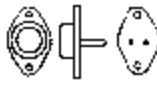
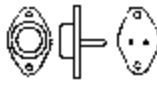
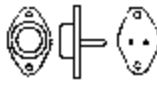
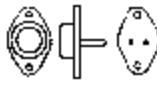
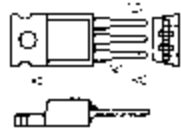
器件型号 Element type	厂名 Manufacturers	材料用途参数 Material Purpose Parameter	图号 Figure	国内外相似替换器件型号 Replace of similar type	备注 Notes	外形参考图 Reference shape
T2512MH	TAG	SCR-D 25A, 600V, 0.05A, 2.5V	B-91	MCA223A8		 图 B-91
T2512MK	TAG	=T2512MH	D-16	TAG740-600, TAG741-600		
T2512NH	TAG	SCR-D 25A, 800V, 0.05A, 2.5V	B-91	MCA223A10		
T2512NK	TAG	=T2512NH	D-16	TAG740-800, TAG741-800		
T2512BKS		SCR-D 250A, 200V				
T2512DKS		SCR-D 250A, 400V				
T2512MKS		SCR-D 250A, 600V				
T2512NKS		SCR-D 250A, 800V				
T2513BH	TAG	SCR-D 25A, 200V, 0.05A, 2.5V	B-91	MCA223A4		 图 D-16
T2513BK	TAG	=T2513BH	D-16	TAG740 200, TAG741-200		
T2513BKS		SCR-D 250A, 200V	B-91	MCA223A6		
T2513DH	TAG	SCR-D 25A, 400V, 0.05A, 2.5V	D-16	TAG740-400, TAG741-400		
T2513DK	TAG	=T2513DH				
T2513DKS		SCR-D 250A, 400V				
T2513MH	TAG	SCR-D 25A, 600V, 0.05A, 2.5V	B-91	MCA223A8		 图 B-62
T2513MK	TAG	=T2513MH	D-16	TAG740-600, TAG741-600		
T2513MKS		SCR-D 250A, 600V	B-91	MCA223A10		
T2513NH	TAG	SCR-D 25A, 800V, 0.05A, 2.5V	D-16	TAG740-800, TAG741-800		
T2513NK	TAG	=T2513NH				
T2513NKS		Triac 250A, 800V				
T2606B		Triac 6A, 200V, 0.045A	B-62	MAC222-4, TW7N400, TXC10K40M		
T2606D		Triac 6A, 400V, 0.045A	B-62	MAC222-6, TW7N400, TXC10K40M		
T2606DF		Triac 6A, 450V, 0.045A	B-62	MAC222-7, TW7N600, TXC10K50M		
T2616DF		Triac =T2606DF	B-62	T2606DF		
T2700B		Triac 6A, 200V, 0.04A	D-9	Q2006L4, TAG220-200, TAG261-200, TAG266-200		 图 D-9
T2700D		Triac 6A, 400V, 0.04A	D-9	SK3507, TAG220-400, TAG261-400, TAG266-400		
T2700M		Triac 6A, 600V, 0.04A	D-9	TAG220-600, TAG261-600, TAG266-600		

器件型号 Element type	厂名 Manufacturers	材料用途参数 Material Purpose Parameter	图号 Figure	国内外相似替换器件型号 Replace of similar type	备注 Notes	外形参考图 Reference shape
T2700N		Triac 6A, 800V, 0.04A	D-9	TAG220-800, TAG261-800, TAG266-800		
T2706B...N		Triac =T2700B...N; 0.045A	D-9	SK3507, TAG220..., TAG225..., T2806..., T4706...		
T2710B...N		Triac =T2700B...N	D-9	T2700B...N		
T2716B...N		Triac =T2700B...N	D-9	T2706B...N		
T2800A	ASI, MOT	Triac 8A, 100V, 0.06A, 2.5V	B-91	BT137-500, MAC222A-3, TAG224-100		 图 B-91
T2800B	ASI, MOT	Triac 8A, 200V, 0.06A, 2.5V	B-91	Q2006L4, MAC222A-4, SK3658, SK56004, TAG225-200, IAG224-200, TIC226B, BT137/500		
T2800C	ASI, MOT	Triac 8A, 300V, 0.06A, 2.5V	B-91	BT137-500, MAC222A-5, Q4006L4, SK3659, SK56006, TAG224-300, TIC226D		
T2800D	ASI, MOT	Triac 8A, 400V, 0.06A, 2.5V	B-91	BT137-500, MAC222A-6, Q4006L4, SK3659, SK56006, TAG224-400, TAG225-400, TIC226D		
T2800E	ASI, MOT	Triac 8A, 500V, 0.06A, 2.5V	B-91	BT137-500, MAC222A-7, Q5006L4, SK3660, SK56008, TAG224-500, TAG225-500, TIC226E		
T2800F	ASI, MOT	Triac 8A, 50V, 0.06A, 2.5V	B-91	BT137-500, MAC222A-2, TAG224-100		
T2800M	ASI, MOT	Triac 8A, 600V, 0.06A, 2.5V	B-91	BT137-600, MAC222A-8, Q6006L4, SK3660, SK56006, TAG224-600, TAG225-600, TIC226M		
T2800N		Triac 8A, 800V, 0.06A, 0.03A	B-11	BT137-800, MAC222A-10, TAG224-800		
T2801A	ASI	Triac 6A, 100V, 0.08A, 4V	B-91	BS7-02A, MAC216-4, SC141B		
T2801B	ASI, MOT	Triac 6A, 200V, 0.08A, 4V	B-91	BS7-02A, MAC216-4, Q4006L4, SC141B, SK3938, SK5633, TAG220-200, TIC226B		
T2801C	ASI	Triac 6A, 300V, 0.08A, 4V	B-91	BS7-04A, MAC216-6, Q4006L4, SC141D		
T2801D	ASI, MOT	Triac 6A, 400V, 0.08A, 4V	B-91	BS7-04A, MAC216-6, SC141D, Q4006L4, SK3933, SK5635, TAG220-400, TIC226D		
T2801DF		6A, 450V, 0.08A, 0.1A	B-11	BS7-05A, MAC216-7, SC141E		

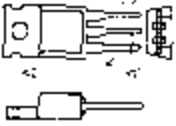
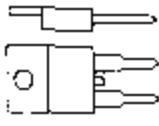

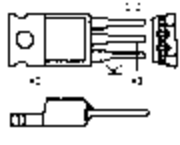
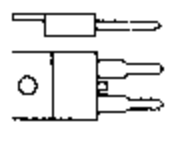
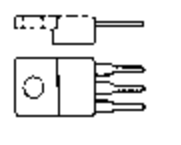
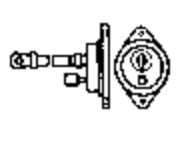
器件型号 Element type	厂名 Manufacturers	材料用途参数 Material Purpose Parameter	图号 Figure	国内外相似替换器件型号 Replace of similar type	备注 Notes	外形参考图 Reference shape
T2801E	ASI, MOT	6A, 500V, 0.08A, 4V	B-91	BS7-05A, MAC216-7, Q5006L4, SK3939, SK5636, SC141E, TAG220-500, TIC226E		 图 B-91
T2801F	ASI	6A, 50V, 0.08A, 4V	B-91	BS7-02A, MAC216-4, SC141B		
T2801M	ASI, MOT	6A, 600V, 0.08A, 4V	B-91	BS7-06A, MAC216-8, SC141M		
T2801N		6A, 800V	B-9	Y2801N		
T2801S		6A, 1kV	B-9			
T2802A	ASI, RCA	8A, 100V, 0.05A, 2.5V	B-91	MAC222-4, Q2008L5, SK3938, SK5633, TAG224-200, TIC226B, T2802B		
T2802B	ASI, MOT	8A, 200V, 0.05A, 2.5V	B-91	SK3533, SK5635, TIC226D, T2802C, Q4008L5		
T2802C	ASI, MOT	8A, 300V, 0.05A, 2.5V	B-91			
T2802D	ASI, MOT	8A, 400V, 0.05A, 2.5V	B-91	MAC222-6, Q4008L5, SK3533, SK5635, T2802D, TAG224-400, TIC226D, TXD10K/L40		 图 B-9
T2802E	ASI, MOT	8A, 500V, 0.05A, 2.5V	B-91	MAC222-7, Q5008L5, SK3939, SK5636, TAG224-500, TIC226E, TXD10K/L50, T2802E		
T2802F	ASI, MOT	8A, 50V, 0.05A, 2.5V	B-91	MAC222-2, TIC226F, T2802F		
T2802M	ASI, MOT	8A, 600V, 0.05A, 2.5V	B-91	MAC222-8, Q5008L5, TIC226M, TXD10K/L60, T2802M		
T2802N		8A, 600V, 0.05A, 2.5V	B-11	MAC222-8, TIC226M, TXD10K/L60		
T2805A	RCA	8A, 100V, 0.025A, 2.5V	B-91	QZ2008L, SK3648, SK56004, 2N6346A		
T2805B	RCA	8A, 200V, 0.025A, 2.5V	B-91	QZ008L4, SK3648, SK56004, TAG426-200		
T2805M	RCA	8A, 600V, 0.025A, 2.5V	B-91			
T2806A		8A, 100V, 0.045A, 1.5V		TAG225-100, TAG252-100, T2806N		
T2806B		8A, 200V, 0.045A	B-9	TAG225-200, IAG252-200, T2806B		
T2806C	RCA	8A, 300V, 0.045A, 1.5V	B-91	TAG225-300, TAG252-300, T2806C		
T2806D	RCA	8A, 400V, 0.045A, 1.5V	B-91	TAG225-400, TAG252-400, T2806D		
T2806E		8A, 500V, 0.045A, 1.5V	B-91	TAG225-500, TAG252-500		
T2806F		8A, 50V, 0.045A, 1.5V	B-91	TAG225-100, TAG252-100		

器件型号 Element type	厂名 Manufacturers	材料用途参数 Material Purpose Parameter	图号 Figure	国内外相似替换器件型号 Replace of similar type	备注 Notes	外形参考图 Reference shape
T2806M	RCA	SCR-D 8A, 600V, 0.045A, 1.5V	B-91	TAG225-600, TAG252-600, T2806M		 图 B-91
T2806N		SCR-D 8A, 800V, 0.045A	B-9	TAG225-800, TAG252-800, T2806N		
T2850A	RCA	Triac 8A, 100V, 0.06A	B-91	BT137-500, Q2008L4, SK3658/56004, MAC222A-3, TAG224-100		 图 B-9
T2850B	RCA	Triac 8A, 200V, 0.06A	B-91	BT137-500, MAC222A-4, Q2008L4, SK3658, SK56004, TAG224-200, TAG425-200, 2N6346A		
T2850D		Triac 8A, 400V, 0.06A	B-11	BT137-500, MAC222A-6, TAG224-400, 2N6347A		 图 B-11
T2850E		Triac 8A, 500V, 0.06A	B-11	BT137-500, MAC222A-7, TAG224-500, T2850E		
T2850F		Triac 8A, 50V, 0.06A	B-11	BT137-500, MAC222A-2, TAG224-100		 图 D-16
T2850M	RCA	Triac 8A, 600V, 0.06A	B-91	BT137-600, MAC222A-8, TAG224-600		
T2851B		Triac 8A, 200V, 0.08A	B-9	TAG425-200, TAG451-200, TAG456-200, T2801B		
T2851C		Triac 8A, 300V, 0.08A	B-9	TAG425-400, TAG451-400, TAG456-400, T2801C		
T2851D		Triac 8A, 400V, 0.08A	B-9	TAG425-100, TAG451-100, TAG456-100, T2801D		
T2851DF		Triac 8A, 450V, 0.08A	B-11	TAG425-500, TAG451-600, TAG456-600		
T2851E		Triac 8A, 500V, 0.08A	B-9	TAG425-500, TAG451-600, TAG456-600, T2801E		
T2851M		Triac 8A, 600V, 0.08A	B-11	TAG425-600, TAG451-600, TAG456-600		
T2856A...M		Triac =T2850A...M		TAG426..., TAG452..., TAG457...		
T4012BK	TAG	Triac 40A, 200V, 0.05A, 2.5V	D-16			
T4012BKS		Triac 300A, 200V				
T4012DK	TAG	Triac 40A, 400V, 0.05A, 2.5V	D-16			
T4012DKS		Triac 300A, 400V				
T4012MK	TAG	Triac 40A, 600V, 0.05A, 2.5V	D-16			
T4012MKS		Triac 300A, 600V				
T4012NK	TAG	Triac 40A, 800V, 0.05A, 2.5V	D-16			
T4012NKS		Triac 300A, 800V				

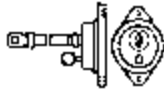
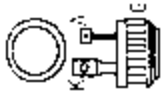
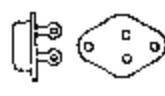
器件型号 Element type	厂名 Manufacturers	材料用途参数 Material Purpose Parameter	图号 Figure	国内外相似替换器件型号 Replace of similar type	备注 Notes	外形参考图 Reference shape
T4013BK	TAG	40A, 200V, 0.05A, 2.5V	D-16			
T4013BKS		SCR-D 300A, 200V				图 D-16
T4013DK	TAG	40A, 400V, 0.05A, 2.5V	D-16			
T4013DKS		SCR-D 300A, 400V				
T4013MK	TAG	40A, 600V, 0.05A, 2.5V	D-16			
T4013MKS		SCR-D 300A, 600V				
T4013NK	TAG	40A, 800V, 0.05A, 2.5V	D-16			
T4013NKS		SCR-D 300A, 800V				
T4100A		SCR-D 15A, 100V	C-85	2N5571		
T4100B		SCR-D 15A, 200V	C-85	2N5571		
T4100C		SCR-D 15A, 300V	C-85	2N5572		
T4100D		SCR-D 15A, 400V	C-85	2N5572		图 C-85
T4100E	RCA	SCR-D 15A, 500V, 0.05A, 2.5V	C-85	T6400E, 2N5443, 2N6159		
T4100F	RCA	SCR-D 15A, 50V, 0.05A, 2.5V	C-85	T6400F, 2N5441, 2N5442, 2N5443, 2N5571, 2N6157, 2N6158, 2N6159		
T4100M	MOT, RCA	SCR-D 15A, 600V, 0.05A, 2.5V	C-85	T4100M, T6400M, 2N5443, 2N6159		
T4101A		SCR-D 10A, 100V	C-85	2N5567		
T4101B		SCR-D 10A, 200V	C-85	2N5567		
T4101C		SCR-D 10A, 300V	C-85	2N5568		
T4101D		SCR-D 10A, 400V	C-85	2N5568		
T4101E	RCA	SCR-D 10A, 500V, 0.025A, 2.5V	C-85	2N6159		
T4101F	RCA	SCR-D 10A, 50V, 0.025A, 2.5V	E-14	2N5567, 2N5568, 2N6159		
T4101M	MOT, RCA	SCR-D 10A, 600V, 0.05A, 2.5V	C-85	Q6010		
T4103B		Triac 10A, 200V, 0.08A	D-14	T6400B, 2N5441, 2N5442, 2N5443, 2N6157, 2N6158, 2N6159		
T4103D		Triac 15A, 400V, 0.08A	D-14	T6400D, 2N5442, 2N5443, 2N6158, 2N6159		图 D-14
T4103E		Triac 15A, 500V, 0.08A	D-14	T6400E, 2N5443, 2N6159		

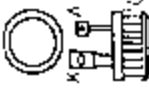
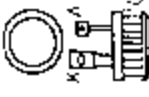
器件型号 Element type	厂名 Manufacturers	材料用途参数 Material Purpose Parameter	图号 Figure	国内外相似替换器件型号 Replace of similar type	备注 Notes	外形参考图 Reference shape
T4103M		Triac 15A, 600V, 0.08A	D-14	T6400M, 2N5443, 2N6159		 图 D-14
T4104B...M		Triac =T4103B...M: 10A	D-14	T4100..., T6400..., 2N6157...2N6159		
T4105B...M		Triac =T4103B...M: 6A	D-14	T4100..., T6400..., 2N6157...2N6159		
T4106B	RCA	SCR-D 15A, 200V, 0.045A, 1.5V	C-85	Q2015G, 2N5571		 图 C-85
T4106D	RCA	SCR-D 15A, 400V, 0.045A, 1.5V	C-85	Q4015G, 2N5572		
T4106E	RCA	SCR-D 15A, 500V, 0.05A, 1.5V	D-14	T4101E, T6406E, T6407E		
T4106F	RCA	SCR-D 15A, 50V, 0.045A, 1.5V	D-14	T4101F, T6406F, T6407F		
T4106M	RCA	SCR-D 15A, 600V, 0.05A, 2.5V	C-85	Q6015G, T4100M, T4101M, T6406M, T6407M		
T4107B	RCA	SCR-D 10A, 200V	C-85	2N5567		
T4107D	RCA	SCR-D 10A, 400V	C-85	2N5568		
T4107E	RCA	SCR-D 10A, 500V, 0.045A	D-14	T4101B, T6406B, T6407B		
T4107F	RCA	SCR-D 10A, 50V, 0.045A	D-14	T4101D, T6406D, T6407D		
T4107M	RCA	SCR-D 10A, 600V, 0.045A	C-85	T4101M, T4101M, T6406M, T6407M		
T4110A		SCR-D 15A, 100V	C-85	MAC5573		 图 C-85
T4110B		SCR-D 15A, 200V	C-85	MAC5573		
T4110C		SCR-D 15A, 300V	C-85	MAC5574		
T4110D		SCR-D 15A, 400V	C-85	MAC5574		
T4110E	ASI, RCA	SCR-D 15A, 500V, 0.05A, 2.5V	F-21	T6410E, T6411E, 2N6160, 2N6161, 2N6162, 2N6159		
T4110F	RCA	SCR-D 15A, 50V, 0.05A, 2.5V	F-21	MAC5573, T6410F, T6411F, 2N6160, 2N6161		
T4110M	ASI, RCA	SCR-D 15A, 600V, 0.05A, 2.5V	F-21	Q6015H, MAC411DM, T6410M, T6411M, 2N6160		
T4111A		Triac 10A, 100V	C-85	MAC5569		
T4111B		Triac 10A, 200V	C-85	MAC5569		
T4111C		Triac 10A, 300V	C-85	MAC5570		
T4111D		Triac 10A, 400V	C-85	MAC5570		
T4111E	ASI, RCA	Inac 10A, 500V, 0.025A, 2.5V	F-21	2N6159		
T4111F	RCA	Triac 10A, 50V, 0.025A, 2.5V	F-21	MAC5569		
T4111M	ASI, RCA	Triac 10A, 600V, 0.025A, 2.5V	F-21	MAC411M, SK3520, SK5677		





器件型号 Element type	厂名 Manufacturers	材料用途参数 Material Purpose Parameter	图号 Figure	国内外相似替换器件型号 Replace of similar type	备注 Notes	外形参考图 Reference shape
T4113B...M		Triac =T4103B...M	F-55	T6411..., T6410..., 2N6160...2N6162		 图 F-55 图 F-48
T4114B...M		Triac =T4104B...M	F-55	T4110..., T6411..., 2N6160...2N6162		
T4115B...M		Triac =T4105B...M	F-55	T4110..., T6411..., 2N6160...2N6162		
T4116B	RCA	SCR-D 15A, 200V, 0.045A, 1.5V	F-48	SK3508, SK5675, Q2015H, 2N5573		 图 F-55 图 F-48
T4116D	RCA	SCR-D 15A, 400V, 0.045A, 1.5V	F-48	SK3508, SK5675, Q4015H, 2N5574		
T4116F		SCR-D 15A, 500V, 0.045A, 1.5V	F-55	T4111E, T4117E, T6417E		
T4116F		SCR-D 15A, 50V, 0.045A, 1.5V	F-55	T4111F, T4117F, T6417F		
T4116M	RCA	SCR-D 15A, 600V, 0.05A, 2.5V	F-21	Q6015H, T4110M, T4111M, T4117M, T6417M		
T4117B	RCA	SCR-D 10A, 200V, 0.045A, 1.5V	F-48	SK3508, SK5675, Q2015H, 2N5569		
T4117D	RCA	SCR-D 10A, 400V, 0.045A, 1.5V	F-48	Q4015H, 2N5570		
T4117E		SCR-D 10A, 500V, 0.045A, 1.5V	F-55	T4111E, T4116E, T6417E		
T4117F		SCR-D 10A, 50V, 0.045A, 1.5V	F-55	T4111F, T4116F, T6417F		
T4117M	RCA	SCR-D 10A, 600V, 2.5V	F-48	Q6015H, T4111M, T4111M, T4116M, T6417M		
T4120A		SCR-D 15A, 100V	F-57	MAC4120B		 图 F-21 图 F-57
T4120B	ASI, MOT	SCR-D 15A, 200V, 0.05A, 2.5V	F-49	MAC4120B, Q2015B		
T4120C		SCR-D 15A, 300V		MAC4120D		
T4120D	ASI, MOT	SCR-D 15A, 400V, 0.05A, 2.5V	F-49	MAC4120D, Q4015B		
T4120E	ASI, MOT	SCR-D 15A, 500V, 0.05A, 2.5V	F-49	MAC4120M, T6420E, T6421E, 2N6163, 2N6164, 2N6165		
T4120F	RCA	SCR-D 15A, 50V, 0.05A, 2.5V	F-49	MAC4120B, T6420F, T6421F, 2N6163, 2N6164, 2N6165		
T4120M	ASI, MOT	SCR-D 15A, 600V, 0.05A, 2.5V	F-49	MAC4120M, Q6015B, T6420M, T6421M, 2N6163, 2N6164, 2N6165		
T4120N		SCR-D 15A, 800V	F-57	MAC4120N		
T4120S		SCR-D 15A, 1kV	F-57	MAC4120N		
T4121A		SCR-D 10A, 100V	C-85	MAC4121B		
T4121B	ASI, MOT	SCR-D 10A, 200V, 0.025A, 2.5V	F-49	MAC4121B, Q2010B		
T4121C		SCR-D 10A, 300V		MAC4121D		

图 F-49 图 C-85

器件型号 Element type	厂名 Manufacturers	材料用途参数 Material Purpose Parameter	图号 Figure	国内外相似替换器件型号 Replace of similar type	备注 Notes	外形参考图 Reference shape
T4121D	ASI, MOT	SCR-D 10A, 400V, 0.025A, 2.5V	F-49	MAC4121D, Q4010B		 图 F-49
T4121E	ASI, MOT	SCR-D 10A, 500V, 0.025A, 2.5V	F-49	MAC4121M		
T4121F	RCA	SCR-D 10A, 50V, 0.025A, 2.5V	F-49	MAC4121B		
T4121M	ASI, MOT	SCR-D 10A, 600V, 0.025A, 2.5V	F-49	MAC4121M, Q6010B		
T4121N		SCR-D 10A, 800V		MAC4121N		
T4121S		SCR-D 10A, 700V		MAC4121N		
T4126B	RCA	SCR-D 15A, 200V, 0.05A, 2.5V	F-49	Q2015B, T4120B		 图 E-8
T4126D	RCA	SCR-D 15A, 400V, 0.05A, 2.5V	F-49	Q4015B, T4120D		
T4126E		SCR-D 15A, 500V, 0.05A, 2.5V	E-8	T4121E, T4127E, T6426E, T6427E		
T4126F		SCR-D 15A, 50V, 0.05A, 2.5V	E-8	T4121F, T4127F, T6426F, T6427F		
T4126M	RCA	SCR-D 15A, 600V, 0.05A, 2.5V	F-49	Q6015B, T4120M, T4121M, T4127M, T6426M, T6427M		
T4127B		SCR-D 10A, 300V	C-85	T4121B		
T4127D		SCR-D 10A, 400V	C-85	T4121D		 图 C-85
T4127E		SCR-D 10A, 500V, 0.045A, 0.015A	E-8	T4121E, T4127F, T6426E, T6427E		
T4127F		SCR-D 10A, 50V, 0.045A, 0.015A	E-8	T4121F, T4127F, T6426F, T6427F		
T4127M		SCR-D 10A, 600V, 0.045A, 0.015A	C-85	T4121M, T4121M, T4127M, T6426M, T6427M		
T4700B	RCA	SCR-D 15A, 200V, 0.03A, 2.5V	D-9	BT139-500, MAC15A4, Q2015L5, TAG280-200		
T4700C		SCR-D 15A, 300V	B-9	MAC15A6		
T4700D	RCA	SCR-D 15A, 400V, 0.03A, 2.5V	D-9	BT139-500, MAC15A6, Q4015L5, TAG280-400		
T4700E	RCA	SCR-D 15A, 500V, 0.03A, 2.5V	D-9	BT139-500, MAC15A7, MAC15A-8, TAG280-600		
T4700F	RCA	SCR-D 15A, 50V, 0.03A, 2.5V	D-9	BT139-500, MAC15A2, TAG280-200		
T4700M		SCR-D 15A, 600V, 0.08A	B-9	BT139-600, MAC15A8, MAC15A10, TAG280-600		
T4700N		SCR-D 15A, 800V, 0.08A	B-9	BT139-800, MAC15A4, MAC15A10, TAG280-800		
T4706B		SCR-D 15A, 200V, 0.045A	B-9	MAC15A4, MAC15B, TIC246B, TXE10L20		 图 B-9
T4706D		SCR-D 15A, 400V, 0.045A	B-9	MAC15A6, MAC15D, TIC246D, TXE10L40		



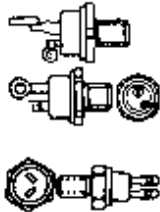
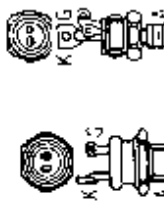
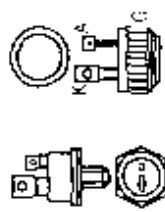
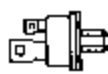

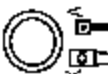
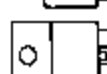
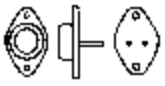
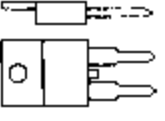
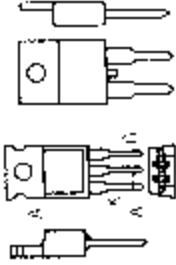
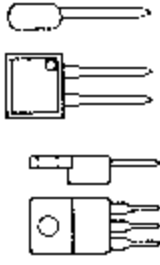
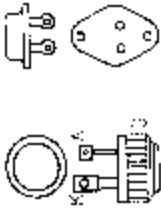
器件型号 Element type	厂名 Manufacturers	材料用途参数 Material Purpose Parameter	图号 Figure	国内外相似替换器件型号 Replace of similar type	备注 Notes	外形参考图 Reference shape
T4706E	SCR-D	15A, 500V, 0.045A	D-9	MAC15A8, TIC246E, TXE10L50		 图 D-9
T4706F	SCR-D	15A, 50V, 0.045A	D-9	MAC15A4, TIC246F		
T4706M	SCR-D	15A, 600V, 0.045A	D-9	MAC15A8, TIC246M, IXE10L60		
T4706N	SCR-D	15A, 800V, 0.045A	D-9	MAC15A10, TIC246N, TXE10L80		
T50R1A10		MOD, 50A, 100V				
T50R1A20		MOD, 50A, 200V				
T50R1A40		MOD, 50A, 400V				
T50R1A60		MOD, 50A, 600V				
T50R1A80		MOD, 50A, 800V				
T50R1A100		MOD, 50A, 1kV				
T50R1A120		MOD, 50A, 1.2kV				
T6000A	SCR-D	15A, 100V	B-9	MAC15A4		 图 B-9
T6000B	RCA	SCR-D 16A, 200V, 0.08A	B-91	BT139-500, MAC15A4, Q2015L5, SK3938, SK5633, TAG280-200		
T6000C	RCA	SCR-D 16A, 300V, 0.08A	B-91	BT139-500, MAC15A6, Q4015L5, SK3933, SK5635, TAG280-400		
T6000D	RCA	SCR-D 16A, 400V, 0.08A	B-91	BT139-500, MAC15A6, Q4015L5, SK3933, SK5635, TAG280-400, TAG280-400		
T6000E	RCA	SCR-D 16A, 500V, 0.08A	B-91	BT139-500, MAC15A8, Q5015L5, SK3939, SK5636, TAG280-600		
T6000F	RCA	SCR-D 16A, 50V, 0.08A	B-91	BT139-500, MAC15A2, MAC15A4, SK3937, SK5632, TAG280-200		
T6000M	RCA	SCR-D 16A, 600V, 0.08A	B-91	BT139-600, MAC15A4, MAC15A8, Q6015L5, TAG280-600		
T6000N	RCA	SCR-D 16A, 800V, 0.08A	B-9	BT139-800, MAC15A10, TAG280-800		
T6001A	SCR-D	15A, 100V	B-9	MAC15A4		
T6001B	SCR-D	16A, 200V, 0.08A, 3V	B-91	BT139-500, MAC15A4, Q2015L5, TAG280-200		



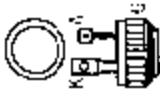
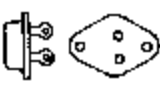



器件型号 Element type	厂名 Manufacturers	材料用途参数 Material Purpose Parameter	图号 Figure	国内外相似替换器件型号 Replace of similar type	备注 Notes	外形参考图 Reference shape
T6001C	RCA	SCR-D 16A, 300V, 0.08A, 3V	B-91	MAC15A, Q4015L6		 图 B-91 图 B-9
T6001D	RCA	SCR-D 16A, 400V, 0.08A, 3V	B-91	BT139-500, MAC15A6, Q4015L6, TAG280-400		
T6001E	RCA	SCR-D 16A, 500V, 0.08A, 3V	B-91	BT139-500, MAC15A8, Q5015L6, TAG280-600		
T6001F	RCA	SCR-D 16A, 50V, 0.08A, 3V	B-91	BT139-500, MAC15A4, TAG280-200		
T6001M	RCA	SCR-D 16A, 600V, 0.08A, 3V	B-91	BT139-600, MAC15A8, Q6015L6, TAG280-600		
T6001N	RCA	SCR-D 15A, 800V, 0.08A, 3V	B-9	BT139-600, MAC15A10, TAG280-600		
T6006A		SCR-D 15A, 100V	B-9	MAC15A4		 图 B-11 图 B-2
T6006B	RCA	SCR-D 16A, 200V, 0.045A, 1.5V	B-91	MAC15A4, Q2015L5, SK3938, SK5633, TIC246B		
T6006C	RCA	SCR-D 16A, 300V, 0.045A, 1.5V	B-91	MAC15A6, Q4015L5, SK3533, SK5635, TIC246C		
T6006D	RCA	SCR-D 16A, 400V, 0.045A, 1.5V	B-91	MAC15A6, Q4015L5, SK3533, SK5635, TIC246D		
T6006E	RCA	SCR-D 16A, 500V, 0.045A, 1.5V	B-91	MAC15A8, Q5015L5, SK3938, SK5636, TIC246E		
T6006F		SCR-D 15A, 200V, 0.045A	B-11	MAC15A4, TIC246B		
T6006M	RCA	SCR-D 16A, 600V, 0.045A, 1.5V	B-91	MAC15A8, Q6015L5, TIC246M		
T6006N		SCR-D 16A, 800V, 0.045A	B-11	MAC15A10, TIC246N		
T6260B		SCR-D 25A, 200V, 0.08A	B-2	MAC525A4, TAG725-200, TAG726-200		
T6260C		SCR-D 25A, 300V, 0.08A	B-2	MAC525A5, TAG725-400, TAG726-400		
T6260D		SCR-D 25A, 400V, 0.08A	B-2	MAC525A6, TAG725-400, TAG726-400		
T6260E		SCR-D 25A, 500V, 0.08A	B-2	MAC525A7, TAG725-600, TAG726-600		
T6260M		SCR-D 25A, 600V, 0.08A	B-2	MAC525A8, TAG725-600, TAG726-600		
T6261B...M		SCR-D T6260B...M	B-2	MAC25... , MAC50... , MAC525...		 图 C-85 图 D-14
T6400A		SCR-D 40A, 100V	C-85	MCA6400B		
T6400B	MOT	SCR D 40A, 200V, 0.08A, 2.5V	C-85	ECG5688, MCA6400B, 2N5441, 2N5442, 2N5443		
T6400C		SCR-D 40A, 300V	C-85	MCA6400D		
T6400D	MOT	SCR-D 40A, 400V, 0.08A, 2.5V	C-85	ECG5689, MCA6400D, 2N5442, 2N5443		
T6400E		SCR-D 40A, 500V, 0.08A	C-85	MCA6400M, 2N5443		
T6400F		SCR-D 40A, 50V, 0.08A	D-14	2N5441, 2N5442, 2N5443		



器件型号 Element type	厂名 Manufacturers	材料用途参数 Material Purpose Parameter	图号 Figure	国内外相似替换器件型号 Replace of similar type	备注 Notes	外形参考图 Reference shape	
T6400M	MOT	SCR-D 40A, 600V, 0.05A, 2.5V	C-85	ECG5690, MCA6400M, 2N5443		 图 C-85	
T6400N		SCR-D 40A, 800V	C-85	MCA6400N			
T6400S		SCR-D 40A, 1kV	C-85	MCA6400N			
T6401A		SCR-D 30A, 100V	C-85	MCA6401B			
T6401B	MOT, RCA	SCR-D 30A, 200V, 0.05A, 2.5V	C-85	ECG5688, MCA6401B, Q2025G			
T6401C		SCR-D 30A, 300V	C-85	MCA6401D			
T6401D	MOT, RCA	SCR-D 30A, 400V, 0.05A, 2.5V	C-85	ECG5689, MCA6401D, Q4025G			
T6401E	RCA	SCR-D 30A, 500V, 0.05A, 2.5V	C-85	MCA6401M			
T6401F	RCA	SCR-D 30A, 50V, 0.05A, 2.5V	C-85				
T6401M	MOT, RCA	SCR-D 30A, 600V, 0.05A, 2.5V	C-85	ECG5689, MCA6401M, Q6025G			
T6401N		SCR-D 30A, 800V, 0.08A	C-85	MCA6401N			
T6401S		SCR D 30A, 1kV	C-85	MCA6401N			
T6402E		SCR-D 40A, 400V	C-85	MCA5443			
T6402F		SCR-D 40A, 50V	C-85	MCA5441			
T6404B		SCR-D 40A, 200V, 0.12A	D-14	T6400B, 2N5441, 2N5442, 2N5443			 图 D-14
T6404D		SCR-D 40A, 400V, 0.12A	D-14	T6400D, 2N5442, 2N5443			
T6404E		SCR-D 40A, 500V, 0.12A	D-14	T6400E, 2N5443			
T6405B		SCR-D 25A, 200V, 0.12A, 0.09A	D-14	T6400B, T6404B, 2N5441, 2N5442, 2N5443			
T6405D		SCR-D 25A, 400V, 0.12A, 0.09A	D-14	T6400D, T6404D, 2N5441, 2N5442, 2N5443			
T6405E		SCR-D 25A, 500V, 0.12A, 0.09A	D-14	T6400E, T6404E, 2N5441, 2N5442, 2N5443			
T6406B	RCA	SCR-D 40A, 200V, 0.05A, 2.5V	C-85	2N5441			
T6406D	RCA	SCR-D 40A, 400V, 0.05A, 2.5V	C-85	2N5442			
T6406E	RCA	SCR-D 40A, 500V, 0.05A, 2.5V	C-85	2N5443			
T6406M	RCA	SCR-D 40A, 600V, 0.05A, 2.5V	C-85	2N5443			
T6407B	RCA	SCR-D 30A, 200V, 0.045A, 1.5V	C-85	MCA6401B, Q2025G, T6406B			
T6407D	RCA	SCR-D 30A, 400V, 0.045A, 1.5V	C-85	MCA6401D, Q4025G, T6406D			
T6407E	RCA	SCR-D 30A, 500V, 0.045A, 1.5V	C-85	MCA6401M, T6406E			
T6407M	RCA	SCR-D 30A, 600V, 0.045A, 1.5V	C-85	MCA6401M, Q4025G, T6406F			

器件型号 Element type	厂名 Manufacturers	材料用途参数 Material Purpose Parameter	图号 Figure	国内外相似替换器件型号 Replace of similar type	备注 Notes	外形参考图 Reference shape
T6410A		SCR-D 40A, 100V	F-47	T6411B		 图 F-47
T6410B	MOT	SCR-D 40A, 200V, 0.05A, 2.5V	F-47	2N5444, 2N5445, 2N5446		
T6410C		SCR-D 40A, 300V, 0.08A	F-47	T6410D, 2N5444, 2N5445, 2N5446		
T6410D	MOT	SCR-D 40A, 400V, 0.05A, 2.5V	F-47	2N5444, 2N5445, 2N5446		
T6410E		SCR-D 40A, 500V, 0.08A	F-47	T6410M, 2N5444, 2N5445, 2N5446		
T6410M	MOT	SCR-D 40A, 600V, 0.05A, 2.5V	F-47	SK3521, SK5686, 2N5444, 2N5445, 2N5446		
T6410N		SCR-D 40A, 800V	F-47			
T6410S		SCR-D 40A, 1kV	F-47	T6410N		
T6411A		SCR-D 40A, 100V	F-47	T6411B		
T6411B	MOT, RCA	SCR-D 30A, 200V, 0.05A, 2.5V	F-47	ECC5693, Q2025H, SK3552, SK5693, T6410B, 2N5444, 2N5445, 2N5446, 2N6160, 2N6161, 2N6162		
T6411C		SCR-D 40A, 300V, 0.05A	F-47	T6410C, 2N5444, 2N5445, 2N5446, 2N6160, 2N6161, 2N6162		
T6411D	MOT, RCA	SCR-D 30A, 400V, 0.05A, 2.5V	F-47	ECC5695, Q4025H, SK3509, SK5695, T6410D, 2N5444, 2N5445, 2N5446, 2N6160, 2N6161, 2N6162		
T6411E	RCA	SCR-D 40A, 500V, 0.08A	F-47	T6410E, 2N5444, 2N5445, 2N5446, 2N6160, 2N6161, 2N6162		
T6411M	RCA	SCR-D 40A, 600V, 0.045A, 0.08A	F-47	T6410M, 2N5444, 2N5445, 2N5446, 2N6160, 2N6161, 2N6162		
T6411N	MOT, RCA	SCR-D 40A, 800V	F-47			 图 F-55
T6411S		SCR-D 40A, 1kV	F-47			
T6412E		SCR-D 40A, 500V	F-47			
T6412F		SCR-D 40A, 50V	F-47			
T6414B...E		SCR-D =T6404B...E	F-55	T6410B, 2N5444, 2N5445, 2N5446		
T6415B...E		SCR-D =T6405B...E	F-55	T6411B, 2N5444, 2N5445, 2N5446, 2N6160		
T6416B...M		SCR-D =T6400B...M: 0.045A	F-55	2N6161, 2N6162		
T6417B...M		SCR-D =T6401B...M: 0.045A	F-55			



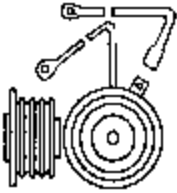

器件型号 Element type	厂名 Manufacturers	材料用途参数 Material Purpose Parameter	图号 Figure	国内外相似替换器件型号 Replace of similar type	备注 Notes	外形参考图 Reference shape
T6420A		SCR-D 40A, 100V	F-57	T6411B		 图 F-57
T6420B	MOT, RCA	SCR-D 40A, 200V, 0.05A, 2.5V	F-57	ECG56022, ECG5693, Q2025H, Q2040D, SK3652, SK5693		
T6420C		SCR-D 40A, 300V, 0.08A, 0.06A	F-57			 图 F-49
T6420D	MOT, RCA	SCR-D 40A, 400V, 0.05A, 2.5V	F-57	ECG56024, ECG5695, Q4025H, SK3509, SK3662, SK56024, SK5695,		
T6420E	RCA	SCR-D 40A, 500V, 0.05A, 2.5V	F-49	ECG56026		 图 F-57
T6420F	RCA	SCR-D 40A, 50V, 0.05A, 2.5V	F-49	ECG56022		
T6420M	MOT, RCA	SCR-D 40A, 600V, 0.05A, 2.5V	F-57	ECG56025, Q6040D		
T6420N	MOT	SCR-D 40A, 800V, 0.05A, 2.5V	F-57			
T6420S		SCR-D 40A, 1kV	F-57			
T6421A		SCR-D 30A, 100V	F-57			
T6421B	MOT, RCA	SCR-D 30A, 200V, 0.05A, 2.5V	F-57	EC56022, Q2025V, T6420B, 2N6163, 2N6164		
T6421C		SCR-D 30A, 300V, 0.08A	F-57	T6420C, 2N6163, 2N6164, 2N6165		
T6421D	MOT, RCA	SCR-D 30A, 400V, 0.05A, 2.5V	F-57	EC56024, Q4025V, T6420D, 2N6163, 2N6164		
T6421E	RCA	SCR-D 30A, 500V, 0.05A, 2.5V	F-49	ECG56026, T6420E, 2N6163, 2N6164, 2N6165		
T6421F	RCA	SCR-D 30A, 50V, 0.05A, 2.5V	F-49	ECG56022, T6420F, 2N6163, 2N6164, 2N6165		
T6421M	MOT, RCA	SCR-D 30A, 600V, 0.05A, 2.5V	F-57	ECG56026, Q6025V, T6420M, 2N6163, 2N6164, 2N6165		
T6421N		SCR-D 30A, 800V	F-57			 图 F-49
T6421S		SCR-D 30A, 1kV	F-57			
T6426B	RCA	SCR-D 40A, 200V, 0.05A, 2.5V	F-57	Q2040D		
T6426D	RCA	SCR-D 40A, 400V, 0.05A, 2.5V	F-49	Q4040D		 图 F-49
T6426M	RCA	SCR-D 40A, 600V, 0.05A, 2.5V	F-49	Q6040D		
T6427B	HCA	SCR-D 30A, 200V, 0.05A, 2.5V	F-49	T6426B		
T6427D	RCA	SCR-D 30A, 400V, 0.05A, 2.5V	F-49	Q4040D, T6426D		 图 F-49
T6427M	RCA	SCR-D 30A, 600V, 0.05A, 2.5V	F-49	Q6040D, T6426M		

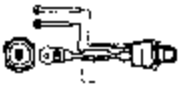
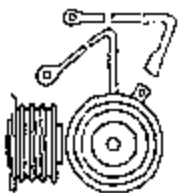

器件型号 Element type	厂名 Manufacturers	材料用途参数 Material Purpose Parameter	图号 Figure	国内外相似替换器件型号 Replace of similar type	备注 Notes	外形参考图 Reference shape
T5070140B4AB	WES	63A, 100V, 0.15A, 3V	C-74			 图 C-74
T5070140B4AQ	WES	63A, 100V, 0.15A, 3V	F-91			
T5070170B4AB	WES	110A, 100V, 0.15A, 3V	C-74			
T5070170B4AQ	WES	110A, 100V, 0.15A, 3V	F-91	ECG5371		
T5070180B4AB	WES	125A, 100V, 0.15A, 3V	C-74			
T5070180B4AQ	WES	125A, 100V, 0.15A, 3V	F-91			
T5070240B4AB	WES	63A, 200V, 0.15A, 3V	C-74			
T5070240B4AQ	WES	63A, 200V, 0.15A, 3V	F-91	ECG5371		
T5070270B4AB	WES	110A, 200V, 0.15A, 3V	C-74			
T5070270B4AQ	WES	110A, 200V, 0.15A, 3V	F-91	ECG5371		
T5070280B4AB	WES	125A, 200V, 0.15A, 3V	C-74			
T5070280B4AQ	WES	125A, 200V, 0.15A, 3V	F-91	ECG5371		
T5070340B4AB	WES	63A, 300V, 0.15A, 3V	C-74			
T5070340B4AQ	WES	63A, 300V, 0.15A, 3V	F-91	ECG5371		
T5070370B4AB	WES	110A, 300V, 0.15A, 3V	C-74			
T5070370B4AQ	WES	110A, 300V, 0.15A, 3V	F-91	ECG5371		
T5070380B4AB	WES	125A, 300V, 0.15A, 3V	C-74			
T5070380B4AQ	WES	125A, 300V, 0.15A, 3V	F-91	ECG5371		
T5070440B4AB	WES	63A, 400V, 0.15A, 3V	C-74			
T5070470B4AB	WES	110A, 400V, 0.15A, 3V	F-91	ECG5371		
T5070470B4AQ	WES	110A, 400V, 0.15A, 3V	C-74			
T5070480B4AB	WES	125A, 400V, 0.15A, 3V	F-91	ECG5371		
T5070540B4AB	WES	63A, 500V, 0.15A, 3V	C-74			
T5070540B4AQ	WES	63A, 500V, 0.15A, 3V	F-91	ECG5371		
T5070570B4AB	WES	110A, 500V, 0.15A, 3V	C-74			
T5070570B4AQ	WES	110A, 500V, 0.15A, 3V	F-91	ECG5371		
T5070580B4AB	WES	125A, 500V, 0.15A, 3V	C-74			

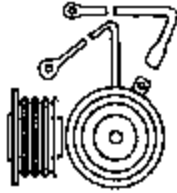

器件型号 Element type	厂名 Manufacturers	材料用途参数 Material Purpose Parameter	图号 Figure	国内外相似替换器型号 Replace of similar type	备注 Notes	外形参考图 Reference shape
T5070580B4AQ	WES	125A, 500V, 0.15A, 3V	F-91	ECG5371		
T5070640B4AB	WES	63A, 600V, 0.15A, 3V	C-74	ECG5371		
T5070640B4AQ	WES	63A, 600V, 0.15A, 3V	F-91	ECG5371		
T5070670B4AB	WES	110A, 600V, 0.15A, 3V	C-74	ECG5371		
T5070670B4AQ	WES	110A, 600V, 0.15A, 3V	F-91	ECG5371		
T5070680B4AB	WES	125A, 600V, 0.15A, 3V	C-74	ECG5371		
T5070680B4AQ	WES	125A, 600V, 0.15A, 3V	F-91	ECG5371		
T5070740B4AB	WES	63A, 700V, 0.15A, 3V	C-74	ECG5372		
T5070740B4AQ	WES	63A, 700V, 0.15A, 3V	F-91	ECG5372		
T5070770B4AB	WES	110A, 700V, 0.15A, 3V	C-74	ECG5372		
T5070770B4AQ	WES	110A, 700V, 0.15A, 3V	F-91	ECG5372		
T5070780B4AB	WES	125A, 700V, 0.15A, 3V	C-74	ECG5372		
T5070780B4AQ	WES	125A, 700V, 0.15A, 3V	F-91	ECG5372		
T5070840B4AB	WES	63A, 800V, 0.15A, 3V	C-74	ECG5372		
T5070840B4AQ	WES	63A, 800V, 0.15A, 3V	F-91	ECG5372		
T5070870B4AB	WES	110A, 800V, 0.15A, 3V	C-74	ECG5372		
T5070870B4AQ	WES	110A, 800V, 0.15A, 3V	F-91	ECG5372		
T5070880B4AB	WES	125A, 800V, 0.15A, 3V	C-74	ECG5372		
T5070880B4AQ	WES	125A, 800V, 0.15A, 3V	F-91	ECG5372		
T5070940B4AB	WES	63A, 900V, 0.15A, 3V	C-74	ECG5372		
T5070940B4AQ	WES	63A, 900V, 0.15A, 3V	F-91	ECG5372		
T5070970B4AB	WES	110A, 900V, 0.15A, 3V	C-74	ECG5372		
T5070970B4AQ	WES	110A, 900V, 0.15A, 3V	F-91	ECG5372		
T5070980B4AB	WES	125A, 900V, 0.15A, 3V	C-74	ECG5372		
T5070980B4AQ	WES	125A, 900V, 0.15A, 3V	F-91	ECG5372		
T5071040B4AB	WES	63A, 1kV, 0.15A, 3V	C-74	ECG5372		
T5071040B4AQ	WES	63A, 1kV, 0.15A, 3V	F-91	ECG5372		
T5071070B4AB	WES	110A, 1kV, 0.15A, 3V	C-74	ECG5372		
T5071070B4AQ	WES	110A, 1kV, 0.15A, 3V	F-91	ECG5372		

器件型号 Element type	厂名 Manufacturers	材料用途参数 Material Purpose Parameter	图号 Figure	国内外相似替换器件型号 Replace of similar type	备注 Notes	外形参考图 Reference shape	
T5071080B4AB	WES	125A, 1KV, 0.15A, 3V	C-74	ECG5372		 <p>图 C-74</p>	
T5071080B4AQ	WES	125A, 1KV, 0.15A, 3V	F-91	ECG5372			
T5071140B4AB	WES	63A, 1.1KV, 0.15A, 3V	C-74	ECG5372			
T5071140B4AQ	WES	63A, 1.1KV, 0.15A, 3V	F-91	ECG5372			
T5071170 B4AB	WES	110A, 1.1KV, 0.15A, 3V	C-74	ECG5372			
T5071170B4AQ	WES	110A, 1.1KV, 0.15A, 3V	F-91	ECG5372			
T5071180B4AB	WES	125A, 1.1KV, 0.15A, 3V	C-74	ECG5372			
T5071180B4AQ	WES	125A, 1.1KV, 0.15A, 3V	F-91	ECG5372			
T5071240B4AB	WES	63A, 1.2KV, 0.15A, 3V	C-74	ECG5372			
T5071240B4AQ	WES	63A, 1.2KV, 0.15A, 3V	F-91	ECG5372			
T5071270B4AB	WES	110A, 1.2KV, 0.15A, 3V	C-74	ECG5372			
T5071270B4AQ	WES	110A, 1.2KV, 0.15A, 3V	F-91	ECG5372			
T5071280B4AB	WES	125A, 1.2KV, 0.15A, 3V	C-74	ECG5372			
T5071280B4AQ	WES	125A, 1.2KV, 0.15A, 3V	F-91	ECG5372			
T6070113B4BT	WES	200A, 100V, 0.15A, 3V	F-91	ECG5374			 <p>图 F-91</p>
T6070115B4BT	WES	235A, 100V, 0.15A, 3V	F-91	ECG5374			
T6070118D4BT	WES	275A, 100V, 0.15A, 3V	F-91	ECG5374			
T6070213B4BT	WES	200A, 200V, 0.15A, 3V	F-91	ECG5374			
T6070215B4BT	WES	235A, 200V, 0.15A, 3V	F-91	ECG5374			
T6070218B4BT	WES	275A, 200V, 0.15A, 3V	F-91	ECG5374			
T6070313B4BT	WES	200A, 300V, 0.15A, 3V	F-91	ECG5374			
T6070315B4BT	WES	235A, 300V, 0.15A, 3V	F-91	ECG5374			
T6070318B4BT	WES	275A, 300V, 0.15A, 3V	F-91	ECG5374			
T6070413B4BT	WES	200A, 400V, 0.15A, 3V	F-91	ECG5374			
T6070415B4BT	WES	235A, 400V, 0.15A, 3V	F-91	ECG5374			
T6070418B4BT	WES	275A, 400V, 0.15A, 3V	F-91	ECG5374			
T6070513B4BT	WES	200A, 500V, 0.15A, 3V	F-91	ECG5374			
T6070515B4BT	WES	235A, 500V, 0.15A, 3V	F-91	ECG5374			

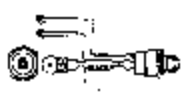

器件型号 Element type	厂名 Manufacturers	材料用途参数 Material Purpose Parameter	图号 Figure	国内外相似替换器件型号 Replace of similar type	备注 Notes	外形参考图 Reference shape
T6070518B4BT	WES	275A, 500V, 0.15A, 3V	F-91	ECG5374		 图 F-91
T6070613B4RT	WES	200A, 600V, 0.15A, 3V	F-91	ECG5374		
T6070615B4BT	WES	235A, 600V, 0.15A, 3V	F-91	ECG5374		
T6070618B4BT	WES	275A, 600V, 0.15A, 3V	F-91	ECG5375		
T6070713B4BT	WES	200A, 700V, 0.15A, 3V	F-91	ECG5375		
T6070715B4BT	WES	235A, 700V, 0.15A, 3V	F-91	ECG5375		
T6070718B4BT	WES	275A, 700V, 0.15A, 3V	F-91	ECG5375		
T6070813B4BT	WES	200A, 800V, 0.15A, 3V	F-91	ECG5375		
T6070815B4BT	WES	235A, 800V, 0.15A, 3V	F-91	ECG5375		
T6070818B4BT	WES	275A, 800V, 0.15A, 3V	F-91	ECG5375		
T6070913B4BT	WES	200A, 900V, 0.15A, 3V	F-91	ECG5375		
T6070915B4BT	WES	235A, 900V, 0.15A, 3V	F-91	ECG5375		
T6070918B4BT	WES	275A, 900V, 0.15A, 3V	F-91	ECG5375		
T6071013B4BT	WES	200A, 1kV, 0.15A, 3V	F-91	ECG5375		
T6071015B4BT	WES	235A, 1kV, 0.15A, 3V	F-91	ECG5375		
T6071018B4BT	WES	275A, 1kV, 0.15A, 3V	F-91	ECG5375		
T6071113B4BT	WES	200A, 1.1kV, 0.15A, 3V	F-91	ECG5375		
T6071115B4BT	WES	235A, 1.1kV, 0.15A, 3V	F-91	ECG5375		
T6071118B4BT	WES	275A, 1.1kV, 0.15A, 3V	F-91	ECG5375		
T6071213B4BT	WES	200A, 1.2kV, 0.15A, 3V	F-91	ECG5375		
T6071218B4BT	WES	275A, 1.2kV, 0.15A	F-91	ECG5375		
T7070128B4BY	WES	430A, 100V, 0.15A, 3V	F-71	ECG5377		 图 F-71
T7070133B4BY	WES	500A, 100V, 0.15A, 3V	F-71	ECG5377		
T7070228B4RY	WES	430A, 200V, 0.15A, 3V	F-71	ECG5377		
T7070233B4BY	WES	500A, 200V, 0.15A, 3V	F-71	ECG5377		
T7070328B4BY	WES	430A, 300V, 0.15A, 3V	F-71	ECG5377		
T7070333B4BY	WES	500A, 300V, 0.15A, 3V	F-71	ECG5377		
T7070428B4BY	WES	430A, 400V, 0.15A, 3V	F-71	ECG5377		
T7070433B4BY	WES	500A, 400V, 0.15A, 3V	F-71	ECG5377		

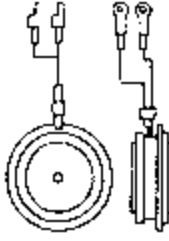
器件型号 Element type	厂名 Manufacturers	材料用途参数 Material Purpose Parameter	图号 Figure	国内外相似替换器件型号 Replace of similar type	备注 Notes	外形参考图 Reference shape
T7070528 B4BY	WES	430A, 500V, 0.15A, 3V	F-71	ECG5377		 图 F-71
T7070533 B4BY	WES	500A, 500V, 0.15A, 3V	F-71	ECG5377		
T7070625 B4BY	WES	400A, 600V, 0.15A, 3V	F-71	ECG5377		
T7070628 B4BY	WES	430A, 600V, 0.15A, 3V	F-71	ECG5377		
T7070630 B4BY	WES	475A, 600V, 0.15A, 3V	F-71	ECG5377		
T7070633 B4BY	WES	500A, 600V, 0.15A, 3V	F-71	ECG5378		
T7070725 B4BY	WES	400A, 700V, 0.15A, 3V	F-71	ECG5378		
T7070728 B4BY	WES	430A, 700V, 0.15A, 3V	F-71	ECG5378		
T7070730 B4BY	WES	475A, 700V, 0.15A, 3V	F-71	ECG5378		
T7070733 B4BY	WES	500A, 700V, 0.15A, 3V	F-71	ECG5378		
T7070825 B4BY	WES	400A, 800V, 0.15A, 3V	F-71	ECG5378		
T7070828 B4BY	WES	430A, 800V, 0.15A, 3V	F-71	ECG5378		
T7070830 B4BY	WES	475A, 800V, 0.15A, 3V	F-71	ECG5378		
T7070833 B4BY	WES	500A, 800V, 0.15A, 3V	F-71	ECG5378		
T7070925 B4BY	WES	400A, 900V, 0.15A, 3V	F-71	ECG5378		
T7070930 B4BY	WES	475A, 900V, 0.15A, 3V	F-71	ECG5378		
T7071025 B4BY	WES	400A, 1kV, 0.15A, 3V	F-71	ECG5378		
T7071030 B4BY	WES	475A, 1kV, 0.15A, 3V	F-71	ECG5378		
T7071130 B4BY	WES	475A, 1.1kV, 0.15A, 3V	F-71	ECG5378		
T7071225 B4BY	WES	400A, 1.2kV, 0.15A, 3V	F-71	ECG5378		
T7270135 B4DN	WES	550A, 100V, 0.15A, 3V	C-47	ECG5386		 图 C-47
T7270145 B4DN	WES	700A, 100V, 0.15A, 3V	C-47	ECG5386		
T7270148 B4DN	WES	750A, 100V, 0.15A, 3V	C-47	ECG5386		
T7270235 B4DN	WES	550A, 200V, 0.15A, 3V	C-47	ECG5386		
T7270240 B4DN	WES	625A, 200V, 0.15A, 3V	C-47	ECG5386		
T7270245 B4DN	WES	700A, 200V, 0.15A, 3V	C-47	ECG5386		
T7270246 B4DN	WES	750A, 200V, 0.15A, 3V	C-47	ECG5386		
T7270335 B4DN	WES	550A, 300V, 0.15A, 3V	C-47	ECG5386		
T7270340 B4DN	WES	625A, 300V, 0.15A, 3V	C-47	ECG5386		



器件型号 Element type	厂名 Manufacturers	材料用途参数 Material Purpose Parameter	图号 Figure	国内外相似替换器件型号 Replace of similar type	备注 Notes	外形参考图 Reference shape
T7270345 B4DN	WES	700A, 300V, 0.15A, 3V	C-47			
T7270348 B4DN	WES	750A, 300V, 0.15A, 3V	C-47			
T7270435 B4DN	WES	550A, 400V, 0.15A, 3V	C-47	ECG5386		
T7270440 B4DN	WES	625A, 400V, 0.15A, 3V	C-47			
T7270445 B4DN	WES	700A, 400V, 0.15A, 3V	C-47			
T7270448 B4DN	WES	750A, 400V, 0.15A, 3V	C-47			
T7270535 B4DN	WES	550A, 500V, 0.15A, 3V	C-47	ECG5386		
T7270540 B4DN	WES	625A, 500V, 0.15A, 3V	C-47			
T7270545 B4DN	WES	700A, 500V, 0.15A, 3V	C-47			
T7270548 B4DN	WES	750A, 500V, 0.15A, 3V	C-47			
T7270635 B4DN	WES	550A, 600V, 0.15A, 3V	C-47	ECG5386		
T7270640 B4DN	WES	625A, 600V, 0.15A, 3V	C-47			
T7270645 B4DN	WES	700A, 600V, 0.15A, 3V	C-47			
T7270648 B4DN	WES	750A, 600V, 0.15A, 3V	C-47			
T7270735 B4DN	WES	550A, 700V, 0.15A, 3V	C-47	ECG5387		
T7270740 B4DN	WES	625A, 700V, 0.15A, 3V	C-47			
T7270745 B4DN	WES	700A, 700V, 0.15A, 3V	C-47			
T7270748 B4DN	WES	750A, 700V, 0.15A, 3V	C-47			
T7270835 B4DN	WES	550A, 800V, 0.15A, 3V	C-47	ECG5387		
T7270840 B4DN	WES	625A, 800V, 0.15A, 3V	C-47			
T7270845 B4DN	WES	700A, 800V, 0.15A, 3V	C-47			
T7270848 B4DN	WES	750A, 800V, 0.15A, 3V	C-47			
T7270935 B4DN	WES	550A, 900V, 0.15A, 3V	C-47	ECG5387		
T7270945 B4DN	WES	700A, 900V, 0.15A, 3V	C-47			
T7271035 B4DN	WES	550A, 1kV, 0.15A, 3V	C-47	ECG5387		
T7271045 B4DN	WES	700A, 1kV, 0.15A, 3V	C-47			
T7271135 B4DN	WES	550A, 1.1kV, 0.15A, 3V	C-47	ECG5387		
T7271245 B4DN	WES	700A, 1.2kV, 0.15A, 3V	C-47			

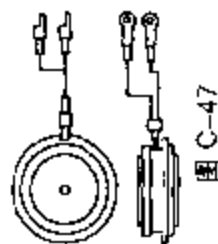

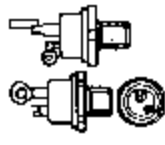
器件型号 Element type	厂名 Manufacturers	材料用途参数 Material Purpose Parameter	图号 Figure	国内外相似替换器件型号 Replace of similar type	备注 Notes	外形参考图 Reference shape
T40000160600, 1600	WES	25A, 50V, 0.08A, 3V	F-48			 图 F-48
T40000160800, 1800	WES	25A, 50V, 0.04A, 3V	F-48			
T40001100600, 1600	WES	16A, 100V, 0.08A, 3V	F-48			
T40001100800, 1800	WES	16A, 100V, 0.04A, 3V	F-48			
T40001160600, 1600	WES	25A, 100V, 0.08A, 3V	F-48			
T40001160800, 1800	WES	25A, 100V, 0.04A, 3V	F-48			
T40001220600, 1800	WES	35A, 100V, 0.04A, 3V	F-48			
T40001221600, 1800	WES	35A, 100V, 0.04A, 3V	F-48			
T40002100600, 1600	WES	16A, 200V, 0.08A, 3V	F-48			
T40002100800, 1800	WES	16A, 200V, 0.04A, 3V	F-48			
T40002160600, 1600	WES	25A, 200V, 0.08A, 3V	F-48			
T40002160800, 1800	WES	25A, 200V, 0.04A, 3V	F-48			
T40002220600, 1600	WES	35A, 200V, 0.08A, 3V	F-48			
T40002220800, 1800	WES	35A, 200V, 0.04A, 3V	F-48			

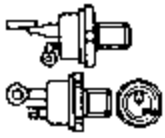

器件型号 Element type	厂名 Manufacturers	材料用途参数 Material Purpose Parameter	图号 Figure	国内外相似替换器件型号 Replace of similar type	备注 Notes	外形参考图 Reference shape
T40003100600, 1800	WES	16A, 300V, 0.08A, 3V	F-48			 图 F-48
T40003100800, 1800	WES	16A, 300V, 0.04A, 3V	F-48			
T400031600600, 1600	WES	25A, 300V, 0.08A, 3V	F-48			
T40003160800, 1800	WES	25A, 300V, 0.04A, 3V	F-48			
T40003220600, 1600	WES	35A, 300V, 0.08A, 3V	F-48			
T40003220800, 1800	WES	35A, 300V, 0.04A, 3V	F-48			
T40004100600, 1800	WES	16A, 400V, 0.08A, 3V	F-48			
T40004100800, 1800	WES	16A, 400V, 0.04A, 3V	F-48			
T40004160600, 1600	WES	25A, 400V, 0.08A, 3V	F-48			
T40004160800, 1800	WES	25A, 400V, 0.04A, 3V	F-48			
T40004220600, 1600	WES	35A, 400V, 0.08A, 3V	F-48			
T40004220800, 1800	WES	35A, 400V, 0.04A, 3V	F-48			
T40005100600, 1600	WES	16A, 500V, 0.08A, 3V	F-48			
T40005100800, 1800	WES	16A, 500V, 0.04A, 3V	F-48			

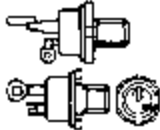
器件型号 Element type	厂名 Manufacturers	材料用途参数 Material Purpose Parameter	图号 Figure	国内外相似替换器件型号 Replace of similar type	备注 Notes	外形参考图 Reference shape
T40005160600, 1600	WES	25A, 500V, 0.08A, 3V	F-48			 <p>图 F-48</p>
T40005160800, 1800	WES	25A, 500V, 0.04A, 3V	F-48			
T400052200600, 1600	WES	35A, 500V, 0.08A, 3V	F-48			
T40005220800, 1800	WES	35A, 500V, 0.04A, 3V	F-48			
T40006100600, 1600	WES	16A, 600V, 0.08A, 3V	F-48			
T40006100800, 1800	WES	16A, 600V, 0.04A, 3V	F-48			
T40006160600, 1600	WES	25A, 600V, 0.08A, 3V	F-48			
T40006160800, 1800	WES	25A, 600V, 0.04A, 3V	F-48			
T40006220600, 1600	WES	35A, 600V, 0.08A, 3V	F-48			
T40006220800, 1800	WES	35A, 600V, 0.04A, 3V	F-48			
T40007100600, 1600	WES	16A, 700V, 0.08A, 3V	F-48			
T40007100800, 1800	WES	16A, 700V, 0.04A, 3V	F-48			
T40007160600, 1600	WES	25A, 700V, 0.08A, 3V	F-48			
T40007160800, 1800	WES	25A, 700V, 0.04A, 3V	F-48			

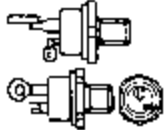

器件型号 Element type	厂名 Manufacturers	材料用途参数 Material Purpose Parameter	图号 Figure	国内外相似替换器件型号 Replace of similar type	备注 Notes	外形参考图 Reference shape
T40007220600, 1600	WES	35A, 700V, 0.08A, 3V	F-48			 图 F-48
T40007220800, 1800	WES	35A, 700V, 0.04A, 3V	F-48			
T40008100600, 1600	WES	16A, 800V, 0.08A, 3V	F-48			
T40008100800, 1800	WES	16A, 800V, 0.04A, 3V	F-48			
T40008160600, 1600	WES	25A, 800V, 0.08A, 3V	F-48			
T40008160800, 1800	WES	25A, 800V, 0.04A, 3V	F-48			
T40008220600, 1600	WES	35A, 800V, 0.08A, 3V	F-48			
T40008220800, 1800	WES	35A, 800V, 0.04A, 3V	F-48			
T40009100600, 1600	WES	16A, 900V, 0.08A, 3V	F-48			
T40009100800, 1800	WES	16A, 900V, 0.04A, 3V	F-48			
T40009160600, 1600	WES	25A, 900V, 0.08A, 3V	F-48			
T40009160800, 1800	WES	25A, 900V, 0.04A, 3V	F-48			
T40009220600, 1600	WES	35A, 900V, 0.08A, 3V	F-48			
T40009220800, 1800	WES	35A, 900V, 0.04A, 3V	F-48			

器件型号 Element type	厂名 Manufacturers	材料 用途 参数 Material Purpose Parameter	图号 Figure	国内外相似替换器件型号 Replace of similar type	备注 Notes	外形参考图 Reference shape
T40010100600, 1600	WES	16A, 1kV, 0.08A, 3V	F-48			
T40010100800, 1800	WES	16A, 1kV, 0.04A, 3V	F-48			
T40010160600, 1600	WES	25A, 1kV, 0.08A, 3V	F-48			
T40010160800, 1800	WES	25A, 1kV, 0.04A, 3V	F-48			
T40010220600, 1600	WES	35A, 1kV, 0.08A, 3V	F-48			
T40010220800, 1800	WES	35A, 1kV, 0.04A, 3V	F-48			
T4001100600, 1600	WES	16A, 1.1kV, 0.08A, 3V	F-48			
T4001100800, 1800	WES	16A, 1.1kV, 0.04A, 3V	F-48			
T4001160600, 1600	WES	25A, 1.1kV, 0.08A, 3V	F-48			
T4001160800, 1800	WES	25A, 1.1kV, 0.04A, 3V	F-48			
T4001220600, 1600	WES	35A, 1.1kV, 0.08A, 3V	F-48			
T4001220800, 1800	WES	35A, 1.1kV, 0.04A, 3V	F-48			
T40012100600, 1600	WES	16A, 1.2kV, 0.08A, 3V	F-48			
T40012100800, 1800	WES	16A, 1.2kV, 0.04A, 3V	F-48			



图 T-48





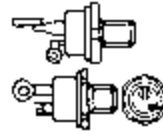

器件型号 Element type	厂名 Manufacturers	材料用途参数 Material Purpose Parameter	图号 Figure	国内外相似替换器型号 Replace of similar type	备注 Notes	外形参考图 Reference shape
T4001216 0600, 1600	WES	25A, 1.2kV, 0.08A, 3V	F-48			
T4001216 0800, 1800	WES	25A, 1.2kV, 0.04A, 3V	F-48			
T4001222 0600, 1600	WES	35A, 1.2kV, 0.08A, 3V	F-48			
T40012220800, 1800	WES	35A, 1.2kV, 0.04A, 3V	F-48			
T500074004AQ	WES	63A, 700V, 0.15A, 3V	F-91	ECG5574		
T500074005AB	WES	63A, 700V, 0.1A, 3V	B-74	ECG5579		图 F-48
T500074005AQ	WES	63A, 700V, 0.1A, 3V	F-91	ECG5574		
T500078004AB	WES	125A, 700V, 0.15A, 3V	B-74			
T500078004AQ	WES	125A, 700V, 0.15A, 3V	F-91			
T500078005AB	WES	125A, 700V, 0.1A, 3V	B-74	ECG5579		
T500078005AQ	WES	125A, 700V, 0.1A, 3V	F-91	ECG5574		
T500084004AB	WES	63A, 800V, 0.15A, 3V	B-74			
T500084004AQ	WES	63A, 800V, 0.15A, 3V	F-91			
T500084005AB	WES	63A, 800V, 0.1A, 3V	B-74			
T500084005AQ	WES	63A, 800V, 0.1A, 3V	F-91			
T500088004AB	WES	125A, 800V, 0.15A, 3V	B-74			
T500088004AQ	WES	125A, 800V, 0.15A, 3V	F-91			
T500088005AB	WES	125A, 800V, 0.1A, 3V	B-74			
T500088005AQ	WES	125A, 800V, 0.1A, 3V	F-91			
T500094004AB	WES	63A, 900V, 0.15A, 3V	B-74			
T500094004AQ	WES	63A, 900V, 0.15A, 3V	F-91			
T500094005AB	WES	63A, 900V, 0.1A, 3V	B-74			
T500094005AQ	WES	63A, 900V, 0.1A, 3V	F-91			
T500098004AB	WES	125A, 900V, 0.15A, 3V	B-74			
T500098004AQ	WES	125A, 900V, 0.15A, 3V	F-91			

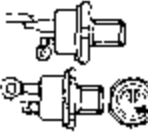
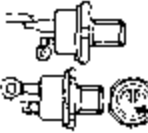

图 B-74

器件型号 Element type	厂名 Manufacturers	材料用途参数 Material Purpose Parameter	图号 Figure	国内外相似替换器件型号 Replace of similar type	备注 Notes	外形参考图 Reference shape
T500098005AB	WES	125A, 900V, 0.1A, 3V	B-74			 图 B-74
T500098005AQ	WES	125A, 900V, 0.1A, 3V	F-91			
T500104004AQ	WES	63A, 1KV, 0.15A, 3V	F-91			 图 F-91
T500104005AB	WES	63A, 1KV, 0.1A, 3V	B-74	ECG5579		
T500104005AQ	WES	63A, 1KV, 0.1A, 3V	F-91	ECG5574		
T500108004AB	WES	125A, 1KV, 0.15A, 3V	B-74			
T500108004AQ	WES	125A, 1KV, 0.15A, 3V	F-91	ECG5574		
T500108005AB	WES	125A, 1KV, 0.1A, 3V	B-74	ECG5579		
T500108005AQ	WES	125A, 1KV, 0.1A, 3V	F-91	ECG5574		
T500114004AB, 5AB	WES	63A, 1.1KV, 0.1A, 3V	B-74			
T500114004AQ, 5AQ	WES	63A, 1.1KV, 0.1A, 3V	F-91			
T500118004AB	WES	125A, 1.1KV, 0.15A, 3V	B-74			
T500118004AQ	WES	125A, 1.1KV, 0.15A, 3V	F-91	ECG5574		
T500118005AB	WES	125A, 1.1KV, 0.1A, 3V	B-74	ECG5579		
T500118005AQ	WES	125A, 1.1KV, 0.1A, 3V	F-91	ECG5574		
T500124004AB	WES	63A, 1.2KV, 0.15A, 3V	B-74			
T500124004AQ	WES	63A, 1.2KV, 0.15A, 3V	F-91	ECG5574		
T500128004AB	WES	125A, 1.2KV, 0.15A, 3V	B-74			
T500128004AQ	WES	125A, 1.2KV, 0.15A, 3V	F-91	ECG5574		
T500128005AB	WES	125A, 1.2KV, 0.1A, 3V	B-74	ECG5579		
T500128005AQ	WES	125A, 1.2KV, 0.1A, 3V	F-91	ECG5574		
T500134004AB	WES	63A, 1.3KV, 0.15A, 3V	B-74			
T500134004AQ	WES	63A, 1.3KV, 0.15A, 3V	F-91	ECG5574		
T500134005AB	WFS	63A, 1.3KV, 0.1A, 3V	B-74			
T500134005AQ	WES	63A, 1.3KV, 0.1A, 3V	F-91			
T500138004AB	WES	125A, 1.3KV, 0.15A, 3V	B-74			

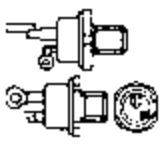
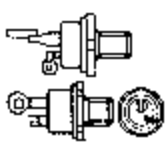

器件型号 Element type	厂名 Manufacturers	材料用途参数 Material Purpose Parameter	图号 Figure	国内外相似替换器件型号 Replace of similar type	备注 Notes	外形参考图 Reference shape	
T500138004AQ	WES	125A, 1.3KV, 0.15A, 3V	F-91			 图 F-91	
T500138005AB	WES	125A, 1.3KV, 0.1A, 3V	B-74				
T500138005AQ	WES	125A, 1.3KV, 0.1A, 3V	F-91				
T500144004AB, 5AB	WES	63A, 1.4KV, 0.1A, 3V	B-74				
T500144004AQ, 5AQ	WES	63A, 1.4KV, 0.1A, 3V	F-91				
T500154001AB	WES	63A, 1.5KV, 0.15A, 3V	B-74				
T500154004AQ	WES	63A, 1.5KV, 0.15A, 3V	F-91				
T500154005AB	WES	63A, 1.5KV, 0.1A, 3V	B-74				
T500154005AQ	WES	63A, 1.5KV, 0.1A, 3V	F-91				
T500158004AB, 5AB	WES	125A, 1.5KV, 0.1A, 3V	B-74				
T500158004AQ, 5AQ	WES	125A, 1.5KV, 0.1A, 3V	F-91				
T507014034AB, 44AB, 54AB, 64AB, 74AB, 84AB	WES	63A, 100V, 0.15A, 3V	B-74				 图 B-74
T507014034AQ, 44AQ, 54A, 64AQ, 74AQ, 84AQ	WES	63A, 100V, 0.15A, 3V	F-91	ECG5371			
T507017034AB, 44AB, 54AB, 64AB, 74AB, 84AB	WES	110A, 100V, 0.15A, 3V	B-74				
T507017034AQ, 44AQ, 54A, 64AQ, 74AQ, 84AQ	WES	110A, 100V, 0.15A, 3V	F-91	ECG5371			

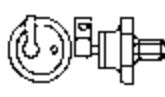
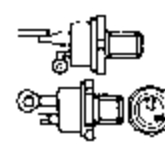
器件型号 Element type	厂名 Manufacturers	材料用途参数 Material Purpose Parameter	图号 Figure	国内外相似替换器件型号 Replace of similar type	备注 Notes	外形参考图 Reference shape
T507018034AB, 44AB, 54AB, 64AB, 74AB, 84AB	WES	125A, 100V, 0.15A, 3V	B-74			
T507018034AQ, 44AQ, 54A, 64AQ, 74AQ, 84AQ	WES	125A, 100V, 0.15A, 3V	F-91	ECG5371		
T507024034AB, 44AB, 54AB, 64AB, 74AB, 84AB	WES	63A, 200V, 0.15A, 3V	B-74			
T507024034AQ, 44AQ, 54A, 64AQ, 74AQ, 84AQ	WES	63A, 200V, 0.15A, 3V	F-91	ECG5371		 图 B-74
T507027034AB, 44AB, 54AB, 64AB, 74AB, 84AB	WES	110A, 200V, 0.15A, 3V	B-74			
T507027034AQ, 44AQ, 54A, 64AQ, 74AQ, 84AQ	WES	110A, 200V, 0.15A, 3V	F-91	ECG5371		 图 F-91
T507028034AB, 44AB, 54AB, 64AB, 74AB, 84AB	WES	125A, 200V, 0.15A, 3V	B-74			
T507028034AQ, 44AQ, 54A, 64AQ, 74AQ, 84AQ	WES	125A, 200V, 0.15A, 3V	F-91	ECG5371		
T507034034AB, 44AB, 54AB, 64AB, 74AB, 84AB	WES	63A, 300V, 0.15A, 3V	B-74			



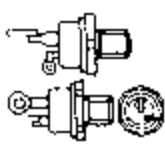
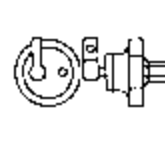

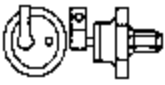
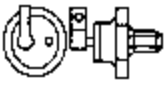
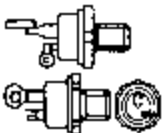
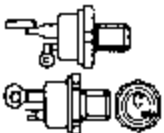
器件型号 Element type	厂名 Manufacturers	材料 Material	用途 Purpose	参数 Parameter	图号 Figure	同内外相似替换器型号 Replace of similar type	备注 Notes	外形参考图 Reference shape
T507034034AQ, 44AQ, 54AQ, 64AQ, 74AQ, 84AQ	WES			63A, 300V, 0.15A, 3V	F-91	ECG5371		 图 F-91
T507037034AB, 44AB, 54AB, 64AB, 74AB, 84AB	WES			110A, 300V, 0.15A, 3V	B-74			
T507037034AQ, 44AQ, 54AQ, 64AQ, 74AQ, 84AQ	WES			110A, 300V, 0.15A, 3V	F-91	ECG5371		
T507038034AB, 44AB, 54AB, 64AB, 74AB, 84AB	WES			125A, 300V, 0.15A, 3V	B-74			
T507038034AQ, 44AQ, 54AQ, 64AQ, 74AQ, 84AQ	WES			125A, 300V, 0.15A, 3V	F-91	ECG5371		
T507044034AB, 44AB, 54AB, 64AB, 74AB, 84AB	WES			63A, 400V, 0.15A, 3V	B-74			 图 B-74
T507044034AQ, 44AQ, 54AQ, 64AQ, 74AQ	WES			63A, 400V, 0.15A, 3V	F-91	ECG5371		
T507047034AB, 44AB, 54AB, 64AB, 74AB, 84AB	WES			110A, 400V, 0.15A, 3V	B-74			
T507047034AQ, 44AQ, 54AQ, 64AQ, 74AQ, 84AQ	WES			110A, 400V, 0.15A, 3V	F-91	ECG5371		

器件型号 Element type	厂名 Manufacturers	材料用途参数 Material Purpose Parameter	图号 Figure	国内外相似替换器件型号 Replace of similar type	备注 Notes	外形参考图 Reference shape
T507048034AB, 44AB, 54AB, 64AB, 74AB, 84AB	WES	125A, 400V, 0.15A, 3V	B-74			 图 D-74
T507048034AQ, 44AQ, 54AQ, 64AQ, 74AQ, 84AQ	WES	125A, 400V, 0.15A, 3V	F-91	ECG5371		
T507054034AB, 44AB, 54AB, 64AB, 74AB, 84AB	WES	63A, 500V, 0.15A, 3V	B-74			 图 D-74
T507054034AQ, 44AQ, 54AQ, 64AQ, 74AQ, 84AQ	WES	63A, 500V, 0.15A, 3V	F-91	ECG5371		
T507057034AB, 44AB, 54AB, 64AB, 74AB, 84AB	WES	110A, 500V, 0.15A, 3V	B-74			 图 F-91
T507057034AQ, 44AQ, 54AQ, 64AQ, 74AQ, 84AQ	WES	110A, 500V, 0.15A, 3V	F-91	ECG5371		
T507058034AB, 44AB, 54AB, 64AB, 74AB, 84AB	WES	125A, 500V, 0.15A, 3V	B-74			 图 F-91
T507058034AQ, 44AQ, 54AQ, 64AQ, 74AQ, 84AQ	WES	125A, 500V, 0.15A, 3V	F-91	ECG5371		
T507064034AB, 44AB, 54AB, 64AB, 74AB, 84AB	WES	63A, 600V, 0.15A, 3V	B-74			

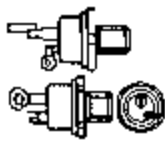
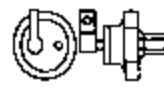

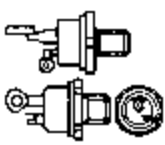
器件型号 Element type	厂名 Manufacturers	材料用途参数 Material Purpose Parameter	图号 Figure	国内外相似替换器件型号 Replace of similar type	备注 Notes	外形参考图 Reference shape
T507064034AQ, 44AQ, 54AQ, 64AQ, 74AQ, 84AQ	WES	63A, 600V, 0.15A, 3V	F-91	ECG5371		 图 F-91
T507067034AB, 44AB, 54AB, 64AB, 74AB, 84AB	WES	110A, 500V, 0.15A, 3V	B-74			
T507067034AQ, 44AQ, 54AQ, 64AQ, 74AQ, 84AQ	WES	110A, 600V, 0.15A, 3V	F-91	ECG5371		 图 B-74
T507068034AB, 44AB, 54AB, 64AB, 74AB, 84AB	WES	125A, 600V, 0.15A, 3V	B-74			
T507068034AQ, 44AQ, 54AQ, 64AQ, 74AQ, 84AQ	WES	125A, 600V, 0.15A, 3V	F-91	ECG5371		
T507074034AB, 44AB, 54AB, 64AB, 74AB, 84AB	WES	63A, 700V, 0.15A, 3V	B-74			
T507074034AQ, 44AQ, 54AQ, 64AQ, 74AQ, 84AQ	WES	63A, 700V, 0.15A, 3V	F-91	ECG5372		
T507077034AB, 44AB, 54AB, 64AB, 74AB, 84AB	WES	110A, 700V, 0.15A, 3V	B-74			
T507077034AQ, 44AQ, 54AQ, 64AQ	WES	110A, 700V, 0.15A, 3V	F-91	ECG5372, 74AQ, 84AQV		
T507078034AB, 44AB, 54AB, 64AB, 74AB, 84AB	WES	125A, 700V, 0.15A, 3V	B-74			

器件型号 Element type	厂名 Manufacturers	材料用途参数 Material Purpose Parameter	图号 Figure	国内外相似替换器件型号 Replacc of similar type	备注 Notes	外形参考图 Reference shape
T507078034AQ, 44AQ, 54AQ, 64AQ, 74AQ, 84AQ	WES	125A, 700V, 0.15A, 3V	F-91	ECG5372		 图 F-91
T507084034AB, 44AB, 54AB, 64AB, 74AB, 84AB	WES	63A, 800V, 0.15A, 3V	B-74			
T507084034AQ, 44AQ, 54AQ, 64AQ, 74AQ, 84AQ	WES	63A, 800V, 0.15A, 3V	F-91	ECG5372		 图 D-74
T507087034AQ, 44AQ, 54AQ, 64AQ, 74AQ, 84AQ	WES	110A, 800V, 0.15A, 3V	F-91	ECG5372		
T507087054AB, 64AB, 74AB, 84AB	WES	110A, 800V, 0.15A, 3V	B-74			
T507088034AB, 44AB, 54AB, 64AB, 74AB, 84AB	WES	125A, 800V, 0.15A, 3V	B-74			
T507068034AQ, 44AQ, 54AQ, 64AQ, 74AQ, 84AQ	WES	125A, 800V, 0.15A, 3V	F-91	ECG5372		
T507094034AB, 44AB, 54AB, 64AB, 74AB, 84AB	WES	63A, 900V, 0.15A, 3V	B-74			
T507094034AQ, 44AQ, 54AQ, 64AQ, 74AQ, 84AQ	WES	63A, 900V, 0.15A, 3V	F-91	ECG5372		
T507097034AB, 44AB, 54AB, 64AB, 74AB, 84AB	WES	110A, 900V, 0.15A, 3V	B-74			

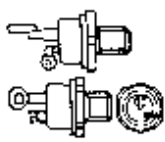
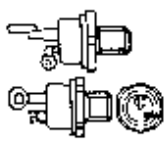
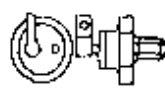
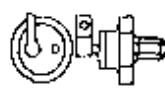

器件型号 Element type	厂名 Manufacturers	材料用途参数 Material Purpose Parameter	图号 Figure	国内外相似替换器件型号 Replace of similar type	备注 Notes	外形参考图 Reference shape
T507097034AQ, 44AQ, 51AQ, 64AQ, 74AQ, 84AQ	WES	110A, 900V, 0.15A, 3V	F-91	ECG5372		 图 F-91
T507098034AB, 44AB, 54AB, 64AB, 74AB, 84AB	WES	125A, 900V, 0.15A, 3V	B-74			
T507098034AQ, 44AQ, 54AQ, 64AQ, 74AQ	WES	125A, 900V, 0.15A, 3V	F-91	ECG5372		 图 F-91
T507104034AB, 44AB, 54AB, 64AB, 74AB	WES	63A, 1kV, 0.15A, 3V	B-74			
T507104034AQ, 44AQ, 54AQ, 64AQ, 74AQ	WES	63A, 1kV, 0.15A, 3V	F-91	ECG5372		 图 B-74
T507107034AB, 44AB, 54AB, 64AB, 74AB	WES	110A, 1kV, 0.15A, 3V	B-74			
T507107034AQ, 44AQ, 54AQ, 64AQ, 74AQ	WES	110A, 1kV, 0.15A, 3V	F-91	FCG5372		 图 B-74
T507108034AB, 44AB, 54AB, 64AB, 74AB	WES	125A, 1kV, 0.15A, 3V	B-74			
T507108034AQ, 44AQ, 54AQ, 64AQ, 74AQ	WES	125A, 1kV, 0.15A, 3V	F-91	ECG5372		

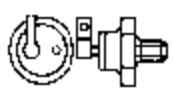
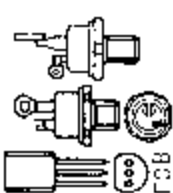
器件型号 Element type	厂名 Manufacturer's	材料 Material	用途 Purpose	参数 Parameter	图号 Figure	国内外相似替换器件型号 Replace of similar type	备注 Notes	外形参考图 Reference shape
T507114034AB, 44AB, 54AB, 64AB, 74AB	WES			63A, 1.1KV, 0.1A, 3V	B-74			 图 B-74
T507114034AQ, 44AQ, 54AQ, 64AQ, 74AQ	WES			63A, 1.1KV, 0.1A, 3V	F-91	ECG5372		
T507117034AB, 44AB, 54AB, 64AB, 74AB	WES			110A, 1.1KV, 0.15A, 3V	B 74			 图 F-91
T507117034AQ, 44AQ, 54AQ, 64AQ, 74AQ	WES			110A, 1.1KV, 0.15A, 3V	F-91	ECG5372		
T507118034AB, 44AB, 54AB, 64AB, 74AB	WES			125A, 1.1KV, 0.15A, 3V	B-74			
T507118034AQ, 44AQ, 54AQ, 64AQ, 74AQ	WES			125A, 1.1KV, 0.15A, 3V	F-91	ECG5372		
T507124034AB, 44AB, 54AB, 64AB, 74AB	WES			63A, 1.2KV, 0.15A, 3V	B-74			
T507124034AQ, 44AQ, 54AQ, 64AQ, 74AQ	WES			63A, 1.2KV, 0.15A, 3V	F-91	ECG5372		
T507127034AB, 44AB, 54AB, 64AB, 74AB	WES			110A, 1.2KV, 0.15A, 3V	B-74			





器件型号 Element type	厂名 Manufacturers	材料用途参数 Material Purpose Parameter	图号 Figure	国内外相似替换器件型号 Replace of similar type	备注 Notes	外形参考图 Reference shape
T507127034AQ, 44AQ, 54AQ, 64AQ, 74AQ	WES	110A, 1.2kV, 0.15A, 3V	F-91	ECG5372		 图 F-91
T507126034AB, 44AB, 54AB, 64AB, 74AB	WES	125A, 1.2kV, 0.15A, 3V	B-74			
T507128034AQ, 44AQ, 54AQ, 64AQ, 74AQ	WES	125A, 1.2kV, 0.15A, 3V	F-91	ECG5372		
T507134034AB, 44AB, 54AB, 64AB	WES	63A, 1.3kV, 0.15A, 3V	B-74			
T507134034AQ, 44AQ, 54AQ, 64AQ	WES	63A, 1.3kV, 0.15A, 3V	F-91			
T507137034AB, 44AB, 54AB	WES	110A, 1.3kV, 0.15A, 3V	B-74			
T507137034AQ, 44AQ, 54AQ	WES	110A, 1.3kV, 0.15A, 3V	F-91			
T507144034AB	WES	63A, 1.4kV, 0.1A, 3V	B-74			
T507144034AQ	WES	63A, 1.4kV, 0.1A, 3V	F-91			
T510005004AB	WES	80A, 50V, 0.15A, 3V	B-74	ECG5575		
T510005004AQ	WES	80A, 50V, 0.15A, 3V	F-91	ECG5570		
T510005005AB	WES	80A, 50V, 0.1A, 3V	B-74	ECG5575		
T510005005AQ	WES	80A, 50V, 0.1A, 3V	F-91	ECG5570		
T510008004AB	WES	125A, 50V, 0.15A, 3V	B-74	ECG5575		
T510008004AQ	WES	125A, 50V, 0.15A, 3V	F-91	ECG5570		
T510008005AB	WES	125A, 50V, 0.1A, 3V	B-74	ECG5575		
T510008005AQ	WES	125A, 50V, 0.1A, 3V	F-91	ECG5570		
T510015004AB	WES	80A, 100V, 0.15A, 3V	B-74	ECG5570		
T510015004AQ	WES	80A, 100V, 0.15A, 3V	F-91	ECG5570		



图 B-74

器件型号 Element type	厂名 Manufacturers	材料用途参数 Material Purpose Parameter	图号 Figure	国内外相似替换器件型号 Replace of similar type	备注 Notes	外形参考图 Reference shape
T510015005AB	WES	80A, 100V, 0.1A, 3V	B-74	ECG5575		 图 B-74
T510015005AQ	WES	80A, 100V, 0.1A, 3V	F-91	ECG5570		
T510018004AB	WES	125A, 100V, 0.15A, 3V	B-74	ECG5575		 图 F-91
T510018004AQ	WES	125A, 100V, 0.15A, 3V	F-91	ECG5570		
T510018005AB	WES	125A, 100V, 0.1A, 3V	B-74	ECG5575		
T510018005AQ	WES	125A, 100V, 0.1A, 3V	F-91	ECG5570		
T510025004AB	WES	80A, 200V, 0.15A, 3V	B-74	ECG5575		
T510025004AQ	WES	80A, 200V, 0.15A, 3V	F-91	ECG5570		
T510025005AB	WES	80A, 200V, 0.1A, 3V	B-74	ECG5575		
T510025005AQ	WES	80A, 200V, 0.1A, 3V	F-91	ECG5570		
T510028004AB	WES	125A, 200V, 0.15A, 3V	B-74	ECG5575		
T510028004AQ	WES	125A, 200V, 0.15A, 3V	F-91	ECG5570		
T510028005AB	WES	125A, 200V, 0.1A, 3V	B-74	ECG5575		
T510028005AQ	WES	125A, 200V, 0.1A, 3V	F-91	ECG5570		
T510035004AB	WES	80A, 300V, 0.15A, 3V	B-74	ECG5575		
T510035004AQ	WES	80A, 300V, 0.15A, 3V	F-91	ECG5570		
T510035005AB	WES	80A, 300V, 0.1A, 3V	B-74	ECG5575		
T510035005AQ	WES	80A, 300V, 0.1A, 3V	F-91	ECG5570		
T510038004AB	WES	125A, 300V, 0.15A, 3V	B-74	ECG5575		
T510038004AQ	WES	125A, 300V, 0.15A, 3V	F-91	ECG5570		
T510038005AB	WES	125A, 300V, 0.1A, 3V	B-74	ECG5575		
T510038005AQ	WES	125A, 300V, 0.1A, 3V	F-91	ECG5570		
T510045004AB	WES	80A, 400V, 0.15A, 3V	B-74	ECG5575		
T510045004AQ	WES	80A, 400V, 0.15A, 3V	F-91	ECG5570		
T510045005AB	WES	80A, 400V, 0.1A, 3V	B-74	ECG5575		
T510045005AQ	WES	80A, 400V, 0.1A, 3V	F-91	ECG5570		
T510048004AB	WFS	125A, 400V, 0.15A, 3V	B-74	ECG5575		
T510048004AQ	WFS	125A, 400V, 0.15A, 3V	F-91	ECG5570		
T510048005AB	WES	125A, 400V, 0.1A, 3V	B-74	ECG5575		

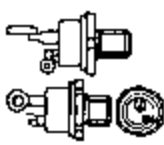

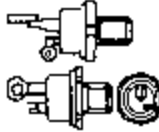
器件型号 Element type	厂名 Manufacturers	材料用途参数 Material Purpose Parameter	图号 Figure	国内外相似替换器件型号 Replac of similar type	备注 Notes	外形参考图 Reference scape
T510048005AQ	WES	125A, 400V, 0.1A, 3V	F-91			
T510055004AB	WES	80A, 500V, 0.15A, 3V	B-74			
T510055004AQ	WES	80A, 500V, 0.15A, 3V	F-91	ECG5572		
T510055005AB	WES	80A, 500V, 0.1A, 3V	B-74	ECG5577		
T510055005AQ	WES	80A, 500V, 0.1A, 3V	F-91	ECG5572		
T510058004AB	WES	125A, 500V, 0.15A, 3V	B-74	ECG5577		
T510058004AQ	WES	125A, 500V, 0.15A, 3V	F-91	ECG5572		
T510058005AB	WES	125A, 500V, 0.1A, 3V	B-74	ECG5577		
T510058005AQ	WES	125A, 500V, 0.1A, 3V	F-91	ECG5572		
T510065004AB	WES	80A, 600V, 0.15A, 3V	B-74			
T510065004AQ	WES	80A, 600V, 0.15A, 3V	F-91	ECG5572		
T510065005AB	WES	80A, 600V, 0.1A, 3V	B-74			
T510065005AQ	WES	80A, 600V, 0.1A, 3V	F-91	ECG5572		
T510068004AB	WES	125A, 600V, 0.15A, 3V	B-74	ECG5577		
T510068004AQ	WES	125A, 600V, 0.15A, 3V	F-91	ECG5572		
T510068005AB	WES	125A, 600V, 0.1A, 3V	B-74	ECG5577		
T510068005AQ	WES	125A, 600V, 0.1A, 3V	F-91	ECG5572		
T510068007AB	WES	125A, 600V, 0.07A, 3V	B-74			
T510068007AQ	WES	125A, 600V, 0.07A, 3V	F-91			
T527121284DN	WES	180A, 1.2kV, 0.15A, 3V		ECG5381		
T600061504	WES	235A, 600V, 0.15A, 3V	F-91			
T600071304	WES	200A, 700V, 0.15A, 3V	F-91			
T600071504	WES	235A, 700V, 0.15A, 3V	F-91			
T600071804	WES	275A, 700V, 0.15A, 3V	F-91			
T600081304	WES	200A, 800V, 0.15A, 3V	F-91			
T600081504	WES	235A, 800V, 0.15A, 3V	F-91			
T600081804	WES	275A, 800V, 0.15A, 3V	F-91			
T600091304	WES	200A, 900V, 0.15A, 3V	F-91			
T600091504	WES	235A, 900V, 0.15A, 3V	F-91			



图 F-91



图 F-64

器件型号 Element type	厂名 Manufacturers	材料 Material	用途 Purpose	参数 Parameter	图号 Figure	国内外相似替换器件型号 Replace of similar type	备注 Notes	外形参考图 Reference shape
T600091804	WES	275A, 900V, 0.15A, 3V			F-91	ECG5584		 图 F-91
T600101304	WES	200A, 1kV, 0.15A, 3V			F-91	ECG5584		
T600101504	WES	235A, 1kV, 0.15A, 3V			F-91	ECG5584		
T600101804	WES	275A, 1kV, 0.15A, 3V			F-91	ECG5584		
T600111304	WES	200A, 1.1kV, 0.15A, 3V			F-91	ECG5584		
T600111504	WES	235A, 1.1kV, 0.15A, 3V			F-91	ECG5584		
T600111804	WES	275A, 1.1kV, 0.15A, 3V			F-91	ECG5584		
T600121504	WES	235A, 1.2kV, 0.15A, 3V			F-91	ECG5584		
T600131504	WES	235A, 1.3kV, 0.15A, 3V			F-91	ECG5584		
T600131804	WES	275A, 1.3kV, 0.15A, 3V			F-91	ECG5584		
T600141304	WES	200A, 1.4kV, 0.15A, 3V			F-91	ECG5584		
T600141504	WES	235A, 1.4kV, 0.15A, 3V			F-91	ECG5584		
T600151304	WES	200A, 1.5kV, 0.15A, 3V			F-91	ECG5584		
T600151504	WES	235A, 1.5kV, 0.15A, 3V			F-91	ECG5584		
T607011324	WES	200A, 100V, 0.15A, 3V			F-91	ECG5374		
T607011334, 44, 54, 64, 74, 84	WES	200A, 100V, 0.15A, 3V			F-91	ECG5374		
T607011524	WES	235A, 100V, 0.15A, 3V			F-91	ECG5374		
T607011534, 44, 54, 64, 74, 84	WES	235A, 100V, 0.15A, 3V			F-91	ECG5374		
T607011824	WES	275A, 100V, 0.15A, 3V			F-91	ECG5374		
T607011834, 44, 54, 64, 74	WES	275A, 100V, 0.15A, 3V			F-91	ECG5374		
T607021324, 44	WES	200A, 200V, 0.15A, 3V			F-91	FCG5374		
T607021334, 54, 64, 74, 84	WES	200A, 200V, 0.15A, 3V			F-91	FCG5374		
T607021524, 34	WES	235A, 200V, 0.15A, 3V			F-91	ECG5374		
T607021544, 54, 64, 74, 84	WES	235A, 200V, 0.15A, 3V			F-91	ECG5374		

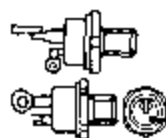

器件型号 Element type	厂名 Manufacturers	材料用途参数 Material Purpose Paramcter	图号 Figure	国内外相似替换器件型号 Rcplace of similar type	备注 Notes	外形参考图 Reference shape
T607021824	WES	275A, 200V, 0.15A, 3V	F-91	ECG5374		 F-91
T607021834, 44, 54, 64, 74, 84	WES	275A, 200V, 0.15A, 3V	F-91	ECG5374		
T607031324	WES	200A, 300V, 0.15A, 3V	F-91			
T607031334, 44, 54, 64, 74, 84	WES	200A, 300V, 0.15A, 3V	F-91	ECG5374		
T607031524	WES	235A, 300V, 0.15A, 3V	F-91			
T607031534, 44, 54, 64, 74, 84	WES	235A, 300V, 0.15A, 3V	F-91	ECG5374		
T607031824	WES	275A, 300V, 0.15A, 3V	F-91			
T607031834, 44, 54, 64, 74, 84	WES	275A, 300V, 0.15A, 3V	F-91	ECG5374		
T607041324	WES	200A, 400V, 0.15A, 3V	F-91			
T607041334, 44, 54, 64, 74, 84	WES	200A, 400V, 0.15A, 3V	F-91	ECG5374		
T607041524	WES	235A, 400V, 0.15A, 3V	F-91			
T607041534, 44, 54, 64, 74, 84	WES	235A, 400V, 0.15A, 3V	F-91	ECG5374		
T607041824	WES	275A, 400V, 0.15A, 3V	F-91			
T607041834, 44, 54, 64, 74, 84	WES	275A, 400V, 0.15A, 3V	F-91	ECG5374		
T607051324	WES	200A, 500V, 0.15A, 3V	F-91			
T607051334, 44, 54, 64, 74, 84	WES	200A, 500V, 0.15A, 3V	F-91	ECG5374		
T607051524	WES	235A, 500V, 0.15A, 3V	F-91			
T607051534, 44, 54, 64, 74, 84	WFS	235A, 500V, 0.15A, 3V	F-91	ECG5374		
T607051824	WES	275A, 500V, 0.15A, 3V	F-91			

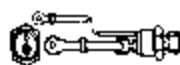
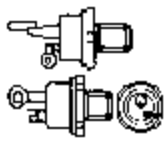
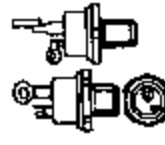
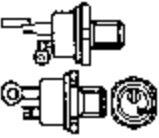
器件型号 Element type	厂名 Manufacturers	材料用途参数 Material Purpose Parameter	图号 Figure	国内外相似替换器件型号 Replace of similar type	备注 Notes	外形参考图 Reference shape
T607061834, 44, 54, 64, 74, 84	WES	275A, 500V, 0.15A, 3V	F-91	ECG5374		 图 1-91
T607061324	WES	200A, 600V, 0.15A, 3V	F-91			
T607061334, 44, 54, 64, 74, 84	WES	200A, 600V, 0.15A; 3V	F-91	ECG5374		
T607061524	WES	235A, 600V, 0.15A, 3V	F-91			
T607061534, 44, 54, 64, 74, 84	WES	235A, 600V, 0.15A, 3V	F-91	ECG5374		
T607061824	WES	275A, 600V, 0.15A, 3V	F-91			
T607061834, 44, 54, 64, 74, 84	WES	275A, 600V, 0.15A, 3V	F-91	ECG5374		
T607071324	WES	200A, 700V, 0.15A, 3V	F-91			
T607071334, 44, 54, 64, 74, 84	WES	200A, 700V, 0.15A, 3V	F-91	ECG5375		
T607071524	WES	235A, 700V, 0.15A, 3V	F-91			
T607071534, 44, 54, 64, 74, 84	WES	235A, 700V, 0.15A, 3V	F-91	ECG5375		
T607071824	WES	275A, 700V, 0.15A, 3V	F-91			
T607071834, 44, 54, 64, 74, 84	WES	275A, 700V, 0.15A, 3V	F-91	ECG5375		
T607081324	WES	200A, 800V, 0.15A, 3V	F-91			
T607081334, 44, 54, 64, 74, 84	WES	200A, 800V, 0.15A, 3V	F-91	ECG5375		
T607081524	WES	235A, 800V, 0.15A, 3V	F-91			
T607081534, 44, 54, 64, 74, 84	WES	235A, 800V, 0.15A, 3V	F-91	ECG5375		
T607081824	WES	275A, 800V, 0.15A, 3V	F-91			
T607081834, 44, 54, 64, 74, 84	WES	275A, 800V, 0.15A, 3V	F-91	ECG5375		

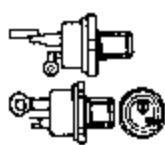

器件型号 Element type	厂名 Manufacturers	材料用途参数 Material Purpose Parameter	图号 Figure	国内外相似替换器件型号 Replace of similar type	备注 Notes	外形参考图 Reference shape
T607091324	WES	200A, 900V, 0.15A, 3V	F-91			 F-91
T607091334, 44, 54, 64, 74, 84	WES	200A, 900V, 0.15A, 3V	F-91	ECG5375		
T607091524	WES	235A, 900V, 0.15A, 3V	F-91			
T607091534, 44, 54, 64, 74, 84	WES	235A, 900V, 0.15A, 3V	F-91	ECG5375		
T607091824	WES	275A, 900V, 0.15A, 3V	F-91			
T607091834, 44, 54, 64, 74, 84	WES	275A, 900V, 0.15A, 3V	F-91	ECG5375		
T607101324	WES	200A, 1kV, 0.15A, 3V	F-91			
T607101334, 44, 54, 64, 74	WES	200A, 1kV, 0.15A, 3V	F-91	ECG5375		
T607101524	WES	235A, 1kV, 0.15A, 3V	F-91			
T607101534, 44, 54, 64, 74	WES	235A, 1kV, 0.15A, 3V	F-91	ECG5375		
T607101824	WES	275A, 1kV, 0.15A, 3V	F-91			
T607101834, 44, 54, 64, 74	WES	275A, 1kV, 0.15A, 3V	F-91	ECG5375		
T607111324	WES	200A, 1.1kV, 0.15A, 3V	F-91			
T607111334, 44, 54, 64	WES	200A, 1.1kV, 0.15A, 3V	F-91	ECG5375		
T607111524	WES	235A, 1.1kV, 0.15A, 3V	F-91			
T607111534, 44, 54, 64	WES	235A, 1.1kV, 0.15A, 3V	F-91	ECG5375		
T607111824	WES	275A, 1.1kV, 0.15A, 3V	F-91			
T607111831, 44, 54, 64	WES	275A, 1.1kV, 0.15A, 3V	F-91	ECG5375		
T607121324	WES	200A, 1.2kV, 0.15A, 3V	F-91			

器件型号 Element type	厂名 Manufacturers	材料用途参数 Material Purpose Parameter	图号 Figure	国内外相似替换器件型号 Replace of similar type	备注 Notes	外形参考图 Reference shape
T607121334, 44, 54, 64	WES	200A, 1.2kV, 0.15A, 3V	F-91	ECG5375		
T607121544, 54, 64	WES	235A, 1.2kV, 0.15A, 3V	F-91	ECG5375		
T607121824	WES	275A, 1.2kV, 0.15A, 3V	F-91	ECG5375		
T607121834, 54, 64	WES	275A, 1.2kV, 0.15A, 3V	F-91	ECG5580		
T610011304	WES	200A, 100V, 0.15A, 3V	F-91	ECG5580		
T610011504	WES	235A, 100V, 0.15A, 3V	F-91	ECG5580		
T610021304	WES	200A, 200V, 0.15A, 3V	F-91	ECG5580		
T610021504	WES	235A, 200V, 0.15A, 3V	F-91	ECG5580		
T610031304	WES	200A, 300V, 0.15A, 3V	F-91	ECG5582		
T610031504	WES	235A, 300V, 0.15A, 3V	F-91	ECG5582		
T610031804	WES	275A, 300V, 0.15A, 3V	F-91	ECG5582		
T610041504	WES	235A, 400V, 0.15A, 3V	F-91	ECG5582		
T610041804	WES	275A, 400V, 0.15A, 3V	F-91	ECG5582		
T610051304	WES	200A, 500V, 0.15A, 3V	F-91	ECG5582		
T610051504	WES	235A, 500V, 0.15A, 3V	F-91	ECG5582		
T610051804	WES	275A, 500V, 0.15A, 3V	F-91	ECG5582		
T610061304	WES	200A, 600V, 0.15A, 3V	F-91	ECG5582		
T610061504	WES	235A, 600V, 0.15A, 3V	F-91	ECG5582		
T610061804	WES	275A, 600V, 0.15A, 3V	F-91	ECG5582		
T620071504	WES	235A, 700V, 0.15A, 3V	C-35	ECG5592		
T620072004	WES	315A, 700V, 0.15A, 3V	C-35	ECG5592		
T620073004	WES	470A, 700V, 0.15A, 3V	C-35	ECG5592		
T620081504	WES	235A, 800V, 0.15A, 3V	C-35	ECG5592		
T620082004	WES	315A, 800V, 0.15A, 3V	C-35	ECG5592		
T620083004	WES	470A, 800V, 0.15A, 3V	C-35	ECG5592		
T620091504	WES	235A, 900V, 0.15A, 3V	C-35	ECG5592		
T620092004	WES	315A, 900V, 0.15A, 3V	C-35	ECG5592		
T620093004	WES	470A, 900V, 0.15A, 3V	C-35	ECG5592		



图 F-91





图 C-35

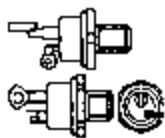

器件型号 Element type	厂名 Manufacturers	材料用途参数 Material Purpose Parameter	图号 Figure	国内外相似替换器件型号 Replace of similar type	备注 Notes	外形参考图 Reference shape
T620101504	WES	235A, 1kV, 0.15A, 3V	C-35	FCG5592		 <p>图 C-35</p>
T620102004	WES	315A, 1kV, 0.15A, 3V	C-35	ECG5592		
T620103004	WES	470A, 1kV, 0.15A, 3V	C-35	LCG5592		
T620111504	WES	235A, 1.1kV, 0.15A, 3V	C-35	ECG5592		
T620112004	WES	315A, 1.1kV, 0.15A, 3V	C-35	EOG5592		
T620113004	WES	470A, 1.1kV, 0.15A, 3V	C-35	ECG5592		
T620122004	WES	315A, 1.2kV, 0.15A, 3V	C-35	ECG5592		
T620123004	WES	470A, 1.2kV, 0.15A, 3V	C-35	ECG5592		
T620131504	WES	235A, 1.3kV, 0.15A, 3V		ECG5592		
T620141504	WES	235A, 1.4kV, 0.15A, 3V	C-35			
T620142004	WES	315A, 1.4kV, 0.15A, 3V	C-35			
T620143004	WES	470A, 1.4kV, 0.15A, 3V	C-35			
T620151504	WES	235A, 1.5kV, 0.15A, 3V	C-35			
T620152004	WES	315A, 1.5kV, 0.15A, 3V	C-35			
T620153004	WES	470A, 1.5kV, 0.15A, 3V	C-35			
T625012504	WES	390A, 100V, 0.15A, 3V	C-35			
T625013004	WES	470A, 100V, 0.15A, 3V	C-35			
T625014004	WES	625A, 100V, 0.15A, 3V	C-35			
T625022504	WES	390A, 200V, 0.15A, 3V	C-35			
T625023004	WES	470A, 200V, 0.15A, 3V	C-35			
T625024004	WES	625A, 200V, 0.15A, 3V	C-35			
T625032504	WES	390A, 300V, 0.15A, 3V	C-35			
T625033004	WES	470A, 300V, 0.15A, 3V	C-35			
T625034004	WES	625A, 300V, 0.15A, 3V	C-35			
T625042504	WES	390A, 400V, 0.15A, 3V	C-35			
T625043004	WES	470A, 400V, 0.15A, 3V	C-35			
T625044004	WES	625A, 400V, 0.15A, 3V	C-35			
T625052504	WES	390A, 500V, 0.15A, 3V	C-35			
T625053004	WES	470A, 500V, 0.15A, 3V	C-35			

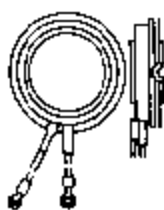
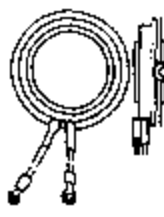
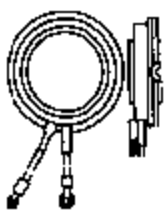
器件型号 Element type	厂名 Manufacturers	材料用途参数 Material Purpose Parameter	图号 Figure	国内外相似替换器件型号 Replace of similar type	备注 Notes	外形参考图 Reference shape
T625054004	WES	625A, 500V, 0.15A, 3V	C-35			 <p>图 C-35</p>
T625062504	WES	390A, 600V, 0.15A, 3V	C-35			
T625063004	WES	470A, 600V, 0.15A, 3V	C-35			
T625064004	WES	625A, 600V, 0.15A, 3V	C-35			
T625072504	WES	390A, 700V, 0.15A, 3V	C-35			
T625073004	WES	470A, 700V, 0.15A, 3V	C-35			
T625074004	WES	625A, 700V, 0.15A, 3V	C-35			
T625082504	WES	390A, 800V, 0.15A, 3V	C-35			
T625083004	WES	470A, 800V, 0.15A, 3V	C-35			
T625084004	WES	625A, 800V, 0.15A, 3V	C-35			
T625092504	WES	390A, 900V, 0.15A, 3V	C-35			
T625093004	WES	470A, 900V, 0.15A, 3V	C-35			
T625094004	WES	625A, 900V, 0.15A, 3V	C-35			
T625102004	WES	315A, 1kV, 0.15A, 3V	C-35			
T625102504	WES	390A, 1kV, 0.15A, 3V	C-35			
T625103004	WES	470A, 1kV, 0.15A, 3V	C-35			
T625104004	WES	625A, 1kV, 0.15A, 3V	C-35			
T625112504	WES	390A, 1.1kV, 0.15A, 3V	C-35			
T625113004	WES	470A, 1.1kV, 0.15A, 3V	C-35			
T625122504	WES	390A, 1.2kV, 0.15A, 3V	C-35			
T625123004	WES	470A, 1.2kV, 0.15A, 3V	C-35			
T625124004	WES	625A, 1.2kV, 0.15A, 3V	C-35			
T627011534, 44, 54, 64, 74, 84	WES	235A, 100V, 0.15A, 3V	C-35	ECG5380		
T627012034, 44, 54, 64, 74, 84	WES	315A, 100V, 0.15A, 3V	C-35	ECG5380		
T627012534, 44, 54, 64, 74, 84	WES	400A, 100V, 0.15A, 3V	C-35	ECG5380		

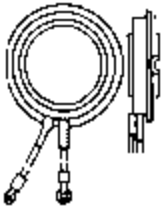

器件型号 Element type	厂名 Manufacturers	材料用途参数 Material Purpose Parameter	图号 Figure	国内外相似替换器型号 Replace of similar type	备注 Notes	外形参考图 Reference shape
T627021534, 44, 54, 64, 74, 84	WES	235A, 200V, 0.15A, 3V	C-35	ECG5380		 <p>图 C-35</p>
T627022034, 44, 54, 64, 74, 84	WES	315A, 200V, 0.15A, 3V	C-35	ECG5380		
T627031534, 44, 54, 64, 74, 84	WES	235A, 300V, 0.15A, 3V	C-35	ECG5380		
T627032034, 44, 54, 64, 74, 84	WES	315A, 300V, 0.15A, 3V	C-35	ECG5380		
T627032534, 44, 54, 64, 74, 84	WES	400A, 300V, 0.15A, 3V	C-35	ECG5380		
T627041534, 44, 54, 64, 74, 84	WES	235A, 400V, 0.15A, 3V	C-35	ECG5380		
T627042034, 44, 54, 64, 74, 84	WES	315A, 400V, 0.15A, 3V	C-35	ECG5380		
T627042534, 44, 54, 64, 74, 84	WES	400A, 400V, 0.15A, 3V	C-35	ECG5380		
T627051534, 44, 54, 64, 74, 84	WES	400A, 500V, 0.15A, 3V	C-35			
T627052034, 44, 54, 64, 74, 84	WES	315A, 500V, 0.15A, 3V	C-35	ECG5380		
T627061534, 44, 54, 64, 74, 84	WES	235A, 600V, 0.15A, 3V	C-35	ECG5380		
T627062034, 44, 54, 64, 74, 84	WES	315A, 600V, 0.15A, 3V	C-35	ECG5380		
T627062534, 44, 54, 64, 74, 84	WES	400A, 600V, 0.15A, 3V	C-35	ECG5380		
T627071534, 44, 54, 64, 74, 84	WES	235A, 700V, 0.15A, 3V	C-35	ECG5381		

器件型号 Element type	厂名 Manufacturers	材料用途参数 Material Purpose Parameter	图号 Figure	国内外相似替换器件型号 Replace of similar type	备注 Notes	外形参考图 Reference shape
T627072034, 44, 54, 64, 74, 84	WES	315A, 700V, 0.15A, 3V	C-35	ECG5381		 图 C-35
T627072534, 44, 54, 64, 74, 84	WES	400A, 700V, 0.15A, 3V	C-35	ECG5381		
T627081534, 44, 54, 64, 74, 84	WES	235A, 800V, 0.15A, 3V	C-35	ECG5381		
T627082034, 44, 54, 64, 74, 84	WES	315A, 800V, 0.15A, 3V	C-35	ECG5381		
T627082534, 44, 54, 64, 74, 84	WES	400A, 800V, 0.15A, 3V	C-35	ECG5381		
T627091534, 44, 54, 64, 74, 84	WES	235A, 900V, 0.15A, 3V	C-35	ECG5381		
T627092034, 44, 54, 64, 74, 84	WES	315A, 900V, 0.15A, 3V	C-35	ECG5381		
T627092534, 44, 54, 64, 74, 84	WES	400A, 900V, 0.15A, 3V	C-35	ECG5381		
T627101534, 44, 54, 64, 74, 84	WES	235A, 1kV, 0.15A, 3V	C-35	ECG5381		
T627102034, 44, 54, 64, 74, 84	WES	315A, 1kV, 0.15A, 3V	C-35	ECG5381		
T627102534, 44, 54, 64, 74, 84	WES	400A, 1kV, 0.15A, 3V	C-35	ECG5381		
T627112034, 44, 54, 64, 74, 84	WES	315A, 1.1kV, 0.15A, 3V	C-35	ECG5381		
T627112534, 44, 54, 64, 74, 84	WES	400A, 1.1kV, 0.15A, 3V	C-35	ECG5381		
T627121534, 44, 54, 64, 74, 84	WES	235A, 1.2kV, 0.15A, 3V	C-35	ECG5381		



器件型号 Element type	厂名 Manufacturers	材料用途参数 Material Purpose Parameter	图号 Figure	国内外相似替换器型号 Replace of similar type	备注 Notes	外形参考图 Reference shape
T627122534, 44, 54, 64, 74, 84	WES	400A, 1.2KV, 0.15A, 3V	C-35	ECG5381		
T630011504	WES	235A, 100V, 0.15A, 3V	C-35	ECG5591		
T630012004	WES	315A, 100V, 0.15A, 3V	C-35	ECG5591		
T630013004	WES	470A, 100V, 0.15A, 3V	C-35	ECG5590		
T630021504	WES	235A, 200V, 0.15A, 3V	C-35	ECG5590		
T630022004	WES	315A, 200V, 0.15A, 3V	C-35	ECG5591		
T630023004	WES	470A, 200V, 0.15A, 3V	C-35	ECG5590		
T630031504	WES	235A, 300V, 0.15A, 3V	C-35	ECG5591		
T630032004	WES	315A, 300V, 0.15A, 3V	C-35	ECG5591		
T630033004	WES	470A, 300V, 0.15A, 3V	C-35	ECG5591		
T630041504	WES	235A, 400V, 0.15A, 3V	C-35	ECG5591		
T630042004	WES	315A, 400V, 0.15A, 3V	C-35	ECG5591		
T630043004	WES	470A, 400V, 0.15A, 3V	C-35	ECG5591		
T630051504	WES	235A, 500V, 0.15A, 3V	C-35	ECG5591		
T630052004	WES	315A, 500V, 0.15A, 3V	C-35	ECG5591		
T630053004	WES	470A, 500V, 0.15A, 3V	C-35	ECG5591		
T630061504	WES	235A, 600V, 0.15A, 3V	C-35	ECG5591		
T630062004	WES	315A, 600V, 0.15A, 3V	C-35	ECG5591		
T630063004	WES	470A, 600V, 0.15A, 3V	C-35	ECG5591		
T700123004	WES	470A, 1.2KV, 0.15A, 3V	F-71	ECG5589		
T700123504	WES	550A, 1.2KV, 0.15A, 3V	F-71	ECG5589		
T700132504	WES	400A, 1.3KV, 0.15A, 3V	F-71			
T700133004	WES	470A, 1.3KV, 0.15A, 3V	F-71			
T700133504	WES	550A, 1.3KV, 0.15A, 3V	F-71			
T700143004	WES	470A, 1.4KV, 0.15A, 3V	F-71			
T700143504	WES	550A, 1.4KV, 0.15A, 3V	F-71			
T700153004	WES	470A, 1.5KV, 0.15A, 3V	F-71			



图 C-35





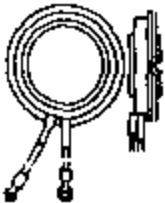
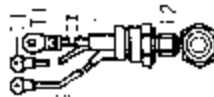





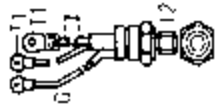

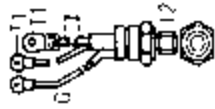
图 F-71

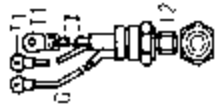

器件型号 Element type	厂名 Manufacturers	材料用途参数 Material Purpose Parameter	图号 Figure	国内外相似替换器件型号 Replace of similar type	备注 Notes	外形参考图 Reference shape
T700162504	WES	400A, 1.6kV, 0.15A, 3V	F-71			 图 F-71
T700163004	WES	470A, 1.6kV, 0.15A, 3V	F-71			
T700163504	WES	550A, 1.6kV, 0.15A, 3V	F-71			
T700173004	WES	470A, 1.7kV, 0.15A, 3V	F-71			
T700182504	WES	400A, 1.8kV, 0.15A, 3V	F-71			
T700183004	WES	470A, 1.8kV, 0.15A, 3V	F-71			
T700203004	WES	470A, 2kV, 0.15A, 3V	F-71			
T700222504	WES	400A, 2.2kV, 0.15A, 3V	F-71			
T700223004	WES	470A, 2.2kV, 0.15A, 3V	F-71			
T707012524, 34, 44, 54	WES	400A, 100V, 0.15A, 3V	F-71	ECG5377		
T707012564, 74	WES	400A, 100V, 0.15A, 3V	F-84			
T707013024, 34, 44, 54	WES	475A, 100V, 0.15A, 3V	F-71	ECG5377		
T707013064, 74	WES	475A, 100V, 0.15A, 3V	F-84			
T707013334, 44, 54, 64, 74, 84	WES	500A, 100V, 0.15A, 3V	F-71			
T707022524, 34, 44, 54	WES	400A, 200V, 0.15A, 3V	F-71	ECG5377		
T707022564, 74	WES	400A, 200V, 0.15A, 3V	F-71			
T707022834, 44, 54	WES	430A, 200V, 0.15A, 3V	F-71	ECG5377		
T707022864, 74, 84	WES	430A, 200V, 0.15A, 3V	F-71			
T707023024, 34, 44, 54	WES	475A, 200V, 0.15A, 3V	F-71	ECG5377		
T707023064, 74	WES	475A, 200V, 0.15A, 3V	F-84			
T707023334, 44, 54, 64, 74, 84	WES	500A, 200V, 0.15A, 3V	F-71			
T707032524, 34, 44, 54	WES	400A, 300V, 0.15A, 3V	F-71	ECG5377		



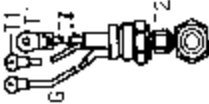

器件型号 Element type	厂名 Manufacturers	材料用途参数 Material Purpose Parameter	图号 Figure	国内外相似替换器件型号 Replace of similar type	备注 Notes	外形参考图 Reference shape
T707032564, 74	WES	400A, 300V, 0.15A, 3V	F-71			 F-71
T707032834, 44, 54	WES	430A, 300V, 0.15A, 3V	F-71	ECG5377		
T707032864, 74, 84	WES	430A, 300V, 0.15A, 3V	F-71			
T707033024, 34, 44, 54	WFS	475A, 300V, 0.15A, 3V	F-71	ECG5377		
T707033064, 74	WES	475A, 300V, 0.15A, 3V	F-84			 F-84
T707042524, 34, 44, 54	WES	400A, 400V, 0.15A, 3V	F-71	ECG5377		
T707042564, 74	WES	400A, 400V, 0.15A, 3V	F-71			
T707042834, 44, 54	WES	430A, 400V, 0.15A, 3V	F-71	ECG5377		
T707042864, 74, 84	WES	430A, 400V, 0.15A, 3V	F-71			
T707043024, 34, 44, 54	WES	475A, 400V, 0.15A, 3V	F-71	ECG5377		
T707043064, 74	WES	475A, 400V, 0.15A, 3V	F-84			
T707043334, 44, 54, 64, 74, 84	WFS	500A, 400V, 0.15A, 3V	F-71			
T707052524, 34, 44, 54	WES	400A, 500V, 0.15A, 3V	F-71	ECG5377		
T707052564, 74	WES	400A, 500V, 0.15A, 3V	F-71			
T707052834, 44, 54	WES	430A, 500V, 0.15A, 3V	F-71	ECG5377		
T707052864, 74, 84	WES	430A, 500V, 0.15A, 3V	F-71			
T707053024, 34, 44, 54	WES	475A, 500V, 0.15A, 3V	F-71	ECG5377		
T707053064, 74	WES	475A, 500V, 0.15A, 3V	F-84			
T707053334, 44, 54, 64, 74, 84	WES	500A, 500V, 0.15A, 3V	F-71			
T707062524, 34, 44, 54	WES	400A, 600V, 0.15A, 3V	F-71	ECG5377		
T707062564, 74, 84	WES	400A, 600V, 0.15A, 3V	F-71			

器件型号 Element type	厂名 Manufacturers	材料用途参数 Material Purpose parameter	图号 Figure	国内外相似替换器件型号 Replace of similar type	备注 Notes	外形参考图 Reference shape
T707063024, 34, 44, 54	WES	475A, 600V, 0.15A, 3V	F-71	ECG5377		 图 F-71
T707063064, 74, 84	WES	475A, 600V, 0.15A, 3V	F-71			
T707063334, 44, 54, 64, 74, 84	WES	500A, 600V, 0.15A, 3V	F-71			 图 F-84
T707072524, 34, 44, 54	WES	400A, 700V, 0.15A, 3V	F-71	ECG5378		
T707072564, 74, 84	WES	400A, 700V, 0.15A, 3V	F-84			 图 F-71
T707072834, 44, 54	WES	430A, 700V, 0.15A, 3V	F-71	ECG5378		
T707072864, 74	WES	430A, 700V, 0.15A, 3V	F-71			 图 F-84
T707073024, 34, 44, 54	WES	475A, 700V, 0.15A, 3V	F-71	ECG5378		
T707073064, 74, 84	WES	475A, 700V, 0.15A, 3V	F-84			 图 F-71
T707082524, 34, 44, 54	WES	400A, 800V, 0.15A, 3V	F-71	ECG5378		
T707082564, 74, 84	WES	400A, 800V, 0.15A, 3V	F-71			 图 F-84
T707082834, 44, 54	WES	430A, 800V, 0.15A, 3V	F-71	ECG5378		
T707082864, 74, 84	WES	430A, 800V, 0.15A, 3V	F-71			 图 F-84
T707083024, 34, 44, 54	WES	475A, 800V, 0.15A, 3V	F-71	ECG5378		
T707083064, 74, 84	WES	475A, 800V, 0.15A, 3V	F-71			 图 F-84
T707083334, 44, 54, 64, 74, 84	WES	500A, 800V, 0.15A, 3V	F-71			
T707092524, 34, 44, 54	WES	400A, 900V, 0.15A, 3V	F-71	ECG5378		 图 F-84
T707092564, 74, 84	WES	400A, 900V, 0.15A, 3V	F-71			
T707093024, 34, 44, 54	WES	475A, 900V, 0.15A, 3V	F-71	ECG5378		 图 F-84
T707093064, 74, 84	WES	475A, 900V, 0.15A, 3V	F-71			





器件型号 Element type	厂名 Manufacturers	材料用途参数 Material Purpose Parameter	图号 Figure	国内外相似替换器件型号 Replace of similar type	备注 Notes	外形参考图 Reference shape
T707102524, 34, 44, 54	WES	400A, 1kV, 0.15A, 3V	F-71	ECG5378		 图 F-71
T707102564, 74, 84	WES	400A, 1kV, 0.15A, 3V	F-71			
T707103024, 34, 44, 54	WES	475A, 1kV, 0.15A, 3V	F-71	ECG5378		 图 F-84
T707103064, 74	WES	475A, 1kV, 0.15A, 3V	F-84			
T707103084	WES	475A, 1kV, 0.15A, 3V	F-71			
T707112524, 34, 44, 54	WES	400A, 1.1kV, 0.15A, 3V	F-71	ECG5378		
T707112564, 74	WES	400A, 1.1kV, 0.15A, 3V	F-84			
T707112584	WES	400A, 1.1kV, 0.15A, 3V	F-71			
T707113024, 34, 44, 54	WES	475A, 1.1kV, 0.15A, 3V	F-71	ECG5378		
T707113064, 74, 84	WES	475A, 1.1kV, 0.15A, 3V	F-84			
T707122524, 34, 44, 54	WES	400A, 1.2kV, 0.15A, 3V	F-71	ECG5378		
T707122564, 74, 84	WES	400A, 1.2kV, 0.15A, 3V	F-71			
T707123024, 34, 44, 54	WES	475A, 1.2kV, 0.15A, 3V	F-71	ECG5378		
T707123064, 74, 84	WES	475A, 1.2kV, 0.15A, 3V	F-71			
T710012504	WES	400A, 100V, 0.15A, 3V	F-71			
T710013004	WES	470A, 100V, 0.15A, 3V	F-71			
T710013504	WES	550A, 100V, 0.15A, 3V	F-71			
T710022504	WES	400A, 200V, 0.15A, 3V	F-71			
T710023004	WES	470A, 200V, 0.15A, 3V	F-71			
T710023504	WES	550A, 200V, 0.15A, 3V	F-71			
T710042504	WES	400A, 400V, 0.15A, 3V	F-71			
T710043004	WES	470A, 400V, 0.15A, 3V	F-71			
T710043504	WES	550A, 400V, 0.15A, 3V	F-71			

器件型号 Element type	厂名 Manufacturers	材料用途参数 Material Purpose Parameter	图号 Figure	国内外相似替换器件型号 Replace of similar type	备注 Notes	外形参考图 Reference shape
T710062504	WES	400A, 600V, 0.15A, 3V	F-71			 图 F-71
T710063004	WES	470A, 600V, 0.15A, 3V	F-71			
T710063504	WES	550A, 600V, 0.15A, 3V	F-71			
T710082504	WES	400A, 800V, 0.15A, 3V	F-71			
T710083004	WES	470A, 800V, 0.15A, 3V	F-71			
T710083504	WES	550A, 800V, 0.15A, 3V	F-71			
T710102504	WES	400A, 1kV, 0.15A, 3V	F-71			
T710103004	WES	470A, 1kV, 0.15A, 3V	F-71			
T710103504	WES	550A, 1kV, 0.15A, 3V	F-71			
T720084504	WES	700A, 800V, 0.15A, 3V	C-47	ECG5596		
T720085504	WES	850A, 800V, 0.15A, 3V	C-47	ECG5596		
T720103504	WES	500A, 1kV, 0.15A, 3V	C-47	ECG5596		
T720104504	WES	700A, 1kV, 0.15A, 3V	C-47	ECG5596		
T720105504	WES	850A, 1kV, 0.15A, 3V	C-47	ECG5596		
T720123504	WES	550A, 1.2kV, 0.15A, 3V	C-47	ECG5596		
T720124504	WES	700A, 1.2kV, 0.15A, 3V	C-47	ECG5596		
T720125504	WES	850A, 1.2kV, 0.15A, 3V	C-47	ECG5596		
T720133504	WES	550A, 1.3kV, 0.15A, 3V	C-47	ECG5596		
T720134504	WES	700A, 1.3kV, 0.15A, 3V	C-47	ECG5596		
T720135504	WES	850A, 1.3kV, 0.15A, 3V	C-47	ECG5596		
T720144504	WES	700A, 1.4kV, 0.15A, 3V	C-47	ECG5596		
T720153504	WES	550A, 1.5kV, 0.15A, 3V	C-47	ECG5596		
T720154504	WES	700A, 1.5kV, 0.15A, 3V	C-47	ECG5596		
T720155504	WES	850A, 1.5kV, 0.15A, 3V	C-47	ECG5596		
T720163504	WES	550A, 1.6kV, 0.15A, 3V	C-47			 图 C-47
T720164504	WES	700A, 1.6kV, 0.15A, 3V	C-47			
T720165504	WES	850A, 1.6kV, 0.15A, 3V	C-47			

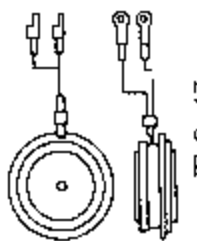
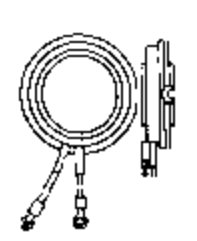
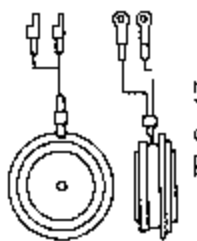
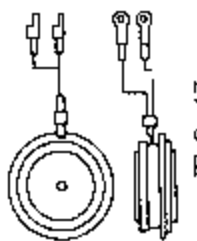
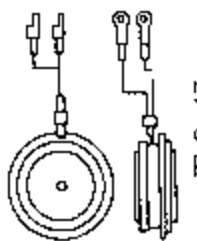
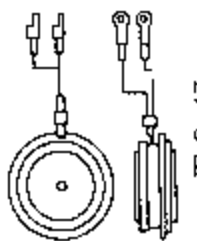
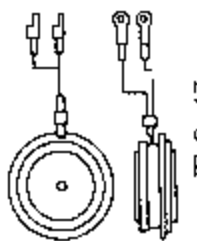
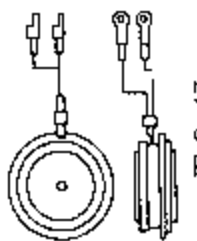

器件型号 Element type	厂名 Manufacturers	材料用途参数 Material Purpose Parameter	图号 Figure	国内外相似替换器件型号 Replace of similar type	备注 Notes	外形参考图 Reference shape
T720173504	WES	550A, 1.7kV, 0.15A, 3V	C-47			 图 C-47
T720174504	WES	700A, 1.7kV, 0.15A, 3V	C-47			
T720183504	WES	550A, 1.8kV, 0.15A, 3V	C-47			 图 C-35
T720204504	WES	700A, 2kV, 0.15A, 3V	C-47			
T720223504	WES	550A, 2.2kV, 0.15A, 3V	C-47			 图 C-47
T720224504	WES	700A, 2.2kV, 0.15A, 3V	C-47			
T727012524, 34, 44	WES	400A, 100V, 0.15A, 3V	C-35			 图 C-47
T727013524, 34, 44, 54, 64, 74, 84	WES	550A, 100V, 0.15A, 3V	C-47	ECG5386		
T727014034, 44, 54, 64, 74, 84	WES	625A, 100V, 0.15A, 3V	C-47			 图 C-47
T727014524, 34, 44, 54, 64, 74, 84	WES	700A, 100V, 0.15A, 3V	C-47			
T727014834, 44, 54, 64, 74, 84	WES	750A, 100V, 0.15A, 3V	C-47			 图 C-47
T727023524, 34, 44, 54, 64, 74, 84	WES	550A, 200V, 0.15A, 3V	C-47	ECG5386		
T727024034, 44, 54, 64, 74, 84	WES	625A, 200V, 0.15A, 3V	C-47			 图 C-47
T727024524, 34, 44, 54, 64, 74, 84	WES	700A, 200V, 0.15A, 3V	C-47			
T727024834, 44, 54, 64, 74, 84	WES	750A, 200V, 0.15A, 3V	C-47			 图 C-47
T727033524, 34, 44, 54, 64, 74, 84	WES	550A, 300V, 0.15A, 3V	C-47	ECG5386		

器件型号 Element type	厂名 Manufacturers	材料用途参数 Material Purpose Parameter	图号 Figure	国内外相似替换器件型号 Replace of similar type	备注 Notes	外形参考图 Reference snape
T727031034, 44, 54, 64, 74, 84	WES	625A, 300V, 0.15A, 3V	C-47			  <p>EC-47</p>
T727034524, 34, 44, 54, 64, 74, 84	WES	700A, 300V, 0.15A, 3V	C-47			
T727034834, 44, 54, 64, 74, 84	WES	750A, 300V, 0.15A, 3V	C-47			
T727043524, 34, 44, 54, 64, 74, 84	WES	550A, 400V, 0.15A, 3V	C-47	ECG5386		
T727044034, 44, 54, 64, 74, 84	WES	625A, 400V, 0.15A, 3V	C-47			
T727044524, 34, 44, 54, 64, 74, 84	WES	700A, 400V, 0.15A, 3V	C-47			
T727044834, 44, 54, 64, 74, 84	WES	750A, 400V, 0.15A, 3V	C-47			
T727053524, 34, 44, 54, 64, 74, 84	WES	550A, 500V, 0.15A, 3V	C-47	ECG5386		
T727054034, 44, 54, 64, 74, 84	WES	625A, 500V, 0.15A, 3V	C-47			
T727054524, 34, 44, 54, 64, 74, 84	WES	700A, 500V, 0.15A, 3V	C-47			
T727054834, 44, 54, 64, 74, 84	WES	750A, 500V, 0.15A, 3V	C-47			
T727063524, 34, 44, 54, 74, 84	WES	550A, 600V, 0.15A, 3V	C-47	ECG5386		
T727064034, 44, 54, 64, 74, 84	WES	625A, 600V, 0.15A, 3V	C-47			
T727064524, 34, 44, 54, 64, 74, 84	WES	700A, 600V, 0.15A, 3V	C-47			



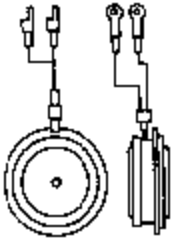

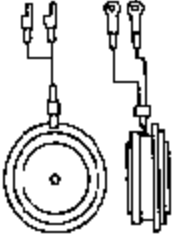
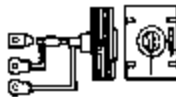

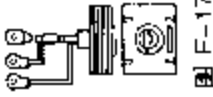
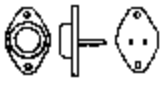
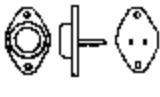
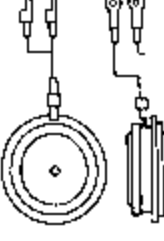
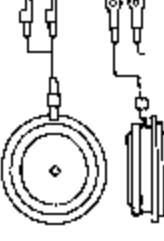
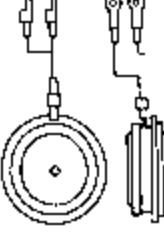
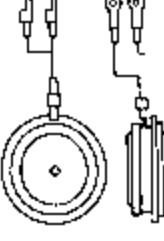
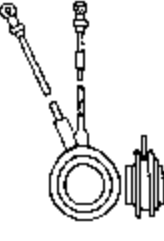

器件型号 Element type	厂名 Manufacturers	材料用途参数 Material Purpose Parameter	图号 Figure	国内外相似替换器件型号 Replace of similar type	备注 Notes	外形参考图 Reference shape
T727064834, 44, 54, 64, 74, 84	WES	750A, 600V, 0.15A, 3V	C-47			 <p>图 C-47</p>
T727073524, 34, 44, 54, 64, 74, 84	WES	550A, 700V, 0.15A, 3V	C-47	ECG5387		
T727074034, 44, 54, 64, 74, 84	WES	625A, 700V, 0.15A, 3V	C-47			
T727074524, 34, 44, 54, 64, 74, 84	WES	700A, 700V, 0.15A, 3V	C-47			
T727074834, 44, 54, 64, 74, 84	WES	750A, 700V, 0.15A, 3V	C-47			
T727083524, 34, 44, 54, 64, 74, 84	WES	550A, 800V, 0.15A, 3V	C-47	ECG5387		
T727084034, 44, 54, 64, 74, 84	WES	625A, 800V, 0.15A, 3V	C-47			
T727084524, 34, 44, 54, 64, 74, 84	WES	700A, 800V, 0.15A, 3V	C-47			
T727084834, 44, 54, 64, 74, 84	WES	750A, 800V, 0.15A, 3V	C-47			
T727093524, 34, 44, 54, 64, 74, 84	WES	550A, 900V, 0.15A, 3V	C-47	ECG5387		
T727094524, 34, 44, 54, 64, 74, 84	WES	700A, 900V, 0.15A, 3V	C-47			
T727103524, 34, 44, 54, 64, 74, 84	WES	550A, 1KV, 0.15A, 3V	C-47	ECG5387		
T727104524, 34, 44, 54, 64, 74, 84	WES	700A, 1KV, 0.15A, 3V	C-47			
T727113524, 34, 44, 54, 64, 74, 84	WES	550A, 1.1KV, 0.15A, 3V	C-47	ECG5387		

器件型号 Element type	厂名 Manufacturers	材料用途参数 Material Purpose Parameter	图号 Figure	国内外相似替换器件型号 Replace of similar type	备注 Notes	外形参考图 Reference shape	
T727114524, 34, 44, 54, 64, 74, 84	WES	700A, 1.1kV, 0.15A, 3V	C-47				
T727123524, 34, 44, 54, 64, 74, 84	WES	550A, 1.2kV, 0.15A, 3V	C 47	ECG5387			
T727124524, 34, 44, 54, 64, 74, 84	WES	700A, 1.2kV, 0.15A, 3V	C-47				
T730013504	WES	550A, 100V, 0.15A, 3V	C-47	ECG5594		 <p>图 C-47</p>	
T730014504	WES	700A, 100V, 0.15A, 3V	C-47	ECG5594			
T730023504	WES	550A, 200V, 0.15A, 3V	C-47	ECG5594			
T730024504	WES	700A, 200V, 0.15A, 3V	C-47	ECG5594			
T730025504	WES	850A, 200V, 0.15A, 3V	C-47	ECG5595			
T730043504	WES	550A, 400V, 0.15A, 3V	C-47	ECG5595			
T730044504	WES	700A, 400V, 0.15A, 3V	C-47	ECG5595			
T730045504	WES	850A, 400V, 0.15A, 3V	C-47	ECG5595			
T730063504	WES	550A, 600V, 0.15A, 3V	C-47	ECG5595			
T730064504	WES	700A, 600V, 0.15A, 3V	C-47	ECG5595			
T730065504	WES	850A, 600V, 0.15A, 3V	C-47	ECG5595			
T760013004	WFS	470A, 100V, 0.15A, 3V	E-17				 <p>图 E-17</p>
T760023004	WES	470A, 200V, 0.15A, 3V	E-17				
T760063004	WES	470A, 600V, 0.15A, 3V	E-17				
T760083004	WES	470A, 800V, 0.15A, 3V	E-17				
T760103004	WES	470A, 1kV, 0.15A, 3V	E-17				
T760123004	WES	470A, 1.2kV, 0.15A, 3V	E-17				
T760133004	WES	470A, 1.3kV, 0.15A, 3V	E-17				
T760143004	WES	470A, 1.4kV, 0.15A, 3V	E-17				
T760153004	WES	470A, 1.5kV, 0.15A, 3V	E-17				
T760163004	WES	470A, 1.6kV, 0.15A, 3V	E-17				
T760173004	WES	470A, 1.7kV, 0.15A, 3V	E-17				



器件型号 Element type	厂名 Manufacturers	材料用途参数 Material Purpose Parameter	图号 Figure	国内外相似替换器件型号 Replace of similar type	备注 Notes	外形参考图 Reference shape
T760203004	WES	470A, 2KV, 0.15A, 3V	E-17			 图 F-17
T760223004	WES	470A, 2.2KV, 0.15A, 3V	E-17			
TA8376		SCR-H 3.2A, 750V	D-9	40888		 图 D-9
TA8377		SCR-H 3.2A, 700V	D-9	40889		
TA16090		SCR-H 3.2A, 750V	D-9	40888		 图 D-9
TA16091		SCR-H 3.2A, 700V	D-9	40889		
TA20061203	WES	1.2kA, 600V, 0.2A, 3V	C-47			 图 C-47
TA20061603	WES	1.6kA, 600V, 0.2A, 3V	C-47			
TA20061803	WES	1.8kA, 600V, 0.2A, 3V	C-47			
TA20081203	WES	1.2kA, 800V, 0.2A, 3V	C-47			 图 C-47
TA20081603	WES	1.6kA, 800V, 0.2A, 3V	C-47			
TA20081803	WES	1.8kA, 800V, 0.2A, 3V	C-47			
TA20101203	WES	1.2kA, 1kV, 0.2A, 3V	C-47			 图 C-47
TA20101603	WES	1.8kA, 1kV, 0.2A, 3V	C-47			
TA20121203	WES	1.2kA, 1.2kV, 0.2A, 3V	C-47			 图 C-47
TA20122603	WES	1.6kA, 1.2kV, 0.2A, 3V	C-47			
TA20141203	WES	1.2kA, 1.4kV, 0.2A, 3V	C-47			 图 C-32
TA20141404	WES	2.2kA, 1.4kV, 0.2A, 3V	C-32			
TA20141603	WES	1.6kA, 1.4kV, 0.2A, 3V	C-47			
TA20161203	WES	1.2kA, 1.6kV, 0.2A, 3V	C-47			
TA20161603	WES	1.6kA, 1.6kV, 0.2A, 3V	C-47			
TA20161803	WES	1.8kA, 1.6kV, 0.2A, 3V	C-47			

器件型号 Element type	厂名 Manufacturers	材料用途参数 Material Purpose Parameter	图号 Figure	国内外相似替换器件型号 Replace of similar type	备注 Notes	外形参考图 Reference shape
TA20181203	WES	1.2kA, 1.8kV, 0.2A, 3V	C-47			
TA20201203	WES	1.2kA, 2kV, 0.2A, 3V	C-47			
TA20201603	WES	1.6kA, 2kV, 0.2A, 3V	C-47			
TA20221203	WES	1.2kA, 2.2kV, 0.2A, 3V	C-47			
TA20221404	WES	2.2kA, 2.2kV, 0.2A, 3V	C-47			
TA20221603	WES	1.6kA, 2.2kV, 0.2A, 3V	C-47			
TAD		0.8A, 100V, 0.005A, 2.2V	B-36			
TAG		0.8A, 100V, 0.01A, 2.2V	B-36			
TAH		0.8A, 100V, 0.025A, 2.2V	B-36			
TAS		0.8A, 100V, 0.003A, 2.2V	B-36			
TAG001-20	TAG	1A, 20V, 0.015A	B-51			
TAG002 20	TAG	1A, 20V, 0.001A	B-51			
TAG1-50...600		50Hz-Thy 1A, 0.05-0.6kV, 0.01A	B-62	BTX30..., S2600..., TAG613..., TiN...		
TAG2-50...600		50Hz-Thy 1A, 0.05-0.6kV, 0.001A	B-62	TAG614...		
TAG2.5-100...800		50Hz Thy 2.5A, 0.1-0.8V, 0.02A	B-62	TAG611 ..., TAG605-...		
TAG2.5 (S)100...800	TAG	2.5A, 0.1-0.8V, 0.02A, 2V	B-51			
TAG3-50...800R		50Hz-Thy 3.2A, 0.05-0.8kV, 0.015A, 0.025A	D-9	BSIC1026...1053, CS6-02...08, TAG671-100...800, TAG676-100...800		
TAG3S100...800	TAG	SCR-H 5A, 0.1-0.8kV, 0.015A, 2V	D-9			
TAG06A		50Hz-Thy 0.5A, 100V, 200μA, 0.005A	B-62	BRV55-100, MCR100-3, TAG70D, TAG72D		







器件型号 Element type	厂名 Manufacturers	材料用途参数 Material Purpose Parameter	图号 Figure	国内外相似替换器件型号 Replace of similar type	备注 Notes	外形参考图 Reference shape
TAG06B		50Hz-Thy 0.5A, 200V, 200 μ A, 0.005A	B-62	BRY55-200, MCR100-4, TAG70D, TAG72D		
TAG06C		50Hz-Thy 0.5A, 300V, 200 μ A, 0.005A	B-62	BRY55-300, MCR100-5, TAG70D, TAG72D		
TAG06D		50Hz-Thy 0.5A, 400V, 200 μ A, 0.005A	B-62	BRY55-300, MCR100-6, TAG70D, TAG72D		
TAG06Y		50Hz-Thy 0.5A, 30V, 200 μ A, 0.005A	B-62	BRY55-30, MCR100-3, TAG70D, TAG72D		
TAG06YY		50Hz-Thy 0.5A, 60V, 200 μ A, 0.005A	B-62	BRY55-60, MCR100-3, TAG70D, TAG72D		
TAG06 400	TAG	0.6A, 400V, 200 μ A, 1V	B-65			
TAG6-50...1000(R)		50Hz-Thy 6A, 0.05-1kV, 0.025A	D-9			
TAG6S-50...1000(R)		SCR-H 6A, 0.05-1kV, 0.025A	D-9			
TAG6S-50...1000(R)	TAG	7.5A, 0.1-1kV, 0.025A, 2V	D-9			
TAG7-50...1000(R)		50Hz-Thy 6A, 0.05-1kV, 0.025A	F-55	C35..., MCR64..., TAG35..., T12N...		
TAG7S-50...1000(R)		SCR-H 6A, 0.05-1kV, 0.025A	F-55	TAG15S..., T12F...		
TAG7-50...1000(R)	TAG	SCR-H 7.5A, 0.05-1kV, 0.025A, 2V	F-48			
TAG9N400...1000	TAG	50Hz-Thy 17A, 0.4-1kV, 0.05A, 2V	F-48	BTW39/..., BTW45/..., TAG14N..., IAG15...		
TAG10-50...1000		50Hz-Thy 6.3A, 0.05-1kV, 0.03A	F-55	CS35..., MCR64..., TAG35..., T12N...		
TAG10-(S)100	TAG	SCR-H 10A, 100V, 0.025A, 3V	F-48	TAG15S-100, T12F100COB		
TAG10-(S)200	TAG	SCR-H 10A, 200V, 0.025A, 3V	F-48	TAG15S-200, T12F200COB		
TAG10-(S)300	TAG	SCR-H 10A, 300V, 0.03A, 0.025A	F-55	TAG15S-300, T12F300COB		
TAG10-(S)400	TAG	SCR H 10A, 400V, 0.025A, 3V	F-48	TAG15S-400, T12F400COB		
TAG10-(S)500	TAG	SCR-H 10A, 500V, 0.025A, 3V	F-48	TAG15S-500, T12F500COB		
TAG10-(S)600	TAG	SCR-H 10A, 600V, 0.025A, 3V	F-48	TAG15S-600, T12F600COB		
TAG10-(S)700	TAG	SCR-H 10A, 700V, 0.025A, 3V	F-48	TAG15S-700, T12F700COB		
TAG10-(S)800	TAG	SCR-H 10A, 800V, 0.025A, 3V	F-48	TAG15S-800, T12F800COB		
TAG10-(S)900	TAG	SCR-H 10A, 900V, 0.025A, 3V	F-48	TAG15S-900, T12F900COB		
TAG10-(S)1000	TAG	SCR-H 10A, 1kV, 0.025A, 3V	F-48	TAG15S-1000, T12F1000COB		
TAG12F400	TAG	SCR-H 25A, 400V, 0.075A, 2.5V	F-48	TAG16F400, TAG19F400, T17F400C, T24F400C		
TAG12F600	TAG	SCR-H 25A, 600V, 0.075A, 2.5V	F-48	TAG16F600, TAG19F600, T17F600C, T24F600C		
TAG12F800	TAG	SCR-H 25A, 800V, 0.075A, 2.5V	F-48	TAG16F800, TAG19F800, T17F800C, T24F800C		

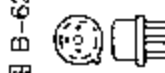
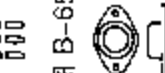

图 B-62

图 B-65

图 D-9

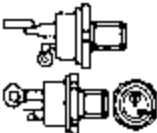

图 F-55

图 F-48

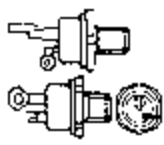
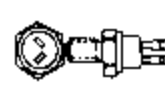

器件型号 Element type	厂名 Manufacturers	材料用途参数 Material Purpose Parameter	图号 Figure	国内外相似替换器件型号 Replace of similar type	备注 Notes	外形参考图 Reference shape
TAG12F900	TAG	SCR-H 25A, 900V, 0.075A, 2.5V	F-48	TAG16F900, TAG19F900, T17F1000C, T24F900C		 图 F-48
TAG12F1000	TAG	SCR-H 25A, 1kV, 0.075A, 2.5V	F-48	TAG16F1000, TAG19F1000, T17F1000C		
TAG14N400	TAG	50Hz-Thy 25A, 400V, 0.05A, 2V	F-48	BTW39-400, BTW45-400R, S4025H, T12N400COB		 图 F-55
TAG14N600	TAG	50Hz-Thy 25A, 600V, 0.05A, 2V	F-48	BTW39-600, BTW45-600R, S6025H, T12N600COB		
TAG14N800	TAG	50Hz-Thy 25A, 800V, 0.05A, 2V	F-48	BTW39-800, BTW45-800R, T12N800COB		
TAG14N900	TAG	50Hz Thy 25A, 900V, 0.05A, 2V	F-48	BTW39-900, BTW45-1000R, T12N900COB		
TAG14N1000	TAG	50Hz-Thy 25A, 1kV, 0.05A, 2V	F-48	BTW39-1000, BTW45-1000R, T12N1000COB		
TAG15-100		50Hz-Thy 15A, 100V, 0.05A	F-55	BTW39-100, T12N100COB		
TAG15-200		50Hz-Thy 15A, 200V, 0.05A	F-55	BTW39-200, T12N200COB		
TAG15-300		50Hz-Thy 15A, 300V, 0.05A	F-55	BTW39-300, T12N300COB		
TAG15-400		50Hz-Thy 15A, 400V, 0.05A	F-55	BTW39-400, BTW45-400R, T12N400COB		
TAG15-500		50Hz-Thy 15A, 500V, 0.05A	F-55	BTW39-500, BTW45-500R, T12N500COB		
TAG15-600		50Hz-Thy 15A, 600V, 0.05A	F-55	BTW39-600, BTW45-600R, T12N600COB		
TAG15-700		50Hz-Thy 15A, 700V, 0.05A	F-55	BTW39-700, BTW45-700R, T12N700COB		
TAG15-800		50Hz-Thy 15A, 800V, 0.05A	F-55	BTW39-800, BTW45-800R, T12N800COB		
TAG15-900		50Hz-Thy 15A, 900V, 0.05A	F-55	BTW39-900, BTW45-900R, T12N900COB		
TAG15-1000		50Hz-Thy 15A, 1kV, 0.05A	F-55	BTW39-1000, BTW45-1000R, T12N1000COB		
TAG15-(S)100	TAG	SCR-H 15A, 100V, 0.05A, 3V	F-48	T12F100COB		
TAG15-(S)200	TAG	SCR-H 15A, 200V, 0.05A, 3V	F-48	T12F200COB		
TAG15-(S)400	TAG	SCR-H 15A, 400V, 0.05A, 3V	F-48	T12F400COB		
TAG15-(S)500	TAG	SCR-H 15A, 500V, 0.05A, 3V	F-48	T12F500COB		
TAG15-(S)600	TAG	SCR-H 15A, 600V, 0.05A, 3V	F-48	T12F600COB		
TAG15-(S)700	TAG	SCR-H 15A, 700V, 0.05A, 3V	F-48	T12F700COB		
TAG15-(S)800	TAG	SCR-H 15A, 800V, 0.05A, 3V	F-48	T12F800COB		
TAG15-(S)900	TAG	SCR-H 15A, 900V, 0.05A, 3V	F-48	T12F900COB		
TAG15-(S)1000	TAG	SCR-H 15A, 1kV, 0.05A, 3V	F-48	T12F1000COB		
TAG16F400	TAG	SCR-H 30A, 400V, 0.075A, 2.5V	F-48	TAG19F400, T17F400C, T24F400C		
TAG16F600	TAG	SCR-H 30A, 600V, 0.075A, 2.5V	F-48	TAG19F600, T17F600C, T24F600C		

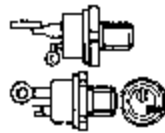





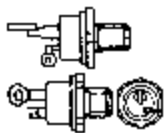

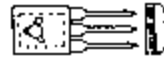



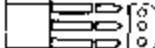



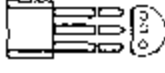

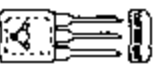

器件型号 Element type	厂名 Manufacturers	材料用途参数 Material Purpose Parameter	图号 Figure	国内外相似替换器件型号 Replace of similar type	备注 Notes	外形参考图 Reference shape	
TAG16F800	TAG	SCR-H 30A, 800V, 0.075A, 2.5V	F-48	TAG19F800, T17F800C, T24F800C		 <p>图 F-48</p>	
TAG16F900	TAG	SCR-H 30A, 900V, 0.075A, 2.5V	F-48	TAG19F900, T17F1000C, T24F900C			
TAG16F1000	TAG	SCR-H 30A, 1kV, 0.065A, 2.5V	F-48	TAG19F1000, T17F1000C, T24F1000C			
TAG16N400	TAG	SCR-H 30A, 400V, 0.05A, 2V	F-48	BTW92-400R, S4035H, T17N400BOB, T24N400BOB			
TAG16N600	TAG	SCR-H 30A, 600V, 0.05A, 2V	F-48	BTW92-600R, S6035H, T17N600BOB, T24N600BOB			
TAG16N800	TAG	SCR-H 30A, 800V, 0.05A, 2V	F-48	BTW92-800R, T17N800BOB, T24N800BOB			
TAG16N900	TAG	SCR-H 30A, 900V, 0.05A, 2V	F-48	BTW92-1000R, T17N1000BOB, T24N1000BOB			
TAG16N1000	TAG	SCR-H 30A, 1kV, 0.05A, 2V	F-48	BTW92-1000R, T17N1000BOB, T24N1000BOB			
TAG16N1100	TAG	SCR-H 30A, 1.1kV, 0.05A, 2V	F-48	BTW92-1200R, T17N1200BOB, T24N1200BOB			
TAG16N1200	TAG	SCR-H 30A, 1.2kV, 0.05A, 2V	F-48	BTW92-1200R, T17N1200BOB, T24N1200BOB			
TAG16N1300	TAG	SCR-H 30A, 1.3kV, 0.05A, 2V	F-48	BTW92-1200R, T17N1200BOB, T24N1200BOB			
TAG16N1400	TAG	SCR-H 30A, 1.4kV, 0.05A, 2V	F-48	BTW92-1400R, T17N1400BOB, T24N1400BOB			
TAG19F400~1000	SCR-H	19A, 0.4~1kV, 0.075A, 0.1A	F-55	T17F...C, T24F...C			 <p>图 F-55</p>
TAG20-50~1000	50Hz-Thy	20A, 0.05~1kV, 0.05A	F-55	BTW92..., CS16..., T17N..., T24N...			
TAG20S-50	SCR-H	20A, 50V, 0.05A, 3V	F-55				
TAG20S-100	SCR-H	20A, 100V, 0.05A, 3V	F-55				
TAG20S-200	SCR-H	20A, 200V, 0.05A, 3V	F-55				
TAG20S-300	SCR-H	20A, 300V, 0.05A, 3V	F-55				
TAG20S-400	SCR-H	20A, 400V, 0.05A, 3V	F-55				
TAG20S-500	SCR-H	20A, 500V, 0.05A, 3V	F-55				
TAG20S-600	SCR-H	20A, 600V, 0.05A, 3V	F-55				
TAG20S-700	SCR-H	20A, 700V, 0.05A, 3V	F-55				
TAG20S-800	SCR-H	20A, 800V, 0.05A, 3V	F-55				
TAG20S-900	SCR-H	20A, 900V, 0.05A, 3V	F-55				
TAG20S-1000	SCR-H	20A, 1kV, 0.05A, 3V	F-55				
TAG20S200	TAG	20A, 200V, 0.05A, 3V	F-48				
TAG20S400	TAG	20A, 400V, 0.05A, 3V	F-48				

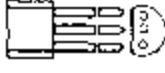
器件型号 Element type	厂名 Manufacturers	材料用途参数 Material Purpose Parameter	图号 Figure	国内外相似替换器件型号 Replace of similar type	备注 Notes	外形参考图 Reference shape	
TAG24N400	TAG	50Hz-Thy 40A, 400V, 0.05A, 2V	F-48	CS23-10, S4035H, T24N400BOB		 图 F-48	
TAG24N600	TAG	50Hz-Thy 24A, 600V, 0.05A, 2V	F-48	CS23-10, S6035H, T24N600BOB			
TAG24N800	TAG	50Hz-Thy 24A, 800V, 0.05A, 2V	F-48	CS23-10, T24N800BOB			
TAG24N900	TAG	50Hz-Thy 24A, 900V, 0.15A, 2V	F-48	CS23-10, T24N1000BOB			
TAG24N1000	TAG	50Hz-Thy 24A, 1kV, 0.05A, 2V	F-48	CS23-10, T24N1000BOB			
TAG24N1100	TAG	50Hz-Thy 24A, 1.1kV, 0.05A	F-55	CS23-10, T24N1100BOB			
TAG24N1200	TAG	50Hz-Thy 24A, 1.2kV, 0.05A	F-55	CS23-10, T24N1200BOB			
TAG24N1300	TAG	50Hz-Thy 24A, 1.3kV, 0.05A	F-55	CS23-10, T24N1400BOB			
TAG24N1400	TAG	50Hz-Thy 24A, 1.4kV, 0.05A	F-55	CS23-10, T24N1400BOB			
TAG35-100		50Hz-Thy 35A, 100V, 0.04A	F-55	MCR64-3			 图 F-55
TAG35-200		50Hz-Thy 35A, 200V, 0.04A	F-55	MCR64-4			
TAG35-300		50Hz-Thy 35A, 300V, 0.04A	F-55	MCR64-5			
TAG35-400		50Hz-Thy 35A, 400V, 0.04A	F-55	MCR64-6			
TAG35-500		50Hz-Thy 35A, 500V, 0.04A	F-55	MCR64-7			
TAG35-600		50Hz Thy 35A, 600V, 0.04A	F-55	MCR64-8			
TAG35-700		50Hz-Thy 35A, 700V, 0.04A	F-55	MCR64-9			
TAG35-800		50Hz-Thy 35A, 800V, 0.04A	F-55	MCR64-10			
TAG35-900		50Hz-Thy 35A, 900V, 0.04A	F-55				
TAG35-1000		50Hz-Thy 35A, 1kV, 0.04A	F-55				
TAG35-(S)100	TAG	SCR-H 35A, 100V, 0.04A, 2V	F-48				
TAG35-(S)200	TAG	SCR-H 35A, 200V, 0.04A, 2V	F-48				
TAG35-(S)300	TAG	SCR-H 35A, 300V, 0.04A, 2V	F-48				
TAG35-(S)400	TAG	SCR-H 35A, 400V, 0.04A, 2V	F-48				
TAG35-(S)500	TAG	SCR-H 35A, 500V, 0.04A, 2V	F-48				
TAG35-(S)600	TAG	SCR-H 35A, 600V, 0.04A, 2V	F-48				
TAG35-(S)700	TAG	SCR-H 35A, 700V, 0.04A, 2V	F-48				
TAG35-(S)800	TAG	SCR-H 35A, 800V, 0.04A, 2V	F-48				
TAG35-(S)900	TAG	SCR-H 35A, 900V, 0.04A, 2V	F-48				

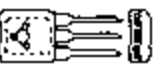

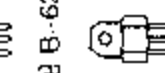
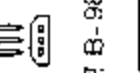

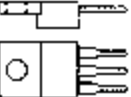
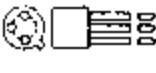

器件型号 Element type	厂名 Manufacturers	材料用途参数 Material Purpose Parameter	图号 Figure	国内外相似替换器件型号 Replace of similar type	备注 Notes	外形参考图 Reference snape
TAG35-(S)1000	TAG	SCR-H 35A, 1kV, 0.04A, 2V	F-48			
TAG59A		50Hz-Thy 1A, 100V, 200 μ A	B-35	BT149A, MCR606-3, 2N6681, 2N6682, 2N6683, 2N6684, 2N6685		 图 F-48
TAG59B		50Hz-Thy 1A, 200V, 200 μ A	B-35	BT149B, MCR606-4, 2N6682, 2N6683, 2N6684, 2N6685		
TAG59D		50Hz-Thy 1A, 400V, 200 μ A	B-35	BT149D, MCR606-6, 2N6683, 2N6684, 2N6685		
TAG59E		50Hz-Thy 1A, 500V, 200 μ A	B-35	BT149E, MCR606-7, 2N6684, 2N6685		
TAG59F		50Hz-Thy 1A, 50V, 200 μ A	B-35	BT149F, MCR606-2, 2N6681, 2N6682, 2N6683, 2N6684, 2N6685		
TAG59M		50Hz-Thy 1A, 600V, 200 μ A	B-35	BT149M, MCR606-8, 2N6684, 2N6685		
TAG59S		50Hz-Thy 1A, 700V, 200 μ A	B-35	2N6685		
TAG60A		SCR-H 0.8A, 100V, 200 μ A	B-35	BRX46...BRX56, TAG62A		
TAG60F		SCR-H 0.8A, 50V, 200 μ A	B-35	BRX46...BRX56, TAG62F		 图 B-35
TAG60Y		SCR-H 0.8A, 30V, 200 μ A	B-35	BRX46...BRX56, TAG62Y		 图 B-62
TAG62A		SCR-H 0.8A, 100V, 200 μ A	B-35	BRX46...BRX56, TAG60A		
TAG62F		SCR-H 0.8A, 50V, 200 μ A	B-35	BRX46...BRX56, TAG60F		
TAG62Y		SCR-H 0.8A, 30V, 200 μ A	B-35	BRX44...BRX56, TAG60Y		
TAG64A		SCR-H 0.65A, 100V, 200 μ A	B-62	BRX44...BRX56, TAG60A		
TAG64F		SCR-H 0.65A, 50V, 200 μ A	B-62	BRX44...BRX56, TAG60F		
TAG64Y		SCR-H 0.65A, 30V, 200 μ A	B-62	BRX44...BRX56, TAG60Y		 图 B-81
TAG66A		SCR-H 0.65A, 100V, 200 μ A	B-81	BRX60...BRX66		
TAG66F		SCR-H 0.65A, 50V, 200 μ A	B-81	BRX60...BRX66		
TAG66Y		SCR-H 0.65A, 30V, 200 μ A	B-81	BRX60...BRX66		
TAG70D		50Hz-Thy 0.5A, 400V, 200 μ A	B-35	BRY55/400, TAG72D, 2N6683, 2N6684, 2N6685		

器件型号 Element type	厂名 Manufacturers	材料 Material	用途 Purpose	参数 Parameter	图号 Figure	国内外相似替换器件型号 Replace of similar type	备注 Notes	外形参考图 Reference shape
TAG70E		50Hz-Thy	0.5A, 500V, 200 μ A		B-35	BRY55/500, TAG72E, 2N6684, 2N6685		
TAG70M		50Hz-Thy	0.5A, 600V, 200 μ A		B-35	BRY55/600, TAG72M, 2N6684, 2N6685		
TAG70N		50Hz-Thy	0.5A, 800V, 200 μ A		B-35	BRY55/800, TAG72N, 2N6685		
TAG70S		50Hz-Thy	0.5A, 700V, 200 μ A		B-35	BRY55/700, TAG72S, 2N6685		
TAG72D		50Hz-Thy	0.8A, 400V, 200 μ A, 0.8V		B-36	BRY55-400, TAG72D, 2N6681...2N6685		
TAG72E	TAG	50Hz-Thy	0.8A, 500V, 200 μ A, 0.8V		B-36	BRY55-500, TAG72E, 2N6681...2N6685		
TAG72M	TAG	50Hz-Thy	0.8A, 600V, 200 μ A, 0.8V		B-36	BRY55-600, TAG72M, 2N6681...2N6685		
TAG72N	TAG	50Hz-Thy	0.8A, 800V, 200 μ A, 0.8V		B-36	BRY55-800, TAG72N, 2N6681...2N6685		
TAG72S	TAG	50Hz-Thy	0.8A, 700V, 200 μ A, 0.8V		B-36	BRY55-700, TAG72S, 2N6681...2N6685		
TAG92A, -3		Triac	0.6A, 100V, 0.01A		B-35	MAC91-3, MAC94-3, TAG94A, Z0106B		
TAG92B, -4		Triac	0.6A, 200V, 0.01A		B-35	MAC91-4, MAC94-4, TAG94B, Z0106B		
TAG92C, -5		Triac	0.6A, 300V, 0.01A		B-35	MAC91-5, MAC94-5, TAG94C, Z0106D		
TAG92D, -6		Triac	0.6A, 400V, 0.01A		B-35	MAC91-6, MAC94-6, TAG94D, Z0106D		
TAG92Y, -1		Triac	0.6A, 30V, 0.01A		B-35	MAC91-2, MAC94-2, TAG94Y, Z0106B		
TAG92YY, -2		Triac	0.6A, 60V, 0.01A		B-35	MAC91-3, MAC94-3, TAG94YY, Z0106B		
TAG92B1	TAG	Triac	0.35A, 30V, 0.01A, 2V		B-36			
TAG92B2	TAG	Triac	0.35A, 60V, 0.01A, 2V		B-36			
TAG92B3	TAG	Triac	0.35A, 100V, 0.01A, 2V		B-36			
TAG92B4	TAG	Triac	0.35A, 200V, 0.01A, 2V		B-36			
TAG92B5	TAG	Triac	0.35A, 300V, 0.01A, 2V		B-36			
TAG92B6	TAG	Triac	0.35A, 400V, 0.01A, 2V		B-36			
TAG92-1	TAG	Triac	0.35A, 30V, 0.005A, 2V		B-36	MAC91-2, MAC94-2, TAG94Y, Z0106B		
TAG92-2	TAG	Triac	0.35A, 60V, 0.005A, 2V		B-36	MAC91-3, MAC94-3, TAG94YY, Z0106B		
TAG92-3	TAG	Triac	0.35A, 100V, 0.005A, 2V		B-36	MAC91-3, MAC94-3, TAG94A, Z0106B		
TAG92-4	TAG	Triac	0.35A, 200V, 0.005A, 2V		B-36	MAC91-4, MAC94-4, TAG94B, Z0106B		
TAG92-5	TAG	Triac	0.35A, 300V, 0.005A, 2V		B-36	MAC91-5, MAC94-5, TAG94C, Z0106D		
TAG92-6	TAG	Triac	0.35A, 400V, 0.005A, 2V		B-36	MAC91-6, MAC94-6, TAG94D, Z0106D		

器件型号 Element type	厂名 Manufacturers	材料用途参数 Material Purpose Parameter	图号 Figure	国内外相似替换器件型号 Replace of similar type	备注 Notes	外形参考图 Reference shape
TAG92-A1	TAG	Triac 0.35A, 30V, 0.005A, 2V	B-36			
TAG92-A2	TAG	Triac 0.35A, 60V, 0.005A, 2V	B-36			
TAG92-A3	TAG	Triac 0.35A, 100V, 0.005A, 2V	B-36			
TAG92-A4	TAG	Triac 0.35A, 200V, 0.005A, 2V	B-36			
TAG92-A5	TAG	Triac 0.35A, 300V, 0.005A, 2V	B-36			
TAG92-A6	TAG	Triac 0.35A, 400V, 0.005A, 2V	B-36			
TAG93A...YY		Triac =TAG92A...YY: 0.005A	B-35	MAC92(A)..., MAC95..., ZD104...		
TAG94A...YY		Triac =TAG92A...YY: 0.01A	B-35	MAC91A...3, MAC94..., ZD106		
TAG96A		Triac 4A, 100V, 0.025A	B-81	2N6070, 2N671, 2N6072, 2N6073, 2N6074, 2N6075		
TAG96B		Triac 4A, 200V, 0.025A	B-81	2N6071, 2N6072, 2N6073, 2N6074, 2N6075		
TAG96C		Triac 4A, 300V, 0.025A	B-81	2N6072, 2N6073, 2N6074, 2N6075		
TAG96D		Triac 4A, 400V, 0.025A	B-81	2N6073, 2N6074, 2N6075		
TAG96E		Triac 4A, 500V, 0.025A	B-81	2N6074, 2N6075		
TAG96M		Triac 4A, 600V, 0.025A	B-81	2N6075		
TAG97A		Triac 4A, 100V, 0.01A	B-81	2N6070A...6075A		
TAG97B		Triac 4A, 200V, 0.01A	B-81	2N6070A...6075A		
TAG97C		Triac 4A, 300V, 0.01A	B-81	2N6070A...6075A		
TAG97D		Triac 4A, 400V, 0.01A	B-81	2N6070A...6075A		
TAG97E		Triac 4A, 500V, 0.01A	B-81	2N6070A...6075A		
TAG97M		Triac 4A, 600V, 0.01A	B-81	2N6070A...6075A		
TAG98A...M		Triac 4A, 100-600V, 0.005A	B-81	2N6070B...2N6075B		
TAG103X		SCR-H 1A, 30V, 200μA, 0.002A	B-62	BR203, TAG64A, TAG64F, TAG64Y		
TAG106A...M		50Hz-Thy 4A, 100-600V, 200μA, 0.8V	B-98	C106A...M, C108A...M, TAG106B...M		
TAG106-50	TAG	4A, 50V, 200μA, 0.8V				
TAG106-100	TAG	4A, 100V, 200μA, 0.8V				
TAG106-200	TAG	4A, 200V, 200μA, 0.8V				

器件型号 Element type	厂名 Manufacturers	材料用途参数 Material Purpose Parameter	图号 Figure	国内外相似替换器件型号 Replace of similar type	备注 Notes	外形参考图 Reference shape
TAG106-300	TAG	4A, 300V, 200 μ A, 0.8V				
TAG106-400	TAG	4A, 400V, 200 μ A, 0.8V				
TAG106-500	TAG	4A, 500V, 200 μ A, 0.8V				
TAG106-600	TAG	4A, 600V, 200 μ A, 0.8V				
TAG107A...M		50Hz-Thy 4A, 100-600V, 500 μ A, 0.8V	B-98	C107A...M, S2061A...M, TIC108A...M		
TAG107-50...600	TAG	4A, 50-600V, 500 μ A, 0.8V	B-98			
TAG108A...M		50Hz-Thy 4A, 100-600V, 200 μ A, 0.8V	B-98	C108A...M, TAG623-100...600, TAG628-100...600, TAG106A...M		
TAG122-100...600		50Hz-Thy 6A, 100-600V, 0.25A, 1.5V	B-11	BSIC1026M, CS6-02...07, C122A...M, TIC116A...M		
TAG136A...M		Triac 4A, 100-600V, 0.025A, 0.05A	B-98	TAG96A, 2N6068...6075		
TAG137A...M		Triac 4A, 100-600V, 0.01A, 0.025A	B-98	TAG97A, ZD409B, 2N6068A...6075A		
TAG138A...M		Triac 4A, 100-600V, 0.005A, 0.01A	B-98	TAG98... , ZD405... , 2N6068B...2N6075B		
TAG200-100...600		Triac 2A, 100-600V, 0.025A	B-62	T2303A...M, TAG208-100...600, TAG620-100...600, TAG630-100...600		
TAG201-100...600		Triac 2A, 100-600V, 0.01A	B-62	T2302A...M, TAG202A-100...600, TAG203-100...600, TAG209-100...600		
TAG202-100...600		Triac 4A, 100-600V, 0.01A	B-62	TAG202A-100...600, TAG203-100...600, TAG209-100...600		
TAG202A-100...600		Triac 4A, 100-600V, 0.01A	B-62	TAG203-100...600, TAG209-100...600, ZD409B...M		
TAG202A200	TAG	2.5A, 200V, 0.01A, 1.8V	B-51			
TAG202A400	TAG	2.5A, 400V, 0.01A, 1.8V	B-51			
TAG203-100...600		Triac 4A, 100-600V, 0.01A	B-62	TAG203A100...600, TAG209-100...600, ZD409B...M		
TAG203A-100...600		Triac 4A, 100-600V, 0.01A	B-62	TAG209-100...600, ZD409B...M, 2N6068A...		



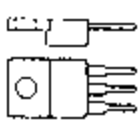
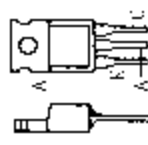

器件型号 Element type	厂名 Manufacturers	材料用途参数 Material: Purpose Parameter	图号 Figure	国内外相似替换器件型号 Replace of similar type	备注 Notes	外形参考图 Reference shape	
TAG203A100	TAG	2.5A, 100V, 0.005A, 1.8V	B-51				
TAG203A200	TAG	2.5A, 200V, 0.005A, 1.8V	B-51				
TAG203A400	TAG	2.5A, 400V, 0.005A, 1.8V	B-51				
TAG204(A)-100		Triac 4A, 100V, 0.005A	B-62	TAG204A100, TAG205-100, Z0405R			
TAG204(A)-200		Triac 4A, 200V, 0.005A	B-62	TAG204A200, TAG205-200, Z0405B			
TAG204(A)-300		Triac 4A, 300V, 0.005A	B-62	TAG204A300, TAG205-300, Z0405D			
TAG204(A)-400		Triac 4A, 400V, 0.005A	B-62	TAG204A400, TAG205-400, Z0405D			
TAG204(A)-500		Triac 4A, 500V, 0.005A	B-62	TAG204A500, TAG205-500, Z0405M			
TAG204(A)-600		Triac 4A, 600V, 0.005A	B-62	TAG204A600, TAG205-600, Z0405M			
TAG204A100	TAG	2.5A, 100V, 0.003A, 1.8V	B-51				
TAG204A200	TAG	2.5A, 200V, 0.003A, 1.8V	B-51				
TAG204A400	TAG	2.5A, 400V, 0.003A, 1.8V	B-51				
TAG205-100		Triac 4A, 100V, 0.005A, 2.5V	B-62	L1003M9, TAG204A100, TAG205-100, Z0405B			
TAG205-200	TAG	Triac 4A, 200V, 0.005A, 2.5V	B-62	L2003M9, TAG204A200, TAG205-200, Z0405B			
TAG205-300	TAG	Triac 4A, 300V, 0.005A, 2.5V	B-62	L3003M9, TAG204A300, TAG205-300, Z0405D			
TAG205-400	TAG	Triac 4A, 400V, 0.005A, 2.5V	B-62	L4003M9, TAG204A400, TAG205-400, Z0405D			
TAG205-500	TAG	Triac 4A, 500V, 0.025A, 2.5V	B-51	L5003M9, TAG204A500, TAG205-500, Z0405M			
TAG205-600	TAG	Triac 4A, 600V, 0.025A, 2.5V	B-51	L6003M9, TAG204A600, TAG205-600, Z0405M			
TAG206-100...600	TAG	Triac 4A, 100-600V, 0.003A, 2.5V	B-62	L1003M7...6003M7, TAG207-100...600, Z0402...			
TAG207-100...600	TAG	Triac 4A, 100-600V, 0.003A	B-62	TAG207-100...600, Z0402BE...ME, Z0402BF...MF			
TAG208-100...600		Triac 4A, 100-600V, 0.025A	B-62	TAG220-100...600, TAG231-100...600, TAG421-100...600, Z0410B...M			
TAG209-100...600		Triac 4A, 100-600V, 0.01A	B-62	TAG202A100...600, TAG203-100...600, Z0409B...			
TAG220-100...800		Triac 6A, 100-800V, 0.025A	B-11	TAG225-100...800, TAG257-100...800			
TAG221-100...800		Triac 6A, 100-800V, 0.01A	B-11	MAC228A3...10, TAG226-100...800, TXC18G40M			
TAG222-100...800		Triac 6A, 100-800V, 0.005A, 0.01A	B-11	TAG227-100...800			
TAG224-100...800		Triac 8A, 100-800V, 0.05A	B-11	BT137/..., MAC222A..., T2800..., T2850...			

器件型号 Element type	厂名 Manufacturers	材料用途参数 Material Purpose Parameter	图号 Figure	国内外相似替换器件型号 Replace of similar type	备注 Notes	外形参考图 Reference shape
TAG225-100...800	Triac	8A, 100-800V, 0.025A	B-11	MAC228A..., TAG252-100...800, TAG257-100...800, TAG426-100...800, TAG452-100...800 MAC228A3...10		 图 B-11
TAG226-100...800	Triac	8A, 100-800V, 0.01A	B-11			
TAG227-100...800	Triac	8A, 100-800V, 0.005A	B-11			
TAG230-200...800	Triac	5A, 200-800V, 0.05A	B-11	MAC222A3...A10, TAG224-200...800		
TAG231-200...800	Triac	5A, 200-800V, 0.025A	B-11	TAG220-200...800, TAG225-200...800, TAG257-200...800		
TAG232-200...800	Triac	5A, 200-800V, 0.01A	B-11	MAC228A4...A10, TAG221-200...800, TXC18G40M...80M		
TAG233-200...800	Triac	5A, 200-800V, 0.005A	B-11	TAG222-200...800, TAG227-200...800, TXC18D40M...80M		
TAG240-100...800	Triac	6.5A, 100-800V, 0.05A	B-11	MAC222-3...10, TIC226..., TW7N100...800FZ, T2802...		
TAG241-100...800	Triac	6.5A, 100-800V, 0.025A	B-11	TAG252-100...800, TAG257-100...800, T2806A...N		 图 B-91
TAG245-100...800	Triac	8A, 100-800V, 0.05A	B-11	MAC222 3...10, TAG224 100...800, T2802..., TIC226...		
TAG246-100...800	Triac	8A, 100-800V, 0.025A	B-11	TAG225-100...800, TAG257-100...800, T2806...		
TAG250(A) -100...800	Triac	10A, 100-800V, 0.075A	B-11	BT138..., TAG251-..., TXD10H...M		
TAG250A200	TAG	10A, 200V, 0.05A, 2.5V	B-91			
TAG250A400	TAG	10A, 400V, 0.05A, 2.5V	B-91			
TAG250A600	TAG	10A, 600V, 0.05A, 2.5V	B-91			
TAG250A800	TAG	10A, 800V, 0.05A, 2.5V	B-91			

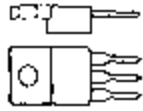
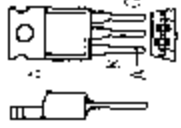
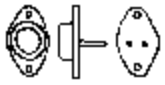
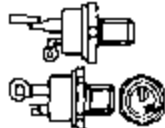

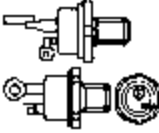
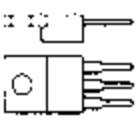

器件型号 Element type	厂名 Manufacturers	材料 Material	用途 Purpose	参数 Parameter	图号 Figure	国内外相似替换器件型号 Replace of similar type	备注 Notes	外形参考图 Reference shape
TAG251-100...800	Triac	10A, 100-800V, 0.05A			B-11	BT138/..., TAG255-..., TXD10H...M		
TAG252-100...800	Triac	10A, 100-800V, 0.025A			B-11	TAG257-100...800		
TAG255(A)-100		12A, 100V, 0.075A, 0.05A			B-11	TAG256-100		
TAG255(A)-200	Triac	12A, 200V, 0.075A, 0.05A			B-11	TAG256-200		
TAG255(A)-300	Triac	12A, 300V, 0.075A, 0.05A			B-11	TAG256-300		
TAG255(A)-400	Triac	12A, 400V, 0.075A, 0.05A			B-11	TAG256-400, TXD10H40P		
TAG255(A)-500	Triac	12A, 500V, 0.075A, 0.05A			B-11	BT138-500, TAG256-500, TXD10H50P		
TAG255(A)-600	Triac	12A, 600V, 0.075A, 0.05A			B-11	BT138-600, TAG256-600, TXD10H60P		
TAG255(A)-700	Triac	12A, 700V, 0.075A, 0.05A			B-11	BT138-700, TAG256-700, TXD10H70P		
TAG255(A)-800	Triac	12A, 800V, 0.075A, 0.05A			B-11	BT138-800, TAG256-800, TXD10H80P		
TAG255A200...800	TAG	12A, 200-800V, 0.05A, 2.5V			B-91			
TAG256-100...800	Triac	12A, 100-800V, 0.05A			B-11	BT138/..., TAG255-..., TXD10H...P, 2N6346A...		
TAG257-100...800	Triac	12A, 100-800V, 0.025A			B-11			
TAG260-100...800	Triac	8A, 100-800V, 0.05A			D-9	TAG224-100...800, TAG265-100...800, T4700...		
TAG261-100...800	Triac	8A, 100-800V, 0.025A			D-9	Q6008L4, TAG225 100...800, TAG252-100...800, TAG265-100...800		
TAG265-100...800	Triac	12A, 100-800V, 0.05A			D-9	BT138/..., TAG255-..., T4700...		
TAG266-100...800	Triac	12A, 100-800V, 0.025A			D-9	TAG257-100...800		
TAG270-100	TAG	10A, 100V, 0.05A, 2.5V			F-48	BS10-01A, SC245B, TXD99A20, T4110A		
TAG270-200	TAG	10A, 200V, 0.05A, 2.5V			F-48	BS10-02A, SC245B, TXD99A20, T4110B		
TAG270-300	TAG	10A, 300V, 0.05A, 2.5V			F-48	BS10-03A, SC245C, TXD99A30, T4110C		
TAG270-400	IAG	10A, 400V, 0.05A, 2.5V			F-48	BS10-04A, SC245D, TXD99A40, T4110D		
TAG270-500	TAG	10A, 500V, 0.05A, 2.5V			F-48	BS10-05A, SC245E, TXD99A50, T4110E		
TAG270-600	TAG	10A, 600V, 0.05A, 2.5V			F-48	BS10-06A, SC245M, TXD99A60, T4110M		
TAG271-100	TAG	10A, 100V, 0.025A, 2.5V			F-48	T4111A, T4116A, T4117A		

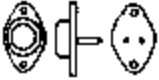
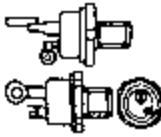

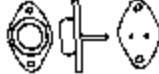
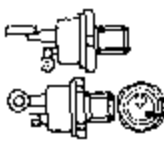
器件型号 Element type	厂名 Manufacturers	材料用途参数 Material Purpose Parameter	图号 Figure	国内外相似替换器件型号 Replace of similar type	备注 Notes	外形参考图 Reference shape
TAG271-200	TAG	Triac 10A, 200V, 0.025A, 2.5V	F-48	T4111B, T4116B, T4117B		 图 F-48
TAG271-300	TAG	Triac 10A, 300V, 0.025A, 2.5V	F-48	T4111C, T4116C, T4117C		
TAG271-400	TAG	Triac 10A, 400V, 0.025A, 2.5V	F-48	T4111D, T4116D, T4117D		
TAG271-500	TAG	Triac 10A, 500V, 0.025A, 2.5V	F-48	T4111E, T4116E, T4117E		
TAG271-600	TAG	Triac 10A, 600V, 0.025A, 2.5V	F-48	T4111M, T4116M, T4117M		
TAG275-100	TAG	Triac 12A, 100V, 0.05A, 2.5V	F-48	SC250B		 图 B-11
TAG275-200	TAG	Triac 12A, 200V, 0.05A, 2.5V	F-48	SC250B		
TAG275-300	TAG	Triac 12A, 300V, 0.05A, 2.5V	F-48	SC250C		
TAG275-400	TAG	Triac 12A, 400V, 0.05A, 2.5V	F-48	SC250D, TW12N400C, TW18N400CT		
TAG275-500	TAG	Triac 12A, 500V, 0.05A, 2.5V	F-48	SC250E, TW12N500C, TW18N500CT		
TAG275-600	TAG	Triac 12A, 600V, 0.05A, 2.5V	F-48	SC250M, TW12N600C, TW18N600CT		
TAG276-100	TAG	Triac 12A, 100V, 0.05A, 2.5V	F-48	T6417A		
TAG276-200	TAG	Triac 12A, 200V, 0.05A, 2.5V	F-48	T6417B		
TAG276-300	TAG	Triac 12A, 300V, 0.05A, 2.5V	F-48	T6417C		
TAG276-400	TAG	Triac 12A, 400V, 0.05A, 2.5V	F-48	T6417D		
TAG276-500	TAG	Triac 12A, 500V, 0.05A, 2.5V	F-48	T6417E		
TAG276-600	TAG	Triac 12A, 600V, 0.05A, 2.5V	F-48	T6417M		
TAG280-200...800		Triac 16A, 200-800V, 0.075A	B-11	BT139/..., MAC15A..., T6000...		 图 B-51
TAG281-200...800		Triac 16A, 200-800V, 0.05A	B-11	BT139/..., MAC223A...		
TAG302-50	TAG	Triac 2A, 50V, 0.015A, 2.5V	B-51	TAG201-100, TAG202-100, TAG203-100, T2302F		
TAG302-100	TAG	Triac 2A, 100V, 0.015A, 2.5V	B-51	TAG201-100, TAG202-100, TAG203-100, T2302A		
TAG302-200	TAG	Triac 2A, 200V, 0.015A, 2.5V	B-51	TAG201-200, TAG202-200, TAG203-200, T2302B		
TAG302-300	TAG	Triac 2A, 300V, 0.015A, 2.5V	B-51	TAG201-300, TAG202-300, TAG203-300, T2302C		
TAG302-400	TAG	Triac 2A, 400V, 0.015A, 2.5V	B-51	TAG201-400, TAG202-400, TAG203-400, T2302D		
TAG302-500	TAG	Triac 2A, 500V, 0.015A, 2.5V	B-51	TAG201-500, TAG202-500, TAG203-500, T2302E		
TAG302-600	TAG	Triac 2A, 600V, 0.015A, 2.5V	B-51	TAG201-600, TAG202-600, TAG203-600, T2302M		

器件型号 Element type	厂名 Manufacturers	材料用途参数 Material Purpose Parameter	图号 Figure	国内外相似替换器件型号 Replace of similar type	备注 Notes	外形参考图 Reference shape
TAG306-50	TAG	Triac 6A, 50V, 0.05A, 2.5V	D-9	TAG260-100, TAG265-100, T4700F		 图 D-9
TAG306-100	TAG	Triac 6A, 100V, 0.05A, 2.5V	D-9	TAG260-100, TAG265-100, T4700A		
TAG306-200	TAG	Triac 6A, 200V, 0.05A, 2.5V	D-9	TAG260-200, TAG265-200, T4700B		
TAG306-300	TAG	Triac 6A, 300V, 0.05A, 2.5V	D-9	TAG260-300, TAG265-300, T4700C		
TAG306-400	TAG	Triac 6A, 400V, 0.05A, 2.5V	D-9	TAG260-400, TAG265-400, T4700D		
TAG306-500	TAG	Triac 6A, 500V, 0.05A, 2.5V	D-9	TAG260-500, TAG265-500, T4700E		
TAG306-600	TAG	Triac 6A, 600V, 0.05A, 2.5V	D-9	TAG260-600, TAG265-600, T4700M		
TAG306-700	TAG	Triac 6A, 700V, 0.05A, 2.5V	D-9	TAG260-700, TAG265-700, T4700N		
TAG306-800	TAG	Triac 6A, 800V, 0.05A, 2.5V	D-9	TAG260-800, TAG265-800, T4700N		
TAG307-50	TAG	Triac 6A, 50V, 0.05A, 2.5V	F-48			
TAG307-100	TAG	Triac 6A, 100V, 0.05A, 2.5V	F-48			
TAG307-200	TAG	Triac 6A, 200V, 0.05A, 2.5V	F-48			
TAG307-300	TAG	Triac 6A, 300V, 0.05A, 2.5V	F-48			
TAG307-400	TAG	Triac 6A, 400V, 0.05A, 2.5V	F-48	TW12N400C, TW18N400CT		
TAG307-500	TAG	Triac 6A, 500V, 0.05A, 2.5V	F-48	TW12N500C, TW18N500CT		
TAG307-600	TAG	Triac 6A, 600V, 0.05A, 2.5V	F-48	TW12N600C, TW18N600CT		
TAG307-700	TAG	Triac 6A, 700V, 0.05A, 2.5V	F-48	TW12N700C, TW18N700CT		
TAG307-800	TAG	Triac 6A, 800V, 0.05A, 2.5V	F-48	TW12N800C, TW18N800CT		
TAG310-50	TAG	Triac 10A, 50V, 0.05A, 2.5V	F-48			 图 F-48
TAG310-100	TAG	Triac 10A, 100V, 0.05A, 2.5V	F-48			
TAG310-200	TAG	Triac 10A, 200V, 0.05A, 2.5V	F-48			
TAG310-300	TAG	Triac 10A, 300V, 0.05A, 2.5V	F-48			
TAG310-400	TAG	Triac 10A, 400V, 0.05A, 2.5V	F-48	TW12N400C, TW18N400CT		
TAG310-500	TAG	Triac 10A, 500V, 0.05A, 2.5V	F-48	TW12N500C, TW18N500CT		
TAG310-600	TAG	Triac 10A, 600V, 0.05A, 2.5V	F-48	TW12N600C, TW18N600CT		
TAG310-700	TAG	Triac 10A, 700V, 0.05A, 2.5V	F-48	TW12N700C, TW18N700CT		
TAG310-800	TAG	Triac 10A, 800V, 0.05A, 2.5V	F-48	TW12N800C, TW18N800CT		

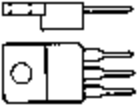
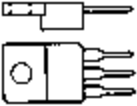
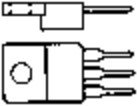
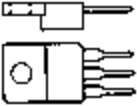

器件型号 Element type	厂名 Manufacturers	材料用途参数 Material Purpose Parameter	图号 Figure	国内外相似替换器件型号 Replace of similar type	备注 Notes	外形参考图 Reference shape
TAG340-100	TAG	Triac 12A, 100V, 0.1A, 3V	D-9	T4700A, T6000A		 图 D-9
TAG340-200	TAG	Triac 12A, 200V, 0.1A, 3V	D-9	T4700B, T6000B		
TAG340-300	TAG	Triac 12A, 300V, 0.1A, 3V	D-9	T4700C, T6000C		
TAG340-400	TAG	Triac 12A, 400V, 0.1A, 3V	D-9	T4700D, T6000D		
TAG340-500	TAG	Triac 12A, 500V, 0.1A, 3V	D-9	BT138-500, T4700E, T6000E		
TAG340-600	TAG	Triac 12A, 600V, 0.1A, 3V	D-9	BT138-600, T4700M, T6000M		
TAG341-100	TAG	Triac 12A, 100V, 0.05A, 3V	D-9	TAG255-100, TAG265-100		
TAG341-200	TAG	Triac 12A, 200V, 0.05A, 3V	D-9	BT238, TAG255-200, TAG265-200		
TAG341-300	TAG	Triac 12A, 300V, 0.05A, 3V	D-9	BT23C, TAG255-300, TAG265-300		
TAG341-400	TAG	Triac 12A, 400V, 0.05A, 3V	D-9	BT23D, TAG255-400, TAG265-400		
TAG341-500	TAG	Triac 12A, 500V, 0.05A, 3V	D-9	BT138-500, BT23E, TAG255-500, TAG265-500		
TAG341-600	TAG	Triac 12A, 600V, 0.05A, 3V	D-9	BT138-600, BT23M, TAG255-600, TAG265-600		
TAG350-100	TAG	Triac 15A, 100V, 0.1A, 3V	F-48	T6410A, T6411A, 2N6160, 2N6161, 2N6162		 图 F-48
TAG350-200	TAG	Triac 15A, 200V, 0.1A, 3V	F-48	T6410B, T6411B, 2N6160, 2N6161, 2N6162		
TAG350-300	TAG	Triac 15A, 300V, 0.1A, 3V	F-48	T6410C, T6411C, 2N6160, 2N6161, 2N6162		
TAG350-400	TAG	Triac 15A, 400V, 0.1A, 3V	F-48	TW18N400CT, T6410D, T6411D, 2N6160, 2N6161, 2N6162		
TAG350-500	TAG	Triac 15A, 500V, 0.1A, 3V	F-48	TW18N500CT, T6410E, T6411E, 2N6160, 2N6161, 2N6162		
TAG350-600	TAG	Triac 15A, 600V, 0.1A, 3V	F-48	TW18N600CT, T6410M, T6411M, 2N6160, 2N6161, 2N6162		
TAG351-100	TAG	Triac 15A, 100V, 0.05A, 3V	F-48	SC250B, SC260B, TXD98A20, TXE99A20		
TAG351-200	TAG	Triac 15A, 200V, 0.05A, 3V	F-48	SC250B, SC260B, TXD98A20, TXE99A20		
TAG351-300	TAG	Triac 15A, 300V, 0.05A, 3V	F-48	SC250C, SC260C, TXD98A30, TXE99A30		
TAG351-400	TAG	Triac 15A, 400V, 0.05A, 3V	F-48	SC250D, SC260D, TXD98A40, TXE99A40		
TAG351-500	TAG	Triac 15A, 500V, 0.05A, 3V	F-48	SC250E, SC260E, TXD98A50, TXE99A50		
TAG351-600	TAG	Triac 15A, 600V, 0.05A, 3V	F-48	SC250M, SC260M, TXD98A60, TXE99A60		

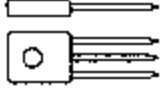

器件型号 Element type	厂名 Manufacturers	材料用途参数 Material Purpose Parameter	图号 Figure	国内外相似替换器件型号 Replace of similar type	备注 Notes	外形参考图 Reference shape
TAG420-100...800	Triac	5.5A, 100-800V, 0.05A	B-11	TAG425-100...800, TAG451-200...800, TAG456-200...800, TAG481-200		
TAG421-100...800	Triac	5.5A, 100-800V, 0.025A	B-11	TAG426-200...800, TAG452-200...800, TAG457-200...800		
TAG425-100...800	Triac	8A, 100-800V, 0.05A	B-11	TAG451-200...800, TAG456-200...800, TAG481-200...800		
TAG426-100...800	Triac	8A, 100-800V, 0.025A	B-11	TAG452-200...800, TAG457-200...800		
TAG451-200...800	Triac	8A, 200-800V, 0.05A	B-11	TAG456-200...800, TAG481-200...800		
TAG452-200...800	Triac	8A, 200-800V, 0.025A	B-11	TAG457-200...800		
TAG456-200...800	Triac	10A, 200-800V, 0.05A	B-11	TAG481-200...800		
TAG457-200...800	Triac	10A, 200-800V, 0.025A	B-11			
TAG480-200...800	Triac	12A, 200-800V, 0.075A	B-11			
TAG481-200...800	Triac	12A, 200-800V, 0.05A	B-11			
TAG510B	TAG	50Hz-Thy 4A, 200V, 0.01A, 1V	B-6	TAG621 200, TAG631-200, TAG651-200		
TAG510D	TAG	50Hz-Thy 4A, 400V, 0.01A, 1V	B-6	TAG621-400, TAG626-400, TAG631-400		
TAG510E	TAG	50Hz-Thy 4A, 500V, 0.01A, 1V	B-6	TAG621-500, TAG626-500, TAG631-500		
TAG510M	TAG	50Hz-Thy 4A, 600V, 0.01A, 1V	B-6	TAG621-600, TAG626-600, TAG631-600		
TAG511B	TAG	50Hz-Thy 4A, 200V, 0.005A, 1V	B-6	TAG622-200, TAG632-200, TAG662-200, TAG667-200		
TAG511D	TAG	50Hz-Thy 4A, 400V, 0.005A, 1V	B-6	TAG622-400, TAG632-400, TAG662-400, TAG667-400		
TAG511E	TAG	50Hz-Thy 4A, 500V, 0.005A, 1V	B-6	TAG622-500, TAG632-500, TAG662-500, TAG667-500		

器件型号 Element type	厂名 Manufacturers	材料 Material	用途 Purpose	参数 Parameter	图号 Figure	国内外相似替换器件型号 Replace of similar type	备注 Notes	外形参考图 Reference shape
TAG511M	TAG	50Hz-Thy	4A, 600V, 0.005A, 1V	B-6	TAG622-600, TAG632-600, TAG662-600, TAG667-600		 B-6	
TAG512B	TAG	50Hz-Thy	4A, 200V, 0.002A, 1V	B-6	S2062B			
TAG512D	TAG	50Hz-Thy	4A, 400V, 0.002A, 1V	B-6	S2062C			
TAG512E	TAG	50Hz-Thy	4A, 500V, 0.002A, 1V	B-6	S2062E			
TAG512M	TAG	50Hz-Thy	4A, 600V, 0.002A, 1V	B-6	S2062M			
TAG520A		50Hz-Thy	1.6A, 100V, 0.01A	B-62	BTX30-100, T1N100, 2N1596, 2N1597, 2N1598, 2N1599		 B-62	
TAG520B		50Hz-Thy	1.6A, 200V, 0.01A	B-62	BTX30-200, T1N200, 2N1597, 2N1598, 2N1599			
TAG520C		50Hz-Thy	1.6A, 300V, 0.01A	B-62	BTX30-300, T1N300, 2N1598, 2N1599			
TAG520D		50Hz-Thy	1.6A, 400V, 0.01A	B-62	BTX30-400, T1N400, 2N1599			
TAG520F		50Hz-Thy	1.6A, 50V, 0.01A	B-62	BTX30-50, T1N100, 2N1595, 2N1596, 2N1597, 2N1598, 2N1599			
TAG521A...F		50Hz-Thy	1.6A, 100-500V, 0.0002A	B-62	C106...; TAG615-..., X0403..., 2N2322...2N2329		 B-62	
TAG605-100...800	TAG	50Hz-Thy	4A, 100-800V, 0.05A, 3V	B-51	BSIC10..., MCR107..., TAG620..., TAG630...			
TAG605-100	TAG	50Hz-Thy	4A, 100V, 0.015A, 3V	B-51	S1003M, S2620A, TAG621-100, TAG626-100, TAG631-100			
TAG605-200		50Hz-Thy	2.6A, 200V, 0.015A, 3V	B-62	S2003M, S2620B, TAG621-200..., TAG626-200, TAG631-200			
TAG605-300		50Hz-Thy	2.6A, 300V, 0.015A, 3V	B-62	S3003M, S2620D, TAG621-300, TAG626-300, TAG631-300			
TAG605-400		50Hz-Thy	2.6A, 400V, 0.015A, 3V	B-62	S4003M, S2620D, TAG621-400, TAG626-400, TAG631-400			
TAG605-500		50Hz-Thy	2.6A, 500V, 0.015A, 3V	B-62	S5003M, S2620M, TAG621-500, TAG626-500, TAG631-500			
TAG605-600		50Hz-Thy	2.6A, 600V, 0.015A, 3V	B-62	S6003M, S2620M, TAG621-600, TAG626-600, TAG631-600			

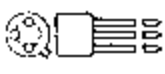

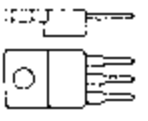
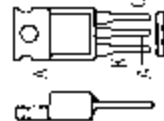

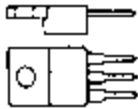
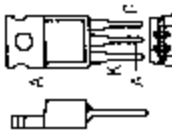
器件型号 Element type	厂名 Manufacturers	材料用途参数 Material Purpose Parameter	图号 Figure	国内外相似替换器件型号 Replace of similar type	备注 Notes	外形参考图 Reference shape
TAG606 /00		50Hz-Thy 2.6A, 700V, 0.015A, 3V	B-62	S7003M, S2620N, TAG621-700, TAG626-700, TAG631-700		 图 B-62
TAG606-800		50Hz-Thy 2.6A, 800V, 0.015A, 3V	B-62	S8003M, S2620N, TAG621-800, TAG626-800, TAG631-800		
TAG607-100...800		50Hz-Thy 2.6A, 100-800V, 0.005A, 0.015A	B-62	TAG622-100...800, TAG627-100...800, TAG632-100...800, TAG662-100...800		
TAG611-100...800	TAG	50Hz-Thy 1.9A, 100-800V, 0.025A, 1.5V	B-51	BS1C10..., ECG5408, S1003M, TAG605..., TAG620..., TAG630...		 图 B-51
TAG612-100...800	TAG	50Hz-Thy 1.9A, 100-800V, 0.01A, 1.5V	B-51	ECG5408, S1003M, TAG606..., TAG621..., TAG626..., TAG631...		
TAG613-100...800	IAG	50Hz-Thy 1.9A, 100-800V, 0.005A, 1.5V	B-51	S1003M, TAG607-200...800, TAG622-200...800, TAG627-200...800		
TAG614-100...800	TAG	50Hz-Thy 1.9A, 100-800V, 0.001A, 1.5V	B-51	S1003MS3, TIC108B...N		
TAG615-100...800	TAG	50Hz-Thy 1.9A, 100-800V, 200 μA, 1.5V	B-51	S1003MS2, TAG623..., TAG628..., TAG633..., TIC106...		 图 B-11
TAG620-100...800		50Hz-Thy 2.6A, 100-800V, 0.05A, 3V	B-11	BS1C10..., TAG625..., TIC126..., T7.5N...		
TAG620S100	TAG	SCR-H 5A, 100V, 0.05A, 3V	B-91	TAG625S100, TAG660S100, TAG665S100		
TAG620S200	TAG	SCR-H 5A, 200V, 0.05A, 3V	B-91	TAG625S200, TAG660S200, TAG665S200		
TAG620S300	TAG	SCR-H 5A, 300V, 0.05A, 3V	B-91	TAG625S300, TAG660S300, TAG665S300		
TAG620S400	TAG	SCR-H 5A, 400V, 0.05A, 3V	B-91	TAG625S400, TAG660S400, TAG665S400		
TAG620S500	IAG	SCR-H 5A, 500V, 0.05A, 3V	B-91	BT151-500R, TAG625S500, TAG660S500, TAG665S500		 图 B-91
TAG620S600	TAG	SCR-H 5A, 600V, 0.05A, 3V	B-91	BT151-600R, TAG625S600, TAG660S600, TAG665S600		
TAG620S700		50Hz-Thy 2.6A, 700V, 0.05A, 3V	B-11	BT151-700R, TAG625S700, IAG660S700, TAG665S700		

器件型号 Element type	厂名 Manufacturers	材料用途参数 Material Purpose Parameter	图号 Figure	国内外相似替换器件型号 Replace of similar type	备注 Notes	外形参考图 Reference shape
TAG620S800		50Hz-Thy 2.6A, 800V, 0.05A, 3V	B-11	BT151-800R, TAG625S800, TAG660S800, TAG665S800		 图 B-11
TAG621-100...800	TAG	50Hz-Thy 2.6A, 100-800V, 0.015A, 3V	B-91	S1006L, TAG626-100, TAG626S100, TAG651S100, TAG661-100...800, TAG665-100...800, TAG666S100...800		
TAG621S100	TAG	SCR-H 2.6A, 100V, 0.015A, 3V	B-91	TAG626S100, TAG651S100, TAG666S100		 图 B-91
TAG621S200	TAG	SCR-H 2.6A, 200V, 0.015A, 3V	B-91	TAG626S200, TAG651S200, TAG666S200		
TAG621S300	TAG	SCR-H 2.6A, 300V, 0.015A, 3V	B-91	TAG626S300, TAG651S300, TAG666S300		
TAG621S400	TAG	SCR-H 2.6A, 400V, 0.015A, 3V	B-91	TAG626S400, TAG651S400, TAG666S400		
TAG621S500	TAG	SCR-H 2.6A, 500V, 0.015A, 3V	B-91	TAG626S500, TAG651S500, TAG666S500		
TAG621S600	TAG	SCR-H 2.6A, 600V, 0.015A, 3V	B-91	TAG626S600, TAG651S600, TAG666S600		
TAG621S700		50Hz-Thy 2.6A, 700V, 0.015A, 3V	B-11	TAG626S700, TAG651S700, TAG666S700		
TAG621S800		50Hz-Thy 2.6A, 800V, 0.015A, 3V	B-11	TAG626S800, TAG651S800, TAG666S800		
TAG622-100...800		50Hz-Thy 2.6A, 100-800V, 0.005A	B-11	TAG667-100...800		
TAG623-100...800		50Hz-Thy 2.6A, 100-800V, 0.0002A	B-11	S4060..., TAG626-100...800		
TAG625-100...800	TAG	50Hz-Thy 3.5A, 100-800V, 0.05A, 3V	B-91	CS6..., ECG5462, S1008L, S2800..., TAG660..., TIC116...		
TAG625S100	TAG	SCR-H 6A, 100V, 0.05A, 3V	B-91	TAG660S100, TAG665S100		
TAG625S200	TAG	SCR-H 6A, 200V, 0.05A, 3V	B-91	TAG660S200, TAG665S200		
TAG625S300	TAG	SCR-H 6A, 300V, 0.05A, 3V	B-91	TAG660S300, TAG665S300		
TAG625S400	TAG	SCR-H 6A, 400V, 0.05A, 3V	B-91	TAG660S400, TAG665S400		
TAG625S500	TAG	SCR-H 6A, 500V, 0.05A, 3V	B-91	BT151-500R, TAG660S500, TAG665S500		
TAG625S600	TAG	SCR-H 6A, 600V, 0.05A, 3V	B-91	BT151-600R, TAG660S600, TAG665S600		
TAG625S700		SCR-H 3.5A, 700V, 0.025A	B-11	BT151-700R, TAG660S700, TAG665S700		
TAG625S800		SCR-H 3.5A, 800V, 0.025A	B-11	BT151-800R, TAG660S800, TAG665S800		
TAG626-100	TAG	50Hz-Thy 3.5A, 100V, 0.015A, 3V	B-91	S1008L, TAG661-100, TAG666-100		
TAG626-200		50Hz-Thy 3.5A, 200V, 0.01A	B-11	TAG661-200, TAG666-200		
TAG626-300		50Hz-Thy 3.5A, 300V, 0.01A	B-11	TAG661-300, TAG666-300		

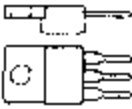
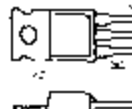

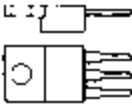
器件型号 Element type	厂名 Manufacturers	材料用途参数 Material Purpose Parameter	图号 Figure	国内外相似替换器件型号 Replace of similar type	备注 Notes	外形参考图 Reference shape
TAG626-400		50Hz-Thy 3.5A, 400V, 0.01A	B-11	TAG661-400, TAG666-400, T3.5N400FOB		 图 B-11
TAG626-500		50Hz-Thy 3.5A, 500V, 0.01A	B-11	TAG661-500, TAG666-500, T3.5N500FOB		
TAG626-600		50Hz-Thy 3.5A, 600V, 0.01A	B-11	TAG661-600, TAG666-600, T3.5N600FOB		
TAG626-700		50Hz-Thy 3.5A, 700V, 0.01A	B-11	TAG661-700, TAG666-700, T3.5N700FOB		
TAG626-800		50Hz-Thy 3.5A, 800V, 0.01A	B-11	TAG661-800, TAG666-800, T3.5N800FOB		
TAG626S100	TAG	SCR-H 3.5A, 100V, 0.015A, 3V	B-91	TAG661S100, TAG666S100		
TAG626S200	TAG	SCR-H 3.5A, 200V, 0.015A, 3V	B-91	TAG661S200, TAG666S200		
TAG626S300	TAG	SCR-H 3.5A, 300V, 0.015A, 3V	B-91	TAG661S300, TAG666S300		
TAG626S400	TAG	SCR-H 3.5A, 400V, 0.015A, 3V	B-91	TAG661S400, TAG666S400		
TAG626S500	TAG	SCR-H 3.5A, 500V, 0.015A, 3V	B-91	BT151-500R, TAG661S500, TAG666S500		
TAG626S600	TAG	SCR-H 3.5A, 600V, 0.015A, 3V	B-91	BT151-600R, TAG661S600, TAG666S600		
TAG626S700		SCR-H 3.5A, 700V, 0.01A	B-11	BT151-700R, TAG661S700, TAG666S700		
TAG626S800		SCR-H 3.5A, 800V, 0.01A	B-11	BT151-800R, TAG661S800, TAG666S800		
TAG627-100...800	TAG	50Hz-Thy 3.5A, 100-800V, 0.005A, 2V	B-91	ECG5437, S1008L, TAG662..., TAG667...		 图 B-91
TAG628-100...800		50Hz-Thy 3.5A, 100-800V, 200 μA	B-11	B5C10..., TAG620..., TAG625..., TIC116...		
TAG630-100...800		50Hz-Thy 2.4A, 100-800V, 0.025A	B-11	B5C10..., TAG621..., TAG626..., T3.5N...		
TAG631-100...800		50Hz-Thy 2.4A, 100-800V, 0.01A, 0.025A	B-11	TAG622-100...800, TAG627-100...800,		
TAG632-100...800		50Hz-Thy 2.4A, 100-800V, 0.005A, 0.015A	B-11	TAG662-100...800, TAG667-100...800,		
TAG633-100...800		50Hz-Thy 2.4A, 100-800V, 200 μA	B-11	S4060..., TAG623-100...800, TAG628-100...800,		
TAG650-100...600		50Hz-Thy 6.5A, 100-600V, 0.05A	B-11	TIC106...		
TAG650-(S)100	TAG	SCR-H 6.5A, 100V, 0.05A, 3.5V	B-91	TAG655-100...600		
TAG650-(S)200	TAG	SCR-H 6.5A, 200V, 0.05A, 3V	B-91	TAG655S100		
TAG650-(S)300	TAG	SCR-H 6.5A, 300V, 0.05A, 3V	B-91	TAC655S200		
TAG650-(S)400	TAG	SCR-H 6.5A, 400V, 0.05A, 3V	B-91	TAG655S300		
TAG650-(S)500	TAG	SCR-H 6.5A, 500V, 0.05A, 3V	B-91	TAG655S400		
TAG650-(S)600	TAG	SCR-H 6.5A, 600V, 0.05A, 3V	B-91	TAG655S500		
			B-91	TAG655S600		

器件型号 Element type	厂名 Manufacturers	材料用途参数 Material Purpose Parameter	图号 Figure	国内外相似替换器件型号 Replace of similar type	备注 Notes	外形参考图 Reference shape
TAG651-100		50Hz-Thy 6.5A, 100V, 0.015A	B-11	TAG656-100		 图 B-11
TAG651-200		50Hz-Thy 6.5A, 200V, 0.015A	B-11	TAG656-200		
TAG651-300		50Hz Thy 6.5A, 300V, 0.015A	B-11	TAG656-300		
TAG651-400		50Hz-Thy 6.5A, 400V, 0.015A	B-11	TAG656-400		
TAG651-500		50Hz-Thy 6.5A, 500V, 0.015A	B-11	TAG656-500		
TAG651-600		50Hz-Thy 6.5A, 600V, 0.015A	B-11	TAG656-600		
TAG651-(S)100	TAG	SCR-H 6.5A, 100V, 0.015A, 3.5V	B-91	TAG666S100		
TAG651-(S)200	TAG	SCR-H 6.5A, 200V, 0.015A, 3V	B-91	TAG666S200		
TAG651-(S)300	TAG	SCR-H 6.5A, 300V, 0.015A, 3V	B-91	TAG666S300		
TAG651-(S)400	TAG	SCR-H 6.5A, 400V, 0.015A, 3V	B-91	TAG666S400		
TAG651-(S)500	TAG	SCR-H 6.5A, 500V, 0.015A, 3V	B-91	TAG666S500		
TAG651-(S)600	TAG	SCR-H 6.5A, 600V, 0.015A, 3V	B-91	TAG666S600		
TAG651S200	TAG	SCR-H 6.5A, 200V, 0.05A, 3V	B-91	TAG666S200		
TAG655-100...600		50Hz-Thy 8A, 100-600V, 0.05A	B-11	TAG665S100...600		 图 B-91
TAG655-(S)100	TAG	SCR-H 8A, 100V, 0.05A, 3V	B-91	CSF11-02cr1		
TAG655-(S)200	TAG	SCR-H 8A, 200V, 0.05A, 3V	B-91	CSF11-02er1		
TAG655-(S)300	TAG	SCR-H 8A, 300V, 0.05A, 3V	B-91	CSF11-04cr1		
TAG655-(S)400	TAG	SCR-H 8A, 400V, 0.05A, 3V	B-91	CSF11-04er1		
TAG655-(S)500	TAG	SCR-H 8A, 500V, 0.05A, 3V	B-91	CSF11-06ep1		
TAG655-(S)600	TAG	SCR-H 8A, 600V, 0.05A, 3V	B-91	CSF11-06ep1		
TAG655-100...600		50Hz-Thy 8A, 100-600V, 0.015A	B-11	BSIC10...M, C122..., CS6..., TIC116...		
TAG656-(S)100	TAG	SCR-H 8A, 100V, 0.015A, 3V	B-91	TAG661S100, TAG666S100		
TAG656-(S)200	TAG	SCR-H 8A, 200V, 0.015A, 3V	B-91	TAG661S200, TAG666S200		
TAG656-(S)300	TAG	SCR-H 8A, 300V, 0.015A, 3V	B-91	TAG661S300, TAG666S300		
TAG656-(S)400	TAG	SCR-H 8A, 400V, 0.015A, 3V	B-91	BT151-400R, TAG661S400, TAG666S400		
TAG656-(S)500	TAG	SCR-H 8A, 500V, 0.015A, 3V	B-91	BT151-500R, TAG661S500, TAG666S500		
TAG656-(S)600	TAG	SCR-H 8A, 600V, 0.015A, 2V	B-91	BT151-600R, TAG661S600, TAG666S600		

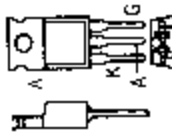

器件型号 Element type	厂名 Manufacturers	材料用途参数 Material Purpose Parameter	图号 Figure	国内外相似替换器件型号 Replace of similar type	备注 Notes	外形参考图 Reference shape
TAG660-100	TAG	50Hz-Thy 4.5A, 100V, 0.05A, 3V	B-91	S1010L, S2800A, TAG655-100, 2N6394, 2N6395, 2N6396, 2N6397, 2N6398, 2N6399		 图 B-91
TAG660-200		50Hz-Thy 4.5A, 200V, 0.025A	B-11	S2800B, TAG655-200, 2N6394, 2N6395, 2N6396, 2N6397, 2N6398, 2N6399		
TAG660-300		50Hz-Thy 4.5A, 300V, 0.025A	B-11	S2800C, TAG655-300, 2N6394, 2N6395, 2N6396, 2N6397, 2N6398, 2N6399		
TAG660-400		50Hz-Thy 4.5A, 400V, 0.025A	B-11	S2800D, TAG655-400, 2N6394, 2N6395, 2N6396, 2N6397, 2N6398, 2N6399		
TAG660-500	TAG	50Hz-Thy 4.5A, 500V, 0.05A, 3V	B-91	S2800E, S6010L, TAG655-500, 2N6394, 2N6395, 2N6396, 2N6397, 2N6398, 2N6399		
TAG660-600		50Hz-Thy 4.5A, 600V, 0.025A	B-11	S2800M, TAG655-600, 2N6394, 2N6395, 2N6396, 2N6397, 2N6398, 2N6399		
TAG660-700		50Hz-Thy 4.5A, 700V, 0.025A	B-11	S2800S, TAG655-700, 2N6394, 2N6395, 2N6396, 2N6397, 2N6398, 2N6399		
TAG660-800		50Hz-Thy 4.5A, 800V, 0.025A	B-11	S2800N, TAG655-800, 2N6394, 2N6395, 2N6396, 2N6397, 2N6398, 2N6399		
TAG660S100	TAG	SCR-H 10A, 100V, 0.05A, 3V	B-91	TAG665S100		
TAG660S200	TAG	SCR-H 10A, 200V, 0.05A, 3V	B-91	TAG665S200		
TAG660S300	TAG	SCR-H 10A, 300V, 0.05A, 3V	B-91	TAG665S300		
TAG660S400	TAG	SCR-H 10A, 400V, 0.05A, 3V	B-91	BT151-400R, TAG665S400		
TAG660S500	TAG	SCR-H 10A, 500V, 0.05A, 3V	B-91	BT151-500R, TAG665S500		
TAG660S600	TAG	SCR-H 10A, 600V, 0.05A, 3V	B-91	BT151-600R, TAG665S600		
TAG660S700		SCR-H 4.5A, 700V, 0.025A, 0.03A	B-11	BT151-700R, TAG665S700		
TAG660S800		SCR-H 4.5A, 800V, 0.025A, 0.03A	B-11	BT151-800R, TAG665S800		
TAG661-100	TAG	50Hz-Thy 4.5A, 100V, 0.015A, 3V	B-91	S1010L, TAG666-100		
TAG661-200		50Hz-Thy 4.5A, 200V, 0.01A	B-11	TAG666-200		
TAG661-300		50Hz-Thy 4.5A, 300V, 0.01A	B-11	TAG666-300		
TAG661-400		50Hz-Thy 4.5A, 400V, 0.01A	B-11	TAG666-400		
TAG661-500	TAG	50Hz-Thy 4.5A, 500V, 0.015A, 3V	B-91	S6010L, TAG666-500		

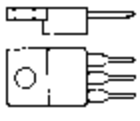
器件型号 Element type	厂名 Manufacturers	材料用途参数 Material Purpose Parameter	图号 Figure	国内外相似替换器件型号 Replace of similar type	备注 Notes	外形参考图 Reference shape
TAG661-600		50Hz-Thy 4.5A, 600V, 0.01A	B-11	TAG666-600		 图 D-11
TAG661-700		50Hz-Thy 4.5A, 700V, 0.01A	B-11	TAG666-700		
TAG661-800		50Hz-Thy 4.5A, 800V, 0.01A	B-11	TAG666-800		
TAG661S100	TAG	SCR-H 4.5A, 100V, 0.015A, 3V	B-91	TAG666S100		
TAG661S200	TAG	SCR-H 4.5A, 200V, 0.015A, 3V	B-91	TAG666S200		
TAG661S300	TAG	SCR-H 4.5A, 300V, 0.015A, 3V	B-91	TAG666S300		
TAG661S400	TAG	SCR-H 4.5A, 400V, 0.015A, 3V	B-91	BT151-400R, TAG666S400		
TAG661S500	TAG	SCR-H 4.5A, 500V, 0.015A, 3V	B-91	BT151-500R, TAG666S500		
TAG661S600	TAG	SCR-H 4.5A, 600V, 0.015A, 3V	B-91	BT151-600R, TAG666S600		
TAG661S700	TAG	SCR-H 4.5A, 700V, 0.01A	B-11	BT151-700R, TAG666S700		
TAG661S800		SCR-H 4.5A, 800V, 0.01A	B-11	BT151-800R, TAG666S800		
TAG662-100...800		50Hz-Thy 4.5A, 100-800V, 0.005A	B-11	TAG667-100...800		
TAG665-100...800		50Hz-Thy 5.3A, 100-800V, 0.05A, 3V	B-91	BS1D10..., S1015L, TAG680..., TIC126..., T7.5N...		
TAG665S100	TAG	SCR-H 5.3A, 100V, 0.05A, 3V	B-91			
TAG665S200	TAG	SCR-H 5.3A, 200V, 0.05A, 3V	B-91			
TAG665S300	TAG	SCR-H 5.3A, 300V, 0.05A, 3V	B-91			
TAG665S400	TAG	SCR-H 5.3A, 400V, 0.05A, 3V	B-91	BT151-400R		
TAG665S500	TAG	SCR-H 5.3A, 500V, 0.05A, 3V	B-91	BT151-500R		
TAG665S600	TAG	SCR-H 5.3A, 600V, 0.05A, 3V	B-91	BT151-600R		
TAG665S700		SCR-H 5.3A, 700V, 0.025A, 0.03A	B-11	BT151-700R		
TAG665S800		SCR-H 5.3A, 800V, 0.025A, 0.03A	B-11	BT151-800R		
TAG666-100...800		50Hz-Thy 5.3A, 100-800V, 0.015A, 3V	B-91	BS1D10..., BS1D16..., S1015L...		
TAG666S100	TAG	SCR-H 5.3A, 100V, 0.015A, 3V	B-91			
TAG666S200	TAG	SCR-H 5.3A, 200V, 0.015A, 3V	B-91			
TAG666S300	TAG	SCR-H 5.3A, 300V, 0.015A, 3V	B-91			
TAG666S400	TAG	SCR-H 5.3A, 400V, 0.015A, 3V	B-91	BT151-400R		
TAG666S500	TAG	SCR-H 5.3A, 500V, 0.015A, 3V	B-91	BT151-500R		
TAG666S600	TAG	SCR-H 5.3A, 600V, 0.015A, 3V	B-91	BT151-600R		

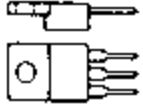
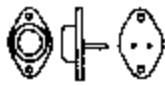

器件型号 Element type	厂名 Manufacturers	材料用途参数 Material Purpose Parameter	图号 Figure	国内外相似替换器件型号 Replace of similar type	备注 Notes	外形参考图 Reference shape
TAG666S700	SCR-H	5.3A, 700V, 0.01A	B-11	BT151-700R		 图 B-11
TAG666S800	SCR-H	5.3A, 800V, 0.01A	B-11	BT151-800R		
TAG667-100~800	50Hz-Thy	5.3A, 100~800V, 0.005A	B-11			
TAG670-100	TAG	50Hz-Thy 5.1A, 100V, 0.05A, 3V	D-9	ECG5462, S1008L, TAG675-100		 图 D-9
TAG670-200		50Hz-Thy 5.1A, 200V, 0.05A	D-9	TAG675-200		
TAG670-300		50Hz-Thy 5.1A, 300V, 0.05A	D-9	TAG675-300		
TAG670-400		50Hz-Thy 5.1A, 400V, 0.05A	D-9	BT152-400R, TAG675-400		
TAG670-500	TAG	50Hz-Thy 5.1A, 500V, 0.05A, 3V	D-9	BT152-600R, S5008L, TAG675-500		
TAG670-600		50Hz-Thy 5.1A, 600V, 0.05A	D-9	BT152-600R, TAG675-600		
TAG670-700		50Hz-Thy 5.1A, 700V, 0.05A	D-9	BT152-800R, TAG675-700		
TAG670-800		50Hz-Thy 5.1A, 800V, 0.05A	D-9	BT152-800R, TAG675-800		
TAG670S-100~800	SCR-H	5.1A, 100~800V, 0.05A	D-9	CSF11-02er1, TAG675S...		
TAG671-100~800	50Hz-Thy	5.1A, 100~800V, 0.015A	D-9	S2800..., TAG676..., 2N6394...2N6399		
TAG671S100	TAG	SCR-H 5.1A, 100V, 0.015A, 3V	D-9	TAG676S100		
TAG671S200	TAG	SCR-H 5.1A, 200V, 0.015A, 3V	D-9	TAG676S200		
TAG671S300	TAG	SCR-H 5.1A, 300V, 0.015A, 3V	D-9	TAG676S300		
TAG671S400	TAG	SCR-H 5.1A, 400V, 0.015A, 3V	D-9	TAG676S400		
TAG671S500	TAG	SCR-H 5.1A, 500V, 0.015A, 3V	D-9	BT151-500R, TAG676S500		
TAG671S600	TAG	SCR-H 5.1A, 600V, 0.015A, 3V	D-9	BT151-600R, TAG676S600		
TAG671S700		SCR-H 5.1A, 700V, 0.015A	D-9	BT151-700R, TAG676S700		
TAG671S800		SCR-H 5.1A, 800V, 0.015A	D-9	BT151-800R, TAG676S800		
TAG675-100	TAG	50Hz-Thy 5.5A, 100V, 0.05A, 3V	D-9	ECG5552, S1015L, 2N6504, 2N6505, 2N6506, 2N6508, 2N6509		
TAG675-200		50Hz-Thy 5.5A, 200V, 0.05A	D-9	2N6504, 2N6505, 2N6506, 2N6507, 2N6508, 2N6509		
TAG675-300		50Hz-Thy 5.5A, 300V, 0.05A	D-9	2N6504, 2N6505, 2N6506, 2N6507, 2N6508, 2N6509		
TAG675-400		50Hz-Thy 5.5A, 400V, 0.05A	D-9	BSID1026, BT152-400R, 2N6504, 2N6505		

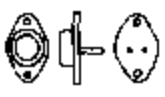
器件型号 Element type	厂名 Manufacturers	材料用途参数 Material Purpose Parameter	图号 Figure	国内外相似替换器型号 Replace of similar type	备注 Notes	外形参考图 Reference shape
TAG675-500	TAG	50Hz-Thy 5.5A, 500V, 0.05A, 3V	D-9	BSiD1033, BT152-600R, S5015L, 2N6504, 2N6505, 2N6506, 2N6507, 2N6508, 2N6509		 图 D-9
TAG675-600		50Hz-Thy 5.5A, 600V, 0.05A	D-9	BSiD1040, BT152-600R, 2N6504, 2N6505, 2N6506, 2N6507, 2N6508, 2N6509		
TAG675-700		50Hz-Thy 5.5A, 700V, 0.05A	D-9	BSiD1046, BT152-800R, 2N6504, 2N6505, 2N6506, 2N6507, 2N6508, 2N6509		
TAG675-800		50Hz-Thy 5.5A, 800V, 0.05A	D-9	BSiD1053, BT152-800R, 2N6504, 2N6505, 2N6506, 2N6507, 2N6508, 2N6509		
TAG675S100	TAG	SCR-H 5.5A, 100V, 0.05A, 3V	D-9	CSF11-02er1		
TAG675S300	TAG	SCR-H 5.5A, 300V, 0.05A, 3V	D-9	CSF11-04er1		
TAG675S400	TAG	SCR-H 5.5A, 400V, 0.05A, 3V	D-9	CSF11-04er1		
TAG675S500	TAG	SCR-H 5.5A, 500V, 0.05A, 3V	D-9	CSF11 06ep1		
TAG675S500	TAG	SCR-H 5.5A, 600V, 0.05A, 3V	D-9	CSF11-06ep1		
TAG676-100	TAG	50Hz-Thy 5.5A, 100V, 0.015A, 3V	D-9	S1015L, TAG681-100, TIC126A		
TAG676-200		50Hz-Thy 5.5A, 200V, 0.015A, 3V	D-9	TAG681-200, TIC126B		
TAG676-300		50Hz-Thy 5.5A, 300V, 0.015A, 3V	D-9	TAG681-300, TIC126C		
TAG676-400		50Hz-Thy 5.5A, 400V, 0.015A, 3V	D-9	TAG681-400, TIC126D, T7.5N400F		
TAG676-500	TAG	50Hz-Thy 5.5A, 500V, 0.015A, 3V	D-9	S5015L, TAG681-500, TIC126E, T7.5N500F		
TAG676-600		50Hz-Thy 5.5A, 600V, 0.015A, 3V	D-9	TAG681-600, TIC126M, T7.5N600F		
TAG676-700		50Hz-Thy 5.5A, 700V, 0.015A, 3V	D-9	TAG681-700, TIC126S, T7.5N700F		
TAG676-800		50Hz-Thy 5.5A, 800V, 0.015A, 3V	D-9	TAG681-800, TIC126N, T7.5N800F		
TAG676S100	TAG	SCR-H 5.5A, 100V, 0.05A, 3V	D-9			
TAG676S200	TAG	SCR-H 5.5A, 200V, 0.05A, 3V	D-9			
TAG676S300	TAG	SCR-H 5.5A, 300V, 0.05A, 3V	D-9			
TAG676S400	TAG	SCR-H 5.5A, 400V, 0.05A, 3V	D-9			
TAG676S500	TAG	SCR-H 5.5A, 500V, 0.05A, 3V	D-9	BT151-500R		
TAG676S600	TAG	SCR-H 5.5A, 600V, 0.05A, 3V	D-9	BT151-600R		
TAG676S700		SCR-H 5.5A, 700V, 0.015A	D-9	BT151-700R		
TAG676S800		SCR-H 5.5A, 800V, 0.015A	D-9	BT151-800R		













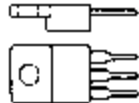

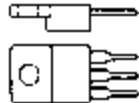
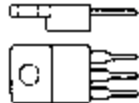
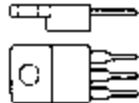



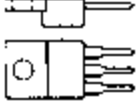
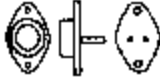

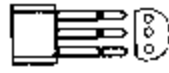
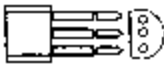
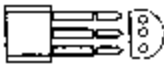
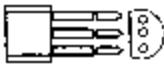
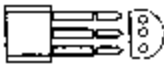
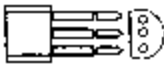
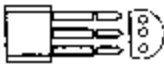







器件型号 Element type	厂名 Manufacturers	材料用途参数 Material Purpose Parameter	图号 Figure	国内外相似替换器件型号 Replace of similar type	备注 Notes	外形参考图 Reference shape
TAG680-100...800		50Hz-Thy 7.3A, 100-800V, 0.025A	B-11	BS1D10...M, CS15... T9.5N... 2N6400...2N6405		
TAG681-100...800		50Hz-Thy 7.3A, 100-800V, 0.015A, 0.03A	B-11	BS1D10...M, CS15... T9.5N...		
TAG725-200...800		Triac 25A, 200-800V, 0.075A		MAC25A... MAC50A... TAG740...		
TAG726-200...800		Inac 25A, 200-800V, 0.05A		TAG741-200...800		
TAG740-200...800		Triac 40A, 200-800V, 0.075A		MAC50A4...A10		
TAG741-200...800		Triac 40A, 200-800V, 0.05A				
TAG825-200...800		50Hz-Thy 13A, 200-800V, 0.075A		BTW67-200...800, TAG840-200...800		
TAG826-200...800		50Hz-Thy 25A, 200-800V, 0.05A		BTW66-200...800, TAG841-200...800		
TAG840-200...800		50Hz-Thy 22A, 200-800V, 0.075A		BTW67-200...800		
TAG841-200...800		50Hz-Thy 22A, 200-800V, 0.05A				
TAG4441		50Hz-Thy 5.1A, 50V, 0.03A	B-11	2N4441		
TAG4442		50Hz-Thy 5.1A, 200V, 0.03A	B-11	2N4442		
TAG4443		50Hz-Thy 5.1A, 400V, 0.03A	B-11	2N4443		
TAG4444		50Hz-Thy 5.1A, 600V, 0.03A	B-11	2N4444		
TAG5001A...M		GTO, 8.5A, 100-600V, 0.2A	D-9			
TAG5002A...M		GTO, =TAG5001A...M	D-9			
TAG5003A...M		GTO, =TAG5001A...M	D-9			
TAG6151		Triac 10A, 200V, 0.125A, 3V	B-11	2N6151, 2N6152, 2N6153, 2N6154, 2N6155, 2N6156		
TAG6152		Triac 10A, 400V, 0.125A, 3V	B-11	2N6151, 2N6152, 2N6153, 2N6154, 2N6155, 2N6156		

图 B 11

图 D-9

器件型号 Element type	厂名 Manufacturers	材料用途参数 Material Purpose Parameter	图号 Figure	国内外相似替换器件型号 Replace of similar type	备注 Notes	外形参考图 Reference shape
TAG6153		Triac 10A, 600V, 0.125A, 3V	B-11	2N6151, 2N6152, 2N6153, 2N6154, 2N6155, 2N6156		 图 B-11
TAG6154		Triac 30A, 200V, 0.125A, 3V	B-11	2N6151, 2N6152, 2N6153, 2N6154, 2N6155, 2N6156		
TAG6155		Triac 30A, 400V, 0.125A, 3V	B-11	2N6151, 2N6152, 2N6153, 2N6154, 2N6155, 2N6156		
TAG6156		Triac 30A, 600V, 0.125A, 3V	B-11	2N6151, 2N6152, 2N6153, 2N6154, 2N6155, 2N6156		
TAS3707D		SCR-H TV-HA, 3.2A, 400V, 0.032A	D-9	TD3F400H, TDF4F400H, TU3F400H		
TAS3707EF		SCR-H TV-HA, 3.2A, 650V, 0.032A	D-9	TD3F700H, TDF4F700H, TU3F700H		 图 D-9
TAS3900E		ITR 8A, 500V, 0.04A, 4V	B-11	S3900E		
TAS3900MF		ITR 8A, 650V, 0.04A, 4V	B-11	S3900MF		
TAS3900S		ITR 8A, 700V, 0.04A, 4V	B-11	S3900S		
TAS3900SF		ITR 8A, 750V, 0.04A, 4V	B-11	S3900SF		
TAS3901M		ITR 8A, 600V, 0.045A, 4V	B-11	S3901M		 图 F-55
TAS3901MF		ITR 8A, 650V, 0.045A, 4V	B-11	S3901MF		
TAS3901S		ITR, 8A, 700V, 0.045A, 4V	B-11	S3901S		
TAS7431B		SCR-H 25A, 200V, 0.08A, 3V	F-55	S7310B		
TAS7431C		SCR-H 25A, 300V, 0.08A, 3V	F-55	S7310C		
TAS7431D		SCR-H 25A, 400V, 0.08A, 3V	F-55	S7310D		
TAS7431E		SCR-H 25A, 500V, 0.08A, 3V	F-55	S7310E		
TAS7431M		SCR-H 25A, 600V, 0.08A, 3V	F-55	S7310M		 图 B-36
TAS7431N		SCR-H 25A, 800V, 0.08A, 3V	F-55	S7310N		
TBD		1A, 200V, 0.005A, 2V	B-36			
TBG		1A, 200V, 0.01A, 2V	B-36			



器件型号 Element type	厂名 Manufacturers	材料用途参数 Material Purpose Parameter	图号 Figure	国内外相似替换器件型号 Replace of similar type	备注 Notes	外形参考图 Reference shape
TBH		1A, 200V, 0.025A, 2V	B-36			
TBS		1A, 200V, 0.003A, 2.2V	B-36			
TCD		0.8A, 300V, 0.005A, 2.2V	B-36			
TCG		0.8A, 300V, 0.01A, 2.2V	B-36			
TCH		0.8A, 300V, 0.025A, 2.2V	B-36			
TCS		0.8A, 300V, 0.003A, 2.2V	B-36			
TC201B3	TCE	1.6A, 200V, 0.01A, 2V	A-10			
TC204B4	TCE	4A, 200V, 0.025A, 2V	A-10			
TC210B5	TCE	10A, 200V, 0.05A, 2.5V	A-11			
TC215B5	TCE	15A, 200V, 0.05A, 2.5V	C-32			
TC225B6	TCE	25A, 200V, 0.08A, 2.5V	A-11			
TC240B7	TCE	40A, 200V, 0.1A, 2.5V	C-32			
TC301	SEL	3A, 100V, 0.025A	B-51			
TC302	SEL	3A, 200V, 0.025A	B-51			
TC303	SEL	3A, 300V, 0.025A	B-51			
TC304	SEL	3A, 400V, 0.025A	B-51			
TC306	SEL	3A, 600V, 0.025A	B-51			
TC404B4	TCE	4A, 400V, 0.025A, 2V	A-10			
TC408B4	TCE	8A, 400V, 0.025A, 2.5V	A-10			
TC410B5	TCE	10A, 400V, 0.05A, 2.5V	A-11			
TC415B5	TCE	15A, 400V, 0.05A, 2.5V	A-11			
TC425B6	TCE	25A, 400V, 0.08A, 2.5V	A-11			
TC440B7	TCE	40A, 400V, 0.1A, 2.5V	A-11			
TC504B4	TCE	4A, 500V, 0.025A, 2V	A-10			

外形参考图

Reference shape



图 B-36



图 A-10



图 A-11





图 C-32

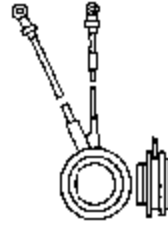

图 B-51

器件型号 Element type	厂名 Manufacturers	材料用途参数 Material Purpose Parameter	图号 Figure	国内外相似替换器件型号 Replace of similar type	备注 Notes	外形参考图 Reference shape
TC508B4	TCE	8A, 500V, 0.025A, 2.5V	A-10			 图 A-10
TC515B5	TCE	15A, 500V, 0.05A, 2.5V	A-11			
TC525B6	TCE	25A, 500V, 0.08A, 2.5V	A-11			
TC540B7	TCE	40A, 500V, 0.1A, 2.5V	A-11			
TC604B4	TCE	4A, 600V, 0.025A, 2V	A-10			 图 A-11
TC608B4	TCE	8A, 600V, 0.025A, 2.5V	A-10			
TC610B6	TCE	10A, 600V, 0.05A, 2.5V	A-11			
TC615B5	TCE	15A, 600V, 0.06A, 2.5V	A-11			
TC625B6	TCE	25A, 600V, 0.08A, 2.5V	A-11			
TC640B7	TCE	40A, 600V, 0.1A, 2.5V	A-11			
TD2.8F400...800H		TV-HA, 2.8A, 400-800V, 0.05A	D-9	B5C01...H, TD3F...H, TD4F...H		
TD2.8F400...800R		TV-HA, 2.8A, 400-800V, 0.05A	D-9	B5C01...R, TD3F...R, TD4F...R		
TD3F400	AEG	3.4A, 400V, 0.05A, 3.5V	D-9			 图 D-9
TD3F400H		3.4A, 400V, 0.05A, 0.1A	D-9	TD4F400H		
TD3F400R		3.4A, 400V, 0.05A, 0.1A	D-9	TD4F400R		
TD3F500	AEG	3.4A, 500V, 0.05A, 3.5V	D-9			
TD3F500H		3.4A, 500V, 0.05A, 0.1A	D-9	TD4F500H		
TD3F500R		3.4A, 500V, 0.05A, 0.1A	D-9	TD4F500R		
TD3F600	AEG	3.4A, 600V, 0.05A, 3.5V	D-9			
TD3F600H		3.4A, 600V, 0.05A, 0.1A	D-9	TD4F600H		
TD3F600R		3.4A, 600V, 0.05A, 0.1A	D-9	TD4F600R		
TD3F700	AEG	3.4A, 700V, 0.05A, 3.5V	D-9			
TD3F700H		3.4A, 700V, 0.05A, 0.1A	D-9	TD4F700H		
TD3F700R		3.4A, 700V, 0.05A, 0.1A	D-9	TD4F700R		
TD3F800	AEG	3.4A, 800V, 0.05A, 2V	D-9			
TD3F800H		3.4A, 800V, 0.05A, 0.1A	D-9	TD4F800H		

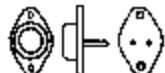



























器件型号 Element type	厂名 Manufacturers	材料用途参数 Material Purpose Parameter	图号 Figure	国内外相似替换器件型号 Replace of similar type	备注 Notes	外形参考图 Reference shape
TD3F800R		3.4A, 800V, 0.05A, 0.1A	D-9	TD4F800R		
TD3FP800H		3.4A, 800V, 0.05A, 0.1A	B-11	BSiCC0253H, 17088		
TD3FP800R		3.4A, 800V, 0.05A, 0.1A	B-11	BSiCC0253R, 17089		
TD4F400H		4A, 400V, 0.05A, 0.1A	D-9	BSiCC0226H, 17088		
TD4F400R		4A, 400V, 0.05A, 0.1A	D-9	BSiCC0226R, 17089		
TD4F500H		4A, 500V, 0.05A, 0.1A	D-9	BSiCC0233H, 17088		
TD4F500R		4A, 500V, 0.05A, 0.1A	D-9	BSiCC0233R, 17089		
TD4F600H		4A, 600V, 0.05A, 0.1A	D-9	BSiCC0240H, 17088		
TD4F600R		4A, 600V, 0.05A, 0.1A	D-9	BSiCC0240R, 17089		
TD4F700H		4A, 700V, 0.05A, 0.1A	D-9	BSiCC0246H, 17088		
TD4F700R		4A, 700V, 0.05A, 0.1A	D-9	BSiCC0246R, 17089		
TD4F800H		4A, 800V, 0.05A, 0.1A	D-9	BSiCC0253H, 17088		
TD4F800R		4A, 800V, 0.05A, 0.1A	D-9	BSiCC0253R, 17089		
TD5	THE	50Hz-Thy 1.6A, 500V, 0.01A, 3V	B-51	2N1595		
TD6	THE	50Hz-Thy 1.6A, 600V, 0.01A, 3V	B-51	2N1595		
TD18F200	AGE	25.5A, 200V, 0.08A, 2.7V	H-13			
TD18F400	AGE	25.5A, 400V, 0.08A, 2.7V	H-13			
TD18F400 KCC	AGE	25A, 400V, 0.08A, 2.7V	H-13			
TD18F600	AGE	25.5A, 600V, 0.08A, 2.7V	H-13			
TD18F600 KCC	AGE	25A, 600V, 0.08A, 2.7V	H-13			
TD18F800	AGE	25.5A, 800V, 0.08A, 2.7V	H-13			
TD18F800 KCC	AGE	25A, 800V, 0.08A, 2.7V	H-13			
TD18F900	AGE	25.5A, 900V, 0.08A, 2.7V	H-13			
TD18F900 KCC	AGE	25A, 900V, 0.08A, 2.7V	H-13			
TD18F1000	AGE	25.5A, 1kV, 0.08A, 2.7V	H-13			
TD18F1000 KCC	AGE	25A, 1kV, 0.08A, 2.7V	H-13			
TD18F1100	AGE	25.5A, 1.1kV, 0.08A, 2.7V	H-13			

图 H-13

图 B-51

图 B-11

器件型号 Element type	厂名 Manufacturers	材料 Material	用途 Purpose	参数 Parameter	图号 Figure	国内外相似替换器件型号 Replace of similar type	备注 Notes	外形参考图 Reference shape
TD18F1200 KCC	AGE	SCA	25A, 1.2KV, 0.08A, 2.7V	H-13				 图 H-13
TD18N400 KCC, KOF	AGE		25.5A, 400V, 0.08A, 2.7V	H-13				
TD18N600 KCC, KOF	AGE		25.5A, 600V, 0.08A, 2.7V	H-13				
TD18N800 KCC, KOF	AGE	SCA	25.5A, 800V, 0.08A, 2.7V	H-13				
TD18N1000 KCC	AGE	SCA	25A, 1KV, 0.08A, 2.7V	H-13				
TD18N1100 KCC, KOF	AGE	SCA	25.5A, 1.1KV, 0.08A, 2.7V	H-13				
TD18N1200 KCC, KOF	AGE		25.5A, 1.2KV, 0.08A, 2.7V	H-13				
TD18N1400 KCC, KOF	AGE		25.5A, 1.4KV, 0.08A, 2.7V	H-13				
TD25F200	AGE		32A, 200V, 0.08A, 2.7V	H-13				
TD25F400	AGE		32A, 400V, 0.08A, 2.7V	H-13				
TD25F400 KCC	AGE	SCA	32A, 400V, 0.08A, 2.7V	H-13				
TD25F600	AGE		32A, 600V, 0.08A, 2.7V	H-13				
TD25F600 KCC	AGE	SCA	32A, 600V, 0.08A, 2.7V	H-13				
TD25F800	AGE		32A, 800V, 0.08A, 2.7V	H-13				
TD25F800 KCC	AGE	SCA	32A, 800V, 0.08A, 2.7V	H-13				
TD25F900	AGE		32A, 900V, 0.08A, 2.7V	H-13				
TD25F900 KCC	AGE	SCA	32A, 900V, 0.08A, 2.7V	H-13				
TD25F1000	AGE		32A, 1KV, 0.08A, 2.7V	H-13				
TD25F1000 KCC	AGE	SCA	32A, 1KV, 0.08A, 2.7V	H-13				
TD25F1100	AGE		32A, 1.1KV, 0.08A, 2.7V	H-13				
TD25F1100KCC	AGE	SCA	32A, 1.1KV, 0.08A, 2.7V	H-13				
TD25F1200	AGE		32A, 1.2KV, 0.08A, 2.7V	H-13				

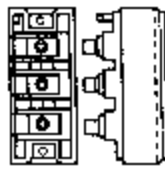

器件型号 Element type	厂名 Manufacturers	材料 Material	用途 Purpose	参数 Parameter	图号 Figure	国内外相似替换器件型号 Replace of similar type	备注 Notes	外形参考图 Reference shape
TD25F1200 KCC	AGE	SCA	32A, 1.2kV, 0.08A, 2.7V		H-13			
TD25N400	AGE		32A, 400V, 0.08A, 2.7V		H-13			
TD25N600	AGE		32A, 600V, 0.08A, 2.7V		H-13			
TD25N800	AGE		32A, 800V, 0.08A, 2.7V		H-13			
TD25N1100	AGE		32A, 1.1kV, 0.08A, 2.7V		H-13			
TD25N1200	AGE		32A, 1.2kV, 0.08A, 2.7V		H-13			
TD25N1400	AGF		32A, 1.4kV, 0.08A, 2.7V		H-13			
TD32F 400			51A, 400V					
TD32F600			51A, 600V					
TD32F800			51A, 800V					
TD32F900			51A, 900V					
TD32F1000			51A, 1kV					
TD32F1100			51A, 1.1kV					
TD32N600			32A, 600V					
TD32N800			32A, 800V					
TD32N1100			32A, 1.1kV					
TD32N1400			32A, 1.4kV					
TD35F200	AGE		63A, 200V, 0.15A, 1.4V		H-13			
TD35F400	AGE		63A, 400V, 0.15A, 1.4V		H-13			
TD35F600	AGE		63A, 600V, 0.15A, 1.4V		H-13			
TD35F800	AGE		63A, 800V, 0.15A, 1.4V		H-13			
TD35F900	AGE		63A, 900V, 0.15A, 1.4V		H-13			
TD35F1000	AGE		63A, 1kV, 0.15A, 1.4V		H-13			
TD35F1100	AGE		63A, 1.1kV, 0.15A, 1.4V		H-13			
TD35F1200	AGE		63A, 1.2kV, 0.15A, 1.4V		H-13			



图 H-13

器件型号 Element type	厂名 Manufacturers	材料用途参数 Material Purpose Parameter	图号 Figure	国内外相似替换器件型号 Replace of similar type	备注 Notes	外形参考图 Reference snape
TD36N200	AGE	51A, 200V, 0.15A, 2.5V				 图 H-13
TD36N400	AGE	51A, 400V, 0.15A, 2.5V				
TD36N600	AGE	51A, 600V, 0.15A, 2.5V				
TD36N800	AGE	51A, 800V, 0.15A, 2.5V				
TD36N1100	AGE	51A, 1.1kV, 0.15A, 2.5V				
TD36N1200	AGE	51A, 1.2kV, 0.15A, 2.5V				
TD36N1400	AGE	51A, 1.4kV, 0.15A, 2.5V				
TD45F200	AGE	76A, 200V, 0.15A, 1.4V	H-13			
TD45F400	AGE	76A, 400V, 0.15A, 1.4V	H-13			
TD45F600	AGE	76A, 600V, 0.15A, 1.4V	H-13			
TD45F800	AGE	76A, 800V, 0.15A, 1.4V	H-13			
TD45F900	AGE	76A, 900V, 0.15A, 1.4V	H-13			
TD45F1000	AGE	76A, 1kV, 0.15A, 1.4V	H-13			
TD45F1100	AGE	76A, 1.1kV, 0.15A, 1.4V	H-13			
TD45F1200	AGE	76A, 1.2kV, 0.15A, 1.4V	H-13			
TD45N400	AGE	63A, 400V, 0.12A, 1.4V	H-13			
TD45N600	AGE	63A, 600V, 0.12A, 1.4V	H-13			
TD45N800	AGE	63A, 800V, 0.12A, 1.4V	H-13			
TD45N1100	AGE	63A, 1.1kV, 0.12A, 1.4V	H-13			
TD45N1200	AGE	63A, 1.2kV, 0.12A, 1.4V	H-13			
TD45N1400	AGE	63A, 1.4kV, 0.12A, 1.4V	H-13			
TD45N1500	AGE	63A, 1.5kV, 0.15A, 1.4V	H-13			
TD46N200		64A, 200V, 0.15A, 2.5V				
TD46N400		64A, 400V, 0.15A, 2.5V				
TD46N600		64A, 600V, 0.15A, 2.5V				
TD46N800		64A, 800V, 0.15A, 2.5V				



器件型号 Element type	厂名 Manufacturers	材料用途参数 Material Purpose Parameter	图号 Figure	国内外相似替换器件型号 Replace of similar type	备注 Notes	外形参考图 Reference shape
TD46N1100		64A, 1.1kV, 0.15A, 2.5V				 <p>图 H-13</p>
TD46N1200		64A, 1.2kV, 0.15A, 2.5V				
TD46N1400		64A, 1.4kV, 0.15A, 2.5V				
TD60N400	AGE	76A, 400V, 0.12A, 1.4V	H-13			
TD60N600	AGE	76A, 600V, 0.12A, 1.4V	H-13			
TD60N800	AGE	76A, 800V, 0.12A, 1.4V	H-13			
TD60N800KOC	AGE	63A, 800V, 0.15A, 1.4V	H-13			
TD60N1100	AGE	76A, 1.1kV, 0.12A, 1.4V	H-13			
TD60N1200	AGE	76A, 1.2kV, 0.12A, 1.4V	H-13			
TD60N1500	AGE	76A, 1.5kV, 0.12A, 1.4V	H-13			
TD71F400		115A, 400V				
TD71F600		115A, 600V				
TD71F800		115A, 800V				
TD71F900		115A, 900V				
TD71F1000		115A, 1kV				
TD71F1100		115A, 1.1kV				
TD71F1200		115A, 1.2kV				
TD71F1300		115A, 1.3kV				
TD75N400		95A, 400V, 0.12A, 1.4V				
TD75N600		95A, 600V, 0.12A, 1.4V				
TD75N800		95A, 800V, 0.12A, 1.4V				
TD75N1100		95A, 1.1kV				
TD75N1200		95A, 1.2kV				
TD75N1400		95A, 1.4kV, 0.12A, 1.4V				
TD75N1600		95A, 1.6kV, 0.12A, 1.4V				

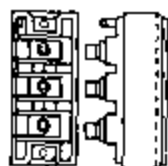
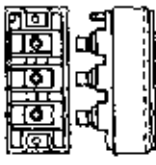
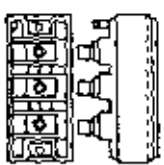
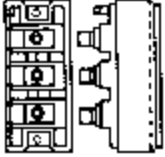

器件型号 Element type	厂名 Manufacturers	材料用途参数 Material Purpose Parameter	图号 Figure	国内外相似替换器件型号 Replace of similar type	备注 Notes	外形参考图 Reference shape
TD81F400 TD81F600 TD81F800		115A, 400V 115A, 600V 115A, 800V				
TD86N600 TD86N800 TD86N1100 TD86N1200 TD86N1400 TD86N1600 TD86N1800	AGE AGE AGE AGE AGE AGE AGE	102A, 600V 102A, 800V 102A, 1.1KV 102A, 1.2KV 102A, 1.4KV 102A, 1.6KV 102A, 1.8KV				
TD95N400 TD95N600 TD95N800 TD95N1100 TD95N1200	AGE AGE AGE AGE AGE	95A, 400V, 0.12A, 1.4V 95A, 600V, 0.12A, 1.4V 95A, 800V, 0.12A, 1.4V 95A, 1.1KV, 0.12A, 1.4V 95A, 1.2KV, 0.12A, 1.4V	H-13 H-13 H-13 H-13 H-13			 图 H-13
TD101F400 TD101F600 TD101F800 TD101F900 TD101F1000 TD101F1300		128A, 400V 128A, 600V 128A, 800V 128A, 900V 128A, 1KV 128A, 1.3KV				
TD106N600 TD106N800 TD106N1100 TD106N1200		115A, 600V 115A, 800V 115A, 1.1KV 115A, 1.2KV				



器件型号 Element type	厂名 Manufacturers	材料用途参数 Material Purpose Parameter	图号 Figure	国内外相似替换器件型号 Replace of similar type	备注 Notes	外形参考图 Reference shape
TD106N1400		115A, 1.4kV				
TD106N1600		115A, 1.6kV				
TD106N1800		115A, 1.8kV				
TD111F400		128A, 400V				
TD111F600		128A, 600V				
TD111F800		128A, 800V				
TD121N1100		128A, 1.1kV, 0.15A, 1.4V				
TD121N1200		128A, 1.2kV, 0.15A, 1.4V				
TD121N1400		128A, 1.4kV, 0.15A, 1.4V				
TD121N1600		128A, 1.6kV, 0.15A, 1.4V				
TD121N1800		128A, 1.8kV, 0.15A, 1.4V				
TD131N400		141A, 400V, 0.15A, 1.4V				
TD131N600		141A, 600V, 0.15A, 1.4V				
TD131N800		141A, 800V, 0.15A, 1.4V				
TD131N1100		141A, 1.1kV, 0.15A, 1.4V				
TD131N1200		141A, 1.2kV, 0.15A, 1.4V				
TD131N1400		141A, 1.4kV, 0.15A, 1.4V				
TD170N400		223A, 400V, 0.2A, 2V				
TD170N600		223A, 600V, 0.2A, 2V				
TD170N800		223A, 800V, 0.2A, 2V				
TD170N1100		223A, 1.1kV, 0.2A, 2V				
TD170N1200		223A, 1.2kV, 0.2A, 2V				
TD170N1400		223A, 1.4kV, 0.2A, 2V				
TD170N1600		223A, 1.6kV, 0.2A, 2V				
TD170N1800		223A, 1.8kV, 0.2A, 2V				

器件型号 Element type	厂名 Manufacturers	材料用途参数 Material Purpose Parameter	图号 Figure	国内外相似替换器件型号 Replacc of similar type	备注 Notes	外形参考图 Reference shape
TD180F400		180A, 400V				
TD180F600		180A, 600V				
TD180F800		180A, 800V				
TD180F900		180A, 900V				
TD180F1000		180A, 1kV				
TD180F1100		180A, 1.1kV				
TD180F1200		180A, 1.2kV				
TD200F400		200A, 400V				
TD200F600		200A, 600V				
TD200F800		200A, 800V				
TD200F900		200A, 900V				
TD200F1000		200A, 1kV				
TD200F1100		200A, 1.1kV				
TD200F1200		200A, 1.2kV				
TD210N400		261A, 400V, 0.2A, 2V				
TD210N600		210A, 600V, 0.2A, 2V				
TD210N800		210A, 800V, 0.2A, 2V				
TD210N1100		210A, 1.1kV, 0.2A, 2V				
TD210N1200		210A, 1.2kV, 0.2A, 2V				
TD210N1400		210A, 1.4kV, 0.2A, 2V				
TD210N1600		210A, 1.6kV, 0.2A, 2V				
TD210N1800		261A, 1.8kV, 0.2A, 2V				
TD250N400		261A, 400V, 0.2A, 2V				
TD250N600		250A, 600V, 0.2A, 2V				
TD250N800		250A, 800V, 0.2A, 2V				
TD250N1100		250A, 1.1kV, 0.2A, 2V				



器件型号 Element type	厂名 Manufacturers	材料用途参数 Material Purpose Parameter	图号 Figure	国内外相似替换器件型号 Replace of similar type	备注 Notes	外形参考图 Reference shape
TD250N1200		250A, 1.2kV, 0.2A, 2V				 图 B-62
TD250N1400		250A, 1.4kV, 0.2A, 2V				
TD250N1600		250A, 1.6kV, 0.2A, 2V				
TD250N1800		261A, 1.8kV, 0.2A, 2V				
TD251N400		261A, 400V, 0.2A, 2V				
TD251N600		261A, 600V, 0.2A, 2V				
TD251N800		261A, 800V, 0.2A, 2V				
TD251N1100		261A, 1.1kV, 0.2A, 2V				
TD251N1200		261A, 1.2kV, 0.2A, 2V				
TD251N1400		261A, 1.4kV, 0.2A, 2V				
TD503		50Hz-Thy 1.6A, 50V, 0.02A, 1.5V	B-62	BRY54/30T		 图 B-51
TD1003		50Hz-Thy 1.6A, 100V, 0.02A, 1.5V	B-62	BRY54/100T		
TD2003		50Hz-Thy 1.6A, 200V, 0.02A, 1.5V	B-62	BRY54/200T		
TD3001	THE	1.6A, 300V, 0.0025A, 5V	B-51			
TD3003	THC	50Hz Thy 1.6A, 400V, 0.01A, 1.5V	B-51	BRY54/300T, FCG5409		
TD4003		50Hz-Thy 1.6A, 700V, 0.02A, 1.5V	B-62	BRY54/400T		
TD5001S	THE	1.6A, 500V, 200 μA, 0.8V	B-51	2N2322		
TD5003		50Hz-Thy 1.6A, 50V, 0.02A, 1.5V	B-62	BRY54/500T		
TD6001S	THE	1.6A, 600V, 200 μA, 0.8V	B-51	2N2322		
TD6003		50Hz-Thy 1.6A, 600V, 0.02A, 1.5V	B-62	BRY54/500T		

器件型号 Element type	厂名 Manufacturers	材料用途参数 Material Purpose Parameter	图号 Figure	国内外相似替换器件型号 Replace of similar type	备注 Notes	外形参考图 Reference shape
TDA25-40...160	CHN	25A, 0.4~1.6KV, 0.15A, 3V				
TDA40-40...160	CHN	40A, 0.4~1.6KV, 0.15A, 3V				
TDA55-40...160	CHN	55A, 0.4~1.6KV, 0.15A, 3V				
TDA90-40...160	CHN	90A, 0.4~1.6KV, 0.15A, 3V				
TDA110-40...160	CHN	110A, 0.4~1.6KV, 0.15A, 3V				
TDA130-40...160	CHN	130A, 0.4~1.6KV, 0.15A, 3V				
TDA160-40...160	CHN	160A, 0.4~1.6KV, 0.15A, 3V				
TDA200-40...160	CHN	200A, 0.4~1.6KV, 0.15A, 3V				
TDA250-40...160	CHN	250A, 0.4~1.6KV, 0.15A, 3V				
TDR25-40...160	CHN	25A, 0.4~1.6KV, 0.15A, 3V				
TDR40-40...160	CHN	40A, 0.4~1.6KV, 0.15A, 3V				
TDR55-40...160	CHN	55A, 0.4~1.6KV, 0.15A, 3V				
TDR90-40...160	CHN	90A, 0.4~1.6KV, 0.15A, 3V				
TDR110-40...160	CHN	110A, 0.4~1.6KV, 0.15A, 3V				
TDR130-40...160	CHN	130A, 0.4~1.6KV, 0.15A, 3V				
TDR160-40...160	CHN	160A, 0.4~1.6KV, 0.15A, 3V				
TDR200-40...160	CHN	200A, 0.4~1.6KV, 0.15A, 3V				
TDR250-40...160	CHN	250A, 0.4~1.6KV, 0.15A, 3V				
TDS25-40...160	CHN	25A, 0.4~1.6KV, 0.15A, 3V				
TDS40-40...160	CHN	40A, 0.4~1.6KV, 0.15A, 3V				
TDS55-40...160	CHN	55A, 0.4~1.6KV, 0.15A, 3V				
TDS90-40...160	CHN	90A, 0.4~1.6KV, 0.15A, 3V				
TDS110-40...160	CHN	110A, 0.4~1.6KV, 0.15A, 3V				
TDS130-40...160	CHN	130A, 0.4~1.6KV, 0.15A, 3V				
TDS160-40...160	CHN	160A, 0.4~1.6KV, 0.15A, 3V				
TDS200-40...160	CHN	200A, 0.4~1.6KV, 0.15A, 3V				
TDS250-40...160	CHN	250A, 0.4~1.6KV, 0.15A, 3V				



器件型号 Element type	厂名 Manufacturers	材料用途参数 Material: Purpose Parameter	图号 Figure	国内外相似替换器件型号 Replace of similar type	备注 Notes	外形参考图 Reference shape
TE205		0.8A, 200V		MCH100-4		 图 B-36
TE305		0.8A, 300V		MCR100-5		
TE405		0.8A, 400V		MCR100-6		
TE505		0.8A, 500V		MCR100-7		
TE605		0.8A, 600V		MCR100-8		
TFH		0.8A, 50V, 0.025A, 2.2V	B-36			
TFS		0.8A, 50V, 0.003A, 2.2V	B-36			
TF320M	SAK	50Hz-Thy 3A, 200V, 0.05A, 1.8V	B-11	TAG620-200, TAG621-200, TAG622-200		
TF320MA	SAK	3A, 200V, 0.001A, 1V				
TF321M		50Hz-Thy 3A, 200V, 0.01A, 0.004A	B-11	TAG621-200, TAG622-200		
TF321M-A		50Hz-Thy 3A, 200V, 100 μ A, 0.001A	B-11	S0602BH, TAG623-200, TIC106B		
TF321S		3A, 200V, 0.01A, 0.07A	B-11			
TF340M	SAK	3A, 400V, 0.05A, 1.8V	B-11	TAG620-400, TAG621-400, TAG622-400		
TF340MA	SAK	3A, 400V, 0.003A, 1.5V	B-11			
TF340MB		3A, 400V	B-11			
TF341M	SAK	50Hz-Thy 3A, 400V, 0.01A, 0.004A	B-11	TAG621-400, TAG622 400		
TF341M-A	SAK	50Hz-Thy 3A, 400V, 100 μ A, 0.001A	B-11	S0602DH, TAG623-400, TIC106D		
TF341S	SAK	3A, 400V, 0.01A, 0.004A				
TF361M		50Hz-Thy 3A, 600V, 0.01A, 0.004A	B-11	TAG621-600, TAG622-600		
TF361M-A		50Hz-Thy 3A, 600V, 100 μ A, 0.001A	B-11	S0602MH, TAG623-600, TIC106M		
TF361S		3A, 600V, 0.01A, 0.004A	B-11			
TF520M	SAK	5A, 200V, 0.015A, 1.5V				
TF521M		5A, 200V, 0.015A, 0.004A	B-11	C122B, TAG660-200, TAG661-200, TAG662-200, TIC115B		





图 B-11

器件型号 Element type	厂名 Manufacturers	材料用途参数 Material Purpose Parameter	图号 Figure	国内外相似替换器件型号 Replace of similar type	备注 Notes	外形参考图 Reference shape
TF521S		5A, 200V, 0.0115A				
TF540M TF541M	SAK	5A, 400V, 0.015A, 1.5V 5A, 400V, 0.015A, 0.004A	B-11	C122D, TAG660-400, TAG661-400, TAG662-400, TIC116D		
TF541S TF541S-A		5A, 400V 5A, 400V				
TF561M		5A, 600V, 0.015A, 0.004A	B-11	C122M, TAG660-600, TAG661-600, TAG662-600, TIC116M		
TF561S TF561S-A		5A, 600V, 0.015A, 0.004A 5A, 600V				
TF620M TF640M	SAK SAK	50Hz-Thy 6A, 200V, 0.05A, 1.8V 50Hz-Thy 6A, 400V, 0.05A, 1.8V	B-11 B-11	S2800B, TAG660-200, TAG661-200, TIC116B S2800D, TAG660-400, TAG661-400, TIC116D		
TF820M TF821M TF821S	SAK	8A, 200V, 0.05A, 1.8V 8A, 200V, 0.015A, 0.01A 8A, 200V, 0.015A, 0.01A	B-11 B-11	S1205B, TAG680-200, TAG681-200, TIC122B		
TF840M TF841M TF841S	SAK	50Hz-Thy 8A, 400V, 0.05A, 1.8V 50Hz-Thy 8A, 400V, 0.015A, 0.01A 5A, 400V, 0.015A, 0.01A	B-11 B-11	S1205D, TAG680-400, TAG681-400, TIC122D		
TF861M TF861S		50Hz-Thy 8A, 800V, 0.015A, 0.01A 8A, 600V, 0.015A, 0.01A	B-11 B-11	S1205M, TAG680-600, TAG681-600, TIC122M		
TFD312S TFD312S-C	SCB SCB	3A, 120V 3A, 20V				

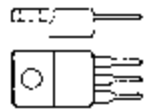

图 B-11

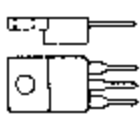

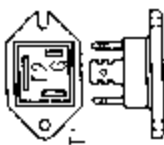
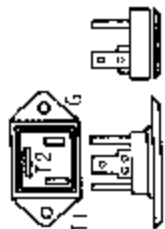
器件型号 Element type	厂名 Manufacturers	材料用途参数 Material Purpose Parameter	图号 Figure	国内外相似替换器件型号 Replace of similar type	备注 Notes	外形参考图 Reference shape
TFD312S-F	SCB	3A, 35V				 图 B-11
TFD312S-G	SCB	3A, 45V				
TFD312S-J	SCB	3A, 80V				
TFD312S-K	SCB	3A, 100V				
TFD312S-L	SCB	3A, 120V				
TFD312S-M	SCB	3A, 145V				
TFD312S-N	SCB	3A, 170V				
TFD312S-O	SCB	3A, 190V				
TFH340M	SAK	SCR-H 3A, 400V, 0.07A, 3V	B-11	S5800D, S5801D, S5802D, TAG620S-400, TAG621S-400		 图 B-36
TFH341S		SCR-H 3A, 400V, 0.02A, 0.025A	B-11	TAG650S-400, TAG651S-400		
TFH361S		SCR-H 3A, 600V, 0.02A, 0.025A	B-11	TAG650S-600, TAG651S-600		
TFM640M		6A, 200V	B-11			 图 G-10
TFM640MA		6A, 200V	B-36			
TG16C20	SEM	SCR-D 16A, 200V, 0.05A, 3V	G-18			 图 G-12
TG16C30	SEM	SCR-D 16A, 300V, 0.05A, 3V	G-18			
TG16C40	SEM	SCR-D 16A, 400V, 0.05A, 3V	G-18			
TG16C50	SEM	SCR-D 16A, 500V, 0.05A, 3V	G-18			
TG16C60	SEM	SCR D 16A, 600V, 0.05A, 3V	G-18			
TG16E20		SCR-D 16A, 200V	G-12			
TG16E30		SCR-D 16A, 300V	G-12			
TG16E40		SCR-D 16A, 400V	G-12			
TG16E50		SCR-D 16A, 500V	G-12			

器件型号 Element type	厂名 Manufacturers	材料 Material	用途 Purpose	参数 Parameter	图号 Figure	国内外相似替换器件型号 Replace of similar type	备注 Notes	外形参考图 Reference shape
TG16E60		SCR-D	16A, 600V		G-12			
TG25C20	SEM	SCR-D	25A, 200V, 0.07A, 3V		G-18			
TG25C30	SEM	SCR-D	25A, 300V, 0.07A, 3V		G-18			
TG25C40	SEM	SCR-D	25A, 400V, 0.07A, 3V		G-18			
TG25C50	SEM	SCR-D	25A, 500V, 0.07A, 3V		G-18			
TG25C60	SEM	SCR-D	25A, 600V, 0.07A, 3V		G-18			
TG25E20		SCR-D	25A, 200V		G-12			
TG25E30		SCR-D	25A, 300V		G-12			
TG25E40		SCR-D	25A, 400V		G-12			
TG25E50		SCR-D	25A, 500V		G-12			
TG25E60		SCR-D	25A, 600V		G-12			
TG35C20			35A, 200V, 0.05A, 3V					
TG35C30			35A, 300V, 0.05A, 3V					
TG35C40			35A, 400V, 0.05A, 3V					
TG35C50			35A, 500V, 0.05A, 3V					
TG35C60			35A, 600V, 0.07A, 3V					
TG35E20			35A, 200V, 0.05A, 3V					
TG35E30			35A, 300V, 0.05A, 3V					
TG35E40			35A, 400V, 0.05A, 3V					
TG35E50			35A, 500V, 0.05A, 3V					
TG35E60			35A, 600V, 0.05A, 3V					
TG35F40			35A, 400V, 0.05A, 2.5V					
TG35F50			35A, 500V, 0.05A, 2.5V					
TG35F60			35A, 600V, 0.05A, 2.5V					
TG840M		50Hz-Thy	8A, 400V, 0.03A		B-11	TAG680-400, TAG681-400, TIC122D		



图 G-12



图 G-18

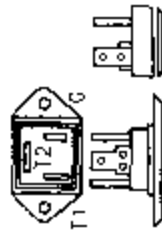

器件型号 Element type	厂名 Manufacturers	材料用途参数 Material Purpose Parameter	图号 Figure	国内外相似替换器件型号 Replace of similar type	备注 Notes	外形参考图 Reference shape
TGAL602	THE	60A, 200V, 0.1A, 3V	F-21			 图 F-21
TGAL604	THE	60A, 400V, 0.1A, 3V	F-21			
TGAL606	THE	60A, 600V, 0.1A, 3V	F-21			
TGAL608	THE	60A, 800V, 0.1A, 3V	F-21			
TGAL610	THE	60A, 1kV, 0.1A, 3V	F-21			
TGDV601	THE	60A, 100V, 0.15A, 2.5V	F-21			
TGDV602	THE	60A, 200V, 0.15A, 2.5V	F-21			
TGDV604	THE	60A, 400V, 0.15A, 2.5V	F-21			
TGDV606	THE	60A, 600V, 0.15A, 2.5V	F-21			
TGDV608	THE	60A, 800V, 0.15A, 2.5V	F-21			
TGDV610	THE	60A, 1kV, 0.15A, 2.5V	F-21			
TGDV612	THE	60A, 1.2kV, 0.15A, 2.5V	F-21			
TGF148-600	THE	63A, 600V, 0.15A, 3V	F-21			
TGF148-700	THE	63A, 700V, 0.15A, 3V	F-21			
TGF148-800	THE	63A, 800V, 0.15A, 3V	F-21			
TGF148-900	THE	63A, 900V, 0.15A, 3V	F-21			
TGF148-1000	THE	63A, 1kV, 0.15A, 3V	F-21			
TGF148-1100	THE	63A, 1.1kV, 0.15A, 3V	F-21			
TGF148-1200	THE	63A, 1.2kV, 0.15A, 3V	F-21			
TGF149-100	THE	63A, 100V, 0.15A, 3V	F-21			
TGF149-200	THE	63A, 200V, 0.15A, 3V	F-21			
TGF149-300	THE	63A, 300V, 0.15A, 3V	F-21			
TGF149-400	THE	63A, 400V, 0.15A, 3V	F-21			
TGF149-500	THE	63A, 500V, 0.15A, 3V	F-21			
TGF149-600	THE	63A, 600V, 0.15A, 3V	F-21			
TGH340M	SAK	3A, 400V, 0.05A, 2V				

器件型号 Element type	厂名 Manufacturers	材料用途参数 Material Purpose Parameter	图号 Figure	国内外相似替换器件型号 Replace of similar type	备注 Notes	外形参考图 Reference shape
ThyDE01A26B2H	SIE	SCA 20A, 400V, 0.02A, 2.5V				 图 C-70
ThyDF74A40	SIE	SCA 130A, 600V, 0.25A, 1.5V	C-70			
ThyDF74A53K59	SIE	SCA 130A, 800V, 0.25A, 1.5V	C-70			 图 H-13
ThyDF74A53k-V1	SIE	SCA 65A, 800V	H-13			
ThyDF74A53m-V1	SIF	SCA 130A, 800V, 0.25A, 1.5V	C-70			 图 C-57
ThyDF74A53m-V2	SIE	SCA 130A, 800V, 0.25A, 1.5V	C-70			
ThyDF74A60K59	SIE	SCA 130A, 900V, 0.25A, 1.5V	C-70			
ThyDF74A 60m-V1, V2	SIE	SCA 130A, 900V, 0.25A, 1.5V	C-70			
ThyDF74A66	SIE	SCA 130A, 1kV, 0.25A, 1.5V	C-70			
ThyDF74A 80k-V1, V2	SIE	SCA 65A, 1.2kV	H-13			
ThyDF74A 80kS9-V1, V2	SIE	SCA 120A, 1.2kV, 0.25A, 1.5V	C-70			
ThyDF74A 80m-V1, V2	SIE	SCA 130A, 1.2kV, 0.25A, 1.5V	C-70			
ThyDF74A 86k-V1, V2	SIE	SCA 65A, 1.3kV	H-13			
ThyDF74A 86kS9-V1, V2	SIE	SCA 130A, 1.3kV, 0.25A, 1.5V	C-70			
ThyDF74A 86mV1, V2	SIE	SCA 130A, 1.3kV, 0.25A, 1.5V	C-70			
ThyDF75A40	SIE	SCA 96A, 600V, 0.2A, 1.5V	C-57			
ThyDF75A53	SIE	SCA 96A, 800V, 0.2A, 1.5V	C-57			
ThyDF75A60	SIE	SCA 96A, 900V, 0.2A, 1.5V	C-57			
ThyDF75A80	SIE	SCA 96A, 1.3kV, 0.2A, 1.5V	C-57			
ThyDF77A40I	SIE	SCA 130A, 600V, 0.25A, 1.5V	C-70			

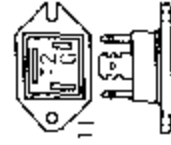
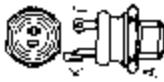
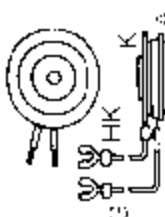
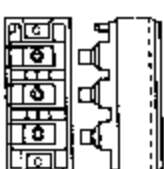
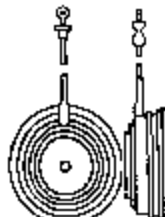

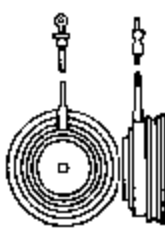
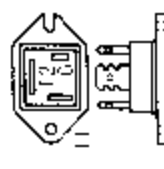

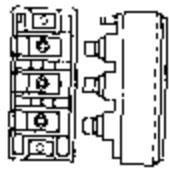
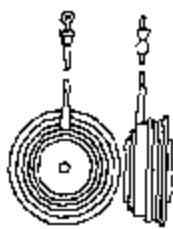
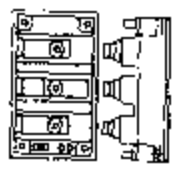
器件型号 Element type	厂名 Manufacturers	材料用途参数 Material Purpose Parameter	图号 Figure	国内外相似替换器件型号 Replace of similar type	备注 Notes	外形参考图 Reference snape
ThyDF77A40g	SIE	SCA 240A, 600V, 0.25A, 1.5V	C-57			 图 C-57
ThyDF77A46f, g	SIE	SCA 130A, 700V, 0.25A, 1.5V	C-70			
ThyDF77A53f, g	SIE	SCA 130A, 800V, 0.25A, 1.5V	C-70			
ThyDF77A60f, g	SIE	SCA 130A, 900V, 0.25A, 1.5V	C-70			
ThyDF77A66f, g	SIE	SCA 130A, 1KV, 0.25A, 1.5V	C-70			
ThyDG74A53	SIE	SCA 180A, 600V, 0.25A, 1.5V	C-57			
ThyDG74A60	SIE	SCA 180A, 900V, 0.25A, 1.5V	C-57			
ThyDG74A66	SIE	SCA 180A, 1KV, 0.25A, 1.5V	C-57			
ThyDG74A80	SIE	SCA 180A, 1.2KV, 0.25A, 1.5V	G-18			
ThyDG74A86	SIE	SCA 180A, 1.3KV, 0.25A, 1.5V	C-57			
ThyDG75A40	SIE	SCA 130A, 600V, 0.2A, 1.5V	C-57			 图 G-18
ThyDG75A53	SIE	SCA 130A, 800V, 0.2A, 1.5V	C-57			
ThyDG75A60	SIE	SCA 130A, 900V, 0.2A, 1.5V	C-57			
ThyDG75A60	SIE	SCA 130A, 1.2KV, 0.2A, 1.5V	C-57			
ThyDG75A90	SIE	SCA 130A, 1.3KV, 0.2A, 1.5V	C-57			
ThyDG75A110	SIE	SCA 95A, 1.6KV, 0.2A, 1.5V	C-57			
ThyDG77A40	SIE	SCA 180A, 600V, 0.25A, 1.5V	C-57			
ThyDG77A46	SIE	SCA 180A, 700V, 0.25A, 1.5V	C-57			
ThyDG77A53	SIE	SCA 180A, 800V, 0.25A, 1.5V	C-57			
ThyDH74A40K	SIE	SCA 120A, 600V	H-13			
ThyDH74A40m	SIE	SCA 240A, 600V, 0.25A, 1.5V	C-57			
ThyDH74A53K	SIE	SCA 120A, 800V	H-13			
ThyDH74A53m	SIE	SCA 240A, 800V, 0.25A, 1.5V	C-57			
ThyDH74A40m	SIE	SCA 240A, 600V, 0.25A, 1.5V	C-57			
ThyDH74A60m	SIE	SCA 240A, 900V, 0.25A, 1.5V	C-57			
ThyDH74A66m	SIE	SCA 240A, 1KV, 0.25A, 1.5V	C-57			



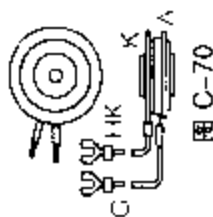
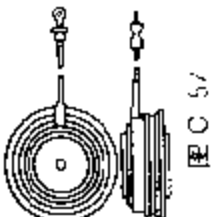
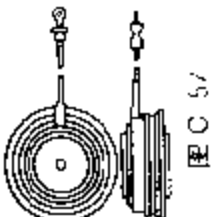
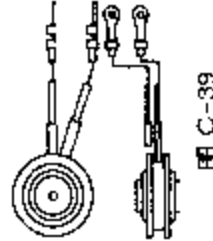

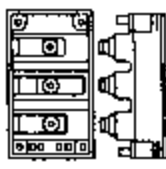
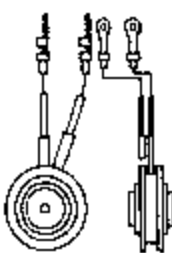
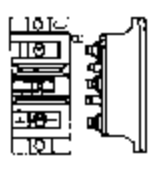
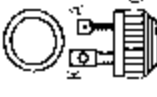





器件型号 Element type	厂名 Manufacturers	材料用途参数 Material Purpose Parameter	图号 Figure	国内外相似替换器件型号 Replace of similar type	备注 Notes	外形参考图 Reference shape
ThyDH74A80k	SIE	SCA 120A, 1.2kV	H-13			 图 H-13
ThyDH74A86k	SIE	SCA 120A, 1.3kV	H-13			
ThyDH74A86m	SIE	SCA 240A, 1.3kV, 0.25A, 1.5V	C-57			
ThyDH75A40	SIE	SCA 150A, 600V, 0.2A, 1.5V	C-57			
ThyDH75A53	SIE	SCA 150A, 800V, 0.2A, 1.5V	C-57			
ThyDH75A60	SIE	SCA 150A, 900V, 0.2A, 1.5V	C-57			
ThyDH75A80	SIE	SCA 150A, 1.2kV, 0.2A, 1.5V	C-57			
ThyDH75A90	SIE	SCA 150A, 1.3kV, 0.2A, 1.5V	C-57			
ThyDH75A110	SIE	SCA 150A, 1.6kV, 0.2A, 1.5V	C-57			
ThyDH77A53f	SIE	SCA 120A, 800V	H-13			
ThyDH77A60f	SIE	SCA 120A, 900V	H-13			
ThyDH77A66f	SIE	SCA 120A, 1kV	H-13			
ThyDK75A110V2	SIE	SCA 95A, 1.6kV, 0.2A, 1.5V	H-13			 图 C-57
ThyDM74A40k	SIE	SCA 250A, 600V	H-18			
ThyDM74A53k	SIE	SCA 250A, 800V	H-18			
ThyDM74A80k	SIE	SCA 250A, 1.2kV	H-18			
ThyDM74A86k	SIE	SCA 250A, 1.3kV	H-18			 图 H-18
ThyDM77A53f	SIE	SCA 250A, 800V	H-18			
ThyDM77A60f	SIE	SCA 250A, 900V	H-18			
ThyDM77A66f	SIE	SCA 250A, 1kV	H-18			
ThyF74A53k	SIE	SCA 65A, 800V	H-13			
ThyF74A80k	SIE	SCA 65A, 1.2kV	H-13			
ThyF74A86k	SIE	SCA 65A, 1.3kV	H-13			



器件型号 Element type	厂名 Manufacturers	材料用途参数 Material Purpose Parameter	图号 Figure	国内外相似替换器件型号 Replace of similar type	备注 Notes	外形参考图 Reference shape
ThyF77A461, g	SIE	SCA 130A, 700V, 0.25A, 1.5V	C-70			 图 C-70
ThyF77A531, g	SIE	SCA 130A, 800V, 0.25A, 1.5V	C-70			
ThyF77A601, g	SIE	SCA 130A, 900V, 0.25A, 1.5V	C-70			
ThyF77A661, g	SIE	SCA 130A, 1kV, 0.25A, 1.5V	C-70			
ThyG74A40k	SIE	SCA 180A, 600V, 0.25A, 1.5V	C-57			 图 C-57
ThyG74A86k	SIE	SCA 180A, 1.3kV, 0.25A, 1.5V	C-57			
ThyG77A461	SIE	SCA 180A, 700V, 0.25A, 1.5V	C-57			
ThyG77A531	SIE	SCA 180A, 800V, 0.25A, 1.5V	C-57			
ThyH74A40k, m	SIE	SCA 240A, 600V, 0.25A, 1.5V	C-57			 图 C-57
ThyH74A53k, m	SIE	SCA 240A, 800V, 0.25A, 1.5V	C-57			
ThyH74A60k, m	SIE	SCA 240A, 900V, 0.25A, 1.5V	C-57			
ThyH74A66k	SIE	SCA 240A, 1kV, 0.25A, 1.5V	C-57			
ThyH74A86m	SIE	SCA 240A, 1.3kV, 0.25A, 1.5V	C-57			
ThyH77A40f	SIE	SCA 240A, 600V, 0.25A, 1.5V	C-57			
ThyH77A46f	SIE	SCA 240A, 700V, 0.25A, 1.5V	C-57			
ThyH77A53f	SIF	SCA 240A, 800V, 0.25A, 1.5V	C-57			 图 C-39
ThyH77A60f	SIE	SCA 240A, 900V, 0.25A, 1.5V	C-57			
ThyH77A66f	SIE	SCA 240A, 1kV, 0.25A, 1.5V	C-57			
ThyL75A40S, V	SIE	SCA 135A, 600V, 0.25A, 1.5V	C-39			
ThyL75A53S, V	SIE	SCA 135A, 800V, 0.25A, 1.5V	C-39			
ThyL75A80S, V	SIE	SCA 135A, 1.2kV, 0.25A, 1.5V	C-39			
ThyL75A90S, V	SIE	SCA 135A, 1.3kV, 0.25A, 1.5V	C-39			
ThyL75A110S, V	SIE	SCA 135A, 1.6kV, 0.25A, 1.5V	C-39			

器件型号 Element type	厂名 Manufacturers	材料用途参数 Material Purpose Parameter	图号 Figure	国内外相似替换器件型号 Hoplacel of similar type	备注 Notes	外形参考图 Reference shape
ThyM74A53	SIE	SCA 250A, 800V	H-18			 图 H-18
ThyM74A80	SIE	SCA 250A, 1.2kV	H-18			
ThyM74A86	SIE	SCA 250A, 1.3kV	H-18			
ThyM75A40	SIE	SCA 160A, 600V, 0.25A, 1.5V	C-39			
ThyM75A53	SIE	SCA 160A, 800V, 0.25A, 1.5V	C-39			
ThyM75A80	SIE	SCA 150A, 1.2kV, 0.25A, 1.5V	H-18			 图 C-39
ThyM75A90	SIE	SCA 160A, 1.6kV	H-17			
ThyM75A110	SIE	SCA 160A, 1.6kV	H-17			
ThyM77A40	SIE	SCA 250A, 600V	H-18			 图 H-18
ThyM77A60	SIE	SCA 250A, 900V	H-18			
ThyM77A66	SIE	SCA 250A, 1kV	H-18			
TIC20		Triac 10A, 200V, 0.05A	C-85	TIC220B, 2N5567		 图 C-85
TIC21		Triac 10A, 400V, 0.05A	C-85	TIC220D, 2N5568		
TIC22		Triac 10A, 200V, 0.05A	C-85	TIC222B, 2N5569		
TIC23		Triac 10A, 400V, 0.05A	C-85	TIC222D, 2N5570		
TIC39A		SCR-D 25A, 100V, 200 μA	B-62	TAG615-100, 2N6238, 2N6334, 2N6335, 2N6336, 2N6337		 图 B-62
TIC39B		SCR-D 25A, 200V, 200 μA	B-62	TAG615-200, 2N6239, 2N6335, 2N6336, 2N6337		
TIC39C		SCR-D 10A, 300V, 200 μA	B-62	MCR100-5, TAG615-400, 2N6336, 2N6337		
TIC39D		SCR-D 25A, 400V, 200 μA	B-62	TAG615-400, 2N6240, 2N6337		
TIC39E		SCR-D 10A, 500V, 200 μA	B-62	MCR100-7		
TIC39F		SCR-D 25A, 50V, 200 μA	B-62	TAG615-100, 2N6237, 2N6333, 2N6334, 2N6335, 2N6336, 2N6337		
TIC39Y		SCR-D 25A, 30V, 200 μA	B-62	TAG615-100, 2N6236, 2N6332, 2N6333, 2N6334, 2N6335, 2N6336, 2N6337		



器件型号 Element type	厂名 Manufacturers	材料用途参数 Material Purpose Parameter	图号 Figure	国内外相似替换器件型号 Replace of similar type	备注 Notes	外形参考图 Reference shape
TIC44	SST, TII	SCR-D 0.3A, 30V, 200 μ A, 0.8V	B-36	BRY55-30, ECG5400, TAG70, TIC60, TIC61, TIC62, TIC63, TIC64, 2N5060		 图 B-36
TIC45	SST, TII	SCR-D 0.3A, 60V, 200 μ A, 0.8V	B-36	BRY55-60, ECG5401, TIC61, TIC62, TIC63, TIC64, 2N5061		 图 B-36
TIC46	SST, TII	SCR-D 0.8A, 100V, 200 μ A, 0.005A	B-19	BRY55-100, MCR100-3, TIC62, TIC63, TIC64, 2N5062		 图 B-19
TIC47	SST, TII	SCR-D 0.3A, 200V, 200 μ A, 0.8V	B-36	BRY55-200, ECG5404, MCR100-4, TIC64, 2N5064		 图 B-19
TIC60		SCR-D 0.8A, 30V, 200 μ A	B-35	2N5060		 图 B-35
TIC61		SCR-D 0.8A, 60V, 200 μ A	B-35	2N5061		 图 B-35
TIC62		SCR-D 0.8A, 100V, 200 μ A	B-35	2N5062		 图 B-35
TIC63		SCR-D 0.8A, 150V, 200 μ A	B-35	2N5063		 图 B-35
TIC64		SCR-D 0.8A, 200V, 200 μ A	B-35	2N5064		 图 B-35
TIC101A	TII, TIB	50Hz-Thy 5A, 100V, 400 μ A, 1V	C-85	S1006LS3, TAG623-100, TAG628-100, TIC106A		 图 B-35
TIC101B	TII, TIB	50Hz-Thy 5A, 200V, 400 μ A, 1V	C-86	S2006LS3, TAG623-200, TAG628-200, TIC106B		 图 C-86
TIC101C	TII, TIB	50Hz-Thy 5A, 300V, 400 μ A	B-11	TAG623-300, TAG628-300, TIC106C		图 C-86
TIC101D	TII, TIB	50Hz-Thy 5A, 400V, 400 μ A, 1V	C-86	S4006LS3, TAG623-400, TAG628-400, TIC106D		图 C-86
TIC101E	TII, TIB	50Hz-Thy 5A, 500V, 400 μ A	B-11	TAG623-500, TAG628-500, TIC106E		图 C-86
TIC101F	TII, TIB	50Hz-Thy 5A, 50V, 400 μ A, 1V	C-86	S0506LS3, TAG623-100, TAG628-100, TIC106F		图 C-86
TIC101M	TII, TIB	50Hz-Thy 5A, 600V, 400 μ A, 1V	C-86	TAG623-600, TAG628-600, TIC106M		图 C-86
TIC101Y	TII, TIB	50Hz-Thy 5A, 30V, 400 μ A, 1V	C-86	S0306LS3, TAG623-100, TAG628-100, TIC106Y		图 C-86
TIC102A	TII, TIB	50Hz-Thy 5A, 100V, 0.005A, 1V	C-86	CS3-02, S1006L, TAG622-100, TAG627-100		图 B-11
TIC102B	TII, TIB	50Hz-Thy 5A, 200V, 0.005A, 1V	C-86	CS3-02, S2006L, TAG622-200, TAG627-200		图 B-11
TIC102D	TII, TIB	50Hz-Thy 5A, 400V, 0.005A, 1V	C-86	CS3-04, S4006L, TAG622-400, TAG627-400		图 B-11
TIC102F	TII, TIB	50Hz-Thy 5A, 50V, 0.005A, 1V	C-86	CS3-06, S0506L, TAG622-100, TAG627-100		图 B-11
TIC102M	TII, TIB	50Hz-Thy 5A, 600V, 0.005A, 1V	C-86	CS3-06, S6006L, TAG622-600, TAG627-600		图 B-11
TIC102Y	TII, TIB	50Hz-Thy 5A, 30V, 0.005A, 1V	C-86	S0306L, TAG622-100, TAG627-100		图 B-11

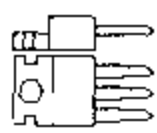
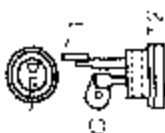
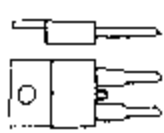



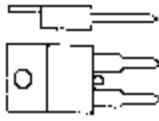
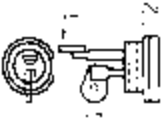
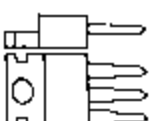

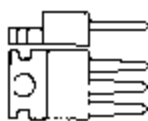
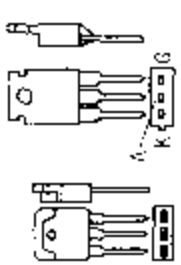
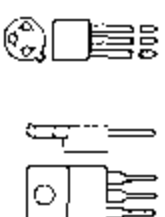
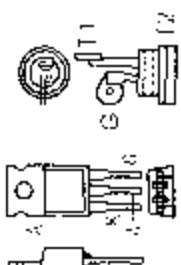



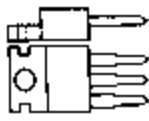
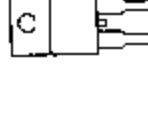
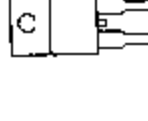
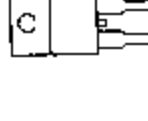





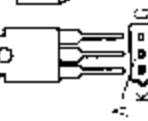

器件型号 Element type	厂名 Manufacturer's	材料用途参数 Material Purpose Parameter	图号 Figure	国内外相似替换器件型号 Repiece of similar type	备注 Notes	外形参考图 Reference shape
TIC106A	TII, TIB	50Hz-Thy 5A, 100V, 200 μ A, 1V	B-20	ECG5437, S4060A, T106A1, TAG623-100, TAG628-100		 图 B-20
TIC106B	TII, TIB	50Hz-Thy 5A, 200V, 200 μ A, 1V	B-20	ECG5437, S4060B, T106B1, TAG623-200, TAG628-200		
TIC106C	TII, TIB	50Hz-Thy 5A, 300V, 200 μ A, 1V	B-20	ECG5437, S4060C, T106C1, TAG623-300, TAG628-300		
TIC106D	TII, TIB	50Hz-Thy 5A, 400V, 200 μ A, 1V	B-20	ECG5437, S4060D, T106D1, TAG623-400, TAG628-400		
TIC106E	TII, TIB	50Hz-Thy 3.2A, 500V, 200 μ A, 1.2V	B-20	S4060E, TAG623-500, TAG628-500		
TIC106F	TII, TIB	50Hz-Thy 5A, 50V, 200 μ A, 1V	B-20	ECG5437, S4060F, T106A1, TAG623-100, TAG628-100		
TIC106M	TII, TIB	50Hz-Thy 3.2A, 600V, 200 μ A, 1.2V	B-20	S4060M, TAG623-600, TAG628-600		
TIC106N	TII, TIB	50Hz-Thy 3.2A, 800V, 200 μ A, 1.2V	B-20	S4060N, TAG623-800, TAG628-800		
TIC106S	TII, TIB	50Hz-Thy 3.2A, 700V, 200 μ A, 1.2V	B-20	S4060S, TAG623-700, TAG628-700		
TIC106Y	TII	50Hz-Thy 5A, 30V, 200 μ A, 1V	B-20	ECG5437, S4060F, T106Y1, TAG623-100, TAG628-100		 图 C-86
TIC108A	TII, TIB	50Hz-Thy 5A, 100V, 0.001A, 100V	C-86	TAG622-100, TAG623-100, TAG628-100, TIC106A		
TIC108B	TII, TIB	50Hz-Thy 5A, 200V, 0.001A, 200V	C-86	TAG622-200, TAG623-200, TAG628-200, TIC106B		
TIC108C	TII, TIB	50Hz-Thy 5A, 300V, 0.001A, 300V	C-86	TAG622-300, TAG623-300, TAG628-300, TIC106C		
TIC108D	TII, TIB	50Hz-Thy 5A, 400V, 0.001A, 400V	C-86	TAG622-400, TAG623-400, TAG628-400, TIC106D		
TIC108E	TII, TIB	50Hz-Thy 5A, 500V, 0.001A, 500V	C-86	TAG622-500, TAG623-500, TAG628-500, TIC106E		
TIC108M	TII, TIB	50Hz-Thy 5A, 600V, 0.001A, 600V	C-86	TAG622-600, TAG623-600, TAG628-600, TIC106E		
TIC108N	TII, TIB	50Hz-Thy 5A, 800V, 0.001A, 800V	C-86	TAG622-800, TAG623-800, TAG628-800, TIC106M		
TIC108S	TII, TIB	50Hz Thy 5A, 700V, 0.001A, 700V	C-86	TAG622-700, TAG623-700, TAG628-700, TIC106S		
TIC116A	TII, TIB	50Hz-Thy 6A, 100V, 0.02A, 1.5V	B-9	BSIC1026M, ECG5462, C122A1, CS6-02, S2800A, TAG660-100		 图 B-9



器件型号 Element type	厂名 Manufacturers	材料 Material	用途 Purpose	参数 Parameter	图号 Figure	国内外相似替换器件型号 Replace of similar type	备注 Notes	外形参考图 Reference shape
TIC116B		50Hz-Thy	8A, 100V, 0.02A	B-9		BSIC1026M, C122B1, CS6-02, S2800B, TAG660-200		 图 B-9
TIC116C	TII, TIB	50Hz-Thy	8A, 300V, 0.02A, 1.5V	B-9		BSIC1026M, CS6-04, C122C1, ECG5465, S2800C, TAG660-400		
TIC116D	TII, TIB	50Hz-Thy	8A, 400V, 0.02A, 1.5V	B-9		BSIC1026M, ECG5465, C122D1, CS6-04, S2800D, TAG660-400		
TIC116E	TII, TIB	50Hz-Thy	8A, 500V, 0.02A, 1.5V	B-9		BSIC1033M, C122E1, CS6-06, S2800E		
TIC116F	TII, TIB	50Hz-Thy	8A, 50V, 0.02A, 1.5V	B-9		BSIC1026M, ECG5461, C122F1, CS6-02, S2800F, TAG660-100		
TIC116M	TII, TIB	50Hz-Thy	6A, 600V, 0.02A, 1.5V	B-9		BSIC1040M, C122M1, CS6-06, S2800M, TAG660-600		
TIC116N	TII, TIB	50Hz-Thy	8A, 800V, 0.02A, 1.5V	C-86		BSIC1053M, CS6-08, S2800N, TAG660-800		
TIC116S	TII	50Hz-Thy	5A, 700V, 0.02A, 2.5V	B-20		BSIC1046M, CS6-08, S2800S, TAG660-700		 图 C-86
TIC122B	TII	50Hz-Thy	8A, 200V, 0.025A, 1.5V	C-86		BSID1026, S2008L, TAG680-200, TIC126B		
TIC122D	TII	50Hz-Thy	8A, 400V, 0.025A, 1.5V	C-86		BSID1026, S4008L, TAG680-400, TIC126D		
TIC122E	TII	50Hz-Thy	8A, 500V, 0.025A, 1.5V	C-86		BSID1033, S6008L, TAG680-500, TIC126E		
TIC122F	TII	50Hz-Thy	8A, 50V, 0.025A, 1.5V	C-86		BSID1026, S0508L, TAG680-100, TIC126F		
TIC126A	TII, TIB	50Hz-Thy	12A, 100V, 0.02A, 1.5V	B-9		S1010L, TAG680-100, 2N6395		
TIC126B	TII, TIB	50Hz-Thy	12A, 200V, 0.02A, 1.5V	B-9		S2010L, TAG680-200, 2N6396		
TIC126C	TII, TIB	50Hz-Thy	12A, 300V, 0.02A, 1.5V	B-9		MCR220-5, S4010L, TAG680-300		
TIC126D	TII, TIB	50Hz-Thy	12A, 400V, 0.02A, 1.5V	B-9		BSID1026, S4010L, TAG680-400, T7.5N400FOB, T9.5N400FOB, 2N6397		 图 B-20
TIC126E	TII, TIB	50Hz-Thy	12A, 500V, 0.02A, 1.5V	B-9		BSID1033, MCR220-7, S6010L, TAG680-500, T7.5N500FOB, T9.5N500FOB		
TIC126F	TII, TIB	50Hz-Thy	12A, 50V, 0.02A, 1.5V	B-9		S0510L, TAG680-100, 2N6394		
TIC126M	TII, TIB	50Hz-Thy	12A, 600V, 0.02A, 1.5V	B-9		BSID1040, S6010L, TAG680-600, T7.5N600FOB, T9.5N600FOB, 2N6398		



器件型号 Element type	厂名 Manufacturers	材料 Material	用途 Purpose	参数 Parameter	图号 Figure	国内外相似替换器件型号 Replace of similar type	备注 Notes	外形参考图 Reference shape
TIC126N	TII, TIB	50Hz-Thy	7.5A, 600V, 0.02A, 1.5V		B-20	BSID1053, TAG680-800, T7.5N800FOB, T9.5N800FOB		 图 B-20
TIC126S	TIB	50Hz-Thy	7.5A, 700V, 0.02A, 1.5V		B-20	BSID1046, TAG680 700, T7.5N700FOB, T9.5N700FOB		 图 B-84 图 B-90
TIC163A...F		50Hz-Thy	25A, 50-500V, 0.02A, 0.04A		B-84			
TIC201A	ASI, TII	Triac	2.5A, 100V, 0.025A, 2.5V		B-90	TAG220-100, TAG225-100, IAG231-200		
TIC201B	ASI, TII	Triac	2.5A, 200V, 0.025A, 2.5V		B-90	TAG220-200, TAG225-200, TAG231-200		
TIC201C	ASI, TII	Triac	2.5A, 300V, 0.025A, 2.5V		B-90	TAG220-300, TAG225-300, TAG231-400		
TIC201D		Triac	2.5A, 400V, 0.025A		B-11	TAG220-400, TAG225-400, TAG231-400		
TIC201E	ASI, TII	Triac	2.5A, 500V, 0.025A, 2.5V		B-90	TAG220-500, TAG225-500, TAG231-600		
TIC201M	ASI, TII	Triac	2.5A, 600V, 0.025A, 2.5V		B-90	TAG220-600, TAG225-600, TAG231-600		
TIC201N	ASI, TII	Triac	2.5A, 800V, 0.025A, 2.5V		B-90	TAG220-800, TAG225-800, TAG231-800		
TIC201S	TII, TIB	Triac	2.5A, 700V, 0.025A, 2.5V		B-90	TAG220 700, TAG225-700, TAG231-700		
TIC205A		Triac	2A, 100V, 0.05A, 2V		B-62	T2301PA, T2302A, TAG201-100, TAG202-100		 图 B-11 图 B-62
TIC205B		Triac	2A, 200V, 0.05A, 2V		B-62	T2301PB, T2302B, TAG201-200, TAG202-200		
TIC205D		Triac	2A, 400V, 0.05A, 2V		B-62	T2301PD, T2302D, TAG201-400, TAG202-400		
TIC206A	ASI, TII	Triac	3A, 100V, 0.005A, 2V		B-91	Q2003L3, TAG232-100, TIC216A, TXC18G40, TXC18H40, 2N6070A		
TIC206B	ASI, TII	Triac	3A, 200V, 0.005A, 2V		B-91	Q2003L3, TAG232-200, TIC216B, TXC18G40, TXC18H40, 2N6071A		
TIC206C	ASI, TII	Triac	3A, 300V, 0.005A, 2V		C-86	TAG232-400, TIC216C, TXC18G40, TXC18H40, 2N6073A		 图 B 91 图 C-86
TIC206D	ASI, TII	Triac	3A, 400V, 0.006A, 2V		B-91	Q4003L3, TAG232-400, TIC216D, TXC18G40, TXC18H40		
TIC206E	ASI, TII	Triac	3A, 500V, 0.005A, 2V		B-20	TAG232-600, TIC216E, TXC18G60, TXC18H60		
TIC206M	ASI, TII	Triac	3A, 600V, 0.005A, 2V		B-20	TAG232-600, TIC216M, TXC18G60, TXC18H60		
TIC206N	ASI, TII	Triac	3A, 700V, 0.005A, 2V		B-20	TAG232-800, TIC216N, TXC18G80, TXC18H80		



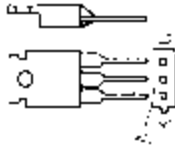
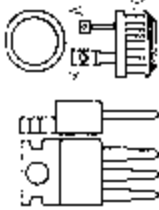
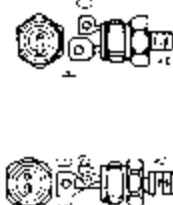
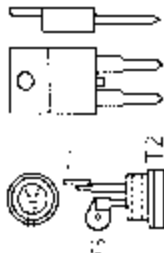



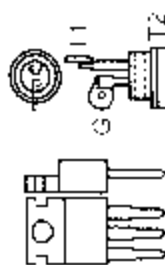
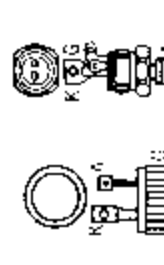
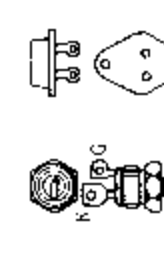

















器件型号 Element type	厂名 Manufacturers	材料用途参数 Material Purpose Parameter	图号 Figure	国内外相似替换器件型号 Replace of similar type	备注 Notes	外形参考图 Reference shape
TIC206S	TII, TIB	3A, 800V, 0.005A, 2V	B-20	TAG232-800, TIC216S, TXC18G70, TXC18H70		
TIC215A		4A, 100V, 0.01A, 0.03A	B-62	TAG202-200, TAG202A-200, T2302B, 2N6070B		
TIC215B		4A, 200V, 0.01A, 0.03A	B-62	TAG202-200, TAG202A-200, T2302B, 2N6071B		
TIC215D		4A, 400V, 0.01A, 0.03A	B-62	TAG202 400, TAG202A-400, T2302D, 2N6073D		
TIC216A	ASI, TII	6A, 100V, 0.005A, 2.2V	B-9	ECG5608, MAC228A4, TAG221-100, TAG226-100, TXC18H40M		
TIC216B	ASI, TII	6A, 200V, 0.005A, 2.2V	B-9	ECG5608, MAC228A4, TAG221-200, TAG226-200, TXC18H40M		
TIC216C	TIB	6A, 300V, 0.005A, 2.2V	D-9	TAG221-400, TAG226-400, TXC18H40M		
TIC216D	ASI, TII	6A, 400V, 0.005A, 2.2V	B-9	ECG5608, MAC228A6, TAG221-400, TAG226-400, TXC18H40M		
TIC216E	TII, TIB	6A, 500V, 0.005A, 2.2V	D-9	TAG221-500, TAG226-500, TXC18H50M		
TIC216M	TII, TIB	6A, 600V, 0.005A, 2.2V	D-9	TAG221-600, TAG226-600, TXC18H60M		
TIC216N	TII, TIB	6A, 800V, 0.005A, 2.2V	D-9	TAG221-800, TAG226-800, TXC18H80M		
TIC216S	TII, TIB	6A, 700V, 0.005A, 2.2V	C-86	TAG221-700, TAG226-700, TXC18H70M		
TIC220B		10A, 200V, 0.05A	C-85	BS802B, BS802B, TW6N200H, T4100B, 2N5567		
TIC220D		10A, 400V, 0.05A	C-85	BS604B, BS804B, TW6N400, T4100D, 2N5568		
TIC220E		10A, 600V, 0.05A	C-85	BS605B, BS805B, TW6N500, T4100M, T4101M		
TIC221B		10A, 200V, 0.05A	F-57	MCA4121B, SC245B3, SC250B3, T4120B, T6421B		
TIC221D		10A, 400V, 0.05A	F-57	MCA4121D, SC245D3, SC250D3, T4120D, T6421D		
TIC221E		10A, 600V, 0.05A	F-57	MCA4121M, SC245E3, SC250E3, T4120E, T6421E		
TIC222B		10A, 200V, 0.05A	F-57	BS6-02A, BS8-02A, SC245B, TW6N200C, 2N5569		
TIC222D		10A, 400V, 0.05A	F-57	RS6-04A, BS8-04A, SC245D, TW6N400C, 2N5570		
TIC222E		10A, 600V, 0.05A	F-57	BS6-06A, BS8-06A, SC245E, T4111M, TW6N600C		
TIC225A	TII, TIB	8A, 100V, 0.005A, 3V	B-90	TAG227-100		
TIC225B	ASI, TII	8A, 200V, 0.005A, 3V	B-90	TAG227-200		

器件型号 Element type	厂名 Manufacturers	材料用途参数 Material Purpose Parameter	图号 Figure	国内外相似替换器件型号 Replace of similar type	备注 Notes	外形参考图 Reference shape
TIC225C	ASI, TII	Triac 8A, 300V, 0.005A, 3V	B-90	TAG227-300		 图 B-90
TIC225D	ASI, TII	Triac 8A, 400V, 0.005A, 3V	B-90	ECG5608, TAG227-400		
TIC225E	ASI, TII	Triac 8A, 500V, 0.005A, 3V	B-90	TAG227-500		
TIC225M	ASI, TII	Triac 8A, 600V, 0.005A, 3V	B-90	ECG5609, TAG227-600		
TIC225N	ASI, TII	Triac 8A, 800V, 0.005A, 3V	B-90	ECG5610, IAG227-700		
TIC225S	TII, TIB	Triac 8A, 700V, 0.005A, 3V	B-90	TAG227-800		
TIC226A...S	TIB	Triac 8A, 100-800V, 0.05A, 2.5V	B-20	BT137/..., MAC222..., TAG224..., T2802...		
TIC230B		SCR-D 10A, 200V, 0.05A	C-85	BS10-02B, SC246B, TW10N200CT, T4100B, 2N5567		 图 B-20 图 C-85
TIC230D		SCR-D 10A, 400V, 0.05A	C-85	BS10-04B, SC246D, TW10N400CT, T4100D		
TIC230E		SCR-D 10A, 600V, 0.05A	C-85	BS10-06B, SC246M, TW10N600CT, T4100M		
TIC231B		SCR-D 10A, 200V, 0.05A	F-57	SC245B3, SC250B3, SC260B3, T4120R, T4121R		
TIC231D		SCR-D 10A, 400V, 0.05A	F-57	SC245D3, SC250D3, SC260D3, T4120D, T4121D		
TIC231E		SCR-D 10A, 600V, 0.05A	F-57	SC245M3, SC250M3, SC260M3, T4120M, T4121M		
TIC232B		SCR-D 10A, 200V, 0.05A	F-47	BS10-02A, SC245B, TXD99A20, T4110B, 2N5569		 图 F-57 图 F-47
TIC232D		SCR-D 10A, 400V, 0.05A	F-47	BS10-04A, SC245D, TXD99A40, T4110D, 2N5570		
TIC232E		SCR-D 10A, 600V, 0.05A	F-47	BS10-06A, SC245M, TXD99A60, T4110M, T4111M		
TIC236A	TII, TIB	Triac 12A, 100V, 2.5V	C-86	TW11N400, TXD10K40P, 2N6342A, 2N6343A, 2N6344A, 2N6345A		 图 B-9 图 C-86
TIC236B	TII, TIB	SCR-D 12A, 200V, 0.05A, 2.5V	B-9	ECG56004, Q2015L5, T2800B, TW11N400, TXD10K40P, 2N6342A, 2N6344A, 2N6345A		
TIC236C	TII, TIB	Triac 12A, 300V, 0.05A, 2.5V	B-20	TW11N400, TXD10K40P, 2N6343A, 2N6344A, 2N6345A		
TIC236D	TII, TIB	SCR-D 12A, 400V, 0.05A, 2.5V	B-9	ECG56006, Q4015L5, T2800D, TW11N400, TXD10K40P, 2N6343A, 2N6344A, 2N6345A		
TIC236E	TII, TIB	Triac 12A, 500V, 0.05A, 2.5V	C-86	TW11N600, TXD10K50P, 2N6344A, 2N6345A		
TIC236M	TII, TIB	Triac 12A, 600V, 0.05A, 2.5V	C-86	Q6015L5, TW11N600, TXD10K60P, 2N6344A, 2N6345A		



器件型号 Element type	厂名 Manufacturers	材料用途参数 Material Purpose Parameter	图号 Figure	国内外相似替换器件型号 Replace of similar type	备注 Notes	外形参考图 Reference shape
TIC236N	TII, TIB	12A, 800V, 0.05A, 2.5V	B-20	TW11N800, TXD10K80P, 2N6345A		 图 B-20 图 C-86
TIC236S	TII, TIB	12A, 700V, 0.05A, 2.5V	C-86	TW11N700, TXD10K70P, 2N6345A		
TIC240B	SCR-D	15A, 200V, 0.05A	C-85	SC251B, T6400B, T6405B, 2N5571, 2N6157, 2N6159		 图 C-85 图 F-57
TIC240D	SCR-D	15A, 400V, 0.05A	C-85	SC251D, T6400D, T6405D, 2N5572, 2N6157, 2N6159		
TIC240E	SCR-D	15A, 600V, 0.05A	C-85	SC251M, T6400M, T6405M, T4100M, 2N6157, 2N6158, 2N6159		
TIC241B	SCR-D	15A, 200V, 0.05A	F-57	SC251B3, SC260R3, T4120B, 2N6145, 2N6146, 2N6147		 图 F-57
TIC241D	SCR-D	15A, 400V, 0.05A	F-57	SC251D3, SC260D3, T4120D, 2N6145, 2N6146, 2N6147		
TIC241E	SCR-D	15A, 600V, 0.05A	F-57	SC251M3, SC260M3, T4120M, 2N6145, 2N6146, 2N6147		
TIC242B	SCR-D	15A, 200V, 0.05A	F-47	SC250B, IXD98A20, IXE99A20, 2N5573		 图 F-47 图 D-14
TIC242D	SCR-D	15A, 400V, 0.05A	F-47	SC250D, TW18N400CT, TXD98A40, TXE99A60, 2N5574		
TIC242E	SCR-D	15A, 600V, 0.05A	F-47	SC250M, TW18N600CT, TXD98A40, TXE99A60, T4110M		
TIC246A...S	TII, TIB	12.4A, 100-800V, 0.05A, 2.5V	C-86	MAC15..., MAC223..., TXE10..., T6001...		 图 D-14
TIC250B	Triac	20A, 200V, 0.1A	D-14	SC261B, T6400B, T6400B, 2N6157, 2N6158, 2N6159		
TIC250D	Triac	20A, 400V, 0.1A	D-14	SC261D, T6400D, T6400D, 2N6158, 2N6159		
TIC250E	Triac	20A, 500V, 0.1A	D-14	SC261M, T6400E, T6400E, 2N6159		
TIC250M	Triac	20A, 600V, 0.1A	D-14	SC261M, T6400M, 2N6159		 图 F-47 图 D-14
TIC252B...M	SCR-D	30A, 200-600V, 0.1A	F-47	SC260..., T6411..., T6415..., TXE99...		

器件型号 Element type	厂名 Manufacturers	材料 Material	用途 Purpose	参数 Parameter	图号 Figure	国内外相似替换器件型号 Replace of similar type	备注 Notes	外形参考图 Reference shape
TIC253A		Triac		20A, 100V, 0.05A, 2.5V	C-86	BTA26A, BTA41A, TIC263A		
TIC253B		Triac		20A, 200V, 0.05A, 2.5V	B-28	BTA26B, BTA41B, MAC20-4, TIC263B		
TIC253C		Triac		20A, 300V, 0.05A, 2.5V	B-91	BTA26C, BTA41C, TIC263C		
TIC253D	TII, TIR	Triac		20A, 400V, 0.05A, 2.5V	B-28	BTA26D, BTA41D, MAC20-6, TIC263D		
TIC253E	TII, TIB	Triac		20A, 500V, 0.05A, 2.5V	B-28	BTA26E, BTA41E, MAC20-7, TIC263E		
TIC253M	TII, TIB	Triac		20A, 600V, 0.05A, 2.5V	B-28	BTA26M, BTA41M, MAC20-8, TIC263M		
TIC253N		Triac		20A, 600V, 0.05A, 2.5V	C-86	BTA26N, BTA41N, TIC263N		
TIC253S		Triac		20A, 700V, 0.05A, 2.5V	C-86	BTA26S, BTA41S, TIC263S		
TIC260B		SCR-D		30A, 200V, 0.1A	C-85	SC261B, I6400B, T6401B, T6404B, T6405B		
TIC260D		SCR-D		30A, 400V, 0.1A	C-85	SC261D, T6400D, T6401D, T6404D, T6405D		
TIC260E, M		SCR-D		30A, 600V, 0.1A	C-85	SC261M, T6400M, T6401M, T6404M, T6405M		
TIC262B		SCR-D		25A, 200V, 0.1A	C-85	SC260B, TXE99A20, T6401B, T6411B, T6415B		
TIC262D		SCR-D		30A, 400V, 0.1A	C-85	SC260D, TXE99A40, T6411D, T6411D, T6415D		
TIC262E, M		SCR-D		30A, 600V, 0.1A	C-85	SC260M, TXE99A60, T6411M, T6411M, T6415M		
TIC263A...S		Triac		25A, 100~800V, 0.05A, 2.5V	C-86	BTA26-200...800A, BTA41-200...800A, MAC25-4...8		
TIC270B		SCR-D		40A, 200V, 0.1A	C-85	T6400B, 2N5441		
TIC270D		SCR-D		40A, 400V, 0.1A	C-85	T6400D, 2N5442		
TIC270E, M		SCR-D		40A, 600V, 0.1A	C-85	T6400M, 2N5444		
TIC272B		SCR-D		40A, 200V, 0.1A	C-85	T6410B, 2N5444		
TIC272D		SCR-D		40A, 400V, 0.1A	C-85	T6410D, 2N5445		
TIC272E, M		SCR-D		40A, 600V, 0.1A	C-85	T6410M, 2N5446		
TICP100D	TII			1A, 400V, 0.001A, 1V	B-36	2N5546		

器件型号 Element type	厂名 Manufacturers	材料用途参数 Material Purpose Parameter	图号 Figure	国内外相似替换器件型号 Replace of similar type	备注 Notes	外形参考图 Reference shape
TICP106A	TII	2A, 100V, 200 μ A, 1V	B-36			
TICP106B	TII	2A, 200V, 200 μ A, 1V	B-36			图 B-36
TICP106C	TII	2A, 300V, 200 μ A, 1V	B-36			
TICP106D	TII	2A, 400V, 200 μ A, 1V	B-36			
TICP106M	TII	2A, 500V, 200 μ A, 1V	B-36			
TICP108A	TII	2A, 100V, 0.001A, 1V	B-36			
TICP108B	TII	2A, 200V, 0.001A, 1V	B-36			
TICP108C	TII	2A, 300V, 0.001A, 1V	B-36			
TICP108D	TII	2A, 400V, 0.001A, 1V	B-36			
TICP108E	TII	2A, 500V, 0.001A, 1V	B-36			
TICP108M	TII	2A, 600V, 0.001A, 1V	B-36			
TICP206A	TII	1.5A, 100V, 0.008A, 2.5V	B-36			
TICP206B	TII	1.5A, 200V, 0.008A, 2.5V	B-36			
TICP206C	TII	1.5A, 300V, 0.008A, 2.5V	B-36			
TICP206D	TII	1.5A, 400V, 0.008A, 2.5V	B-36			
TICP206E	TII	1.5A, 500V, 0.008A, 2.5V	R-36			
TK1201	THE	120A, 100V, 0.125A, 3V	E-6			
TK1202	THE	120A, 200V, 0.15A, 3V	E-6			
TK1204	THE	120A, 400V, 0.15A, 3V	E-6			
TK1206	THE	120A, 600V, 0.15A, 3V	E-6			
TK1208	THE	120A, 800V, 0.15A, 3V	E-6			
TK1210	THE	120A, 1kV, 0.15A, 3V	E-6			
TK1212	THE	120A, 1.2kV, 0.15A, 3V	F-48			
TK1216	THE	120A, 1.6kV, 0.15A, 3V	F-91			
TK1401	THE	140A, 100V, 0.125A, 3V	E-6	ECG5580		



图 E-6





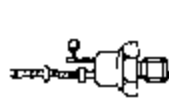

图 F-48

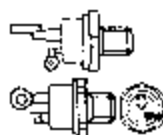

图 F-91

器件型号 Element type	厂名 Manufacturers	材料用途参数 Material Purpose Parameter	图号 Figure	国内外相似替换器件型号 Replace of similar type	备注 Notes	外形参考图 Reference shape
TK1402	THE	140A, 200V, 0.125A, 3V	E-6	ECG5580		 图 E-6
TK1404	THE	140A, 400V, 0.125A, 3V	E-6	ECG5582		
TK1406	THE	140A, 600V, 0.125A, 3V	E-6	ECG5582		
TK1408	THE	140A, 800V, 0.125A, 3V	E-6	ECG5584		
TK1410	THE	140A, 1kV, 0.125A, 3V	E-6	ECG5584		
TK1412	THE	140A, 1.2kV, 0.125A, 3V	E-6	ECG5584		
TK1416	THE	140A, 1.6kV, 0.125A, 3V	E-6	ECG5584		
TK1802	THE	180A, 200V, 0.15A, 3V	E-6			 图 F-59
TK1804	THE	180A, 400V, 0.15A, 3V	E-6			
TK1806	THE	180A, 600V, 0.15A, 3V	E-6			
TK1808	THE	180A, 800V, 0.15A, 3V	F-59			
TK1810	THE	180A, 1kV, 0.15A, 1.5V	F-91			
TK1812	THE	180A, 1.2kV, 0.15A, 3V	E-6			
TK2601	THE	260A, 100V, 0.2A, 3V	E-6			
TK2602	THE	260A, 200V, 0.2A, 3V	F-91			
TK2606	THE	260A, 600V, 0.2A, 3V	F-91			
TK2608	THE	260A, 800V, 0.2A, 3V	F-91			
TK2610	THE	260A, 1kV, 0.2A, 3V	F-91			
TK2612	THE	260A, 1.2kV, 0.2A	F-91			
TK2614	THE	260A, 1.4kV, 0.2A, 3V	F-91			
TK2616	THE	260A, 1.6kV, 0.2A, 3V	F-91			
TK3001	THE	300A, 100V, 0.2A, 3V	F-91			 图 F-91
TK3002	THE	600A, 200V, 0.2A, 3V	F-91			
TK3004	THE	600A, 400V, 0.2A, 3V	F-91			
TK3006	THE	600A, 600V, 0.2A, 3V	F-91			
TK3008	THE	600A, 800V, 0.2A, 3V	F-91			



器件型号 Element type	厂名 Manufacturers	材料用途参数 Material Purpose Parameter	图号 Figure	国内外相似替换器件型号 Replace of similar type	备注 Notes	外形参考图 Reference shape
TK3010	THE	600A, 1kV, 0.2A, 3V	F-91			
TK3012	THE	600A, 1.2kV, 0.2A, 3V	F-91			
TK3014	THE	600A, 1.4kV, 0.2A, 3V	F-91			
TK3016	THE	600A, 1.6kV, 0.2A, 3V	F-91			
TK3601	THE	360A, 100V, 0.2A, 3V	F-91			
TK3602	THE	360A, 200V, 0.2A, 3V	F-91			
TK3604	THE	360A, 400V, 0.2A, 3V	F-91			
TK3606	THE	360A, 600V, 0.2A, 3V	F-91			
TK3608	THE	360A, 800V, 0.2A, 3V	F-91			
TK3610	THE	360A, 1kV, 0.2A, 3V	F-91			
TK3612	THE	360A, 1.2kV, 0.2A, 3V	F-91			
TKAL110	THE	100A, 100V, 0.2A, 3V	E-6			
TKAL120	THE	100A, 200V, 0.2A, 3V	E-6			
TKAL140	THE	100A, 400V, 0.2A, 3V	E-6			
TKAL180	THE	100A, 600V, 0.2A, 3V	E-6			
TKAL210	THE	220A, 100V, 0.3A, 3V	F-91			
TKAL220	THE	220A, 200V, 0.3A, 3V	F-91			
TKAL240	THE	220A, 400V, 0.3A, 3V	F-91			
TKAL260	THE	220A, 600V, 0.3A, 3V	F-91			
TKAL280	THE	220A, 800V, 0.3A, 3V	F-91			
TKAL1100	THE	100A, 1kV, 0.2A, 3V	F-91			
TKAL2110	THE	220A, 1kV, 0.3A, 3V	F-91			
TKAL2120	THE	220A, 1.2kV, 0.3A, 3V	F-91			
TKE806	THE	80A, 600V, 0.125A, 3V	E-6	ECG5572		
TKE808	THE	80A, 800V, 0.125A, 3V	E-6	ECG5574		
TKE810	THE	80A, 1kV, 0.125A, 3V	E-6	ECG5574		





图 F-91

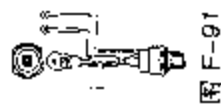

图 E-6

器件型号 Element type	厂名 Manufacturers	材料用途参数 Material Purpose Parameter	图号 Figure	国内外相似替换器件型号 Replace of similar type	备注 Notes	外形参考图 Reference shape
TKE1201	THE	120A, 100V, 0.125A, 3V	E-6	ECG5570		
TKE1202	THE	120A, 200V, 0.125A, 3V	E-6	ECG5570		
TKE1204	THE	120A, 400V, 0.125A, 3V	E-6	ECG5572		
TKE1206	THE	120A, 600V, 0.125A, 3V	E-6	ECG5572		
TKE1208	THE	120A, 800V, 0.125A, 3V	E-6	ECG5574		
TL106-05	THE	1.6A, 50V, 200 μ A, 1V	B-32	MCR106-2		
TL106-1	THE	1.6A, 100V, 200 μ A, 1V	B-32	MCR106-3		
TL106-2	THE	1.6A, 200V, 200 μ A, 1V	B-32	MCR106-4		
TL106-4	THE	1.6A, 400V, 200 μ A, 1V	B-32	MCR106-6		
TL106-6	THE	1.6A, 600V, 200 μ A, 1V	B-32	MCR106-8		
TL107-05	THE	1.6A, 50V, 500 μ A, 1V	B-32	MCR106-2		
TL107-1	THE	1.6A, 100V, 200 μ A, 1V	B-32	MCR106-3		
TL107-2	THE	1.6A, 200V, 500 μ A, 1V	B-32	MCR106-4		
TL107-4	THE	1.6A, 400V, 500 μ A, 1V	B-32	MCR106-6		
TL107-6	THE	1.6A, 600V, 500 μ A, 1V	B-32	MCR106-8		
TL1003	THE	1.6A, 100V, 0.015A, 3V	B-9	MCR218-3		
TL1006	THE	3A, 100V, 0.015A, 3V	B-9	MCR218-3		
TL2003	THE	1.6A, 200V, 0.015A, 3V	B-9			
TL2006	THE	3A, 200V, 0.015A, 3V	B-9			
TL4003	THE	1.6A, 400V, 0.015A, 3V	B-9	MCR218-6		
TL4006	THE	3A, 400V, 0.015A, 3V	B-9	MCR218-6		
TL6003	THE	1.6A, 600V, 0.015A, 3V	B-9	MCR218-8		
TL6006	THE	3A, 600V, 0.015A, 3V	B-9	MCR218-8		
TL8003	THE	1.6A, 800V, 0.015A, 3V	B-9	MCR218-10		
TL8006	THE	3A, 800V, 0.015A, 3V	B-9	MCR218-10		
TL111A	SCR-D	1A, 200V, 0.01A, 3V	B-78	T2322A		

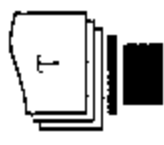

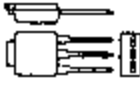
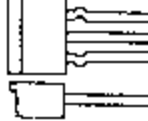
器件型号 Element type	厂名 Manufacturers	材料用途参数 Material Purpose Parameter	图号 Figure	国内外相似替换器件型号 Replace of similar type	备注 Notes	外形参考图 Reference shape
TLC111B	SCR-D	2.5A, 200V	B-78	T2322B		 图 B-78
TLC111D		1A, 200V, 0.01A, 1.5V	B-78			
TLC113A	THE	SCR-D 1.6A, 200V, 0.01A, 3V	B-32	T2322A		 图 B-78
TLC113B	THE	SCR-D 1.6A, 200V, 0.025A, 3V	B-32	T2322B		
TLC113D	THE	SCR-D 1.6A, 200V, 0.005A, 3V	B-32			
TLC116A	THE	3A, 200V, 0.01A, 3V	B-32			
TLC116B	THE	3A, 200V, 0.025A, 3V	B-32			
TLC116D, S		3A, 200V, 0.01A, 1.5V	B-78			
TLC116T		3A, 200V, 0.005A, 1.5V	B-78			
TLC221A		1A, 400V, 0.01A, 3V	B-78			
TLC221B	THE	1A, 400V, 0.025A, 3V	B-32			
TLC221D		1A, 400V, 0.01A, 1.5V	B-78			
TLC221S	THE	1A, 400V, 0.025A, 3V	B-32			
TLC221T	THE	1A, 400V, 0.005A, 3V	B-32			
TLC223A	THE	1.6A, 400V, 0.01A, 3V	B-32			
TLC223B	THE	1.6A, 400V, 0.025A, 3V	B-32			
TLC223D	THE	1.6A, 400V, 0.005A, 3V	B-32			
TLC226A	THE	3A, 400V, 0.01A, 3V	B-32			
TLC226B	THE	3A, 400V, 0.025A, 3V	B-32			
TLC226D, S		3A, 400V, 0.01A, 1.5V	B-78			
TLC226T		3A, 400V, 0.005A, 1.5V	B-78			
TLC331A		1A, 400V, 0.025A, 1.5V	B-78			
TLC331B	THE	1A, 600V, 0.025A, 3V	B-32			

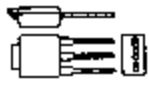
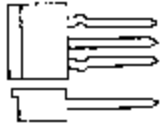
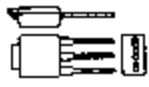
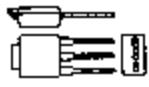
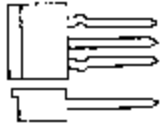
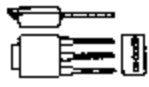
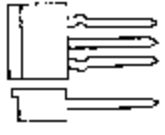
器件型号 Element type	厂名 Manufacturers	材料用途参数 Material/Purpose Parameter	图号 Figure	国内外相似替换器件型号 Replace of similar type	备注 Notes	外形参考图 Reference shape
ILC331D		1A, 600V, 0.01A, 1.5V	B-78			
TLC331S, T	THE	1A, 600V, 0.01A, 3V	B-32			
TLC333A	THE	1.6A, 600V, 0.01A, 3V	B-32			
TLC333B, D	THE	1.6A, 600V, 0.025A, 3V	B-32			
TLC336A	THE	3A, 600V, 0.01A, 3V	B-32			
TLC336B	THE	3A, 600V, 0.025A, 3V	B-32			
TLC336D, S		3A, 600V, 0.01A, 1.5V	B-78			
TLC336T		3A, 600V, 0.005A, 1.5V	B-78			
TLC381A		1A, 700V, 0.01A, 3V	B-78			
TLC381B		1A, 700V, 0.025A, 3V	B-32			
TLC381D, S	THE	1A, 700V, 0.01A, 1.5V	B-78			
TLC381T	THE	1A, 700V, 0.005A, 3V	B-32			
TLC383A	THE	1.6A, 700V, 0.01A, 3V	B-32			
TLC383B	THE	1.6A, 700V, 0.025A, 3V	B-32			
TLC383D	THE	1.6A, 700V, 0.005A, 3V	B-32			
TLC386A	THE	3A, 700V, 0.01A, 3V	B-32			
TLC386B	THE	3A, 700V, 0.025A, 3V	B-32			
TLC386D, S		3A, 700V, 0.01A, 1.5V	B-78			
TLC386T		3A, 700V, 0.005A, 1.5V	B-78			
TLF1006	THE	3A, 100V, 0.05A, 3V				
TLF2006	THE	3A, 200V, 0.05A, 2V				
TLF3006	THE	3A, 300V, 0.05A, 2V	B-32			
TLF4006	THE	3A, 400V, 0.05A, 2V	B-32			

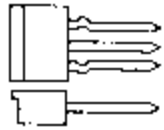
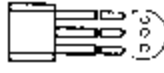
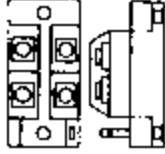
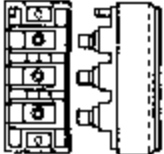

器件型号 Element type	厂名 Manufacturers	材料用途参数 Material Purpose Parameter	图号 Figure	国内外相似替换器件型号 Replace of similar type	备注 Notes	外形参考图 Reference shape
TL5106-05	THE	4A, 50V, 200 μ A, 1V	B-32	MCR106-2		 图 B-32
TL5106-1	THE	4A, 100V, 200 μ A, 1V	B-32	MCR106-3		
TL5106-2	THE	4A, 200V, 200 μ A, 1V	B-32	MCR106-4		
TL5106-4	THE	4A, 400V, 200 μ A, 1V	B-32	MCR106-6		
TL5106-6	THE	4A, 600V, 200 μ A, 1V	B-32	MCR106-8		
TL5107-05	THE	4A, 50V, 500 μ A, 1V	B-32	MCR106-2		
ILS107-1	THE	4A, 100V, 500 μ A, 1V	B-32	MCR106-3		 图 B-36
TL5107-2	THE	4A, 200V, 500 μ A, 1V	B-32	MCR106-4		
TL5107-4	THE	4A, 400V, 500 μ A, 1V	B-32	MCR106-6		
TL5107-6	THE	4A, 600V, 500 μ A, 1V	B-32	MCR106-8		
TMD		1A, 600V, 0.005A, 2V	B-36			
TMG		1A, 600V, 0.01A, 2V	B-36			
TMH		1A, 600V, 0.025A, 2V	B-36			 图 H-2
TMS		1A, 600V, 0.003A, 2V	B-36			
TM20RAH	MIT	SCA 20A, 800V, 0.05A, 3V	H-2			
TM20RAM	MIT	SCA 20A, 400V, 0.05A, 3V	H-2			
TM25CZH, DZH, EZH	MIT	SCA 25A, 800V, 0.05A, 3V	H-13			 图 H-13
TM25RZH	MIT	SCA 25A, 800V, 0.05A, 3V	H-13			
TM25CZM, DZM, EZM, RZM	MIT	SCA 25A, 400V, 0.05A, 3V				
TM55CZ2H, DZ2H, CZ2H, RZ2H	MIT	SCA 55A, 1.6kV, 0.1A, 2V	H-13			
TM55CZ24, DZ24, EZ24, RZ24	MIT	SCA 55A, 1.2kV, 0.1A, 2V	H-13			

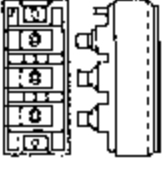
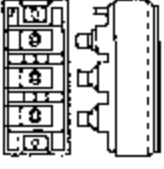
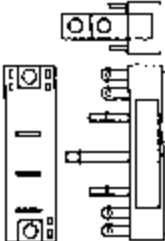
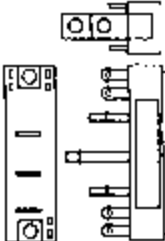
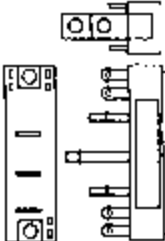
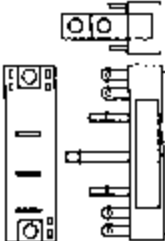
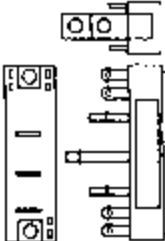
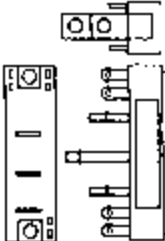
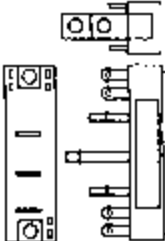
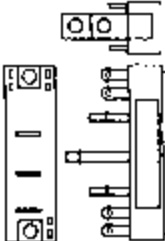
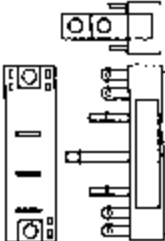
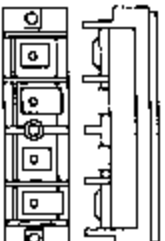
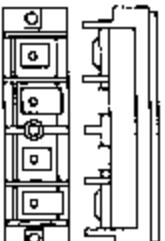
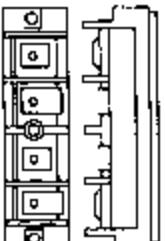
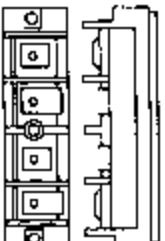

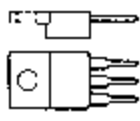
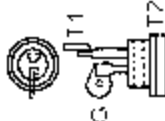

器件型号 Element type	厂名 Manufacturers	材料用途参数 Material Purpose Parameter	图号 Figure	国内外相似替换器件型号 Replace of similar type	备注 Notes	外形参考图 Reference shape
TM55CZH, DZH, EZH, RZH	MIT	SCA 55A, 800V, 0.1A, 3V	H-13			
TM55CZM, DZM, EZM, RZM, SZM	MIT	SCA 55A, 400V, 0.1A, 3V	H-13			
TM60SA6	MIT	SCA 60A, 300V, 0.1A, 3V	H-23			
TM90CZ2H, DZ2H, EZ2H	MIT	SCA 90A, 1.6kV, 0.1A, 2V	H-13			
TM90CZ24, DZ24, EZ24	MIT	SCA 90A, 1.2kV, 0.1A, 2V	H-13			
TM90CZH, DZH, EZH, RZH	MIT	SCA 90A, 800V, 0.1A, 3V	H-13			
TM90CZM, DZM, EZM, RZM	MIT	SCA 90A, 400V, 0.1A, 3V	H-13			
TM90RZ2H	MIT	SCA 55A, 1.6kV, 0.1A, 2V	H-13			
TM90R24	MIT	SCA 55A, 1.2kV, 0.1A, 2V	H-13			
TM90SA6	MIT	SCA 60A, 300V, 0.1A, 3V	H-23			
TM90SZM	MIT	SCA 100A, 400V, 0.1A, 3V	H-13			
TM130CZ2H, DZ2H, EZ2H, RZ2H	MIT	SCA 95A, 1.6kV, 0.1A, 3V	H-24			
TM130CZ24, DZ24, EZ24, RZ24	MIT	SCA 130A, 1.2kV, 0.1A, 3V	H-24			
TM130CZH, DZH, EZH, RZH	MIT	SCA 130A, 800V, 0.1A, 3V	H-24			
TM130CZM, DZM, EZM, RZM	MIT	SCA 130A, 400V, 0.1A, 3V	H-24			

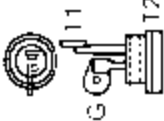
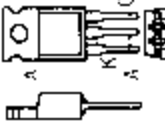
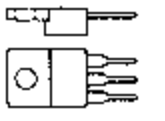

器件型号 Element type	厂名 Manufacturers	材料用途参数 Material Purpose Parameter	图号 Figure	国内外相似替换器件型号 Replace of similar type	备注 Notes	外形参考图 Reference shape
TM200DZ24		200A, 1.2kV, 0.1A, 3V				
TM200DZH		200A, 1.5kV, 0.1A, 3V				
TM200DZ-H		200A, 800V, 0.1A, 3V				
TM320M	SAK	3A, 200V, 0.05A, 3V	B-11	TAG232-200, TIC216B, T2506B		 B-11
TM340M	SAK	3A, 400V, 0.05A, 3V	B-11	TAG232-400, TIC216D, T2506D		
TM340M-A		50Hz-Thy	B-11	S5801D, S5802D, TIC108D		
TM341M-L		3A, 400V, 0.03A, 2V	C-86	TAG232-400, TIC206D, TXC18H40		
TM341S		3A, 400V, 0.03A, 2V				
TM341S-L		3A, 400V, 0.03A, 2V	C-86	TAG421-400		
TM361M-L		3A, 600V, 0.03A, 2V	C-86	TAG232-600, TIC206M, TXC18H60		
TM361S		3A, 600V, 0.03A, 2V				
TM361S-L		3A, 600V, 0.02A, 2V	C-86	TAG421-600		
TM507		8A, 50V		2N4168		
TM520M	SAK	5A, 200V, 0.05A, 1.8V				 C-86 B-11 C-86
TM540M	SAK	5A, 400V, 0.05A, 1.8V				
TM541M-L		5A, 400V, 0.03A, 2V	C-86	TAG232-400, TIC216D, T2506D		
TM541S		5A, 400V, 0.03A, 2V				
TM541S-L		5A, 400V, 0.03A, 2V	B-11	TAG421-400		
TM561S		5A, 600V, 0.03A, 2V				
TM561M-L		5A, 600V, 0.03A, 2V	C-86	T2506M, TAG232-600, TIC216M		
TM561S		5A, 600V, 0.03A, 2V				
TM561S-L		5A, 600V, 0.03A, 2V	C-86	TAG421-600		
TM620M	SAK	6A, 200V, 0.05A, 3V	B-11	SC146B, TAG250B, TAG251B, TAG252B, TW9N400		
TM640M	SAK	6A, 400V, 0.05A, 3V	B-11	SC146D, TAG250D, TAG251D, TAG252D, TW9N400		

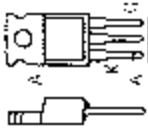
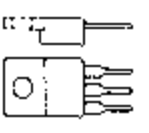
器件型号 Element type	厂名 Manufacturers	材料用途参数 Material Purpose Parameter	图号 Figure	国内外相似替换器件型号 Replace of similar type	备注 Notes	外形参考图 Reference shape
TM820M	SAK	SCA-D 8A, 200V, 0.05A, 1.8V				 图 C-86
TM840M	SAK	SCA-D 8A, 400V, 0.05A, 1.5V				
TM841M-L		Triac 8A, 400V, 0.03A, 2V	C-86	BT158-400, TAG225-400, T2806D		
TM841S		Triac 8A, 400V, 0.03A, 2V				
TM841S-L		8A, 400V, 0.03A, 2V	C-86	TAG426-400, TAG452-400		
TM861M-L		Triac 8A, 600V, 0.03A, 2V	B-91	BT158-600, TAG225-600, T2805M		
TM861S		Triac 8A, 600V, 0.03A, 0.015A	B-11			
TM861S-L		8A, 600V, 0.03A, 2V	B-91	TAG426-600, TAG452-600		
TM1007	THE	7.4A, 100V, 0.04A, 3V		ECG5482, 2N4169		 图 B-91
TM1020	SAK	10A, 200V, 0.05A, 3V	B-11	T4700B, T4706B, 2N4169		
TM1020M	SAK	SCR-D 10A, 200V, 0.05A	B-11	SC151B, TAG280-400, TAG281-400, TIC246B		
TM1040	SAK	10A, 400V, 0.05A, 3V	B-11	T4700D, T4706D		
TM1040M	SAK	SCR-D 10A, 200V, 0.05A	B-11	SC151D, TAG280-400, TAG281-400, TIC246D		
TM1041S-R		Triac 10A, 400V				 图 B-11
TM1041M-L		10A, 400V, 0.03A, 2V	B-91	TAG252-400, TAG257-400		
TM1041S-L		Triac 10A, 400V, 0.03A, 2V	B-91	TAG457-400		
TM1061M-L		10A, 600V, 0.03A, 2V	B-91	TAG252-600, TAG257-600		
TM1061S-R		Triac 10A, 600V				
TM1061S-L	SAK	Triac 10A, 600V, 0.03A, 2V	B-91	TAG457-600		
TM1241M L		12A, 400V, 0.03A, 2V	B-91	TAG257-400		
TM1241S-L		12A, 400V, 0.03A, 2V	B-91			

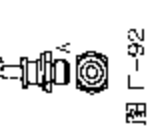
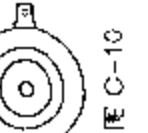

器件型号 Element type	厂名 Manufacturers	材料用途参数 Material Purpose Parameter	图号 Figure	国内外相似替换器件型号 Replace of similar type	备注 Notes	外形参考图 Reference shape
TM1261S	Triac	12A, 600V	B-91	TAG257-600		
TM1261M-L		12A, 600V, 0.03A, 2V	B-91			
TM1261S-L	Triac	12A, 600V, 0.03A, 2V	B-91			
TM1641S	Triac	16A, 400V				
TM1641M-L		16A, 400V, 0.03A, 2V	B-91	TAG6006-400		
TM1641S-L		16A, 400V, 0.03A, 2V	B-91			
TM1661M-L		16A, 600V, 0.03A, 2V	B-91	TAG6006-600		
TM1661S-L	Triac	10A, 600V, 0.03A, 2V	B-11			
TM3007		8A, 300V		2N4171		
TM4007		8A, 400V		2N4172		
TM5007		8A, 500V		2N4173		
TM6007		8A, 600V		2N4174		
TN41A	TOS	PUT 2A, 40V, 10μA, 1kV	B-36	ECG6402		
TN41B	TOS	PUT 2A, 40V, 10μA, 1kV	B-36			
TN90-16	BBC	104A, 1.6kV, 0.15A, 3V	F-92			
TN130-02	BBC	152A, 200V, 0.15A, 3V	F-92			
TN130-12	BBC	152A, 1.2kV, 0.15A, 3V	F-92			
TN232-01		280A, 100V, 0.125A, 3V	C-10			
TN232-02		280A, 200V, 0.125A, 3V	C-10			
TN232-04		280A, 400V, 0.125A, 3V	C-10			
TN232-06		280A, 600V, 0.125A, 3V	C-10			
TN232-08		280A, 800V, 0.125A, 3V	C-10			
TN232-10		280A, 1kV, 0.125A, 3V	C-10			

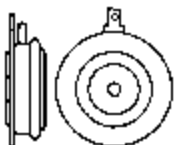
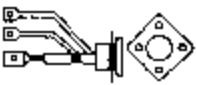
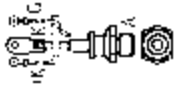
器件型号 Element type	厂名 Manufacturers	材料用途参数 Material Purpose Parameter	图号 Figure	国内外相似替换器件型号 Replace of similar type	备注 Notes	外形参考图 Reference shape
TN232-12		280A, 1.2kV, 0.125A, 3V	C-10			 图 C-10
TN232-14		280A, 1.4kV, 0.125A, 3V	C-10			
TN232-16		280A, 1.6kV, 0.125A, 3V	C-10			
TN295-06	BBC	353A, 800V, 0.2A, 3V	D 38			
TN330-06g06, h01, h04, i04	BBC	409A, 600V, 0.2A, 3V	F 92			
TN330-06g07	BBC	409A, 600V, 0.2A, 3V	D-38			
TN330-10i01	BBC	409A, 1kV, 0.2A, 3V	F-92			
TN330-12i01	BBC	409A, 1.2kV, 0.2A, 3V				
TN431 01		430A, 100V, 0.2A, 3V	C-10			 图 D-38
TN431-02		430A, 200V, 0.2A, 3V	C-10			
TN431-04		430A, 400V, 0.2A, 3V	C-10			
TN431-06		430A, 600V, 0.2A, 3V	C-10			
TN431-08		430A, 800V, 0.2A, 3V	C-10			
TN431 10		430A, 1kV, 0.2A, 3V	C-10			
TN431-12		430A, 1.2kV, 0.2A, 3V	C-10			
TN431-14		430A, 1.4kV, 0.2A, 3V	C-10			
TN431-16		430A, 1.6kV, 0.2A, 3V	C-10			
TN431-18		430A, 1.8kV, 0.2A, 3V	C-10			
TN431-20		430A, 2kV, 0.2A, 3V	C-10			
TN432-01		525A, 100V, 0.2A, 3V	C-10			 图 F-92
TN432-02		525A, 200V, 0.2A, 3V	C-10			
TN432-04		525A, 400V, 0.2A, 3V	C-10			
TN432-06		525A, 600V, 0.2A, 3V	C-10			
TN432-08		525A, 800V, 0.2A, 3V	C-10			
TN432-10		525A, 1kV, 0.2A, 3V	C-10			

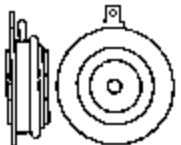
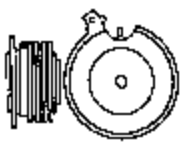

器件型号 Element type	厂名 Manufacturers	材料用途参数 Material Purpose Parameter	图号 Figure	国内外相似替换器件型号 Replace of similar type	备注 Notes	外形参考图 Reference shape	
TN432-12		525A, 1.2kV, 0.2A, 3V	C-10			 图 C-10	
TN432-14		525A, 1.4kV, 0.2A, 3V	C-10				
TN432-16		525A, 1.6kV, 0.2A, 3V	C-10				
TN433-01		600A, 100V, 0.2A, 3V	C-10				
TN433-02		600A, 200V, 0.2A, 3V	C-10				
TN433-04		600A, 400V, 0.2A, 3V	C-10				
TN433-06		600A, 600V, 0.2A, 3V	C-10				
TN433-08		600A, 800V, 0.2A, 3V	C-10				
TN433-10		600A, 1kV, 0.2A, 3V	C-10				
TN433-12		600A, 1.2kV, 0.2A, 3V	C-10				
TN470-10ioc	BBC	556A, 1kV, 0.2A, 3V	C-11				 图 C-11
TN631-01		600A, 100V, 0.2A, 3V					
TN631-02		600A, 200V, 0.2A, 3V					
TN631-04		600A, 400V, 0.2A, 3V					
TN631-06		600A, 600V, 0.2A, 3V					
TN631-08		600A, 800V, 0.2A, 3V					
TN631-10		600A, 1kV, 0.2A, 3V					
TN631-12		600A, 1.2kV, 0.2A, 3V					
TN631-14		600A, 1.4kV, 0.2A, 3V					
TN631-16		600A, 1.6kV, 0.2A, 3V					
TN631-18		600A, 1.8kV, 0.2A, 3V					
TN631-20		600A, 2kV, 0.2A, 3V					
TN631-22		600A, 2.2kV, 0.2A, 3V					
TN631-24		600A, 2.4kV, 0.2A, 3V					
TN632-01		700A, 100V, 0.2A, 3V					
TN632-02		700A, 200V, 0.2A, 3V					
TN632-04		700A, 400V, 0.2A, 3V					



器件型号 Element type	厂名 Manufacturers	材料用途参数 Material Purpose Parameter	图号 Figure	国内外相似替换器件型号 Replace of similar type	备注 Notes	外形参考图 Reference shape
TN632-06		700A, 600V, 0.2A, 3V				
TN632-08		700A, 800V, 0.2A, 3V				
TN632-10		700A, 1kV, 0.2A, 3V				
TN632-12		700A, 1.2kV, 0.2A, 3V				
TN632-14		700A, 1.4kV, 0.2A, 3V				
TN632-16		700A, 1.6kV, 0.2A, 3V				
TN632-18		700A, 1.8kV, 0.2A, 3V				
TN632-20		700A, 2kV, 0.2A, 3V				
TN633-01		850A, 100V, 0.2A, 3V				
TN633-02		850A, 200V, 0.2A, 3V				
TN633-03		850A, 400V, 0.2A, 3V				
TN633-06		850A, 600V, 0.2A, 3V				
TN633-08		850A, 800V, 0.2A, 3V				
TN633-10		850A, 1kV, 0.2A, 3V				
TN633-12		850A, 1.2kV, 0.2A, 3V				
TN633-14		850A, 1.4kV, 0.2A, 3V				
TN731-12		900A, 1.2kV, 0.2A, 3V				
TN731-14		900A, 1.4kV, 0.2A, 3V				
TN731-16		900A, 1.6kV, 0.2A, 3V				
TN731-18		900A, 1.8kV, 0.2A, 3V				
TN731-20		900A, 2kV, 0.2A, 3V				
TN731-22		900A, 2.2kV, 0.2A, 3V				
TN733-01		1.1kA, 100V, 0.2A, 3V				
TN733-02		1.1kA, 200V, 0.2A, 3V				
TN733-04		1.1kA, 400V, 0.2A, 3V				
TN733-06		1.1kA, 600V, 0.2A, 3V				
TN733-08		1.1kA, 800V, 0.2A, 3V				

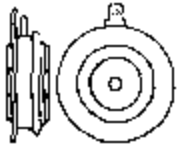
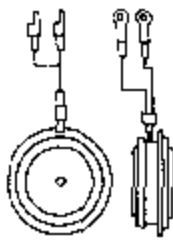

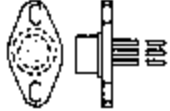
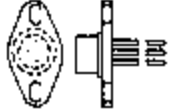
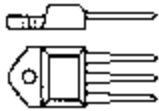
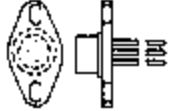
器件型号 Element type	厂名 Manufacturers	材料用途参数 Material Purpose Parameter	图号 Figure	国内外相似替换器件型号 Replace of similar type	备注 Notes	外形参考图 Reference shape	
TN733-10		1.1kA, 1kV, 0.2A, 3V					
TN733-12		1.1kA, 1.2kV, 0.2A, 3V					
TN733-14		1.1kA, 1.4kV, 0.2A, 3V					
TN931-01		1.4kA, 100V, 0.2A, 3V	C-10			 <p>图 C-10</p>	
TN931-02		1.4kA, 200V, 0.2A, 3V	C-10				
TN931-04		1.4kA, 400V, 0.2A, 3V	C-10				
TN931-06		1.4kA, 600V, 0.2A, 3V	C-10				
TN931-08		1.4kA, 800V, 0.2A, 3V	C-10				
TN931-10		1.4kA, 1kV, 0.2A, 3V	C-10				
TN931-12		1.4kA, 1.2kV, 0.2A, 3V	C-10				
TN931-14		1.4kA, 1.4kV, 0.2A, 3V	C-10				
TN931-16		1.4kA, 1.6kV, 0.2A, 3V	C-10				
TN931-18		1.4kA, 1.8kV, 0.2A, 3V	C-10				
TN931-20		1.4kA, 2kV, 0.2A, 3V	C-10				
TN933-01		1.9kA, 100V, 0.2A, 3V	C-10				 <p>图 C-47</p>
TN933-02		1.9kA, 200V, 0.2A, 3V	C-10				
TN933-04		1.9kA, 400V, 0.2A, 3V	C-10				
TN933-06		1.9kA, 600V, 0.2A, 3V	C-10				
TN933-08		1.9kA, 800V, 0.2A, 3V	C-10				
TN933-10		1.9kA, 1kV, 0.2A, 3V	C-10				
TN933-12		1.9kA, 1.2kV, 0.2A, 3V	C-10				
TN933-14		1.9kA, 1.4kV, 0.2A, 3V	C-10				
TNS11012D25	THE	1.1kA, 1.2kV, 0.2A, 3V	C-47				
TOC108S(A)	THE	0.8A, 100V, 0.01A, 2V	B-36				
TOC108T(A)	THE	0.8A, 100V, 0.005A, 2V	B-36				

器件型号 Element type	厂名 Manufacturers	材料 Material	用途 Purpose	参数 Parameter	图号 Figure	国内外相似替换器件型号 Replace of similar type	备注 Notes	外形参考图 Reference shape
TOC108V(A)	THE			0.8A, 100V, 0.003A, 2V	B-36			
TOC208T(A)	THE			0.8A, 200V, 0.005A, 2V	B-36			
TOC208V(A)	THE			0.8A, 200V, 0.003A, 2V	B-36			
TOC408S(A)	THE			0.8A, 400V, 0.01A, 2V	B-36			
TOC408T(A)	THE			0.8A, 400V, 0.005A, 2V	B-36			
TOC608S(A)	THE			0.8A, 600V, 0.01A, 2V	B-36			
TOC608T(A)	THE			0.8A, 600V, 0.005A, 2V	B-36			
TOC608V(A)	THE			0.8A, 600V, 0.003A, 2V	B-36			
TODV125	THE			25A, 100V, 0.15A, 2.5V	D-33			
TODV140	THE			40A, 100V, 0.2A, 2.5V	D-33			
TODV225	THE			25A, 200V, 0.15A, 2.5V	D-33			
TODV240	THE			40A, 200V, 0.2A, 2.5V	D-33			
TODV425	THE			25A, 400V, 0.15A, 2.5V	D-33			
TODV440	THE			40A, 400V, 0.2A, 2.5V	D-33			
TODV625	THE			25A, 600V, 0.15A, 2.5V	D-33			
TODV825	THE			25A, 800V, 0.15A, 2.5V	D-33			
TODV1025	THE			25A, 1KV, 0.15A, 2.5V	D-33			
TODV1225	THE			25A, 1.2KV, 0.15A, 2.5V	D-33			
TPDV125	THE			25A, 100V, 0.15A, 2.5V	B-29			
TPDV140	THE			40A, 100V, 0.2A, 2.5V	B-29			
TPDV225	THE			25A, 200V, 0.15A, 2.5V	B-29			
TPDV240	THE			40A, 200V, 0.2A, 2.5V	B-29			
TPDV425	THE			25A, 400V, 0.15A, 2.5V	B-29			
TPDV440	THE			40A, 400V, 0.2A, 2.5V	B-29			

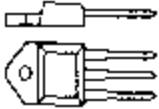

器件型号 Element type	厂名 Manufacturers	材料 Material	用途 Purpose	参数 Parameter	图号 Figure	国内外相似替换器件型号 Replace of similar type	备注 Notes	外形参考图 Reference shape	
TPDV625	THE			25A, 600V, 0.15A, 2.5V	B-29			 图 B-29	
TPDV640	THE			40A, 600V, 0.2A, 2.5V	B-29				
TPDV825	THE			25A, 800V, 0.15A, 2.5V	B-29				
TPDV840	THE			40A, 800V, 0.2A, 2.5V	B-29				
TPDV1025	THE			25A, 1kV, 0.15A, 2.5V	B-29				
TPDV1040	THE			40A, 1kV, 0.2A, 2.5V	R-29				
TPDV1225	THE			25A, 1.2kV, 0.15A, 2.5V	B-29				
TPDV1240	THE			40A, 1.2kV, 0.2A, 2.5V	B-29				
TQ1104LT35	THE			4A, 200V	B-91				 图 B-91
TQ1104L140	THE			4A, 200V	B-91				
TQ1106LT35	THE			6A, 200V	B-91				
TQ1106L140	THE			6A, 200V	B-91				
TQ1108LT35	THE			8A, 200V	B-91				
TQ1108L140	THE			8A, 200V	B-91				
TQ1110LT35	THE			10A, 200V	B-91				
TQ1110L140	THE			10A, 200V	R-91				
TQ1112LT35	THE			12A, 200V	B-91				
TQ1112L140	THE			12A, 200V	B-91				
TQ2204LT35, 40	THE			4A, 400V	B-91				
TQ2206LT35, 40	THE			6A, 400V	B-91				
TQ2208LT35, 40	THE			8A, 400V	B-91				
TQ2210LT35, 40	THE			10A, 400V	B-91				
TQ2212LT35, 40	THE			12A, 400V	B-91				
TQ3804LT35, 40	THE			4A, 700V	B-91				
TQ3806LT35, 40	THE			6A, 700V	B-91				
TQ3808LT35, 40	THE			8A, 700V	B-91				

器件型号 Element type	厂名 Manufacturers	材料用途参数 Material Purpose Parameter	图号 Figure	国内外相似替换器件型号 Replace of similar type	备注 Notes	外形参考图 Reference shape
TQ3812LT35, 40	THE	12A, 700V	B-91			 图 B-91
TR93-400T		80A, 200-800V	B-9			
TR92A1	TAG	0.45A, 30V, 0.005A, 2V	B-36			
TR92A2	TAG	0.45A, 60V, 0.005A, 2V	B-36			
TR92A3	TAG	0.45A, 100V, 0.005A, 2V	B-36			
TR92A4	TAG	0.45A, 200V, 0.005A, 2V	B-36			
TR92A5	TAG	0.45A, 300V, 0.005A, 2V	B-36			
TR92A6	TAG	0.45A, 400V, 0.005A, 2V	B-36			
TR92B1	TAG	0.45A, 30V, 0.01A, 2V	B-36			
TR92B2	TAG	0.45A, 60V, 0.01A, 2V	B-36			
TR92B3	TAG	0.45A, 100V, 0.01A, 2V	B-36			
TR92B4	TAG	0.45A, 200V, 0.01A, 2V	B-36			
TR92B5	TAG	0.45A, 300V, 0.01A, 2V	B-36			
TR92B6	TAG	0.45A, 400V, 0.01A, 2V	B-36			
TR93A1	TAG	0.65A, 30V, 0.005A, 2V	B-36			
TR93A2	TAG	0.65A, 60V, 0.005A, 2V	B-36			
TR93A3	TAG	0.65A, 100V, 0.005A, 2V	B-36			
TR93A4	TAG	0.65A, 200V, 0.005A, 2V	B-36			
TR93A5	TAG	0.65A, 300V, 0.005A, 2V	B-36			
TR93A6	TAG	0.65A, 400V, 0.005A, 2V	B-36			
TR93B1	TAG	0.65A, 30V, 0.01A, 2V	B-36			
TR93B2	TAG	0.65A, 60V, 0.01A, 2V	B-36			
TR93B3	TAG	0.65A, 100V, 0.01A, 2V	B-36			
TR93B4	TAG	0.65A, 200V, 0.01A, 2V	B-36			
TR93B5	TAG	0.65A, 300V, 0.01A, 2V	B-36			
TR93B6	TAG	0.65A, 400V, 0.01A, 2V	B-36			
TR94A1	TAG	0.8A, 30V, 0.005A, 2V	B-36			

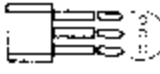

器件型号 Element type	厂名 Manufacturers	材料 Material	用途 Purpose	参数 Parameter	图号 Figure	国内外相似替换器件型号 Replace of similar type	备注 Notes	外形参考图 Reference shape
TR94A2	TAG			0.8A, 60V, 0.005A, 2V	B-36			
TR94A3	TAG			0.8A, 100V, 0.005A, 2V	B-36			
TR94A4	TAG			0.8A, 200V, 0.005A, 2V	B-36			
TR94A5	TAG			0.8A, 300V, 0.005A, 2V	B-36			
TR94A6	TAG			0.8A, 400V, 0.005A, 2V	B-36			
TR94B1	TAG			0.8A, 30V, 0.01A, 2V	B-36			
TR94B2	TAG			0.8A, 60V, 0.01A, 2V	B-36			
TR94B3	TAG			0.8A, 100V, 0.01A, 2V	B-36			
TR94B4	TAG			0.8A, 200V, 0.01A, 2V	B-36			
TR94B5	TAG			0.8A, 300V, 0.01A, 2V	B-36			
TR94B6	TAG			0.8A, 400V, 0.01A, 2V	B-36			
TR0116A	TAG			1.6A, 100V, 0.025A, 2.5V	B-51			
TR0116D	TAG			1.6A, 400V, 0.025A, 2.5V	D-9			
TR0116M	TAG			1.6A, 600V, 0.025A, 2.5V	B-51			
TR0135A	TAG			4A, 100V, 0.025A, 2.5V	B-91			
TR0135B	TAG			4A, 200V, 0.025A, 2.5V	B-91			
TR0135D	TAG			4A, 400V, 0.025A, 2.5V	B-91			
TR0135M	TAG			4A, 600V, 0.025A, 2.5V	B-91			
TR0135N	TAG			4A, 800V, 0.025A, 2.5V	B-91			
TR0140A	TAG			6A, 100V, 0.05A, 2.5V	B-91			
TR0140B	TAG			6A, 200V, 0.05A, 2.5V	B-91			
TR0140D	TAG			6A, 400V, 0.05A, 2.5V	B-91			
TR0140M	TAG			6A, 600V, 0.05A, 2.5V	B-91			
TR0140N	TAG			6A, 800V, 0.05A, 2.5V	B-91			
TR0141A	TAG			6A, 100V, 0.05A, 2.5V	B-91			
TR0141B	TAG			6A, 200V, 0.05A, 2.5V	B-91			



图 B-36



图 B-51

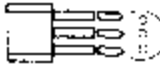

图 D-9



图 B-91

器件型号 Element type	厂名 Manufacturers	材料用途参数 Material Purpose Parameter	图号 Figure	国内外相似替换器件型号 Replace of similar type	备注 Notes	外形参考图 Reference shape	
TR0141D	TAG	6A, 400V, 0.05A, 2.5V	B-91			 图 B 91	
TR0141M	TAG	6A, 600V, 0.05A, 2.5V	B-91				
TR0141N	TAG	6A, 800V, 0.05A, 2.5V	B-91				
TR0142A	TAG	8A, 100V, 0.05A, 2.5V	B-91				
TR0142B	TAG	8A, 200V, 0.05A, 2.5V	B-91				
TR0142D	TAG	8A, 400V, 0.05A, 2.5V	B-91				
TR0142M	TAG	8A, 600V, 0.05A, 2.5V	B-91				
TR0146A	TAG	10A, 100V, 0.05A, 2.5V	B-91				
TR0146B	TAG	10A, 200V, 0.05A, 2.5V	B-91				
TR0146D	TAG	10A, 400V, 0.05A, 2.5V	B-91				
TR0146M	TAG	10A, 600V, 0.05A, 2.5V	B-91			 图 F-48	
TR0146N	TAG	10A, 800V, 0.05A, 2.5V	B-91				
TR0240A	TAG	6A, 100V, 0.05A, 2.5V	F-48				
TR0240B	TAG	6A, 200V, 0.05A, 2.5V	F-48				
TR0240D	TAG	6A, 400V, 0.05A, 2.5V	F-48				
TR0240M	TAG	6A, 600V, 0.05A, 2.5V	F-48				
TR0241A	TAG	6A, 100V, 0.05A, 2.5V	D-9				
TR0245A	TAG	10A, 100V, 0.05A, 2.5V	F-48				 图 D-9
TR0245B	TAG	10A, 200V, 0.05A, 2.5V	F-48				
TR0245D	TAG	10A, 400V, 0.05A, 2.5V	F-48				
TR0245M	TAG	10A, 600V, 0.05A, 2.5V	F-48				
TR1010	THE	10A, 1kV, 0.08A, 3V	F-48				
TR1110	THE	10A, 1.1kV, 0.08A, 3V	F-48				
TR1210	THE	10A, 1.2kV, 0.08A, 3V	F-48				
TR6010	THE	16A, 600V, 0.08A, 3V	F-48				

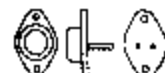
ECG5529

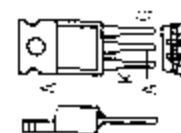
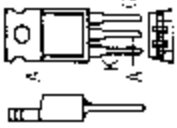
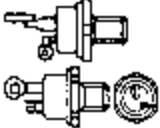
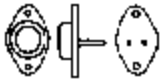
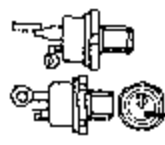
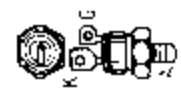
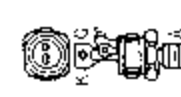
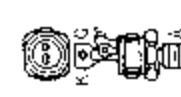
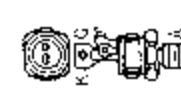
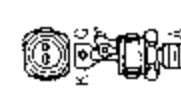

器件型号 Element type	厂名 Manufacturers	材料用途参数 Material Purpose Parameter	图号 Figure	国内外相似替换器件型号 Replace of similar type	备注 Notes	外形参考图 Reference photo
TR7010	THE	16A, 700V, 0.08A, 3V	F-48	ECG5531		 图 F-48
TR8010	THE	16A, 800V, 0.08A, 3V	F-48	ECG5531		
TR9010	THE	16A, 900V, 0.08A, 3V	F-48			
TRAL1025D	THE	25A, 1kV, 0.1A, 3V	F-48			 图 F-47
TRAL1115D	THE	15A, 200V, 0.05A, 3V	F-48			
TRAL1125D	THE	SCR-D 25A, 200V, 0.1A, 3V	F-47	SC260B		
TRAL1135D	THE	SCR-D 35A, 200V, 0.1A, 3V	F-57	T6420B		
TRAL1225D	THE	25A, 1.2kV, 0.1A, 3V	F-48			
TRAL2225D	THE	SCR-D 25A, 400V, 0.1A, 3V	F-57	SC260D		 图 F-57
TRAL2235D	THE	SCR-D 35A, 400V, 0.1A, 3V	F-57	T6420B		
TRAL3315D	THE	15A, 600V, 0.05A, 3V	F-48			
TRAL3325D	THE	25A, 600V, 0.1A, 3V	F-48			 图 F-57
TRAL3335D	THE	35A, 600V, 0.1A, 3V	F-48			
TRAL3815D	THE	15A, 700V, 0.05A, 3V	F-48			
TRAL3825D	THE	25A, 700V, 0.1A, 3V	F-48			 图 F-57
TRAL3835D	THE	SCR-D 35A, 700V, 0.1A, 3V	F-57	T6420N		
TRDV125	THE	27A, 100V, 0.15A, 3V	F-48			
TRDV225	THE	27A, 200V, 0.15A, 3V	F-48			 图 F-57
TRDV425	THE	27A, 400V, 0.15A, 3V	F-48			
TRDV625	THE	27A, 600V, 0.15A, 3V	F-48			
TRDV825	THE	27A, 800V, 0.15A, 3V	F-48			
TRDV1025	THE	27A, 1kV, 0.15A, 3V	F-48			
TRDV1225	THE	27A, 1.2kV, 0.15A, 3V	F-48			

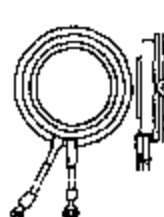
器件型号 Element type	厂名 Manufacturers	材料用途参数 Material Purpose Parameter	图号 Figure	国内外相似替换器件型号 Replace of similar type	备注 Notes	外形参考图 Reference shape
TRS02104D09	THE	210A, 400V, 0.15A, 3V	C-35			 <p>图 C-35</p>
TRS02106D09	THE	210A, 600V, 0.15A, 3V	C-35			
TRS02108D09	THE	210A, 800V, 0.15A, 3V	C-35			
TRS02110D09	THE	210A, 1kV, 0.15A, 3V	C-35			
TRS02112D09	THE	210A, 1.2kV, 0.15A, 3V	C-35			
TRS02114D09	THE	210A, 1.4kV, 0.15A, 3V	C-35			
TRS02301D09	THE	230A, 100V, 0.15A, 3V	C-35			
TRS02302D09	THE	230A, 200V, 0.15A, 3V	C-35			
TRS02304D09	THE	230A, 400V, 0.15A, 3V	C-35			
TRS02306D09	THE	230A, 600V, 0.15A, 3V	C-35			
TRS02308D09	THE	230A, 800V, 0.15A, 3V	C-35			
TRS02310D09	THE	230A, 1kV, 0.15A, 3V	C-35			
TRS02601D09	THE	260A, 100V, 0.15A, 3V	C-35			
TRS02602D09	THE	260A, 200V, 0.15A, 3V	C-35			
TRS02604D09	THE	260A, 400V, 0.15A, 3V	C-35			
TRS02606D09	THE	260A, 600V, 0.15A, 3V	C-35			
TRS02608D09	THE	260A, 800V, 0.15A, 3V	C-35			
TRS02610D09	THE	260A, 1kV, 0.15A, 3V	C-35			
TRS03801D13	THE	380A, 100V, 0.2A, 3V	C-35			
TRS03802D13	THE	380A, 200V, 0.2A, 3V	C-35			
TRS03804D13	THE	380A, 400V, 0.2A, 3V	C-35			
TRS03806D13	THE	380A, 600V, 0.2A, 3V	C-35			
TRS03808D13	THE	380A, 800V, 0.2A, 3V	C-35			
TRS03810D13	THE	380A, 1kV, 0.2A, 3V	C-35			
TRS03812D13	THE	380A, 1.2kV, 0.2A, 3V	C-35			

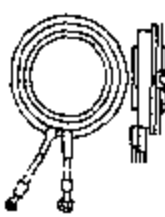
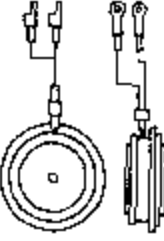
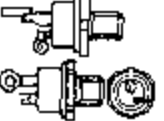

器件型号 Element type	厂名 Manufacturers	材料用途参数 Material Purpose Parameter	图号 Figure	国内外相似替换器件型号 Replace of similar type	备注 Notes	外形参考图 Reference shape
TRS04001D13	THE	400A, 100V, 0.2A, 3V	C-35			 图 C-35
TRS04002D13	THE	400A, 200V, 0.2A, 3V	C-35			
TRS04004D13	THE	400A, 400V, 0.2A, 3V	C-35			
TRS04006D13	THE	400A, 600V, 0.2A, 3V	C-35			
TRS04008D13	THE	400A, 800V, 0.2A, 3V	C-35			
TRS04010D13	THE	400A, 1kV, 0.2A, 3V	C-35			
TRS04301D13	THE	430A, 100V, 0.2A, 3V	C-35			 图 C-47
TRS04302D13	THE	430A, 200V, 0.2A, 3V	C-35			
TRS04304D13	THE	430A, 400V, 0.2A, 3V	C-35			
TRS04306D13	THE	430A, 600V, 0.2A, 3V	C-35			
TRS04308D13	THE	430A, 800V, 0.2A, 3V	C-35			
TRS04310D13	THE	430A, 1kV, 0.2A, 3V	C-35			
TRS06601D17	THE	660A, 100V, 0.2A, 3V	C-47			 图 F-48
TRS06602D17	THE	660A, 200V, 0.2A, 3V	C-47			
TRS06604D17	THE	660A, 400V, 0.2A, 3V	C-47			
TRS06606D17	THE	660A, 600V, 0.2A, 3V	C-47			
TRS06608D17	THE	660A, 800V, 0.2A, 3V	C-47			
TRS11001D25	THE	1.1kA, 100V, 0.2A, 3V	C-47			
TS035FA	THE	35A, 50V, 0.18A, 3V	F-48			ECG5542, 2N3896 ECG5543, 2N3897 ECG5545, 2N3898
TS135	THE	35A, 100V, 0.08A, 3V	F-48			
TS135FA	THE	35A, 100V, 0.18A, 3V	F-48			
TS235	THE	35A, 200V, 0.08A, 3V	F-48			
TS235FA	THE	35A, 200V, 0.18A, 3V	F-48			
TS435	THE	35A, 400V, 0.08A, 3V	F-48			
TS435FA	THE	35A, 400V, 0.18A, 3V	F-48			

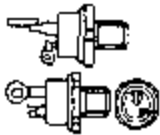
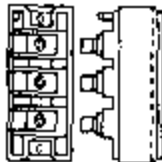
器件型号 Element type	厂名 Manufacturers	材料用途参数 Material Purpose Parameter	图号 Figure	国内外相似替换器件型号 Replace of similar type	备注 Notes	外形参考图 Reference shape
TS635	THE	35A, 600V, 0.08A, 3V	F-48	ECC5545, 2N3899		 图 F-48
TS635FA	THE	35A, 600V, 0.18A, 3V	F-48			
TS835	THE	35A, 800V, 0.08A, 3V	F-48	ECC5548, MCF3935-10		
TS835FA	THE	35A, 800V, 0.18A, 3V	F-48			
TS1035	THE	35A, 1kV, 0.08A, 3V	F-48			
TS1235	THE	35A, 1.2kV, 0.08A, 3V	F-48			
TSD035	THE	35A, 50V, 0.2A, 1.5V	F-48			 图 H-13
TSD235	THE	35A, 200V, 0.2A, 1.5V	F-48			
TSD435	THE	35A, 400V, 0.2A, 1.5V	F-48			
TSD635	THE	35A, 600V, 0.2A, 1.5V	F-48			
TSD835	THE	35A, 800V, 0.2A, 1.5V	F-48			
TSD1035	THE	35A, 1kV, 0.2A, 1.5V	F-48			
TSP225	THE	25A, 25V, 0.05A, 2V	F-48			
TSP525	THE	25A, 50V, 0.05A, 2V	F-48			
TSP1025	THE	25A, 100V, 0.05A, 2V	F-48			
TT18F200	AEG	SCA 25A, 200V, 0.08A, 2.7V	H-13			
TT18F400	AEG	SCA 25A, 400V, 0.08A, 2.7V	H-13			
TT18F600	AEG	SCA 25A, 600V, 0.08A, 2.7V	H-13			
TT18F800	AEG	SCA 25A, 800V, 0.08A, 2.7V	H-13			
TT18F900	AEG	SCA 25A, 900V, 0.08A, 2.7V	H-13			
TT18F1000	AEG	SCA 25A, 1kV, 0.08A, 2.7V	H-13			
TT18F1100	AEG	SCA 25A, 1.1kV, 0.08A, 2.7V	H-13			
TT18F1200	AEG	SCA 25A, 1.2kV, 0.08A, 2.7V	H-13			
TT18N400	AEG	SCA 25A, 400V, 0.08A, 2.7V	H-13			
TT18N800	AEG	SCA 25A, 800V, 0.08A, 2.7V	H-13			
TT18N1100	AEG	SCA 25A, 1.1kV, 0.08A, 2.7V	H-13			

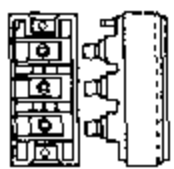

器件型号 Element type	厂名 Manufacturers	材料用途参数 Material Purpose Parameter	图号 Figure	国内外相似替换器件型号 Replace of similar type	备注 Notes	外形参考图 Reference shape
TT18N1200	AEG	SCA 25A, 1.2kV, 0.08A, 2.7V	H-13			 图 H-13
TT18N1400	AEG	SCA 25A, 1.4kV, 0.08A, 2.7V	H-13			
TT25F200	AEG	SCA 32A, 200V, 0.08A, 2.7V	H-13			
TT25F400	AEG	SCA 32A, 400V, 0.08A, 2.7V	H-13			
TT25F600	AEG	SCA 32A, 600V, 0.08A, 2.7V	H-13			
TT25F800	AEG	SCA 32A, 800V, 0.08A, 2.7V	H-13			
TT25F900	AEG	SCA 32A, 900V, 0.08A, 2.7V	H-13			
TT25F1000	AEG	SCA 32A, 1kV, 0.08A, 2.7V	H-13			
TT25F1100	AEG	SCA 32A, 1.1kV, 0.08A, 2.7V	H-13			
TT25F1200	AEG	SCA 32A, 1.2kV, 0.08A, 2.7V	H-13			
TT25N400	AEG	SCA 32A, 400V, 0.08A, 2.7V	H-13			
TT25N600	AEG	SCA 32A, 600V, 0.08A, 2.7V	H-13			
TT25N1400	AEG	SCA 32A, 1.4kV, 0.08A, 2.7V	H-13			
TT32N400	AEG	SCA 32A, 400V, 0.12A, 1.4V	H-13			
TT32N600	AEG	SCA 32A, 600V, 0.12A, 1.4V	H-13			
TT32N800	AEG	SCA 32A, 800V, 0.12A, 1.4V	H-13			
TT32N1100	AEG	SCA 32A, 1.1kV, 0.12A, 1.4V	H-13			
TT32N1200	AEG	SCA 32A, 1.2kV, 0.12A, 1.4V	H-13			
TT32N1400	AEG	SCA 32A, 1.4kV, 0.12A, 1.4V	H-13			
TT32N1600	AEG	SCA 32A, 1.6kV, 0.12A, 1.4V	H-13			
TT35F200	AEG	SCA 63A, 200V, 0.15A, 1.4V	H-13			
TT35F400	AEG	SCA 63A, 400V, 0.15A, 1.4V	H-13			
TT35F600	AEG	SCA 63A, 600V, 0.15A, 1.4V	H-13			
TT35F800	AEG	SCA 63A, 800V, 0.15A, 1.4V	H-13			
TT35F900	AEG	SCA 63A, 900V, 0.15A, 1.4V	H-13			

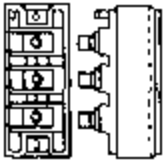
器件型号 Element type	厂名 Manufacturers	材料用途参数 Material Purpose Parameter	图号 Figure	国内外相似替换器件型号 Replace of similar type	备注 Notes	外形参考图 Reference shape
TT35F1000	AEG	SCA 63A, 1kV, 0.15A, 1.4V	H-13			 <p>图 H-13</p>
TT35F1100	AEG	SCA 63A, 1.1kV, 0.15A, 1.4V	H-13			
TT35F1200	AEG	SCA 63A, 1.2kV, 0.15A, 1.4V	H-13			
TT36N200		51A, 200V, 0.15A, 2.5V				
TT36N400		51A, 400V, 0.15A, 2.5V				
TT36N600		51A, 600V, 0.15A, 2.5V				
TT36N1100		51A, 1.1kV, 0.15A, 2.5V				
TT36N1200		51A, 1.2kV, 0.15A, 2.5V				
TT36N1400		51A, 1.4kV, 0.15A, 2.5V				
TT42F200		64A, 200V, 0.15A, 2.5V				
TT42F400		64A, 400V, 0.15A, 2.5V				
TT42F600		64A, 600V, 0.15A, 2.5V				
TT42F800		64A, 800V, 0.15A, 2.5V				
TT42F900		64A, 900V, 0.15A, 2.5V				
TT42F1000		64A, 1kV, 0.15A, 2.5V				
TT42N400	AEG	SCA 63A, 400V, 0.12A, 1.4V	H-13			
TT42N800	AEG	SCA 63A, 800V, 0.12A, 1.4V	H-13			
TT42N1100	AEG	SCA 63A, 1.1kV, 0.12A, 1.4V	H-13			
TT42N1200	AEG	SCA 63A, 1.2kV, 0.12A, 1.4V	H-13			
TT45F200	AEG	SCA 76A, 200V, 0.15A, 1.4V	H-13			
TT45F400	AEG	SCA 76A, 400V, 0.15A, 1.4V	H-13			
TT45F600	AEG	SCA 76A, 600V, 0.15A, 1.4V	H-13			
TT45F800	AEG	SCA 76A, 800V, 0.15A, 1.4V	H-13			
TT45F900	AEG	SCA 76A, 900V, 0.15A, 1.4V	H-13			
TT45F1000	AEG	SCA 76A, 1kV, 0.15A, 1.4V	H-13			
TT45F1100	AEG	SCA 76A, 1.1kV, 0.15A, 1.4V	H-13			
TT45F1200	AEG	SCA 76A, 1.2kV, 0.15A, 1.4V	H-13			

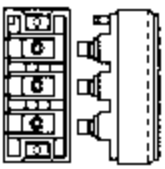

器件型号 Element type	厂名 Manufacturers	材料用途参数 Material Purpose Parameter	图号 Figure	国内外相似替换器件型号 Replace of similar type	备注 Notes	外形参考图 Reference shape
TT45N400	AEG	SCA 63A, 400V, 0.12A, 1.4V	H-13			 图 H 13
TT45N600	AEG	SCA 64A, 600V, 0.12A, 1.4V	H-13			
TT45N800	AEG	SCA 63A, 800V, 0.12A, 1.4V	H-13			
TT45N1000	AEG	SCA 64A, 1kV, 0.12A, 1.4V	H-13			
TT45N1100	AEG	SCA 63A, 1.1kV, 0.12A, 1.4V	H-13			
TT45N1200	AEG	SCA 64A, 1.2kV, 0.12A, 1.4V	H-13			
TT45N1400	AEG	SCA 63A, 1.4kV, 0.12A, 1.4V	H-13			
TT45N1500	AEG	SCA 63A, 1.5kV, 0.12A, 1.4V	H-13			
TT46N200		64A, 200V, 0.15A, 2.5V				
TT46N400		64A, 400V, 0.15A, 2.5V				
TT46N600		64A, 600V, 0.15A, 2.5V				
TT46N800		64A, 800V, 0.15A, 2.5V				
TT46N1100		64A, 1.1kV, 0.15A, 2.5V				
TT46N1200		64A, 1.2kV, 0.15A, 2.5V				
TT46N1400		64A, 1.4kV, 0.15A, 2.5V				
TT60N400	AEG	SCA 76A, 400V, 0.12A, 1.4V	H-13			
TT60N600	AEG	SCA 73A, 600V, 0.12A, 1.4V	H-13			
TT60N800	AEG	SCA 76A, 800V, 0.12A, 1.4V	H-13			
TT60N1000	AEG	SCA 73A, 1kV, 0.12A, 1.4V	H-13			
TT60N1100	AEG	SCA 76A, 1.1kV, 0.12A, 1.4V	H-13			
TT60N1200F	AEG	SCA 73A, 1.2kV, 0.12A, 1.4V	H-13			
TT60N1400	AEG	SCA 73A, 1.4kV, 0.12A, 1.4V	H-13			
TT60N1500	AEG	SCA 76A, 1.5kV, 0.12A, 1.4V	H-13			
TT71F900		115A, 900V, 0.15A, 2V				
TT71F1000		115A, 1kV, 0.15A, 2V				
TT71F1100		115A, 1.1kV, 0.15A, 2V				

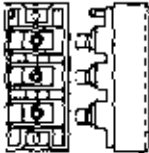
器件型号 Element type	厂名 Manufacturers	材料用途参数 Material Purpose Parameter	图号 Figure	国内外相似替换器件型号 Replacc of similar type	备注 Notes	外形参考图 Reference shape
TT71F1200		115A, 1.2kV, 0.15A, 2V				 图 H-13
TT71F1300		115A, 1.3kV, 0.15A, 2V				
TT75N400		95A, 400V, 0.12A, 1.4V				
TT75N600		95A, 600V, 0.12A, 1.4V				
TT75N800		95A, 800V, 0.12A, 1.4V				
TT75N1100		95A, 1.1kV, 0.12A, 1.4V				
TT75N1200		95A, 1.2kV, 0.12A, 1.4V				
TT75N1400		95A, 1.4kV, 0.12A, 1.4V				
TT75N1600		95A, 1.6kV, 0.12A, 1.4V				
TT81F400		115A, 400V, 0.15A, 2V				
TT81F600		115A, 600V, 0.15A, 2V				
TT81F800		115A, 800V, 0.15A, 2V				
TT86N600		102A, 600V, 0.15A, 1.4V				
TT86N800		102A, 800V, 0.15A, 1.4V				
TT86N1100		102A, 1.1kV, 0.15A, 1.4V				
TT86N1200		102A, 1.2kV, 0.15A, 1.4V				
TT86N1400		102A, 1.4kV, 0.15A, 1.4V				
TT86N1600		102A, 1.6kV, 0.15A, 1.4V				
TT86N1800		102A, 1.8kV, 0.15A, 1.4V				
TT95N400	AEG	SCA 95A, 400V, 0.12A, 1.4V	H-13			
TT95N600	AEG	SCA 95A, 600V, 0.12A, 1.4V	H-13			
TT95N800	AEG	SCA 95A, 800V, 0.12A, 1.4V	H-13			
TT95N1100	AEG	SCA 76A, 1.1kV, 0.15A, 1.4V	H-13			
TT95N1200	AEG	SCA 95A, 1.2kV, 0.12A, 1.4V	H-13			

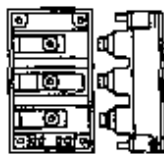

器件型号 Element type	厂名 Manufacturers	材料用途参数 Material Purpose Parameter	图号 Figure	国内外相似替换器件型号 Replace of similar type	备注 Notes	外形参考图 Reference shape
TT101F900		128A, 900V, 0.15A, 2V				 图 H-18
TT101F1000		128A, 1kV, 0.15A, 2V				
TT101F1100		128A, 1.1kV, 0.15A, 2V				
TT101F1200		128A, 1.2kV, 0.15A, 2V				
TT101F1300		128A, 1.3kV, 0.15A, 2V				
TT106N600		115A, 600V, 0.15A, 1.4V				
TT106N800		115A, 800V, 0.15A, 1.4V				
TT106N1100		115A, 1.1kV, 0.15A, 1.4V				
TT106N1200		115A, 1.2kV, 0.15A, 1.4V				
TT106N1400		115A, 1.4kV, 0.15A, 1.4V				
TT106N1600		115A, 1.6kV, 0.15A, 1.4V				
TT106N1800		115A, 1.8kV, 0.15A, 1.4V				
TT111F400		128A, 400V, 0.15A, 2V				
TT111F600		128A, 600V, 0.15A, 2V				
TT111F800		128A, 800V, 0.15A, 2V				
TT121N1100		128A, 1.1kV, 0.15A, 1.4V				
TT121N1200		128A, 1.2kV, 0.15A, 1.4V				
TT121N1400		128A, 1.4kV, 0.15A, 1.4V				
TT121N1600		128A, 1.6kV, 0.15A, 1.4V				
TT121N1800		128A, 1.8kV, 0.15A, 1.4V				
TT130N600	AEG	SCA 130A, 600V, 0.25A, 1.5V	H-18			
TT130N800	AEG	SCA 130A, 800V, 0.25A, 1.5V	H-18			
TT130N1100	AEG	SCA 120A, 1.1kV, 0.25A, 1.6V	H-18			
TT130N1200	AEG	SCA 130A, 1.2kV, 0.25A, 1.5V	H-18			
TT130N1400	AEG	SCA 130A, 1.4kV, 0.25A, 1.5V	H-18			

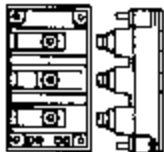
器件型号 Element type	厂名 Manufacturers	材料用途参数 Material Purpose Parameter	图号 Figure	国内外相似替换器件型号 Replace of similar type	备注 Notes	外形参考图 Reference shape
TT130N1500	AEG	SCA 130A, 1.5KV, 0.25A, 1.5V	H-18			 图 H-18
TT130N1600	AEG	SCA 95A, 1.6KV, 0.25A, 1.5V	H-18			
TT131N400		141A, 400V, 0.15A, 1.4V				
TT131N600		131A, 600V, 0.15A, 1.4V				
TT131N800		131A, 800V, 0.15A, 1.4V				
TT131N1100		131A, 1.1KV, 0.15A, 1.4V				
TT131N1200		131A, 1.2KV, 0.15A, 1.4V				
TT131N1400		131A, 1.4KV, 0.15A, 1.4V				
TT160N600	AEG	SCA 160A, 600V, 0.25A, 1.5V	H-18			
TT160N800	AEG	SCA 160A, 800V, 0.25A, 1.5V	H-18			
TT160N1100	AEG	SCA 160A, 1.1KV, 0.25A, 1.5V	H-18			
TT160N1600	AEG	SCA 160A, 1.6KV, 0.25A, 1.5V	H-18			
TT170N400		223A, 400V, 0.2A, 2V				
TT170N600		170A, 600V, 0.2A, 2V				
TT170N800		170A, 800V, 0.2A, 2V				
TT170N1100		170A, 1.1KV, 0.2A, 2V				
TT170N1200		170A, 1.2KV, 0.2A, 2V				
TT170N1400		170A, 1.4KV, 0.2A, 2V				
TT170N1600		170A, 1.6KV, 0.2A, 2V				
TT170N1800		223A, 1.8KV, 0.2A, 2V				
TT180F400		180A, 400V, 0.25A, 2.2V				
TT180F600		180A, 600V, 0.25A, 2.2V				
TT180F800		180A, 800V, 0.25A, 2.2V				
TT180F1000		180A, 1KV, 0.25A, 2.2V				
TT180F1100		180A, 1.1KV, 0.25A, 2.2V				
TT180F1200		180A, 1.2KV, 0.25A, 2.2V				



器件型号 Element type	厂名 Manufacturers	材料用途参数 Material Purpose Parameter	图号 Figure	国内外相似替换器件型号 Replace of similar type	备注 Notes	外形参考图 Reference shape
TT200F400		200A, 400V, 0.25A, 2.2V				
TT200F600		200A, 600V, 0.25A, 2.2V				
TT200F800		200A, 800V, 0.25A, 2.2V				
TT200F1000		200A, 1kV, 0.25A, 2.2V				
TT200F1100		200A, 1.1kV, 0.25A, 2.2V				
TT210N400		261A, 400V, 0.2A, 2V				
TT210N600		210A, 600V, 0.2A, 2V				
TT210N800		210A, 800V, 0.2A, 2V				
TT210N1100		210A, 1.1kV, 0.2A, 2V				
TT210N1200		210A, 1.2kV, 0.2A, 2V				
TT210N1400		210A, 1.4kV, 0.2A, 2V				
TT210N1600		210A, 1.6kV, 0.2A, 2V				
TT250N400		261A, 400V, 0.2A, 2V				
TT250N600		250A, 600V, 0.2A, 2V				
TT250N800		250A, 800V, 0.2A, 2V				
TT250N1100		250A, 1.1kV, 0.2A, 2V				
TT250N1200		250A, 1.2kV, 0.2A, 2V				
TT250N1400		250A, 1.4kV, 0.2A, 2V				
TT250N1600		250A, 1.6kV, 0.2A, 2V				
TT250N1800		261A, 1.8kV, 0.2A, 2V				
TTA25-40...160	CHN	25A, 0.4~1.6kV, 0.15A, 3V				
TTA40-40...160	CHN	40A, 0.4~1.6kV, 0.15A, 3V				
TTA55-40...160	CHN	55A, 0.4~1.6kV, 0.15A, 3V				
TTA90-40...160	CHN	90A, 0.4~1.6kV, 0.15A, 3V				
TTA110-40...160	CHN	110A, 0.4~1.6kV, 0.15A, 3V				
TTA130-40...160	CHN	130A, 0.4~1.6kV, 0.15A, 3V				





器件型号 Element type	厂名 Manufacturers	材料用途参数 Material Purpose Parameter	图号 Figure	国内外相似替换器件型号 Replace of similar type	备注 Notes	外形参考图 Reference shape
TTA160-40...160	CHN	160A, 0.4~1.6kV, 0.15A, 3V				
TTA200-40...160	CHN	200A, 0.4~1.6kV, 0.15A, 3V				
TIA250-40...160	CHN	250A, 0.4~1.6kV, 0.15A, 3V				
TTC25-40...160	CHN	25A, 0.4~1.6kV, 0.15A, 3V				
TTC40-40...160	CHN	40A, 0.4~1.6kV, 0.15A, 3V				
TTC55-40...160	CHN	55A, 0.4~1.6kV, 0.15A, 3V				
TTC90-40...160	CHN	90A, 0.4~1.6kV, 0.15A, 3V				
TTC110-40...160	CHN	110A, 0.4~1.6kV, 0.15A, 3V				
TTC130-40...160	CHN	130A, 0.4~1.6kV, 0.15A, 3V				
TTC160-40...160	CHN	160A, 0.4~1.6kV, 0.15A, 3V				
TTC200-40...160	CHN	200A, 0.4~1.6kV, 0.15A, 3V				
TTC250-40...160	CHN	250A, 0.4~1.6kV, 0.15A, 3V				
TTR25-40...160	CHN	25A, 0.4~1.6kV, 0.15A, 3V				
TTR40-40...160	CHN	40A, 0.4~1.6kV, 0.15A, 3V				
TTR55-40...160	CHN	55A, 0.4~1.6kV, 0.15A, 3V				
TTR90-40...160	CHN	90A, 0.4~1.6kV, 0.15A, 3V				
TTR110-40...160	CHN	110A, 0.4~1.6kV, 0.15A, 3V				
TTR130-40...160	CHN	130A, 0.4~1.6kV, 0.15A, 3V				
TTR160-40...160	CHN	160A, 0.4~1.6kV, 0.15A, 3V				
TTR200-40...160	CHN	200A, 0.4~1.6kV, 0.15A, 3V				
TTR250-40...160	CHN	250A, 0.4~1.6kV, 0.15A, 3V				
TTS25-40...160	CHN	25A, 0.4~1.6kV, 0.15A, 3V				
TTS40-40...160	CHN	40A, 0.4~1.6kV, 0.15A, 3V				
TTS55-40...160	CHN	55A, 0.4~1.6kV, 0.15A, 3V				
TTS90-40...160	CHN	90A, 0.4~1.6kV, 0.15A, 3V				
TTS110-40...160	CHN	110A, 0.4~1.6kV, 0.15A, 3V				

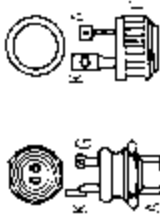
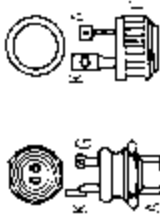
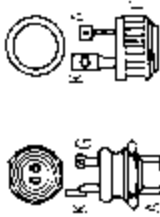
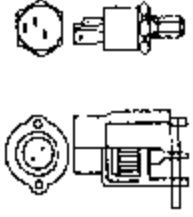
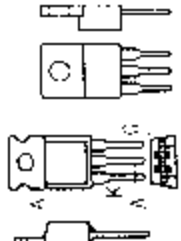



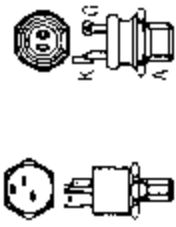
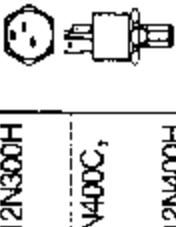
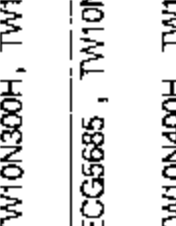
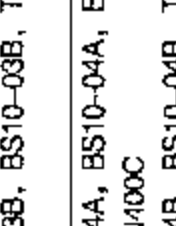

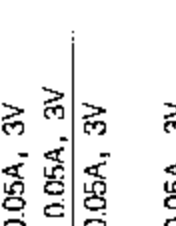
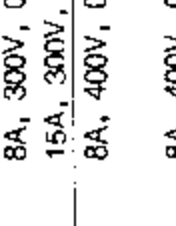
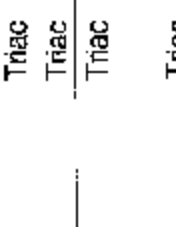
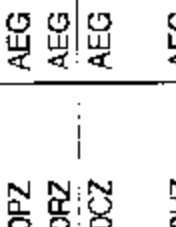
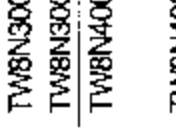

器件型号 Element type	厂名 Manufacturers	材料用途参数 Material Purpose Parameter	图号 Figure	国内外相似替换器件型号 Replace of similar type	备注 Notes	外形参考图 Reference shape
TTS130-40...160	CHN	130A, 0.4-1.6kV, 0.15A, 3V				
TTS160-40...160	CHN	160A, 0.4-1.6kV, 0.15A, 3V				
TTS200-40...160	CHN	200A, 0.4-1.6kV, 0.15A, 3V				
TTS250-40...160	CHN	250A, 0.4-1.6kV, 0.15A, 3V				
TUP13	PIH	PUT 0.15A, 40V	B-77			
TV526/100...700		Triac 10A, 100-700V, 0.075A	B-11	MAC15..., TW9N..., TW11N..., T6001...		
TW6N100CZ	AEG	Triac 6A, 100V, 0.05A, 3V	F-21	BS6-01A, BS8-01A, ECG5673, TW6N100C, TW10N100C		
TW6N100HZ	AEG	Triac 6A, 100V, 0.05A, 3V	C-85	BS6-01B, BS8-01B, TW6N100H, TW10N100H		
TW6N100PZ	AEG	Triac 6A, 100V, 0.05A, 3V	D-40	BS6-01B, BS8-01B, TW6N100H, TW10N100H		
TW6N100RZ	AEG	Triac 12A, 100V, 0.05A, 3V	F-56			
TW6N200CZ	AEG	Triac 6A, 200V, 0.05A, 3V	F-21	BS6-02A, BS8-02A, ECG5673, TW6N200C, TW10N200C		
TW6N200HZ	AEG	Triac 6A, 200V, 0.05A, 3V	C-85	BS6-02B, BS8-02B, TW6N200H, TW10N200H		
TW6N200PZ	AEG	Triac 6A, 200V, 0.05A, 3V	D-40	BS6-02B, BS8-02B, TW6N200H, TW10N200H		
TW6N200RZ	AEG	Triac 12A, 200V, 0.05A, 3V	F-56			
TW6N300CZ	AEG	Triac 6A, 300V, 0.05A, 3V	F-21	BS6-03A, BS8-03A, ECG5675, TW6N300C, TW10N300C		
TW6N300HZ	AEG	Triac 6A, 300V, 0.05A, 3V	C-85	BS6-03B, BS8-03B, TW6N300H, TW10N300H		
TW6N300PZ	AEG	Triac 6A, 300V, 0.05A, 3V	D-40	BS6-03B, BS8-03B, TW6N300H, TW10N300H		
TW6N300RZ	AEG	Triac 12A, 300V, 0.05A, 3V	F-56			
TW6N400CZ	AEG	Triac 6A, 400V, 0.05A, 3V	F-21	BS6-04A, BS8-04A, ECG5675, TW6N400C, TW10N400C		
TW6N400HZ	AEG	Triac 6A, 400V, 0.05A, 3V	C-85	BS6-04B, BS8-04B, TW6N400H, TW10N400H		
TW6N400PZ	AEG	Triac 6A, 400V, 0.05A, 3V	D-40	BS6-04B, BS8-04B, TW6N400H, TW10N400H		
TW6N400RZ	AEG	Triac 12A, 400V, 0.05A, 3V	F-56			

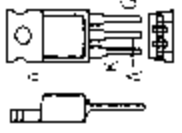
器件型号 Element type	厂名 Manufacturers	材料用途参数 Material Purpose Parameter	图号 Figure	国内外相似替换器件型号 Replace of similar type	备注 Notes	外形参考图 Reference shape
TW6N500CZ	AEG	Triac 6A, 500V, 0.05A, 3V	F-21	BS6-05A, BS8-05A, ECG5677, TW8N500C, TW10N500C		 图 F-21 图 C-85
TW6N500HZ	AEG	Triac 6A, 500V, 0.05A, 3V	C-85	BS6-05B, BS8-05B, TW8N-05H, TW10N500H		
TW6N500PZ	AEG	Triac 6A, 500V, 0.05A, 3V	D-40	BS6-05B, BS8-05B, TW8N-05H, TW10N500H		
TW6N600CZ	AEG	Triac 6A, 600V, 0.05A, 3V	F-21	BS6-06A, BS8-06A, ECG5676, TW8N600C, TW10N600C		 图 F-21 图 C-85
TW6N600HZ	AEG	Triac 6A, 600V, 0.05A, 3V	C-85	BS6-06B, DS8-06B, TW8N600H, TW10N600H		
TW6N600PZ	AEG	Triac 6A, 600V, 0.05A, 3V	D-40	BS6-06B, BS8-06B, TW8N600H, TW10N600H		
TW6N600RZ	AEG	Triac 12A, 600V, 0.05A, 3V	F-56			
TW6N700CZ	AEG	Triac 6A, 700V, 0.05A, 3V	F-21	BS6-07A, BS8-07A, TW8N700C, TW10N700C		 图 F-21 图 C-85
TW6N700HZ	AEG	Triac 6A, 700V, 0.05A, 3V	C-85	BS6-07B, BS8-07B, TW8N700H, TW10N700H		
TW6N700PZ	AEG	Triac 6A, 700V, 0.05A, 3V	D-40	BS6-07B, BS8-07B, TW8N700H, TW10N700H		
TW6N700RZ	AEG	Triac 12A, 700V, 0.05A, 3V	F-56			 图 D-40 图 F-56
TW7N400FZ	AEG	Triac 7A, 400V, 0.05A, 2V	B-91	MAC222-6, TIC226D, T2800D, T2802D		
TW7N500FZ	AEG	Triac 7A, 500V, 0.05A	B-11	MAC222-7, TIC226C, T2800C, T2802C		
TW7N600FZ	AEG	Triac 7A, 600V, 0.05A	B-11	MAC222-8, TIC226E, T2800E, T2802E		
TW7N700FZ	AEG	Triac 7A, 700V, 0.05A, 2V	D-91	MAC222-9, TIC226M, T2800M, T2802M		
TW7N800FZ	AEG	Triac 7A, 800V, 0.05A, 2V	B-91	MAC222-10, TIC226S, T2800S, T2802S		 图 B-91 图 B-11
TW8N100CZ	AEG	Triac 8A, 100V, 0.05A, 3V	F-21	ECG5682, BS8-01A, BS10-01A, TW10N100C, TW12N100C		
TW8N100HZ	AEG	Triac 8A, 100V, 0.05A, 3V	C-85	BS8-01B, BS10-01B, TW10N100H, TW12N100H		
TW8N100PZ	AEG	Triac 8A, 100V, 0.05A, 3V	D-40	BS8-01B, BS10-01B, TW10N100H, TW12N100H		
TW8N100RZ	AEG	Triac 15A, 100V, 0.05A, 3V	F-56			
TW8N200CZ	AEG	Triac 8A, 200V, 0.05A, 3V	F-21	BS8-02A, BS10-02A, ECG5683, TW10N200C, TW12N200C		
TW8N200HZ	AEG	Triac 8A, 200V, 0.05A, 3V	C-85	BS8-02B, BS10-02B, TW10N200H, TW12N200H		
TW8N200PZ	AEG	Triac 8A, 200V, 0.05A, 3V	D-40	BS8-02B, BS10-02B, TW10N200H, TW12N200H		

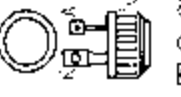
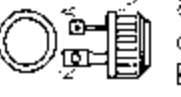
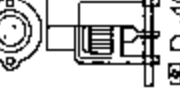
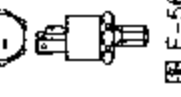
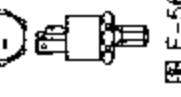

器件型号 Element type	厂名 Manufacturers	材料用途参数 Material Purpose Parameter	图号 Figure	国内外相似替换器件型号 Replace of similar type	备注 Notes	外形参考图 Reference shape
TW8N200RZ	AEG	15A, 200V, 0.05A, 3V	F-56	BS8-03A, BS10-03A, ECG5685, TW10N300C, TW12N300C		 图 F-56
TW8N300CZ	AEG	8A, 300V, 0.05A, 3V	F-21	BS8-03B, BS10-03B, TW10N300H, TW12N300H		 图 F-21
TW8N300HZ	AEG	8A, 300V, 0.05A, 3V	C-85	BS8-03B, BS10-03B, TW10N300H, TW12N300H		 图 C-85
TW8N300PZ	AEG	8A, 300V, 0.05A, 3V	D-40	BS8-03B, BS10-03B, TW10N300H, TW12N300H		 图 D-40
TW8N300RZ	AEG	15A, 300V, 0.05A, 3V	F-56	BS8-04A, BS10-04A, ECG5685, TW10N400C, TW12N400C		 图 F-56
TW8N400CZ	AEG	8A, 400V, 0.05A, 3V	F-21	BS8-04B, BS10-04B, TW10N400H, TW12N400H		 图 F-21
TW8N400HZ	AEG	8A, 400V, 0.05A, 3V	C-85	BS8-04B, BS10-04B, TW10N400H, TW12N400H		 图 C-85
TW8N400PZ	AEG	8A, 400V, 0.05A, 3V	D-40	BS8-04B, BS10-04B, TW10N400H, TW12N400H		 图 D-40
TW8N400RZ	AEG	15A, 400V, 0.05A, 3V	F-56	BS8-05A, BS10-05A, ECG5687, TW10N500C, TW12N500C		 图 F-56
TW8N500CZ	AEG	8A, 500V, 0.05A, 3V	F-21	BS8-05B, BS10-05B, TW10N500H, TW12N500H		 图 F-21
TW8N500HZ	AEG	8A, 500V, 0.05A, 3V	C-85	BS8-05B, BS10-05B, TW10N500H, TW12N500H		 图 C-85
TW8N500PZ	AEG	8A, 500V, 0.05A, 3V	D-40	BS8-05B, BS10-05B, TW10N500H, TW12N500H		图 D-40
TW8N500RZ	AEG	15A, 500V, 0.05A, 3V	F-56	BS8-06A, BS10-06A, ECG5697, TW10N600C, TW12N600C		图 F-56
TW8N600CZ	AEG	8A, 600V, 0.05A, 3V	F-21	BS8-06B, BS10-06B, TW10N600H, TW12N600H		图 F-21
TW8N600HZ	AEG	8A, 600V, 0.05A, 3V	C-85	BS8-06B, BS10-06B, TW10N600H, TW12N600H		图 C-85
TW8N600PZ	AEG	8A, 600V, 0.05A, 3V	D-40	BS8-06B, BS10-06B, TW10N600H, TW12N600H		图 D-40
TW8N600RZ	AEG	15A, 600V, 0.05A, 3V	F-56	BS8-07A, BS10-07A, TW10N700C, TW12N700C		图 F-56
TW8N700CZ	AEG	8A, 700V, 0.05A, 3V	F-21	BS8-07B, BS10-07B, TW10N700H, TW12N700H		图 F-21
TW8N700HZ	AEG	8A, 700V, 0.05A, 3V	C-85	BS8-07B, BS10-07B, TW10N700H, TW12N700H		图 C-85
TW8N700PZ	AEG	8A, 700V, 0.05A, 3V	D-40	BS8-07B, BS10-07B, TW10N700H, TW12N700H		图 D-40
TW8N700RZ	AEG	15A, 700V, 0.05A, 3V	F-56	BS8-07B, BS10-07B, TW10N700H, TW12N700H		图 F-56
TW9N400FZ	AEG	9A, 400V, 0.05A, 2V	B-91	TAG251-400, TAG256-400, TIC236D, TXD10H400M		图 B-91
TW9N500FZ	AEG	10A, 500V, 0.05A	B-11	TAG251-500, TAG256-500, TIC236E, TXD10H500M		图 B-11
TW9N600FZ	AEG	10A, 600V, 0.05A	B-11	TAG251-600, TAG256-600, TIC236M, FXD10H600M		图 B-11

器件型号 Element type	厂名 Manufacturers	材料用途参数 Material Purpose Parameter	图号 Figure	国内外相似替换器件型号 Replace of similar type	备注 Notes	外形参考图 Reference shape
TW9N700FZ	AEG	Triac 9A, 700V, 0.05A, 2V	B-91	TAG251-700, TAG256-700, TIC236S, TXD10H700M		 图 B-91
TW9N800FZ	AEG	Triac 9A, 800V, 0.05A, 2V	B-91	TAG251-800, TAG256-800, TIC236N, TXD10H800M		
TW10N100CZ	AEG	Triac 10A, 100V, 0.05A, 3V	F-21	BS10-01A, ECG5682, TW12N100C, TW18N100CZ, TW25N100CZ		 图 F-21
TW10N100HZ	AEG	Triac 10A, 100V, 0.05A, 3V	C-85	BS10-01B, TW12N100H, T6401A		
TW10N100PZ	AEG	Triac 10A, 100V, 0.05A, 3V	D-40	BS10-01B, TW12N100H, T6401A		 图 C-85
TW10N100RZ	AEG	Triac 19A, 100V, 0.05A, 3V	F-56			
TW10N200CZ	AEG	Triac 10A, 200V, 0.05A, 3V	F-21	BS10-02A, ECG5683, TW12N200C, TW18N200CZ, TW25N200CZ		 图 F-21
TW10N200HZ	AEG	Triac 10A, 200V, 0.05A, 3V	C-85	BS10-02B, TW12N200H, T6401B		
TW10N200PZ	AEG	Triac 10A, 200V, 0.05A, 3V	D-40	BS10-02B, TW12N200H, T6401B		 图 C-85
TW10N200RZ	AEG	Triac 19A, 200V, 0.05A, 3V	F-56			
TW10N300CZ	AEG	Triac 10A, 300V, 0.05A, 3V	F-21	BS10-03A, ECG5685, TW12N300C, TW18N300CZ, TW25N300CZ		 图 D-40
TW10N300HZ	AEG	Triac 10A, 300V, 0.05A, 3V	C-85	BS10-03B, TW12N300H, T6401C		
TW10N300PZ	AEG	Triac 10A, 300V, 0.05A, 3V	D-40	BS10-03B, TW12N300H, T6401C		 图 D-40
TW10N400CZ	AEG	Triac 10A, 400V, 0.05A, 3V	F-21	BS10-04A, ECG5685, TW12N400C, TW18N400CZ, TW25N400CZ		
TW10N400HZ	AEG	Triac 10A, 400V, 0.05A, 3V	C-85	BS10-04B, TW12N400H, T6401D		 图 F-56
TW10N400PZ	AEG	Triac 10A, 400V, 0.05A, 3V	D-40	BS10-04B, TW12N400H, T6401D		
TW10N400RZ	AEG	Triac 19A, 400V, 0.05A, 3V	F-56			 图 F-56
TW10N500CZ	AEG	Triac 10A, 500V, 0.05A, 3V	F-21	BS10-05A, ECG5687, TW12N500C, TW18N500CZ, TW25N500CZ		
TW10N500HZ	AEG	Triac 10A, 500V, 0.05A, 3V	C-85	BS10-05B, TW12N500H, T6401E		 图 F-56
TW10N500PZ	AEG	Triac 10A, 500V, 0.05A, 3V	D-40	BS10-05B, TW12N500H, T6401E		
TW10N500RZ	AEG	Triac 19A, 500V, 0.05A, 3V	F-56			 图 F-56
TW10N600CZ	AEG	Triac 10A, 600V, 0.05A, 3V	F-21	BS10-06A, ECG5697, TW12N600C, TW18N600CZ, TW25N600CZ		













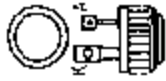













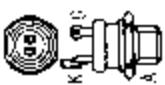
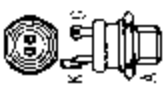

器件型号 Element type	厂名 Manufacturers	材料用途参数 Material Purpose Parameter	图号 Figure	国内外相似替换器件型号 Replace of similar type	备注 Notes	外形参考图 Reference shape
TW10N600HZ	AEG	10A, 600V, 0.05A, 3V	C-85	BS10-06B, TW12N600H, T6401M		
TW10N600PZ	AEG	10A, 600V, 0.05A, 3V	D-40	BS10-06B, TW12N600H, T6401M		
TW10N700CZ	AEG	10A, 700V, 0.05A, 3V	F-21	BS10-07A, TW12N700C, TW18N700CZ		
TW10N700HZ	AEG	10A, 700V, 0.05A, 3V	C-85	BS10-07B, TW12N700H, T6401S		
TW10N700PZ	AEG	10A, 700V, 0.05A, 3V	D-40	BS10-07B, TW12N700H, T6401S		
TW10N700RZ	AEG	19A, 700V, 0.05A, 3V	F-56			
TW11N400FZ	AEG	11A, 400V, 0.05A, 2V	B-91	TIC236D, TXD10K/L40P, 2N6342A, 2N6343A, 2N6344A, 2N6345A		
TW11N500FZ		11A, 600V, 0.05A, 2V	B-91	TIC236M, TXD10K/L60P, 2N6342A, 2N6343A, 2N6344A, 2N6345A		
TW11N600FZ	AEG	11A, 600V, 0.05A, 2V	B-91	TIC236M, TXD10K/L60P, 2N6342A, 2N6343A, 2N6344A, 2N6345A		
TW11N700FZ		12A, 700V, 0.05A	B-11	TIC236S, TXD10K/L70P, 2N6342A, 2N6343A, 2N6344A, 2N6345A		
TW11N800FZ	AEG	11A, 800V, 0.05A, 2V	B-91	TIC236N, TXD10K/L80P, 2N6342A, 2N6343A, 2N6344A, 2N6345A		
TW12N400CT	AEG	12A, 400V, 0.08A, 3V	F-23	TW18N400CZ, TW25N400CZ		
TW12N400CX	AEG	12A, 400V, 0.08A, 3V	F-21			
TW12N400HT		12A, 400V, 0.08A, 3V	D-14			
TW12N400RT	AEG	23A, 400V, 0.08A, 3V	F-56			
TW12N400FX	AEG	23A, 400V, 0.08A, 3V	F-56			
TW12N500CT	AEG	12A, 500V, 0.08A, 3V	F-23	TW18N500CZ, TW25N500CZ		
TW12N500CX	AEG	12A, 500V, 0.08A, 3V	F-23	TW18N500CZ, TW25N500CZ		
TW12N500HT		12A, 500V, 0.08A, 3V	D-14			
TW12N500RT	AEG	23A, 500V, 0.08A, 3V	F-56			
TW12N500RX	AEG	23A, 500V, 0.08A, 3V	F-56			
TW12N600CT	AEG	12A, 600V, 0.08A, 3V	F-23	TW18N600CZ, TW25N600CZ		

图 D-14

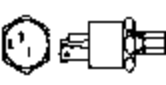
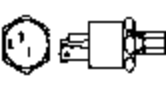
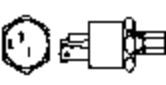
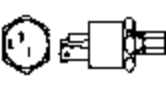

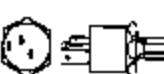



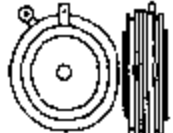



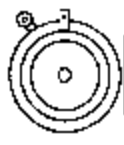



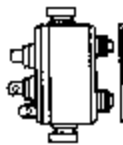

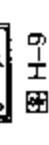
器件型号 Element type	厂名 Manufacturers	材料用途参数 Material Purpose Parameter	图号 Figure	国内外相似替换器件型号 Replace of similar type	备注 Notes	外形参考图 Reference shape
TW12N600CX	AEG	12A, 600V, 0.08A, 3V	F-21			 图 F-21
TW12N600HT		Triac	D-14			
TW12N600RT	AEG	12A, 600V, 0.08A, 3V	F-56			
TW12N600RX	AEG	23A, 600V, 0.08A, 3V	F-56			
TW12N700CT	AEG	12A, 700V, 0.08A, 3V	F-23	TW18N700CZ, TW25N700CZ		 图 F-21
TW12N700CX	AEG	12A, 700V, 0.08A, 3V	F-23	TW18N700CZ, TW25N700CZ		
TW12N700HT		Triac	D-14			
TW12N700RT	AEG	12A, 700V, 0.08A, 3V	F-56			
TW12N700RX	AEG	23A, 700V, 0.08A, 3V	F-56			 图 D-14
TW12N800CT	AEG	12A, 800V, 0.08A, 3V	F-23	TW18N800CZ, TW25N800CZ		
TW12N800CX	AEG	12A, 800V, 0.08A, 3V	F-21			
TW12N800HT		Triac	D-14			
TW12N800RT	AEG	12A, 800V, 0.08A, 3V	F-56			 图 D-14
TW12N800RX	AEG	23A, 800V, 0.08A, 3V	F-56			
TW12N900CT	AEG	12A, 900V, 0.08A, 3V	F-23	TW18N900CZ, TW25N900CZ		
TW12N900CX	AEG	12A, 900V, 0.08A, 3V	F-23	TW18N900CZ, TW25N900CZ		
TW12N900HT		Triac	D-14			 图 F-56
TW12N900RT	AEG	12A, 900V, 0.08A, 3V	F-56			
TW12N900RX	AEG	23A, 900V, 0.08A, 3V	F-56			
TW12N1000CT	AEG	12A, 1kV, 0.08A, 3V	F-23	TW18N1000CZ, TW25N1000CZ		
TW12N1000CX	AEG	12A, 1kV, 0.08A, 3V	F-21			 图 F-56
TW12N1000HT		Triac	D-14			
TW12N1000RT	AEG	12A, 1kV, 0.08A, 3V	F-56			
TW12N1000RX	AEG	23A, 1kV, 0.08A, 3V	F-56			
TW12N1100CT	AEG	12A, 1.1kV, 0.08A, 3V	F-23	TW18N1100CZ, TW25N1100CZ		 图 F-56
TW12N1100CX	AEG	12A, 1.1kV, 0.08A, 3V	F-21			
TW12N1100HT		Triac	D-14			
TW12N1100RT	AEG	12A, 1.1kV, 0.08A, 3V	F-56			
TW12N1100RX	AEG	23A, 1.1kV, 0.08A, 3V	F-56			 图 F-56

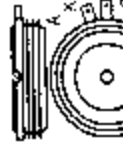

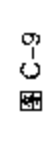
器件型号 Element type	厂名 Manufacturers	材料用途参数 Material Purpose Parameter	图号 Figure	国内外相似替换器件型号 Replace of similar type	备注 Notes	外形参考图 Reference shape
TW18N400CT	AEG	Triac 36A, 400V, 0.08A, 3V	F-21	TW25N400CZ		 K A 图 F-21
TW18N400CX	AEG	18A, 400V, 0.08A, 3V	F-23			
TW18N400RX	AEG	36A, 400V, 0.08A, 3V	F-56			
TW18N500CT	AEG	Triac 36A, 500V, 0.08A, 3V	F-21	TW25N500CZ		 K A 图 F-23
TW18N500CX	AEG	18A, 500V, 0.08A, 3V	F-23			
TW18N500RT	AEG	36A, 500V, 0.08A, 3V	F-56			
TW18N500RX	AEG	36A, 500V, 0.08A, 3V	F-56			 K A 图 F-56
TW18N600CT	AEG	Triac 36A, 600V, 0.08A, 3V	F-21	TW25N600CZ		
TW18N600CX	AEG	18A, 600V, 0.08A, 3V	F-23			
TW18N600RX	AEG	36A, 600V, 0.08A, 3V	F-56			
TW18N700CT	AEG	Triac 36A, 700V, 0.08A, 3V	F-21	TW25N700CZ		
TW18N700CX	AEG	18A, 700V, 0.08A, 3V	F-23			
TW18N700RT	AEG	36A, 700V, 0.08A, 3V	F-56			
TW18N700RX	AEG	36A, 700V, 0.08A, 3V	F-56			
TW18N800CT	AEG	Triac 36A, 800V, 0.08A, 3V	F-21	TW25N800CZ		
TW18N800CX	AEG	18A, 800V, 0.08A, 3V	F-23			
TW18N800RT	AEG	36A, 800V, 0.08A, 3V	F-56			
TW18N800RX	AEG	36A, 800V, 0.08A, 3V	F-56			
TW18N900CT	AEG	Triac 36A, 900V, 0.08A, 3V	F-21	TW25N900CZ		
TW18N900CX	AEG	18A, 900V, 0.08A, 3V	F-23			
TW18N900RT	AEG	36A, 900V, 0.08A, 3V	F-56			
TW18N900RX	AEG	36A, 900V, 0.08A, 3V	F-56			
TW18N1000CT	AEG	Triac 36A, 1kV, 0.08A, 3V	F-21	TW25N1000CZ		
TW18N1000CX	AEG	18A, 1kV, 0.08A, 3V	F-23			
TW18N1000RT	AEG	36A, 1kV, 0.08A, 3V	F-56			
TW18N1000RX	AEG	36A, 1kV, 0.08A, 3V	F-56			
TW18N1100CT	AEG	Triac 36A, 1.1kV, 0.08A, 3V	F-21	TW25N1100CZ		
TW18N1100CX	AEG	18A, 1.1kV, 0.08A, 3V	F-23			
TW18N1100RT	AEG	36A, 1.1kV, 0.08A, 3V	F-56			

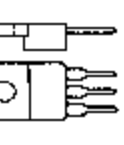
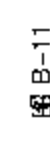

器件型号 Element type	厂名 Manufacturers	材料用途参数 Material Purpose Parameter	图号 Figure	国内外相似替换器件型号 Replace of similar type	备注 Notes	外形参考图 Reference shape	
TW18N1100RX	AEG	36A, 1.1KV, 0.08A, 3V	F-56			 图 F-56	
TW25N400CT	AEG	40A, 400V, 0.15A, 3V	F-21			 图 F-21	
TW25N400CX	AEG	25A, 400V, 0.15A, 3V	F-23				
TW25N500CT	AEG	40A, 500V, 0.15A, 3V	F-21				
TW25N500CX	AEG	25A, 500V, 0.15A, 3V	F-23				
TW25N600CT	AEG	40A, 600V, 0.15A, 3V	F-21				
TW25N600CX	AEG	25A, 600V, 0.15A, 3V	F-23				
TW25N700CT	AEG	40A, 700V, 0.15A, 3V	F-21				
TW25N700CX	AEG	25A, 700V, 0.15A, 3V	F-23				
TW25N800CT	AEG	40A, 800V, 0.15A, 3V	F-21				
TW25N800CX	AEG	25A, 800V, 0.15A, 3V	F-23				
TW25N900CT	AEG	40A, 900V, 0.15A, 3V	F-21				
TW25N900CX	AEG	25A, 900V, 0.15A, 3V	F-23				
TW25N1000CT	AEG	40A, 1KV, 0.15A, 3V	F-21				
TW25N1000CX	AEG	25A, 1KV, 0.15A, 3V	F-23				
TW25N1100CT	AEG	40A, 1.1KV, 0.15A, 3V	F-21				
TW25N1100CX	AEG	25A, 1.1KV, 0.15A, 3V	F-23				
TX1150N3600	AEG	1.1KA, 3.6KV, 0.25A, 2V	C-19			 图 F-23	
TX1150N3800	AEG	1.1KA, 3.8KV, 0.25A, 2V	C-19				
TX1150N4000	AEG	1.1KA, 4KV, 0.25A, 2V	C-19				
TX1150N4200	AEG	1.1KA, 4.2KV, 0.25A, 2V	C-19				
TX1150N4400	AEG	1.1KA, 4.4KV, 0.25A, 2V	C-19				
TX1350N3000	AEG	1.4KA, 3KV, 0.25A, 2V	C-19				
TX1350N3200	AEG	1.4KA, 3.2KV, 0.25A, 2V	C-19				
TX1350N3400	AEG	1.4KA, 3.4KV, 0.25A, 2V	C-19				
TX1350N3600	AEG	1.4KA, 3.6KV, 0.25A, 2V	C-19				
							 图 C-19



器件型号 Element type	厂名 Manufacturers	材料用途参数 Material Purpose Parameter	图号 Figure	国内外相似替换器件型号 Replace of similar type	备注 Notes	外形参考图 Reference shape
TX1650N2000	AEG	1.7kA, 2kV, 0.25A, 2V	C-19			
TX1650N2200	AEG	1.7kA, 2.2kV, 0.25A, 2V	C-19			
TX1650N2400	AEG	1.7kA, 2.4kV, 0.25A, 2V	C-19			
TX1650N2600	AEG	1.7kA, 2.6kV, 0.25A, 2V	C-19			
TX1650N2800	AEG	1.7kA, 2.8kV, 0.25A, 2V	C-19			
TX1900N1200	AEG	1.9kA, 1.2kV, 0.25A, 2V	H-9			
TX1900N1400	AEG	1.9kA, 1.4kV, 0.25A, 2V	C-19			
TX1900N1600	AEG	1.9kA, 1.6kV, 0.25A, 2V	C-19			
TX1900N1800	AEG	1.9kA, 1.8kV, 0.25A, 2V	C-19			
TX2200N3600	AEG	2.2kA, 3.6kV, 0.4A, 2V	C-9			
TX2200N3800	AEG	2.2kA, 3.8kV, 0.4A, 2V	C-9			
TX2200N4000	AEG	2.2kA, 4kV, 0.4A, 2V	C-9			
TX2200N4200	AEG	2.2kA, 4.2kV, 0.4A, 2V	C-9			
TX2200N4400	AEG	2.2kA, 4.4kV, 0.4A, 2V	C-9			
TXAL116B	Triac	6A, 200V, 0.05A	B-11	TAG425-200, TAG451-200, TAG456-200		
TXAL116C	Triac	6A, 200V, 0.06A	B-11	TAG425 200, TAG451-200, TAG456-200		
TXAL116M	Triac	6A, 200V, 0.1A	B-11	TAG425-200, TAG451-200, TAG456-200		
TXAL118B	Triac	8A, 200V, 0.05A	B-11	TAG425-200, TAG451-200, TAG456-200		
TXAL118C	Triac	8A, 200V, 0.06A	B-11	TAG425-200, TAG451-200, TAG456-200		
TXAL118M	Triac	8A, 200V, 0.1A	B-11	TAG425-200, TAG451-200, TAG456-200		
TXAL226B	Triac	6A, 400V, 0.05A	B-11	TAG425-400, TAG451-400, TAG456-400		
TXAL226C	Triac	6A, 400V, 0.06A	B-11	TAG425-400, TAG451-400, TAG456-400		
TXAL226M	Triac	6A, 400V, 0.1A	B-11	TAG425-400, TAG451-400, TAG456-400		

器件型号 Element type	厂名 Manufacturers	材料用途参数 Material Purpose Parameter	图号 Figure	国内外相似替换器件型号 Replace of similar type	备注 Notes	外形参考图 Reference shape
TXAL228B	Triac	8A, 400V, 0.05A	B-11	TAG425-400, TAG451-400, TAG456-400		
TXAL228C	Triac	8A, 400V, 0.06A	B-11	TAG425-400, TAG451-400, TAG456-400		
TXAL228M	Triac	8A, 400V, 0.1A	B-11	TAG425-400, TAG451-400, TAG456-400		
TXAL386B	Triac	6A, 700V, 0.05A	B-11	TAG425-700, TAG451-700, TAG456-700		
TXAL386C	Triac	6A, 700V, 0.06A	B-11	TAG425-700, TAG451-700, TAG456-700		
TXAL386M	Triac	6A, 700V, 0.1A	B-11	TAG425-700, TAG451-700, TAG456-700		
TXAL388B	Triac	8A, 200V, 0.05A	B-11	TAG425-200, TAG451-200, TAG456-200		
TXAL388C	Triac	8A, 200V, 0.06A	B-11	TAG425-200, TAG451-200, TAG456-200		
TXAL388M	Triac	8A, 200V, 0.1A	B-11	TAG425-200, TAG451-200, TAG456-200		
TXAL1110B	Triac	10A, 200V, 0.05A	B-11	TAG456-200, TAG480-200, TAG481-200		
TXAL1110C	Triac	10A, 200V, 0.06A	B-11	TAG456-200, TAG480-200, TAG481-200		
TXAL1110M	Triac	10A, 200V, 0.1A	B-11	TAG456-200, TAG480-200, TAG481-200		
TXAL1115B	Triac	15A, 200V, 0.05A	B-11	MAC15-4, TIC246B, T6001B		
TXAL1115M	Triac	15A, 200V, 0.1A	B-11	MAC15-4, TIC246B, T6001B		
TXAL2220B	Triac	10A, 400V, 0.05A	B-11	TAG456-400, TAG480-400, TAG481-400		
TXAL2220C	Triac	10A, 400V, 0.06A	B-11	TAG456-400, TAG480-400, TAG481-400		
TXAL2220M	Triac	10A, 400V, 0.1A	B-11	TAG456-400, TAG480-400, TAG481-400		
TXAL2225B	Triac	15A, 400V, 0.05A	B-11	MAC15-6, TIC246D, T6001D		
TXAL2225M	Triac	15A, 400V, 0.1A	B-11	MAC15-6, TIC246D, T6001D		
TXAL3810B	Triac	10A, 700V, 0.05A	B-11	TAG456-700, TAG480-700, TAG481-700		
TXAL3810C	Triac	10A, 700V, 0.06A	B-11	TAG456-700, TAG480-700, TAG481-700		
TXAL3810M	Triac	10A, 700V, 0.1A	B-11	TAG456-700, TAG480-700, TAG481-700		

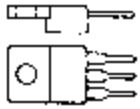
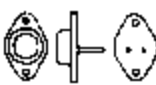

器件型号 Element type	厂名 Manufacturers	材料用途参数 Material Purpose Parameter	图号 Figure	国内外相似替换器件型号 Replace of similar type	备注 Notes	外形参考图 Reference shape
TXAL3815B	Triac	15A, 700V, 0.05A	B-11	MAC15-9, TIC246N, T6001N		 图 B-11
TXAL3815M	Triac	15A, 700V, 0.1A	B-11	MAC15-9, TIC246N, T6001N		
TXC01A10...60	Triac	7.5A, 100-600V, 0.075A	D-9	TAG260-100...600, TAG265-100...600, T4700A...		 图 D-9
TXC01B10...60	Triac	7.5A, 100-600V, 0.075A	D-9	TAG260-100...600, TAG265-100...600, T4700A...		
TXC01C10...60	Triac	7.5A, 100-600V, 0.05A	D-9	MAC222-100...600, TAG260 100...600, TAG265-100...600		
TXC01D10...60	Triac	7.5A, 100-600V, 0.05A	D-9	MAC222-100...600, TAG260-100...600, TAG265-100...600		
TXC01E10...60	Triac	7.5A, 100-600V, 0.015A	D-9	TAG226-100...600, TAG261-100...600, TAG266-100...600		
TXC01F10...60	Triac	7.5A, 100-600V, 0.015A	D-9	TAG226-100...600, TAG261-100...600, TAG266-100...600		
TXC02A10...60	Triac	3A, 100-600V, 0.075A, 0.08A		BT136/..., TAG250-100...600, TXC10L ...		
TXC02B10...60	Triac	3A, 100-600V, 0.075A		BT136/..., TAG250-100...600, TXC10L ...		
TXC02C10...60	Triac	3A, 100-600V, 0.05A		TAG216..., TAG230-100...600, TAG10K...		
TXC02D10...60	Triac	3A, 100-600V, 0.05A		TAG216..., TAG230-100...600, TAG10K...		
TXC02E10...60	Triac	3A, 100-600V, 0.015A		TAG97-100...600, TAG137-100...600, TIC206A...		
TXC02F10...60	Triac	3A, 100-600V, 0.015A, 0.02A		TAG97-100...600, TAG137-100...600, TIC206A...		
TXC03A10...60	Triac	1A, 100-600V, 0.075A	B-108	TAG250-100...600, TXC10L..., TXC30L ...		 图 B-108
TXC03B10...60	Triac	1A, 100-600V, 0.075A	B-108	TAG250-100...600, TXC10L..., TXC30L ...		
TXC03C10...60	Triac	1A, 100-600V, 0.05A	B-108	TAG230-100...600, TXC10K..., TXC30K ...		
TXC03D10...60	Triac	1A, 100-600V, 0.05A	B-108	TAG230-100, TXC10K..., TXC30K...		
TXC03E10...60	Triac	1A, 100-600V, 0.015A	B-108	TAG201-100...600, T2302..., TXC38H..., TXC38G...		
TXC03F10...60	Triac	1A, 100-600V, 0.015A, 0.02A	B-108	TAG201-100...600, T2302A...M, TXC38H..., TXC38G...		

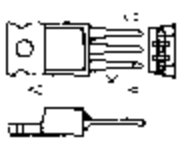

器件型号 Element type	厂名 Manufacturers	材料用途参数 Material Purpose Parameter	图号 Figure	国内外相似替换器件型号 Replace of similar type	备注 Notes	外形参考图 Reference shape
TXC10H40	SIE	Triac 4A, 400V, 0.025A, 2V	B-91	TAG230-400, T2500D, T2800D		 图 B-91
TXC10H40M	SIE	Triac 6A, 400V, 0.025A, 2V	B-91	MAC222A6, TAG224-400, T2500D, T2800D		
TXC10H50	SIE	Triac 4A, 500V, 0.025A, 2V	B-11	BT136-500, TAG230-500, T2500E, T2800E		
TXC10H50M	SIE	Triac 6A, 500V, 0.025A, 2V	B-11	MAC222A7, TAG224-500, T2500E, T2800E		
TXC10H60	SIE	Triac 4A, 600V, 0.025A, 2V	B-91	BT136-600, TAG230-600, T2500M, T2800M		
TXC10H60M	SIE	Triac 6A, 600V, 0.025A, 2V	B-91	MAC222A8, TAG224-600, T2500M, T2800M		
TXC10H70	SIE	Triac 4A, 700V, 0.025A, 2V	B-11	BT136-700, TAG230-700, T2500S, T2800S		
TXC10H70M	SIE	Triac 6A, 700V, 0.025A, 2V	B-11	MAC222A9, TAG224-700, T2500S, T2800S		
TXC10H80	SIE	Triac 4A, 800V, 0.025A, 2V	B-11	BT136-800, TAG230-800, T2500N, T2800N		
TXC10H80M	SIE	Triac 6A, 800V, 0.025A, 2V	B-11	MAC222A10, TAG224-800, T2500N, T2800N		
TXC10K40	SIE	Triac 4A, 400V, 0.05A, 2V	B-91	TAG230-400, T2500D, T2800D		
TXC10K40M	SIE	Triac 6A, 400V, 0.05A, 2V	B-91	MAC222A6, TAG224-400, T2500D, T2800D		
TXC10K50	SIE	Triac 4A, 500V, 0.05A, 2V	B-11	BT136-500, TAG230-500, T2500E, T2800E		
TXC10K50M	SIE	Triac 6A, 500V, 0.05A, 2V	B-11	MAC222A7, TAG224-500, T2500E, T2800E		
TXC10K60	SIE	Triac 4A, 600V, 0.05A, 2V	B-91	BT136-600, TAG230-600, T2500M, T2800M		
TXC10K60M	SIE	Triac 6A, 600V, 0.05A, 2V	B-91	MAC222A8, TAG224-600, T2500M, T2800M		
TXC10K70	SIE	Triac 4A, 700V, 0.05A, 2V	B-11	BT136-700, TAG230-700, T2500S, T2800S		
TXC10K70M	SIE	Triac 6A, 700V, 0.05A, 2V	B-11	MAC222A9, TAG224-700, T2500S, T2800S		
TXC10K80	SIE	Triac 4A, 800V, 0.05A, 2V	B-91	BT136-800, TAG230-800, T2500N, T2800N		
TXC10K80M	SIE	Triac 6A, 800V, 0.05A, 2V	B-91	MAC222A10, TAG224-800, T2500N, T2800N		
TXC10L40	SIE	Triac 4A, 400V, 0.075A, 2V	B-11	TAG250-400, T2500D, T2800D		
TXC10L40M	SIE	Triac 6A, 400V, 0.075A, 2V	B-11	MAC222A6, TAG250-400, T2500D, T2800D		
TXC10L50	SIE	Triac 4A, 500V, 0.075A, 2V	B-11	BT136-500, TAG224-500, TAG250-500, T2500E, T2800E		
TXC10L50M	SIE	Triac 6A, 500V, 0.075A, 2V	B-11	MAC222A7, TAG224-500, TAG250-500, T2500E, T2800E		
TXC10L60	SIE	Triac 4A, 600V, 0.075A, 2V	B-91	BT136-600, TAG224-600, TAG250-600, T2500M, T2800M		

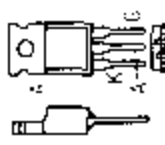
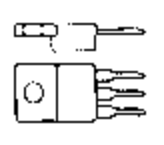

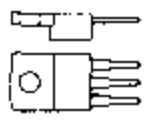
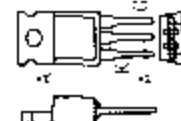
器件型号 Element type	厂名 Manufacturers	材料用途参数 Material Purpose Parameter	图号 Figure	国内外相似替换器件型号 Rcplace of similar type	备注 Notes	外形参考图 Reference shape
TXC10L60M	SIE	Triac 6A, 600V, 0.075A, 2V	B-91	MAC222A8, TAG224-600, TAG250-600, T2500M, T2800M		 图 B-91
TXC10L70	SIE	Triac 4A, 700V, 0.075A, 2V	B-11	BT136-700, TAG224-700, TAG250-700, T2500S, T2800S		
TXC10L70M	SIE	Triac 6A, 700V, 0.075A, 2V	B-11	MAC222A9, TAG224-700, TAG250-700, T2500S, T2800S		
TXC10L80	SIE	Triac 4A, 800V, 0.075A, 2V	B-11	BT136-800, TAG224-800, TAG250-800, T2500N, T2800N		
TXC10L80M	SIE	Triac 6A, 800V, 0.075A, 2V	B-11	MAC222A10, TAG224-800, TAG250-800, T2500N, T2800N		
TXC18D40	SIE	Triac 4A, 400V, 0.005A, 0.02A	B-11	TAG222-400, TAG227-400, TAG233-400, TXC18D40M		 图 B-11
TXC18D40M	SIE	Triac 6A, 400V, 0.005A, 0.02A	B-11	TAG222-400, TAG227-400		
TXC18D50	SIE	Triac 4A, 500V, 0.005A, 0.02A	B-11	TAG222-500, TAG227-500, TAG233-500, TXC18D50M		
TXC18D50M	SIE	Triac 6A, 500V, 0.005A, 0.02A	B-11	TAG222-500, TAG227-500		
TXC18D60	SIE	Triac 4A, 600V, 0.005A, 0.02A	B-11	TAG222-600, TAG227-600, TAG233-600, TXC18D60M		
TXC18D60M	SIE	Triac 6A, 600V, 0.005A, 0.02A	B-11	TAG222-600, TAG227-600		
TXC18D70	SIE	Triac 4A, 700V, 0.005A, 0.02A	B-11	TAG222-700, TAG227-700, TAG233-700, TXC18D70M		
TXC18D70M	SIE	Triac 6A, 700V, 0.005A, 0.02A	B-11	TAG222-700, TAG227-700		
TXC18D80	SIE	Triac 4A, 800V, 0.005A, 0.02A	B-11	TAG222-800, TAG227-800, TAG233-800, TXC18D80M		
TXC18D80M	SIE	Triac 6A, 800V, 0.005A, 0.02A	B-11	TAG222-800, TAG227-800		
TXC18E40	SIE	Triac 4A, 400V, 0.005A, 2V	B-91	MAC22B-6, TAG223-400, TIC225-400, TXC18E40M		
TXC18E40M	SIE	Triac 6A, 400V, 0.005A, 2V	B-91	MAC22B-6, TAG222-400, TIC225-400, TXC18D40M		
TXC18E50	SIE	Triac 4A, 500V, 0.005A, 2V	B-11	MAC22B-7, TAG223-500, TIC225-500, TXC18E50M		

器件型号 Element type	厂名 Manufacturers	材料用途参数 Material Purpose Parameter	图号 Figure	国内外相似替换器件型号 Replace of similar type	备注 Notes	外形参考图 Reference shape
TXC18E50M	SIE	Triac 6A, 500V, 0.005A, 2V	B-11	MAC228-7, TAG222-500, TIC225-500, TXC18D50M		 图 B-11
TXC18E60	SIE	Triac 4A, 600V, 0.005A, 2V	B-91	MAC228-8, IAG223-600, TIC225-600, TXC18E60M		
TXC18E60M	SIE	Triac 6A, 600V, 0.005A, 2V	B-11	MAC228-8, TAG222-600, TIC225-600, TXC18D60M		
TXC18E70	SIE	Triac 4A, 700V, 0.005A, 2V	B-11	MAC228-9, TAG223-700, TIC225-700, TXC18E70M		
TXC18E70M	SIE	Triac 6A, 700V, 0.005A, 2V	B-11	MAC228-9, TAG222-700, TIC225-700, TXC18D70M		 图 B-91
TXC18E80	SIE	Triac 4A, 800V, 0.005A, 2V	B-11	MAC228-10, TAG223-800, TIC225-800		
TXC18E80M	SIE	Triac 6A, 800V, 0.005A, 2V	B-11	MAC228-10, TAG222-800, TIC225-800		
TXC18G40	SIE	Triac 4A, 400V, 0.01A, 2V	B-11	TAG221-400, TAG226-400, TAG232-400, TXC18G40M		
TXC18G40M	SIE	Triac 6A, 400V, 0.01A, 2V	B-11	MAC228A6, TAG221-400, IAG226-400		
TXC18G50	SIE	Triac 4A, 500V, 0.01A, 2V	B-11	TAG221-500, TAG226-500, TAG232-500, TXC18G50M		
TXC18G50M	SIE	Triac 6A, 500V, 0.01A, 2V	B-11	MAC228A7, TAG221-500, TAG226-500		
TXC18G60	SIE	Triac 4A, 600V, 0.01A, 2V	B-91	TAG221-600, TAG226-600, TAG232-600, TXC18G60M		
TXC18G60M	SIE	Triac 6A, 600V, 0.01A, 2V	B-91	MAC228A8, TAG221-600, TAG226-600		
TXC18G70	SIE	Triac 4A, 700V, 0.01A, 2V	B-91	TAG221-700, TAG226-700, TAG232-700, TXC18G70M		
TXC18G70M	SIE	Triac 6A, 700V, 0.01A, 2V	B-91	MAC228A9, TAG221-700, TAG226-700		
TXC18G80	SIE	Triac 4A, 800V, 0.01A, 2V	B-91	TAG221-800, TAG226-800, TAG232-800, TXC18G80M		
IXC18G80M	SIE	Triac 6A, 800V, 0.01A, 2V	B-11	MAC228A10, TAG221-800, TAG226-800		
TXC18H40	SIE	Triac 4A, 400V, 0.01A, 2V	B-91	TAG232-400, TIC216D, TXC18H40M, TXC18G40		
TXC18H40M	SIE	Triac 6A, 400V, 0.01A, 2V	B-91	TAG221-400, TAG226-400, TIC216D, TXC18G40M		
TXC18H50	SIE	Triac 4A, 500V, 0.01A, 2V	B-11	TAG232-500, TIC216E, TXC18H50M, TXC18G50		
TXC18H50M	SIE	Triac 6A, 500V, 0.01A, 2V	B-11	TAG221-500, TAG226-500, TIC216E, TXC18G50M		
TXC18H60	SIE	Triac 4A, 600V, 0.01A, 2V	B-91	TAG232-600, TIC216M, TXC18H60M, TXC18G60		
TXC18H60M	SIE	Triac 6A, 600V, 0.01A, 2V	B-91	TAG221-600, TAG226-600, TIC216M, TXC18G60M		
TXC18H70	SIE	Triac 4A, 700V, 0.01A, 2V	B-11	TAG232-700, TIC216S, TXC18H70M, TXC18G70		

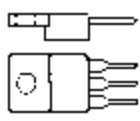
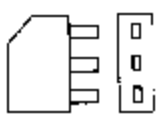

器件型号 Element type	厂名 Manufacturers	材料用途参数 Material Purpose Parameter	图号 Figure	国内外相似替换器件型号 Replace of similar type	备注 Notes	外形参考图 Reference shape
TXC18H70M	SIE	Triac 6A, 700V, 0.01A, 2V	B-11	TAG221-700, TAG226-700, TIC216S, TXC18G70M		 图 B-11
TXC18H80	SIE	Triac 4A, 800V, 0.01A, 2V	B-11	TAG232-800, TIC216N, TXC18H80M, TXC18G80		
TXC18H80M	SIE	Triac 6A, 800V, 0.01A, 2V	B-11	TAG221-800, TAG226-800, TIC216N, TXC18G80M		
TXC30H40...80		Triac 1A, 400-800V, 0.025A	B-108	TAG220..., TAG231..., T2323..., ZD410...		 图 B-108
TXC30J40...80		Triac 1A, 400-800V, 0.025A	B-108	TAG220..., TAG231..., T2323..., ZD410...		
TXC30K40...80		Triac 1A, 400-800V, 0.05A	B-108	MAC222..., TIC226..., TW7N..., TXC10K...		
TXC30L40...80		Triac 1A, 400-800V, 0.075A	B-108	TAG250..., TIC226..., TW7N..., TXC10L...		
TXC30M40...80		Triac 1A, 400-800V, 0.05A	B-108	MAC222..., TIC226..., TW7N..., TXC10K...		
TXC30P40...80		Triac 1A, 400-800V, 0.075A	B-108	TAG250..., TIC226..., TW7N..., TXC10L...		
TXC31H40...80		Triac 2.5A, 400-800V, 0.025A		TAG220..., TAG231..., T2323..., ZD410...		
TXC31J40...80		Triac 2.5A, 400-800V, 0.025A		TAG220..., TAG231..., T2323..., ZD410...		
TXC31K40...80		Triac 2.5A, 400-800V, 0.05A		MAC222..., TIC226..., TW7N4..., TXC10K...		
TXC31L40...80		Triac 2.5A, 400-800V, 0.075A		TAG250..., TW7N..., TXCD10L..., TXC10L...		
TXC31M40...80		Triac 2.5A, 400-800V, 0.05A		MAC222..., TIC226..., TW7N..., TXC10K...		
TXC31P40...80		Triac 2.5A, 400-800V, 0.075A		TAG250..., TW7N..., TXCD10L..., TXC10L...		
TXC38D40...80		Triac 1A, 400-800V, 0.005A	B-108	TAG222..., TAG233..., TXC18D..., T2301...		 图 B-91
TXC38E40...80		Triac 1A, 400-800V, 0.005A	B-108	TXC18E..., TXC38D..., T2301..., ZD104...		
TXC38G40...80		Triac 1A, 400-800V, 0.01A	B-108	TAG232..., TXC18G..., T2302..., ZD106...		
TXC38H40...80		Triac 1A, 400-800V, 0.01A	B-108	TXC18H..., TXC38G..., T2302..., ZD106...		
TXC39D40...80		Triac 2.5A, 400-800V, 0.005A		TXC18D..., T2301..., T2327..., ZD405...		
TXC39E40...80		Triac 2.5A, 400-800V, 0.005A		TXC18D..., TXC39D..., T2327..., ZD405...		
TXC39G40...80		Triac 2.5A, 400-800V, 0.01A		TXC18G..., T2302..., ZD106..., ZD409...		
TXC39H40...80		Triac 2.5A, 400-800V, 0.01A		TXC18H40, TXC39G40, T2302D, ZD106DA, ZD106DB		
TXC1040	SIE	4A, 400V, 0.025A	B-91			
TXC1040M	SIE	6A, 400V, 0.025A	B-91			

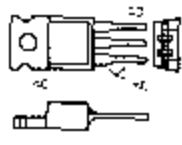
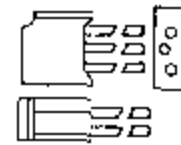

器件型号 Element type	厂名 Manufacturers	材料用途参数 Material Purpose Parameter	图号 Figure	国内外相似替换器件型号 Replace of similar type	备注 Notes	外形参考图 Reference shape
TXC1050	SIE	4A, 500V, 0.05A	B-91			 图 B-91
TXC1050M	SIE	6A, 500V, 0.05A	B-91			
TXC1060	SIE	4A, 600V, 0.075A	B-91			
TXC1060M	SIE	6A, 600V, 0.075A	B-91			
TXC1070	SIE	4A, 700V, 0.075A	B-91			
TXC1070M	SIE	6A, 700V, 0.075A	B-91			
TXC1080	SIE	4A, 800V, 0.075A	B-91			
TXC1080M	SIE	6A, 800V, 0.075A	B-91			
TXC1840	SIE	4A, 400V, 0.005A	B-91			
TXC1840M	SIE	6A, 400V, 0.005A	B-91			
TXC1850M	SIE	6A, 500V, 0.005A	B-91			
TXC1860	SIE	4A, 600V, 0.01A	B-91			
TXC1860M	SIE	6A, 600V, 0.01A	B-91			
TXC1870	SIE	4A, 700V, 0.01A	B-91			
TXC1870M	SIE	6A, 700V, 0.01A	B-91			
TXC1880	SIE	4A, 800V, 0.01A	B-91			
TXC3040	SIE	1A, 400V, 0.025A	B-30			 图 B-30
TXC3050	SIE	1A, 500V, 0.05A	B-30			
TXC3060	SIE	1A, 600V, 0.075A	B-30			
TXC3070	SIE	1A, 700V, 0.075A	B-30			
TXC3080	SIE	4A, 800V, 0.075A	B-30			
TXC3840	SIE	1A, 400V, 0.005A	B-30			
TXC3860	SIE	1A, 600V, 0.01A	B-30			
TXC3870	SIF	1A, 700V, 0.01A	B-30			
TXC3880	SIE	4A, 800V, 0.01A	B-30			

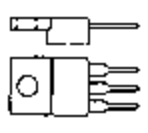

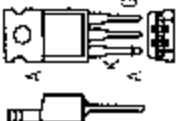

器件型号 Element type	厂名 Manufacturers	材料用途参数 Material Purpose Parameter	图号 Figure	国内外相似替换器件型号 Replace of similar type	备注 Notes	外形参考图 Reference shape
TXD10H40	SIE	Triac 8A, 400V, 0.05A, 2V	B-11	MAC222A6, TAG224-400		 图 B-11
TXD10H40M	SIE	Triac 10A, 400V, 0.05A, 2V	B-11	MAC15A4, TAG251-400, TAG255-400		
TXD10H40P	SIE	Triac 12A, 400V, 0.05A, 2V	B-11	MAC15A4, TAG255-400, TAG256-400		
TXD10H50	SIE	Triac 8A, 500V, 0.05A, 2V	B-11	BT137-500, MAC222A7, TAG224-500		
TXD10H50M	SIE	Triac 10A, 500V, 0.05A, 2V	B-11	BT138-600, MAC15A6, TAG251-500, TAG255-500		
TXD10H50P	SIE	Triac 12A, 500V, 0.05A, 2V	B-11	BT138-500, MAC15A6, TAG255-500, TAG256-500		
TXD10H60	SIE	Triac 8A, 600V, 0.025A, 2V	B-91	BT137-600, MAC222A6, TAG224-500		
TXD10H60M	SIE	Triac 10A, 600V, 0.025A, 2V	B-91	BT138 600, MAC15A8, TAG251-600, TAG255-600		
TXD10H60P	SIE	Triac 12A, 600V, 0.025A, 2V	B-91	BT138-600, MAC15A8, TAG255-600, TAG256-600		
TXD10H70	SIE	Triac 8A, 700V, 0.025A, 2V	B-91	BT137-700, MAC222A9, TAG224-700		
TXD10H70M	SIE	Triac 10A, 700V, 0.025A, 2V	B-91	BT138-700, MAC15A10, TAG251-700, TAG255-700		
TXD10H70P	SIE	Triac 12A, 700V, 0.025A, 2V	B-91	BT138-700, MAC15A10, TAG255-700, TAG256-700		
TXD10H80	SIE	Triac 8A, 800V, 0.05A, 2V	B-11	BT137-800, MAC222A10, TAG224-800		
TXD10H80M	SIE	Triac 10A, 800V, 0.05A, 2V	B-11	BT138-800, MAC15A10, TAG251-800, TAG255-800		
TXD10H80P	SIE	Triac 12A, 800V, 0.05A, 2V	B-11	BT138-800, MAC15A10, TAG255-800, TAG256-800		
TXD10K40		Triac 8A, 400V, 0.05A, 2V	B-11	MAC222-6, TIC226D, 2N6342, 2N6343, 2N6344, 2N6345		
TXD10K40M		Triac 10A, 400V, 0.05A, 2V	B-91	TIC236D, TW9N400FZ, TW11N400FZ, T6001D		
TXD10K40P		Triac 12A, 400V, 0.05A, 2V	B-91	TIC236D, TW11N, 2N6342A, 2N6343A, 2N6344A, 2N6345A		
TXD10K40R		Triac 15A, 400V, 0.05A, 2.3V	B-91			
TXD10K50		Triac 8A, 500V, 0.05A, 2V	B-11	MAC222-7, TIC226E, 2N6342, 2N6343, 2N6344, 2N6345		
TXD10K50M		Triac 10A, 500V, 0.05A, 2V	B-91	TIC236E, TW9N500FZ, TW11N500FZ, T6001E		
TXD10K50P		Triac 12A, 500V, 0.05A, 2V	B-11	TIC236E, TW11N, 2N6342A, 2N6343A, 2N6344A, 2N6345A		
TXD10K60		Triac 8A, 600V, 0.05A, 2V	B-91	MAC222-8, TIC226M, 2N6342, 2N6343, 2N6344, 2N6345		

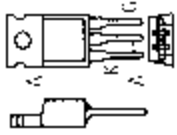
器件型号 Element type	厂名 Manufacturers	材料用途参数 Material Purpose Parameter	图号 Figure	国内外相似替换器件型号 Replace of similar type	备注 Notes	外形参考图 Reference shape
TXD10K60M		Triac 10A, 600V, 0.05A, 2V	B-91	TIC236M, TW9N600FZ, TW11N600FZ, T6001M		 图 B-91
TXD10K60P		Triac 12A, 600V, 0.05A, 2V	B-91	TIC236M, TW11N, 2N6342A, 2N6343A, 2N6344A, 2N6345A		
TXD10K60R	SIE	Triac 15A, 600V, 0.05A, 2V	B-91	MAC222-9, TIC226S, 2N6342, 2N6343, 2N6344, 2N6345		
TXD10K70M		Triac 10A, 700V, 0.05A, 2V	B-91	TIC236S, TW9N700FZ, TW11N700FZ, T6001S		
TXD10K70P		Triac 12A, 700V, 0.05A, 2V	B-91	TIC236S, TW11N, 2N6342A, 2N6343A, 2N6344A, 2N6345A		
TXD10K80		Triac 8A, 800V, 0.05A, 2V	B-91	MAC222-10, TIC226N, 2N6342, 2N6343, 2N6344, 2N6345		
TXD10K80M		Triac 10A, 800V, 0.05A, 2V	B-91	TIC236N, TW9N800FZ, TW11N800FZ, T6001N		
TXD10K80P		Triac 12A, 800V, 0.05A, 2V	B-91	TIC236N, TW11N, 2N6342A, 2N6343A, 2N6344A, 2N6345A		
TXD10K80R	SIE	Triac 15A, 800V, 0.05A, 2V	B-91	MAC222-6, TIC226D, 2N6342, 2N6343, 2N6344, 2N6345		
TXD10L40		Triac 8A, 400V, 0.075A, 2V	B-91	TIC236D, TXD10L40P, TW9N400FZ, TW11N400FZ		
TXD10L40M		Triac 10A, 400V, 0.075A, 2V	B-91	TIC236D, TW11N, 2N6342A, 2N6343A, 2N6344A, 2N6345A		
TXD10L40P		Triac 12A, 400V, 0.075A, 2V	B-91	MAC222-7, TIC226E, 2N6342, 2N6343, 2N6344, 2N6345		
TXD10L50		Triac 8A, 500V, 0.075A, 2V	B-11	TIC236E, TXD10L50P, TW9N500FZ, TW11N500FZ		
TXD10L50M		Triac 10A, 500V, 0.075A, 2V	B-11	TIC236E, TW11N, 2N6342A, 2N6343A, 2N6344A, 2N6345A		
TXD10L50P		Triac 12A, 500V, 0.075A, 2V	B-11	MAC222-8, TIC226M, 2N6342, 2N6343, 2N6344, 2N6345		
TXD10L60		Triac 8A, 600V, 0.075A, 2V	B-91	TIC236M, TXD10L60P, TW9N600FZ, TW11N600FZ		
TXD10L60M		Triac 10A, 600V, 0.075A, 2V	B-91			



器件型号 Element type	厂名 Manufacturers	材料用途参数 Material Purpose Parameter	图号 Figure	国内外相似替换器件型号 Replace of similar type	备注 Notes	外形参考图 Reference shape
TXD10L60P	Triac	12A, 600V, 0.075A, 2V	B-91	TIC236M, TW11N, 2N6342A, 2N6343A, 2N6344A, 2N6345A		 图 B-91
TXD10L70	Triac	8A, 700V, 0.075A, 2V	B-11	MAC222-y, TIC226S, 2N6342, 2N6343, 2N6344, 2N6345		
TXD10L70M	Triac	10A, 700V, 0.075A, 2V	B-91	TIC236S, TXD10L70P, TW9N700FZ, TW11N/00FZ		
TXD10L70P	Triac	12A, 700V, 0.075A, 2V	B-91	TIC236S, TW11N, 2N6342A, 2N6343A, 2N6344A, 2N6345A		
TXD10L80	Triac	8A, 800V, 0.075A, 2V	B-11	MAC222-10, TIC226N, 2N6342, 2N6343, 2N6344, 2N6345		
TXD10L80M	Triac	10A, 800V, 0.075A, 2V	B-11	TIC236N, TXD10L80P, TW9N800FZ, TW11N800FZ		
TXD10L80P	Triac	12A, 800V, 0.075A, 2V	B-11	TIC236N, TW11N, 2N6342A, 2N6343A, 2N6344A, 2N6345A		
TXD98A20...60	Triac	15A, 200-600V, 0.05A	F-55	SC250..., SC260..., TXE99A...		 图 B-11
TXD99A20...60	Triac	10A, 200-600V, 0.05A	F-55	BS10..., SC245..., SC250...		
TXD1040	SIE	8A, 400V, 0.025A	B-91			 图 F-55
TXD1040M	SIE	10A, 400V, 0.025A	B-91			
TXD1040P	SIE	12A, 400V, 0.025A	B-91			
TXD1050	SIE	8A, 500V, 0.05A	B-91			
TXD1050M	SIE	10A, 500V, 0.05A	B-91			
TXD1050P	SIE	12A, 500V, 0.05A	B-91			
TXD1060	SIE	8A, 600V, 0.075A	B-91			
TXD1060M	SIE	10A, 600V, 0.075A	B-91			
TXD1060P	SIE	12A, 600V, 0.075A	B-91			
TXD1070	SIE	8A, 700V, 0.075A	B-91			
TXD1070M	SIE	10A, 700V, 0.075A	B-91			
TXD1070P	SIE	12A, 700V, 0.075A	B-91			
TXD1080	SIE	8A, 800V, 0.075A	B-91			

器件型号 Element type	厂名 Manufacturers	材料用途参数 Material Purpose Parameter	图号 Figure	国内外相似替换器件型号 Replace of similar type	备注 Notes	外形参考图 Reference shape
TXD1080M	SIE	10A, 800V, 0.075A	B-91			 图 B-91
TXDV208	SIE	8A, 200V, 0.05A, 2V	B-91	MAC222-4, TIC226B, T2802B		
TXDV212	SIE	12A, 200V, 0.1A, 2.5V	B-91	TIC236B		
TXDV408	SIE	8A, 400V, 0.05A, 2.5V	B-91	MAC222-6, TIC226D, T2802D		
TXDV412	SIE	12, 400V, 0.1A, 2.5V	B-91	TIC236D, TW11N400FZ, TXD10K/L40P		
IXDV608	SIE	8A, 600V, 0.05A, 2V	B-91	MAC222-8, TIC226M, T2802M		
TXDV612	SIE	12A, 600V, 0.1A, 2.5V	B-91	TIC236M, TW11N600FZ, TXD10K/L60P		
TXDV808	Triac	8A, 800V, 0.1A, 0.03A	B-11	MAC222 10, TIC226N, T2802N		
TXDV812	SIE	12A, 800V, 0.1A, 2.5V	B-91	TIC236N, TW11N800FZ, TXD10K/L80P		
TXE10L20	SIE	20A, 200V, 0.05A	B-91	MAC223-4, MAC223A4		
TXE10L30	Triac	20A, 300V, 0.05A	B-11	MAC223-5, MAC223A5		
TXE10L40	Triac	20A, 400V, 0.05A, 2.3V	B-91	MAC223-6, MAC223A6		
TXE10L50	Triac	20A, 500V, 0.05A	B-11	MAC223-7, MAC223A7		
TXE10L60	Triac	20A, 600V, 0.05A, 2.3V	B-91	MAC223-8, MAC223A8		
TXE10L70	Triac	20A, 700V, 0.05A	B-11	MAC223-9, MAC223A9		
TXE10L80	Triac	20A, 800V, 0.05A, 2.3V	B-91	MAC223-10, MAC223A10		 图 B-11
TXE99A20	Triac	25A, 200V, 0.05A, 0.075A	F-55	SC260B, T6410B, T6411B, 2N6160, 2N6161, 2N6162		
TXE99A30	Triac	25A, 300V, 0.05A, 0.075A	F-55	SC260D, T6410C, T6411C, 2N6160, 2N6161, 2N6162		
TXE99A40	Triac	25A, 400V, 0.05A, 0.075A	F-55	SC260D, T6410D, T6411D, 2N6160, 2N6161, 2N6162		
TXE99A50	Triac	25A, 500V, 0.05A, 0.075A	F-55	SC260M, T6410E, T6411E, 2N6160, 2N6161, 2N6162		
TXE99A60	Triac	25A, 600V, 0.05A, 0.075A	F-55	SC260M, T6410M, T6411M, 2N6160, 2N6161		 图 F-55
TXN054(A)	THE	4A, 50V, 0.015A, 1.5V	B-91			
TXN056(A)	THE	6A, 50V, 0.015A, 1.5V	B-91	TAG620-100, TIC116A		
TXN058(A)	THE	8A, 50V, 0.015A, 1.5V	B-91	S2800F, TAG660-100, TIC116A		

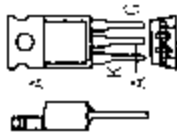
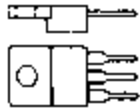

器件型号 Element type	厂名 Manufacturers	材料用途参数 Material Purpose Parameter	图号 Figure	国内外相似替换器件型号 Replace of similar type	备注 Notes	外形参考图 Reference shape
TXN104(A)	THE	4A, 100V, 0.015A, 1.5V	B-91			 图 B-91
TXN106(A)	THE	6A, 100V, 0.015A, 1.5V	B-91	CS6-02, TAG620-100, TIC116A		
TXN108(A)	THE	8A, 100V, 0.015A, 1.5V	B-91	S2800A, TAG660-100, TIC116A		
TXN110(A)	THE	10A, 100V, 0.015A, 1.5V	B-91			
TXN112(A)	THE	12A, 100V, 0.015A, 1.5V	B-91			
TXN204(A)	THE	4A, 200V, 0.015A, 1.5V	B-91			
TXN206(A)	THE	6A, 200V, 0.015A, 1.5V	B-91	CS6-2, TAG620-200, TIC116B		
TXN208(A)	THE	8A, 200V, 0.015A, 1.5V	B-91	S2800B, TAG660-200, TIC116E		
TXN210(A)	THE	10A, 200V, 0.015A, 1.5V	B-91			
TXN212(A)	THE	12A, 200V, 0.015A, 1.5V	B-91			
TXN404(A)	THE	4A, 400V, 0.015A, 1.5V	B-91			 图 B-11
TXN406(A)	THE	6A, 400V, 0.015A, 1.5V	B-91	CS6-04, TAG620-400, TIC116C		
TXN408(A)	THE	8A, 400V, 0.015A, 1.5V	B-91	S2800D, TAG660-400, TIC116C		
TXN410(A)	THE	10A, 400V, 0.015A, 1.5V	B-91			
TXN412(A)	THE	12A, 400V, 0.015A, 1.5V	B-91			
TXN0510		50Hz-Thy 10A, 50V, 0.015A, 1.5V	B-11	S2800F, TAG665-100, TIC126A		
TXN0510A	THE	10A, 50V, 0.015A, 1.5V	B-91			
TXN0610		50Hz-Thy 10A, 100V, 0.015A, 1.5V	B-11	S2800A, TAG665-100, TIC126A		
TXN0710		50Hz-Thy 10A, 200V, 0.015A, 1.5V	B-11	S2800B, TAG665-200, TIC126B		
TXN0810		50Hz-Thy 10A, 300V, 0.015A, 1.5V	B-11	S2800C, TAG665-300, TIC126C		
TXN0910		50Hz-Thy 10A, 400V, 0.015A, 1.5V	B-11	S2800D, TAG665-400, TIC126D		
TXN1010		50Hz-Thy 10A, 500V, 0.015A, 1.5V	B-11	S2800E, TAG665-500, TIC126E		
TXN0512		50Hz-Thy 12A, 50V, 0.015A, 1.5V	B-11	TAG680-100, TIC126A		
TXN0512A	THE	12A, 50V, 0.015A, 1.5V	B-91			
TXN0612		50Hz-Thy 12A, 100V, 0.015A, 1.5V	B-11	TAG680-100, TIC126A		

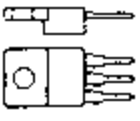
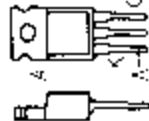
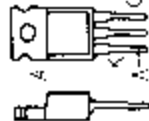
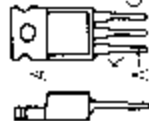
器件型号 Element type	厂名 Manufacturers	材料用途参数 Material Purpose Parameter	图号 Figure	国内外相似替换器件型号 Replace of similar type	备注 Notes	外形参考图 Reference shape
TXN0712		50Hz-Thy 12A, 200V, 0.015A, 1.5V	B-11	TAG680-200, TIC126B		 图 B-11
TXN0812		50Hz-Thy 12A, 300V, 0.015A, 1.5V	B-11	TAG680-300, TIC126C		
TXN0912		50Hz-Thy 12A, 400V, 0.015A, 1.5V	B-11	TAG680-400, TIC126D, T7.5N400FOB		
TXN1012		50Hz-Thy 12A, 500V, 0.015A, 1.5V	B-11	TAG680-500, TIC126E, T7.5N500FOB		
TXN0516		50Hz-Thy 16A, 50V, 0.025A, 1.5V	B-11	TAG680-100, TAG681-100		 图 B-91
TXN0604		50Hz-Thy 16A, 100V, 0.025A, 1.5V	B-11	TAG680-100, TAG681-100		
TXN604A	THE	4A, 600V, 0.015A, 1.5V	B-91	TAG680-200, IAG681-200		
TXN0606	THE	16A, 200V, 0.025A, 1.5V	B-11	TAG680-200, IAG681-200		
TXN606A	THE	6A, 600V, 0.015A, 1.5V	B-91	TAG680-200, IAG681-200		
TXN0608	THE	16A, 300V, 0.025A, 1.5V	B-11	TAG680-300, TAG681-300		
TXN608A	THE	8A, 600V, 0.015A, 1.5V	B-91	TAG680-300, TAG681-300		
TXN610A	THE	10A, 600V, 0.015A, 1.5V	B-91	TAG680-300, TAG681-300		
TXN0612	THE	16A, 400V, 0.025A, 1.5V	B-11	TAG680-400, TAG681-400, T9.5N400FOB		
TXN612A	THE	12A, 600V, 0.015A, 1.5V	B-91	TAG680-400, TAG681-400, T9.5N400FOB		
TXN0616		50Hz-Thy 16A, 500V, 0.025A, 1.5V	B-11	TAG680-500, TAG681-500, T9.5N500FOB		
TXN682		50Hz-Thy 2A, 50V, 0.025A, 1.5V	B-11			 图 B-91
TXN683		50Hz-Thy 2A, 100V, 0.025A, 1.5V	B-11			
TXN685		50Hz-Thy 2A, 200V, 0.025A, 1.5V	B-11	CS15-02go2		
TXN688		50Hz-Thy 2A, 400V, 0.025A, 1.5V	B-11	CS15-04go2		
TXN690		50Hz-Thy 2A, 600V, 0.025A, 1.5V	B-11	CS15-06go2		
TXN804(A)	THE	4A, 800V, 0.015A, 1.5V	B-91			 图 B-91
TXN806(A)	THE	6A, 800V, 0.015A, 1.5V	B-91			
TXN808	THE	8A, 800V, 0.015A, 1.5V	B-91			
TXN810(A)	THE	10A, 800V, 0.015A, 1.5V	B-91			
TXN812(A)	THE	12A, 800V, 0.015A, 1.5V	B-91			

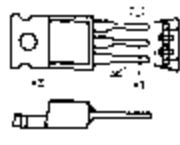

器件型号 Element type	厂名 Manufacturers	材料用途参数 Material Purpose Parameter	图号 Figure	国内外相似替换器件型号 Replace of similar type	备注 Notes	外形参考图 Reference shape
TXN1004(A)	THE	4A, 1kV, 0.015A, 1.5V	B-91			 图 B-91
TXN1006(A)	THE	6A, 1kV, 0.015A, 1.5V	B-91			
TXN1010	THE	10A, 1kV, 0.015A, 1.5V	B-91			
TXN1012(A)	THE	12A, 1kV, 0.015A, 1.5V	B-91			
TXS406-05(A)	THE	50H-Thy 4A, 50V, 200 μ A, 2V	B-91	TAG623-100, TAG633-100, TIC106A		
TXS406-2	THE	50H-Thy 4A, 200V, 200 μ A, 2V	B-91	TAG623-200, TAG633-200, TIC106B		
TXS406-4	THE	50H-Thy 4A, 400V, 200 μ A, 2V	B-91	TAG623-400, TAG633-400, TIC106D		
TXS406-6	THE	50H-Thy 4A, 600V, 200 μ A, 2V	B-91	TAG623-600, TAG633-600, TIC106M		
TXS406-8	THE	50H-Thy 4A, 800V, 200 μ A, 2V	B-91	TAG623-800, TAG633-800, TIC106N		
TXS407-05(A)	THE	50H-Thy 4A, 50V, 500 μ A, 2V	B-91	TAG623-100, TIC106A, TIC108A		
TXS407-2(A)	THE	50H-Thy 4A, 200V, 500 μ A, 2V	B-91	TAG623-200, TIC106B, TIC108B		
TXS407-4(A)	THE	50H-Thy 4A, 400V, 500 μ A, 2V	B-91	TAG623-400, TIC106D, TIC108D		
TXS407-6(A)	THE	50H-Thy 4A, 600V, 500 μ A, 2V	B-91	TAG623-600, TIC106M, TIC108M		
TXS407-8(A)	THE	50H-Thy 4A, 800V, 500 μ A, 2V	B-91	TAG623-800, TIC106N, TIC108N		
TXS606-05(A)	THE	50H Thy 6A, 50V, 200 μ A, 2V	B-91	S4060F, TAG623-100, TAG628-100		
TXS606-2(A)	THE	50H-Thy 6A, 200V, 500 μ A, 2V	B-91	S4060B, TAG623-200, TAG628-200		
TXS606-4(A)	THE	50H-Thy 6A, 400V, 500 μ A, 2V	B-91	S4060D, TAG623-400, TAG628-400		
TXS606-6(A)	THE	50H-Thy 6A, 600V, 500 μ A, 2V	B-91	S4060M, TAG623-600, TAG628-600		
TXS606-8(A)	THE	50H-Thy 6A, 800V, 500 μ A, 2V	B-91	S4060N, TAG623-800, TAG628-800		
TXS607-05(A)	THE	50H-Thy 6A, 50V, 500 μ A, 2V	B-91	S4060F, TAG623-100, TAG628-100		
TXS607-2(A)	THE	50H-Thy 6A, 200V, 500 μ A, 2V	B-91	S4060B, TAG623-200, TAG628-200		
TXS607-4(A)	THE	50H-Thy 6A, 400V, 500 μ A, 2V	B-91	S4060D, TAG623-400, TAG628-400		
TXS607-6(A)	THE	50H-Thy 6A, 600V, 500 μ A, 2V	B-91	S4060M, TAG623-600, TAG628-600		
TXS607-8(A)	THE	50H-Thy 6A, 800V, 500 μ A, 2V	B-91	S4060N, TAG623-800, TAG628-800		
TXS806-05(A)	THE	50H-Thy 8A, 50V, 200 μ A, 2V	B-91	S4060F, TAG628-100		
TXS806-1(A)	THE	50H-Thy 8A, 100V, 200 μ A, 2V	B-91	S4060A, TAG628-100		

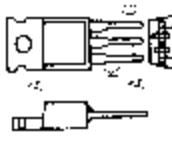
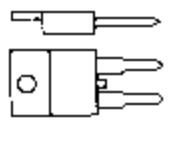
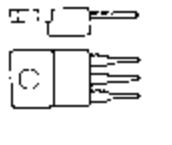
器件型号 Element type	厂名 Manufacturers	材料用途参数 Material Purpose Parameter	图号 Figure	国内外相似替换器件型号 Replace of similar type	备注 Notes	外形参考图 Reference shape
TXS806-2(A)	THE	50H-Thy 8A, 200V, 200 μ A, 2V	B-91	S4060B, TAG628-200		 图 B-91
TXS806-4(A)	THE	50H-Thy 8A, 400V, 200 μ A, 2V	B-91	S4060D, TAG628-400		
TXS806-6(A)	THE	50H Thy 8A, 600V, 200 μ A, 2V	B-91	S4060M, TAG628-600		
TXS806-8(A)	THE	50H-Thy 8A, 800V, 200 μ A, 2V	B-91	S4060N, TAG628-800		
TXS807-05(A)	IHE	50H-Thy 8A, 50V, 500 μ A, 2V	B-91	S4060F, TAG628-100		
TXS807-1(A)	THE	50H-Thy 8A, 100V, 500 μ A, 2V	B-91	S4060A, TAG628-100		
TXS807-2(A)	THE	50H-Thy 8A, 200V, 500 μ A, 2V	B-91	S4060B, TAG628-200		
TXS807-4(A)	THE	50H-Thy 8A, 400V, 500 μ A, 2V	B-91	S4060D, TAG628-400		
TXS807-6(A)	THE	50H-Thy 8A, 600V, 500 μ A, 2V	B-91	S4060M, TAG628-600		
TXS807-8(A)	THE	50H-Thy 8A, 800V, 500 μ A, 2V	B-91	S4060N, TAG628-800		
TXS1006 05(A)	THE	50H-Thy 10A, 50V, 200 μ A, 2V	B-91	S4060F		 图 B-9
TXS1006-1(A)	THE	50H-Thy 10A, 100V, 200 μ A, 2V	B-91	S4060A		
TXS1006-2(A)	THE	50H-Thy 10A, 200V, 200 μ A, 2V	B-91	S4060B		
TXS1006-4(A)	THE	50H-Thy 10A, 400V, 200 μ A, 2V	B-91	S4060D		
TXS1006-6(A)	THE	50H-Thy 10A, 600V, 200 μ A, 2V	B-91	S4060M		
TXS1006-8(A)	THE	50H-Thy 10A, 800V, 200 μ A, 2V	B-91	S4060N		
TXS1007-05(A)	THE	50H-Thy 10A, 50V, 200 μ A, 2V	B-91	S4060F		
TXS1007-1(A)	THE	50H-Thy 10A, 100V, 500 μ A, 2V	B-91	S4060A		
TXS1007-2(A)	THE	50H-Thy 10A, 200V, 500 μ A, 2V	B-91	S4060B		
TXS1007-4(A)	THE	50H-Thy 10A, 400V, 500 μ A, 2V	B-91	S4060D		
TXS1007-6(A)	THE	50H-Thy 10A, 600V, 500 μ A, 2V	B-91	S4060M		
TXS1007-8(A)	THE	50H-Thy 10A, 800V, 500 μ A, 2V	B-91	S4060N		 图 B-11
TY504		50H-Thy 4A, 50V, 0.015A	B-9	TYN054		
TY505F		SCR-H 5A, 50V, 0.04A, 3V	B-11	TYN505		
TY508		50H-Thy 8A, 50V, 0.015A	B-9	TYN058		
TY510		50H-Thy 10A, 50V, 0.015A	B-9	TYN0510		

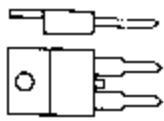
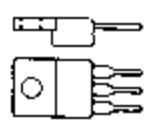
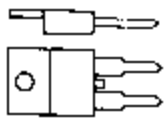
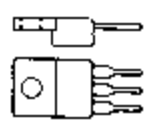
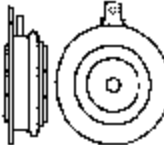
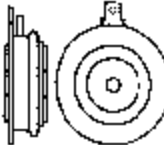

器件型号 Element type	厂名 Manufacturers	材料用途参数 Material Purpose Parameter	图号 Figure	国内外相似替换器件型号 Replace of similar type	备注 Notes	外形参考图 Reference shape
TY1004	50H-Thy	4A, 100V, 0.015A	B-9	TYN104		 图 B-9
TY1005F	SCR-H	5A, 100V, 0.04A, 1.5V	B-11	TYN1005		
TY1008	50H-Thy	8A, 100V, 0.015A	B-9	IYN108		
TY1010	50H-Thy	10A, 100V, 0.015A	B-9	TYN110		
TY2004	50H-Thy	4A, 200V, 0.015A	B-9	TYN204		 图 B-11
TY2005F	SCR-H	5A, 200V, 0.04A, 3V	B-11	TYN2005		
TY2008	50H-Thy	8A, 200V, 0.015A	B-9	TYN208		
TY2010	50H-Thy	10A, 200V, 0.015A	B-9	TYN210		
TY3004	50H-Thy	4A, 300V, 0.015A	B-9	TYN204		 图 B-9
TY3005F	SCR-H	5A, 300V, 0.04A, 3V	B-11	TYN3005		
TY3008	50H-Thy	8A, 300V, 0.015A	B-9	TYN208		
TY3010	50H-Thy	10A, 300V, 0.015A	B-9	TYN210		
TY4004	50H-Thy	4A, 400V, 0.015A	B-9	TYN404		 图 B-11
TY4005F	SCR-H	5A, 400V, 0.04A, 3V	B-11	TYF4005		
TY4008	50H-Thy	8A, 400V, 0.015A	B-9	TYN408		
TY4010	50H-Thy	10A, 400V, 0.015A	B-9	TYN410		
TY5004	50H-Thy	4A, 500V, 0.015A	B-9	TYN404		 图 C-10
TY5005F	SCR-H	5A, 500V, 0.04A, 1.5V	B-11	TYF5005		
TY5008	50H-Thy	8A, 500V, 0.015A	B-9	TYF408		
TY5010	50H-Thy	10A, 500V, 0.015A	B-9	TYN410		
TY6004	50H-Thy	8A, 600V, 0.015A	B-9	TYN604		 图 C-10
TY6005F	SCR-H	5A, 600V, 0.04A	B-11	TYF6005		
TY6008	50H-Thy	8A, 600V, 0.015A	B-9	TYN608		
TY6010	50H-Thy	10A, 600V, 0.015A	C-10	TYN610		

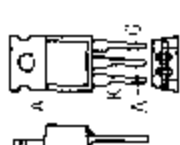
器件型号 Element type	厂名 Manufacturers	材料用途参数 Material Purpose Parameter	图号 Figure	国内外相似替换器件型号 Replace of similar type	备注 Notes	外形参考图 Reference shape
TY8006	THE	8A, 600V, 0.04A, 1.5V	B-91			 图 B-91
TYAL116B		Triac 6A, 200V, 0.05A	B-11	MAC222-4, TXC10KL40M, TW7N400FZ		
TYAL116C		Triac 6A, 220V, 0.06A	B-11	MAC222A-5, TAG224-330, TXC10H40M		
TYAL116M		Triac 6A, 220V, 0.1A	B-11	MAC222A-5, TAG224-330, TXC10H40M		
TYAL118B		Triac 8A, 200V, 0.05A	B-11	MAC222-4, TIC226B, T2802B, MAC222-4		
TYAL118C		Triac 8A, 200V, 0.06A	B-11	BT137-200, MAC222A-2, TAG224-200		
TYAL118M		Triac 8A, 300V, 0.1A	B-11	MAC222-5, TIC226C, T2802C		
TYAL226B		Triac 6A, 400V, 0.05A	B-11	MAC222-6, TW7N400FZ, TXC10KL40M		
TYAL226C		Triac 6A, 220V, 0.06A	B-11	MAC222A-5, TAG224-300, TXC10H40M		
TYAL226M		Triac 6A, 220V, 0.1A	B-11	MAC222A-5, TAG224-300, TXC10H40M		
TYAL228B		SCR-D 8A, 400V, 0.05A	B-11	MAC222-6		
TYAL228C		SCR-D 8A, 200V, 0.06A	B-11	T2800B		
TYAL228M		SCR-D 8A, 200V, 0.1A	B-11	MAC222-4, TIC226B, T2802B		
TYAL386B		Triac 6A, 700V, 0.05A	B-11	MAC222-9, TW7N700FZ, TXC10KL70M		
TYAL386C		Triac 6A, 220V, 0.06A	B-11	MAC222A-5, TAG224-300, TXC10H40M		
TYAL386M		Triac 6A, 220V, 0.1A	B-11	MAC222A-5, TAG224-300, TXC10H40M		
TYAL388B		SCR-D 8A, 200V, 0.05A	B-11	MAC222-4, TIC226B, T2802B		
TYAL388C		SCR-D 8A, 220V, 0.06A	B-11	MAC222-4, TIC226B, T2802B		
TYAL388M		SCR-D 8A, 220V, 0.1A	B-11	MAC222-4, TIC226B, T2802B		
TYAL1110B		SCR-D 10A, 200V, 0.05A	B-9	SC146B, TIC236B, TXD10KL20M		
TYAL1110C		Triac 10A, 200V, 0.06A	B-11	TAG250-200, TAG251-200		
TYAL1110M		SCR-D 10A, 200V, 0.1A	B-9	SC146B		
TYAL1115B		SCR-D 15A, 200V, 0.05A	B-9	MAC15-4, MAC15A4, TIC246B, T6001B		
TYAL1115M		SCR-D 15A, 200V, 0.1A	B-9	MAC15-4, TIC246B, T6001B		
TYAL2210B		SCR-D 10A, 400V, 0.05A	B-9	SC146D, TIC236D, TW9N400FZ, TXD10KL40M		



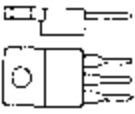
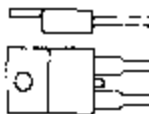
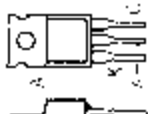
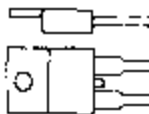
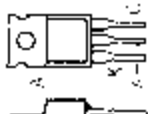

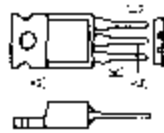
器件型号 Element type	厂名 Manufacturers	材料用途参数 Material Purpose Parameter	图号 Figure	国内外相似替换器件型号 Replace of similar type	备注 Notes	外形参考图 Reference shape
TYAL2210C	Triac	10A, 400V, 0.06A	B-11	TAG250 400, TAG251-400		 图 B-11
TYAL2210M	SCR-D	10A, 400V, 0.1A	B-9	SC146D, TIC246D, T6001D		
TYAL2215B	SCR-D	15A, 400V, 0.05A	B-9	MAC15-6, MAC15A6, TIC246D, T6001D		 图 B-9
TYAL2215M	SCR-D	15A, 400V, 0.1A	B-9	MAC15-6, TIC246D, T6001D		
TYAL3810B	Triac	10A, 700V, 0.05A	B-11	TIC236S, TW9N700FZ, TXD10K/L70M		 图 B-11
TYAL3810C	Triac	10A, 700V, 0.06A	B-11	BT138-800R, TAG250-700, TAG251-700		
TYAL3810M	Triac	10A, 700V, 0.1A	B-11	MAC15-9, TIC246S, T6001N		
TYAL3815B	Triac	15A, 700V, 0.05A	B-11	MAC15-9, TIC246S, T6001N		 图 B-9
TYAL3815M	Triac	15A, 700V, 0.1A	B-11	MAC15-9, TIC246S, T6001N		
TYF505	THE	SCR-H	B-91	S5800..., CSF11-...		 图 B-91
TYF508A	THE	SCR-H	B-91	CSF-...		
TYF1005	THE	SCR-H	B-91	S5800..., CSF11-...		
TYF2005	THF	SCR-H	B-91	CSF11-02er1, S5800B		
TYF2008A	THE	SCR-H	B-91	CSF11-02er1		
TYF3005	THE	SCR-H	B-91	CSF11-04er1, S5800D		
TYF4005	THE	SCR-H	B-91	CSF11-04er1, S5800D		
TYF4008A	THE	SCR-H	B-91	CSF11-04er1		
TYF5005	THE	SCR-H	B-91	CSF11-06er1, S5800E		
TYF6005	THE	SCR-H	B-91	CSF11 06er1, S5800E		
TYF6008A	THE	SCR-H	B-91	CSF11-06er1		
TYN054(A)	THE	50Hz-Thy	B-91	TAG620-100, TAG625-100, TAG630-100		
TYN056(A)	THE	50Hz-Thy	B-91	TAG620-100, TAG625-100, TIC116A		
TYN058	THE	50Hz-Thy	B-91	S2800A, TAG660-100, TIC116A		

器件型号 Element type	厂名 Manufacturers	材料用途参数 Material Purpose Parameter	图号 Figure	国内外相似替换器件型号 Replace of similar type	备注 Notes	外形参考图 Reference space
TYN104(A)	THE	50Hz-Thy 4A, 100V, 0.015A, 1.5V	B-91	TAG620-100, TAG625-100, TAG630-100		 图 B 91
TYN106(A)	THE	50Hz-Thy 6A, 100V, 0.015A, 1.5V	B-91	TAG620-100, TAG625-100, TIC116A		
TYN108	THE	50Hz-Thy 8A, 100V, 0.015A, 1.5V	B-91	S2800A, TAG660-100, TIC116A		
TYN110	THE	50Hz-Thy 10A, 100V, 0.015A, 0.03A	B-11	S2800A, TAG665-100, TIC126A		
TYN112(A)	THE	50Hz-Thy 12A, 100V, 0.015A, 1.5V	B-91	TAG680-100, TIC126A		
TYN116(A)	THE	50Hz-Thy 16A, 100V, 0.025A, 1.5V	B-91	TAG680-100, TAG681-100		
TYN204(A)	THE	50Hz-Thy 4A, 200V, 0.015A, 1.5V	B-91	TAG620-200, TAG625-200, TAG630-200		
TYN206(A)	THE	50Hz-Thy 6A, 200V, 0.015A, 1.5V	B-91	TAG620-200, TAG625-200, TIC116B		
TYN208	THE	50Hz-Thy 8A, 200V, 0.015A, 1.5V	B-91	CS6-02, S2800B, TAG660-200, TIC116B		
TYN210(A)	THE	50Hz-Thy 10A, 200V, 0.015A, 1.5V	B-91	S2800B, TAG665-200, TIC126B		
TYN212(A)	THE	50Hz-Thy 12A, 200V, 0.015A, 1.5V	B-91	TAG680-200, TIC126B		
TYN216(A)	THE	50Hz-Thy 16A, 200V, 0.025A, 1.5V	B-91	TAG680-200, TAG681-200		
TYN404(A)	THE	50Hz-Thy 4A, 400V, 0.015A, 1.5V	B-91	TAG620 400, TAG625-400, TAG630-400		
TYN406(A)	THE	50Hz-Thy 6A, 400V, 0.015A, 1.5V	B-91	TAG620-400, TAG625-400, TIC116D		
TYN408(A)	THE	50Hz-Thy 8A, 400V, 0.015A, 1.5V	B-91	CS6-04, S2800D, TAG660-400, TIC116D		
TYN410(A)	THE	50Hz-Thy 10A, 400V, 0.015A, 1.5V	B-91	S2800D, TAG665-400, TIC126D		
TYN412(A)	THE	50Hz-Thy 12A, 400V, 0.015A, 1.5V	B-91	TAG680-400, TIC126D, T7.5M400FOB		
TYN416(A)	THE	50Hz-Thy 16A, 400V, 0.025A, 1.5V	B-91	TAG680-400, TAG681-400, T9.5M400FOB		
TYN0510(A)	THE	50Hz-Thy 10A, 50V, 0.015A, 1.5V	B-91	S2800A, TAG665-100, TIC126A		
TYN0512(A)	THE	50Hz-Thy 12A, 50V, 0.015A, 1.5V	B-91	TAG680-100, TIC126A		
TYN0516(A)	THE	50Hz-Thy 16A, 50V, 0.025A, 1.5V	B-91	TAG680-100, TAG681-100		
TYN604(A)	THE	50Hz-Thy 4A, 600V, 0.015A, 1.5V	B-91	TAG620-600, TAG625-600, TAG630-600		
TYN606(A)	THE	50Hz-Thy 6A, 600V, 0.015A, 1.5V	B-91	TAG620-600, TAG625-600, TIC116M		

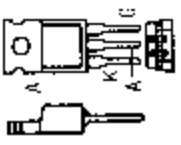
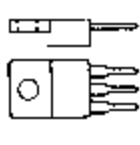

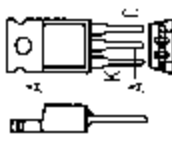
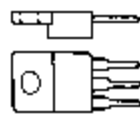
器件型号 Element type	厂名 Manufacturers	材料用途参数 Material Purpose Parameter	图号 Figure	国内外相似替换器件型号 Replace of similar type	备注 Notes	外形参考图 Reference shape
TYN608(A)	THE	50Hz-Thy 8A, 600V, 0.015A, 1.5V	B-91	CS6-06, S2800M, TAG660-600, TIC116M		 图 B-91
TYN612(A)	THE	50Hz-Thy 12A, 600V, 0.015A, 1.5V	B-91	TAG680-400, TIC126D, T7.5N400FOB		
TYN616(A)	THE	50Hz-Thy 16A, 600V, 0.025A, 1.5V	B-91	TAG680-400, TAG681-400, T9.5N400FOB		
TYN682(A)	THE	50Hz-Thy 25A, 50V, 0.025A, 1.5V	B-91			 图 B-11
TYN683(A)	THE	50Hz-Thy 25A, 100V, 0.025A, 1.5V	B-91	CS15-02go2		
TYN685(A)	THE	50Hz-Thy 25A, 200V, 0.025A, 1.5V	B-91	CS15-04go2		
TYN688(A)	THE	50Hz-Thy 25A, 400V, 0.025A, 1.5V	B-91	CS15-06go2		
TYN690(A)	THE	50Hz-Thy 25A, 600V, 0.025A, 1.5V	B-91			
TYN804(A)	THE	50Hz-Thy 4A, 800V, 0.015A, 1.5V	B-91	TAG620-800, TAG625-800, TAG630-800		
TYN806(A)	THE	50Hz-Thy 6A, 800V, 0.015A, 1.5V	B-91	TAG620-800, TAG625-800, TIC116N		
TYN808(A)	THE	50Hz-Thy 8A, 800V, 0.015A, 1.5V	B-91	CS6-08, S2800N, TAG660-800, TIC116N		
TYN810(A)	THE	50Hz-Thy 10A, 800V, 0.015A, 1.5V	B-91	S2800N, TAG665-800, TIC126N		
TYN812(A)	THE	50Hz-Thy 12A, 800V, 0.015A, 1.5V	B-91	TAG680-800, TIC126N, T7.5N800FOB		
TYN1004(A)	THE	50Hz-Thy 4A, 1kV, 0.015A, 1.5V	B-91			
TYN1006(A)	THE	50Hz-Thy 6A, 1kV, 0.015A, 1.5V	B-91			
TYN1008(A)	THE	50Hz-Thy 8A, 1kV, 0.015A, 1.5V	B-91			
TYN1010(A)	THE	50Hz-Thy 10A, 1kV, 0.015A, 1.5V	B-91			
TYN1012(A)	THE	50Hz-Thy 12A, 1kV, 0.015A, 1.5V	B-91			
TYP212	THE	12A, 25V, 0.03A, 1.5V	B-91			
TYP512	THE	12A, 50V, 0.03A, 1.5V	B-91			
TYP1012	THE	12A, 100V, 0.03A, 1.5V	B-91			
TYS406-05(A)	THE	4A, 50V, 200 μ A, 2V	B-91	TAG623-100, TAG633-100, TIC106A		
TYS406-1		50Hz-Thy 4A, 100V, 200 μ A	B-11	TAG623-100, TAG633-100, TIC106A		
TYS406-2(A)	THE	50Hz-Thy 4A, 200V, 200 μ A, 2V	B-91	TAG623-200, TAG633-200, TIC106C		

器件型号 Element type	厂名 Manufacturers	材料用途参数 Material Purpose Parameter	图号 Figure	国内外相似替换器件型号 Replace of similar type	备注 Notes	外形参考图 Reference shape
TYS406-4(A)	THE	50Hz Thy 4A, 400V, 200 μ A, 2V	B-91	TAG623-400, TAG633-400, TIC106D		 图 B-91
TYS406-6(A)	THE	50Hz-Thy 4A, 600V, 200 μ A, 2V	B-91	TAG623-600, TAG633-600, TIC106M		
TYS406-8(A)	THE	50Hz-Thy 4A, 800V, 200 μ A, 2V	B-91	TAG623-800, TAG633-800, TIC106N		
TYS407-05		50Hz-Thy 4A, 50V, 500 μ A	B-11	TAG623-100, TIC106F, TIC108A		
TYS407-1		50Hz-Thy 4A, 100V, 500 μ A	B-11	TAG623-100, TIC106A, TIC108A		
TYS407-2		50Hz-Thy 4A, 200V, 500 μ A	B-11	TAG623-200, TIC106C, TIC108B		
TYS407-4		50Hz-Thy 4A, 400V, 500 μ A	B-11	TAG623-400, TIC106D, TIC108D		
TYS407-6		50Hz-Thy 4A, 600V, 500 μ A	B-11	TAG623-600, TIC106M, TIC108M		
TYS407-8		50Hz-Thy 4A, 800V, 500 μ A	B-11	TAG623-800, TIC106N, TIC108N		
TYS407-05A	THE	4A, 50V, 500 μ A, 2V	B-91			 图 B-11
TYS407-2A	THE	4A, 200V, 500 μ A, 2V	B-91			
TYS407-4A	THE	4A, 400V, 500 μ A, 2V	B-91			
TYS407-6A	THE	4A, 600V, 500 μ A, 2V	B-91			
TYS407-8A	THE	4A, 800V, 500 μ A, 2V	B-91			
TYS606-05		50Hz-Thy 6A, 50V, 200 μ A	B-11	S4060A, TAG623-100, TAG628-100		
TYS606-1		50Hz-Thy 6A, 100V, 200 μ A	B-11	S4060A, TAG623-100, TAG628-100		
TYS606-2		50Hz-Thy 6A, 200V, 200 μ A	B-11	S4060B, TAG623-200, TAG628-200		
TYS606-4		50Hz-Thy 6A, 400V, 200 μ A	B-11	S4060D, TAG623-400, TAG628-400		
TYS606-6		50Hz-Thy 6A, 600V, 200 μ A	B-11	S4060M, TAG623-600, TAG628-600		
TYS606-8		50Hz-Thy 6A, 800V, 200 μ A	B-11	S4060N, TAG623-800, TAG628-800		
TYS606-05A	THE	50Hz-Thy 6A, 50V, 200 μ A, 2V	B-91	S4060A, TAG623-100, TAG628-200		
TYS606-2A	THE	50Hz-Thy 6A, 200V, 200 μ A, 2V	B-91	S4060B, TAG623-200, TAG628-200		
TYS606-4A	THE	50Hz-Thy 6A, 400V, 200 μ A, 2V	B-91	S4060D, TAG623-400, TAG628-400		
TYS606-6A	THE	50Hz-Thy 6A, 600V, 200 μ A, 2V	B-91	S4060M, TAG623-600, TAG628-600		
TYS606-8A	THE	50Hz-Thy 6A, 800V, 200 μ A, 2V	B-91	S4060N, TAG623-800, TAG628-800		
TYS607-05A	THE	6A, 50V, 500 μ A, 2V	B-91			
TYS607-2A	THE	6A, 200V, 500 μ A, 2V	B-91			

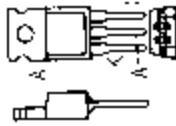
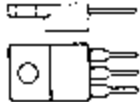
器件型号 Element type	厂名 Manufacturers	材料用途参数 Material Purpose Parameter	图号 Figure	国内外相似替换器件型号 Replace of similar type	备注 Notes	外形参考图 Reference shape
TY5607-4A	THE	6A, 400V, 500 μ A, 2V	B-91			 图 B-91
TY5607-6A	THE	6A, 600V, 500 μ A, 2V	B-91			
TY5607-8A	THE	6A, 800V, 500 μ A, 2V	B-91			
TY5607-05		50Hz-Thy 6A, 50V, 500 μ A, 2V	B-91	S4060A, TAG623-100, TAG628-100		
TY5607-1		50Hz-Thy 6A, 100V, 500 μ A	B-11	S4060A, TAG623-100, TAG628-100		
TY5607-2		50Hz-Thy 6A, 200V, 500 μ A	B-11	S4060B, TAG623-200, TAG628-200		
TY5607-4		50Hz-Thy 6A, 400V, 500 μ A	B-11	S4060D, TAG623-400, TAG628-400		
TY5607-6		50Hz-Thy 6A, 600V, 500 μ A	B-11	S4060M, TAG623-600, TAG628-600		
TY5607-8		50Hz-Thy 6A, 800V, 500 μ A	B-11	S4060N, TAG623-800, TAG628-800		
TY5806-05A	THE	8A, 50V, 200 μ A, 2V	B-91	S4060A, TAG628-100		 图 B-11
TY5806-1A	THE	8A, 100V, 200 μ A, 2V	B-91	S4060A, TAG628-100		
TY5806-2A	THE	8A, 200V, 200 μ A, 2V	B-91	S4060B, TAG628-200		
TY5806-4A	THE	8A, 400V, 200 μ A, 2V	B-91	S4060D, TAG628-400		
TY5806-6A	THE	8A, 600V, 200 μ A, 2V	B-91	S4060M, TAG628-600		
TY5806-8A	THE	8A, 800V, 200 μ A, 2V	B-91	S4060N, TAG628-800		
TY5807-05(A)		50Hz-Thy 8A, 50V, 500 μ A, 0.006A	B-11	S4060A, TAG628-100		
TY5807-1(A)		50Hz-Thy 8A, 100V, 500 μ A, 0.006A	B-11	S4060A, TAG628-100		
TY5807-2(A)		50Hz-Thy 8A, 200V, 500 μ A, 0.006A	B-11	S4060B, TAG628-200		
TY5807-4(A)		50Hz-Thy 8A, 400V, 500 μ A, 0.006A	B-11	S4060D, TAG628-400		
TY5807-6(A)		50Hz-Thy 8A, 600V, 500 μ A, 0.006A	B-11	S4060M, TAG628-600		
TY5807-8(A)		50Hz-Thy 8A, 800V, 500 μ A, 0.006A	B-11	S4060N, TAG628-800		
TY51006-05(A)	THE	50Hz-Thy 10A, 50V, 200 μ A, 2V	B-91	S4060A, S4060B, S4060C, S4060D, S4060E, S4060F, S4060M, S4060N, S4060S		
TY51006 1(A)	THE	50Hz-Thy 10A, 100V, 200 μ A, 2V	B-91	S4060A, S4060B, S4060C, S4060D, S4060E, S4060N, S4060S		
TY51006-2(A)	THE	50Hz-Thy 10A, 200V, 200 μ A, 2V	B-91	S4060B, S4060C, S4060D, S4060E, S4060M, S4060S		

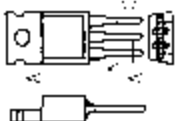
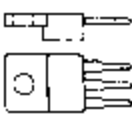
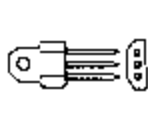
器件型号 Element type	厂名 Manufacturers	材料用途参数 Material Purpose Parameter	图号 Figure	国内外相似替换器件型号 Replace of similar type	备注 Notes	外形参考图 Reference shape
TYS1006-4(A)	THE	50Hz-Thy 10A, 400V, 200 μ A, 2V	B-91	S4060D, S4060E, S4060M, S4060N, S4060S		 图 B-91
TYS1006-6(A)	THE	50Hz-Thy 10A, 600V, 200 μ A, 2V	B-91	S4060M, S4060N, S4060S		
TYS1006-8(A)	THE	50Hz-Thy 10A, 800V, 200 μ A, 2V	D-91	S4060N		
TYS1007-05(A)		50Hz-Thy 10A, 50V, 500 μ A, 2V	B-11	S4060A		
TYS1007-1(A)		50Hz-Thy 10A, 100V, 500 μ A, 2V	B-11	S4060A		
TYS1007-2(A)		50Hz-Thy 10A, 200V, 500 μ A, 2V	B-11	S4060B		
TYS1007-4(A)		50Hz-Thy 10A, 400V, 500 μ A, 2V	B-11	S4060D		
TYS1007-6(A)		50Hz-Thy 10A, 600V, 500 μ A, 2V	B-11	S4060M		
TYS1007-8(A)		50Hz-Thy 10A, 800V, 500 μ A, 2V	B-11	S4060N		
						 图 B-11
						 图 B-98



T类外形参考图索引



图 A-7



图 A-10

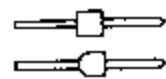

图 A-11



图 B-2



图 B-6

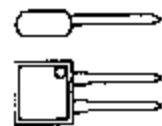

图 B-7

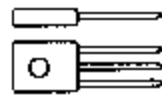

图 B-9



图 B-10

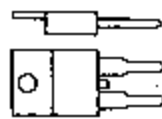

图 B-11



图 B-19

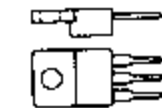

图 B-20

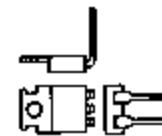

图 B-21

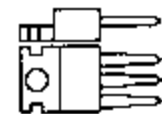

图 B-23

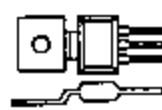

图 B-28

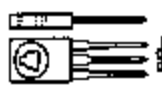

图 B-29

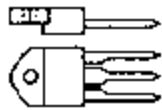

图 B-30

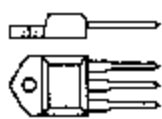

图 B-31

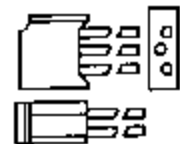

图 B-32



图 B-35

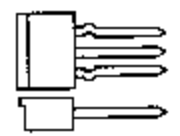

图 B-36

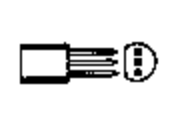

图 B-47

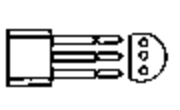

图 B-51

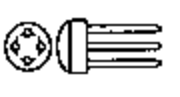

图 B-55



图 B-62

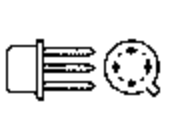

图 B-65



图 B-74



图 B-77



图 B-78



图 B-81

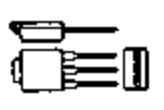

图 B-84



图 B-89

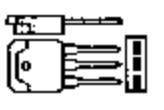

图 B-90

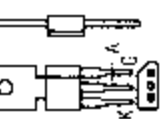

图 B-91

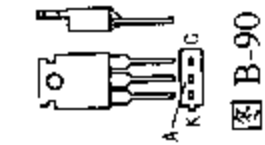

图 B-97

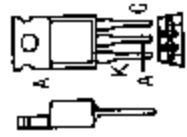

图 B-98

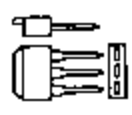

图 B-108



图 C-8



图 C-9

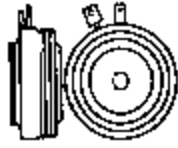

图 C-10

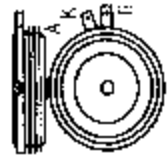

图 C-11

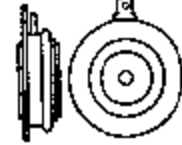

图 C-13



图 C-19

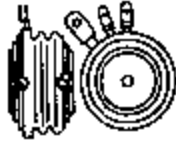

图 C-32

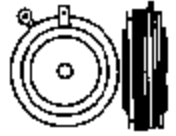

图 C-35

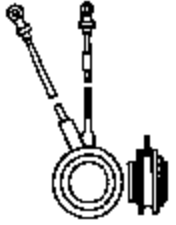

图 C-39

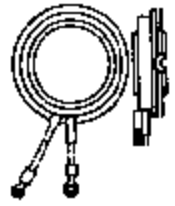

图 C-47

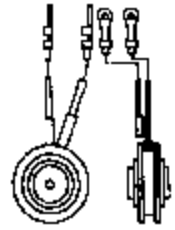

图 C-57

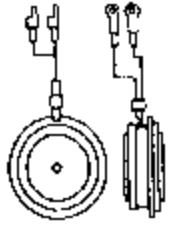

图 C-67

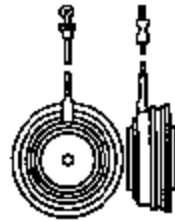

图 C-70

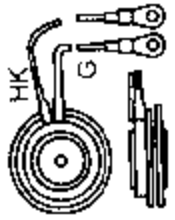

图 C-74

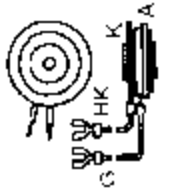

图 C-85

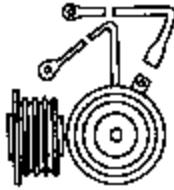

图 C-86

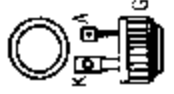

图 C-39

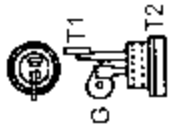

图 D-9

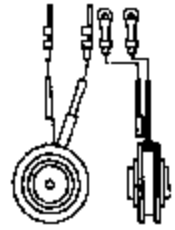

图 D-14

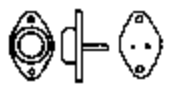

图 D-16

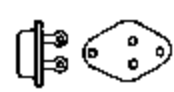

图 D-33



图 D-35

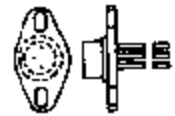

图 D-38

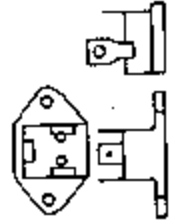

图 D-40





图 E-7

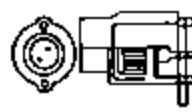

图 E-8



图 E-14



图 E-17

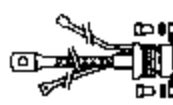

图 E-30

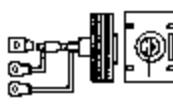

图 F-21

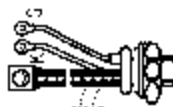

图 F-23



图 F-47



图 F-48



图 F-49



图 F-55

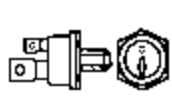

图 F-56

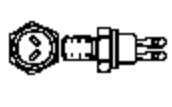

图 F-57



图 F-59



图 F-63



图 F-64



图 F-71



图 F-84

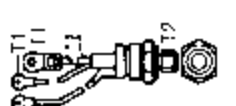

图 F-91



图 F-92



图 G-12

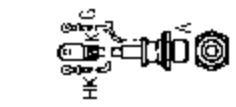

图 G-18



图 H-2



图 H-9



图 H-13

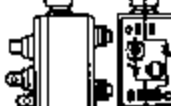

图 H-17

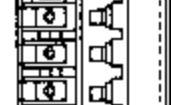

图 H-18



图 H-23



图 H-24



图 H-25

器件型号 Element type	厂名 Manufacturers	材料用途参数 Material Purpose Parameter	图号 Figure	国内外相似替换器件型号 Replace of similar type	备注 Notes	外形参考图 Reference shape
U131T1, T2	UNI	PUT 8A, 40V, 10 μ A, 1kV	B-65			
U181A	GTN	SCA 18A, 200V, 0.04A, 2.5V				
U181C	GTN	SCA 18A, 600V, 0.04A, 2.5V				
U401A	GTN	SCA 40A, 200V, 0.04A, 3V				
U401B	GTN	SCA 40A, 400V, 0.04A, 3V				
U401C	GTN	SCA 40A, 600V, 0.04A, 3V				
U401D	GTN	SCA 40A, 800V, 0.04A, 3V				
U401E	GTN	SCA 40A, 1kV, 0.04A, 3V				
U401F	GTN	SCA 40A, 1.2kV, 0.04A, 3V				
U551A	GTN	SCA 200V, 0.11A, 3V				
U551B	GTN	SCA 400V, 0.11A, 3V				
U551C	GTN	SCA 600V, 0.11A, 3V				
U551D	GTN	SCA 800V, 0.11A, 3V				
U551E	GTN	SCA 1kV, 0.11A, 3V				
U551F	GTN	SCA 1.2kV, 0.11A, 3V				
U901A	GTN	SCA 90A, 200V, 0.11A, 3V				
U901B	GTN	SCA 90A, 400V, 0.11A, 3V				
U901C	GTN	SCA 90A, 600V, 0.11A, 3V				
U901D	GTN	SCA 90A, 800V, 0.11A, 3V				
U901E	GTN	SCA 90A, 1kV, 0.11A, 3V				
U901F	GTN	SCA 90A, 1.2kV, 0.11A, 3V				
U901G	GTN	SCA 90A, 1.4kV, 0.11A, 3V				
U905A	GTN	SCB 90A, 200V, 0.11A, 3V	H-29			
U905B	GTN	SCB 90A, 400V, 0.11A, 3V	H-29			



图 B-65

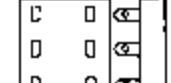

图 H-29



器件型号 Element type	厂名 Manufacturers	材料用途参数 Material Purpose Parameter	图号 Figure	国内外相似替换器件型号 Heplace of similar type	备注 Notes	外形参考图 Reference shape
U905C	GTN	SCB 90A, 600V, 0.11A, 3V	H-29			 图 H-29
U905D	GTN	SCB 90A, 800V, 0.11A, 3V	H-29			
U905E	GTN	SCB 90A, 1kV, 0.11A, 3V	H-29			
U905F	GTN	SCB 90A, 1.2kV, 0.11A, 3V	H-29			
U905G	GTN	SCB 90A, 1.4kV, 0.11A, 3V	H-29			
USF05G49		0.5A, 400V				
URSF05G49-1P, 3P, 5P	SCB	0.5A, 400V				
USF3G48		3A, 400V				
USF3J48		3A, 600V		B-12		 图 B-12
USF5G48		5A, 400V				
USF5J48		5A, 600V				
USF8G48		8A, 400V		B-12		
USF8J48		8A, 600V		B 12		
USF10G48		10A, 400V				
USF10J48		10A, 600V				
USM2D44		2A, 200V		G-8		 图 G-8
USM2G44		2A, 400V		G-8		
USM3G44		3A, 400V		G-8		
USM3J44		3A, 600V		G-8		
USM3G48		3A, 400V				
USM3J48		3A, 600V				
USM6G44		6A, 400V		G-8		
USM6J44		6A, 600V		G-8		
USM6G48/A		6A, 400V		B-12		
UFM6J48/A		6A, 600V		B-12		

器件型号 Element type	厂名 Manufacturers	材料用途参数 Material Purpose Parameter	图号 Figure	国内外相似替换器件型号 Hoplace of similar type	备注 Notes	外形参考图 Reference shape
USM16G48/A		8A, 400V	B-12			 图 B-12
UFM16J48/A		8A, 600V	B-12			
USM12G48/A		12A, 400V	B-12			
USM12J48/A		12A, 600V	B-12			
USM16G48/A		12A, 400V	B-12			

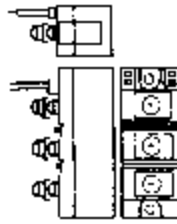
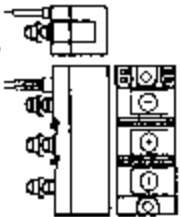
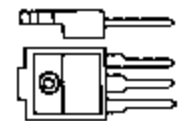
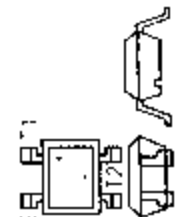
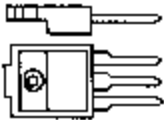

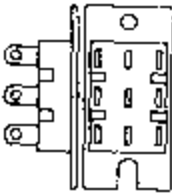
器件型号 Element type	厂名 Manufacturers	材料 Material	用途 Purpose	参数 Parameter	图号 Figure	国内外相似替换器件型号 Replce of similar type	备注 Notes	外形参考图 Reference shape
V15A	GTN	SCA		15A, 200V, 0.1A, 2.5V	H-12			 <p>图 H-12</p>
V15B	GTN	SCA		15A, 400V, 0.1A, 3.5V	H-12			
V15C	GTN	SCA		15A, 600V, 0.1A, 3.5V	H-12			
V15D	GTN	SCA		15A, 800V, 0.1A, 3.5V	H-12			
V15E	GTN	SCA		15A, 1kV, 0.1A, 3.5V	H-12			
V15F	GTN	SCA		15A, 1.2kV, 0.1A, 3.5V	H-12			
V25A	GTN	SCA		25A, 200V, 0.2A, 3.5V	H-12			
V25B	GTN	SCA		25A, 400V, 0.2A, 3.5V	H-12			
V25C	GTN	SCA		25A, 600V, 0.2A, 3.5V	H-12			
V25D	GTN	SCA		25A, 800V, 0.2A, 3.5V	H-12			
V25E	GTN	SCA		25A, 1kV, 0.2A, 3.5V	H-12			
V25F	GTN	SCA		25A, 1.2kV, 0.2A, 3.5V	H-12			
V40A	GTN	SCA		40A, 200V, 0.25A, 3.5V	H-12			
V40B	GTN	SCA		40A, 400V, 0.25A, 3.5V	H-12			
V40C	GTN	SCA		40A, 600V, 0.25A, 3.5V	H-12			
V40D	GTN	SCA		40A, 800V, 0.25A, 3.5V	H-12			
V40E	GTN	SCA		40A, 1kV, 0.25A, 3.5V	H-12			
V40F	GTN	SCA		40A, 1.2kV, 0.25A, 3.5V	H-12			



器件型号 Element type	厂名 Manufacturers	材料用途参数 Material Purpose Parameter	图号 Figure	国内外相似替换器件型号 Replace of similar type	备注 Notes	外形参考图 Reference shape
W4DA25B		25A, 200V, 0.15A, 3V				
W4DA25D		25A, 400V, 0.15A, 3V				
W4DA25M		25A, 600V, 0.15A, 3V				
W4DA25N		25A, 800V, 0.15A, 3V				
W4DA25P		25A, 1kV, 0.15A, 3V				
W4DA25PB		25A, 1.2kV, 0.15A, 3V				
W4DA25PD		25A, 1.4kV, 0.15A, 3V				
W4DA25PM		25A, 1.6kV, 0.15A, 3V				
W4DA40B		45A, 200V, 0.15A, 3V				
W4DA40D		45A, 400V, 0.15A, 3V				
W4DA40M		45A, 600V, 0.15A, 3V				
W4DA40N		45A, 800V, 0.15A, 3V				
W4DA40P		45A, 1kV, 0.15A, 3V				
W4DA40PB		45A, 1.2kV, 0.15A, 3V				
W4DA40PD		45A, 1.4kV, 0.15A, 3V				
W4DA40PM		45A, 1.6kV, 0.15A, 3V				
W4DA55B		55A, 200V, 0.15A, 3V				
W4DA55D		55A, 400V, 0.15A, 3V				
W4DA55M		55A, 600V, 0.15A, 3V				
W4DA55N		55A, 800V, 0.15A, 3V				
W4DA55P		55A, 1kV, 0.15A, 3V				
W4DA55PB		55A, 1.2kV, 0.15A, 3V				
W4DA55PD		55A, 1.4kV, 0.15A, 3V				
W4DA55PM		55A, 1.6kV, 0.15A, 3V				
W4DA90B		90A, 200V, 0.15A, 3V				
W4DA90D		90A, 400V, 0.15A, 3V				











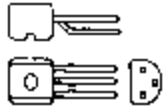





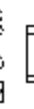
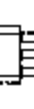
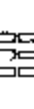



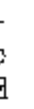

器件型号 Element type	厂名 Manufacturers	材料用途参数 Material Purpose Parameter	图号 Figure	国内外相似替换器件型号 Replace of similar type	备注 Notes	外形参考图 Reference shape
W4DA90M		90A, 600V, 0.15A, 3V				
W4DA90N		90A, 600V, 0.15A, 3V				
W4DA90P		90A, 1kV, 0.15A, 3V				
W4DA90PB		90A, 1.2kV, 0.15A, 3V				
W4DA90PD		90A, 1.4kV, 0.15A, 3V				
W4DA90PM		90A, 1.6kV, 0.15A, 3V				
W4DC25D		25A, 400V, 0.08A, 3V				
W4DC25M		25A, 600V, 0.08A, 3V				
W4DC25N		25A, 800V, 0.08A, 3V				
W4DC25P		25A, 1kV, 0.08A, 3V				
W4DC25PB		25A, 1.2kV, 0.08A, 3V				
W4DC25PD		25A, 1.4kV, 0.08A, 3V				
W4DC25PM		25A, 1.6kV, 0.08A, 3V				
W4DC40D		45A, 400V, 0.15A, 3V				
W4DC40M		45A, 600V, 0.15A, 3V				
W4DC40N		45A, 800V, 0.15A, 3V				
W4DC40P		45A, 1kV, 0.15A, 3V				
W4DC40PB		45A, 1.2kV, 0.15A, 3V				
W4DC40PD		45A, 1.4kV, 0.15A, 3V				
W4DC40PM		45A, 1.6kV, 0.15A, 3V				
W4DC55D		55A, 400V, 0.15A, 3V				
W4DC55M		55A, 600V, 0.15A, 3V				
W4DC55N		55A, 800V, 0.15A, 3V				
W4DC55P		55A, 1kV, 0.15A, 3V				
W4DC55PB		55A, 1.2kV, 0.15A, 3V				
W4DC55PD		55A, 1.4kV, 0.15A, 3V				

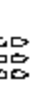
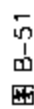



器件型号 Element type	厂名 Manufacturers	材料用途参数 Material Purpose Parameter	图号 Figure	国内外相似替换器件型号 Replace of similar type	备注 Notes	外形参考图 Reference shape
W4DC55PM		55A, 1.6KV, 0.15A, 3V				
W4DC90D		90A, 400V, 0.15A, 3V				
W4DC90M		90A, 600V, 0.15A, 3V				
W4DC90N		90A, 800V, 0.15A, 3V				
W4DC90P		90A, 1KV, 0.15A, 3V				
W4DC90PB		90A, 1.2KV, 0.15A, 3V				
W4DC90PD		90A, 1.4KV, 0.15A, 3V				
W4DC90PM		90A, 1.6KV, 0.15A, 3V				
WS504A	Triac	2-4A, 1.2KV				
WS604A	Triac	2-4A, 500V				
WV2BE25C		25A, 120V, 0.05A, 2.5V				
WV2BE25E		25A, 240V, 0.05A, 2.5V				
WV2BH25C		25A, 120V, 0.05A, 2.5V				
WV2BH25E		25A, 240V, 0.05A, 2.5V				
WV2BU25C		25A, 120V, 0.05A, 2.5V				
WV2BU25E		25A, 240V, 0.05A, 2.5V				

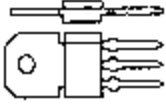
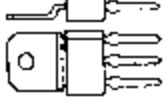
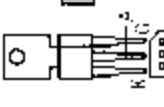
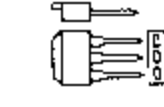

器件型号 Element type	厂名 Manufacturers	材料用途参数 Material Purpose Parameter	图号 Figure	国内外相似替换器件型号 Replace of similar type	备注 Notes	外形参考图 Reference shape
X0100AA	TAG	0.6A, 100V, 20 μ A, 0.8V	B-36			 图 B-36
X0100AR	TAG	0.6A, 100V, 20 μ A, 0.8V	B-44			
X0100BA	TAG	0.6A, 200V, 20 μ A, 0.8V	B-36			
X0100BB	TAG	0.6A, 200V, 20 μ A, 0.8V	B-44			 图 B-44
X0100CA	TAG	0.6A, 300V, 20 μ A, 0.8V	B-36			
X0100CB	TAG	0.6A, 300V, 20 μ A, 0.8V	B-44			
X0100DA	TAG	0.6A, 400V, 20 μ A, 0.8V	B-36			 图 B-65
X0100DB	TAG	0.6A, 400V, 20 μ A, 0.8V	B-44			
X0101BA	TAG	0.6A, 200V, 20 μ A, 0.8V	B-36			
X0101BB	TAG	0.6A, 200V, 20 μ A, 0.8V	B-44			
X0101BD	TAG	0.6A, 200V, 20 μ A, 0.8V	B-65			
X0101DA	TAG	0.6A, 400V, 20 μ A, 0.8V	B-36			
X0101DR	TAG	0.6A, 400V, 20 μ A, 0.8V	B-44			
X0101DD	TAG	0.6A, 400V, 20 μ A, 0.8V	B-65			
X0101MA	TAG	0.6A, 600V, 20 μ A, 0.8V	B-36			
X0101MB	TAG	0.6A, 600V, 20 μ A, 0.8V	B-44			
X0101MD	TAG	0.6A, 600V, 20 μ A, 0.8V	B-65			
X0101NA	TAG	0.6A, 800V, 20 μ A, 0.8V	B-36			
X0101NB	TAG	0.6A, 800V, 20 μ A, 0.8V	B-44			
X0101ND	TAG	0.6A, 800V, 20 μ A, 0.8V	B-65			
X0102AA	TAG	0.6A, 100V, 200 μ A, 0.8V	B-36	BT149, MCR606, TAG59		
X0102AB	TAG	0.6A, 100V, 200 μ A, 0.8V	B-44	BT149, MCR606, TAG59		
X0102BA	TAG	0.6A, 200V, 200 μ A, 0.8V	B-36	BT149, MCH606, TAG59		
X0102BB	TAG	0.6A, 200V, 200 μ A, 0.8V	B-44	BT149, MCR606, TAG59		
X0102CA	TAG	0.6A, 300V, 200 μ A, 0.8V	B-36	BT149, MCR606, TAG59		
X0102CB	TAG	0.6A, 300V, 200 μ A, 0.8V	B-44	BT149, MCR606, TAG59		
X0102DA	TAG	0.6A, 400V, 200 μ A, 0.8V	B-36	BT149, MCR606, TAG59		
X0102DB	TAG	0.6A, 400V, 200 μ A, 0.8V	B-44	BT149, MCR606, TAG59		
X0103BA	TAG	0.6A, 200V, 200 μ A, 0.8V	B-36	2N6681, 2N6682, 2N6683, 2N6684, 2N6685		

器件型号 Element type	厂名 Manufacturers	材料用途参数 Material Purpose Parameter	图号 Figure	国内外相似替换器件型号 Replace of similar type	备注 Notes	外形参考图 Reference shape
X0103BB	TAG	0.6A, 200V, 200 μ A, 0.8V	B-44	2N6681, 2N6682, 2N6683, 2N6684, 2N6685		
X0103BD	TAG	0.6A, 200V, 200 μ A, 0.8V	B-65	TAG651		
X0103DA	TAG	0.6A, 400V, 200 μ A, 0.8V	B-44			
X0103DB	TAG	0.6A, 400V, 200 μ A, 0.8V	B-65			
X0103MA	TAG	0.6A, 600V, 200 μ A, 0.8V	B-36			
X0103MB	TAG	0.6A, 600V, 200 μ A, 0.8V	B-44			
X0103MD	TAG	0.6A, 600V, 200 μ A, 0.8V	B-65			
X0103NA	TAG	0.6A, 800V, 200 μ A, 0.8V	B-36	2N6681, 2N6682, 2N6683, 2N6684, 2N6685		
X0103NB	TAG	0.6A, 800V, 200 μ A, 0.8V	B-44	2N6681, 2N6682, 2N6683, 2N6684, 2N6685		
X0103ND	TAG	0.6A, 800V, 200 μ A, 0.8V	B-65	TAG651		
X0202 · A		22.5A, 200V	B-36			
X0202 · N		22.5A, 800V	G-1			
X0203 · A		22.5A, 200V	B-36			
X0203 · N		22.5A, 400V	G-1			
X0205 · A		22.5A, 200V	B-36			
X0205 · N		22.5A, 200-800V	G-1			
X0301BG	TAG	1.6A, 200V, 20 μ A, 0.8V	B-51	TAG615		
X0301DG	TAG	1.6A, 400V, 20 μ A, 0.8V	B-51			
X0301MG	TAG	1.6A, 600V, 20 μ A, 0.8V	B-51			
X0303BG	TAG	1.6A, 200V, 200 μ A, 0.8V	B-51			
X0303DG	TAG	1.6A, 400V, 200 μ A, 0.8V	B-51			
X0303MG	TAG	1.6A, 600V, 200 μ A, 0.8V	B-51			
X0304BG	TAG	1.6A, 200V, 500 μ A, 0.8V	B-51			
X0304DG	TAG	1.6A, 400V, 500 μ A, 0.8V	B-51			
X0304MG	TAG	1.6A, 600V, 500 μ A, 0.8V	B-51			

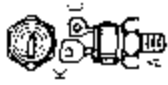
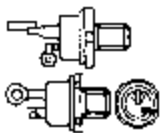

器件型号 Element type	厂名 Manufacturers	材料 Material	用途 Purpose	参数 Parameter	图号 Figure	国内外相似替换器件型号 Replace of similar type	备注 Notes	外形参考图 Reference shape
X0402·E				30A, 200-800V	B-15			
X0402·F				30A, 200-800V	B-16			
X0403B	TAG			2.1A, 200V, 200 μA, 0.8V	B-89			
X0403·F			50Hz-Thy	2.5A, 200V, 200 μA, 0.005A	B-97	S4060, TAG623, TAG628		
X0403D	TAG			2.4A, 400V, 200 μA, 0.8V	B-89			
X0403M	TAG			2.4A, 600V, 200 μA, 0.8V	B-89			
X0403N	TAG			2.4A, 800V, 200 μA, 0.8V	B-89			
X0404B	TAG			2.4A, 200V, 500 μA, 0.8V	B-89			
X0404D	TAG			2.4A, 400V, 500 μA, 0.8V	B-89			
X0404M	TAG			2.4A, 600V, 500 μA, 0.8V	B-89			
X0404N	TAG			2.4A, 800V, 500 μA, 0.8V	B-89			
X0405·E				30A, 200-800V	B-15			
X0405·F				30A, 200-800V	B-16			
X0609B	TAG			4A, 200V, 10 μA, 0.8V	B-89			
X0609BE	TAG		50Hz-Thy	4A, 200V, 10 μA, 0.8V	B-98	TAG621-200, TAG622-200, TAG632-200		
X0609BF	TAG		50Hz-Thy	4A, 200V, 10 μA, 0.8V	B-97	TAG626, TAG627, T3,5N200		
X0609DE, DF	TAG		50Hz-Thy	4A, 400V, 10 μA, 0.8V	B-89	TAG621 400, TAG622-400, TAG632-400		
X0609ME, MF	TAG		50Hz-Thy	4A, 600V, 10 μA, 0.8V	B-89	TAG621-600, TAG622-600, TAG632-600		
X0609NE, NF	TAG		50Hz-Thy	4A, 800V, 10 μA, 0.8V	B-89	TAG621-800, TAG622-800, TAG632-800		
X0709B	TAG			4.5A, 200V, 0.8V	B-51			
X0709BG			50Hz-Thy	4.5A, 200V, 0.01A, 0.015A	B-62	TAG607		
X0709D	TAG			4.5A, 400V, 0.8V	B-51			
X0709DG			50Hz-Thy	4.5A, 400V, 0.01A, 0.015A	B-62	TAG607		
X0709M	TAG			4.5A, 600V, 0.8V	B-51			
X0709MG			50Hz-Thy	4.5A, 600V, 0.01A, 0.015A	B-62	TAG607		

器件型号 Element type	厂名 Manufacturers	材料 Material	用途 Purpose	参数 Parameter	图号 Figure	国内外相似替换器件型号 Replace of similar type	备注 Notes	外形参考图 Reference shape
XT2104-401	AEI			12A, 400V, 0.06A, 2.5V	F-47			 <p>图 F-47</p>
XT2104-501	AEI			12A, 500V, 0.06A, 2.5V	F-47			
XT2104-601	AEI			12A, 600V, 0.06A, 2.5V	F-47			 <p>图 F-48</p>
XT2104-701	AEI			12A, 700V, 0.06A, 2.5V	F-47			
XT2105-601	AEI			12A, 600V, 0.06A, 2.5V	F-48			
XT2105-701	AEI			12A, 800V, 0.06A, 2.5V	F-48			
XT2105-1001	AEI			12A, 1kV, 0.06A, 2.5V	F-48			
XT2105-1401	AEI			12A, 1.4kV, 0.06A, 2.5V	F-48			

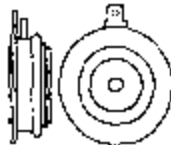

器件型号 Element type	厂名 Manufacturers	材料用途参数 Material Purpose Parameter	图号 Figure	国内外相似替换器件型号 Replace of similar type	备注 Notes	外形参考图 Reference shape
YS110107P34G		3.8kA, 3.4kV, 0.4A, 2.6V	C-10			 图 C-10
YS110107P36G		3.8kA, 3.6kV, 0.4A, 2.6V	C-10			
YS110107P38G		3.8kA, 3.8kV, 0.4A, 2.6V	C-10			
YS110107P40G		3.8kA, 4kV, 0.4A, 2.6V	C-10			
YS110107P42G		3.8kA, 4.2kV, 0.4A, 2.6V	C-10			
YS110108 P22D		3.3kA, 2.2kV, 0.4A, 2.6V	C-10			
YS110108P26D		3.3kA, 2.6kV, 0.4A, 2.6V	C-10			
YS110108P28D		3.3kA, 2.8kV, 0.4A, 2.6V	C-10			
YS110108P44G		3.4kA, 4.4kV, 0.4A, 2.6V	C-10			
YS110108P45G		3.4kA, 4.6kV, 0.4A, 2.6V	C-10			
YS110108P48G		3.4kA, 4.8kV, 0.4A, 2.6V	C-10			
YS110108P50G		3.4kA, 5kV, 0.4A, 2.6V	C-10			
YS110108P52G		3.4kA, 5.2kV, 0.4A, 2.6V	C-10			
YS130101P8D		325A, 800V, 0.25A, 2.4V	C-10			
YS130101P10D		325A, 1kV, 0.25A, 2.4V	C-10			
YS130101P12D		325A, 1.2kV, 0.25A, 2.4V	C-10			
YS130101P14D		325A, 1.4kV, 0.25A, 2.4V	C-10			
YS130101P16D		325A, 1.6kV, 0.25A, 2.4V	C-10			
YS130101P18D		325A, 1.8kV, 0.25A, 2.4V	C-10			
YS130102P4A		325A, 400V, 0.25A, 2.4V	C-10			
YS130102P6A		325A, 600V, 0.25A, 2.4V	C-10			
YS130106P4C(A)		240A, 400V, 0.4A, 3V	C-10			
YS130106P6C(A)		240A, 600V, 0.4A, 3V	C-10			
YS130106P8C		240A, 800V, 0.4A, 3V	C-10			
YS130106P10C		240A, 1kV, 0.4A, 3V	C-10			

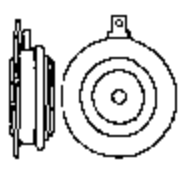
器件型号 Element type	厂名 Manufacturers	材料用途参数 Material Purpose Parameter	图号 Figure	国内外相似替换器件型号 Replace of similar type	备注 Notes	外形参考图 Reference shape
YS130106P12C		240A, 1.2kV, 0.4A, 3V	C-10			 图 C-10
YS130106P14C		240A, 1.4kV, 0.4A, 3V	C-10			
YS130106P16C		240A, 1.6kV, 0.4A, 3V	C-10			
YS130201P8D		140A, 600V, 0.25A, 2.4V				
YS130201P10D		140A, 1kV, 0.25A, 2.4V				
YS130201P12D		140A, 1.2kV, 0.25A, 2.4V				
YS130201P14D		140A, 1.4kV, 0.25A, 2.4V				
YS130201P16D		140A, 1.6kV, 0.25A, 2.4V				
YS130201P18D		140A, 1.8kV, 0.25A, 2.4V				
YS150103P8D		700A, 800V, 0.25A, 2.4V	C-10			
YS150103P10D		700A, 1kV, 0.25A, 2.4V	C-10			
YS150103P12D		700A, 1.2kV, 0.25A, 2.4V	C-10			
YS150103P14D		700A, 1.4kV, 0.25A, 2.4V	C-10			
YS150103P16D		700A, 1.6kV, 0.25A, 2.4V	C-10			
YS150103P18D		700A, 1.8kV, 0.25A, 2.4V	C-10			
YS150103P20D		620A, 2kV, 0.4A, 2.6V	C-10			
YS150104P22D		590A, 2.2kV, 0.4A, 2.6V	C-10			
YS150104P24D		590A, 2.4kV, 0.4A, 2.6V	C-10			
YS150104P26D		590A, 2.6kV, 0.4A, 2.6V	C-10			
YS150104P28D		590A, 2.8kV, 0.4A, 2.6V	C-10			
YS150107P4C		570A, 400V, 0.4A, 4V	C-10			
YS150107P6C		570A, 600V, 0.4A, 4V	C-10			
YS150107P8C		570A, 800V, 0.4A, 4V	C-10			
YS150107P10C		570A, 1kV, 0.4A, 4V	C-10			
YS150107P12C		570A, 1.2kV, 0.4A, 4V	C-10			
YS150107P14C		570A, 1.4kV, 0.4A, 4V	C-10			



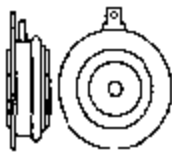

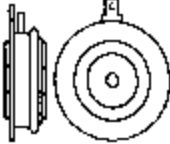

器件型号 Element type	厂名 Manufacturers	材料用途参数 Material Purpose Parameter	图号 Figure	国内外相似替换器件型号 Replace of similar type	备注 Notes	外形参考图 Reference shape
YS150107P16C		570A, 1.6kV, 0.4A, 4V	C-10			 图 C-10
YS150108P10D		530A, 1kV, 0.4A, 4V	C-10			
YS150108P12D		530A, 1.2kV, 0.4A, 4V	C-10			
YS150108P14D		520A, 1.4kV, 0.4A, 4V	C-10			
YS150108P16D		520A, 1.6kV, 0.4A, 4V	C-10			
YS150108P18D		520A, 1.8kV, 0.4A, 4V	C-10			
YS150108P20D		520A, 2kV, 0.4A, 4V	C-10			
YS150201P8D		240A, 800V, 0.4A, 2.6V				
YS150201P10D		240A, 1kV, 0.4A, 2.6V				
YS150201P12D		240A, 1.2kV, 0.4A, 2.6V				
YS150201P14D		240A, 1.4kV, 0.4A, 2.6V				
YS150201P16D		240A, 1.6kV, 0.4A, 2.6V				
YS150201P18D		240A, 1.8kV, 0.4A, 2.6V				
YS150201P22D		210A, 2.2kV, 0.4A, 2.6V				
YS150202P24D		210A, 2.4kV, 0.4A, 2.6V				
YS150202P26D		210A, 2.6kV, 0.4A, 2.6V				
YS170101P14D		1.1kA, 1.4kV, 0.4A, 2.6V	C-10			
YS170101P16D		1.1kA, 1.6kV, 0.4A, 2.6V	C-10			
YS170101P18D		1.1kA, 1.8kV, 0.4A, 2.6V	C-10			
YS170101P20D		1.1kA, 2kV, 0.4A, 2.6V	C-10			
YS170102P34G		785A, 3.4kV, 0.4A, 2.6V	C-10			
YS170102P36G		785A, 3.6kV, 0.4A, 2.6V	C-10			
YS170102P38G		785A, 3.8kV, 0.4A, 2.6V	C-10			
YS170102P40G		785A, 4kV, 0.4A, 2.6V	C-10			
YS170103P22D		970A, 2.2kV, 0.4A, 2.6V	C-10			
YS170103P24D		970A, 2.4kV, 0.4A, 2.6V	C-10			
YS170103P26D		970A, 2.6kV, 0.4A, 2.6V	C-10			
YS170103P28D		970A, 2.8kV, 0.4A, 2.6V	C-10			

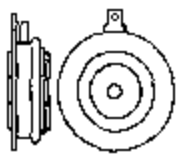
器件型号 Element type	厂名 Manufacturers	材料用途参数 Material Purpose Parameter	图号 Figure	国内外相似替换器件型号 Replace of similar type	备注 Notes	外形参考图 Reference shape
YS170106P32C		440A, 3.2kV, 0.4A, 2.8V	C-10			 图 C-10
YS170106P34C		440A, 3.4kV, 0.4A, 2.8V	C-10			
YS170106P35C		440A, 3.5kV, 0.4A, 2.8V	C-10			
YS170110P8C		885A, 800V, 0.4A, 4V	C-10			
YS170110P10C		885A, 1kV, 0.4A, 4V	C-10			
YS170110P12C		885A, 1.2kV, 0.4A, 4V	C-10			
YS170110P14C		885A, 1.4kV, 0.4A, 4V	C-10			
YS170110P16C		885A, 1.6kV, 0.4A, 4V	C-10			
YS170111P14U		800A, 1.4kV, 0.4A, 4V	C-10			
YS170111P16D		800A, 1.6kV, 0.4A, 4V	C-10			
YS170111P18D		800A, 1.8kV, 0.4A, 4V	C-10			
YS170111P20D		800A, 2kV, 0.4A, 4V	C-10			
YS170112P4B		1.5kA, 400V, 0.4A, 2.6V	C-10			
YS170112P6B		1.5kA, 600V, 0.4A, 2.6V	C-10			
YS170112P8B		1.5kA, 800V, 0.4A, 2.6V	C-10			
YS170112P10B		1.5kA, 1kV, 0.4A, 2.6V	C-10			
YS180101P14D		2.7kA, 1.4kV, 0.4A, 2.6V	C-10			
YS180101P16D		2.7kA, 1.6kV, 0.4A, 2.6V	C-10			
YS180101P18D		2.7kA, 1.8kV, 0.4A, 2.6V	C-10			
YS180101P20D		2.5kA, 2kV, 0.4A, 2.6V	C-10			
YS180102P36G		1.9kA, 3.6kV, 0.4A, 2.6V	C-10			
YS180102P38G		1.9kA, 3.8kV, 0.4A, 2.6V	C-10			
YS180102P40G		1.9kA, 4kV, 0.4A, 2.6V	C-10			
YS180103P22D		2.4kA, 2.2kV, 0.4A, 2.6V	C-10			
YS180103P24D		2.4kA, 2.4kV, 0.4A, 2.6V	C-10			
YS180103P26D		2.4kA, 2.6kV, 0.4A, 2.6V	C-10			
YS180103P28D		2.4kA, 2.8kV, 0.4A, 2.6V	C-10			

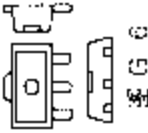

器件型号 Element type	厂名 Manufacturers	材料用途参数 Material Purpose Parameter	图号 Figure	国内外相似替换器件型号 Replace of similar type	备注 Notes	外形参考图 Reference shape
YS190101P42G		2.5kA, 4.2kV, 0.4A, 2.6V	C-10			 <p>图 C-10</p>
YS190101P44G		2.5kA, 4.4kV, 0.4A, 2.6V	C-10			
YS190101P46G		2.5kA, 4.6kV, 0.4A, 2.6V	C-10			
YS190101P48G		2.5kA, 4.8kV, 0.4A, 2.6V	C-10			
YS190101P50G		2.5kA, 5kV, 0.4A, 2.6V	C-10			
YS190101P52G		2.5kA, 5.2kV, 0.4A, 2.6V	C-10			
YS190108P24D		3.1kA, 2.4kV, 0.4A, 2.6V	C-10			
YS190113P34G		2.7kA, 3.4kV, 0.4A, 2.6V	C-10			
YS190113P36G		2.7kA, 3.6kV, 0.4A, 2.6V	C-10			
YS190113P38G		2.7kA, 3.8kV, 0.4A, 2.6V	C-10			
YS190113P40G		2.7kA, 4kV, 0.4A, 2.6V	C-10			
YS190113P42G		2.7kA, 4.2kV, 0.4A, 2.6V	C-10			
YS190114P56G		1.8kA, 5.6kV, 0.4A, 2.6V	C-10			
YS190114P58G		1.8kA, 5.8kV, 0.4A, 2.6V	C-10			
YS190114P60G		1.8kA, 6kV, 0.4A, 2.6V	C-10			
YS190114P62G		1.8kA, 6.2kV, 0.4A, 2.6V	C-10			
YS190114P64G		1.8kA, 6.4kV, 0.4A, 2.6V	C-10			
YS190114P65G		1.8kA, 6.5kV, 0.4A, 2.6V	C-10			

器件型号 Element type	厂名 Manufacturers	材料用途参数 Material Purpose Parameter	图号 Figure	国内外相似替换器件型号 Replace of similar type	备注 Notes	外形参考图 Reference shape
Z3D	Triac	=Z0103DN	G-6			 图 G-6
Z3M	Triac	=Z0103MN	G-6			
Z3N	Triac	=Z0103NN	G-6			
Z3S	Triac	=Z0103SN	G-6			
Z7D	Triac	=Z0107DN	G-6			 图 G-6
Z7M	Triac	=Z0107MN	G-6			
Z7N	Triac	=Z0107NN	G-6			
Z7S	Triac	=Z0107SN	G-6			
Z9D	Triac	=Z0109DN	G-6			 图 B-36
Z9M	Triac	=Z0109MN	G-6			
Z9N	Triac	=Z0109NN	G-6			
Z9S	Triac	=Z0109SN	G-6			
Z0101BA	TAG	1A, 200V, 0.003A, 2V	B-36			 图 B-44
Z0101BB	TAG	1A, 200V, 0.003A, 2V	B-44			
Z0101DA	TAG	1A, 400V, 0.003A, 2V	B-36			
Z0101DB	TAG	1A, 400V, 0.003A, 2V	B-44			
Z0101MA	TAG	1A, 600V, 0.003A, 2V	B-36			
Z0101MB	TAG	1A, 600V, 0.003A, 2V	B-44			
Z0101NA	TAG	4A, 800V, 0.003A, 2V	B-36			
Z0101NB	TAG	1A, 800V, 0.003A, 2V	B-44			
Z0102·A	SBS	8A, 200~800V	B-36			
Z0104BA	TAG	1A, 200V, 0.005A, 2V	B-36			
Z0104BB	TAG	1A, 200V, 0.005A, 2V	B-44			
Z0104DA	TAG	1A, 400V, 0.005A, 2V	B-36			
Z0104DB	TAG	1A, 400V, 0.005A, 2V	B-44			



器件型号 Element type	厂名 Manufacturers	材料用途参数 Material Purpose Parameter	图号 Figure	国内外相似替换器件型号 Replace of similar type	备注 Notes	外形参考图 Reference shape	
Z0104MA	TAG	1A, 600V, 0.005A, 2V	B-36			 图 B-36	
Z0104MB	TAG	1A, 600V, 0.005A, 2V	B-44				
Z0104NA	TAG	4A, 800V, 0.005A, 2V	B-36				
Z0104NB	TAG	4A, 800V, 0.005A, 2V	B-44				
Z0105·A	SBS	8A, 200~800V	B-36				
Z0106BA	TAG	1A, 200V, 0.005A, 2V	B-36				
Z0106BB	TAG	1A, 200V, 0.005A, 2V	B-44				
Z0106DA	TAG	1A, 400V, 0.005A, 2V	B-36				
Z0106DB	TAG	1A, 400V, 0.005A, 2V	B-44				
Z0106MA	TAG	1A, 600V, 0.005A, 2V	B-36				
Z0106MB	TAG	1A, 600V, 0.005A, 2V	B-44				
Z0106NA	TAG	4A, 800V, 0.005A, 2V	B-36				
Z0106NB	TAG	4A, 800V, 0.005A, 2V	B-44				
Z0109·A	SBS	8A, 200~800V	B-36				 图 B-44
Z0110·A	SBS	8A, 200~800V	B-36				
Z0302BG	TAG	3A, 200V, 0.003A, 2V	B-51	TAG207			
Z0302DG	TAG	3A, 400V, 0.003A, 2V	B-51	TAG207			
Z0302MG	TAG	3A, 600V, 0.003A, 2V	B-51	TAG207			
Z0305BG	TAG	3A, 200V, 0.005A, 2V	B-51	TAG204A, TAG205			
Z0305DG	TAG	3A, 400V, 0.005A, 2V	B-51	TAG204A, TAG205			
Z0305MG	TAG	3A, 600V, 0.005A, 2V	B-51	TAG204A, TAG205			
Z0309BG	TAG	3A, 200V, 0.01A, 2V	B-51	TAG203, TAG203A, TAG209			
Z0309DC	TAG	3A, 400V, 0.01A, 2V	B-51	TAG203, TAG203A, TAG209			
Z0309MG	TAG	3A, 600V, 0.01A, 2V	B-51	TAG203, TAG203A, TAG209			



图 B-51

器件型号 Element type	厂名 Manufacturers	材料用途参数 Material Purpose Parameter	图号 Figure	国内外相似替换器件型号 Replace of similar type	备注 Notes	外形参考图 Reference shape
Z0310BG	TAG	3A, 200V, 0.025A, 2V	B-51	TAG208		 图 B-51
Z0310DG	TAG	3A, 400V, 0.025A, 2V	B-51			
Z0310MG	TAG	3A, 600V, 0.025A, 2V	B-51	TAG208		
Z0402BE, BF		Triac	B-18			 图 B-18
Z0402DE		Triac	B-18			
Z0402DF	TAG	4A, 400V, 0.003A, 0.01A	B-18			
Z0402ME, MF	TAG	4A, 400V, 0.003A, 2V	B-18			
Z0402NE, NF		Triac	B-18			
Z0405B	TAG	4A, 200V, 0.005A, 0.01A	B-89			 图 B-89
Z0405BE, BF	TAG	4A, 200V, 0.005A, 2V	B-18	TAG222-200, TAG233-200, TXC18D20		
Z0405D	TAG	4A, 400V, 0.005A, 2V	B-89			
Z0405DE, DF		SBS	B-18	TAG222-400, TAG233-400, TXC18D40		
Z0405M	TAG	4A, 400V, 0.005A	B-89			
Z0405ME, MF		SBS	B-18	TAG222-600, TAG233-600, TXC18D60		
Z0405N	TAG	4A, 600V, 0.005A, 2V	B-89			
Z0405NE, NF		SBS	B-18	TAG222-800, TAG233-800, TXC18D80		
Z0409B	TAG	4A, 200V, 0.01A, 2V	B-89			
Z0409BE, BF		SBS	B-18	TAG221-200, TAG232-200, TXC18G40		
Z0409D	TAG	4A, 400V, 0.01A, 2V	B-89			
Z0409DE, DF		SBS	B-18	TAG221-400, TAG232-400, TXC18G40		
Z0409M	TAG	4A, 400V, 0.01A	B-89			
Z0409ME, MF		SBS	B-18	TAG221-600, TAG232-600, TXC18G60		
Z0409N	TAG	4A, 600V, 0.01A, 2V	B-89			
Z0409NE, NF		SBS	B-18	TAG221-800, TAG232-800, TXC18G80		
Z0410B	TAG	4A, 200V, 0.025A, 2V	B-89			

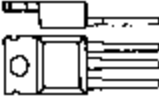
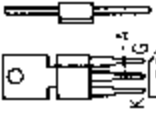

器件型号 Element type	厂名 Manufacturers	材料用途参数 Material Purpose Parameter	图号 Figure	国内外相似替换器件型号 Replace of similar type	备注 Notes	外形参考图 Reference shape
Z0410BE	SBS	4A, 200V, 0.025A	B-15	TAG220-200, TAG231-200, TAG225-200		<p>图 B-15</p> <p>图 B-16</p> <p>图 B-89</p> <p>图 B-98</p> <p>图 B-97</p>
Z0410BF	SBS	4A, 200V, 0.025A	B-16	TAG220-200, TAG231-200, TAG225-200		
Z0410D	TAG	4A, 400V, 0.025A, 2V	B-89	TAG220-400, TAG225-400, TAG231-400		
Z0410DE	Triac	4A, 400V, 0.025A	B-98	TAG220-400, TAG225-400, TAG231-400		
Z0410DF	SBS	4A, 400V, 0.025A	B-16	TAG220-600, TAG225-600, TAG231-600		
Z0410M	TAG	4A, 600V, 0.025A, 2V	B-89	TAG220-600, TAG225-600, TAG231-600		
Z0410ME	Triac	4A, 600V, 0.025A	B-15	TAG220-800, TAG225-800, TAG231-800		
Z0410MF	SBS	4A, 600V, 0.025A	B-16	TAG220-800, TAG225-800, TAG231-800		
Z0410N	TAG	4A, 800V, 0.025A, 2V	B-89	TAG220-800, TAG225-800, TAG231-800		
Z0410NE	Triac	4A, 800V, 0.025A	B-15	TAG220-800, TAG225-800, TAG231-800		
Z0410NF	SBS	4A, 800V, 0.025A	B-97	TAG220-800, TAG225-800, TAG231-800		

U~Z 外形参考图索引



图 B-12



图 B-15

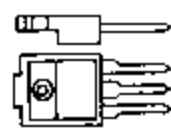

图 B-16

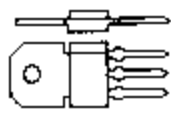

图 B-18

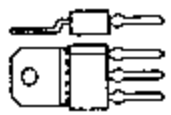

图 B-36

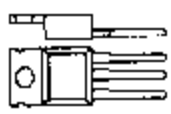

图 B-44

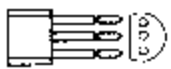

图 B-51

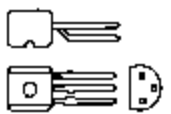

图 B-62



图 B-65



图 B-89



图 B-97

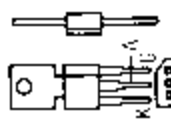

图 B-98

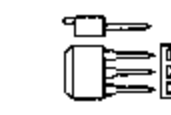

图 C-10

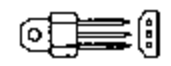

图 F-47

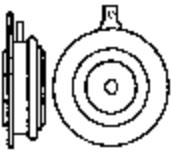

图 F-48

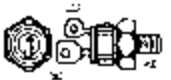

图 G-1

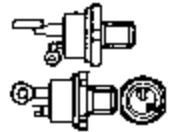

图 G-6

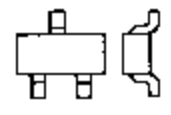

图 G-8



图 H-12



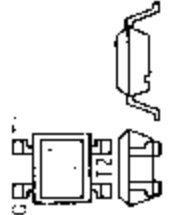



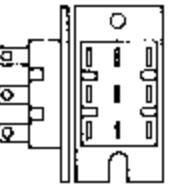

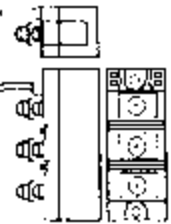

图 H-29

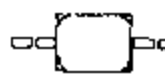

器件型号 Element type	厂名 Manufacturers	材料用途参数 Material Purpose Parameter	图号 Figure	国内外相似替换器件型号 Replace of similar type	备注 Notes	外形参考图 Reference shape	
1N3299	AMR, APD	FLD 10A, 24V, 36V	F-1			 图 F-1	
1N3300	AMR, APD	FLD 0.2A, 30V, 14V, 1.5V	A-2	ECG6406			
1N3300A	AMR, APD	FLD 0.2A, 30V, 16V, 1.5V	A-2	ECG6406			
1N3301	CRI, MDC	FLD 0.2A, 30V, 17V, 1.5V	A-2	ECG6407, SK3523, SK6407			
1N3301A	MDC, SPE	FLD 0.2A, 30V, 19V, 1.5V	A-2	ECG6407, SK3523, SK6407			
1N3302	CRI, MDC	FLD 0.2A, 40V, 21V, 1.5V	A-2	ECG6408			
1N3302A	MDC, SPE	FLD 0.2A, 40V, 24V, 1.5V	A-2	ECG6408			
1N3303	APD, GRI	FLD 0.2A, 50V, 26V, 1.5V	A-2				
1N3303A	APD, MDC	FLD 0.2A, 50V, 29V, 1.5V	A-2				
1N3304	AMR, APD	FLD 0.2A, 50V, 31V, 1.5V	A-2	ECG6408			
1N3304A	APD, MDC	FLD 0.2A, 50V, 35V, 1.5V	A-2				
1N3489	AMR, APD	FLD 10A, 12V, 16V	F-1				 图 A-2
1N3490	AMR, APD	FLD 10A, 12V, 16V	F-1				
1N3771	CRI, MDC	FLD 120V, 170V, 1.2V	F-1				
1N3772	AMR, APD	FLD 12V, 15V, 1.2V	F-1				
1N3831	AMR, APD	FLD 10A, 12V, 16V, 1.2V	F-1				
1N3832	AMR, APD	FLD 10A, 15V, 21V, 1.2V	F-1				
1N3833	AMR, APD	FLD 10A, 18V, 26V, 1.2V	F-1				
1N3834	AMR, APD	FLD 10A, 21V, 31V, 1.2V	F-1				
1N3835	AMR, APD	FLD 10A, 24V, 36V, 1.2V	F-1				
1N3836	AMR, APD	FLD 10A, 27V, 41V, 1.2V	F-1				
1N3837	AMR, APD	FLD 10A, 30V, 46V, 1.2V	F-1				
1N3838	APD, MDC	FLD 10A, 60V, 90V, 1.2V	F-1				
1N3839	AMR, APD	FLD 10A, 12V, 16V, 1.2V	F-1				
1N3840	AMR, APD	FLD 10A, 15V, 21V, 1.2V	F-1				
1N3841	AMR, APD	FLD 10A, 18V, 26V, 1.2V	F-1				

器件型号 Element type	厂名 Manufacturers	材料用途参数 Material Purpose Parameter	图号 Figure	国内外相似替换器件型号 Replace of similar type	备注 Notes	外形参考图 Reference shape
1N3842	APD, MDC	FLD 10A, 21V, 31V, 1.2V	F-1			 图 F-1
1N3843	APD, MDC	FLD 10A, 24V, 36V, 1.2V	F-1			
1N3844	APD, MDC	FLD 10A, 27V, 41V, 1.2V	F-1			
1N3846	APD, MDC	FLD 10A, 60V, 90V, 1.2V	F-1			
1N3935	APD, NJS	FLD 10A, 18V, 26V, 1.2V	F-1			
1N3936	AMR, APD	FLD 10A, 12V, 16V	F-1			
1N5411	AMR, NJS	DAC, 2A, 3V, 29V, 5V	A-4	SK3523, SK6407		
1N5758	AMR, MOT	DAC, 2A, 4V, 16V, 5V	B-1	ECG6406, MBS4991, SK9082A, SK6406		 图 A-4
1N5758A	MOT, SPE	DAC, 2A, 2V, 18V, 5V	B-1	ECG6406, MBS4991, SK9082A, SK6406		
1N5759	MOT, SPE	DAC, 2A, 4V, 28V, 5V	B-1	ECG6407, MBS4991		
1N5759A	SBS	0.2A, 8V		MBS4991		
1N5760	MOT, SPE	DAC, 2A, 4V, 24V, 7V	B-1	ECG6407, MBS4991		
1N5760A	SBS	0.2A, 8V		MBS4991		
1N5761	AMR, MOT	DAC, 2A, 4V, 28V, 7V	B-1	ECG6407, GT32, MBS4991		
1N5761A	MOT, SPE	DAC, 2A, 2V, 30V, 7V	B-1	ECG6407, GT32, MBS4991		
1N5762	AMR, MOT	DAC, 2A, 4V, 32V, 7V	B-1	GT35, MBS4991		
1N5762A	MOT, SPE	DAC, 2A, 2V, 34V, 7V	B-1	GT32, MBS4991		
1N5779	SBS	0.0015A, 8V		MBS4991		 图 B-1
1N5780	SBS	0.0015A, 8V		MBS4991		
1N5781	SBS	0.0015A, 8V		MBS4991		
1N5782	SBS	0.0015A, 8V		MBS4991		
1N5783	SBS	0.0015A, 8V		MBS4991		
1N5784	SBS	0.0015A, 8V		MBS4991		
1N5785	SBS	0.0015A, 8V		MBS4991		

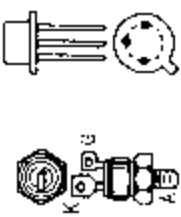
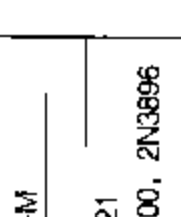
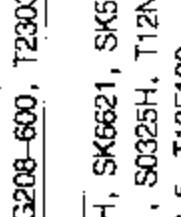
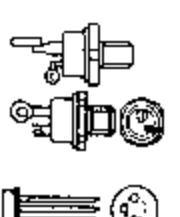
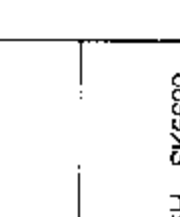
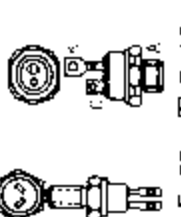

器件型号 Element type	厂名 Manufacturers	材料用途参数 Material Purpose Parameter	图号 Figure	国内外相似替换器件型号 Replace o' similar type	备注 Notes	外形参考图 Reference shape
1N5786	SBS	0.0015A, 8V		MBS4991		 图 D-150
1N5787	SBS	0.0015A, 8V		MBS4991		
1N5788	SBS	0.0015A, 8V		MBS4991		
1N5789	SBS	0.0015A, 8V		MBS4991		
1N5790	SBS	0.0015A, 8V		MBS4991		
1N5791	SBS	0.0015A, 8V		MBS4991		
1N5792	SBS	0.0015A, 8V		MBS4991		
1N5793	SBS	0.0015A, 8V		MBS4991		
1RC20	INR	1.3A, 200V, 0.018A, 2.1V	B-50			 图 F-1
1RC40	INR	1.3A, 400V, 0.018A, 2.1V	B-50			
1RC60	INR	1.3A, 600V, 0.018A, 2.1V	B-50			
1S2093	TOS	DAC, 26V	F-1	ECG6408		 图 F-47
0220100F		35A, 100V	F-47	C228A		
0220200F		35A, 200V	F-47	C228B		
0220300F		35A, 400V	F-47	C228D		
0220400F		35A, 400V	F-47	C228D		
0220500F		35A, 600V	F-47	C228M		
0220600F		35A, 600V	F-47	C228M		
0230100F		35A, 100V	F-47	C228A		
0230200F		35A, 200V	F-47	C228B		
0230400		35A, 400V	F-47	C228D		
0230500		35A, 400V	F-47	C228D		
0230600		35A, 600V	F-47	C228M		

器件型号 Element type	厂名 Manufacturers	材料用途参数 Material Purpose Parameter	图号 Figure	国内外相似替换器件型号 Replace of similar type	备注 Notes	外形参考图 Reference shape
0230600F		35A, 200V	F-17	C228B		
2AC3T		SCR-D 2A, 300V, 0.04A	B-53	TAG200-300, TAG208-300, T2303-D		
2AC5T		SCR-D 2A, 500V, 0.04A	B-53	TAG200-500, TAG208-500, T2303-M		
2AC6T		SCR-D 2A, 600V, 0.04A	B-53	TAG200-600, TAG208-600, T2303-M		
2N681	AEI, AMR	SCS 16A, 25V, 0.08A, 3V	B-60	ECG5521, S0325H, SK6621, SK5521		
2N681A	AMR, CEN	50Hz-Thy 18A, 25V, 0.04A, 3V	F-48	C228U, MCR70-1, S0325H, T12N100, 2N3896		
2N681AS		SCR-H 16A, 25V, 0.08A, 3V	F-55	C234U, MCR1718-5, T12F100		
2N682	AEI, AMR	SCS 16A, 50V, 0.08A, 3V	B-60	ECG5521, S0525H, SK6621, SK5521		
JAN2N682	JES, NAE	16A, 50V, 0.08A, 3V	F-19			
2N682A	AMR, CEN	50Hz-Thy 18A, 50V, 0.04A, 3V	F-48	C228F, MCR70-2, S0525H, SK6621, SK5521, T12N100, 2N3896		
2N682AS		SCR-H 16A, 50V, 0.08A, 3V	F-55	C234F, MCR1718-5, T12F100		
2N683	AEI, AMR	SCS 16A, 100V, 0.08A, 3V	B-60	S1025H, SK6622, SK5522		
JAN2N683	JES, NAE	16A, 100V, 0.08A, 3V	F-19			
2N683A	AMR, CEN	50Hz-Thy 18A, 100V, 0.04A, 3V	F-48	C228A, ECG5522, MCR70-3, S1025H, SK6622, SK5522, T12N100, 2N3896		
2N683AS	CRI, ESE	SCR-H 25A, 100V, 0.04A, 3V	F-48	C234A, MCR1718-5, T12F100		
2N683S	ESE, NAS	25A, 100V, 0.04A, 3V	F-48			
2N684	AEI, AMR	SCS 16A, 150V, 0.08A, 3V	B-60	ECG5524, S2025H, SK6624, SK5524		
2N684A	AMR, CEN	50Hz-Thy 18A, 150V, 0.04A, 3V	F-48	C228B, ECG5524, MCR3935-4, S2025H, SK6624, SK5524, T12N200, 2N3897		
2N684AS		SCR-H 16A, 150V, 0.08A, 3V	F-55	C234B, MCR1718-5, T12F200		
2N685	AEI, AMR	SCS 16A, 200V, 0.08A, 3V	B-60	ECG5524, SK6624, SK5524, S2025H		
2N685A		50Hz-Thy 16A, 200V, 0.08A, 3V	F-55	C228B, MCR3935-4, T12N200, 2N3897		
2N685AS		SCR-H 16A, 200V, 0.08A, 3V	F-55	C234B, MCR1718-5, T12F200		
JAN2N685	GES, NAE	16A, 200V, 0.08A, 3V	F-19			
2N686	AEI, AMH	16A, 250V, 0.08A, 3V	B-60	ECG5527, S4025H, SK6627, SK5527		



器件型号 Element type	厂名 Manufacturers	材料用途参数 Material Purpose Parameter	图号 Figure	国内外相似替换器件型号 Replace of similar type	备注 Notes	外形参考图 Reference shape
2N686A		50Hz-Thy 16A, 250V, 0.08A, 3V	F-55	C228C, MCR3935-5, T12N300, 2N3898		 图 F-55
2N686AS		SCR-H 16A, 250V, 0.08A, 3V	F-55	C234C, MCR1718-5, T12F300		
JAN2N686	GES, NAE	16A, 250V, 0.08A, 3V	F-19			
2N687	AEI, AMR	16A, 300V, 0.08A, 3V	B-60	ECG5527, S4025H, SK6627, SK5527		
2N687A		50Hz-Thy 16A, 300V, 0.08A, 3V	F-55	C228C, MCR3935-5, T12N300, 2N3898		
2N687AS		SCR-H 16A, 300V, 0.08A, 3V	F-55	C234C, MCR1718-5, T12F300		
JAN2N687	JES, NAE	16A, 300V, 0.08A, 3V	F-19			
2N688	AEI, AMR	16A, 400V, 0.08A, 3V	B-60	ECG5527, S4025H, SK6627, K5527		
2N688A		50Hz-Thy 16A, 400V, 0.08A, 3V	F-55	C228D, MCR3935-6, T12N400, 2N3898		
2N688AS		SCR-H 16A, 400V, 0.08A, 3V	F-55	C234D, MCR1718-6, T12F400		
JAN2N688	JES, NAE	16A, 400V, 0.08A, 3V	F-19			
2N689	AEI, AMR	16A, 500V, 0.08A, 3V	B-60	ECG5529, S6025H, SK6629, SK5529		
2N689A		50Hz-Thy 16A, 500V, 0.08A, 3V	F-55	C228E, MCR3935-7, T12N500, 2N3899		
2N689AS		SCR-H 16A, 500V, 0.08A, 3V	F-55	C234E, MCR1718-7, T12F500		
JAN2N689	JES, NAE	16A, 500V, 0.08A, 3V	F-19			
2N690	AEI, AMR	16A, 600V, 0.08A, 3V	B-60	ECG5529, S6025H, SK6629, SK5529		
2N690A		50Hz-Thy 16A, 600V, 0.08A, 3V	F-55	C228M, MCR3935-8, T12N600, 2N3899		
2N690AS		SCR-H 16A, 600V, 0.08A, 3V	F-55	C234M, MCR1718-8, T12F600		
JAN2N690	RCA	16A, 600V, 0.08A, 3V	F-19			
2N691	AEI, AMR	16A, 700V, 0.08A, 3V	B-60	ECG5531		
2N691A		50Hz-Thy 16A, 700V, 0.08A, 3V	F-55	BSIE4146N, MCR3935-9, T12N700		
2N691AS		SCR-H 16A, 700V, 0.08A, 3V	F-55	T12F700, TAG35S-700		
JAN2N691	NON	16A, 700V, 0.08A, 3V	F-19			
2N692	AEI, AMR	16A, 800V, 0.08A, 3V	B-60	ECG5531, SK6631, SK5531		
2N692A		50Hz-Thy 16A, 800V, 0.08A, 3V	F-55	BSIE4153N, MCR3935-10, T12N800		
2N692AS		SCR-H 16A, 800V, 0.08A, 3V	F-55	T12F800, TAG35S-800		
JAN2N692	NON	16A, 800V, 0.08A, 3V	F-19			
2N764	AMR, CRI	GTO 0.2A, 30V, 0.001A, 1V	B-65			



图 F-55



图 F-19









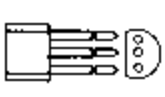



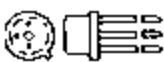











图 B-60









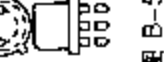



图 B-65







器件型号 Element type	厂名 Manufacturers	材料用途参数 Material Purpose Parameter	图号 Figure	国内外相似替换器件型号 Replace of similar type	备注 Notes	外形参考图 Reference shape	
2N765	AMR, CRI	GTO 0.2A, 60V, 0.001A, 1V	B-65			 B-65	
2N766	AMR, CRI	GTO 0.2A, 100V, 0.001A, 1V	B-65				
2N767	AMR, CRI	GTO 0.2A, 200V, 0.001A, 1V	B-65				
2N876	AMR, ASI	0.35A, 15V, 200 μ A, 0.8V	B-36	EC103Y, ECG5400, MCR102, MCR202, SK3950, SK5400, TAG06Y, TAG615-100, 2N2322, 2N6332		 B-65	
2N877	AMR, ASI	0.35A, 30V, 200 μ A, 0.8V	B-36	EC103Y, ECG5400, MCR102, MCR202, SK3950, SK5400, TAG06Y, TAG615-100, 2N2322, 2N6332			
2N878	AMR, ASI	0.35A, 60V, 20 μ A, 0.6V	B-36	EC103A, ECG5401, MCR103, MCR203, SK3636, SK5402, TAG06YY, TAG615-100, 2N2324, 2N6334			
2N879	AMR, ASI	0.35A, 100V, 200 μ A, 0.8V	B-36	EC103A, ECG5402, MCR204, SK3638, SK5402, TAG06A, TAG615-100, 2N2324, 2N5062, 2N6334			
2N880	AMR, ASI	0.35A, 150V, 200 μ A, 0.8V	B-36	EC103B, ECG5404, MCR205, SK3627, SK5404, TAG06B, TAG615-200, 2N2325, 2N5064, 2N6335			
2N881	AMR, ASI	0.35A, 200V, 200 μ A, 0.8V	B-36	EC103B, ECG5404, MCR120, MCR206, SK3627, SK5404, TAG06B, TAG615-200, 2N2326, 2N6335			
2N882	AMR, CRI	0.35A, 300V, 200 μ A, 0.8V	B-36	EC103D, MCR100-5, TAG06C, TAG615-300, 2N2328, 2N6337			
2N883	AMR, CRI	0.35A, 400V, 200 μ A, 0.8V	B-36	EC103D, MCR100-6, TAG06D, TAG615-400, 2N2329, 2N6337			
2N884	AMR, ASI	0.35A, 15V, 20 μ A, 0.6V	B-36	EC103Y, MCR102, MCR202, 2N2322A			 B-36
2N884A	AMR, CEN	0.275A, 15V, 50 μ A, 0.6V	B-65				
2N885	AMR, ASI	0.35A, 30V, 20 μ A, 0.6V	B-36	EC103Y, MCR102, MCR202, 2N2323A			
2N885A	AMR, CEN	0.275A, 30V, 50 μ A, 0.5V	B-65				
2N886	AMR, ASI	0.35A, 60V, 20 μ A, 0.6V	B-36	EC103A, MCR103, MCR203, 2N2324A			
2N886A	AMR, CEN	0.275A, 60V, 50 μ A, 0.5V	B-65				
2N887	AMR, ASI	0.35A, 100V, 20 μ A, 0.6V	B-36	EC103A, MCR104, MCR204, 2N2324A			
2N887A	AMR, CEN	0.275A, 100V, 50 μ A, 0.5V	B-65				
2N888	AMR, ASI	0.35A, 150V, 20 μ A, 0.6V	B-36	EC103B, MCR115, MCR205, 2N2325A			









器件型号 Element type	厂名 Manufacturers	材料 用途 参数 Material Purpose Parameter	图号 Figure	国内外相似替换器件型号 Replace of similar type	备注 Notes	外形参考图 Reference shape
2N888A	AMR, CEN	0.275A, 150V, 50 μ A, 0.5V	B-65	EC103B, MCR120, MCR206, 2N2326A		
2N889	AMR, ASI	0.35A, 200V, 20 μ A, 0.6V	B-36			
2N889A	AMR, CEN	0.275A, 200V, 50 μ A, 0.5V	B-65	EC103D, MCR100-5, 2N2328A		
2N890	AMR, CRI	0.35A, 300V, 20 μ A, 0.6V	B-36			
2N891	AMR, CRI	0.35A, 400V, 20 μ A, 0.6V	B-36	MCR100-6, 2N2329A		
2N892	AMR, CRI	0.25A, 15V, 50 μ A, 0.7V	B-65			
2N893		0.25A, 15V, 50 μ A, 0.7V	B-62			
2N894	AMR, CRI	0.25A, 30V, 50 μ A, 0.7V	B-65			
2N895	AMR, CRI	0.25A, 30V, 50 μ A, 0.7V	B-65			
2N896	AMR, CRI	0.25A, 60V, 50 μ A, 0.7V	B-65			
2N897	AMR, CRI	0.25A, 60V, 50 μ A, 0.7V	B-65			
2N898	AMR, CRI	0.25A, 100V, 50 μ A, 0.7V	B-65			
2N899	AMR, CRI	0.25A, 100V, 50 μ A, 0.7V	B-65			
2N900	AMR, CRI	0.25A, 200V, 50 μ A, 0.7V	B-62			
2N901	AMR, CRI	0.25A, 200V, 50 μ A, 0.7V	B-65			
2N948	AMR, ASI	0.26A, 30V, 20 μ A, 1V	B-36	EC103Y, MCR102, MCR202, 2N877, 2N2322A		
2N949	AMR, ASI	0.26A, 60V, 20 μ A, 1V	B-36	EC103A, MCR103, MCR203, 2N878, 2N2324A		
2N950	AMR, ASI	0.26A, 100V, 20 μ A, 1V	B-36	EC103A, MCR104, MCR204, 2N879, 2N2324A		
2N951	AMR, ASI	0.26A, 200V, 20 μ A, 1V	B-36	EC103B, MCR120, MCR206, 2N881, 2N2326A		
2N1595	AMR, ASI	50Hz-Thy 1A, 50V, 0.01A, 3V, 0.005A	B-55	BTX18, BTX30, BTX50, ECG5408, S2600B, S0501M, SK3577, T1N100A, TAG1-50		
2N1595A	AMR, ASI	50Hz-Thy 1A, 50V, 0.002A, 3V, 0.005A	B-51	MCR1906-2, S0501M, SK3577, TAG2-50, TAG614-100		
2N1596	AMR, ASI	50Hz-Thy 1A, 100V, 0.01A, 3V, 0.005A	B-55	BTX18, BTX30/100, ECG5406, S1001M, S2600B, SK3577, T1N100A, TAG1-100,		
2N1596A	AMR, ASI	50Hz-Thy 1A, 100V, 0.002A, 3V, 0.005A	B-51	MCR1906-3, S1001M, SK3577, TAG2-100, TAG614-100		

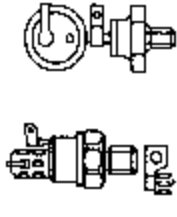

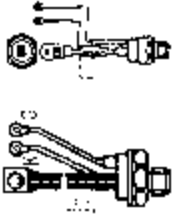
器件型号 Element type	厂名 Manufacturers	材料用途参数 Material Purpose Parameter	图号 Figure	国内外相似替换器件型号 Replace of similar type	备注 Notes	外形参考图 Reference shape
2N1597	AMR, ASI	50Hz-Thy 1A, 200V, 0.01A, 3V, 0.005A	B 55	BTX18, BTX30-200, ECG5408, S2001M, S2600B, SK3577, T1N200A, TAG1-200		 图 B-55
2N1597A	AMR, ASI	50Hz-Thy 1A, 200V, 0.002A, 3V, 0.005A	B-51	MCR1906-4, S2001M, SK3577, TAG2-200, TAG614-200		
2N1598	AMR, ASI	50Hz-Thy 1A, 300V, 0.01A, 3V, 0.005A	B-55	BTX18, BTX30/300, ECG5409, S2600D, S4001M, SK3577, T1N300A, TAG1-300		 图 B-55
2N1598A	AMR, ASI	50Hz-Thy 1A, 300V, 0.002A, 3V, 0.005A	B-51	MCR1906-5, S3001M, SK3577, TAG2-300, TAG614-300		
2N1599	AMR, ASI	50Hz-Thy 1A, 400V, 0.01A, 3V, 0.005A	B-55	BTX18, BTX30/400, ECG5409, S2600D, S4001M, SK3577, T1N400A, TAG1-400		 图 B-51
2N1599A	AMR, ASI	50Hz-Thy 1A, 400V, 0.002A, 3V, 0.005A	B-51	BTX18, MCR1906-6, S4001M, SK3577, TAG2-400, TAG614-400		
2N1600	AMR, ASI	3A, 50V, 0.01A, 3V	F-47	C11FX701, ECG5470, S0515H, SK3577, 2N4168		 图 F-47
2N1601	AMR, ASI	3A, 100V, 0.01A, 3V	F-47	BTY79-400R, C11AX701, ECG5471, S1015H, SK3577, 2N4169		
2N1602	AMR, ASI	3A, 200V, 0.01A, 3V	F-47	BTY79-400R, C11BX701, ECG5472, SK3577, S2015H, 2N4170		
2N1603	AMR, ASI	3A, 300V, 0.01A, 3V	F-47	BTY79-400R, C11CX701, ECG5474, 2N4171, S3015H, SK3578		 图 F-47
2N1604	AMR, ASI	3A, 400V, 0.01A, 3V	F-47	BTY79-400R, C11DX701, ECG5474, S4015H, SK3578, 2N4172		 图 B-62
2N1686	AMR, CRI	GTO, 1A, 30V, 0.001A, 1V	B-51			
2N1687	AMR, CRI	GTO, 1A, 60V, 0.001A, 1V	B-51			
2N1688	AMR, CRI	GTO, 1A, 100V, 0.001A, 1V	B-51			
2N1689	AMR, CRI	GTO, 1A, 200V, 0.001A, 1V	B-51			
2N1765		50Hz-Thy 0.5A, 400V, 0.01A, 0.05A	B-62	BTX30/400, T1N400, TAG1-400, 2N1599		

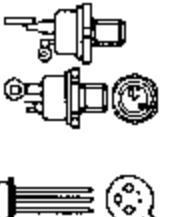

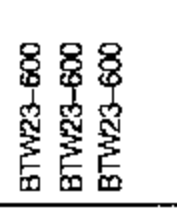



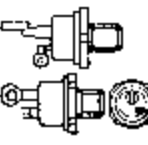

器件型号 Element type	厂名 Manufacturers	材料用途参数 Material Purpose Parameter	图号 Figure	国内外相似替换器件型号 Replace of similar type	备注 Notes	外形参考图 Reference shape
2N1770	AMR, ASI	4.7A, 25V, 0.03A, 2V	F-47	BTY79, ECG5481, S0315B, 2N4167		 图 F-47
2N1771	AMR, ASI	4.7A, 50V, 0.03A, 2V	F-47	BTY79, ECG5481, S0515B, 2N4168		
2N1771A	GES AMR, ASI	8A, 50V	F-47	2N4169		
JAN2N1771A	GES AMR, ASI	7A, 50V, 0.03A, 2V	F-47	BTY79, ECG5482, S1015B, SK3942, SK5483,		 图 E-2
2N1772	GES AMR, ASI	4.7A, 100V, 0.03A, 2V	F-47	2N4169		
2N1772A	GES AMR, ASI	8A, 100V	F-47	2N4169		
JAN2N1772A	GES AMR, ASI	7A, 100V, 0.03A, 2V	F-47	BTY79, ECG5483, S2015B, SK3942, SK5483,		 图 B 74
2N1773	GES AMR, ASI	4.7A, 150V, 0.03A, 2V	F-47	2N4170		
2N1773A	AMR, ASI	8A, 200V	F-47	2N4170		
2N1774	AMR, ASI	4.7A, 200V, 0.03A, 2V	F-47	BTY79, ECG5483, S2015B, SK3942, SK5483,		 图 E-2
2N1774A	GES AMR, ASI	8A, 200V	F-47	2N4170		
JAN2N1774A	GES AMR, ASI	7A, 200V, 0.03A, 2V	F-47	2N4167, 2N4170		
2N1775	AMR, ASI	4.7A, 250V, 0.03A, 2V	F-47	2N4167		 图 B 74
2N1775A	AMR, ASI	8A, 300V	F-47	BTY79, ECG5485, S4015B, SK3943, SK5485,		
2N1776	AMR, ASI	4.7A, 300V, 0.03A, 2V	F-47	2N4171		
2N1776A	AMR, ASI	8A, 300V	F-47	2N4171		 图 B 74
JAN2N1776A	GES AMR, ASI	7A, 300V, 0.03A, 2V	F-47	BTY79, ECG5485, SK3943, SK5485, 2N4171		
2N1777	GES AMR, ASI	4.7A, 400V, 0.03A, 2V	F-47	2N4171		
JAN2N1777A	GES AMR, ASI	7A, 400V, 0.03A, 2V	F-47	BTY79, ECG5485, S4015B, SK3943, SK5485,		 图 B 74
2N1778	GES AMR, ASI	4.7A, 500V, 0.03A, 2V	F-47	2N4172		
2N1792	AMR, ASI	7A, 400V, 0.03A, 2V	F-47	BTY79, ECG5487, S5015B, 2N4173		
JAN2N1792	INR	4.7A, 500V, 0.03A, 2V	F-47			
2N1793	AMR, ASI	70A, 60V, 0.13A, 3V	E-2	BTW23-600		
		110A, 50V, 0.07A, 3V	B-74			
		70A, 120V, 0.13A, 3V	E-2	BTW23-600		

器件型号 Element type	厂名 Manufacturers	材料用途参数 Material Purpose Parameter	图号 Figure	国内外相似替换器件型号 Replace of similar type	备注 Notes	外形参考图 Reference shape
JAN2N1793	INR	110A, 100V, 0.07A, 3V	B-74			
2N1794	AMR, ASI	70A, 180V, 0.13A, 3V	E-2	BTW23-600		
2N1795	AMR, ASI	70A, 240V, 0.13A, 3V	E-2	BTW23-600		
JAN2N1795	INR	110A, 200V, 0.07A, 3V	B-74			
2N1796	AMR, ASI	70A, 300V, 0.13A, 3V	E-2	BTW23-600		
2N1797	AMR, ASI	70A, 360V, 0.13A, 3V	E-2	BTW23-600		
2N1798	AMR, ASI	70A, 480V, 0.13A, 3V	E-2	BTW23-600		
JAN2N1798	INR	110A, 400V, 0.07A, 3V	B-74			
2N1799	AMR, ASI	70A, 600V, 0.13A, 3V	E-2	BTW23-600, C52M		
JAN2N1799	INR	110A, 500V, 0.07A, 3V	B-74			
2N1800	AMR, ASI	70A, 720V, 0.13A, 3V	E-2	BTW23-600, C52N		
JAN2N1800	INR	110A, 600V, 0.07A, 3V	B-74			
2N1801	AMR, ASI	70A, 700V, 0.13A, 3V	E-2	C525		
2N1802	AMR, ASI	70A, 800V, 0.13A, 3V	E-2	C52N		
2N1803	AMR, ASI	70A, 900V, 0.2A, 3V	E-2	C52T		
2N1804	AMR, ASI	70A, 1kV, 0.2A, 3V	E-2	C52PB		
2N1805	AMR, ASI	70A, 500V, 0.13A, 3V	E-28	C50E		
JAN2N1805	INR	110A, 500V, 0.07A, 3V	F-91			
2N1806	AMR, ASI	70A, 600V, 0.13A, 3V	E-28	C50M		
JAN2N1806	INR	110A, 600V, 0.07A, 3V	F-91			
2N1807	AMR, ASI	70A, 700V, 0.13A, 3V	E-28	C50S		
2N1842	AMR, ASI	50Hz-Thy 10A, 25V, 0.15A, 3.5V	B-60	BTW39-50, BTW45-200R, BTY79, ECG5501, S0315L, SK3579, SK5504, TAG9N400, 16RIA10		
2N1842A	AMR, ASI	10A, 25V, 0.15A, 3.5V	B-60	BTY79, ECG5501, S0315L, SK3579, SK5504, 16RIA10		
2N1842B	AMR, CEN	13A, 25V, 0.075A, 3.5V	F-48	SK3579, SK5504		
2N1843	AMR, ASI	50Hz-Thy 10A, 50V, 0.15A, 3.5V	B-60	BTY79, BTW39-50, BTW45-200R, ECG5501, S0320L, SK3579, SK5504, TAG9N400, 16RIA10		

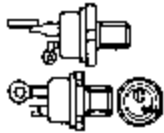

器件型号 Element type	厂名 Manufacturers	材料用途参数 Material Purpose Parameter	图号 Figure	国内外相似替换器件型号 Replace of similar type	备注 Notes	外形参考图 Reference shade
2N1843A	AMR, ASI	10A, 50V, 0.15A, 3.5V	B-60	BTY79, ECG5501, S0520L, SK3579, SK5504, 16RIA10		  用 B-60
2N1843B 2N1844	AMR, CEN AMR, ASI	13A, 50V, 0.075A, 3.5V 50Hz-Thy 10A, 100V, 0.15A, 3.5V	F-48 B-60	ECG5501, SK3579, SK5504 BTY79, BTW39-100, BTW45-200R, ECG5502, S1020L, SK3579, SK5504, TAG9N400, 16RIA10		
2N1844A	AMR, ASI	10A, 100V, 0.15A, 3.5V	B-60	BTY79, ECG5502, S1020L, SK3579, SK5504, 16RIA10		
2N1844B 2N1845	AMR, CEN AMR, ASI	13A, 100V, 0.075A, 3.5V 50Hz-Thy 10A, 150V, 0.15A, 3.5V	F-48 B-60	ECG5502, SK3579, SK5504 BTY79, BTW39-200, BTW45-200R, ECG5504, S2010L, SK3579, SK5504, TAG9N400, 16RIA20		
2N1845A	AMR, ASI	10A, 150V, 0.15A, 3.5V	B-60	BTY79, ECG5504, S2010L, SK3579, SK5504, 16RIA20		
2N1845B 2N1846	AMR, CEN AMR, ASI	13A, 150V, 0.075A, 3.5V 50Hz-Thy 10A, 200V, 0.15A, 3.5V	F-48 B-60	ECG5504, SK3579, SK5504 BTY79, BTW39-200, BTW45-200R, ECG5504, S2010L, SK3579, SK5504, TAG9N400, 16RIA20		
2N1846A	AMR, ASI	10A, 200V, 0.15A, 3.5V	B-60	BTY79, ECG5504, S2010L, SK3579, SK5504, 16RIA20		
2N1846B 2N1847	AMR, CEN AMR, ASI	13A, 200V, 0.075A, 3.5V 50Hz-Thy 10A, 250V, 0.15A, 3.5V	F-48 B-60	ECG5504, SK3579, SK5504 BTY79, ECG5507, BTW39-300, BTW45-300R, S3020L, SK3580, SK5507, TAG9N400, 16RIA40		 用 F-48
2N1847A	AMR, ASI	10A, 250V, 0.15A, 3.5V	B-60	BTY79, ECG5507, S3020L, SK3580, SK5507, 16RIA40		
2N1847B 2N1848	AMR, CEN AMR, ASI	13A, 250V, 0.075A, 3.5V 50Hz-Thy 10A, 300V, 0.15A, 3.5V	F-48 B-60	ECG5507, SK3580, SK5507 BTY79, BTW39-300, BTW45-300R, ECG5507, S3020L, SK3580, SK5507, TAG9N400, 16RIA40		
2N1848A	AMR, ASI	10A, 300V, 0.15A, 3.5V	B-60	BTY79, ECG5507, S3020L, SK3580, SK5507, 16RIA40		
2N1848B	AMR, CEN	13A, 300V, 0.075A, 3.5V	F-48	ECG5507, SK3580, SK5507		

器件型号 Element type	厂名 Manufacturers	材料用途参数 Material Purpose Parameter	图号 Figure	国内外相似替换器件型号 Replace of similar type	备注 Notes	外形参考图 Reference shape
2N1849	AMR, ASI	50Hz-Thy 10A, 400V, 0.15A, 3.5V	B-60	BTY79, BTW39-400, BTW45-400R, ECG5507, S4020L, SK3580, SK5507, TAG9N400, 16RIA40		
2N1849A	AMR, ASI	10A, 400V, 0.15A, 3.5V	B-60	BTY79, ECG5507, S4020L, SK3580, SK5507, 16RIA40		
2N1849B	AMR, CEN	13A, 400V, 0.075A, 3.5V	F-48	ECG5507, SK3580, SK5507		
2N1850	AMR, ASI	50Hz-Thy 10A, 500V, 0.15A, 3.5V	B-60	BTY79, BTW39-500, BTW45-500R, ECG5509, S5020L, SK3504, SK5508, TAG9N600, 16RIA60		
2N1850A	AMR, ASI	10A, 500V, 0.15A, 3.5V	B-60	BTY79, ECG5509, S5020L, SK3504, SK5508, 16RIA60		
2N1850B	AMR, CEN	13A, 500V, 0.075A, 3.5V	F-48	ECG5509, SK3504, SK5508		
2N1869	AMR, CEN	1.25A, 15V, 200 μA, 0.8V	B-55	S0301MS2, 2N4212		
2N1869A	AMR, CRI	50Hz-Thy 1.25A, 15V, 200 μA, 200 μV	B-55	MCR606-2, MCR1906-1, S0301MS2, TAG615-100, 2N2322, 2N6332		
2N1870	AMR, CEN	1.25A, 30V, 200 μA, 0.8V	B-55	S0301MS2, 2N4212		
2N1870A	AMR, CEN	50Hz-Thy 1.25A, 30V, 200 μA, 0.8V	B-55	MCR606-2, MCR1906-1, S0301MS2, TAG615-100, 2N2323, 2N6333		
2N1871		1.6A, 25V, 200 μA, 0.005A	B-55	2N4213		
2N1871A		50Hz-Thy 1.6A, 50V, 200 μA, 0.005A	B-55	MCR606-3, MCR1906-2, TAG615-100, 2N2324, 2N6334		
JAN2N1871A	UNI	0.4A, 60V, 200 μA, 0.8V	B-67			
2N1872	AMR, CEN	1.25A, 100V, 200 μA, 0.8V	B-55	S1001MS2, 2N4214		
2N1872A	UNI	50Hz-Thy 1.25A, 100V, 200 μA, 0.8V	B-55	MCR606-3, MCR1906-3, S1001MS2, TAG615-100, 2N2324, 2N6334		
JAN2N1872A	AMR, CEN	0.4A, 100V, 200 μA, 0.8V	B-67			
2N1873	AMR, CEN	1.25A, 150V, 200 μA, 0.8V	B-55	S2001MS2, 2N4215		
2N1873A	AMR, CEN	50Hz-Thy 1.25A, 150V, 200 μA, 0.8V	B-55	MCR606-4, MCR1906-4, S2001MS2, TAG615-200, 2N2325, 2N4215, 2N6335		
2N1874	AMR, CEN	1.25A, 200V, 200 μA, 0.8V	B-55	S2001MS2, 2N4216		

其他



























器件型号 Element type	厂名 Manufacturers	材料用途参数 Material Purpose Parameter	图号 Figure	国内外相似替换器件型号 Replace of similar type	备注 Notes	外形参考图 Referenced shape
2N1874A	AMR, CEN	50Hz-Thy 1.25A, 200V, 200 μ A, 0.8V	B-55	MCR1906-4, MCR1906-1, S2001MS2, TAG615-200, 2N2326, 2N4216, 2N6336		
JAN2N1874A	UNI	0.4A, 200V, 200 μ A, 0.8V	B-67			
2N1875	AMR, CEN	1.25A, 15V, 20 μ A, 0.6V	B-55	MCR1906-1, S0301MS1, 2N2322		
2N1875A	AMR, CEN	50Hz-Thy 1.25A, 15V, 20 μ A, 0.6V	B-55	MCR1906-1, S0301MS1, 2N2322A		
2N1876	AMR, CEN	1.25A, 30V, 20 μ A, 0.6V	B-55	MCR1906-1, S0301MS1, 2N2322		
2N1876A	AMR, CEN	50Hz-Thy 1.25A, 30V, 20 μ A, 0.6V	B-55	MCR1906-1, S0301MS1, 2N2323A		
2N1877		1.6A, 50V, 20 μ A, 0.003A	B-55	2N2322		
2N1877A		50Hz-Thy 1.6A, 50V, 20 μ A, 0.003A	B-55	MCR1906-2, 2N2324A		
2N1878	AMR, CEN	1.25A, 100V, 20 μ A, 0.6V	B-55	MCR1096-3, S1001MS1, 2N2324		
2N1878A	AMR, CEN	50Hz-Thy 1.25A, 100V, 20 μ A, 0.6V	B-55	MCR1906-3, S1001MS1, 2N2324A		
2N1879	AMR, CEN	1.25A, 150V, 20 μ A, 0.6V	B-55	MCR1096-4, S2001MS1, 2N2326		
2N1879A	AMR, CEN	50Hz-Thy 1.25A, 150V, 20 μ A, 0.6V	B-55	MCR1906-4, S2001MS1, 2N2325A		
2N1880	AMR, CEN	1.25A, 200V, 20 μ A, 0.6V	B-55	MCR1906-4, S2001MS1, 2N2326		
2N1880A	AMR, CEN	50Hz-Thy 1.25A, 200V, 20 μ A, 0.6V	B-55	MCR1906-4, S2001MS1, 2N2326A		
2N1881	AMR, CEN	50Hz-Thy 1.25A, 60V, 0.02A, 80V	B-55	MCR1906-1, MCR1906-2, MCR1906-4, S0301MS3, TAG2-50, TAG614-100		
2N1882	AMR, CEN	50Hz-Thy 1A, 60V, 0.002A, 2V	B-55	MCR1906-2, MCR1906-3, S1001MS3, TAG2-100, TAG614-100		
2N1883	AMR, CEN	50Hz-Thy 1A, 100V, 0.002A, 2V	B-55	MCR1906-3, S1001MS3, TAG2-100, TAG614 100		
2N1884	AMR, CEN	50Hz-Thy 1A, 150V, 0.002A, 2V	B-55	MCR1906-4, S2001MS3, TAG2-200, TAG614-200		
2N1885		1.6A, 200V, 0.0025A, 0.01A	B-55	MCR1906-4, MCR1906-4, TAG2-200, TAG614-200		
2N1908	AMR, ASI	70A, 25V, 0.13A, 3V	F-91	BTW23-600, 71RC30A		
2N1910	AEI, AMR	70A, 50V, 0.13A, 3V	E-28	BTW23-600, 71RC30A		
2N1911	INI, AMR	70A, 100V, 0.13A, 3V	E-28	BTW23-600, 71RC30A		
JAN2N1911	INR	110A, 100V, 0.07A, 3V	F-91			
2N1912	AEI, AMR	70A, 150V, 0.13A, 3V	E-28	BTW23-600, 71RC30A		
2N1913	AEI, AMR	70A, 200V, 0.13A, 3V	E-28	BTW23-600, 71RC30A		

图 B-55

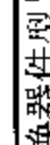
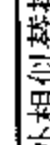
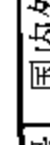

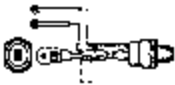
图 B-67

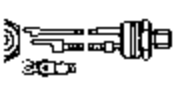
图 F-91

图 E-28

器件型号 Element type	厂名 Manufacturers	材料用途参数 Material Purpose Parameter	图号 Figure	国内外相似替换器件型号 Replace of similar type	备注 Notes	外形参考图 Reference shape
JAN2N1913	INR	110A, 200V, 0.07A, 3V	F-91			
2N1914	AEI, AMR	70A, 250V, 0.13A, 3V	E-28	BTW23-600, 71RC30A		
2N1914A	AMR, CRI	70A, 250V, 0.13A, 3V	F-91			
2N1915	AEI, AMR	70A, 300V, 0.13A, 3V	E-28	BTW23-600, 71RC30A		
JAN2N1915	INR	110A, 300V, 0.07A, 3V	F-91			
2N1916	AEI, AMR	70A, 400V, 0.13A, 3V	E-28	BTW23-600, 71RC60A		
JAN2N1916	INR	110A, 400V, 0.07A, 3V	F-91			
2N1929	AHR, CRI	0.75A, 25V, 0.03A, 2V	F-63	C11U, ECG5400, SK3950, SK5400		
2N1930	AHR, CRI	0.75A, 50V, 0.03A, 2V	F-63	C11F		
2N1931	AHR, CRI	0.75A, 100V, 0.03A, 2V	F-63	C11A, ECG5483, SK3942, SK5483		
2N1932	AHR, CRI	0.75A, 150V, 0.03A, 2V	F-63	C11G, ECG5483, SK3942, SK5483		
2N1933	CRI, IPE	0.75A, 200V, 0.03A, 2V	F-63	C11B, ECG5483, SK3942, SK5483		
2N1934	AMR, CRI	0.75A, 250V, 0.03A, 2V	F-63	C11H		
2N1935	AMR, IPE	0.75A, 300V, 0.03A, 2V	F-63	C11C		
2N2009	AMR, CEN	50Hz-Thy 1.3A, 25V, 200μA, 1V	B-55	C5U, MCR606-2, S0301MS2, TAG615-100, 2N2322, 2N4212, 2N6332		
2N2010	AMR, CEN	50Hz-Thy 1.3A, 50V, 200μA, 1V	B-55	C5F, MCR606-2, S0501MS2, TAG615-100, 2N2323, 2N4212, 2N4213, 2N6333		
2N2011	AMR, CEN	50Hz-Thy 1.3A, 100V, 200μA, 1V	B-55	C5A, MCR606-3, S1001MS2, TAG615-100, 2N2324, 2N4214, 2N6334		
2N2012	AMR, CEN	50Hz-Thy 1.3A, 200V, 200μA, 1V	B-55	C5B, MCR606-4, S2001MS2, TAG615-200, 2N2325, 2N4216, 2N6335		
2N2013	AMR, CEN	50Hz Thy 1.3A, 300V, 200μA, 1V	B-55	C5C, MCR606-5, S4001MS2, TAG615-300, 2N2328, 2N4218, 2N6336		
2N2014	AMR, CEN	50Hz-Thy 1.3A, 400V, 200μA, 1V	B-55	C5D, MCR606 6, S4001MS2, TAG615 400, 2N2329, 2N4219, 2N6337		

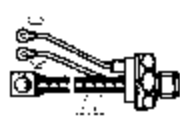

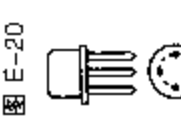
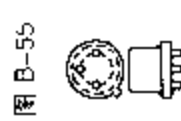

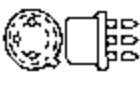
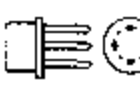
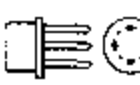
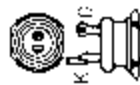
器件型号 Element type	厂名 Manufacturers	材料用途参数 Material Purpose Parameter	图号 Figure	国内外相似替换器件型号 Replace of similar type	备注 Notes	外形参考图 Reference shape
2N2023	AEI, AMR	70A, 25V, 0.15A, 3V	E-28	BTW23-600		 图 E-28  图 F-91  图 E-20  图 B-55  图 B-51
2N2024	AEI, AMR	70A, 50V, 0.15A, 3V	E-28	BTW23-600		
JAN2N2024	INR	70A, 50V, 0.07A, 3V	F-91			
2N2025	AEI, AMR	70A, 100V, 0.15A, 3V	E-28	BTW23-600		
JAN2N2025	INR	70A, 100V, 0.07A, 3V	F-91			
2N2026	AEI, AMR	70A, 150V, 0.15A, 3V	E-28	BTW23-600		
2N2027	AEI, AMR	70A, 200V, 0.15A, 3V	E-28	BTW23-600		
JAN2N2027	INR	70A, 200V, 0.07A, 3V	F-91			
2N2028	AEI, AMR	70A, 250V, 0.15A, 3V	E-28	BTW23-600		
2N2029	AEI, AMR	70A, 300V, 0.15A, 3V	E-28	BTW23-600		
JAN2N2029	INR	70A, 300V, 0.07A, 3V	F-91			
2N2030	AEI, AMR	70A, 400V, 0.15A, 3V	E-28	BTW23-600		
JAN2N2030	INR	70A, 400V, 0.07A, 3V	F-91			
2N2031	AMR, CRI	70A, 50V, 0.13A, 3V	E-28			
JAN2N2031	NON	110A, 50V, 0.07A, 3V	F-91			
2N2044	AMR, CRI	150A, 200V, 0.15A, 3V	E-20			
2N2045	AMR, CRI	150A, 300V, 0.15A, 3V	E-20			
2N2046	AMR, CRI	150A, 400V, 0.15A, 3V	E-20			
2N2047	AMR, CRI	150A, 500V, 0.15A, 3V	E-20			
2N2260		GTO, 0.2A, 30V, 250 μ A				
2N2261		GTO, 0.2A, 30V, 500 μ A				
2N2262		GTO, 0.2A, 30V, 0.005A				
2N2322	AMR, ASI	50Hz-Thy 1.6A, 25V, 350 μ A, 1V	B-55	MCR606-2, TAG615-100, 2N6332		
2N2322A	AMR, ASI	50Hz-Thy 1.6A, 25V, 75 μ A, 0.9V	B-51	S0301MS1		
2N2323	AMR, ASI	50Hz-Thy 1.6A, 50V, 350 μ A, 1V	B-55	MCR606-2, TAG615-100, 2N6333		
2N2323A	AMR, ASI	50Hz-Thy 1.6A, 50V, 75 μ A, 0.9V	B-51	S0501MS1		

器件型号 Element type	厂名 Manufacturers	材料用途参数 Material Purpose Parameter	图号 Figure	国内外相似替换器件型号 Replace of similar type	备注 Notes	外形参考图 Reference shape	
JAN2N2323	GES, UNI	0.22A, 50V, 350 μ A, 1V	B-51			 图 B-51	
JAN2N2323A	GES, UNI	0.22A, 50V, 350 μ A, 1V	B-51				
2N2324	ASI, CEN	50Hz-Thy 1.6A, 100V, 350 μ A, 1V	B-55	MCR606-3, TAG615-100, 2N6334		 图 B-55	
2N2324A	AMR, ASI	50Hz-Thy 1.6A, 100V, 75 μ A, 0.9V	B-51	S1001MS1			
JAN2N2324	GES, UNI	0.22A, 100V, 350 μ A, 1V	B-51				
JAN2N2324A	GES, UNI	0.22A, 100V, 350 μ A, 1V	B-51				
2N2325	AMR, ASI	50Hz-Thy 1.6A, 150V, 350 μ A, 1V	B-55	MCR606-4, TAC615-200, 2N6335			
2N2325A	AMR, ASI	50Hz-Thy 1.6A, 150V, 75 μ A, 0.9V	B-51	S2001MS1			
2N2326	AMR, ASI	50Hz-Thy 1.6A, 200V, 350 μ A, 1V	B-55	MCR606-4, TAG615-200, 2N6335			
2N2326A	AMR, ASI	50Hz-Thy 1.6A, 200V, 70 μ A, 0.9V	B-51	S2001MS1			
JAN2N2326	GES, UNI	0.22A, 200V, 350 μ A, 1V	B-51				
JAN2N2326A	GES, UNI	0.22A, 200V, 350 μ A, 1V	B-51				
2N2327	AMR, ASI	50Hz-Thy 1.6A, 250V, 350 μ A, 1V	B-55	MCR606-5, TAG615-300, 2N6336		 图 B-55	
2N2327A	AMR, ASI	50Hz-Thy 1.6A, 250V, 75 μ A, 0.9V	B-51	S4001MS1			
2N2328	AMR, ASI	50Hz-Thy 1.6A, 300V, 350 μ A, 1V	B-55	MCR606-5, TAG615-300, 2N6336			
2N2328A	AMR, ASI	50Hz Thy 1.6A, 300V, 75 μ A, 0.9V	B-51	S4001MS1			
JAN2N2328	GES, UNI	0.22A, 300V, 350 μ A, 1V	B-51				
JAN2N2328A	UNI	0.22A, 300V, 350 μ A, 1V	B-51				
2N2329	AMR, ASI	50Hz-Thy 1.6A, 400V, 350 μ A, 1V	B-55	MCR606-6, TAG615-400, 2N6337			 图 F-21
2N2329A	AMR, ASI	50Hz-Thy 1.6A, 400V, 75 μ A, 0.9V	B-51	S4001MS1			
JAN2N2329	GES, UNI	0.22A, 400V, 350 μ A, 1V	B-51				
2N2344	AMR, ASI	50Hz-Thy 1.6A, 25V, 75 μ A, 1V	B-55	BTX18-100, MCR1906-1, S0301MS1, 2N2322A			
2N2345	AMR, ASI	50Hz-Thy 1.6A, 50V, 75 μ A, 1V	B-55	BTX18-100, MCR1906-2, S0501MS1, 2N2323A			
2N2346	AMR, ASI	50Hz-Thy 1.6A, 100V, 75 μ A, 1V	B-55	BTX18-100, MCR1906-3, S1001MS1, 2N2324A			
2N2347	AMR, ASI	50Hz-Thy 1.6A, 150V, 75 μ A, 1V	B-55	BTX18-100, MCR1906-4, S2001MS1, 2N2325A			
2N2348	AMR, ASI	50Hz-Thy 1.6A, 200V, 75 μ A, 1V	B-55	BTX18-100, MCR1906-4, S2001MS1, 2N2326A			
2N2454	AMR, CRI	3A, 400V, 0.02A, 3V	F-21	ECG5474			

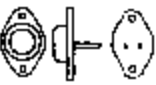
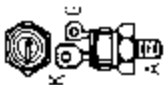

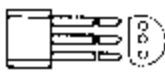
器件型号 Element type	厂名 Manufacturers	材料用途参数 Material Purpose Parameter	图号 Figure	国内外相似替换器件型号 Replace of similar type	备注 Notes	外形参考图 Reference shape
2N2503	AMR, ASI	150A, 50V, 0.15A, 3V	F-91			 图 F-91
2N2504	AMR, ASI	150A, 100V, 0.15A, 3V	F-91			
2N2505	AMR, ASI	150A, 200V, 0.15A, 3V	F-91			
2N2506	AMR, ASI	150A, 1kV, 0.15A, 3V	F-91			
2N2507	AMR, ASI	150A, 400V, 0.15A, 3V	F-91			
2N2508	AMR, ASI	150A, 500V, 0.15A, 3V	F-91			
2N2542	AMR, CRI	205A, 50V, 0.15A, 3V	F-91			
2N2543	AMR, CRI	205A, 100V, 0.15A, 3V	F-91			
2N2544	AMR, CRI	205A, 200V, 0.15A, 3V	F-91			
2N2545	AMR, HTN	205A, 300V, 0.15A, 3V	F-91			 图 D-9
2N2546	AMR, CRI	205A, 400V, 0.15A, 3V	F-91			
2N2547	CRI, HTN	205A, 500V, 0.15A, 3V	F-91			
2N2548	AMR, CRI	205A, 600V, 0.15A, 3V	F-91			
2N2549	AMR, CRI	205A, 800V, 0.15A, 3V	F-91			
2N2550	AMR, CRI	205A, 1kV, 0.15A, 3V	F-91			
2N2573	AMR, CRI	50Hz-Thy 16A, 25V, 0.04A, 3.5V	D-9	C232U, MCR649A9-1, S0325C, 2N3668		
2N2574	AMR, CRI	50Hz-Thy 16A, 50V, 0.04A, 3.5V	D-9	C232F, MCR649A9-2, S0525C, 2N3668		
2N2575	AMR, CRI	50Hz-Thy 16A, 100V, 0.04A, 3.5V	D-9	C232A, MCR649A9-3, S1025C, 2N3668		
2N2576	AMR, CRI	50Hz-Thy 16A, 200V, 0.04A, 3.5V	D-9	C232B, MCR649A9-4, S2025C, 2N3668		
2N2577	AMR, CRI	50Hz-Thy 16A, 300V, 0.04A, 3.5V	D-9	C232C, MCR649A9-5, S4025C, 2N3670		
2N2578	AMR, CRI	50Hz-Thy 16A, 400V, 0.04A, 3.5V	D-9	C232D, MCR649A9-6, S4025C, 2N3670		
2N2579	AMR, CRI	50Hz-Thy 16A, 500V, 0.04A, 3.5V	D-9	C232E, MCR649A9-7, S6025C		 图 F-47
2N2619	AMR, ASI	4.7A, 600V, 0.03A, 2V	F-47	ECG5478, S6015B		
2N2653	AMR, CRI	3A, 400V, 0.02A, 3V	F-47	C15D, ECG5474, 2N4172		

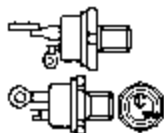
器件型号 Element type	厂名 Manufacturers	材料用途参数 Material Purpose Parameter	图号 Figure	国内外相似替换器件型号 Replace of similar type	备注 Notes	外形参考图 Reference shape
2N2679	AMR, ASI	50Hz-Thy 0.35A, 30V, 100 μ A, 0.9V	B-36	ECG5400, MCR102, MCR202, S0301MS1, SK3950, SK5400, TAG06Y, 2N2323A		 图 B-36
2N2679A	AMR, CEN	SCR-H 0.35A, 30V, 20 μ A, 0.7V	B-65			
2N2680	AMR, ASI	50Hz-Thy 0.35A, 60V, 100 μ A, 0.9V	B-36	ECG5401, MCR103, SK3638, SK5402, S1001MS1, 2N2324A		
2N2680A	AMR, CEN	SCR-H 0.35A, 60V, 20 μ A, 0.7V	B-65	ECG5401		
2N2681	AMR, ASI	50Hz-Thy 0.35A, 100V, 100 μ A, 0.9V	B-36	MCR204, S1001MS1, TAG06A, 2N5062, 2N2324A		
2N2681A	AMR, CEN	SCR-H 0.35A, 100V, 20 μ A, 0.7V	B-65			
2N2682	AMR, ASI	50Hz-Thy 0.35A, 200V, 100 μ A, 0.9V	B-36	S2001MS1, 2N2326A, 2N5064		
2N2682A	AMR, CEN	SCR-H 0.35A, 200V, 20 μ A, 0.7V	B-65			
2N2683	AMR, ASI	50Hz-Thy 0.28A, 30V, 20 μ A, 0.8V	B-36	MCR102, MCR202, S0301MS1, 2N2323A		
2N2683A	AMR, CEN	SCR-H 0.35A, 30V, 20 μ A, 0.7V	B-65			
2N2684	AMR, ASI	50Hz-Thy 0.28A, 60V, 20 μ A, 0.8V	B-36	MCR103, S1001MS1, 2N2324A		 图 B-65
2N2684A	AMR, CEN	SCR-H 0.35A, 60V, 20 μ A, 0.7V	B-65			
2N2685	AMR, ASI	50Hz-Thy 0.28A, 100V, 20 μ A, 0.8V	B-36	MCR204, S1001MS1, 2N2324A, 2N5062		
2N2685A	AMR, CEN	SCR-H 0.35A, 100V, 20 μ A, 0.7V	B-65			
2N2686	AMR, ASI	50Hz-Thy 0.28A, 200V, 20 μ A, 0.8V	B-36	S2001MS1, 2N2326A		
2N2686A	AMR, ASI	SCR H 0.35A, 200V, 20 μ A, 0.7V	B-65			
2N2687	AMR, ASI	50Hz-Thy 0.28A, 30V, 200 μ A, 1V	B-36	C103Y, EC103Y, ECG5400, MCR202, SK3950, SK5400, TAG06Y, TAG615-100, 2N2323, 2N6605		
2N2688	AMR, ASI	50Hz-Thy 0.28A, 60V, 200 μ A, 1V	B-65	C103F, EC103A, ECG5401, SK3638, SK5402, TAG06YY, TAG615-100, 2N2324, 2N6606		 图 F-18
2N2689	AMR, ASI	50Hz-Thy 0.28A, 100V, 200 μ A, 1V	B-65	C103A, EC103A, ECG5402, MCR204, SK3638, SK5402, TAG06A, TAG615-100, 2N6607, 2N2324		
2N2690	ASI, CEN	50Hz-Thy 0.28A, 200V, 200 μ A, 1V	B-65	C103B, EC103B, ECG5404, SK3627, SK5404, TAG06B, TAG615-200, 2N2326, 2N6608		
2N2688	AMR, CRI	50Hz-Thy 16A, 200V, 0.08A, 3V	F-4B	C35B, C140B, ECG5524, MCR3935-4, SK6624, SK5524, T12N200, 2N686		

其他

器件型号 Element type	厂名 Manufacturers	材料用途参数 Material Purpose Parameter	图号 Figure	国内外相似替换器件型号 Replace of similar type	备注 Notes	外形参考图 Reference shape
2N2889	AMR, CRI	50Hz-Thy 16A, 250V, 0.08A, 3V	F-48	C35H, C140C, ECG5527, MCR3935-5, SK6627, SK5527, T12N300, 2N686		
2N3001	AMR, ASI	50Hz-Thy 0.25A, 30V, 20 μ A, 0.7V	B-65	EC103Y, MCR202, 2N885, 2N2323A		
2N3002	AMR, ASI	50Hz-Thy 0.25A, 60V, 20 μ A, 0.7V	B-65	EC103A, MCR203, 2N886, 2N2324A		
2N3003	AMR, ASI	50Hz-Thy 0.25A, 100V, 20 μ A, 0.7V	B-65	EC103A, MCR204, 2N887, 2N2324A		
2N3004	AMR, ASI	50Hz-Thy 0.25A, 200V, 20 μ A, 0.7V	B-65	EC103B, MCR206, 2N889, 2N2326A		
2N3005	AMR, ASI	50Hz-Thy 0.25A, 30V, 200 μ A, 0.8V	B-65	EC103Y, ECG5400, MCR202, SK3950, SK5400, TAG06Y, TAG615-100, 2N877, 2N2323, 2N6605		
2N3006	AMR, ASI	50Hz-Thy 0.25A, 60V, 200 μ A, 0.8V	B-65	EC103A, ECG5401, MCR203, SK3638, SK5402, TAG06YY, TAG615-100, 2N878, 2N2324, 2N6606		
2N3007	AMR, ASI	50Hz-Thy 0.25A, 100V, 200 μ A, 0.8V	B-65	EC103A, ECG5402, MCR204, SK3638, SK5402, TAG06A, TAG615-100, 2N879, 2N2324, 2N6607		
2N3008	AMR, ASI	50Hz-Thy 0.25A, 200V, 200 μ A, 0.8V	B-65	EC103B, ECG5404, MCR206, SK3627, SK5404, TAG06B, TAG615-200, 2N880, 2N2326, 2N6608		
2N3027	AMR, CRI	SCR-H 0.5A, 30V, 0.0012A, 1.1V	B-65	BR103, BRX44, ECG5400, MCR202, S0301MS2, SK3950, SK5400, TAG60Y, TAG64Y, TAG62Y, 2N877		
JAN2N3027	UNI	0.175A, 30V, 200 μ A, 0.8V	B-65	BRX46, BRX51, ECG5401, MCR203, S1001MS2, SK3638, SK5402, TAG62F, TAG64F, TAG60F, 2N878		
2N3028	AMR, CRI	SCR-H 0.5A, 60V, 0.0012A, 1.1V	B-65			
JAN2N3028	UNI	0.175A, 60V, 200 μ A, 0.8V	B-65	BRX46, BRX51, ECG5402, MCH204, S1001MS2, SK3638, SK5402, TAG64A, TAG60A, TAG62A, 2N879		
2N3029	AMR, CRI	SCR-H 0.5A, 100V, 0.0012A, 1.1V	B-65			
JAN2N3029	UNI	0.175A, 100V, 200 μ A, 0.8V	B-65			
2N3030	AMR, CRI	SCR-H 0.5A, 30V, 20 μ A, 0.6V	B-65	ECG5400, MCR202, S0301MS1, SK3950, SK5400		







图 F-48



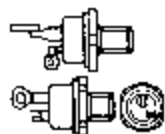

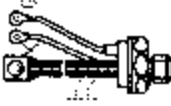



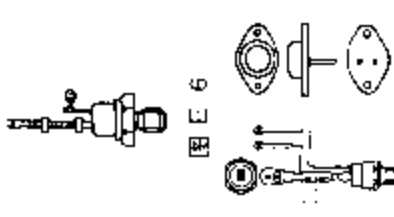
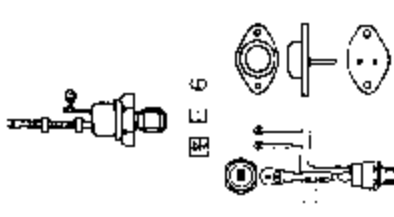
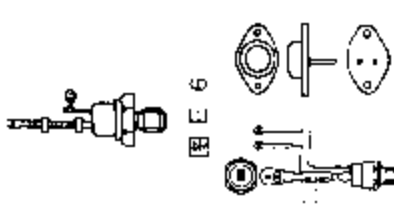
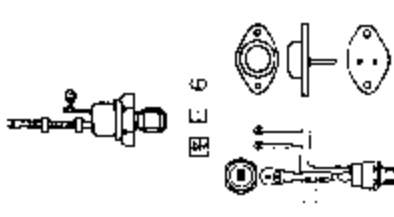
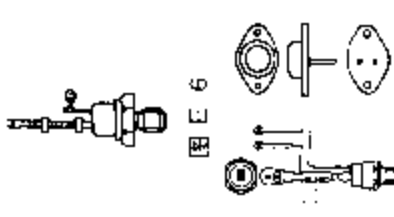
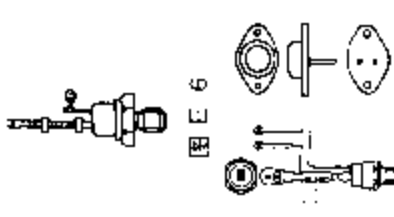
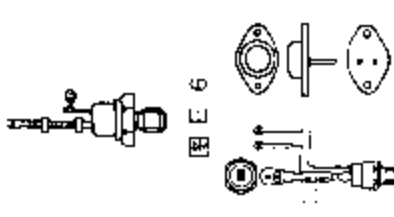
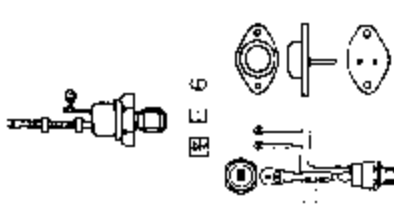
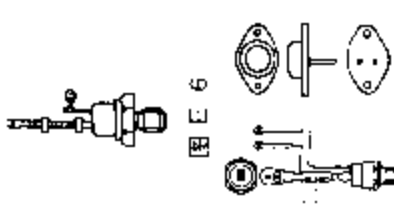
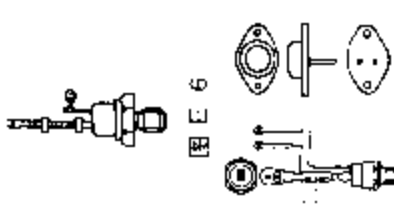
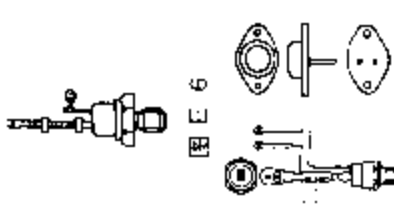
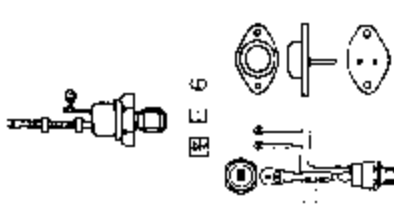
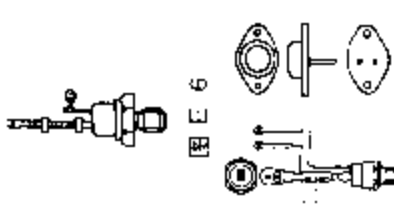
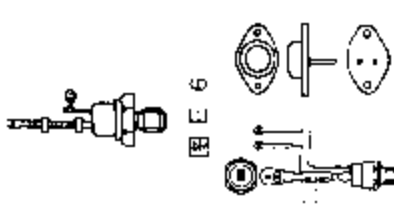
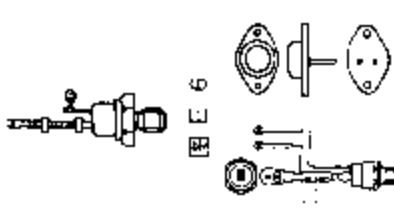
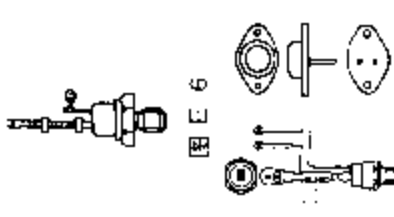
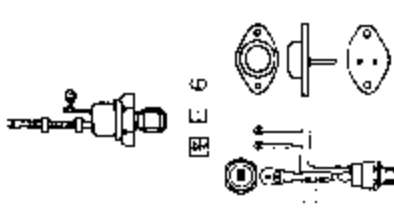
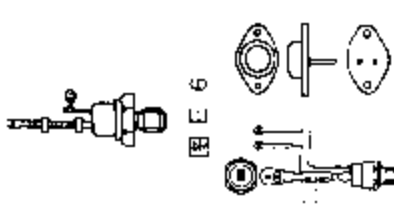
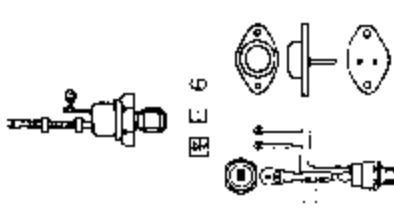
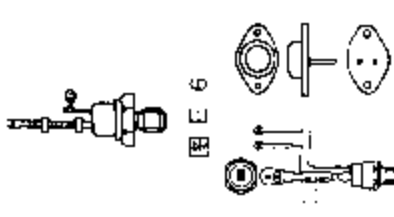



















图 B-65

器件型号 Element type	厂名 Manufacturers	材料用途参数 Material Purpose Parameter	图号 Figure	国内外相似替换器件型号 Replace of similar type	备注 Notes	外形参考图 Reference shape
JAN2N3030	UNI	0.175A, 30V, 20 μ A, 0.6V	B-65	ECG5401, MCR203, S1001MS1, SK3638, SK5402		 图 B-65
2N3031	AMR, CRI	SCR-H 0.5A, 60V, 20 μ A, 0.6V	B-65			
JAN2N3031	UNI	0.175A, 60V, 20 μ A, 0.6V	B-65	ECG5402, MCR204, S1001MS1, SK3638, SK5402		
2N3032	AMR, CRI	SCR-H 0.5A, 100V, 20 μ A, 0.6V	B-65			
JAN2N3032	UNI	0.175A, 100V, 20 μ A, 0.6V	B-65			
2N3091	AMR, ASI	70A, 600V, 0.2A, 3V	E-28	ECG5572		 图 E-28
JAN2N3091	INR	78.5A, 600V, 0.07A, 3V	F-91			
2N3092	AMH, ASI	70A, 700V, 0.2A, 3V	E-28	ECG5574		
2N3093	AMR, ASI	70A, 800V, 0.2A, 3V	E-28	ECG5574		
JAN2N3093	INR	78.5A, 800V, 0.07A, 3V	F-91			
2N3094	AMR, ASI	70A, 900V, 0.2A, 3V	E-28	ECG5574		
2N3095	AMR, ASI	70A, 1kV, 0.2A, 3V	E-28	ECG5574		
JAN2N3095	INR	78.5A, 1kV, 0.07A, 3V	F-91			
2N3096	AMR, ASI	70A, 1.1kV, 0.2A, 3V	E-28	ECG5574		
2N3097	AMR, ASI	70A, 1.2kV, 0.2A, 3V	E-28	FCG5574		
JAN2N3097	INR	78.5A, 1.2kV, 0.07A, 3V	F-91			
2N3098		110A, 1.2kV	E-28			 图 F-91
JAN2N3098	NON	70.5A, 1.3kV, 0.07A, 3V	F-91			
2N3099	AMR, ASI	70A, 600V, 0.2A, 3V	E-6			
JAN2N3099	NON	78.5A, 600V, 0.07A, 3V	F-91			
2N3100	AMR, ASI	70A, 700V, 0.2A, 3V	E-6			
2N3101	AMR, ASI	70A, 800V, 0.2A, 3V	E-6			
2N3102	AMR, ASI	70A, 900V, 0.2A, 3V	E-6			
2N3103	AMR, ASI	70A, 1kV, 0.2A, 3V	E-6			
JAN2N3103	NON	78.5A, 1kV, 0.07A, 3V	F-91			
2N3104	AMR, ASI	70A, 1.1kV, 0.2A, 3V	E-6			
2N2105	AMR, ASI	70A, 1.2kV, 0.2A, 3V	E-6			
JAN2N3105	NON	78.5A, 1.2kV, 0.07A, 3V	F-91			 图 E-6





器件型号 Element type	厂名 Manufacturers	材料用途参数 Material Purpose Parameter	图号 Figure	国内外相似替换器件型号 Replace of similar type	备注 Notes	外形参考图 Reference shape
2N3106 JAN2N3106	AMR, ASI NON	70A, 1.3kV, 0.2A, 3V 70.5A, 1.3kV, 0.07A, 3V	E-6 F-91			
2N3228	AMR, ASI	50Hz-Thy 3.2A, 200V, 0.015A, 2V	D-9	BS10513L, ECG5511, S2008L, SK3683, SK5511, TAG671-200, 2N3525, 2N4101, 2N4170		
2N3254	AMR, ASI	SCR-H 0.25A, 15V, 20 μA, 0.75V	B-52	MCR202, S0301MS1, 2N2322A		
2N3255	AMR, ASI	SCR H 0.25A, 30V, 20 μA, 0.75V	B-52	MCR202, S0301MS1, 2N2323A		
2N3256	AMR, ASI	SCR-H 0.25A, 60V, 20 μA, 0.75V	B-52	MCR203, S1001MS1, 2N2324A		
2N3257	AMR, ASI	SCR-H 0.25A, 15V, 200 μA, 0.75V	B-52	BRY58, BRY30, MCR202, TAG06Y, TIC44, 2N2322, 2N5060, 2N6605		
2N3258	AMR, ASI	SCR-H 0.25A, 30V, 200 μA, 0.75V	B-52	BRY58, BRY30, MCR202, TAG06Y, TIC44, 2N2323, 2N5060, 2N6605		
2N3259	AMR, ASI	SCR-H 0.25A, 60V, 200 μA, 0.75V	B-52	BRY58, BRY60, ECG5401, MCR203, SK3638, SK5402, TAG06YY, TIC46, 2N5062, 2N6606		
2N3269	AMR, CRI	6A, 100V, 200 μA, 0.8V	F-59	2N4169		
2N3270	AMR, CRI	6A, 200V, 200 μA, 0.8V	F-59	2N4170		
2N3271	AMR, CRI	6A, 300V, 200 μA, 0.8V	F-59	2N4171		
2N3272	AMR, CRI	6A, 400V, 200 μA, 0.8V	F-59	2N4172		
2N3273	AMR, ASI	50Hz-Thy 2.2A, 100V, 200 μA, 0.8V	B-51	C106A1, S1001MS2, TAG106A, TAG108A, X0403A		
2N3274	AMR, ASI	50Hz-Thy 2.2A, 200V, 200 μA, 0.8V	B-51	C106B1, S2001MS2, TAG106B, TAG108B, X0403B		
2N3275	AMR, ASI	50Hz-Thy 2.2A, 300V, 200 μA, 0.8V	B-51	C106C1, S4001MS2, TAG106C, TAG108C, X0403C		
2N3276	AMR, ASI	50Hz-Thy 2.2A, 400V, 200 μA, 0.8V	B-51	C106D1, S4001MS2, TAG106D, TAG108D, X0403D		
2N3353	AMR, CRI	250A, 50V, 0.4A, 4V	F-71			
2N3354	AMR, CRI	250A, 100V, 0.4A, 4V	F-71			
2N3355	AMR, CRI	250A, 200V, 0.4A, 4V	F-71	2N4212		
2N3356	AMR, CRI	250A, 300V, 0.4A, 4V	F-71	2N4213		

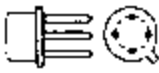
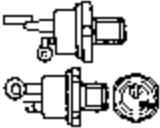

器件型号 Element type	厂名 Manufacturers	材料用途参数 Material Purpose Parameter	图号 Figure	国内外相似替换器件型号 Replace of similar type	备注 Notes	外形参考图 Reference shape
2N3357	AMR, CRI	250A, 400V, 0.4A, 4V	F-71	2N4214		
2N3358	AMR, CRI	250A, 500V, 0.4A, 4V	F-71	2N4216		
2N3359	AMR, CRI	250A, 600V, 0.4A, 4V	F-71	2N4212		
2N3360	AMR, CRI	250A, 700V, 0.4A, 4V	F-71	2N4213		
2N3361	AMR, CRI	250A, 800V, 0.4A, 4V	F-71	2N4214		
2N3362	AMR, CRI	250A, 900V, 0.4A, 4V	F-71	2N4216		
2N3363	AMR, CRI	250A, 1kV, 0.4A, 4V	F-71	2N4212		
2N3525	AMR, ASI	50Hz-Thy 3.2A, 400V, 0.015A, 2V	D-9	BS1C0526L, ECG5512, S4008L, SK3684, SK5512, TAG671-400, TAG676-400, 2N4101, 2N4171		  
2N3528	AMR, ASI	1.3A, 200V, 0.015A, 2V	B-50	ECG5641, S2003M, SK3850, 2N4186		
2N3529	AMR, ASI	1.3A, 400V, 0.015A, 2V	B-50	S4003M, SK3851, 2N4188		
2N3530	AMR, CRI	250A, 50V, 0.4A, 4V	E-18			
2N3531	AMR, CRI	250A, 100V, 0.4A, 4V	E-18			
2N3532	AMR, CRI	250A, 200V, 0.4A, 4V	E-18			
2N3533	AMR, CRI	250A, 300V, 0.4A, 4V	E-18			
2N3534	AMR, CRI	250A, 400V, 0.4A, 4V	E-18			
2N3535	AMR, CRI	250A, 500V, 0.4A, 4V	E-18			
2N3536	AMR, CRI	250A, 600V, 0.4A, 4V	E-18			
2N3537	AMR, CRI	250A, 700V, 0.4A, 4V	E-18			
2N3538	AMR, CRI	250A, 800V, 0.4A, 4V	E-18			
2N3539	AMR, CRI	250A, 900V, 0.4A, 4V	E-18			
2N3540	AMR, CRI	250A, 1kV, 0.4A, 4V	E-18			
2N3555	AMR, ASI	50Hz-Thy 1.6A, 30V, 20 μA, 0.7V	B-55	S0301MS1, 2N2323A, 2N4212		
2N3556	AMR, ASI	50Hz-Thy 1.6A, 60V, 20 μA, 0.7V	B-55	2N2324A, 2N4213		
2N3557	AMR, ASI	50Hz-Thy 1.6A, 100V, 20 μA, 0.7V	B-55	2N2324A, 2N4214		
2N3558	AMR, ASI	50Hz-Thy 1.6A, 200V, 20 μA, 0.7V	B-55	2N2326A, 2N4216		

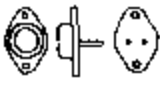
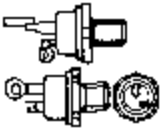

其他

器件型号 Element type	厂名 Manufacturers	材料用途参数 Material Purpose Parameter	图号 Figure	国内外相似替换器件型号 Replace of similar type	备注 Notes	外形参考图 Reference shape
2N3559	AMR, ASI	50Hz-Thy 1.6A, 30V, 200 μ A, 0.8V	B-55	MCR606-2, S0301MS2, TAG615-100, 2N2323, 2N4212, 2N6333		 图 B-55
2N3560	AMR, ASI	50Hz-Thy 1.6A, 60V, 200 μ A, 0.8V	B-55	MCR606-3, S1001MS2, TAG615-100, 2N2324, 2N4213, 2N6334		
2N3561	AMR, ASI	50Hz-Thy 1.6A, 100V, 200 μ A, 0.8V	B-55	MCR606-3, S1001MS2, TAG615-100, 2N2324, 2N4214, 2N6334		
2N3562	AMR, ASI	50Hz-Thy 1.6A, 200V, 200 μ A, 0.8V	B-55	ECG108, MCR606-4, S2001MS2, SK3452/106, TAG615-200, 2N2326, 2N4216, 2N6335		
2N3649	AMR, ASI	SCR-H 16A, 50V, 0.5A, 4.5V	F-48	BTW28-500R, BTW30-800RS, CS15.9-04, ECG5360, S0535H		 图 F-48
2N3650	AMR, ASI	SCR-H 16A, 100V, 0.5A, 4.5V	F-48	BTW28-500R, BTW30-800RS, CS15.9-04, ECG5360, S1035H		
2N3651	AMR, ASI	SCR-H 16A, 200V, 0.5A, 4.5V	F-48	BTW28-500R, BTW30-800RS, CS15.9-04, ECG5360, S2035H		
2N3652	AMR, ASI	SCR-H 16A, 300V, 0.5A, 4.5V	F-48	BTW28-500R, BTW30-800RS, CS15.9-04, ECG5360, S3035H		
2N3653	AMR, ASI	SCR-H 16A, 400V, 0.5A, 4.5V	F-48	BTW28-500R, BTW30-800RS, CS15.9-04, ECG5360, S4035H		
2N3654	AMR, ASI	SCR-H 16A, 50V, 0.5A, 4.5V	F-48	BTW28-500R, BTW30-800RS, CS15.9-04, ECG5360, S0535H		
2N3655	AMR, ASI	SCR-H 16A, 100V, 0.5A, 4.5V	F-48	BTW28-500R, BTW30-800RS, CS15.9-04, ECG5360, S1035H		
2N3656	AMR, ASI	SCR-H 16A, 200V, 0.5A, 4.5V	F-48	BTW28-500R, BTW30-800RS, CS15.9-04, ECG5360, S2035H		
2N3657	AMR, ASI	SCR-H 16A, 300V, 0.5A, 4.5V	F-48	BTW28-500R, BTW30-800RS, CS15.9-04, ECG5360, S3035H		
2N3658	AMR, ASI	SCR-H 16A, 400V, 0.5A, 4.5V	F-48	BTW28-500R, BTW30-800RS, CS15.9-04, ECG5360, S4035H		



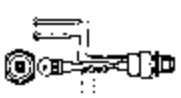
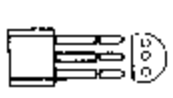

器件型号 Element type	厂名 Manufacturers	材料用途参数 Material Purpose Parameter	图号 Figure	国内外相似替换器件型号 Replace of similar type	备注 Notes	外形参考图 Reference shape
2N3668	AMR, ASI	50Hz-Thy 8A, 100V, 0.08A, 3V	D-9	S0515L, SK3527, 2N2575		 图 D-9
2N3669	AMR, ASI	50Hz-Thy 8A, 200V, 0.08A, 3V	D-9	S4015L, SK3527, 2N2576		
2N3670	AMR, CRI	50Hz-Thy 8A, 400V, 0.08A, 3V	D-9	SK3898/314, 2N2578		
2N3753	AMR, DIT	7.5A, 50V, 0.2A, 3V	F-48	ECG5491, S0515H, SK5491, SK6791		 图 F-48
2N3754	AMR, ASI	7.5A, 100V, 0.2A, 3V	F-48	S1015H		
2N3755	AMR, ASI	7.5A, 200V, 0.2A, 3V	F-48	S2015H		
2N3756	AMR, ASI	7.5A, 300V, 0.2A, 3V	F-48	S4015H		
2N3757	AMR, ASI	7.5A, 400V, 0.2A, 3V	F-48	S6015H		
2N3758	AMR, ASI	7.5A, 500V, 0.2A, 3V	F-48	S6015H		
2N3759	AMR, ASI	7.5A, 600V, 0.2A, 3V	F-48	S6015H		
2N3760	AMR, ASI	7.5A, 700V, 0.2A, 3V	F-48	S8015H		
2N3761	AMR, ASI	7.5A, 800V, 0.2A, 3V	F-48	S8015H		
2N3870	AMR, ASI	50Hz-Thy 22A, 100V, 0.08A, 3V	C-85	BSIE4026M, ECG5517, MCR63-3, MCR3835-3, S1035G, SK3615, SK5517		
2N3871	AMR, ASI	50Hz-Thy 22A, 200V, 0.08A, 3V	C-85	BSIE4026M, ECG5517, MCR63-4, MCR3835-4, S2035G, SK3615, SK5517		
2N3872	AMR, ASI	50Hz-Thy 22A, 400V, 0.08A, 3V	C-85	BSIE4026M, ECG5518, MCR63-6, MCR3835-6, S4035G, SK3653, SK5518		
2N3873	AMR, ASI	50Hz-Thy 22A, 600V, 0.08A, 3V	C-85	BSIE4040M, ECG5519, MCR3835-8, MCR63-8, S6035G, SK3654, SK5519		
2N3884	AMR, ASI	175A, 50V, 0.4A, 4V	F-91			 图 F-91
2N3885	AMR, ASI	175A, 100V, 0.4A, 4V	F-91			
2N3886	AMR, ASI	175A, 200V, 0.4A, 4V	F-91			
2N3887	AMR, ASI	175A, 300V, 0.4A, 4V	F-91			
2N3888	AMR, ASI	175A, 400V, 0.4A, 4V	F-91			
2N3889	AMR, ASI	175A, 500V, 0.4A, 4V	F-91			

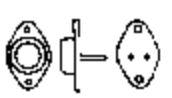
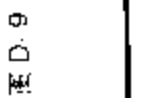





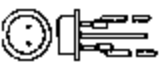



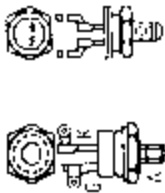
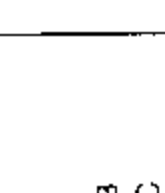
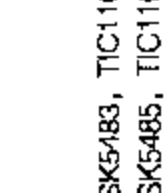
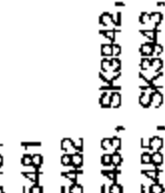
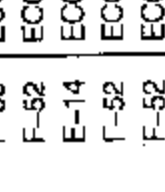
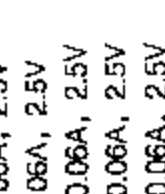
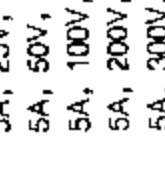
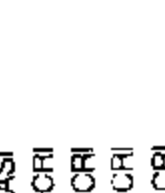
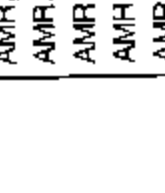
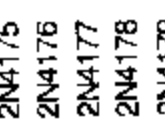

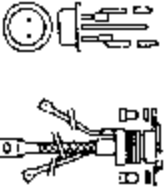
器件型号 Element type	厂名 Manufacturers	材料用途参数 Material Purpose Parameter	图号 Figure	国内外相似替换器件型号 Replace of similar type	备注 Notes	外形参考图 Reference shape
2N3890	AMR, ASI	175A, 600V, 0.4A, 4V	F-91			
2N3891	AMR, ASI	175A, 700V, 0.4A, 4V	F-91			
2N3892	AMR, ASI	175A, 800V, 0.4A, 4V	F-91			
2N3894	AMR, CRI	175A, 1kV, 0.4A, 4V	F-91			
2N3895	AMR, CRI	175A, 1.2kV, 0.4A, 4V	F-91			
2N3896	AMR, ASI	50Hz-Thy 22A, 100V, 0.08A, 3V	F-21	BSIE4126M, C228A, ECG5522, MCR70-3, MCR3935-3, S1035H, SK5542, SK6642		 图 F-91
2N3897	AMR, ASI	50Hz-Thy 22A, 200V, 0.08A, 3V	F-21	BSIE4126M, C35B, C228B, ECG5524, MCR3935-4, S2035H, SK3581, SK5543, T400022208		
2N3898	AMR, ASI	50Hz-Thy 22A, 400V, 0.08A, 3V	F-21	BSIE4126M, C35D, C228D, ECG5527, MCR3935-6, S4035H, SK3582, SK5545, T400032208		 图 F-21
2N3899	AMR, ASI	50Hz-Thy 22A, 600V, 0.08A, 3V	F-21	BSIE4140M, C35M, C228M, ECG5547, MCR3935-8, S6035H, SK3505, SK5547, T400042208		
2N3936	AMR, CRI	50Hz-Thy 7A, 100V, 0.06A, 3.2V	F-47	BTW42-600R, S1008H, TAG9N400, TAG15-100, 2N4169		
2N3937	AMR, CRI	50Hz-Thy 7A, 200V, 0.06A, 3.2V	F-47	BTW42-600R, S2008H, TAG9N400, TAG15-200, 2N4170		
2N3938	AMR, CRI	50Hz-Thy 7A, 300V, 0.06A, 3.2V	F-47	BTW42-600R, S4008H, TAG9N400, TAG15-300, 2N4171		
2N3939	AMR, CEI	50Hz-Thy 7A, 400V, 0.06A, 3.2V	F-47	BTW42-600R, S4008H, TAG9N400, TAG15-400, 2N4172		
2N3940	AMR, CRI	50Hz-Thy 7A, 500V, 0.06A, 3.2V	F-47	BTW42-600R, S6008H, TAG9N600, TAG15-500, 2N4173		 图 F-47
2N3986	AMR, CRI	70A, 500V, 0.2A, 3V	F-91			
2N3987	AMR, CRI	70A, 600V, 0.2A, 3V	F-91			
2N3988	AMR, CRI	70A, 700V, 0.2A, 3V	F-91			

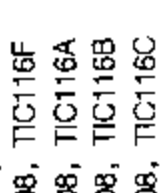
器件型号 Element type	厂名 Manufacturers	材料用途参数 Material Purpose Parameter	图号 Figure	国内外相似替换器件型号 Replace of similar type	备注 Notes	外形参考图 Reference shape
2N3989	AMR, CRI	70A, 800V, 0.2A, 3V	F-91			 图 9-91
2N3990	AMR, CRI	70A, 900V, 0.2A, 3V	F-91			
2N3991	AMR, CRI	70A, 1kV, 0.2A, 3V	F-91			
2N3992	AMR, CRI	70A, 1.1kV, 0.2A, 3V	F-91			
2N4096	AMR, ASI	50Hz-Thy 1A, 50V, 200 μ A, 0.8V	B-36	BRY58, BRY60, MCR103, MCR203, TAG615-100, 2N2323, 2N5062, 2N6333		 图 B-36
2N4097	AMR, ASI	50Hz-Thy 1A, 100V, 200 μ A, 0.8V	B-36	BR58-100, MCR204, TAG615-100, 2N2324, 2N5062, 2N6334		
2N4098	AMR, ASI	50Hz-Thy 1A, 200V, 200 μ A, 0.8V	B-36	BRY58-200, MCR206, TAG615-200, 2N2326, 2N5054, 2N6335		
2N4101	AMR, ASI	50Hz-Thy 3.2A, 600V, 0.03A, 3V	B-9	B51C0540L, ECG5513, S2800M, S6006L, SK3502, SK5513, TAG676-600, TAG671-600, 2N4174		 图 B-9
2N4102	AMR, CRI	50Hz-Thy 1.3A, 600V, 0.03A, 3V	B-9	S2800M, S6003M, SK3851, TAG606-600, TAG612-600, TAG613-600, 2N4190		
2N4103	AMR, CRI	50Hz-Thy 8A, 600V, 0.08A, 3V	D-9	2N2579		
2N4108	AMR, ASI	50Hz-Thy 0.18A, 50V, 200 μ A, 0.8V	B-36	EC103A, MCR103, MCR203, TAG06YY, 2N4096		 图 B-9
2N4109	AMR, ASI	50Hz-Thy 0.18A, 100V, 200 μ A, 0.8V	B-36	EC103A, MCR204, TAG06A, 2N4096, 2N5062		
2N4110	AMR, ASI	50Hz-Thy 0.18A, 200V, 200 μ A, 0.8V	B-36	EC103B, MCR206, TAG06B, 2N4096, 2N5064		
2N4144	AMR, ASI	50Hz-Thy 0.25A, 15V, 0.001A, 0.8V	B-36	EC103Y, ECG5400, MCR101, MCR201, MCR1906-3, SK3950, SK5400, TAG2-50, 2N1595A		 图 D-9
2N4145	AMR, ASI	50Hz-Thy 0.25A, 30V, 0.001A, 0.8V	B-36	EC103Y, ECG5400, MCR101, MCR201, MCR1906-3, SK3950, SK5400, TAG2-50, 2N1595A		
2N4146	AMR, ASI	50Hz-Thy 0.25A, 60V, 0.001A, 0.8V	B-36	EC103A, ECG5402, MCR102, MCR202, MCR1906-3, SK3636, SK5402, TAG2-100, 2N1596A		

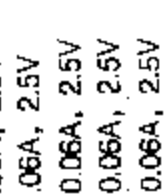
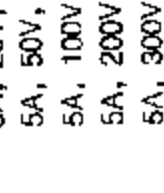
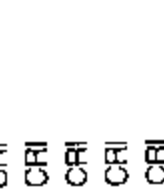
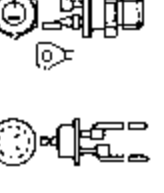



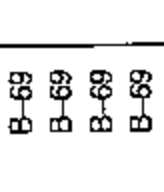
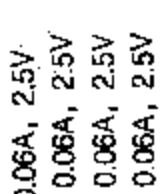
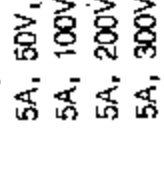
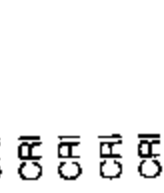
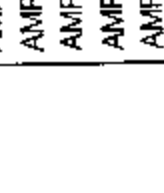
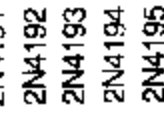

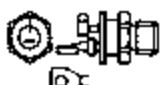
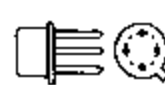

器件型号 Element type	厂名 Manufacturers	材料用途参数 Material Purpose Parameter	图号 Figure	国内外相似替换器件型号 Replace of similar type	备注 Notes	外形参考图 Reference shape
2N4147	AMR, ASI	50Hz-Thy 0.25A, 100V, 0.001A, 0.8V	B-36	EC103A, ECG5402, MCR103, MCR203, MCR1906-3, SK3638, SK5402, TAG2-100, 2N1596A		 图 B-36
2N4148	AMR, ASI	50Hz-Thy 0.25A, 150V, 0.001A, 0.8V	B-36	EC103B, ECG5404, MCR204, MCR1906-4, SK3638, SK5404, TAG2-200, 2N1597A, 2N5062		 图 B-72
2N4149	AMR, ASI	50Hz-Thy 0.25A, 200V, 0.001A, 0.8V	B-36	EC103B, ECG5404, MCR206, MCR1906-4, SK3638, SK5404, TAG2-200, 2N1597A, 2N5064		 图 B-70
2N4151	AMR, CRI	5A, 25V, 0.06A, 2.5V	B-72			
2N4152	AMR, ESE	5A, 50V, 0.06A, 2.5V	B-72			
2N4153	SLD, SPE	5A, 100V, 0.06A, 2.5V	B-72			
2N4154	SLD, SPE	5A, 200V, 0.06A, 2.5V	B-72			
2N4156	SLD, SPE	5A, 400V, 0.06A, 2.5V	B-72			
2N4157	AMR, CRI	5A, 500V, 0.06A, 2.5V	B-72			
2N4158	AMR, CRI	5A, 600V, 0.06A, 2.5V	B-72			
2N4159	SLD, SPE	5A, 25V, 0.06A, 2.5V	B-70			
2N4160	AMR, SLD	5A, 50V, 0.06A, 2.5V	B-70			
2N4161	SLD, SPE	5A, 100V, 0.06A, 2.5V	B-70			
2N4162	AMR, CRI	5A, 200V, 0.06A, 2.5V	B-70			
2N4164	SLD, SPE	5A, 400V, 0.06A, 2.5V	B-70			
2N4165	AMR, CRI	5A, 500V, 0.06A, 2.5V	B-70			
2N4166	AMR, CRI	5A, 600V, 0.06A, 2.5V	B-70			
2N4167	AMR, ASI	5A, 25V, 0.06A, 2.5V	F-50	ECG5481, S0315H, TIC116F		 图 B-70
2N4168	AMR, ASI	5A, 50V, 0.06A, 2.5V	F-50	ECG5481, S0515H, TIC116		
2N4169	AMR, ASI	5A, 100V, 0.06A, 2.5V	F-50	ECG5482, S1015H, TIC116A		
2N4170	AMR, ASI	5A, 200V, 0.06A, 2.5V	F-50	ECG5483, S2015H, SK3942, SK5483, T400042208, TIC116B		 图 F-50
2N4171	AMR, ASI	5A, 300V, 0.06A, 2.5V	F-50	ECG5485, S4015H, SK3943, SK5485, TC116C		



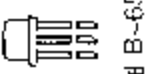
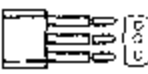

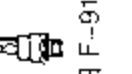
器件型号 Element type	厂名 Manufacturers	材料用途参数 Material Purpose Parameter	图号 Figure	国内外相似替换器件型号 Replace of similar type	备注 Notes	外形参考图 Reference shape
2N4172	AMR, ASI	5A, 400V, 0.06A, 2.5V	F-50	ECG5485, S4015H, SK3943, SK5485, TIC116D		
2N4173	AMR, ASI	5A, 500V, 0.06A, 2.5V	F-50	ECG5487, S6015H, SK3944, SK5487, TIC116E		
2N4174	AMR, ASI	5A, 600V, 0.06A, 2.5V	F-50	ECG5487, S6015H, SK3944, SK5487, TIC116M		
2N4175	AMR, ASI	5A, 25V, 0.06A, 2.5V	F-50	ECG5481		
2N4176	AMR, CRI	5A, 50V, 0.06A, 2.5V	F-52	ECG5481		
2N4177	AMR, CRI	5A, 100V, 0.06A, 2.5V	E-14	ECG5482		
2N4178	AMH, CRI	5A, 200V, 0.06A, 2.5V	F-52	ECG5483, SK3942, SK5483, TIC116B		
2N4179	AMR, CRI	5A, 300V, 0.06A, 2.5V	F-52	ECG5485, SK3943, SK5485, TIC116C		
2N4180	AMR, CRI	5A, 400V, 0.06A, 2.5V	F-52	ECG5485, SK3943, SK5485, TIC166D		
2N4181	AMR, CRI	5A, 500V, 0.06A, 2.5V	F-52	ECG5487, SK3944, SK5487, TIC116E		
2N4182	AMR, CRI	5A, 600V, 0.06A, 2.5V	F-52	ECG5487, SK3944, SK5487, TIC116M		
2N4183	AMR, CRI	5A, 25V, 0.06A, 2.5V	B-70	S0308, TIC116F		
2N4184	AMR, CRI	5A, 50V, 0.06A, 2.5V	B-70	S0508, TIC116F		
2N4185	AMR, CRI	5A, 100V, 0.06A, 2.5V	B-70	S1008, TIC116A		
2N4186	AMR, CRI	5A, 200V, 0.06A, 2.5V	B-70	S2008, TIC116B		
2N4187	AMR, CRI	5A, 300V, 0.06A, 2.5V	B-70	S4008, TIC116C		
2N4188	AMR, CRI	5A, 400V, 0.06A, 2.5V	B-70	S4008, TIC116D		
2N4189	AMR, CRI	5A, 500V, 0.06A, 2.5V	B-70	S5008, TIC116E		
2N4190	AMR, CRI	5A, 600V, 0.06A, 2.5V	B-70	S6008, TIC116M		
2N4191	AMR, CRI	5A, 25V, 0.06A, 2.5V	B-69			
2N4192	AMR, CRI	5A, 50V, 0.06A, 2.5V	B-69			
2N4193	AMR, CRI	5A, 100V, 0.06A, 2.5V	B-69			
2N4194	AMR, CRI	5A, 200V, 0.06A, 2.5V	B-69			
2N4195	AMR, CRI	5A, 300V, 0.06A, 2.5V	B-69			
2N4196	AMR, CRI	5A, 400V, 0.06A, 2.5V	B-69			
2N4197	AMR, CRI	5A, 500V, 0.06A, 2.5V	B-69			
2N4198	AMR, CRI	5A, 600V, 0.06A, 2.5V	B-69			
2N4199	AMR, CRI	SCR-H 5A, 300V, 0.1A, 2V	F-50	C234D, MCR1718-5, T6F300C, TAG15S-400		
JAN2N4199	NON	2A, 300V, 0.05A, 1.5V	F-8			



器件型号 Element type	厂名 Manufacturers	材料用途参数 Material Purpose Parameter	图号 Figure	国内外相似替换器件型号 Replace of similar type	备注 Notes	外形参考图 Reference s:app	
2N4200	AMR, CRI	SCR-H 5A, 400V, 0.1A, 2V	F-50	C234D, MCR1718-6, T6F400C, TAG15S-400		 图 F-50	
JAN2N4200	NON	2A, 400V, 0.05A, 1.5V	F-8				
2N4201	AMR, CRI	SCR-H 5A, 500V, 0.1A, 2V	F-50	C234E, MCR1718-7, T6F500C, TAG15S-500			
JAN2N4201	NON	2A, 500V, 0.05A, 1.5V	F-8				
2N4202	AMR, CRI	SCR-H 5A, 600V, 0.1A, 2V	F-50	C234M, MCR1718-8, T6F600C, TAG15S-600			
JAN2N4202	NON	2A, 600V, 0.05A, 1.5V	F-8				
2N4203	AMR, CRI	SCR-H 5A, 700V, 0.1A, 2V	F-50	MCR1718-9, T6F700C, T12F700, TAG15S-700, 2N691S			
JAN2N4203	NON	2A, 700V, 0.05A, 1.5V	F-8				
2N4204	AMR, CRI	SCR-H 5A, 800V, 0.1A, 2V	F-50	MCR1718-10, T6F800C, T12F800, TAG15S-800, 2N692S			 图 F-8
JAN2N4204	NON	2A, 800V, 0.05A, 1.5V	F-8				
2N4205	AMR, CRI	SCR-H 5A, 900V, 0.1A, 2V	F-8	T12F900, TAG15S-900, TAG35S-900			
JAN2N4205	NON	2A, 900V, 0.05A, 1.5V	F-8				
2N4206	SCR-H	5A, 1kV, 0.1A, 2V	F-55	T12F1000, TAG15S-1000, TAG35S-1000			
JAN2N4206	NON	2A, 1kV, 0.05A, 1.5V	F-8				
2N4212	AMR, ASI	50Hz-Thy 1A, 25V, 300 μA, 1V	B-55	MCR606-2, S0301MS1, TAG615-100, 2N2322, 2N6332		 图 B-55	
2N4213	AMR, ASI	50Hz-Thy 1A, 50V, 300 μA, 1V	B-55	MCR606-2, S0501MS1, TAG615-100, 2N2323, 2N6333			
2N4214	AMR, ASI	50Hz-Thy 1A, 100V, 300 μA, 1V	B-55	MCR606-3, S1001MS1, TAG615-100, 2N2324, 2N6334			
2N4215	AMR, ASI	50Hz-Thy 1A, 150V, 300 μA, 1V	B-55	MCR606-4, S2001MS1, TAG615-200, 2N2325, 2N6335			
2N4216	AMR, ASI	50Hz-Thy 1A, 200V, 300 μA, 1V	B-55	MCR606-4, S2001MS1, TAG615-200, 2N2326, 2N6335			
2N4217	AMR, ASI	50Hz-Thy 1A, 250V, 300 μA, 1V	B-51	MCR606-5, S3001MS1, TAG615-300, 2N2327, 2N6336			

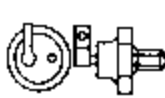

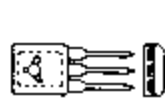

器件型号 Element type	厂名 Manufacturers	材料用途参数 Material Purpose Parameter	图号 Figure	国内外相似替换器件型号 Replace of similar type	备注 Notes	外形参考图 Reference shape
2N4218	AMR, ASI	50Hz-Thy 1A, 300V, 300 μ A, 1V	B-51	MCR606-5, S3001MS1, TAG615-300, 2N2328, 2N6336		
2N4219	AMR, ASI	50Hz-Thy 1A, 400V, 300 μ A, 1V	B-51	MCR606-6, S4001MS1, TAG615-400, 2N2329, 2N6337		
2N4316		50Hz-Thy 8A, 100V, 0.015A	D-9	BSiC0506, TAG671-100, TAG676-100		
2N4317		50Hz-Thy 8A, 200V, 0.015A	D-9	BSiC0513, TAG671-200, TAG676-200		
2N4318		50Hz-Thy 8A, 300V, 0.015A	D-9	BSiC0526, TAG671-300, TAG676-300		
2N4319		50Hz-Thy 8A, 400V, 0.015A	D-9	BSiC0526, TAG671-400, TAG676-400		
2N4320	AMR, CRI	GTO 0.25A, 30V, 500 μ A, 1V	B-65			
2N4321	AMR, CRI	GTO 0.25A, 60V, 500 μ A, 1V	B-65			
2N4322	AMR, CRI	GTO 0.25A, 100V, 500 μ A, 1V	B-65			
2N4323	AMR, CRI	GTO 0.25A, 150V, 500 μ A, 1V	B-65			
2N4324	AMR, CRI	GTO 0.25A, 200V, 500 μ A, 1V	B-65			
2N4325	AMR, CRI	GTO 0.25A, 250V, 500 μ A, 1V	B-65			
2N4326	AMR, CRI	GTO 0.39A, 30V, 500 μ A, 1V	B-65			
2N4327	AMR, CRI	GTO 0.39A, 60V, 500 μ A, 1V	B-65			
2N4328	AMR, CRI	GTO 0.39A, 100V, 500 μ A, 1V	B-65			
2N4329	AMR, CRI	GTO 0.39A, 150V, 500 μ A, 1V	B-65			
2N4330	AMR, CRI	GTO 0.39A, 200V, 500 μ A, 1V	B-65			
2N4331	AMR, CRI	GTO 0.39A, 250V, 500 μ A, 1V	B-65			
2N4332	AMR, ASI	0.39A, 30V, 10 μ A, 0.8V	B-36	EC103Y, MCR102, MCR202		
2N4333	AMR, ASI	0.39A, 60V, 10 μ A, 0.8V	B-36	EC103A, MCR103, MCR203		
2N4334	AMR, ASI	0.39A, 100V, 10 μ A, 0.8V	B-36	EC103A, MCR204, 2N5062		
2N4335	AMR, ASI	0.39A, 150V, 10 μ A, 0.8V	B-36	EC103B, MCR205, 2N5064		
2N4336	AMR, ASI	0.39A, 200V, 10 μ A, 0.8V	B-36	EC103B, MCR120, MCR206		
2N4337	AMR, CRI	0.39A, 250V, 10 μ A, 0.8V	B-65			
2N4381	AMR, ASI	70A, 100V, 0.25A, 5V	F-91	ECG5570		

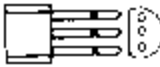

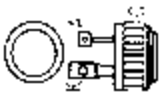

器件型号 Element type	厂名 Manufacturers	材料用途参数 Material Purpose Parameter	图号 Figure	国内外相似替换器件型号 Replace of similar type	备注 Notes	外形参考图 Reference shape
2N4362	AMR, ASI	70A, 200V, 0.25A, 5V	F-91	ECG5570		 图 F-91  图 B-74  图 E-22  图 B-81  图 B-65
2N4363	AMR, ASI	70A, 400V, 0.25A, 5V	F-91	ECG5572		
2N4364	AMR, ASI	70A, 600V, 0.25A, 5V	F-91	ECG5572		
2N4365	AMR, ASI	70A, 800V, 0.25A, 5V	F-91	ECG5574		
2N4366	AMR, ASI	70A, 1kV, 0.25A, 5V	F-91	ECG5574		
2N4367	AMR, ASI	70A, 1.2kV, 0.25A, 5V	F-91	ECG5574		
2N4368	AMR, ASI	70A, 1.4kV, 0.25A, 5V	F-91			
2N4369	AMR, CIR	70A, 1.6kV, 0.25A, 5V	F-91			
2N4370	AMR, CIR	70A, 1.8kV, 0.25A, 5V	F-91			
2N4371	AMR, ASI	70A, 100V, 0.25A, 5V	B-74	ECG5575		
2N4372	SIT, SPE	70A, 200V, 0.25A, 5V	B-74	ECG5575		
2N4373	SIT, SPE	70A, 400V, 0.25A, 5V	B-74	ECG5577		
2N4374	SIT, SPE	70A, 600V, 0.25A, 5V	B-74	ECG5577		
2N4375	SIT, SPE	70A, 800V, 0.25A, 5V	B-74	ECG5579		
2N4376	SIT, SPE	70A, 1kV, 0.25A, 5V	B-74	ECG5579		
2N4377	SIT, SPE	70A, 1.2kV, 0.25A, 5V	B-74	ECG5579		
2N4378	SIT, SPE	70A, 1.4kV, 0.25A, 5V	C-22			
2N4379	SIT, SPE	70A, 1.6kV, 0.25A, 5V	B-74			
2N4380	AMR, CRI	70A, 1.8kV, 0.25A, 5V	B-74			
2N4441	AMR, ASI	50Hz-Thy 5A, 50V, 0.06A, 2.5V	B-81	ECG5442, S0508L, SK3634, SK5444, TIC116F		
2N4442	AMR, ASI	50Hz-Thy 5A, 200V, 0.06A, 2.5V	B-81	ECG5444, S2008L, SK3634, SK5444, TIC116B		
2N4443	AMR, ASI	50Hz-Thy 5A, 400V, 0.06A, 2.5V	B-81	S4008L, TAG4443, TIC116D		
2N4444	AMR, ASI	50Hz-Thy 5A, 600V, 0.06A, 2.5V	B-81	ECG5446, S6008L, TAG4444, TIC116M		
2N4983	AMR, CRI	SUS, 1A, 10V, 10 μ A, 1kV	B-65	ECG6404		
2N4984	AMR, CRI	SUS, 1A, 9V, 10 μ A, 1kV	B-65			
2N4985	AMR, CRI	SUS, 1A, 8.2V, 10 μ A, 1kV	B-65			
2N4986	AMR, CRI	SUS, 1A, 9V, 10 μ A, 1kV	B-65			

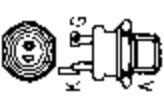

器件型号 Element type	厂名 Manufacturers	材料用途参数 Material Purpose Parameter	图号 Figure	国内外相似替换器件型号 Replace of similar type	备注 Notes	外形参考图 Reference shape
2N4987	AMR, CRI	SUS, 1A, 10V, 10 μ A, 1kV	B-34	ECG6404		 图 B-34
2N4988	AMR, CRI	SUS, 1A, 9V, 10 μ A, 1kV	B-34			
2N4989	CRI, GES	SUS, 1A, 8.2V, 10 μ A, 1kV	B-34			
2N4990	AMR, CRI	SUS, 1A, 9V, 10 μ A, 1kV	B-34	ECG6404		
2N4991	AMR, CRI	SBS, 1A, 10V, 10 μ A, 1kV	B-36	ECG6403, MBS4991, SK3083/197		
2N4992	AMR, CRI	SBS, 1A, 9V, 10 μ A, 1kV	B-36	ECG6403, MBS4992		
2N4993	AMR, CHI	SBS, 1A, 10V, 10 μ A, 1kV	B-36	ECG6403, MBS4991		
2N5060	AMR, CRI	50Hz-Thy 0.255A, 30V, 350 μ A, 1.2V	B-36	BRY30, BRY55, ECG5400, MCR100-3, SK3950, SK5400, TIC60, 2N6564		 图 B-36
2N5061	AMR, ASI	50Hz-Thy 0.255A, 60V, 350 μ A, 1.2V	B-36	BRY55, BRY60, ECG5401, MCR22-2, MCR100-3, SK3638, SK5402, TIC61, 2N5062, 2N6564		
2N5062	AMR, ASI	50Hz-Thy 0.255A, 100V, 350 μ A, 1.2V	B-36	BRY55-100, ECG5402, MCR22-2, MCR100 3, SK3638, SK5402, TIC62, 2N6564		
2N5063	AMR, ASI	50Hz-Thy 0.255A, 150V, 350 μ A, 1.2V	B-36	BRY55-200, ECG5404, MCR100-4, SK3627, SK5404, TIC63, 2N5064, 2N6564		
2N5064	AMR, ASI	50Hz-Thy 0.255A, 200V, 350 μ A, 1.2V	B-36	BRY55-200, ECG5404, MCR22-2, MCR100-4, SK3627, SK5404, TIC64, 2N6564		
2N5164	AMR, ASI	50Hz-Thy 7A, 50V, 0.075A, 2.5V	C 85	ECG5414, MCR63-2, MCR3818-2, MCR3835-2, S0525G, SK3613, SK5514, 2N3870		
2N5164R		50Hz-Thy 13A, 50V, 0.04A, 0.05A	D-14	MCR63-2, MCR3818-2, MCR3835-2, 2N3870		
2N5165	AMR, ASI	50Hz-Thy 7A, 200V, 0.075A, 2.5V	C-85	ECG5414, MCR63-4, MCR3818-4, MCR3835-4, S2025G, SK3613, SK5514, 2N3871		
2N5165R		50Hz-Thy 13A, 200V, 0.04A, 0.05A	D-14	MCR3818-4, MCR63-4, MCR3835-4, 2N3871		
2N5166	AMR, ASI	50Hz-Thy 7A, 400V, 0.075A, 2.5V	C-85	ECG5515, MCR63-6, MCR3818-6, MCR3835-6, S4025G, SK6615, SK5515, 2N3872		
2N5166R		50Hz-Thy 13A, 400V, 0.04A, 0.05A	D-14	MCR63-6, MCR3818-6, MCR3835-6, 2N3872		

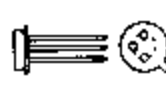
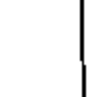

其他

器件型号 Element type	厂名 Manufacturers	材料用途参数 Material Purpose Parameter	图号 Figure	国内外相似替换器件型号 Replace of similar type	备注 Notes	外形参考图 Reference shape
2N5167	AMR, ASI	50Hz-Thy 7A, 600V, 0.075A, 2.5V	C-85	ECG5516, MCR3818-8, MCR63-8, MCR3835-8, S6025G, SK6616, SK5516, 2N3873		 图 C-85
2N5167R		50Hz-Thy 13A, 600V, 0.04A, 0.05A	D-14	MCR63-8, MCR3818-8, MCR3835-8, 2N3873		
2N5168	AMR, ASI	50Hz-Thy 7A, 50V, 0.075A, 2.5V	F-21	FCG5521, MCR64-2, MCR3918-2, MCR3935-2, S0525H, SK6621, SK5521, T40001608, T12N100		 图 F-21
2N5168R		50Hz-Thy 13A, 50V, 0.04A, 0.05A	D-14	MCR63-2, MCR3818-2, MCR3835-2, 2N3870		
2N5169	AMR, ASI	50Hz-Thy 7A, 200V, 0.075A, 2.5V	F-21	ECG5524, MCR3918-4, S2025H, SK3504, SK5508, T12N200, T4000021608, TAG9N200DU, MCR64-4, MCR3935-4		 图 D-14
2N5169R		50Hz-Thy 13A, 200V, 0.04A, 0.05A	D-14	MCR63-4, MCR3835-4, MCR3818-4, 2N3871		
2N5170	AMR, ASI	50Hz-Thy 7A, 400V, 0.075A, 2.5V	F-21	MCR64-6, MCR3918-6, MCR3935-6, S4025H, SK3504, SK5508, T12N400, T4000041608, TAG8N400DU		 图 F-21
2N5170R		50Hz-Thy 13A, 200V, 0.04A, 0.05A	D-14	MCR63-4, MCR3835-4, MCR3818-4, 2N3871		
2N5171	AMR, ASI	50Hz-Thy 7A, 600V, 0.075A, 2.5V	F-21	FCG5529, MCR64-8, MCR3918-8, MCR3935-8, SK6629, SK5529, S6025H, T12N600, T4000061608, TAG9N600DU		 图 F-21
2N5171R		50Hz-Thy 13A, 400V, 0.04A, 0.05A	D-14	MCR63-6, MCR3835-6, MCR3818-6, 2N3872		
2N5204	AEI, AMR	50Hz-Thy 22A, 600V, 0.08A, 3V	F-48	C35M, C228M, ECG5547, MCR3935-8, S6035H, 2N3899		 图 F-48
2N5205	AEI, AMR	50Hz-Thy 22A, 800V, 0.08A, 3V	F-48	C35N, MCR3935-10, MCR64-10, MCR38935-10, S8035H, TAG35-800		
2N5206	AEI, AMR	50Hz-Thy 22A, 1kV, 0.08A, 3V	F-48	C35P, MCR64-10, TAG35-1000		
JAN2N5206	NON	16A, 1kV, 0.08A, 3V	F-19			
2N5207	AEI, AMR	50Hz-Thy 22A, 1.2kV, 0.08A, 3V	F-48			
2N5258	AEI, CRI	300A, 600V, 0.8A, 3V	F-91			
2N5259	AMR, CRI	200A, 800V, 0.8A, 3V	F-91			

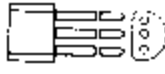

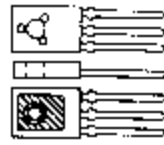
器件型号 Element type	厂名 Manufacturers	材料用途参数 Material Purpose Parameter	图号 Figure	国内外相似替换器件型号 Replace of similar type	备注 Notes	外形参考图 Reference shape
2N5260	AMR, CRI	200A, 1kV, 0.8A, 3V	F-91			 图 F-91
2N5261	AMR, CRI	200A, 1.2kV, 0.8A, 3V	F-91			
2N5273	AMR, CRI	25A, 200V, 0.15A, 3.5V	F-47	BTX94-200, ECG5683, 2N5806, 2N6160		 图 F-47
2N5274	AMR, CRI	25A, 400V, 0.15A, 3.5V	F-47	BTX94-400, ECG5685, SK3521, SK5686, 2N5807, 2N6161		
2N5275	AMR, CRI	25A, 600V, 0.15A, 3.5V	F-47	BTX94-600, ECG5697, SK3522, SK5697, 2N5809, 2N6162		
2N5441	AMR, ASI	40A, 200V, 0.24A, 3.4V	B-60	Q2040, T6400B		 图 B-60
2N5442	AMR, ASI	40A, 400V, 0.24A, 3.4V	B-60	Q4040, T6400D		
2N5443	AMR, ASI	40A, 600V, 0.24A, 3.4V	B-60	Q6040, T6400M		
2N5444	AMR, ASI	40A, 200V, 0.24A, 3.4V	B-60	ECG5693, Q2040D, SK3652, SK5693, T6401B		
2N5445	AMR, ASI	40A, 400V, 0.24A, 3.4V	B-60	BTW43-600G, BTX94-400H, ECG5695, T6401D		
2N5446	AMR, ASI	40A, 600V, 0.24A, 3.4V	B-60	ECG5697, Q6040D, SK3522, SK5697, T6401M		
2N5567	AMR, ASI	10A, 200V, 0.15A, 4V	SCR-D	ECG5688, Q2015G, T4101B, TIC236B		 图 B-60
2N5568	AMR, ASI	10A, 400V, 0.15A, 4V	SCR-D	ECG5689, Q4015G, T4101D, TIC236D		
2N5569	AMR, ASI	10A, 200V, 0.15A, 4V	SCR-D	BTW43-600G, BTX94-400H, ECG5673, Q2015B, SK3508, SK5675, T4111B, TIC236B		
2N5570	AMR, ASI	10A, 400V, 0.15A, 4V	SCR-D	BTW43-600G, BTX94-400H, ECG5675, Q4015B, SK3508, SK5675, T4111D, TIC236D		
2N5571	AMR, ASI	15A, 200V, 0.2A, 4V	SCR-D	ECG5688, Q2015G, T6400B, TIC246B, 2N5441, 2N6157		
2N5572	AMR, ASI	15A, 400V, 0.2A, 4V	SCR-D	ECG5689, Q4015G, T6400D, TIC246D, 2N5442, 2N6158		
2N5573	AMR, ASI	15A, 200V, 0.2A, 4V	SCR-D	BTW43-600G, BTX94-400H, ECG5673, Q2015H, SK3508, SK5675, T6410B, T6411B, TIC246B, 2N5444, 2N6160		







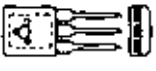

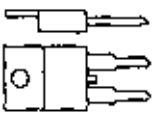
器件型号 Element type	厂名 Manufacturers	材料 Material	用途 Purpose	参数 Parameter	图号 Figure	国内外相似替换器件型号 Replace of similar type	备注 Notes	外形参考图 Reference photo
2N5574	AMR, ASI	SCR-D	15A, 400V, 0.2A, 4V			BTW43-600G, BTX94-400H, ECG5675, Q4015H, SK3508, SK5675, T6411D, T6410D, TIC246D, 2N5445, 2N6161		 图 B-36
2N5719	AMR, ESE	50Hz-Thy	0.2A, 60V, 20 μ A, 0.6V	B-36		MCR103, MCR203, S1001MS1, 2N2324A, 2N3002		
2N5720	AMR, CRI	50Hz-Thy	0.2A, 100V, 20 μ A, 0.6V	B-36		MCR201, S1001MS1, 2N2324A, 2N3003, 2N5062		
2N5721	AMR, CRI	50Hz-Thy	0.2A, 200V, 20 μ A, 0.6V	B-36		MCR206, S2001MS1, 2N2326A, 2N3004, 2N5064		
2N5722	AMR, SHE	50Hz-Thy	0.2A, 300V, 20 μ A, 0.6V	B-36		MCR100-5, S4001MS1, 2N2328A		
2N5723	AMR, CRI	50Hz-Thy	0.2A, 400V, 20 μ A, 0.6V	B-36		MCR100-6, S4001MS1, 2N2329A		
2N5724	AMR, CRI	50Hz-Thy	0.39A, 60V, 20 μ A, 0.6V	B-36		MCR103, MCR203, S1001MS1, 2N2324A		
2N5725		50Hz-Thy	0.8A, 100V, 20 μ A	B-36		2N2324A, 2N5062		
2N5726	AMR, CRI	50Hz-Thy	0.39A, 200V, 20 μ A, 0.6V	B-36		MCR206, S2001MS1, 2N2326A, 2N5064		
2N5727	AMR, CRI	50Hz-Thy	0.39A, 300V, 20 μ A, 0.6V	B-36		MCR100-5, S4001MS1, 2N2328A		
2N5728	AMR, CRI	50Hz-Thy	0.39A, 400V, 20 μ A, 0.6V	B-36		MCR100-6, S4001MS1, 2N2329A		 图 B-51
2N5754	AMR, ASI	SCR-D	2.5A, 100V, 0.11A, 3V	B-51		ECG5640, Q2003P, SC136-B, SK3506, SK5642, T2303A, 2N6070		
2N5755	AMR, ASI	SCR-D	2.5A, 200V, 0.11A, 3V	B-25		ECG5641, Q2003P, SK3506, SK5642, SC136-B, T2303B, 2N6071		
2N5756		SCR-D	2.5A, 300V	B-25		SC136-C, T2303D		
2N5757	AMR, ASI	SCR-D	2.5A, 600V, 0.11A, 3V	B-25		Q400M, ECG5643, SC136-D, SK3519, SK5643, T2303M, 2N6075		 图 B-25
2N5787		50Hz-Thy	0.24A, 30V, 350 μ A, 0.01A			TAG615-100, TIC44, 2N2323, 2N6332		
2N5788		50Hz-Thy	0.24A, 60V, 350 μ A, 0.01A			TAG615-100, TIC46, 2N2324, 2N6334		
2N5789		50Hz-Thy	0.24A, 100V, 350 μ A, 0.01A			TAG615-100, TIC46, 2N2324, 2N6334		
2N5790		50Hz-Thy	0.24A, 200V, 350 μ A, 0.01A			TAG615-200, TIC47, 2N2326, 2N6335		
2N5791		50Hz-Thy	0.24A, 300V, 350 μ A, 0.01A			TAG615-300, TAG06C, 2N2328, 2N6336		
2N5792		50Hz-Thy	0.24A, 400V, 350 μ A, 0.01A			TAG615-400, TAG06D, 2N2329, 2N6337		



器件型号 Element type	厂名 Manufacturers	材料用途参数 Material Purpose Parameter	图号 Figure	国内外相似替换器件型号 Replace of similar type	备注 Notes	外形参考图 Reference shape
2N5806	CRI, SPE	SCR-D 25A, 200V, 0.12A, 4V	B-60	BTX94/200, ECG5543, Q2025VF, 2N6160		 图 B-60
JAN2N5806	NON	25A, 200V, 0.12A, 4V	F-21			
2N5807	AMR, CRI	SCR-D 25A, 400V, 0.12A, 4V	B-60	BTX94/400, ECG5545, Q4025VF, 2N6161		
JAN2N5807	NON	25A, 400V, 0.12A, 4V	F-21			
2N5808	CRI, SPE	SCR-D 25A, 500V, 0.12A, 4V	B-60	BTX94/500, ECG5547, Q5025VF, 2N6162		
JAN2N5808	NON	25A, 500V, 0.12A, 4V	F-21			
2N5809	AMR, CRI	SCR-D 25A, 600V, 0.12A, 4V	B-60	BTX94/600, ECG5547, Q6025VF, 2N6162		 图 B-60
JAN2N5809	NON	25A, 600V, 0.12A, 4V	F-21			
2N6027	AMR, ASI	PUT 2A, 40V, 20μA, 500V	B-63	ECG6402, MPU131, SK3628, SK6402, 2N6116		
2N6027PH		PUT 0.2A, 40V	B-36			
2N6028	AMR, ASI	PUT 2A, 40V, 20μA, 500V	B-63	ECG6402, 2N6120		
2N6028PH		PUT 0.2A, 40V	B-36			
2N6068	AMR, ASI	SCR D 4A, 25V, 0.06A, 2.5V	B-25	ECG5601, Q2004L4, SK3664, SK5602, TAG96A, TAG136A, TAG231-200, TIC216A, Z0410A		 图 F-21
2N6068A, B	AMR, ASI	SCR-D 2A, 25V, 0.015A, 2.5V	B-25	Q2001L3, T2300F, TAG97A, TAG98A, TAG137A, TAG138A, TAG232-100, TAG233-100, TIC216A, Z0405B, Z0409B, Z0409D, Z0409M, Z0409N		
2N6069	AMR, ASI	SCR-D 4A, 50V, 0.06A, 2.5V	B-25	ECG5601, Q2004L4, SK3664, SK5602, T2303F, T2500Y, TAG96A, TAG136A, TAG231-200, Z0410A		
2N6069A, B	AMR, ASI	SCR-D 2A, 50V, 0.015A, 2.5V	B-25	L2004F51, T2301F, TAG97A, TAG98A, TAG137A, TAG138A, TAG232-100, TAG233-100, TIC216A, Z0405B, Z0409B, Z0409D, Z0409M, Z0409N		
2N6070	AMR, ASI	SCR-D 4A, 100V, 0.06A, 2.5V	B-25	ECG5602, Q2004L4, SK3664, SK5602, T2500A, TAG96A, TAG136A, TAG231-200, TIC216A, Z0410A, 2N5754		
2N6070A, B	AMR, ASI	SCR-D 2A, 100V, 0.02A, 2.5V	B-25	L2004F51, T2301A, TAG97A, TAG98A, TAG137A, TAG138A, TAG232-100, TAG233-100, TIC216A, Z0405B, Z0409B, Z0409D, Z0409M, Z0409N		



器件型号 Element type	厂名 Manufacturers	材料用途参数 Material Purpose Parameter	图号 Figure	国内外相似替换器件型号 Replace of similar type	备注 Notes	外形参考图 Reference shape
2N6071	AMR, ASI	SCR-D 4A, 200V, 0.06A, 2.5V	B-81	ECG5603, Q2004L4, SK3665, SK5603, T2500B, TAG98B, TAG136B, TAG231-200, TIC216B, Z0410B, 2N5755		 图 B-81
2N6071A, B	AMR, ASI	SCR-D 2A, 200V, 0.02A, 2.5V	B-23	L2004F51, T2301B, TAG97B, TAG98B, TAG137B, TAG138B, TAG232-200, TAG233-200, TIC216B, Z0405B, Z0409B, Z0409D, Z0409M, Z0409N		
2N6072	AMR, ASI	SCR-D 4A, 300V, 0.06A, 2.5V	B-25	ECG5605, Q4004L4, SK3666, SK5605, T2500C, TAG96C, TAG136C, TIC216D, TAG321-400, Z0410C, 2N5756		 图 B-23
2N6072A, B	AMR, ASI	SCR-D 2A, 300V, 0.02A, 2.5V	B-25	L4004F51, TAG97C, TAG98C, TAG137C, TAG138C, TAG232-300, TAG233-300, TIC216D, Z0405B, Z0409B, Z0409D, Z0409M, Z0409N, 2N5756		
2N6073	AMR, ASI	SCR-D 4A, 400V, 0.06A, 2.5V	B-9	ECG5605, Q4004L4, SK3666, SK5605, T2500D, TAG96D, TAG136D, TAG231-400, TIC216D, Z0410D, 2N5756		 图 B-25
2N6073A, B	AMR, ASI	SCR-D 2A, 400V, 0.02A, 2.5V	B-9	L4004F51, T2301D, TAG97D, TAG98D, TAG137D, TAG138D, TAG232-400, TAG233-400, TIC216D, Z0405B, Z0409B, Z0409D, Z0409M, Z0409N		
2N6074	AMR, ASI	SCR-D 4A, 500V, 0.06A, 2.5V	B-25	ECG5607, Q5004L4, TAG96E, TAG136E, TAG231-600, TIC226M, Z0410E, 2N5757		
2N6074A, B	AMR, ASI	SCR-D 2A, 500V, 0.02A, 2.5V	B-25	Q5004L4, TAG97E, TAG98E, TAG137E, TAG138E, TAG232-500, TIC226M, Z0405B, Z0405D, Z0405M, Z0405N, Z0409B, Z0409D, Z0409M, Z0409N		 图 B-9
2N6075	AMR, ASI	SCR-D 4A, 600V, 0.06A, 2.5V	B-9	ECG5607, Q6004L4, TAG96M, TAG136M, TAG231-600, TIC226M, Z0410M, 2N5757		
2N6075A, B	AMR, ASI	SCR-D 2A, 600V, 0.02A, 2.5V	B-9	Q6004L4, TAG97M, TAG98M, TAG137M, TAG138M, TAG232-600, TAG233-600, TIC226M, Z0405B, Z0405D, Z0409B, Z0409D, Z0409M, Z0409N		

器件型号 Element type	厂名 Manufacturers	材料用途参数 Material Purpose Parameter	图号 Figure	国内外相似替换器件型号 Replace of similar type	备注 Notes	外形参考图 Reference shape
2N6116	AMR, CEN	PUT	B-65			
JAN2N6116	NON	PUT	B-65			
2N6117	AMR, CEN	PUT	B-65			
JAN2N6117	NON	PUT	B-65			
2N6118	AMR, CEN	PUT	B-65			
JAN2N6118	NON	PUT	B-65			
2N6137	AMR, CEN	PUT	B-65	2N6116		
JAN2N6137	UNI	PUT	B-65			
2N6138	AMR, CEN	PUT	B-65	2N6116		
JAN2N6138	NON	PUT	B-65			
2N6139		SCR-D	F-55	T4110E, T6410B, T6411B, 2N5573, 2N6160		
2N6140		SCR-D	F-55	T4110E, T6410D, T6411D, 2N5574, 2N6161		
2N6141		SCR-D	F-55	T4110M, T6410M, T6411M, 2N5446, 2N6162		
2N6142	CRI, SPE	SCR-D	F-50	Q2015H, 2N5569, 2N6139		
2N6143	AMR, ESE	SCR-D	F-57	Q4015H, 2N5570, 2N6140		
2N6144		SCR-D	F-55	2N6141		
2N6145	AMR, ASI	SCR-D	F-57	Q2015H, T4120B, T6420B, T6421B, 2N6163		
2N6146	AMR, ASI	SCR-D	F-57	ECG5675, Q4015H, T4120D, T6421D, T6420D		
2N6147	AMR, ASI	SCR-D	F-57	Q6015H, T4120M, T6421M, T6420M, 2N6165		
2N6151	CRI, MOT	SCR-D	B-81	BT138-500, ECG5614, Q2010L4, T2000B, TIC236B		
2N6152	CRI, MOT	SCR-D	B-81	BT138-500, ECG5616, Q4010L4, T2800D, TIC236D		
2N6153	AMR, CRI	SCR-D	B-81	BT138-600, ECG5618, Q6010L4, T2800M, TIC236M		
2N6154	AMR, CRI	SCR-D	B-81	BT138-500, ECG5624, Q2010L4, SK3632, SK5624, T2802B, TIC236B		
2N6155	CRI, MOT	SCR-D	B-81	BT138-500, ECG5626, Q4010L4, SK3633, SK5626, T2802D, TIC236D		
2N6156	CRI, MOT	SCR-D	B-81	BT138-600, ECG5628, Q6010L4, T2802M, TIC236M		

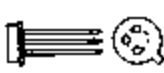
其他

器件型号 Element type	厂名 Manufacturers	材料用途参数 Material Purpose Parameter	图号 Figure	国内外相似替换器件型号 Replace of similar type	备注 Notes	外形参考图 Reference shape
2N6157	AMR, ASI	SCR-D 30A, 200V, 0.25A, 3.4V		Q2025G, T6400B, T6401B, TIC236B, 2N5441		 图 B-60
2N6158	AMR, ASI	SCR-D 30A, 400V, 0.25A, 3.4V		Q4025G, T6400D, T6401D, TIC236D, 2N5442		
2N6159	AMR, ASI	SCR-D 30A, 600V, 0.25A, 3.4V		Q6025G, T6400M, T6401M, TIC236M, 2N5443		
2N6160	AMR, ASI	SCR-D 30A, 200V, 0.25A, 3.4V	B-60	BTW43-600G, BTX94-400H, ECG5693, Q2025H, SK3652, SK5693, T6410B, T6411B, TIC263B, 2N5444		
2N6161	AMR, ASI	SCR-D 30A, 400V, 0.25A, 3.4V	B-60	BTW43-600G, BTX94-400H, ECG5695, Q4025H, SK3509, SK5695, T6410D, T6411D, TIC263D, 2N5445		
2N6162	AMR, ASI	SCR-D 30A, 600V, 0.25A, 3.4V	B-60	BTW43-600G, BTX94-600H, ECG5697, Q6025H, SK3522, SK5697, T6410M, T6411M, TIC263M, 2N5446		
2N6163	AMR, ASI	SCR-D 30A, 200V, 0.25A, 3.4V	F-57	ECG56022, T6420B, T6421B		
2N6164	AMR, ASI	SCR-D 30A, 400V, 0.25A, 3.4V	F-57	ECG5602, Q4025V5, SK3509, SK5695, T6420D, T6421D, TIC263D		
2N6165	AMR, ASI	SCR-D 30A, 600V, 0.25A, 3.4V	F-57	ECG56026, Q6025V5, SK3663, SK56026, T6421M, TIC263M, T6420M		
2N6167		50Hz-Thy 13A, 100V, 0.04A, 0.05A		MCR65-3, 2N6171		 图 F-57
2N6168	ASI, CRI	50Hz-Thy 13A, 200V, 0.075A, 2.5V	F-57	ECG5562, MCR65-4, S2025B, SK3655, SK5562, TIC253B, 2N6172		
2N6169	ASI, CRI	50Hz-Thy 13A, 400V, 0.075A, 2.5V	F-57	ECG5564, MCR65-6, S4025B, TIC253D, 2N6173		
2N6170	ASI, CHI	50Hz-Thy 13A, 600V, 0.075A, 2.5V	F-57	ECG5566, MCR65-8, S6025B, SK3667, SK5566, TIC253M, 2N6174		
2N6171	ASI, CRI	50Hz-Thy 22A, 100V, 0.08A, 3V	B-60	MCR65-3, MCR264-3, S1035B		
2N6172	CRI, MOT	50Hz-Thy 22A, 200V, 0.08A, 3V	B-60	ECG5562, MCR65-4, MCR264-4, S2035B		
2N6173	AMR, CRI	50Hz-Thy 22A, 400V, 0.08A, 3V	B-60	ECG5564, MCR65-6, MCR264-6, S4035B		
2N6174	CRI, MOT	50Hz-Thy 22A, 600V, 0.08A, 3V	B-60	ECG5566, MCT65-8, MCR264-8, S4035B		

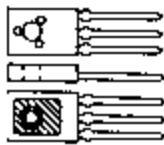
器件型号 Element type	厂名 Manufacturers	材料用途参数 Material Purpose Parameter	图号 Figure	国内外相似替换器件型号 Replace of similar type	备注 Notes	外形参考图 Reference snape
2N6236	AMR, ASI	50Hz-Thy 2.6A, 30V, 500 μ A, 1V	B-25	C106Y, ECG5421, MCR106-1, SK3570, S2060Y, T106Y1, TAG106Y, TIC106Y		 图 B-25
2N6237	AMR, ASI	50Hz-Thy 2.6A, 50V, 500 μ A, 1V	B-25	C106F, ECG5422, MCR106-2, SK3570, S2060F, T106F1, TAG106F, TIC106F		
2N6238	AMR, ASI	50Hz-Thy 2.6A, 100V, 500 μ A, 1V	B-25	C108A, ECG5423, MCR106-3, S2060A, SK3570, T106A1, TAG106A, TIC106A		
2N6239	AMR, ASI	50Hz-Thy 2.6A, 200V, 500 μ A, 1V	B-25	C106B, ECG5414, MCR106-4, SK3954, SK5414, T106B1, TAG106B, TIC106B, S2060B		
2N6240	AMR, ASI	50Hz-Thy 2.6A, 400V, 500 μ A, 1V	B-25	C106D, ECG5415, MCR106-6, S2060D, SK3955, SK5415, T106D1, TAG106D, TIC106D		
2N6241	AMR, ASI	50Hz-Thy 2.6A, 600V, 500 μ A, 1V	B-25	C108M, ECG5416, MCR106-8, S2060M, SK3956, SK5416, TAG106M		
2N6332	AMR, CRI	50Hz-Thy 2A, 30V, 200 μ A, 0.8V	B-25	C106Y, S0303MS2, TAG106Y, TAG615-100		
2N6333	AMR, CRI	50Hz-Thy 2A, 50V, 200 μ A, 0.8V	B-25	C106F, S0503MS2, TAG106F, TAG615-100		
2N6334	AMR, CRI	50Hz-Thy 2A, 100V, 200 μ A, 0.8V	B-25	C106A, S1003MS2, TAG106A, TAG615-100		
2N6335	AMR, CRI	50Hz-Thy 2A, 200V, 200 μ A, 0.8V	B-25	C106B, S2003MS2, TAG106B, TAG615-200		
2N6336	AMR, CRI	50Hz-Thy 2A, 300V, 200 μ A, 0.8V	B-25	C106C, MCR106-5, S4003MS2, TAG106C, TAG615-400		
2N6337	AMR, CRI	50Hz-Thy 2A, 400V, 200 μ A, 0.8V	B-25	C106D, MCR6240, S4003MS2, TAG106D, TAG615-400		
2N6342	AMR, ASI	SCR-D 8A, 200V, 0.125A, 3V	B-9	ECG56004, MAC222-4, Q2008L4, SK3658, SK56004, T2802B, TIC226B, TXD10K40		
2N6342A	ASI, CRI	SCR-D 12A, 200V, 0.125A, 3V	B-9	ECG56004, MAC15-4, Q2010L4, SK3658, SK56004, TIC206B, TIC236B, TW11N400, TXD10K40P		
2N6343	AMR, ASI	SCR-D 8A, 400V, 0.125A, 3V	B-9	BT138-500, ECG56006, MAC222-6, Q4008L4, T2802D, TIC226D, TXD10K40		

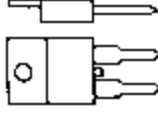
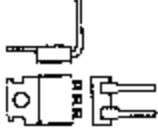
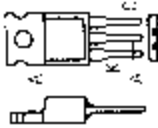

其他

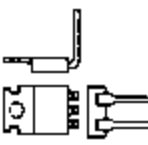
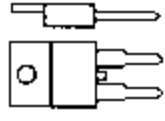
器件型号 Element type	厂名 Manufacturers	材料用途参数 Material Purpose Parameter	图号 Figure	国内外相似替换器件型号 Replace of similar type	备注 Notes	外形参考图 Reference shape
2N6343A	ASI, CRI	SCR-D 12A, 400V, 0.125A, 3V	B-9	ECG56006, Q4010L4, MAC15-6, TIC236D, TW11N400, TXD10K40P		 图 B-9
2N6344	AMR, ASI	SCR-D 8A, 600V, 0.125A, 3V	B-9	BT138-600, ECG56008, MAC222-8, Q6008L4, T2802M, TIC226M, TXD10K60		
2N6344A	ASI, CRI	SCR-D 12A, 600V, 0.125A, 3V	B-9	ECG56008, MAC15-8, Q6010L4, SK3660, SK56006, TIC236M, TW11N600, TXD10K60P		
2N6345	AMR, ASI	SCR-D 8A, 800V, 0.125A, 3V	B-9	BT138-500, ECG56010, Q6008L4, MAC222-10, T2802N, TIC226N, TXD10K80		
2N6345A	ASI, CRI	SCR-D 12A, 800V, 0.125A, 3V	B-9	BT139-600, ECG56010, Q8010L4, MAC15-10, TIC236N, TW11N800, TXD10K80P		
2N6346	AMR, ASI	SCR-D 8A, 200V, 0.125A, 3V	B-19	BT137-500, BT138-500, ECG56004, MAC222A-4, Q2008L4, T2800R, TAG224-200, TIC226B		
2N6346A	ASI, CRI	SCR-D 12A, 200V, 0.125A, 3V	B-19	BT138-500, ECG56004, MAC212A4, Q2015L5, SK3658, SK56004, TAG255-200, TIC236B, TXD10H40P		 图 B-19
2N6347	AMR, ASI	SCR-D 8A, 400V, 0.125A, 3V	B-19	BT137-500, BT138-500, ECG56006, Q4008L4, MAC212A6, MAC222A-6, T2800D, TAG224-400		
2N6347A	ASI, CRI	SCR-D 12A, 400V, 0.125A, 3V	B-19	BT138-500, BT139-600, ECG56006, Q4015L5, MAC212A6, T2800D, TAG255-400, TIC236D, TXD10H40P		
2N6348	AMR, ASI	SCR-D 8A, 600V, 0.125A, 3V	B-9	BT137-600, BT138-600, ECG56008, MAC212A8, MAC222A-8, Q6008L4, T2800M, TAG224-600		
2N6348A		SCR-D 12A, 600V, 0.075A, 0.04A	B-9	BT138-600, MAC212A8, TAG255-600, TXD10H60P		
2N6349		SCR-D 8A, 800V, 0.075A, 0.04A	B-9	BT137-800, MAC222A-10, TAG224-800		
2N6349A	ASI, CRI	SCR-D 12A, 800V, 0.125A, 3V	B-91	BT138 800, BT138-600, ECG56010, Q8015L5, TAG255-800, TXD10H80P		 图 B 91
2N6394	AMR, CRI	50Hz-Thy 7.6A, 50V, 0.06A, 2.5V	B-19	ECG5461, MCF6G-2, SK3674, SD515L, T7.5N400, TAG665-100, TIC126F, 2N6400		

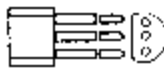
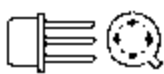
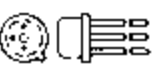
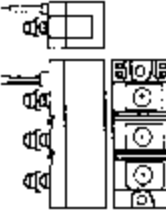

器件型号 Element type	厂名 Manufacturers	材料用途参数 Material Purpose Parameter	图号 Figure	国内外相似替换器件型号 Replace of similar type	备注 Notes	外形参考图 Reference shape
2N6395	AMR, CRI	50Hz-Thy 7.6A, 100V, 0.06A, 2.5V	B-19	MCR6G-3, S1010L, SK3574, T7.5N400, TAG665-100, TIC126A, 2N6401		 图 B-19
2N6396	AMR, CRI	50Hz-Thy 7.6A, 200V, 0.06A, 2.5V	B-19	S2010L, SK3574, TAG665 200, T7.5N400, TIC126B, 2N6402		
2N6397	AMR, CRI	50Hz-Thy 7.6A, 400V, 0.06A, 2.5V	B-19	MCR6G-6, S4010L, SK3575, TAG665-400, T7.5N400, TIC126D, 2N6403		
2N6398	AMR, CRI	50Hz-Thy 7.6A, 600V, 0.06A, 2.5V	B-19	S6010L, SK3576, T7.5N600, TAG665-600, TIC126M, 2N6404		
2N6399	AMR, DIT	50Hz-Thy 7.6A, 800V, 0.06A, 2.5V	B-19	ECG5558, S8010L, T7.5N800, TAG665-800, TIC126N, 2N6405		
2N6400		50Hz-Thy 16A, 50V, 0.03A, 0.04A	B-9	T9.5N400, TAG680-100, TAG681-100		
2N6401	AMR, ASI	50Hz-Thy 10A, 100V, 0.06A, 2.5V	B-9	S1015L, SK3574, T9.5N400, TAG680-100, TAG681-100, TIC126A		
2N6402	AMR, ASI	50Hz-Thy 10A, 200V, 0.06A, 2.5V	B-9	S2015L, SK3575, T9.5N400, TAG680-200, TAG681-200, TIC126B		 图 B-9
2N6403	AMR, ASI	50Hz-Thy 10A, 400V, 0.06A, 2.5V	B-9	S4015L, SK3576, T9.5N400, TAG680-400, TAG681-400, TIC126D		
2N6404	AMR, ASI	50Hz-Thy 10A, 600V, 0.06A, 2.5V	B-9	S6015L, T9.5N600, TAG680-600, TAG681-600, TIC126M		
2N6405	AMR, ASI	50Hz-Thy 10A, 800V, 0.06A, 2.5V	B-9	S8015L, T9.5N800, TAG680-800, TAG681-800		
2N6504	CRI, MOT	50Hz-Thy 16A, 50V, 0.075A, 1.5V	B-9	ECG5550, MCR69-2, S0520L		
2N6505	CRI, MOT	50Hz-Thy 16A, 200V, 0.075A, 1.5V	B-9	ECG5552, MCR69-3, S1020L		
2N6506		50Hz-Thy 25A, 200V, 0.04A, 0.04A	B-9			
2N6507	CRI, MOT	50Hz-Thy 16A, 400V, 0.075A, 1.5V	B-9	ECG5554, S4020L		
2N6508	CRI, MOT	50Hz-Thy 16A, 600V, 0.075A, 1.5V	B-9	ECG5556, S6020L		
2N6509		50Hz-Thy 25A, 800V, 0.04A, 0.04A	B-9			
2N6564	CRI, GES	50Hz-Thy 0.51A, 300V, 350 μA, 1.2V	B-36	EC103D, TAG72D, TAG59D, 2N5064, 2N6563		

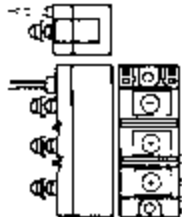
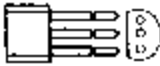





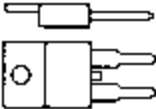

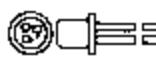
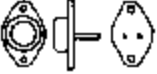













器件型号 Element type	厂名 Manufacturers	材料 Material	用途 Purpose	参数 Parameter	图号 Figure	国内外相似替换器件型号 Replace of similar type	备注 Notes	外形参考图 Reference shape
2N6565	CRI, GES	50Hz-Thy	0.51A, 400V, 350 μ A, 1.2V	B-36	B-36	BT149D, EC103D, TAG72D, TAG59D, 2N6683		
2N6605	HSE, SPE	50Hz-Thy	0.275A, 30V, 200 μ A, 0.8V	B-55	B-55	EC103Y, MCR100-3, 1AG606Y, TIC44, TIC60, 2N1595		 图 B-36
JAN2N6605	NON		0.549A, 30V, 200 μ A, 0.8V	B-65	B-65			
2N6606	CRI, HSE	50Hz-Thy	0.275A, 60V, 200 μ A, 0.8V	B-55	B-55	EC103A, MCR100-3, TAG06YY, TIC46, TIC62, 2N1595		 图 B-55
JAN2N6606	NON		0.549A, 60V, 200 μ A, 0.8V	B-65	B-65			
2N6607	CRI, HSE	50Hz-Thy	0.275A, 100V, 200 μ A, 0.8V	B-55	B-55	EC103A, MCR100-3, TAG06A, TIC46, TIC62, 2N1596		
JAN2N6607	NON		0.549A, 100V, 200 μ A, 0.8V	B-65	B-65			
2N6608	CRI, HSE	50Hz-Thy	0.275A, 200V, 200 μ A, 0.8V	B-55	B-55	EC103B, MCR100-4, TAG06B, TIC47, TIC64, 2N1597		 图 B-65
JAN2N6608	CRI, HSE		0.549A, 200V, 200 μ A, 0.8V	B-65	B-65			
2N6623	SPE	SCA	25A, 400V	H-29	H-29			
2N6624	SPE	SCA	25A, 600V	H-29	H-29			
2N6625	SPE	SCA	25A, 800V	H-29	H-29			
2N6626	SPE	SCA	25A, 1.2kV	H-29	H-29			
2N6627	SPE	SCA	25A, 1.4kV	H-29	H-29			
2N6628	SPE	SCA	32A, 400V	H-29	H-29			
2N6629	SPE	SCA	32A, 600V	H-29	H-29			
2N6630	SPE	SCA	32A, 800V	H-29	H-29			
2N6631	SPE	SCA	32A, 1.2kV	H-29	H-29			
2N6632	SPE	SCA	32A, 1.4kV	H-29	H-29			 图 H-29
2N6633	SPE	SCA	45A, 400V	H-29	H-29			
2N6634	SPE	SCA	45A, 600V	H-29	H-29			
2N6635	SPE	SCA	45A, 800V	H-29	H-29			
2N6636	SPE	SCA	45A, 1.2kV	H-29	H-29			

器件型号 Element type	厂名 Manufacturers	材料用途参数 Material Purpose Parameter	图号 Figure	国内外相似替换器件型号 Replace of similar type	备注 Notes	外形参考图 Reference shape	
2N6637	SPE	SCA 45A, 1.4kV	H-29			 图 H-29	
2N6638	SPE	SCA 57A, 400V	H-29				
2N6639	SPE	SCA 57A, 600V	H-29				
2N6640	SPE	SCA 57A, 800V	H-29				
2N6641	SPE	SCA 57A, 1.2kV	H-29				
2N6642	SPE	SCA 57A, 1.4kV	H-29				
2N6643	SPE	SCA 90A, 400V	H-29				
2N6644	SPE	SCA 85A, 600V	H-29				
2N6645	SPE	SCA 90A, 800V	H-29			 图 B-36	
2N6681	SPE, THE	50Hz-Thy 0.664A, 100V, 800 μA, 1.2V	B-36	BT149A, MCR606-3, TAG59A			
2N6682	SPE, THE	50Hz-Thy 0.664A, 200V, 800 μA, 1.2V	B-36	BT149B, MCR606-4, TAG59B			
2N6683	SPE, THE	50Hz-Thy 0.664A, 400V, 800 μA, 1.2V	B-36	BT149D, MCR606-6, TAG59D			
2N6684	SPE, THE	50Hz-Thy 0.664A, 600V, 800 μA, 1.2V	B-36	BT149M, MCR606-8, TAG59M			
2N6685	THE	50Hz-Thy 0.664A, 800V, 800 μA, 1.2V	B-36	TAG615-R00			
2P05M	NEC	50Hz-Thy 4A, 50V, 200 μA, 0.8V	B-87	C108F, C106F1, TAG106F, TAG108F			 图 B-87
2P1M	NEC	50Hz-Thy 4A, 100V, 200 μA, 0.8V	B-87	C106A1, C108A, ECG5454, TAG106A, TAG108A			
2P2M	NEC, SST	50Hz-Thy 4A, 200V, 200 μA, 0.8V	B-87	C106B1, C108B, ECG5455, TAG106B, TAG108B			
2P4M	NEC, NEJ	50Hz-Thy 4A, 400V, 200 μA, 0.8V	B-87	C106D1, C108D, ECG5457, TAG106D, TAG108D			
2P5M	NEC, NEJ	50Hz-Thy 4A, 500V, 200 μA, 0.8V	B-87	C106E1, C108E, TAG106E, TAG108E			
2P6M	NEC, NEJ	50Hz-Thy 4A, 600V, 200 μA, 0.8V	B-87	C106M1, C108M, TAG106M, TAG108M			
2S2M	NEC, NEJ	2A, 200V, 300 μA, 0.8V	B-87				
2S3M	NEC	2A, 300V, 300 μA, 0.8V	B-87				
2S4M	NEC, NEJ	2A, 400V, 300 μA, 0.8V	B-87				
2SF11		5.4A, 50V					



器件型号 Element type	厂名 Manufacturers	材料用途参数 Material Purpose Parameter	图号 Figure	国内外相似替换器件型号 Replace of similar type	备注 Notes	外形参考图 Reference snape	
2SF12		5.4A, 100V				 图 R-9	
2SF14		5.4A, 200V					
2SF16		5.4A, 300V					
2SF18		5.4A, 400V					
2SF101	NEC	0.3A, 50V, 500 μ A, 1V	B-9	ECG5401, SK3638, SK5402		 图 R-51	
2SF101B	NEC	0.47A, 50V, 500 μ A, 1V	B-51				
2SF102	NEC	0.3A, 100V, 500 μ A, 1V	B-51	ECG5402, SK3638, SK5402			
2SF102B	NEC	0.47, 100V, 500 μ A, 1V	B-53				
2SF104	NEC	0.3A, 200V, 500 μ A, 1V	B-51	ECG5404, SK3627, SK5404			
2SF104B	NEC	0.47A, 200V, 500 μ A, 1V	B-53				
2SF106	NEC	0.3A, 300V, 500 μ A, 1V	B-51	ECG5405, SK3951, SK5405			
2SF106B	NEC	0.47A, 300V, 500 μ A, 1V	B-53				
2SF108	NEC	0.3A, 400V, 500 μ A, 1V	B-51	ECG5405, SK3951, SK5405			
2SF108B	NEC	0.47A, 400V, 500 μ A, 1V	B-53				
2SF110B	NEC	0.47A, 500V, 500 μ A, 1V	B-51				
2SF200		5.4A, 500V					 图 B-53
2SF521	MIT	0.4A, 50V, 0.003A, 1V	B-68	ECG5401, SK3638, SK5402			 图 B-68
2SF522	MIT	0.4A, 100V, 0.003A, 1V	B-68	ECG5402, SK3638, SK5402			
2SF523	MIT	0.4A, 200V, 0.003A, 1V	B-68	ECG5404, SK3627, SK5404			
2SF524	MIT	0.4A, 300V, 0.003A, 1V	B-68	ECG5405, SK3951, SK5405			
2SF525	MIT	0.4A, 400V, 0.003A, 1V	B-68	ECG5405, SK3951, SK5405			
2SF526	MIT	0.4A, 500V, 0.003A, 1V	B-68	ECG5406, SK3952, SK5406			
2SF527	MIT	0.4A, 600V, 0.003A, 1V	B-68	ECG5406, SK3952, SK5406			
2SF528	MIT	3A, 50V, 0.02A, 2V	D-9				
2SF529	MIT	3A, 100V, 0.02A, 2V	D-9				
2SF530	MIT	3A, 200V, 0.02A, 2V	D-9				



器件型号 Element type	厂名 Manufacturers	材料用途参数 Material Purpose Parameter	图号 Figure	国内外相似替换器件型号 Heplace of similar type	备注 Notes	外形参考图 Reference shape
2SF531	MIT	3A, 300V, 0.02A, 2V	D-9			
2SF533	MIT	3A, 500V, 0.02A, 2V	D-9			
2SF534	MIT	3A, 600V, 0.02A, 2V	D-9			
2SF535	MIT	250A, 100V, 0.35A, 4V	F-74			
2SF536	MIT	250A, 200V, 0.35A, 4V	F-74			
2SF537	MIT	250A, 400V, 0.35A, 4V	F-74			
2SF538	MIT	250A, 600V, 0.35A, 4V	F-74			
2SF539	MIT	250A, 800V, 0.35A, 4V	F-74			
2SF540	MIT	250A, 1KV, 0.35A, 4V	F-74			
2SF542	MIT	250A, 1.4KV, 0.35A, 4V	F-74			
2SF543	MIT	250A, 1.6KV, 0.35A, 4V	F-74			
2SF544	MIT	250A, 1.8KV, 0.35A, 4V	F-74			
2SF935	MIT	400A, 1.4KV, 0.35A, 4V	C-76			
2SF936	MIT	400A, 1.6KV, 0.35A, 4V	C-76			
2SF937	MIT	400A, 1.8KV, 0.35A, 4V	C-76			
2SF938	MIT	400A, 2KV, 0.35A, 4V	C-76			
2SF939	MIT	400A, 2.5KV, 0.35A, 4V	C-76			
2SF1110	MIT	0.3A, 50V, 250 μA, 0.8V	B-36	ECG5401, SK3636, SK5402		
2SF1111	MIT	0.3A, 100V, 250 μA, 0.8V	B-36	SK3636, SK5402		
2SF1112	MIT	0.3A, 200V, 250 μA, 0.8V	B-36	ECG5404, SK3627, SK5404		
2SF1113	MIT	0.3A, 300V, 250 μA, 0.8V	B-36	SK3951, SK5405		
2SF1114	MIT	0.3A, 400V, 250 μA, 0.8V	B-36	SK3951, SK5405		
2SF1142	MIT	175A, 200V, 0.3A, 3V	F-71	ECG5587		
2SF1143	MIT	175A, 300V, 0.3A, 3V	F-71			

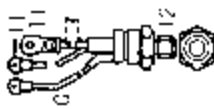
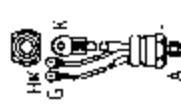

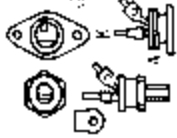
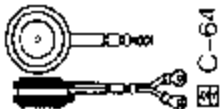
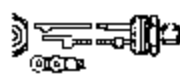
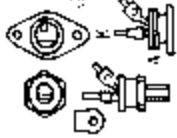
器件型号 Element type	厂名 Manufacturers	材料用途参数 Material Purpose Parameter	图号 Figure	国内外相似替换器件型号 Replace of similar type	备注 Notes	外形参考图 Reference shape
2SF1144	MIT	175A, 400V, 0.3A, 3V	F-71	ECG5587		
2SF1145	MIT	175A, 500V, 0.3A, 3V	F-71	ECG5587		图 F-71
2SF1146	MIT	175A, 600V, 0.3A, 3V	F-71	ECG5587		
2SF1147	MIT	175A, 800V, 0.3A, 3V	F-71	ECG5589		图 D-9
2SF1148	MIT	175A, 1kV, 0.3A, 3V	F-71	ECG5589		
2SF1149	MIT	175A, 1.2kV, 0.3A, 3V	F-71	ECG5589		
2SF1151	MIT	175A, 1.6kV, 0.3A, 3V	F-71			图 F-71
2SF1152	MIT	175A, 1.8kV, 0.3A, 3V	F-71			
2SF1168(A)		50Hz-Thy 6A, 200V, 0.025A, 0.015A	D-9	MCR218-4, TAG625-200, TAG651-200		
2SF1188		SCR-H TV-HA, 3.2A, 650V, 0.03A	D-9	S3703, TD3F700H, TD4F700H		图 F-74
2SF1189		SCR-H TV-HA, 3.2A, 600V, 0.03A	D-9	S3702, TD3F800R, TD4F800R		
2SF1365	MIT	250A, 100V, 0.35A, 4V	F-74			图 F-74
2SF1366	MIT	250A, 200V, 0.35A, 4V	F-74			
2SF1367	MIT	250A, 300V, 0.35A, 4V	F-74			
2SF1369	MIT	250A, 500V, 0.35A, 4V	F-74			图 D-21
2SF1370	MIT	250A, 600V, 0.35A, 4V	F-74			
2SF1424-200		16A, 200V	D-21			图 D-21
2SF1424-300		16A, 300V	D-21			
2SF1424-400		16A, 400V	D-21			
2SF1424-500		16A, 500V	D-21			
2SF1424-600		16A, 600V	D-21			
2SF1425-200		16A, 200V	D-21			
2SF1425-300		16A, 300V	D-21			

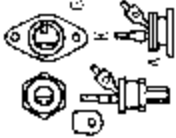
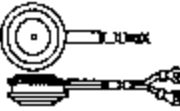
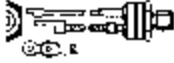

器件型号 Element type	厂名 Manufacturers	材料用途参数 Material Purpose Parameter	图号 Figure	国内外相似替换器件型号 Replace of similar type	备注 Notes	外形参考图 Reference shape
2SF1425-400		16A, 400V	D-21			 图 D-21
2SF1425-500		16A, 500V	D-21			
2SF1425-600		16A, 600V	D-21			
2SF1431-1800		400A, 1.8kV	C-64			
2SF1431-2000		400A, 2kV	C-64			 图 C-64
2SF1431-2300		400A, 2.3kV	C-64			
2SF1431-2500		400A, 2.5kV	C-64			
2SF1434-2000		1kA, 2kV	F-63			
2SF1434-2300		1kA, 2.3kV	F-63			 图 F-63
2SF1434-2500		1kA, 2.5kV	F-63			
2SF1448-200		22A, 200V	D-21			
2SF1448-300		22A, 300V	D-21			
2SF1448-400		22A, 400V	D-21			 图 C-64
2SF1448-500		22A, 500V	D-21			
2SF1448-600		22A, 600V	D-21			
2SF1449-200		22A, 200V	D-21			
2SF1449-300		22A, 300V	D-21			
2SF1449-400		22A, 400V	D-21			
2SF1449-500		22A, 500V	D-21			
2SF1449-600		22A, 600V	D-21			
2SF1450-200		50Hz-Thy 30A, 200V	D-21	CP8C		
2SF1450-300		50Hz-Thy 30A, 300V	D-21	CP8D		
2SF1450-400		50Hz-Thy 30A, 400V	D-21	CP8E		
2SF1450-500		50Hz-Thy 30A, 500V	D-21	CP8F		
2SF1450-600		50Hz-Thy 30A, 600V	D-21	CP8G		
2SF1451-200		50Hz-Thy 30A, 200V	D-21	CP9C		

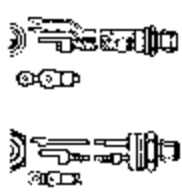
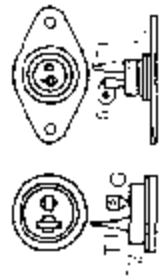
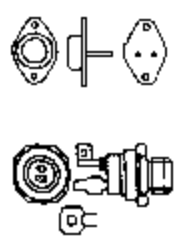

器件型号 Element type	厂名 Manufacturers	材料用途参数 Material Purpose Parameter	图号 Figure	国内外相似替换器件型号 Replace of similar type	备注 Notes	外形参考图 Reference shape	
2SF1451-300		50Hz-Thy 30A, 300V	D-21	CP9D		 图 D-21	
2SF1451-400		50Hz-Thy 30A, 400V	D-21	CP9E			
2SF1451-500		50Hz-Thy 30A, 500V	D-21	CP9F			
2SF1451-600		50Hz-Thy 30A, 600V	D-21	CP9G			
2SF1452-200		50A, 200V	D-21				
2SF1452-300		50A, 300V	D-21				
2SF1452-400		50A, 400V	D-21				
2SF1452-500		50A, 500V	D-21				
2SF1452-600		50A, 600V	D-21			 图 C-64	
2SF1454-200		70A, 200V	C-64				
2SF1454-400		70A, 400V	C-64				
2SF1454-600		70A, 600V	C-64				
2SF1454-800		70A, 800V	C-64				
2SF1455-200		100A, 200V	F-63				 图 F-63
2SF1455-300		100A, 300V	F-63				
2SF1455-400		100A, 400V	F-63				
2SF1455-500		100A, 500V	F-63				
2SF1455-600		100A, 600V	F-63				
2SF1455-800		100A, 800V	F-63				
2SF1456-200		150A, 200V	F-75				
2SF1456-400		150A, 400V	F-75			 图 F-75	
2SF1456-600		150A, 600V	F-75				
2SF1456-800		150A, 800V	F-75				
2SF1457-200		250A, 200V	F-75				
2SF1457-400		250A, 400V	F-75				
2SF1457-600		250A, 600V	F-75				
2SF1457-800		250A, 800V	F-75				
2SF1458-200	SCR-H	70A, 200V	F-63				

器件型号 Element type	厂名 Manufacturers	材料用途参数 Material Purpose Parameter	图号 Figure	国内外相似替换器件型号 Replace of similar type	备注 Notes	外形参考图 Reference shape	
2SF1458-400	SCR-H	70A, 400V	F-63			 图 F-63 至 F-75	
2SF1458-600	SCR-H	70A, 600V	F-63				
2SF1458-800	SCR-H	70A, 800V	F-63				
2SF1459-200	SCR-H	100A, 200V	F-63				
2SF1459-400	SCR-H	100A, 400V	F-63				
2SF1459-600	SCR-H	100A, 600V	F-63				
2SF1459-800	SCR-H	100A, 800V	F-63				
2SF1460-200	SCR-H	150A, 200V	F-75				
2SF1460-400	SCR-H	150A, 400V	F-75				
2SF1460-600	SCR-H	150A, 600V	F-75				
2SF1460-800	SCR-H	150A, 800V	F-75			 图 C-88 图 D-28	
2SF1461-200	SCR-H	250A, 200V	F-75				
2SF1461-400	SCR-H	250A, 400V	F-75				
2SF1461-600	SCR-H	250A, 600V	F-75				
2SF1461-800	SCR-H	250A, 800V	F-75				
2SM136	MIT	16A, 200V, 0.03A, 1.5V	C-88				 图 F-15 图 D-9
2SM137	MIT	16A, 300V, 0.03A, 1.5V	C-88				
2SM138	MIT	16A, 400V, 0.03A, 1.5V	C-88				
2SM139	MIT	16A, 500V, 0.03A, 1.5V	C-88				
2SM140	MIT	16A, 200V, 0.03A, 1.5V	D-28				
2SM141	MIT	16A, 300V, 0.03A, 1.5V	D-28				
2SM142	MIT	16A, 400V, 0.03A, 1.5V	D-28				
2SM143	MIT	16A, 500V, 0.03A, 1.5V	D-28				
2SM144	MIT	16A, 200V, 0.03A, 1.5V	F-15	ECG5675			
2SM145	MIT	16A, 300V, 0.03A, 1.5V	F-15	ECG5675			
2SM146	MIT	16A, 400V, 0.03A, 1.5V	F-15	ECG5675			
2SM147	MIT	16A, 500V, 0.03A, 1.5V	F-15	ECG5677			
2SM148	SCR-D	6A, 200V, 0.045A, 0.01A	D-9	T2700B, TAG261-200, TAG266-200			

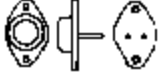

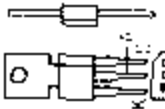
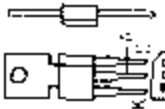
器件型号 Element type	厂名 Manufacturers	材料用途参数 Material Purpose Parameter	图号 Figure	国内外相似替换器件型号 Replace of similar type	备注 Notes	外形参考图 Reference shape
2SM149	SCR-D	6A, 400V, 0.045A, 0.01A	D-9	T2700D, TAG261-400, TAG266-400		 图 D-9
2SM150	SCR-D	6A, 600V, 0.045A, 0.01A	D-9	T2700M, TAG261-600, TAG266-600		
2SM152	SCR-D	1A, 200V, 0.015A	B-98	TAG137B, TAG138B		
2SP1S		25A, 100V				 图 B-89
2SP2S		25A, 200V				
2SP3S		25A, 300V				
2SP4S		25A, 400V				
2SP5S		25A, 500V				
2SP6S		25A, 600V				
2SP8S		25A, 800V				 图 B-89
2SP12S		25A, 1.2KV				
2STO-220S		25A, 1KV				
2V5P4M	NEJ	2.5A, 400V, 200 μ A, 0.8V	B-89			 图 B-89
2V5P5M		2.5A, 500V	B-89			
2V5P6M	NEJ	2.5A, 600V, 200 μ A, 0.8V	B-89			
3CT1K	CHN	0.05A				 图 B-89
3CT1S	CHN	1A, 775V				
3CT2K	CHN	0.1A				
3CT2S	CHN	2A, 775V				
3CT3K	CHN	0.2A				
3CT3S	CHN	3A, 775V				
3CT4K	CHN	0.5A				
3CT5K	CHN	1A				

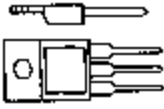
器件型号 Element type	厂名 Manufacturers	材料用途参数 Material Purpose Parameter	图号 Figure	国内外相似替换器件型号 Replace of similar type	备注 Notes	外形参考图 Reference shape
3CT12A	CHN	1A, 50V				 图 B-10
3CT12B	CHN	1A, 100V				
3CT12C	CHN	1A, 200V				
3CT12D	CHN	1A, 300V				
3CT12E	CHN	1A, 400V				
3CT12F	CHN	1A, 500V				
3CT12G	CHN	1A, 600V				
3CT12H	CHN	1A, 700V				
3CT35	CHN	0.2A, 625V				
3CT36	CHN	0.2A, 625V				
3CT0052A	CHN	0.05A, 50V				
3CT0052B	CHN	0.05A, 100V				
3CT0052C	CHN	0.05A, 200V				
3CT0052D	CHN	0.05A, 300V				
3CT0052E	CHN	0.05A, 400V				
3CT011	CHN	0.05A, 210V				
3CT012A	CHN	0.1A, 50V				
3CT012B	CHN	0.1A, 100V				
3CT012C	CHN	0.1A, 200V				
3CT012D	CHN	0.1A, 300V				
3CT012E	CHN	0.1A, 400V				
3CT015A	CHN	0.05A, 20V, 0.00005~0.005A, 1.5V B-10				
3CT015B	CHN	0.05A, 50V, 0.00005~0.005A, 1.5V B-10				
3CT015C	CHN	0.05A, 100V, 0.00005~0.005A, B-10 1.5V				

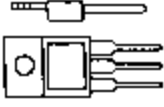

器件型号 Element type	厂名 Manufacturers	材料 用途 参数 Material Purpose Parameter	图号 Figure	国内外相似替换器件型号 Replace of similar type	备注 Notes	外形参考图 Reference shape
3CT015D	CHN	0.05A, 200V, 0.00005-0.005A, B-10 1.5V	B-10			 图 B 10
3CT015E	CHN	0.05A, 300V, 0.00005-0.005A, B-10 1.5V	B-10			
3CT015F	CHN	0.05A, 400V, 0.00005-0.005A, B-10 1.5V	B-10			
3CT015G	CHN	0.05A, 500V, 0.00005-0.005A, B-10 1.5V	B-10			
3CT015H	CHN	0.05A, 600V, 0.00005-0.005A, B-10 1.5V	B-10			
3CT015J	CHN	0.05A, 700V, 0.00005-0.005A, B-10 1.5V	B-10			
3CT016A	CHN	0.05A, 20V, 0.00001-0.005A, 1.5V B-10	B-10			
3CT016B	CHN	0.05A, 50V, 0.00001-0.005A, 1.5V B-10	B-10			
3CT016C	CHN	0.05A, 100V, 0.00001-0.005A, B-10 1.5V	B-10			
3CT016D	CHN	0.05A, 200V, 0.00001-0.005A, B-10 1.5V	B-10			
3CT016E	CHN	0.05A, 300V, 0.00001-0.005A, B-10 1.5V	B-10			
3CT016F	CHN	0.05A, 400V, 0.00001-0.005A, B-10 1.5V	B-10			
3CT016G	CHN	0.05A, 500V, 0.00001-0.005A, B-10 1.5V	B-10			
3CT016H	CHN	0.05A, 600V, 0.00001-0.005A, B-10 1.5V	B-10			
3CT016J	CHN	0.05A, 700V, 0.00001-0.005A, B-10 1.5V	B-10			

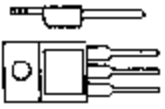
器件型号 Element type	厂名 Manufacturers	材料用途参数 Material Purpose Parameter	图号 Figure	国内外相似替换器件型号 Replace of similar type	备注 Notes	外形参考图 Reference shape
3CT021	CHN	0.1A, 360V				 图 B-10
3CT022	CHN	0.1A, 510V				
3CT022A	CHN	0.2A, 50V				
3CT022B	CHN	0.2A, 100V				
3CT022C	CHN	0.2A, 200V				
3CT022D	CHN	0.2A, 300V				
3CT022E	CHN	0.2A, 400V				
3CT025	CHN	0.1A, 625V				
3CT025A	CHN	0.1A, 20V, 0.00001~0.01A, 1.5V B-10				
3CT025B	CHN	0.1A, 50V, 0.00001~0.01A, 1.5V B-10				
3CT025C	CHN	0.1A, 100V, 0.00001~0.01A, 1.5V B-10				
3CT025D	CHN	0.1A, 200V, 0.00001~0.01A, 1.5V B-10				
3CT025E	CHN	0.1A, 300V, 0.00001~0.01A, 1.5V B-10				
3CT025F	CHN	0.1A, 400V, 0.00001~0.01A, 1.5V B-10				
3CT025G	CHN	0.1A, 500V, 0.00001~0.01A, 1.5V B-10				
3CT025H	CHN	0.1A, 600V, 0.00001~0.01A, 1.5V B-10				
3CT025J	CHN	0.1A, 700V, 0.00001~0.01A, 1.5V B-10				
3CT026	CHN	0.1A, 625V				
3CT026A	CHN	0.1A, 20V, 0.00001~0.01A, 1.5V B-10				
3CT026B	CHN	0.1A, 50V, 0.00001~0.01A, 1.5V B-10				
3CT026C	CHN	0.1A, 100V, 0.00001~0.01A, 1.5V B-10				
3CT026D	CHN	0.1A, 200V, 0.00001~0.01A, 1.5V B-10				
3CT026E	CHN	0.1A, 300V, 0.00001~0.01A, 1.5V B-10				
3CT026F	CHN	0.1A, 400V, 0.00001~0.01A, 1.5V B-10				
3CT026G	CHN	0.1A, 500V, 0.00001~0.01A, 1.5V B-10				
3CT026H	CHN	0.1A, 600V, 0.00001~0.01A, 1.5V B-10				
3CT026J	CHN	0.1A, 700V, 0.00001~0.01A, 1.5V B-10				

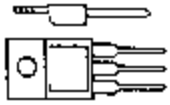

器件型号 Element type	厂名 Manufacturers	材料用途参数 Material Purpose Parameter	图号 Figure	国内外相似替换器件型号 Replace of similar type	备注 Notes	外形参考图 Reference shape
3CT031	CHN	0.2A, 360V				 图 B-10
3CT032	CHN	0.2A, 510V				
3CT032A	CHN	0.3A, 50V				
3CT032B	CHN	0.3A, 100V				
3CT032C	CHN	0.3A, 200V				
3CT032D	CHN	0.3A, 300V				
3CT032E	CHN	0.3A, 400V				
3CT032F	CHN	0.3A, 500V				
3CT032G	CHN	0.3A, 600V				
3CT032H	CHN	0.3A, 700V				
3CT035A	CHN	0.2A, 20V, 0.00001-0.015A, 1.5V B-10				
3CT035B	CHN	0.2A, 50V, 0.00001-0.015A, 1.5V B-10				
3CT035C	CHN	0.2A, 100V, 0.00001-0.015A, 1.5V B-10				
3CT035D	CHN	0.2A, 200V, 0.00001-0.015A, 1.5V B-10				
3CT035E	CHN	0.2A, 300V, 0.00001-0.015A, 1.5V B-10				
3CT035F	CHN	0.2A, 400V, 0.00001-0.015A, 1.5V B-10				
3CT035G	CHN	0.2A, 500V, 0.00001-0.015A, 1.5V B-10				
3CT035H	CHN	0.2A, 600V, 0.00001-0.015A, 1.5V B-10				
3CT035J	CHN	0.2A, 700V, 0.00001-0.015A, 1.5V B-10				
3CT036A	CHN	0.2A, 20V, 0.00001-0.015A, 1.5V B-10				
3CT036B	CHN	0.2A, 50V, 0.00001-0.015A, 1.5V B-10				
3CT036C	CHN	0.2A, 100V, 0.00001-0.015A, 1.5V B-10				
3CT036D	CHN	0.2A, 200V, 0.00001-0.015A, 1.5V B-10				
3CT036E	CHN	0.2A, 300V, 0.00001-0.015A, 1.5V B-10				
3CT036F	CHN	0.2A, 400V, 0.00001-0.015A, 1.5V B-10				
3CT036G	CHN	0.2A, 500V, 0.00001-0.015A, 1.5V B-10				
3CT036H	CHN	0.2A, 600V, 0.00001-0.015A, 1.5V B-10				
3CT036J	CHN	0.2A, 700V, 0.00001-0.015A, 1.5V B-10				

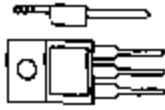
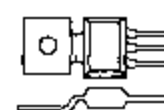

器件型号 Element type	厂名 Manufacturers	材料用途参数 Material Purpose Parameter	图号 Figure	国内外相似替换器件型号 Replace of similar type	备注 Notes	外形参考图 Reference shape
3CT041	CHN	0.3A, 510V				 图 B-10
3CT042	CHN	0.3A, 510V				
3CT045	CHN	0.3A, 645V				 图 B-21
3CT045A	CHN	0.3A, 20V, 0.00001~0.015A, 1.5V B-10				
3CT045B	CHN	0.3A, 50V, 0.00001~0.015A, 1.5V B-10				
3CT045C	CHN	0.3A, 100V, 0.00001~0.015A, 1.5V B-10				
3CT045D	CHN	0.3A, 200V, 0.00001~0.015A, 1.5V B-10				
3CT045E	CHN	0.3A, 300V, 0.00001~0.015A, 1.5V B-10				
3CT045F	CHN	0.3A, 400V, 0.00001~0.015A, 1.5V B-10				
3CT045G	CHN	0.3A, 500V, 0.00001~0.015A, 1.5V B-10				
3CT045H	CHN	0.3A, 600V, 0.00001~0.015A, 1.5V B-10				
3CT045J	CHN	0.3A, 700V, 0.00001~0.015A, 1.5V B-10				
3CT046	CHN	0.3A, 645V				
3CT046A	CHN	0.3A, 20V, 0.00001~0.015A, 1.5V B-10				
3CT046B	CHN	0.3A, 50V, 0.00001~0.015A, 1.5V B-10				
3CT046C	CHN	0.3A, 100V, 0.00001~0.015A, 1.5V B-10				
3CT046D	CHN	0.3A, 200V, 0.00001~0.015A, 1.5V B-10				
3CT046E	CHN	0.3A, 300V, 0.00001~0.015A, 1.5V B-10				
3CT046F	CHN	0.3A, 400V, 0.00001~0.015A, 1.5V B-10				
3CT046G	CHN	0.3A, 500V, 0.00001~0.015A, 1.5V B-10				
3CT046H	CHN	0.3A, 600V, 0.00001~0.015A, 1.5V B-10				
3CT046J	CHN	0.3A, 700V, 0.00001~0.015A, 1.5V B-10				
3CT051	CHN	0.5A, 510V				
3CT051A	CHN	0.5A, 20V, 0.00005~0.02A, 2V B-21				
3CT051B	CHN	0.5A, 50V, 0.00005~0.02A, 2V B-21				
3CT051C	CHN	0.5A, 100V, 0.00005~0.02A, 2V B-21				
3CT051D	CHN	0.5A, 200V, 0.00005~0.02A, 2V B-21				

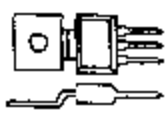
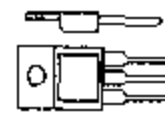

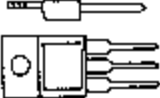
器件型号 Element type	厂名 Manufacturers	材料用途参数 Material Purpose Parameter	图号 Figure	国内外相似替换器件型号 Replace of similar type	备注 Notes	外形参考图 Reference shape	
3CT051E	CHN	0.5A, 300V, 0.00005-0.02A, 2V B-21				 B-21	
3CT051F	CHN	0.5A, 400V, 0.00005-0.02A, 2V B-21					
3CT051G	CHN	0.5A, 500V, 0.00005-0.02A, 2V B-21					
3CT051H	CHN	0.5A, 600V, 0.00005-0.02A, 2V B-21					
3CT052	CHN	4.5A, 510V					
3CT052A	CHN	4.5A, 50V					
3CT052B	CHN	4.5A, 100V					
3CT052C	CHN	4.5A, 200V					
3CT052D	CHN	4.5A, 300V					
3CT052E	CHN	4.5A, 400V					
3CT052F	CHN	4.5A, 500V					
3CT052G	CHN	4.5A, 600V					
3CT052H	CHN	4.5A, 700V					
3CT055	CHN	0.5A, 625V					 B-10
3CT055A	CHN	0.5A, 20V, 0.00005-0.02A, 2V B-10					
3CT055B	CHN	0.5A, 50V, 0.00005-0.02A, 2V B-10					
3CT055C	CHN	0.5A, 100V, 0.00005-0.02A, 2V B-10					
3CT055D	CHN	0.5A, 200V, 0.00005-0.02A, 2V B-10					
3CT055E	CHN	0.5A, 300V, 0.00005-0.02A, 2V B-10					
3CT055F	CHN	0.5A, 400V, 0.00005-0.02A, 2V B-10					
3CT055G	CHN	0.5A, 500V, 0.00005-0.02A, 2V B-10					
3CT055H	CHN	0.5A, 600V, 0.00005-0.02A, 2V B-10					
3CT055J	CHN	0.5A, 700V, 0.00005-0.02A, 2V B-10					
3CT056	CHN	0.5A, 625V					
3CT056A	CHN	0.5A, 20V, 0.00005-0.02A, 2V B-10					
3CT056B	CHN	0.5A, 50V, 0.00005-0.02A, 2V B-10					
3CT056C	CHN	0.5A, 100V, 0.00005-0.02A, 2V B-10					
3CT056D	CHN	0.5A, 200V, 0.00005-0.02A, 2V B-10					

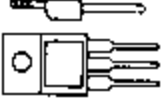

器件型号 Element type	厂名 Manufacturers	材料用途参数 Material Purpose Parameter	图号 Figure	国内外相似替换器件型号 Replace of similar type	备注 Notes	外形参考图 Reference shape
3CT056E	CHN	0.5A, 300V, 0.00005-0.02A, 2V B-10				 图 B-10
3CT056F	CHN	0.5A, 400V, 0.00005-0.02A, 2V B-10				
3CT056G	CHN	0.5A, 500V, 0.00005-0.02A, 2V B-10				
3CT056H	CHN	0.5A, 600V, 0.00005-0.02A, 2V B-10				
3CT056J	CHN	0.5A, 700V, 0.00005-0.02A, 2V B-10				
3CT061	CHN	1A, 525V				
3CT062	CHN	1A, 525V				
3CT063	CHN	1A, 775V				
3CT064	CHN	1A, 775V				
3CT065	CHN	1A, 625V				
3CT065A	CHN	1A, 20V, 0.0001-0.03A, 2V B-10	B-10			
3CT065B	CHN	1A, 50V, 0.0001-0.03A, 2V B-10	B-10			
3CT065C	CHN	1A, 100V, 0.0001-0.03A, 2V B-10	B-10			
3CT065D	CHN	1A, 200V, 0.0001-0.03A, 2V B-10	B-10			
3CT065E	CHN	1A, 300V, 0.0001-0.03A, 2V B-10	B-10			
3CT065F	CHN	1A, 400V, 0.0001-0.03A, 2V B-10	B-10			
3CT065G	CHN	1A, 500V, 0.0001-0.03A, 2V B-10	B-10			
3CT065H	CHN	1A, 600V, 0.0001-0.03A, 2V B-10	B-10			
3CT065J	CHN	1A, 700V, 0.0001-0.03A, 2V B-10	B-10			
3CT066	CHN	1A, 625V				
3CT066A	CHN	1A, 20V, 0.0001-0.03A, 2V B-10	B-10			
3CT066B	CHN	1A, 50V, 0.0001-0.03A, 2V B-10	B-10			
3CT066C	CHN	1A, 100V, 0.0001-0.03A, 2V B-10	B-10			
3CT066D	CHN	1A, 200V, 0.0001-0.03A, 2V B-10	B-10			
3CT066E	CHN	1A, 300V, 0.0001-0.03A, 2V B-10	B-10			
3CT066F	CHN	1A, 400V, 0.0001-0.03A, 2V B-10	B-10			
3CT066G	CHN	1A, 500V, 0.0001-0.03A, 2V B-10	B-10			
3CT066H	CHN	1A, 600V, 0.0001-0.03A, 2V B-10	B-10			

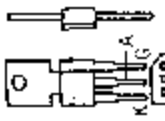
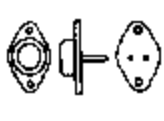

器件型号 Element type	厂名 Manufacturers	材料用途参数 Material Purpose Parameter	图号 Figure	国内外相似替换器件型号 Replace of similar type	备注 Notes	外形参考图 Reference shape
3CT066J	CHN	1A, 700V, 0.0001-0.03A, 2V	B-10			
3CT071	CHN	3A, 350V				
3CT071C	CHN	3A, 200V, 0.0001-0.001A, 1V	B-89			
3CT071D	CHN	3A, 300V, 0.0001-0.001A, 1V	B-89			
3CT071E	CHN	3A, 400V, 0.0001-0.001A, 1V	B-89			
3CT071F	CHN	3A, 500V, 0.0001-0.001A, 1V				
3CT071G	CHN	3A, 600V, 0.0001-0.001A, 1V	B-89			
3CT071H	CHN	3A, 700V, 0.0001-0.001A, 1V	B-89			
3CT075	CHN	3A, 410V				
3CT075A	CHN	3A, 50V, 0.005-0.07A, 3.5V	B-89			
3CT075B	CHN	3A, 100V, 0.005-0.07A, 3.5V	B-89			
3CT075C	CHN	3A, 200V, 0.005-0.07A, 3.5V	B-89			
3CT075D	CHN	3A, 300V, 0.005-0.07A, 3.5V	B-89			
3CT075E	CHN	3A, 400V, 0.005-0.07A, 3.5V	B-89			
3CT075F	CHN	3A, 500V, 0.005-0.07A, 3.5V	B-89			
3CT075G	CHN	3A, 600V, 0.005-0.07A, 3.5V	B-89			
3CT075H	CHN	3A, 700V, 0.005-0.07A, 3.5V	B-89			
3CT075J	CHN	3A, 800V, 0.005-0.07A, 3.5V	B-89			
3CT076A	CHN	3A, 50V, 0.005-0.07A, 3.5V	B-89			
3CT076B	CHN	3A, 100V, 0.005-0.07A, 3.5V	B-89			
3CT076C	CHN	3A, 200V, 0.005-0.07A, 3.5V	B-89			
3CT076D	CHN	3A, 300V, 0.005-0.07A, 3.5V	B-89			
3CT076E	CHN	3A, 400V, 0.005-0.07A, 3.5V	B-89			
3CT076F	CHN	3A, 500V, 0.005-0.07A, 3.5V	B-89			
3CT076G	CHN	3A, 600V, 0.005-0.07A, 3.5V	B-89			
3CT076H	CHN	3A, 700V, 0.005-0.07A, 3.5V	B-89			
3CT076J	CHN	3A, 800V, 0.005-0.07A, 3.5V	B-89			

器件型号 Element type	厂名 Manufacturers	材料用途参数 Material Purpose Parameter	图号 Figure	国内外相似替换器件型号 Replace of similar type	备注 Notes	外形参考图 Reference shape
3CT085	CHN	5A, 425V				 图 B-89
3CT085A	CHN	5A, 50V, 0.005-0.07A, 3.5V	B-89			
3CT085B	CHN	5A, 100V, 0.005-0.07A, 3.5V	B-89			
3CT085C	CHN	5A, 200V, 0.005-0.07A, 3.5V	B-89			
3CT085D	CHN	5A, 300V, 0.005-0.07A, 3.5V	B-89			
3CT085E	CHN	5A, 400V, 0.005-0.07A, 3.5V	B-89			
3CT085F	CHN	5A, 500V, 0.005-0.07A, 3.5V	B-89			
3CT085G	CHN	5A, 600V, 0.005-0.07A, 3.5V	B-89			
3CT085H	CHN	5A, 700V, 0.005-0.07A, 3.5V	B-89			
3CT085J	CHN	5A, 800V, 0.005-0.07A, 3.5V	B-89			
3CT086A	CHN	5A, 50V, 0.005-0.07A, 3.5V	B-89			
3CT086B	CHN	5A, 100V, 0.005-0.07A, 3.5V	B-89			
3CT086C	CHN	5A, 200V, 0.005-0.07A, 3.5V	B-89			
3CT086D	CHN	5A, 300V, 0.005-0.07A, 3.5V	B-89			
3CT086E	CHN	5A, 400V, 0.005-0.07A, 3.5V	B-89			
3CT086F	CHN	5A, 500V, 0.005-0.07A, 3.5V	B-89			
3CT086G	CHN	5A, 600V, 0.005-0.07A, 3.5V	B-89			
3CT086H	CHN	5A, 700V, 0.005-0.07A, 3.5V	B-89			
3CT100A	CHN	100A, 925V				 图 D-9
3CT101	CHN	1A, 775V				
3CT101A	CHN	1A, 50V, 0.003-0.03A, 2.5V	D-9			
3CT101B	CHN	1A, 100V, 0.003-0.03A, 2.5V	D-9			
3CT101C	CHN	1A, 200V, 0.003-0.03A, 2.5V	D-9			
3CT101D	CHN	1A, 300V, 0.003-0.03A, 2.5V	D-9			
3CT101E	CHN	1A, 400V, 0.003-0.03A, 2.5V	D-9			
3CT101F	CHN	1A, 500V, 0.003-0.03A, 2.5V	D-9			
3CT101G	CHN	1A, 600V, 0.003-0.03A, 2.5V	D-9			

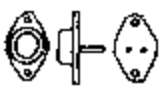

器件型号 Element type	厂名 Manufacturers	材料用途参数 Material Purpose Parameter	图号 Figure	国内外相似替换器件型号 Replace of similar type	备注 Notes	外形参考图 Reference shape
3CT101H	CHN	1A, 700V, 0.003-0.03A, 2.5V	D-9			 图 D-9
3CT101J	CHN	1A, 800V, 0.003-0.03A, 2.5V	D-9			
3CT101K	CHN	1A, 900V, 0.003-0.03A, 2.5V	D-9			
3CT101L	CHN	1A, 1kV, 0.003-0.03A, 2.5V	D-9			
3CT101M	CHN	1A, 1.2kV, 0.003-0.03A, 2.5V	D-9			
3CT101N	CHN	1A, 1.4kV, 0.003-0.03A, 2.5V	D-9			
3CT102	CHN	2A, 775V				
3CT102A	CHN	3A, 50V, 0.005-0.07A, 3.5V	F-27			
3CT102B	CHN	3A, 100V, 0.005-0.07A, 3.5V	F-27			
3CT102C	CHN	3A, 200V, 0.005-0.07A, 3.5V	F-27			
3CT102D	CHN	3A, 300V, 0.005-0.07A, 3.5V	F-27			
3CT102E	CHN	3A, 400V, 0.005-0.07A, 3.5V	F-27			
3CT102F	CHN	3A, 500V, 0.005-0.07A, 3.5V	F-27			
3CT102G	CHN	3A, 600V, 0.005-0.07A, 3.5V	F-27			
3CT102H	CHN	3A, 700V, 0.005-0.07A, 3.5V	F-27			
3CT102J	CHN	3A, 800V, 0.005-0.07A, 3.5V	F-27			
3CT102K	CHN	3A, 900V, 0.005-0.07A, 3.5V	F-27			
3CT102L	CHN	3A, 1kV, 0.005-0.07A, 3.5V	F-27			
3CT102M	CHN	3A, 1.2kV, 0.005-0.07A, 3.5V	F-27			
3CT102N	CHN	3A, 1.4kV, 0.005-0.07A, 3.5V	F-27			
3CT103	CHN	5A, 775V				 图 F-27
3CT103B	CHN	5A, 100V, 0.005-0.07A, 3.5V	F-27			
3CT103C	CHN	5A, 200V, 0.005-0.07A, 3.5V	F-27			
3CT103D	CHN	5A, 300V, 0.005-0.07A, 3.5V	F-27			
3CT103E	CHN	5A, 400V, 0.005-0.07A, 3.5V	F-27			
3CT103F	CHN	5A, 500V, 0.005-0.07A, 3.5V	F-27			
3CT103G	CHN	5A, 600V, 0.005-0.07A, 3.5V	F-27			
3CT103H	CHN	5A, 700V, 0.005-0.07A, 3.5V	F-27			
3CT103J	CHN	5A, 800V, 0.005-0.07A, 3.5V	F-27			
3CT103K	CHN	5A, 900V, 0.005-0.07A, 3.5V	F-27			

器件型号 Element type	厂名 Manufacturers	材料用途参数 Material Purpose Parameter	图号 Figure	国内外相似替换器件型号 Replace of similar type	备注 Notes	外形参考图 Reference shape
3CT103K	CHN	5A, 900V, 0.005-0.07A, 3.5V	F-27			 图 F-27
3CT103L	CHN	5A, 1kV, 0.005-0.07A, 3.5V	F-27			
3CT103M	CHN	5A, 1.2kV, 0.005-0.07A, 3.5V	F-27			
3CT103N	CHN	5A, 1.4kV, 0.005-0.07A, 3.5V	F-27			
3CT103P	CHN	5A, 1.6kV, 0.005-0.07A, 3.5V	F-27			
3CT104	CHN	10A, 100V				
3CT104B	CHN	10A, 100V, 0.005-0.1A, 3.5V	F 27			
3CT104C	CHN	10A, 200V, 0.005-0.1A, 3.5V	F-27			
3CT104D	CHN	10A, 300V, 0.005-0.1A, 3.5V	F-27			
3CT104E	CHN	10A, 400V, 0.005-0.1A, 3.5V	F-27			
3CT104F	CHN	10A, 500V, 0.005-0.1A, 3.5V	F-27			
3CT104G	CHN	10A, 600V, 0.005-0.1A, 3.5V	F-27			
3CT104H	CHN	10A, 700V, 0.005-0.1A, 3.5V	F-27			
3CT104J	CHN	10A, 800V, 0.005-0.1A, 3.5V	F-27			
3CT104K	CHN	10A, 900V, 0.005-0.1A, 3.5V	F-27			
3CT104L	CHN	10A, 1kV, 0.005-0.1A, 3.5V	F-27			
3CT104M	CHN	10A, 1.2kV, 0.005-0.1A, 3.5V	F-27			
3CT104N	CHN	10A, 1.4kV, 0.005-0.1A, 3.5V	F-27			
3CT104P	CHN	10A, 1.6kV, 0.005-0.1A, 3.5V	F-27			
3CT105	CHN	20A, 115V				
3CT105B	CHN	20A, 100V, 0.005-0.1A, 3.5V	F-27			
3CT105C	CHN	20A, 200V, 0.005-0.1A, 3.5V	F-27			
3CT105D	CHN	20A, 300V, 0.005-0.1A, 3.5V	F-27			
3CT105E	CHN	20A, 400V, 0.005-0.1A, 3.5V	F-27			
3CT105F	CHN	20A, 500V, 0.005-0.1A, 3.5V	F-27			
3CT105G	CHN	20A, 600V, 0.005-0.1A, 3.5V	F-27			
3CT105H	CHN	20A, 700V, 0.005-0.1A, 3.5V	F-27			
3CT105J	CHN	20A, 800V, 0.005-0.1A, 3.5V	F-27			
3CT105K	CHN	20A, 900V, 0.005-0.1A, 3.5V	F-27			

其他

器件型号 Element type	厂名 Manufacturers	材料用途参数 Material Purpose Parameter	图号 Figure	国内外相似替换器件型号 Replace of similar type	备注 Notes	外形参考图 Reference shape
3CT105L	CHN	20A, 1kV, 0.005-0.1A, 3.5V	F-27			
3CT105M	CHN	20A, 1.2kV, 0.005-0.1A, 3.5V	F-27			
3CT105N	CHN	20A, 1.4kV, 0.005-0.1A, 3.5V	F-27			
3CT105P	CHN	20A, 1.6kV, 0.005-0.1A, 3.5V	F-27			
3CT106	CHN	30A, 625V				
3CT106B	CHN	30A, 100V, 0.008-0.15A, 3.5V	E-8			
3CT106C	CHN	30A, 200V, 0.008-0.15A, 3.5V	E-8			
3CT106D	CHN	30A, 300V, 0.008-0.15A, 3.5V	E-8			
3CT106E	CHN	30A, 400V, 0.008-0.15A, 3.5V	E-8			
3CT106F	CHN	30A, 500V, 0.008-0.15A, 3.5V	E-8			
3CT106G	CHN	30A, 600V, 0.008-0.15A, 3.5V	E-8			
3CT106H	CHN	30A, 700V, 0.008-0.15A, 3.5V	E-8			
3CT106J	CHN	30A, 800V, 0.008-0.15A, 3.5V	E-8			
3CT106K	CHN	30A, 900V, 0.008-0.15A, 3.5V	E-8			
3CT106L	CHN	30A, 1kV, 0.008-0.15A, 3.5V	E-8			
3CT106M	CHN	30A, 1.2kV, 0.008-0.15A, 3.5V	E-8			
3CT106N	CHN	30A, 1.4kV, 0.008-0.15A, 3.5V	E-8			
3CT106P	CHN	30A, 1.6kV, 0.008-0.15A, 3.5V	E-8			
3CT107	CHN	50A, 925V				
3CT107B	CHN	50A, 100V, 0.008-0.15A, 3.5V	E-8			
3CT107C	CHN	50A, 200V, 0.008-0.15A, 3.5V	E-8			
3CT107D	CHN	50A, 300V, 0.008-0.15A, 3.5V	E-8			
3CT107E	CHN	50A, 400V, 0.008-0.15A, 3.5V	E-8			
3CT107F	CHN	50A, 500V, 0.008-0.15A, 3.5V	E-8			
3CT107G	CHN	50A, 600V, 0.008-0.15A, 3.5V	E-8			
3CT107H	CHN	50A, 700V, 0.008-0.15A, 3.5V	E-8			
3CT107J	CHN	50A, 800V, 0.008-0.15A, 3.5V	E-8			
3CT107K	CHN	50A, 900V, 0.008-0.15A, 3.5V	E-8			
3CT107L	CHN	50A, 1kV, 0.008-0.15A, 3.5V	E-8			





图 F-27

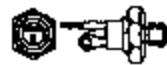

图 E-8

器件型号 Element type	厂名 Manufacturers	材料用途参数 Material Purpose Parameter	图号 Figure	国内外相似替换器件型号 Replace of similar type	备注 Notes	外形参考图 Reference shape
3CT107M	CHN	50A, 1.2KV, 0.008-0.15A, 3.5V E-8				
3CT107N	CHN	50A, 1.4KV, 0.008-0.15A, 3.5V E-8				
3CT107P	CHN	50A, 1.6KV, 0.008-0.15A, 3.5V E 8				
3CT109	CHN	50A, 856V				
3CT111	CHN	3A, 500V				
3CT112	CHN	3A, 600V				
3CT121	CHN	3A, 800V				
3CT123	CHN	5A, 850V				
3CT132	CHN	3A, 500V				
3CT200	CHN	200A, 1.15KV				
3CT200A	CHN	200A, 925V				
3CT205	CHN	20A, 700V				
3CT206	CHN	30A, 700V				
3CT207	CHN	50A, 700V				
3CT208	CHN	100A, 700V				
3CT235	CHN	20A, 600V				
3CT236	CHN	30A, 700V				
3CT237	CHN	50A, 600V				
3CT238	CHN	100A, 550V				
3CT300A	CHN	300A, 1.05KV				
3CT320	CHN	3A, 550V				
3CT400A	CHN	400A, 1.05KV				
3CT500	CHN	500A, 1.15KV				
3CT500A	CHN	500A, 1.025KV				
3CT800A	CHN	800A, 1.025KV				
3CT1000	CHN	1kA, 1.15KV				
3CT1000A	CHN	1kA, 1.025KV				



器件型号 Element type	厂名 Manufacturers	材料 用途 参数 Material Purpose Parameter	图号 Figure	国内外相似替换器件型号 Replace of similar type	备注 Notes	外形参考图 Reference shape
3CTG05A	CHN	0.5A, 100V				
3CTG05B	CHN	0.5A, 200V				
3CTG05C	CHN	0.5A, 300V				
3CTG05D	CHN	0.5A, 400V				
3CTG05E	CHN	0.5A, 500V				
3CTG1A	CHN	1A, 100V				
3CTG1B	CHN	1A, 200V				
3CTG1C	CHN	1A, 300V				
3CTG1D	CHN	1A, 400V				
3CTG1E	CHN	1A, 500V				
3CTG1F	CHN	1A, 600V				
3CTG1G	CHN	1A, 700V				
3CTG1H	CHN	1A, 800V				
3CTG1J	CHN	1A, 900V				
3CTG1K	CHN	1A, 1kV				
3CTG5	CHN	0.5A, 550V				
3CTG5A	CHN	0.5A, 100V				
3CTG5B	CHN	0.5A, 200V				
3CTG5C	CHN	0.5A, 300V				
3CTG5D	CHN	0.5A, 400V				
3CTG5E	CHN	0.5A, 500V				
3CTG5F	CHN	0.5A, 600V				
3CTG5G	CHN	0.5A, 700V				
3CTG5H	CHN	0.5A, 800V				
3CTG5J	CHN	0.5A, 900V				
3CTG5K	CHN	0.5A, 1kV				



器件型号 Element type	厂名 Manufacturers	材料用途参数 Material Purpose Parameter	图号 Figure	国内外相似替换器件型号 Replace of similar type	备注 Notes	外形参考图 Reference shape
3CTG112	CHN	5A, 700V				
3CTG114A	CHN	5A, 800V				
3CTG114B	CHN	5A, 900V				
3CTG114C	CHN	5A, 1kV				
3CTK3A	CHN	3A, 100V				
3CTK3B	CHN	3A, 200V				
3CTK3C	CHN	3A, 300V				
3CTK3D	CHN	3A, 400V				
3CTK3E	CHN	3A, 500V				
3CTK3F	CHN	3A, 600V				
3CTK3G	CHN	3A, 700V				
3CTK3H	CHN	3A, 800V				
3CTK5A	CHN	5A, 100V				
3CTK5B	CHN	5A, 200V				
3CTK5C	CHN	5A, 300V				
3CTK5D	CHN	5A, 400V				
3CTK5E	CHN	5A, 500V				
3CTK5F	CHN	5A, 600V				
3CTK5G	CHN	5A, 700V				
3CTK5H	CHN	5A, 800V				
3CTK10A	CHN	10A, 100V				
3CTK10B	CHN	10A, 200V				
3CTK10C	CHN	10A, 300V				
3CTK10D	CHN	10A, 400V				
3CTK10E	CHN	10A, 500V				
3CTK10F	CHN	10A, 600V				





器件型号 Element type	厂名 Manufacturers	材料用途参数 Material Purpose Parameter	图号 Figure	国内外相似替换器件型号 Replace of similar type	备注 Notes	外形参考图 Reference shape
3CTK10G	CHN	10A, 700V				
3CTK10H	CHN	10A, 800V				
3CTM5A-H	CHN	0.5A, 450V				
3CTM10A-H	CHN	1A, 450V				
3CTN100	CHN	300V				
3CTN150	CHN	400V				
3CTN300	CHN	300V				
3CTN315	CHN	3V				
3CTN400	CHN	400V				
3CTS1A	CHN	1A, 100V				
3CTS1B	CHN	1A, 300V				
3CTS1C	CHN	1A, 400V				
3CTS1D	CHN	1A, 500V				
3CTS3A	CHN	3A, 100V				
3CTS3B	CHN	3A, 300V				
3CTS3C	CHN	3A, 400V				
3CTS3D	CHN	3A, 500V				
3CTS5A	CHN	5A, 100V				
3CTS5B	CHN	5A, 300V				
3CTS5C	CHN	5A, 400V				
3CTS5D	CHN	5A, 500V				
3DT1K	CHN	0.15A				
3DT2K	CHN	0.15A				

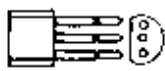

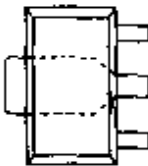
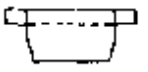
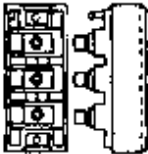

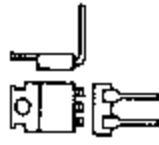

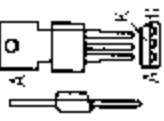
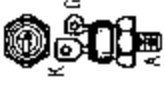
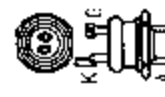















器件型号 Element type	厂名 Manufacturers	材料用途参数 Material Purpose Parameter	图号 Figure	国内外相似替换器件型号 Replace of similar type	备注 Notes	外形参考图 Reference shape
3DT3K	CHN	0.15A				 <p>图 B-36</p>
3DT4K	CHN	0.15A				
3DT5K	CHN	0.15A				
3DT6K	CHN	0.15A				
3DT7K	CHN	0.15A				
3DT8K	CHN	0.15A				
3DT9K	CHN	0.15A				
3DT10K	CHN	0.15A				
3DT11K	CHN	0.15A				
3DT12K	CHN	0.15A				
3DT13K	CHN	0.15A				
3DT14K	CHN	0.15A				
3DT15K	CHN	0.15A				
3DT16K	CHN	0.15A				
3DT17K	CHN	0.15A				
3DT18K	CHN	0.15A				
03P0.5M		50Hz-Thy 0.3A, 50V, 200 μA, 0.005A	B-36	BT149G, TAG59-F, 2N6881, 2N6882, 2N6883, 2N6884, 2N6885		
03P1M		50Hz-Thy 0.3A, 100V, 200 μA, 0.005A	B-36	BT149A, TAG59-A, 2N6881, 2N6882, 2N6883, 2N6884, 2N6885		
03P2J	NEJ	50Hz-Thy 0.3A, 200V, 200 μA, 0.8V	G-4			
03P2M	NEJ	50Hz-Thy 0.3A, 200V, 200 μA, 0.8V	B-36	BT149B, TAG59-B, 2N6882, 2N6883, 2N6884, 2N6885		
03P3M		50Hz-Thy 0.3A, 300V, 200 μA, 0.005A	B-36	BT149D, TAG59-D, 2N6883, 2N6884, 2N6885		
03P4J	NEJ	50Hz-Thy 0.3A, 400V, 200 μA, 0.8V	G-4			
03P4M	NEJ	50Hz Thy 0.3A, 400V, 200 μA, 0.8V	B-36	BT149D, TAG59-D, 2N6883, 2N6884, 2N6885		
03P4MF		0.47A, 500V	B-36			
03P4MG	NEJ	50Hz-Thy 0.3A, 400V, 50 μA, 0.8V	B-36	BT149D, MCR606-6, TAG59-D		



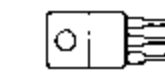

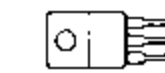

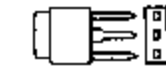

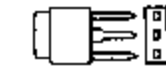

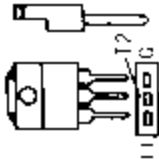
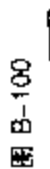
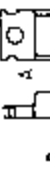
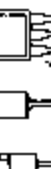
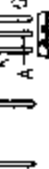
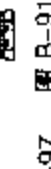
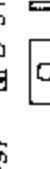
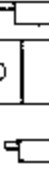

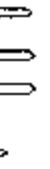

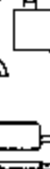
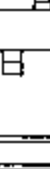



器件型号 Element type	厂名 Manufacturers	材料用途参数 Material Purpose Parameter	图号 Figure	国内外相似替换器件型号 Replace of similar type	备注 Notes	外形参考图 Reference shape
03P4MGC	NEC	50Hz-Thy 0.8A, 400V, 50 μ A	B-36	BT149D, MCR606-6, TAG59-D		
03P5J	NEJ	50Hz-Thy 0.3A, 500V, 200 μ A, 0.8V	G-5	BT149F, TAG59-E, 2N6884, 2N6885		
03P5M	NEJ	50Hz-Thy 0.3A, 500V, 200 μ A, 0.005A	B-36	BT149D, MCR606-6, TAG59-D		
03P5MG	NEJ	50Hz-Thy 0.3A, 400V, 50 μ A, 0.8V	B-36	BT149M, MCR606-7, TAG59-E		
03P5MGC	NEC	50Hz-Thy 0.8A, 500V, 50 μ A, 50 μ A	B-36			
03P6MG		50Hz Thy 0.47A, 600V	B-36			
3L1015	UNI	0.35A, 15V, 5 μ A, 0.55V	B-65			
3L1030	UNI	0.35A, 30V, 5 μ A, 0.55V	B-65	SK3950, SK5400		
3L1060	UNI	0.35A, 60V, 5 μ A, 0.55V	B-65			
3L1100	UNI	0.35A, 100V, 5 μ A, 0.55V	B-65			
3L2015	UNI	0.40A, 15V, 5 μ A, 0.55V	B-65	SK3950, SK5400		
3L2030	UNI	0.40A, 30V, 5 μ A, 0.55V	B-65			
3L2060	UNI	0.40A, 60V, 5 μ A, 0.55V	B-65			
3L2100	UNI	0.40A, 100V, 5 μ A, 0.55V	B-65			
3N81	AMR, ESE	SCS 0.2A, 65V, 1 μ A, 0.65V	B-52			
JAN3N81	NON	SCS 0.2A, 65V, 1 μ A, 0.65V	B-52			
3N82	AMR, GES	SCS 0.2A, 100V, 1 μ A, 0.65V	B-52			
JAN3N82	NON	SCS 0.2A, 100V, 1 μ A, 0.65V	B-52			
3N83	AMR, GES	SCS 0.05A, 70V, 150 μ A, 0.8V	B-52			
3N84	GES, SPE	SCS 0.175A, 40V, 10 μ A, 0.65V	B-52			
3N85	AMR, GES	SCS 0.175A, 100V, 10 μ A, 0.65V	B-52			
3N86	GES, SWT	SCS 0.2A, 65V, 1 μ A, 0.65V	B-52			
JAN3N86	NON	SCS 0.2A, 65V, 1 μ A, 0.65V	B-52			
3N222	INF, WES	SCA 1.2kA, 2.6kV, 0.2A, 3V	H-13			



器件型号 Element type	厂名 Manufacturers	材料用途参数 Material Purpose Parameter	图号 Figure	国内外相似替换器件型号 Replace of similar type	备注 Notes	外形参考图 Reference shape
3P1M		50Hz-Thy 3A, 100V, 0.005A	B-19	TAG621-100, TAG622-100, X0609B, X0609BE		 图 B-19
3P1MH	NEC	50Hz-Thy 3A, 100V, 200 μA, 0.8V	B-19	TAG108-A, TAG623-100, TAG628-100		
3P2M	NEC	50Hz-Thy 3A, 200V, 0.005A, 1.5V	B-19	TAG621-200, TAG622-200, X0609B, X0609BE		
3P2MH	NEC	50Hz-Thy 3A, 200V, 200 μA, 0.8V	B-19	TAG108-B, TAG623-200, TAG628-200		
3P4J		50Hz-Thy 4.7A, 400V	B-94			
3P4J-Z		50Hz-Thy 3A, 400V	B-94			
3P4M	NEC	50Hz-Thy 3A, 400V, 0.005A, 1.5V	B-87	TAG621-400, TAG622-400, X0609DE, X0609DF		
3P4MH	NEC, NEJ	50Hz-Thy 3A, 400V, 200 μA, 0.8V	B-87	TAG108-D, TAG623-400, TAG628-400		 图 B-94
3P5M	NEC	50Hz-Thy 3A, 500V, 0.005A, 1.5V	B-87	TAG621-500, TAG622-500, X0609ME, X0609MF		 图 B-87
3P5MH		50Hz-Thy 4.7A, 500V	B-19	TAG108-M, TAG623-500, TAG628-500		
3P6M	NEC	3A, 600V, 0.005A, 1.5V	B-19			
3P6MH	NEC	50Hz-Thy 3A, 600V, 200 μA, 0.8V	B-19	TAG108-M, TAG623-600, TAG628-500		
3RC5	CEI	4.7A, 50V, 0.016A, 2.1V	F-47	ECC5470		
3S4M	NEJ	SCR-H 1.11A, 400V, 0.03A, 2V	B-87	TAG650S-400, TAG655S-400, CSF11-04er1, CSF11-06ep1, CSF11-06et1		 图 F-47
3S93M		SCR-H 3A, 300V	B-9			
3S94M		SCR-H 3A, 400V	B-9			
3SS3M		SCR-H 3A, 300V, 0.03A	B-98	CSF11-04er1, CSF11-06ep1, CSF11-06et1, TAG650S-300, TAG655S-300		 图 F-21
3SS4M		SCR-H 3A, 400V, 0.03A	B-98	CSF11-04er1, CSF11-06ep1, CSF11-06et1, TAG650S-400, TAG655S-400		
3TCRE	SAR	4.2A, 200V, 0.05A, 3V	F-21			
3TCRF	SAR	4.2A, 250V, 0.05A, 3V	F-21			



器件型号 Element type	厂名 Manufacturers	材料用途参数 Material Purpose Parameter	图号 Figure	国内外相似替换器件型号 Replace of similar type	备注 Notes	外形参考图 Reference shape
3TCRG	SAR	4.2A, 300V, 0.05A, 3V	F-21			
3TCRH	SAR	4.2A, 400V, 0.05A, 3V	F-21			
3TCRJ	SAR	3A, 600V, 0.03A, 2.5V	F-47			
3TCRK	SAR	3A, 700V, 0.03A, 2.5V	F-47			
3TCRL	SAR	3A, 800V, 0.03A, 2.5V	F-47			
4E20-8, 28	APD	1A, 12V, 16V, 1.2V	A-1			
4E20M28	APD, MDC	0.25A, 10V, 16V, 1.2V	A-1			
4E30-8, 28	APD	1A, 18V, 36V, 1.2V	A-1			
4E30M8, 28	APD, MDC	0.25A, 15V, 26V, 1.2V	A-1			
4E40-8, 28	APD, MDC	1A, 24V, 36V, 1.2V	A-1			
4E40M8, 28	APD, MDC	0.25A, 20V, 36V, 1.2V	A-1			
4E50-8, 28	APD, MDC	1A, 30V, 46V, 1.2V	A-1			
4E60-8, 28	MDC	0.15A, 48V, 72V, 1.4V	A-1			
4E100-8, 28	MDC	1A, 60V, 90V, 1.4V	A-1			
4E100M8, 28	MDC	0.15A, 50V, 90V, 1.2V	A-1			
5P01M		5A, 100V	B-9	T3.5N400, TAG661-100, TAG662-100		
5P1M		50Hz-Thy 5A, 100V, 0.015A, 0.01A	B-11			
5P02M		5A, 200V	B-9	ECG5463, SK3572, SK5463, T3.5N400, TAG661-200, TAG662-200		
5P2M	NEC	50Hz-Thy 5A, 200V, 0.01A, 1.5V	B-91			
5P4J		50Hz-Thy 8A, 400V, 200μA, 0.001A	B-94			
5P04M		5A, 400V	B-9			
5P4M	NEC, NEJ	50Hz-Thy 5A, 400V, 0.01A, 1.5V	B-91	ECG5465, SK3587, SK5465, T3.5N400, TAG661-400, TAG662-400		
5P4SM		8A, 400V	B-104			

器件型号 Element type	厂名 Manufacturers	材料用途参数 Material Purpose Parameter	图号 Figure	国内外相似替换器件型号 Replace of similar type	备注 Notes	外形参考图 Reference shape
5P4FMA		5A, 400V	B-100			
5P4Z		50Hz-Thy 5A, 400V, 200μA	B-97			
5P05M	NEC, NEJ	50Hz-Thy 5A, 50V, 0.01A, 1.5V	B-91	TAG661-100, TAG662-100		
5P5M	NEC, NEJ	50Hz-Thy 5A, 500V, 0.01A, 1.5V	B-91	T3,5N500, TAG661-500, TAG662-500		
5P6J		50Hz-Thy 8A, 600V, 200μA	B-94			
5P06M		5A, 600V, 0.015A	B-9			
5P6M	NEC, NEJ	50Hz-Thy 5A, 600V, 0.01A, 1.5V	B-91	T3,5N600, TAG661-600, TAG662-600		
5P6SM		8A, 600V	B-104			
5P6SMA		5A, 600V	B-100			
5P6Z		50Hz-Thy 5A, 600V	B-97			
5R		0.51A, 30V	G-2	MMBS5060		
5S		0.51A, 600V	G-2	MMBS5061		
5S4M		SCR-H 5A, 400V, 0.05A	B-9	BT151, BT500, TAG655S-400, TAG656S-400		
5TB2	HIN	7.5A, 200V, 0.04A	F-50			
5TB3	HIN	7.5A, 300V, 0.04A	F-50			
5TB4	HIN	7.5A, 400V, 0.04A	F-50			
5TB5	HIN	7.5A, 500V, 0.04A	F-50			
5TB6	HIN	7.5A, 600V, 0.04A	F-50			
5TB7	HIN	7.5A, 700V, 0.04A	F-50			
5TB8	HIN	7.5A, 800V, 0.04A	F-50			
5TCRA	SAR	7A, 25V, 0.05A, 3V	F-21	ECG5481		
5TCRB	SAR	7A, 50V, 0.05A, 3V	F-21	ECG5470		
5TCRC	SAR	7A, 100V, 0.05A, 3V	F-21	ECG5471		
5TCRD	SAR	7A, 150V, 0.05A, 3V	F-21			
5TCRE	SAR	7A, 200V, 0.05A, 3V	F-21	ECG5472		
5TCRF	SAR	7A, 250V, 0.05A, 3V	F-21			



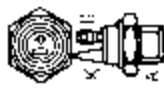
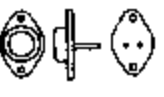

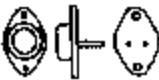



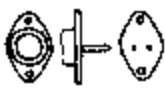
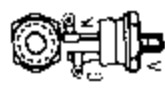

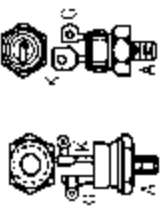



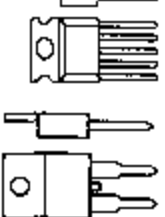





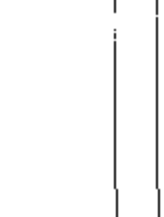
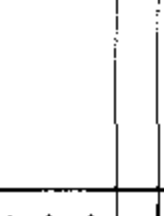

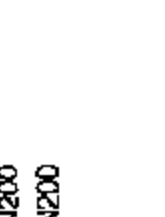
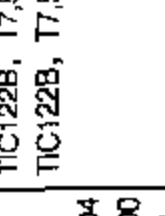
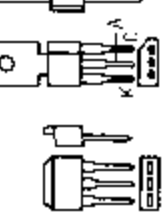

器件型号 Element type	厂名 Manufacturers	材料用途参数 Material Purpose Parameter	图号 Figure	国内外相似替换器件型号 Replace of similar type	备注 Notes	外形参考图 Reference shape
5TCRG	SAR	7A, 300V, 0.05A, 3V	F-21	ECG5474		
5TCRH	SAR	7A, 400V, 0.05A, 3V	F-21	ECG5474		
5TCRI	SAR	7A, 500V, 0.05A, 3V	F-21	ECG5476		
5TCRJ	SAR	4.7A, 600V, 0.05A, 2.5V	F-47	ECG5476		
5TCRK	SAR	4.7A, 700V, 0.05A, 2.5V	F-47			
5TCRL	SAR	4.7A, 800V, 0.05A, 2.5V	F-47			
6AC3F	SCR-D	6A, 300V	C-88			
6AC3S	SCR-D	6A, 300V	F-23			
6AC5F	SCR-D	6A, 500V	C-88			
6AC5S	SCR-D	6A, 500V	F-23			
6AC6F	SCR-D	6A, 600V	C-88			
6AC6S	SCR-D	6A, 600V	F-23			
6S010	HUT	10A, 50V, 0.025A, 1.5V	D-9	S0510L		
6S020	HUT	20A, 50V, 0.025A, 1.5V	D-9	S0520L		
6S110	HUT	10A, 100V, 0.025A, 1.5V	D-9	S1010L, TAG676-100		
6S120	HUT	20A, 100V, 0.025A, 1.5V	D-9	S1020L, TAG676-200		
6S210	HUT	10A, 200V, 0.025A, 1.5V	D-9	S2010L		
6S220	HUT	20A, 200V, 0.025A, 1.5V	D-9	S2020L		
6S310	HUT	10A, 300V, 0.025A, 1.5V	D-9	S3010L, TAG676-300		
6S320	HUT	20A, 300V, 0.025A, 1.5V	D-9	S3020L		
6S410	HUT	10A, 400V, 0.025A, 1.5V	D-9	S4010L		
6S420	HUT	20A, 400V, 0.025A, 1.5V	D-9	S4020L		
6S510	HUT	10A, 500V, 0.025A, 1.5V	D-9	S5010L		
6S520	HUT	20A, 500V, 0.025A, 1.5V	D-9	S5020L		
6S610	HUT	10A, 600V, 0.025A, 1.5V	D-9	S6010L		
6S620	HUT	20A, 600V, 0.025A, 1.5V	D-9	S6020L		

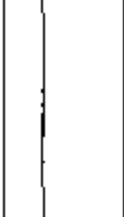
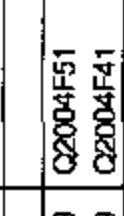

器件型号 Element type	厂名 Manufacturers	材料用途参数 Material Purpose Parameter	图号 Figure	国内外相似替换器件型号 Replace of similar type	备注 Notes	外形参考图 Reference shape
6T010, A	HUT	10A, 50V, 0.05A, 2.5V	D-9	Q2015B		 图 D-9
6T010B, C	HUT	10A, 50V, 0.1A, 2.5V	D-9	Q2015B		
6T010HA, HX	HUT	10A, 50V, 0.025A, 2.5V	D-9	Q2015B		
6T015, A	HUT	15A, 50V, 0.05A, 2.5V	D-9			
6T015B, C	HUT	15A, 50V, 0.1A, 2.5V	D-9			
6T015HA, HX	HUT	15A, 50V, 0.025A, 2.5V	D-9			
6T110, A	HUT	10A, 100V, 0.05A, 2.5V	D-9	Q2015B, TAG265-200		
6T110B, C	HUT	10A, 100V, 0.1A, 2.5V	D-9	Q2015B		
6T110HA, HX	HUT	10A, 100V, 0.025A, 2.5V	D-9	Q2015B		
6T115, A	HUT	15A, 100V, 0.05A, 2.5V	D-9			
6T115B, C	HUT	15A, 100V, 0.1A, 2.5V	D-9			
6T115HA, HX	HUT	15A, 100V, 0.025A, 2.5V	D-9			
6T210, A	HUT	10A, 200V, 0.05A, 2.5V	D-9	Q2015B, TAG265-200		
6T210B	HUT	10A, 200V, 0.1A, 2.5V	D-9	Q2015B		
6T210C	HUT	10A, 200V, 0.15A, 2.5V	D-9	Q2015B		
6T210HA, HX	HUT	10A, 200V, 0.025A, 2.5V	D-9	Q2015B		
6T215, A	HUT	15A, 200V, 0.05A, 2.5V	D-9			
6T215B	HUT	15A, 200V, 0.1A, 2.5V	D-9			
6T215C	HUT	15A, 200V, 0.15A, 2.5V	D-9			
6T215HA, HX	HUT	15A, 200V, 0.025A, 2.5V	D-9			
6T310, A	HUT	10A, 300V, 0.05A, 2.5V	D-9	Q2015B, TAG265-300		
6T310B	HUT	10A, 300V, 0.1A, 2.5V	D-9	Q2015B		
6T310C	HUT	10A, 300V, 0.15A, 2.5V	D-9	Q2015B		
6T310HA, HX	HUT	10A, 300V, 0.025A, 2.5V	D-9	Q2015B		
6T315, A	HUT	15A, 300V, 0.05A, 2.5V	D-9			
6T315B	HUT	15A, 300V, 0.1A, 2.5V	D-9			
6T315C	HUT	15A, 300V, 0.15A, 2.5V	D-9			
6T315HA, HX	HUT	15A, 300V, 0.025A, 2.5V	D-9			



器件型号 Element type	厂名 Manufacturers	材料用途参数 Material Purpose Parameter	图号 Figure	国内外相似替换器件型号 Replace of similar type	备注 Notes	外形参考图 Reference shape	
6T410, A	HUT	10A, 400V, 0.05A, 2.5V	D-9	Q4015B, TAG265-400		 图 D-9	
6T410B	HUT	10A, 400V, 0.1A, 2.5V	D-9	Q4015B			
6T410C	HUT	10A, 400V, 0.15A, 2.5V	D-9	Q4015B			
6T410HA, HX	HUT	10A, 400V, 0.025A, 2.5V	D-9	Q4015B			
6T415, A	HUT	15A, 400V, 0.05A, 2.5V	D-9				
6T415B	HUT	15A, 400V, 0.1A, 2.5V	D-9				
6T415C	HUT	15A, 400V, 0.15A, 2.5V	D-9				
6T415HA, HX	HUT	15A, 400V, 0.025A, 2.5V	D-9				
6T510, A	HUT	10A, 500V, 0.05A, 2.5V	D-9	Q5015B, TAG265-500			
6T510B	HUT	10A, 500V, 0.1A, 2.5V	D-9	Q5015B			
6T510C	HUT	10A, 500V, 0.15A, 2.5V	D-9	Q5015B			
6T510HA, HX	HUT	10A, 500V, 0.025A, 2.5V	D-9	Q5015B			
6T515, A	HUT	15A, 500V, 0.05A, 2.5V	D-9				
6T515B	HUT	15A, 500V, 0.1A, 2.5V	D-9				
6T515C	HUT	15A, 500V, 0.15A, 2.5V	D-9				
6T515HA, HX	HUT	15A, 500V, 0.025A, 2.5V	D-9				
6T610, A	HUT	10A, 600V, 0.05A, 2.5V	D-9	Q6015B, TAG265-600			 图 F-50
6T610B	HUT	10A, 600V, 0.1A, 2.5V	D-9	Q6015B			
6T610C	HUT	10A, 600V, 0.15A, 2.5V	D-9	Q6015B			
6T610HA, HX	HUT	10A, 600V, 0.025A, 2.5V	D-9	Q6015B			
6T615, A	HUT	15A, 600V, 0.05A, 2.5V	D-9				
6T615B	HUT	15A, 600V, 0.1A, 2.5V	D-9				
6T615C	HUT	15A, 600V, 0.15A, 2.5V	D-9				
6T615HA, HX	HUT	15A, 600V, 0.025A, 2.5V	D-9				
7TB1	HIN	12A, 100V, 0.04A	F-50				
7TB2	HIN	12A, 200V, 0.04A	F-50				
7TB3	HIN	12A, 300V, 0.04A	F-50				
7TB4	HIN	12A, 400V, 0.04A	F-50				



器件型号 Element type	厂名 Manufacturers	材料用途参数 Material Purpose Parameter	图号 Figure	国内外相似替换器件型号 Replace of similar type	备注 Notes	外形参考图 Reference shape
7TB5	HIN	12A, 500V, 0.04A	F-50			
7TB6	HIN	12A, 600V, 0.04A	F-50			
7TB7	HIN	12A, 700V, 0.04A	F-50			
7TB8	HIN	12A, 800V, 0.04A	F-50			
7TCRA	SAR	7A, 25V, 0.03A, 2.5V	F-47			
7TCRB	SAR	7A, 50V, 0.03A, 2.5V	F-47			
7TCRC	SAR	7A, 100V, 0.03A, 2.5V	F-47			
7TCRD	SAR	7A, 180V, 0.03A, 2.5V	F-47			
7TCRE	SAR	7A, 200V, 0.03A, 2.5V	F-47			
7TCRF	SAR	7A, 250V, 0.03A, 2.5V	F-47			
7TCRG	SAR	7A, 300V, 0.03A, 2.5V	F-47			
7TCRH	SAR	7A, 400V, 0.03A, 2.5V	F-47			
7TCRI	SAR	7A, 500V, 0.03A, 2.5V	F-47			
7TCRJ	SAR	7A, 600V, 0.03A, 2.5V	F-47			
7TCRK	SAR	7A, 700V, 0.03A, 2.5V	F-47			
7TCRL	SAR	7A, 800V, 0.03A, 2.5V	F-47			
8P1M		50Hz-Thy 80A, 200V, 0.015A	B-9	TIC122B, T7,5N200		
8P2M	NEC, NEJ	50Hz-Thy 5A, 200V, 0.01A, 1.5V	B-9	TIC122B, T7,5N200		
8P2SM		12A, 200V	B-104			
8P2SMA		8A, 200V	B-100			
8P4J		50Hz-Thy 12.6A, 400V, 0.01A	B-94			
8P4M		12A, 400V	B-9			
8P4SM		12A, 400V	B-104			
8P4SMA		8A, 400V	B-100			
8P4Z		50Hz-Thy 8A, 400V, 0.01A	B-97			
8T04A	HUT	4A, 50V, 0.05A, 2.2V	B-89	Q2004F51		
8T04HA	HUT	4A, 50V, 0.025A, 2.2V	B-89	Q2004F41		



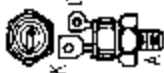
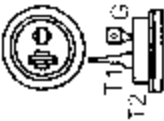
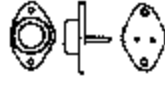



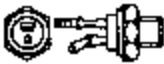
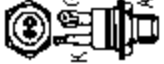
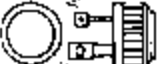

器件型号 Element type	厂名 Manufacturers	材料用途参数 Material Purpose Parameter	图号 Figure	国内外相似替换器件型号 Replace of similar type	备注 Notes	外形参考图 Reference shape	
8T14A	HUT	4A, 100V, 0.05A, 2.2V	B-89	ECG5629, Q2004F51		 图 B-89	
8T14HA	HUT	4A, 100V, 0.025A, 2.2V	B-89	ECG5629, Q2004F41			
8T24A	HUT	4A, 200V, 0.05A, 2.2V	B-89	ECG5629, Q2004F51			
8T24HA	HUT	4A, 200V, 0.025A, 2.2V	R-89	ECG5629, Q2004F41			
8T34A	HUT	4A, 300V, 0.05A, 2.2V	B-89	ECG5629, Q4004F51			
8T34HA	HUT	4A, 300V, 0.025A, 2.2V	B-89	ECG5629, Q4004F41			
8T44A	HUT	4A, 400V, 0.05A, 2.2V	B-89	ECG5629, Q4004F51			
8T44HA	HUT	4A, 400V, 0.025A, 2.2V	B-89	ECG5629, Q4004F41			
8T54A	HUT	4A, 500V, 0.05A, 2.2V	B-89				
8T54HA	HUT	4A, 500V, 0.025A, 2.2V	B-89				
8T64A	HUT	4A, 600V, 0.05A, 2.2V	B-89				
8T64HA	HUT	4A, 600V, 0.025A, 2.2V	B-89				
9CR12U02G	AEI	12A, 200V, 0.1A, 3V	F-21				 图 F-21
9CR12U04G	AEI	12A, 400V, 0.1A, 3V	F-21				
9CR12U06G	AEI	12A, 600V, 0.1A, 3V	F-21				
9CR12U08G	AEI	12A, 800V, 0.1A, 3V	F-21				
9CR12U10G	AEI	12A, 1kV, 0.1A, 3V	F-21				
9CR12U12G	AEI	12A, 1.2kV, 0.1A, 3V	F-21				
9CR20U02G	AEI	20A, 200V, 0.1A, 3V	F-21				
9CR20U04G	AEI	20A, 400V, 0.1A, 3V	F-21				
9CR20U06G	AEI	20A, 600V, 0.1A, 3V	F-21				
9CR20U08G	AEI	20A, 800V, 0.1A, 3V	F-21				
9CR20U10G	AEI	20A, 1kV, 0.1A, 3V	F-21				
9CR20U11G	AEI	20A, 1.1kV, 0.1A, 3V	F-21				
9CR30U02G	AEI	40A, 200V, 0.15A, 3V	E-22			 图 E-22	
9CR30U04G	AEI	40A, 400V, 0.15A, 3V	E-22				
9CR30U06G	AEI	40A, 600V, 0.15A, 3V	E-22				
9CR30U08G	AEI	40A, 800V, 0.15A, 3V	E-22				

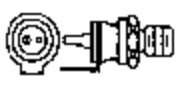

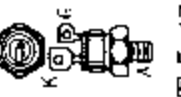
器件型号 Element type	厂名 Manufacturers	材料用途参数 Material Purpose Parameter	图号 Figure	国内外相似替换器件型号 Replace of similar type	备注 Notes	外形参考图 Reference shape
9XT107	AEI	8A, 25V, 0.06A, 2.5V	F-47			 图 F-47
10AC3F		10A, 300V	C-88			 图 C-88
10AC3S		10A, 300V	F-23			
10AC5F		10A, 500V	C-88			
10AC5S		10A, 500V	F-23			
10AC6F		10A, 600V	C-88			
10AC6S		10A, 600V	F-23			
10FCRA	SAR	10A, 25V, 0.04A, 3V				
10FCRB	SAR	10A, 50V, 0.04A, 3V	D-9			 图 D-9
10FCRC	SAR	10A, 100V, 0.04A, 3V	D-9			
10FCRD	SAR	10A, 150V, 0.04A, 3V	D-9			
10FCRE	SAR	10A, 200V, 0.04A, 3V	D-9			
10FCRF	SAR	10A, 250V, 0.04A, 3V	D-9			
10FCRG	SAR	10A, 300V, 0.04A, 3V	D-9			
10FCRH	SAR	10A, 400V, 0.04A, 3V	D-9			
10FCRI	SAR	10A, 500V, 0.04A, 3V	D-9			
10FCRJ	SAR	10A, 600V, 0.04A, 3V	D-9			
10FCRK	SAR	10A, 700V, 0.04A, 3V	D-9			
10FCRL	SAR	10A, 800V, 0.04A, 3V	D-9			
10P1S		11A, 100V	F-22			
10P1SG	NEJ	17A, 100V, 0.04A, 3V	F-31			
10P2S		11A, 200V	F-22			
10P2SG	NEJ	17A, 200V, 0.04A, 3V	F-31			
10P3S		11A, 300V	F-22			
10P3SG	NEJ	17A, 300V, 0.04A, 3V	F-31			
10P4S		11A, 400V	F-22			







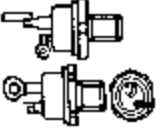

器件型号 Element type	厂名 Manufacturers	材料用途参数 Material Purpose Parameter	图号 Figure	国内外相似替换器件型号 Replace of similar type	备注 Notes	外形参考图 Reference shape
10P4SG	NEJ	17A, 400V, 0.04A, 3V	F-31			
10P5S		11A, 500V	F-22			
10P5SG	NEJ	17A, 500V, 0.04A, 3V	F-31			
10P6S		11A, 600V	F-22			
10P6SG	NEJ	17A, 600V, 0.04A, 3V	F-31			
10P8S		11A, 800V	F-22			
10P8SG	NEJ	17A, 800V, 0.04A, 3V	F-31			
10P10SG	NEJ	17A, 1kV, 0.04A, 3V	F-31			
10P12S		11A, 1.2kV	F-22			
10PCRA	SAR	10A, 25V, 0.04A, 3V	C-85			
10PCRB	SAR	10A, 50V, 0.04A, 3V	C-85			
10PCRC	SAR	10A, 100V, 0.04A, 3V	C-85			
10PCRD	SAR	10A, 150V, 0.04A, 3V	C-85			
10PCRE	SAR	10A, 200V, 0.04A, 3V	C-85			
10PCRF	SAR	10A, 250V, 0.04A, 3V	C-85			
10PCRG	SAR	10A, 300V, 0.04A, 3V	C-85			
10PCRH	SAR	10A, 400V, 0.04A, 3V	C-85			
10PCRI	SAR	10A, 500V, 0.04A, 3V	C-85			
10PCRJ	SAH	10A, 600V, 0.04A, 3V	C-85			
10PCRK	SAR	10A, 700V, 0.04A, 3V	C-85			
10PCRL	SAR	10A, 800V, 0.04A, 3V	C-85			
10PCRNA	SAR	10A, 25V, 0.04A, 3V	F-100			
10PCRNB	SAR	10A, 50V, 0.04A, 3V	F-100			
10PCRNC	SAR	10A, 100V, 0.04A, 3V	F-100			
10PCRND	SAR	10A, 150V, 0.04A, 3V	F-100			
10PCRNE	SAR	10A, 200V, 0.04A, 3V	F-100			
10PCRNF	SAR	10A, 250V, 0.04A, 3V	F-100			
10PCRNG	SAR	10A, 300V, 0.04A, 3V	F-100			
10PCRNH	SAR	10A, 400V, 0.04A, 3V	F-100			

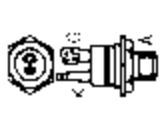
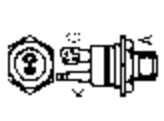
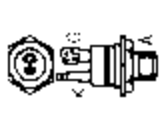
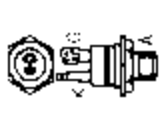
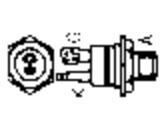
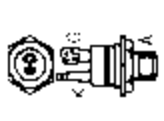
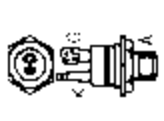
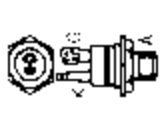
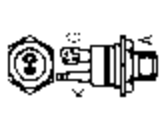
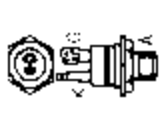

器件型号 Element type	厂名 Manufacturers	材料用途参数 Material Purpose Parameter	图号 Figure	国内外相似替换器型号 Replace of similar type	备注 Notes	外形参考图 Reference shape
10PCRNI	SAR	10A, 500V, 0.04A, 3V	F-100			
10PCRNIJ	SAR	10A, 600V, 0.04A, 3V	F-100			图 F-100
10PCRINK	SAR	10A, 700V, 0.04A, 3V	F-100			
10PCRNL	SAR	10A, 800V, 0.04A, 3V	F-100			图 F-21
10PCRSA	SAR	10A, 25V, 0.04A, 3V	F-21			
10PCRSB	SAR	10A, 50V, 0.04A, 3V	F-21			图 F-47
10PCRSC	SAR	10A, 100V, 0.04A, 3V	F-21			
10PCRSDD	SAR	10A, 150V, 0.04A, 3V	F-21			图 F-48
10PCRSE	SAR	10A, 200V, 0.04A, 3V	F-21			
10PCRSF	SAR	10A, 250V, 0.04A, 3V	F-21			图 F-23
10PCRSG	SAR	10A, 300V, 0.04A, 3V	F-21			
10PCRSH	SAR	10A, 400V, 0.04A, 3V	F-21			图 F-48
10PCRSI	SAR	10A, 500V, 0.04A, 3V	F-21			
10PCRSJ	SAR	10A, 600V, 0.04A, 3V	F-21			图 F-23
10PCRSK	SAR	10A, 700V, 0.04A, 3V	F-21			
10PCRSL	SAR	10A, 800V, 0.04A, 3V	F-21			图 F-48
10R1A10		16A, 100V	F 47	2N1844		
10R1A20		16A, 200V	F-47	2N1846		
10R1A40		16A, 400V	F-47	2N1849		
10R1A60		20A, 600V	F-47	2N5171		
10R1A80		25A, 800V	F-47	2N692		
10R1A100		25A, 1kV				
10R1A120		25A, 1.2kV				
10RIA10	INR	8.5A, 100V, 0.04A, 2V	F-48			
10RIA10M	INR	25A, 100V, 0.04A, 2V	F-23			
10RIA20	INR, INJ	8.5A, 200V, 0.04A, 2V	F-48			
10RIA20M	INR	25A, 200V, 0.04A, 2V	F-23			
10RIA40	INR, INJ	8.5A, 400V, 0.04A, 2V	F-48			



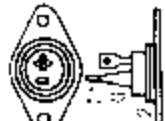
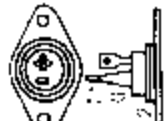
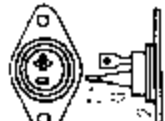
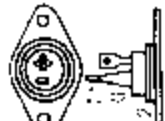
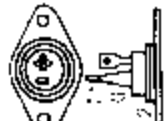
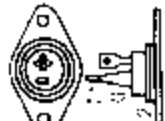
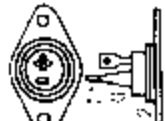
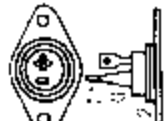
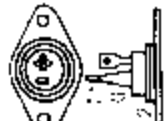
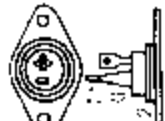

器件型号 Element type	厂名 Manufacturers	材料用途参数 Material Purpose Parameter	图号 Figure	国内外相似替换器件型号 Replace of similar type	备注 Notes	外形参考图 Reference shape	
10RIA40M	INR	25A, 400V, 0.04A, 2V	F-23			 图 F-23	
10RIA60	INR, INJ	8.5A, 600V, 0.04A, 2V	F-48				
10RIA60M	INR	25A, 600V, 0.04A, 2V	F-23				
10RIA80	INR, INJ	8.5A, 800V, 0.04A, 2V	F-48				
10RIA80M	INR	25A, 800V, 0.04A, 2V	F-23				
10RIA100	INR, INJ	8.5A, 1kV, 0.04A, 2V	F-48				
10RIA100M	INR	25A, 1kV, 0.04A, 2V	F-23				
10RIA110	INR, INJ	8.5A, 1.1kV, 0.04A, 2V	F-48				
10RIA110M	INR	25A, 1.1kV, 0.04A, 2V	F-23				
10RIA120M	INR	25A, 1.2kV, 0.04A, 2V	F-23				
10S2SC	SCR-H	8A, 200V	F-23				 图 F-4R
10S3SC	SCR-H	8A, 300V	F-23				
10S4SC	SCR-H	8A, 400V	F-23				
10S5SC	SCR-H	8A, 500V	F-23				
10S6SC	SCR-H	8A, 600V	F-23				
10SS2SC	SCR-H	8A, 200V	F-23				
10SS3SC	SCR-H	8A, 300V	F-23				
10SS4SC	SCR-H	8A, 400V	F-23				
10SS5SC	SCR-H	8A, 500V	F-23				
10SS6SC	SCR-H	8A, 600V	F-23				
10TB1	HIN	15A, 100V, 0.04A	F-50			 图 F-50	
10TB2	HIN	15A, 200V, 0.04A	F-50				
10TB3	HIN	15A, 300V, 0.04A	F-50				
10TB4	HIN	15A, 400V, 0.04A	F-50				
10TB5	HIN	15A, 500V, 0.04A	F-50				
10TB6	HIN	15A, 600V, 0.04A	F-50				
10TB7	HIN	15A, 700V, 0.04A	F-50				



器件型号 Element type	厂名 Manufacturers	材料用途参数 Material Purpose Parameter	图号 Figure	国内外相似替换器件型号 Replace of similar type	备注 Notes	外形参考图 Reference shape
10TB8	HIN	15A, 800V, 0.04A	F-22			
10TO-220S		11A, 1kV				
11RC10	INJ	16A, 100V, 0.04A, 3V	F-15	ECG5522		
11RC20	INJ	16A, 200V, 0.04A, 3V	F-15	ECG5524		
11RC30	INJ	16A, 300V, 0.04A, 3V	F-15	ECG5527		
11RC40	INJ	16A, 400V, 0.04A, 3V	F-15	ECG5527		
11RC50	INJ	16A, 500V, 0.04A, 3V	F-15	ECG5529		
11RC60	INJ	16A, 600V, 0.04A, 3V	F-15	ECG5529		
11RC80	INJ	16A, 800V, 0.04A, 3V	F-15	ECG5529		
11RC100	INJ	16A, 1kV, 0.04A, 3V	F-15	ECG5531		
16AC3D		SCR-D R, 16A, 300V	D-25			
16AC3S		SCR-D R, 16A, 300V	F-23			
16AC5D		SCR-D R, 16A, 500V	D-25			
16AC5S		SCR-D R, 16A, 500V	F-23			
16AC6D		SCR-D R, 16A, 600V	D-25			
16AC6S		SCR-D R, 16A, 600V	F-23			
16ATCRA	SAR	16A, 25V, 0.08A, 3.5V	F-48			
16ATCRB	SAR	16A, 50V, 0.08A, 3.5V	F-48			
16ATCRD	SAR	16A, 150V, 0.08A, 3.5V	F-48			
16ATCRE	SAR	16A, 200V, 0.08A, 3.5V	F-48			
16ATCRF	SAR	16A, 250V, 0.08A, 3.5V	F-48			
16ATCRG	SAR	16A, 300V, 0.08A, 3.5V	F-48			
16ATCRH	SAR	16A, 400V, 0.08A, 3.5V	F-48			
16ATCRI	SAR	16A, 500V, 0.08A, 3.5V	F-48			
16ATCRK	SAR	16A, 700V, 0.08A, 3.5V	F-48			
16ATCRL	SAR	16A, 800V, 0.08A, 3.5V	F-48			



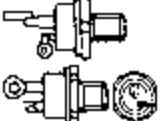

器件型号 Element type	厂名 Manufacturers	材料用途参数 Material Purpose Parameter	图号 Figure	国内外相似替换器件型号 Replace of similar type	备注 Notes	外形参考图 Reference shape	
16FCRA	SAR	16A, 25V, 0.04A, 3V	D-9			 图 D-9	
16FCRB	SAR	16A, 50V, 0.04A, 3V	D-9				
16FCRC	SAR	16A, 100V, 0.04A, 3V	D-9				
16FCRD	SAR	16A, 150V, 0.04A, 3V	D-9				
16FCRE	SAR	16A, 200V, 0.04A, 3V	D-9				
16FCRF	SAR	16A, 250V, 0.04A, 3V	D-9				
16FCRG	SAR	16A, 300V, 0.04A, 3V	D-9				
16FCRH	SAR	16A, 400V, 0.04A, 3V	D-9				
16FCRI	SAR	16A, 500V, 0.04A, 3V	D-9				
16FCRJ	SAR	16A, 600V, 0.04A, 3V	D-9				
16FCRK	SAR	16A, 700V, 0.04A, 3V	D-9				
16FCRL	SAR	16A, 800V, 0.04A, 3V	D-9				
16PCRA	SAR	16A, 25V, 0.04A, 3V	C-85				 图 C-85
16PCRB	SAR	16A, 50V, 0.04A, 3V	C-85				
16PCRC	SAR	16A, 100V, 0.04A, 3V	C-85				
16PCRD	SAR	16A, 150V, 0.04A, 3V	C-85				
16PCRE	SAR	16A, 200V, 0.04A, 3V	C-85				
16PCRF	SAR	16A, 250V, 0.04A, 3V	C-85				
16PCRG	SAR	16A, 300V, 0.04A, 3V	C-85				
16PCRH	SAR	16A, 400V, 0.04A, 3V	C-85				
16PCRI	SAR	16A, 500V, 0.04A, 3V	C-85				
16PCRJ	SAR	16A, 600V, 0.04A, 3V	C-85				
16PCRK	SAR	16A, 700V, 0.04A, 3V	C-85				
16PCRL	SAR	16A, 800V, 0.04A, 3V	C-85				
16PCRNA	SAR	16A, 25V, 0.04A, 3V	F-100			 图 F-100	
16PCRNB	SAR	16A, 50V, 0.04A, 3V	F-100				
16PCRNC	SAR	16A, 100V, 0.04A, 3V	F-100				
16PCRND	SAR	16A, 150V, 0.04A, 3V	F-100				

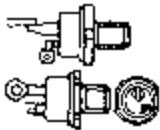

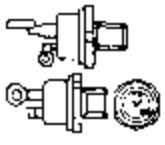

器件型号 Element type	厂名 Manufacturers	材料用途参数 Material Purpose Parameter	图号 Figure	国内外相似替换器件型号 Replace of similar type	备注 Notes	外形参考图 Reference shape	
16PCRNE	SAR	16A, 200V, 0.04A, 3V	F-100			 图 F-100	
16PCRNH	SAR	16A, 250V, 0.04A, 3V	F-100				
16PCRNG	SAR	16A, 300V, 0.04A, 3V	F-100				
16PCRNH	SAR	16A, 400V, 0.04A, 3V	F-100				
16PCRNI	SAR	16A, 500V, 0.04A, 3V	F-100				
16PCRNJ	SAR	16A, 600V, 0.04A, 3V	F-100				
16PCRNK	SAR	16A, 700V, 0.04A, 3V	F-100				
16PCRNLI	SAR	16A, 800V, 0.04A, 3V	F-100				
16PCRSA	SAR	16A, 25V, 0.04A, 3V	F-21				 图 F-21
16PCRSB	SAR	16A, 50V, 0.04A, 3V	F-21				
16PCRSC	SAR	16A, 100V, 0.04A, 3V	F-21				
16PCRSD	SAR	16A, 150V, 0.04A, 3V	F-21				
16PCRSE	SAR	16A, 200V, 0.04A, 3V	F-21				
16PCRSF	SAR	16A, 250V, 0.04A, 3V	F-21				
16PCRSG	SAR	16A, 300V, 0.04A, 3V	F-21				
16PCRSH	SAR	16A, 400V, 0.04A, 3V	F-21				
16PCRSI	SAR	16A, 500V, 0.04A, 3V	F-21				
16PCRSJ	SAR	16A, 600V, 0.04A, 3V	F-21				
16PCRSK	SAR	16A, 700V, 0.04A, 3V	F-21			 图 F-48	
16RC2A	INU, STR	35A, 20V, 0.04A, 2V	F-48	ECG5541, SK5515, SK6615			
16RC5A	STR	35A, 50V, 0.04A, 2V	F-48	ECG5541, S0535H, SK5515, SK6615			
16RC10A	SST, STR	35A, 100V, 0.04A, 2V	F-48	ECG5542, S1035H, SK5515, SK6615			
16RC15A	STR	35A, 150V, 0.04A, 2V	F-48	ECG5543			
16RC20A	SST, STR	35A, 200V, 0.04A, 2V	F-48	ECG5543, S2035H			
16RC25A	STR	35A, 250V, 0.04A, 2V	F-48	ECG5545			
16RC30A	SST, STR	35A, 300V, 0.04A, 2V	F-48	ECG5545, S3035H			
16RC40A	SST, STR	35A, 400V, 0.04A, 2V	F-48	ECG5545, S4035H			



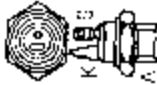

器件型号 Element type	厂名 Manufacturers	材料用途参数 Material Purpose Parameter	图号 Figure	国内外相似替换器件型号 Replace of similar type	备注 Notes	外形参考图 Reference shape
16RC50A	SST, STR	35A, 500V, 0.04A, 2V	F-48	ECG5547, S5035H		 图 F-48
16RC60A	SST, STR	35A, 600V, 0.04A, 2V	F-48	ECG5547, S6035H		
16RC70A	STR	35A, 700V, 0.04A, 2V	F-48			
16RC80A	SST, STR	35A, 800V, 0.04A, 2V	F-48			
16RC90A	STR	35A, 900V, 0.04A, 2V	F-48			
16RC100A	SST, STR	35A, 1kV, 0.04A, 2V	F-48			
16RC110A	STR	35A, 1.1kV, 0.04A, 2V	F-48			
16RC120A	STR	35A, 1.2kV, 0.04A, 2V	F-48			
16RCF5A	STR	35A, 50V, 0.04A, 2V	F-48			
16RCF10A	STR	35A, 100V, 0.04A, 2V	F-48			
16RCF15A	STR	35A, 150V, 0.04A, 2V	F-48			
16RCF20A	STR	35A, 200V, 0.04A, 2V	F-48			
16RCF25A	STR	35A, 250V, 0.04A, 2V	F-48			
16RCF30A	STR	35A, 300V, 0.04A, 2V	F-48			
16RCF40A	STR	35A, 400V, 0.04A, 2V	F-48			
16RCF50A	STR	35A, 500V, 0.04A, 2V	F-48			
16RCF60A	STR	35A, 600V, 0.04A, 2V	F-48			
16RIA10	INR	11.5A, 100V, 0.04A, 2V	F-48			 图 F-23
16RIA10M	INR	35A, 100V, 0.04A, 2V	F-23			
16RIA20	INR, INJ	11.5A, 200V, 0.04A, 2V	F-48			
16RIA20M	INR	35A, 200V, 0.04A, 2V	F-48			
16RIA40	INR, INJ	11.5A, 400V, 0.04A, 2V	F-48			
16RIA40M	INR	35A, 400V, 0.04A, 2V	F-23			
16RIA60	INR, INJ	11.5A, 600V, 0.04A, 2V	F-48			
16RIA60M	INR	35A, 600V, 0.04A, 2V	F-23			
16RIA80	INR, INJ	11.5A, 800V, 0.04A, 2V	F-48			
16RIA80M	INR	35A, 800V, 0.04A, 2V	F-23			
16RIA100	INR, INJ	11.5A, 1kV, 0.04A, 2V	F-48			
16RIA100M	INR	35A, 1kV, 0.04A, 2V	F-23			



器件型号 Element type	厂名 Manufacturers	材料用途参数 Material Purpose Parameter	图号 Figure	国内外相似替换器件型号 Replace of similar type	备注 Notes	外形参考图 Reference shape
16RIA110	INR, INJ	11.5A, 1.1kV, 0.04A, 2V	F-48			 图 F-48
16RIA110M	INR	35A, 1.1kV, 0.04A, 2V	F-23			
16RIA120M	INR	35A, 1.2kV, 0.04A, 2V	F-23			
16TCRA	SAR	16A, 25V, 0.08A, 2.5V	F-48			 图 F-23
16TCRB	SAR	16A, 50V, 0.08A, 2.5V	F-48			
16TCRC	SAR	16A, 100V, 0.08A, 2.5V	F-48			
16TCRD	SAR	16A, 150V, 0.08A, 2.5V	F-48			
16TCRE	SAR	16A, 200V, 0.08A, 2.5V	F-48			
16TCRF	SAR	16A, 250V, 0.08A, 2.5V	F-48			
16TCRG	SAR	16A, 300V, 0.08A, 2.5V	F-48			
16TCRH	SAR	16A, 400V, 0.08A, 2.5V	F-48			
16TCRI	SAR	16A, 500V, 0.08A, 2.5V	F-48			
16TCRJ	SAR	16A, 600V, 0.08A, 2.5V	F-48			
16TCRK	SAR	16A, 700V, 0.08A, 2.5V	F-48			
16TCRL	SAR	16A, 800V, 0.08A, 2.5V	F-48			
17TB1	HIN	25A, 100V, 0.06A	F-21			
17TB2	HIN	25A, 200V, 0.06A	F-21			
17TB3	HIN	25A, 300V, 0.06A	F-21			
17TB4	HIN	25A, 400V, 0.06A	F-21			
17TB5	HIN	25A, 500V, 0.06A	F-21			
17TB6	HIN	25A, 600V, 0.06A	F-21			
17TB7	HIN	25A, 700V, 0.06A	F-21			
17TB8	HIN	25A, 800V, 0.06A	F-21			
20P1SG	NEC	35A, 100V, 0.04A, 3V	F-23	ECG5542		
20P2SG	NEC	35A, 200V, 0.04A, 3V	F-23	ECG5543		
20P3SG	NEC	35A, 300V, 0.04A, 3V	F-23	ECG5545		

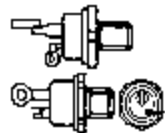
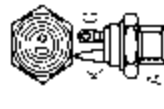



器件型号 Element type	厂名 Manufacturers	材料用途参数 Material Purpose Parameter	图号 Figure	国内外相似替换器件型号 Replace of similar type	备注 Notes	外形参考图 Reference shade
20P4SG	NEC	35A, 400V, 0.04A, 3V	F-23	ECG5545		 图 F-23
20P5SG	NEC	35A, 500V, 0.04A, 3V	F-23	ECG5547		
20P6SG	NEC	35A, 600V, 0.04A, 3V	F-23	ECG5547		
20P8SG	NEC	35A, 800V, 0.04A, 3V	F-31	ECG5548		
20P10SG	NEC	35A, 1kV, 0.04A, 3V	F-31			
20P12SG		19A, 1.2kV				
20S2SC	SCR-H	8A, 200V	F-23			 图 F-31
20S3SC	SCR-H	8A, 300V	F-23			
20S4SC	SCR-H	8A, 400V	F-23			
20S5SC	SCR-H	8A, 500V	F-23			
20S6SC	SCR-H	8A, 600V	F-23			
20S82SC	SCR-H	8A, 200V	F-23			
20S83SC	SCR-H	8A, 300V	F-23			
20S84SC	SCR-H	8A, 400V	F-23			
20S85SC	SCR-H	8A, 500V	F-23			
20S86SC	SCR-H	8A, 600V	F-23			
20TB2	HIN	31A, 200V, 0.06A	F-21			 图 F-21
20TB3	HIN	31A, 300V, 0.06A	F-21			
20TB4	HIN	31A, 400V, 0.06A	F-21			
20TB5	HIN	31A, 500V, 0.06A	F-21			
20TB6	HIN	31A, 600V, 0.06A	F-21			
20TB7	HIN	31A, 700V, 0.06A	F-21			
20TB8	HIN	31A, 800V, 0.06A	F-21			
20TO-220SG		19A, 1kV				
21RC10	INJ	25A, 100V, 0.04A, 3V	F-15	ECG5522, SK5522, SK6622		 图 F-15
21RC20	INJ	25A, 200V, 0.04A, 3V	F-15	ECG5524, SK5524, SK6624		

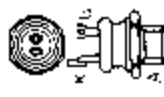

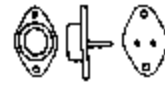
器件型号 Element type	厂名 Manufacturers	材料用途参数 Material Purpose Parameter	图号 Figure	国内外相似替换器件型号 Replace of similar type	备注 Notes	外形参考图 Reference shape
21RC30	INU	25A, 300V, 0.04A, 3V	F-15	ECG5527, SK5527, SK6627		
21RC40	INU	25A, 400V, 0.04A, 3V	F-15	ECG5527, SK5527, SK6627		
21RC50	INU	25A, 500V, 0.04A, 3V	F-15	ECG5529, SK5529, SK6629		
21RC60	INU	25A, 600V, 0.04A, 3V	F-15	ECG5529, SK5529, SK6629		
21RC80	INU	25A, 800V, 0.04A, 3V	F-15	ECG5531, SK5531, SK6622		
21RC100	INU	25A, 1kV, 0.04A, 3V	F-15			
22RIA10	INR	13A, 100V, 0.04A, 2V	F-48	ECG5542		
22RIA10M	INR	35A, 100V, 0.04A, 2V	F-23			
22RIA20	INR, INU	13A, 200V, 0.04A, 2V	F-48	ECG5543		
22RIA20M	INR	35A, 200V, 0.04A, 2V	F-23			
22RIA40	INR, INU	13A, 400V, 0.04A, 2V	F-48			
22RIA40M	INR	35A, 400V, 0.04A, 2V	F-23			
22RIA60	INR, INU	13A, 600V, 0.04A, 2V	F-48			
22RIA60M	INR	35A, 600V, 0.04A, 2V	F-23			
22RIA80	INR, INU	13A, 800V, 0.04A, 2V	F-48	ECG5546		
22RIA80M	INR	35A, 800V, 0.04A, 2V	F-23			
22RIA100	INR, INU	13A, 1kV, 0.04A, 2V	F-48			
22RIA100M	INR	35A, 1kV, 0.04A, 2V	F-23			
22RIA110	INR, INU	13A, 1.1kV, 0.04A, 2V	F-48			
22RIA110M	INR	35A, 1.1kV, 0.04A, 2V	F-23			
22RIA120	INR, INU	13A, 1.2kV, 0.04A, 2V	F-48			
22RIA120M	INR	35A, 1.2kV, 0.04A, 2V	F-23			
22RIA140	INR	35A, 1.4kV	F-48			
22RIA160	INR	35A, 1.6kV	F-48			
23RA5	INU	35A, 50V, 0.04A, 1.5V	F-21			
23RA10	INU	35A, 100V, 0.04A, 1.5V	F-21			
23RA20	INU	35A, 200V, 0.04A, 1.5V	F-21			

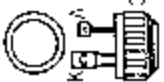



器件型号 Element type	厂名 Manufacturers	材料用途参数 Material Purpose Parameter	图号 Figure	国内外相似替换器件型号 Replace of similar type	备注 Notes	外形参考图 Reference shape
23RA30	INJ	35A, 300V, 0.04A, 1.5V	F-21			 图 F-21
23RA40	INJ	35A, 400V, 0.04A, 1.5V	F-21			
23RA50	INJ	35A, 500V, 0.04A, 1.5V	F-21			
23RA60	INJ	35A, 600V, 0.04A, 1.5V	F-21			
23RA80	INJ	35A, 800V, 0.04A, 1.5V	F-21			
25AC3S	SCR-D	25A, 300V	F-31			 图 F-31
25AC5S	SCR-D	25A, 500V	F-31			
25AC6S	SCR-D	25A, 600V	F-31			
25FCRA	SAR	25A, 25V, 0.04A, 2.5V	D-9			 图 D-9
25FCRB	SAR	25A, 50V, 0.04A, 2.5V	D-9			
25FCRC	SAR	25A, 100V, 0.04A, 2.5V				
25FCRD	SAR	25A, 150V, 0.04A, 2.5V				
25FCRE	SAR	25A, 200V, 0.04A, 2.5V	D-9			
25FCRF	SAR	25A, 250V, 0.04A, 2.5V	D-9			
25FCRG	SAR	25A, 300V, 0.04A, 2.5V	D-9			
25FCRH	SAR	25A, 400V, 0.04A, 2.5V	D-9			
25FCRI	SAR	25A, 500V, 0.04A, 2.5V	D-9			
25FCRJ	SAR	25A, 600V, 0.04A, 2.5V	D-9			
25FCRK	SAR	25A, 700V, 0.04A, 2.5V	D-9			
25FCRL	SAR	25A, 800V, 0.04A, 2.5V	D-9			
25P1SG	SAR	26A, 100V, 0.04A, 3V	F-21			
25P2SG	NEJ	26A, 200V, 0.04A, 3V	F-21			
25P3SG	NEJ	26A, 300V, 0.04A, 3V	F-21			
25P4SG	NEJ	26A, 400V, 0.04A, 3V	F-21			
25P5SG	NEJ	26A, 500V, 0.04A, 3V	F-21			
25P6SG	NEJ	26A, 600V, 0.04A, 3V	F-21			

器件型号 Element type	厂名 Manufacturers	材料用途参数 Material Purpose Parameter	图号 Figure	国内外相似替换器件型号 Replace of similar type	备注 Notes	外形参考图 Reference shape
25P8SG	NEJ	26A, 800V, 0.04A, 3V	F-21			 图 F-21
25P10SG	NEJ	26A, 1kV, 0.04A, 3V	F-21			
25P12SG	NEJ	26A, 1.2kV, 0.04A, 3V	F-21			
25PCRA	SAR	25A, 25V, 0.04A, 2.5V	C-85			 图 C-85
25PCRB	SAR	25A, 50V, 0.04A, 2.5V	C-85			
25PCRC	SAR	25A, 100V, 0.04A, 2.5V	C-85			
25PCRD	SAR	25A, 150V, 0.04A, 2.5V	C-85			
25PCRE	SAR	25A, 200V, 0.04A, 2.5V	C-85			
25PCRF	SAR	25A, 250V, 0.04A, 2.5V	C-85			
25PCRG	SAR	25A, 300V, 0.04A, 2.5V	C-85			
25PCRH	SAR	25A, 400V, 0.04A, 2.5V	C-85			
25PCRI	SAR	25A, 500V, 0.04A, 2.5V	C-85			
25PCRJ	SAR	25A, 600V, 0.04A, 2.5V	C-85			
25PCRK	SAR	25A, 700V, 0.04A, 2.5V	C-85			
25PCRL	SAR	25A, 800V, 0.04A, 2.5V	C-85			
25PCRNA	SAR	25A, 25V, 0.04A, 2.5V	F-100			
25PCRNB	SAR	25A, 50V, 0.04A, 2.5V	F-100			
25PCRNC	SAR	25A, 100V, 0.04A, 2.5V	F-100			
25PCRND	SAR	25A, 150V, 0.04A, 2.5V	F-100			
25PCRNE	SAR	25A, 200V, 0.04A, 2.5V	F-100			
25PCRNF	SAR	25A, 250V, 0.04A, 2.5V	F-100			
25PCRNG	SAR	25A, 300V, 0.04A, 2.5V	F-100			
25PCRNH	SAR	25A, 400V, 0.04A, 2.5V	F-100			
25PCRNI	SAR	25A, 500V, 0.04A, 2.5V	F-100			
25PCRNJ	SAR	25A, 600V, 0.04A, 2.5V	F-100			
25PCRNK	SAR	25A, 700V, 0.04A, 2.5V	F-100			
25PCRNL	SAR	25A, 800V, 0.04A, 2.5V	F-100			
25PCRSA	SAR	25A, 25V, 0.04A, 2.5V	F-21			 图 F-100
25PCRSB	SAR	25A, 50V, 0.04A, 2.5V	F-21			

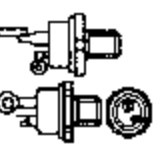

器件型号 Element type	厂名 Manufacturers	材料用途参数 Material Purpose Parameter	图号 Figure	国内外相似替换器件型号 Replace of similar type	备注 Notes	外形参考图 Reference shape
25PCRSK	SAR	25A, 100V, 0.04A, 2.5V	F-21			 图 F-21
25PCRSJ	SAR	25A, 150V, 0.04A, 2.5V	F-21			
25PCRSI	SAR	25A, 200V, 0.04A, 2.5V	F-21			
25PCRSF	SAR	25A, 250V, 0.04A, 2.5V	F-21			
25PCRSR	SAR	25A, 300V, 0.04A, 2.5V	F-21			
25PCRSQ	SAR	25A, 400V, 0.04A, 2.5V	F-21			
25PCRSN	SAR	25A, 500V, 0.04A, 2.5V	F-21			
25PCRSK	SAR	25A, 600V, 0.04A, 2.5V	F-21			
25PCRSJ	SAR	25A, 700V, 0.04A, 2.5V	F-21			
25PCRSI	SAR	25A, 800V, 0.04A, 2.5V	F-21			
25RIA10	INR	25A, 100V, 0.04A, 2V	F-48			 图 F-48
25RIA10M	INR	25A, 100V, 0.04A, 2V	F-23			
25RIA20	INR, INJ	25A, 200V, 0.04A, 2V	F-48			
25RIA20M	INR	25A, 200V, 0.04A, 2V	F-23			
25RIA40	INR, INJ	25A, 400V, 0.04A, 2V	F-48			
25RIA40M	INR	25A, 400V, 0.04A, 2V	F-23			
25RIA60	INR, INJ	25A, 600V, 0.04A, 2V	F-48			
25RIA60M	INR	25A, 600V, 0.04A, 2V	F-23			
25RIA80	INR, INJ	25A, 800V, 0.04A, 2V	F-48			
25RIA80M	INR	25A, 800V, 0.04A, 2V	F-23			
25RIA100	INR, INJ	25A, 1kV, 0.04A, 2V	F-48			 图 F-23
25RIA100M	INR	25A, 1kV, 0.04A, 2V	F-23			
25RIA110	INR, INJ	25A, 1.1kV, 0.04A, 2V	F-48			
25RIA110M	INR	25A, 1.1kV, 0.04A, 2V	F-23			
25RIA120	INR, INJ	25A, 1.2kV, 0.04A, 2V	F-48			
25RIA120M	INR	25A, 1.2kV, 0.04A, 2V	F-23			
25RIA140		40A, 1.4kV	F-48			
25RIA160		40A, 1.6kV	F-48			

器件型号 Element type	厂名 Manufacturers	材料用途参数 Material Purpose Parameter	图号 Figure	国内外相似替换器件型号 Replace of similar type	备注 Notes	外形参考图 Reference shape
25SDG2	WES	47A, 180V, 0.1A, 3V	F-21			 图 F-21
25SDG2JH	WES	50A, 180V, 0.1A, 3V	F-21			
25SDG4	WES	47A, 360V, 0.1A, 3V	F-21			
25SDG4JH	WES	50A, 360V, 0.1A, 3V	F-21			
25SDG5	WES	47A, 450V, 0.1A, 3V	F-21			
25SDG5JH	WES	50A, 450V, 0.1A, 3V	F-21			
25SDG6	WES	47A, 540V, 0.1A, 3V	F-21			
25SDG6JH	WES	50A, 540V, 0.1A, 3V	F-21			
25TB2	HIN	31A, 200V, 0.1A	F-47			 图 F-47
25TB2-JH00	HIN	40A, 200V, 0.1A	F-47			
25TB3	HIN	31A, 300V, 0.1A	F-47			
25TB3-JH00	HIN	40A, 300V, 0.1A	F-47			
25TB4	HIN	31A, 400V, 0.1A	F-47			
25TB4-JH00	HIN	40A, 400V, 0.1A	F-47			
25TB5	HIN	31A, 500V, 0.1A	F-47			
25TB6	HIN	31A, 600V, 0.1A	F-47			
25TB6	HIN	31A, 700V, 0.1A	F-47			
25TB7	HIN	31A, 800V, 0.1A	F-47			
25TB8	HIN	31A, 900V, 0.1A	F-47			
25TB10	HIN	31A, 1kV, 0.1A	F-47			
25IB11	HIN	31A, 1.1kV, 0.1A	F-47			
25TB12	HIN	31A, 1.2kV, 0.1A	F-47			
25TCRA	SAR	25A, 25V, 0.04A, 2.5V	F-48			 图 F-48
25TCRB	SAR	25A, 50V, 0.04A, 2.5V	F-48	ECG5521		
25TCRC	SAR	25A, 150V, 0.04A, 2.5V	F-48	ECG5522		
25TCRF	SAR	25A, 200V, 0.04A, 2.5V	F-48	ECG5524		
25TCRG	SAR	25A, 300V, 0.04A, 2.5V	F-48	ECG5527		
25TCRH	SAR	25A, 400V, 0.04A, 2.5V	F-48	ECG5527		
				ECG5527		

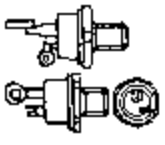
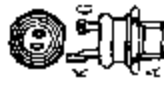
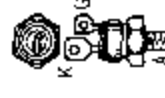

器件型号 Element type	厂名 Manufacturers	材料用途参数 Material Purpose Parameter	图号 Figure	国内外相似替换器件型号 Replace of similar type	备注 Notes	外形参考图 Reference shape
25TCRI	SAR	25A, 500V, 0.04A, 2.5V	F-48	ECG5529		 图 F-48
25TCRJ	SAR	25A, 600V, 0.04A, 2.5V	F-48	ECG5531		
25TCRK	SAR	25A, 700V, 0.04A, 2.5V	F-48	ECG5531		
25TCRL	SAR	25A, 800V, 0.04A, 2.5V	F-48	ECG5531		
25TO-220SG		26A, 1KV	F-21			
26TB1	HIN	25A, 100V, 0.1A	F-47			 图 F-21
26TB2	HIN	25A, 200V, 0.1A	F-47			
26TB3	HIN	25A, 300V, 0.1A	F-47			
26TB4	HIN	25A, 400V, 0.1A	F-47			
26TB5	HIN	25A, 500V, 0.1A	F-47			
26TB6	HIN	25A, 600V, 0.1A	F-47			
26TB7	HIN	25A, 700V, 0.1A	F-47			
26TB8	HIN	25A, 800V, 0.1A	F-47			
26TB9	HIN	25A, 900V, 0.1A	F-47			
26TB10	HIN	25A, 1KV, 0.1A	F-47			
26TB11	HIN	25A, 1.1KV, 0.1A	F-47			
26TB12	HIN	25A, 1.2KV, 0.1A	F-47			
27TB1	HIN	35A, 100V, 0.1A	F-47			 图 F-47
27TB2	HIN	40A, 200V, 0.1A	F-47			
27TB3	HIN	40A, 300V, 0.1A	F-47			
27TB4	HIN	40A, 400V, 0.1A	F-47			
27TB5	HIN	40A, 500V, 0.1A	F-47			
27TB6	HIN	40A, 600V, 0.1A	F-47			
27TB7	HIN	40A, 700V, 0.1A	F-47			
27TB8	HIN	40A, 800V, 0.1A	F-47			
27TB9	HIN	40A, 900V, 0.1A	F-47			
27TB10	HIN	40A, 1KV, 0.1A	F-47			
27TB11	HIN	40A, 1.1KV, 0.1A	F-47			

器件型号 Element type	厂名 Manufacturers	材料用途参数 Material Purpose Parameter	图号 Figure	国内外相似替换器件型号 Replace of similar type	备注 Notes	外形参考图 Reference shape
27TB12	HIN	40A, 1.2kV, 0.1A	F-47			
28TB1	HIN	47A, 100V, 0.1A	F-47			
28TB1-NH	HIN	47A, 100V, 0.1A	F-21			
28TB1-RE	HIN	47A, 100V, 0.1A	F-21			
28TB2	HIN	47A, 200V, 0.1A	F-47			
28TB2-NH	HIN	47A, 200V, 0.1A	F-21			
28TB2-RE	HIN	47A, 200V, 0.1A	F-21			
28TB3	HIN	47A, 300V, 0.1A	F-47			
28TB4	HIN	47A, 400V, 0.1A	F-47			
28TB4-NH	HIN	47A, 400V, 0.1A	F-21			
28TB4-RE	HIN	47A, 400V, 0.1A	F-21			
28TB5	HIN	47A, 500V, 0.1A	F-47			
28TB6	HIN	47A, 600V, 0.1A	F-47			
28TB7	HIN	47A, 700V, 0.1A	F-47			
28TB8	HIN	47A, 800V, 0.1A	F-47			
28TB9	HIN	47A, 900V, 0.1A	F-47			
28TB10	HIN	47A, 1kV, 0.1A	F-47			
28TB11	HIN	47A, 1.1kV, 0.1A	F-47			
28TB12	HIN	47A, 1.2kV, 0.1A	F-47			
29RD40		26A, 400V	F-15			
29RD50		26A, 500V	F-15			
29RD60		26A, 600V	F-15			
29RD80		26A, 800V	F-15			
29RD100		26A, 1kV	F-15			
29RD120		26A, 1.2kV	F-15			
29TB1	HIN	55A, 100V, 0.1A	F-47			



图 F-47







图 F-21



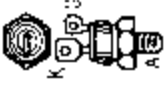
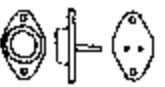

图 F-15

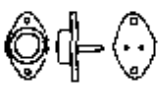

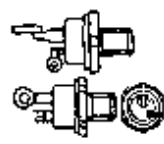

器件型号 Element type	厂名 Manufacturers	材料用途参数 Material Purpose Parameter	图号 Figure	国内外相似替换器件型号 Replace of similar type	备注 Notes	外形参考图 Reference shape	
29TB1-NH	HIN	55A, 100V, 0.1A	F-21			 图 F-21	
29TB1-RE	HIN	55A, 100V, 0.1A	F-21				
29TB2	HIN	55A, 200V, 0.1A	F-47				
29TB3	HIN	55A, 300V, 0.1A	F-47				
29TB4	HIN	55A, 400V, 0.1A	F-47				
29TB5	HIN	55A, 500V, 0.1A	F-47				
29TB6	HIN	55A, 600V, 0.1A	F-47				
29TB7	HIN	55A, 700V, 0.1A	F-47				
29TB8	HIN	55A, 800V, 0.1A	F-47				
29TB9	HIN	55A, 900V, 0.1A	F-47				
29TB10	HIN	55A, 1kV, 0.1A	F-47				
29TB10-NH	HIN	55A, 1kV, 0.1A	F-21				 图 F-47
29TB10-RE	HIN	55A, 1kV, 0.1A	F-21				
29TB11	HIN	55A, 1.1kV, 0.1A	F-47				
29TB12	HIN	55A, 1.2kV, 0.1A	F-47				
29TB12-NH	HIN	55A, 1.2kV, 0.1A	F-21				 图 D-9
29TB12-RE	HIN	55A, 1.2kV, 0.1A	F-21				
35FCRA	SAR	35A, 25V, 0.04A, 3V	D-9			 图 F-48	
35FCRB	SAR	35A, 50V, 0.04A, 3V	D-9				
35FCRC	SAR	35A, 100V, 0.04A, 3V	F-48				
35FCRD	SAR	35A, 150V, 0.04A, 3V	D-9				
35FCRE	SAR	35A, 200V, 0.04A, 3V	D-9				
35FCRF	SAR	35A, 250V, 0.04A, 3V	D-9				
35FCRG	SAR	35A, 300V, 0.04A, 3V	D-9				
35FCRH	SAR	35A, 400V, 0.04A, 3V	D-9				
35FCRI	SAR	35A, 500V, 0.04A, 3V	D-9				
35FCRJ	SAR	35A, 600V, 0.04A, 3V	D-9				
35FCRK	SAR	35A, 700V, 0.04A, 3V	D-9				

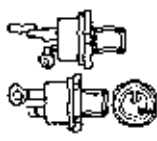
器件型号 Element type	厂名 Manufacturers	材料用途参数 Material Purpose Parameter	图号 Figure	国内外相似替换器件型号 Replace of similar type	备注 Notes	外形参考图 Reference shape
35FCRL	SAR	35A, 800V, 0.04A, 3V	D-9			 图 D-9
35PCRNA	SAR	35A, 25V, 0.04A, 3V				
35PCRNB	SAR	35A, 50V, 0.04A, 3V				
35PCRNC	SAR	35A, 100V, 0.04A, 3V				
35PCRND	SAR	35A, 150V, 0.04A, 3V				
35PCRNE	SAR	35A, 200V, 0.04A, 3V				
35PCRNF	SAR	35A, 250V, 0.04A, 3V				
35PCRNG	SAR	35A, 300V, 0.04A, 3V				
35PCRNH	SAR	35A, 400V, 0.04A, 3V				
35PCRNI	SAR	35A, 500V, 0.04A, 3V				
35PCRNJ	SAR	35A, 600V, 0.04A, 3V				
35PCRNK	SAR	35A, 700V, 0.04A, 3V				
35PCRNL	SAR	35A, 800V, 0.04A, 3V				 图 F-21
35PCRSA	SAR	35A, 25V, 0.04A, 3V	F-21			
35PCRSB	SAR	35A, 50V, 0.04A, 3V	F-21			
35PCRSC	SAR	35A, 100V, 0.04A, 3V	F-21			
35PCRSD	SAR	35A, 150V, 0.04A, 3V	F-21			
35PCRSE	SAR	35A, 200V, 0.04A, 3V	F-21			
35PCRSF	SAR	35A, 250V, 0.04A, 3V	F-21			
35PCRSG	SAR	35A, 300V, 0.04A, 3V	F-21			
35PCRSH	SAR	35A, 400V, 0.04A, 3V	F-21			 图 F-48
35PCRSI	SAR	35A, 500V, 0.04A, 3V	F-21			
35PCRSJ	SAR	35A, 600V, 0.04A, 3V	F-21			
35PCRSK	SAR	35A, 700V, 0.04A, 3V	F-21			
35PCRSL	SAR	35A, 800V, 0.04A, 3V	F-21			
35TCRA	SAR	35A, 25V, 0.04A, 2.5V	F-48			
35TCRB	SAR	35A, 50V, 0.04A, 2.5V	F-48	ECG5541		



器件型号 Element type	厂名 Manufacturers	材料用途参数 Material Purpose Parameter	图号 Figure	国内外相似替换器件型号 Replace of similar type	备注 Notes	外形参考图 Reference shape	
35TCRC	SAR	35A, 100V, 0.04A, 2.5V	F-48	EOG5542		 图 F-48	
35TCRE	SAR	35A, 200V, 0.04A, 2.5V	F-48	EOG5543			
35TCRG	SAR	35A, 300V, 0.04A, 2.5V	F-48	EOG5545			
35TCRH	SAR	35A, 400V, 0.04A, 2.5V	F-48	EOG5545			
35TCRI	SAR	35A, 500V, 0.04A, 2.5V	F-48	EOG5547			
35TCRU	SAR	35A, 600V, 0.04A, 2.5V	F-48	EOG5547			
35TCRK	SAR	35A, 700V, 0.04A, 2.5V	F-48	EOG5548			
35TCRL	SAR	35A, 800V, 0.04A, 2.5V	F-48	EOG5548			
36RA50	INU, SST	80A, 500V, 0.2A, 2.5V	F-91	EOG5572			 图 F-91
36RA60	INU, SST	80A, 600V, 0.2A, 2.5V	F-91	EOG5572			
36RA70	SST	55A, 700V, 0.15A, 2.5V	F-91	EOG5574			
36RA80	INU, SST	80A, 800V, 0.2A, 2.5V	F-91	EOG5574			
36RA90	SST	55A, 900V, 0.15A, 2.5V	F-91	EOG5574			
36RA100	INU, SST	80A, 1kV, 0.2A, 2.5V	F-91	EOG5574			
36RA110	SST	80A, 1.1kV, 0.2A, 2.5V	F-91	EOG5574			
36RA120	INU, SST	80A, 1.2kV, 0.2A, 2.5V	F-91	EOG5574			
36RA150	INU	80A, 1.5kV, 0.2A, 2.5V	F-91	EOG5574			
36RA160	INU	80A, 1.6kV, 0.2A, 2.5V	F-91	EOG5574			
36RC10A	INU, SST	80A, 100V, 0.07A, 2.5V	F-91			 图 B-74	
36RC20A	INU, SST	80A, 200V, 0.07A, 2.5V	F-91				
36RC30A	INU, SST	80A, 300V, 0.07A, 2.5V	F-91				
36RC40A	INU, SST	80A, 400V, 0.07A, 2.5V	F-91				
36RC50A	SST	80A, 500V, 0.07A, 2.5V	F-91				
36RC60A	INU, SST	80A, 600V, 0.07A, 2.5V	F-91				
36RC80A	INU, SST	80A, 800V, 0.07A, 2.5V	F-91				
36RC100A	INU	80A, 1kV, 0.07A, 2.5V	B-74				
36RC110A	INU	80A, 1.1kV, 0.07A, 2.5V	B-74				
36RC120A	INU	80A, 1.2kV, 0.07A, 2.5V	B-74				

器件型号 Element type	厂名 Manufacturers	材料用途参数 Material Purpose Parameter	图号 Figure	国内外相似替换器件型号 Replace of similar type	备注 Notes	外形参考图 Reference shape	
36REH60	INU	80A, 600V, 0.2A, 2.5V	F-91	ECG5572		 图 F-91	
36REH80	INU	80A, 800V, 0.2A, 2.5V	F-91	ECG5574			
36REH100	INU	80A, 1kV, 0.2A, 2.5V	F-91	ECG5574			
36REH120	INU	80A, 1.2kV, 0.2A, 2.5V	F-91	ECG5574			
36REH130	INU	80A, 1.3kV, 0.2A, 2.5V	F-91	ECG5574			
36TB1	HIN	70A, 100V, 0.15A	F-21			 图 F-21	
36TB2	HIN	70A, 200V, 0.15A	F-21				
36TB3	HIN	70A, 300V, 0.15A	F-21				
36TB4	HIN	70A, 400V, 0.15A	F-21				
36TB5	HIN	70A, 500V, 0.15A	F-21				
36TB6	HIN	70A, 600V, 0.15A	F-21				
36TB7	HIN	70A, 700V, 0.15A	F-21				
36TB8	HIN	70A, 800V, 0.15A	F-21				
36TB9	HIN	70A, 900V, 0.15A	F-21				
36TB10	HIN	70A, 1kV, 0.15A	F-21				
36TB11	HIN	70A, 1.1kV, 0.15A	F-21				
36TB12	HIN	70A, 1.2kV, 0.15A	F-21				
37RA60	INU	80A, 600V, 0.2A, 2.5V	B-74	ECG5577			 图 B-74
37RA80	INU	80A, 800V, 0.2A, 2.5V	B-74	ECG5579			
37RA100	INU	80A, 1kV, 0.2A, 2.5V	B-74	ECG5579			
37RA120	INU	80A, 1.2kV, 0.2A, 2.5V	B-74	ECG5579			
37RA150	INU	80A, 1.5kV, 0.2A, 2.5V	B-74	ECG5579			
37RA160	INU	80A, 1.6kV, 0.2A, 2.5V	B-74				
37RC10A	INU	80A, 100V, 0.07A, 2.5V	B-74				
37RC20A	INU	80A, 200V, 0.07A, 2.5V	B-74				
37RC30A	INU	80A, 300V, 0.07A, 2.5V	B-74				
37RC40A	INU	80A, 400V, 0.07A, 2.5V	B-74				



器件型号 Element type	厂名 Manufacturers	材料用途参数 Material Purpose Parameter	图号 Figure	国内外相似替换器型号 Replace of similar type	备注 Notes	外形参考图 Reference shape
37RC80A	INJ	80A, 600V, 0.07A, 2.5V	B-74			 图 B-74
37RC80A	INJ	80A, 800V, 0.07A, 2.5V	B-74			
37RC100A	INJ	80A, 1kV, 0.07A, 2.5V	B-74			
37RC110A	INJ	80A, 1.1kV, 0.07A, 2.5V	B-74			
37RC120A	INJ	80A, 1.2kV, 0.07A, 2.5V	B-74			
37REH60	INJ	80A, 600V, 0.2A, 2.5V	B-74	ECG5577		
37REH80	INJ	80A, 800V, 0.2A, 2.5V	B-74	ECG5579		
37REH100	INJ	80A, 1kV, 0.2A, 2.5V	B-74	ECG5579		
37REH120	INJ	80A, 1.2kV, 0.2A, 2.5V	B-74	ECG5579		
37REH130	INJ	80A, 1.3kV, 0.2A, 2.5V	B-74			
37TB1	HIN	85A, 100V, 0.15A	F-21			
37TB2	HIN	85A, 200V, 0.15A	F-21			
37TB3	HIN	85A, 300V, 0.15A	F-21			
37TB4	HIN	85A, 400V, 0.15A	F-21			
37TB5	HIN	85A, 500V, 0.15A	F-21			
37TB6	HIN	85A, 600V, 0.15A	F-21			
37TB7	HIN	85A, 700V, 0.15A	F-21			
37TB8	HIN	85A, 800V, 0.15A	F-21			
37TB9	HIN	85A, 900V, 0.15A	F-21			
37TB10	HIN	85A, 1kV, 0.15A	F-21			
37TB11	HIN	85A, 1.1kV, 0.15A	F-21			
38TB1	HIN	100A, 100V, 0.15A	F-21			
38TB2	HIN	100A, 200V, 0.15A	F-21			
38TB3	HIN	100A, 300V, 0.15A	F-21			
38TB4	HIN	100A, 400V, 0.15A	F-21			
38TB5	HIN	100A, 500V, 0.15A	F-21			
38TB6	HIN	100A, 600V, 0.15A	F-21			

器件型号 Element type	厂名 Manufacturers	材料用途参数 Material Purpose Parameter	图号 Figure	国内外相似替换器件型号 Replace of similar type	备注 Notes	外形参考图 Reference shape
38TB7	HIN	100A, 700V, 0.15A	F-21			
38TB8	HIN	100A, 800V, 0.15A	F-21			
38TB9	IIN	100A, 900V, 0.15A	F-21			
38TB10	HIN	100A, 1kV, 0.15A	F-21			
38TB11	HIN	100A, 1.1kV, 0.15A	F-21			
38TB12	HIN	100A, 1.2kV, 0.15A	F-21			
39RC20		35A, 200V	F-15			
39RC30		35A, 300V	F-15			
39RC40		35A, 400V	F-15			
39RC50		35A, 500V	F-15			
39RC60		35A, 600V	F-15			
39RC80		35A, 800V	F-15			
39RC100		35A, 1kV	F-15			
39RC120		35A, 1.2kV	F-15			
39RF20	SCR-H	35A, 200V	F-15			
39RF30	SCR-H	35A, 300V	F-15			
39RF40	SCR-H	35A, 400V	F-15			
39RF50	SCR-H	35A, 500V	F-15			
39RF60	SCR-H	35A, 600V	F-15			
39RF80	SCR-H	35A, 800V	F-15			
40C05	SIT	63A, 50V, 0.1A, 3V	F-21			
40C10	SIT	63A, 100V, 0.1A, 3V	F-21	ECG5567		
40C15	SIT	63A, 150V, 0.1A, 3V	F-21	ECG5567		
40C20	SIT	63A, 200V, 0.1A, 3V	F-21	ECG5567		
40C25	SIT	63A, 250V, 0.1A, 3V	F-21	ECG5568		
40C30	SIT	63A, 300V, 0.1A, 3V	F-21	ECG5568		
40C35	SII	63A, 350V, 0.1A, 3V	F-21	ECG5568		





图 F-21



图 F-15



器件型号 Element type	厂名 Manufacturers	材料用途参数 Material Purpose Parameter	图号 Figure	国内外相似替换器件型号 Replace of similar type	备注 Notes	外形参考图 Reference shape	
40C40	SIT	63A, 400V, 0.1A, 3V	F-21	ECG5568		 图 F-21	
40C45	SIT	63A, 450V, 0.1A, 3V	F-21	ECG5568			
40C50	SIT	63A, 500V, 0.1A, 3V	F-21	ECG5568			
40C60	SIT	63A, 600V, 0.1A, 3V	F-21	ECG5568			
40C70	SIT	63A, 700V, 0.1A, 3V	F-21	ECG5569			
40C80	SIT	63A, 800V, 0.1A, 3V	F-21	ECG5569			
40C90	SIT	63A, 900V, 0.1A, 3V	F-21	ECG5569			
40C100	SIT	63A, 1kV, 0.1A, 3V	F-21	ECG5569			
40C110	SIT	63A, 1.1kV, 0.1A, 3V	F-21	ECG5569			
40C120	SIT	63A, 1.2kV, 0.1A, 3V	F-21	ECG5569			
40RBF50W	INR	40A, 500V, 0.2A, 2.5V	F-19				 图 F-19
40RBF60W	INR	40A, 600V, 0.2A, 2.5V	F-19				
40RBF80W	INR	40A, 800V, 0.2A, 2.5V	F-19				
40RBF100W	INR	40A, 1kV, 0.2A, 2.5V	F-19				
40RBF110W	INR	40A, 1.1kV, 0.2A, 2.5V	F-19				
40RCS5	SST	63A, 50V, 0.11A, 3V	F-21	ECG5567			
40RCS10	SST	63A, 100V, 0.11A, 3V	F-21	ECG5567			
40HCS20	SST	63A, 200V, 0.11A, 3V	F-21	ECG5568			
40RCS30	SST	63A, 300V, 0.11A, 3V	F-21	ECG5568			
40RCS40	SSI	63A, 400V, 0.11A, 3V	F-21	ECG5568			
40RCS50	SST	63A, 500V, 0.11A, 3V	F-21	ECG5568			
40RCS60	SST	63A, 600V, 0.11A, 3V	F-21	ECG5568			
40RCS70	SST	63A, 700V, 0.11A, 3V	F-21	ECG5569			
40RCS80	SST	63A, 800V, 0.11A, 3V	F-21	ECG5569			
40RCS90	SST	63A, 900V, 0.11A, 3V	F-21	ECG5569			
40RCS100	SST	63A, 1kV, 0.11A, 3V	F-21	ECG5569			
40RCS110	SST	63A, 1.1kV, 0.11A, 3V	F-21	ECG5569			
40RCS120	SST	63A, 1.2kV, 0.11A, 3V	F-21	ECG5569			

器件型号 Element type	厂名 Manufacturers	材料用途参数 Material Purpose Parameter	图号 Figure	国内外相似替换器件型号 Replace of similar type	备注 Notes	外形参考图 Reference shape
42TB1	HIN	135A, 100V, 0.2A	E-9			
42TB2	HIN	135A, 200V, 0.2A	E-9			
42TB3	HIN	135A, 300V, 0.2A	F-9			
42TB4	HIN	135A, 400V, 0.2A	E-9			
42TB5	HIN	135A, 500V, 0.2A	E-9			
42TB6	HIN	135A, 600V, 0.2A	E-9			
42TB7	HIN	135A, 700V, 0.2A	E-9			
42TB8	HIN	135A, 800V, 0.2A	E-9			
42TB9	HIN	135A, 900V, 0.2A	E-9			
42TB10	HIN	135A, 1kV, 0.2A	E-9			
42TB11	HIN	135A, 1.1kV, 0.2A	E-9			
42TB12	HIN	135A, 1.2kV, 0.2A	E-9			
42TB13	HIN	135A, 1.3kV, 0.2A	E-9			
42TB15	HIN	135A, 1.5kV, 0.2A	E-9			
43TB1	HIN	175A, 100V, 0.2A	E-9			
43TB2	HIN	175A, 200V, 0.2A	E-9			
43TB3	HIN	175A, 300V, 0.2A	E-9			
43TB4	HIN	175A, 400V, 0.2A	E-9			
43TB5	HIN	175A, 500V, 0.2A	E-9			
43TB6	HIN	175A, 600V, 0.2A	E-9			
43TB7	HIN	175A, 700V, 0.2A	E-9			
43TB8	HIN	175A, 800V, 0.2A	E-9			
43TB9	HIN	175A, 900V, 0.2A	E-9			
43TB10	HIN	175A, 1kV, 0.2A	E-9			
43TB11	HIN	175A, 1.1kV, 0.2A	E-9			
43TB12	HIN	175A, 1.2kV, 0.2A	E-9			
43TB13	HIN	175A, 1.3kV, 0.2A	E-9			
43TB15	HIN	175A, 1.5kV, 0.2A	E-9			





图 E-9

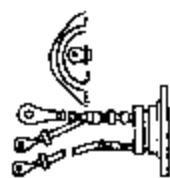
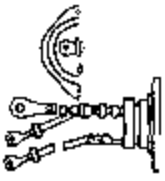
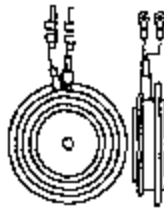
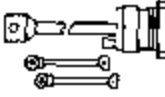
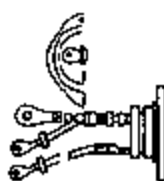
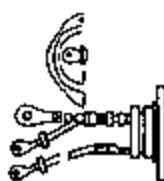

器件型号 Element type	厂名 Manufacturers	材料用途参数 Material Purpose Parameter	图号 Figure	国内外相似替换器件型号 Replace of similar type	备注 Notes	外形参考图 Reference shape
46TB1	HIN	195A, 100V, 0.2A	E-9			 图 E-9
46TB2	HIN	195A, 200V, 0.2A	E-9			
46TB3	HIN	195A, 300V, 0.2A	E-9			
46TB4	HIN	195A, 400V, 0.2A	E-9			
46TB5	HIN	195A, 500V, 0.2A	E-9			
46TB6	HIN	195A, 600V, 0.2A	E-9			
46TB7	HIN	195A, 700V, 0.2A	E-9			
46TB8	HIN	195A, 800V, 0.2A	E-9			
46TB8CHGO	WES	150A, 800V, 0.2A, 3V	C-50			
46TB9	HIN	195A, 900V, 0.2A	E-9			
46TB9-LH00	HIN	220A, 900V, 0.2A	E-9			
46TB10	HIN	195A, 1kV, 0.2A	E-9			
46TB10-LH00	HIN	220A, 1kV, 0.2A	E-9			
46TB11	HIN	220A, 1.1kV, 0.2A	E-9			
46TB12	HIN	220A, 1.2kV, 0.2A	E-9			
46TB13	HIN	195A, 1.3kV, 0.2A	E-9			
46TB14	HIN	195A, 1.4kV, 0.2A	E-9			
46TB15	HIN	195A, 1.5kV, 0.2A	E-9			
46TB18	HIN	190A, 1.8kV, 0.3A	E-12			
46TB20	HIN	190A, 2kV, 0.3A	E-12			
47TB1	HIN	220A, 100V, 0.2A	E-9			 图 C-50
47TB2	HIN	220A, 200V, 0.2A	E-9			
47TB3	HIN	220A, 300V, 0.2A	E-9			
47TB4	HIN	220A, 400V, 0.2A	E-9			
47TB5	HIN	220A, 500V, 0.2A	E-9			
47TB6	HIN	220A, 600V, 0.2A	E-9			
47TB7	HIN	220A, 700V, 0.2A	E-9			
47TB8	HIN	220A, 800V, 0.2A	E-9			
						 图 E-12

器件型号 Element type	厂名 Manufacturers	材料用途参数 Material Purpose Parameter	图号 Figure	国内外相似替换器件型号 Replace of similar type	备注 Notes	外形参考图 Reference shape
47T1B9	HIN	220A, 900V, 0.2A	E-9			
47T1B10	HIN	220A, 1kV, 0.2A	E-9			
47T1B12	HIN	220A, 1.2kV, 0.2A	E-9			
050A1	SIT	80A, 150V, 0.1A, 3V	F-21			
050A2	SIT	80A, 250V, 0.1A, 3V	F-21			
050A3	SIT	80A, 350V, 0.1A, 3V	F-21			
050A4	SIT	80A, 450V, 0.1A, 3V	F-21			
050AA	SIT	80A, 50V, 0.1A, 3V	F-21			
050BB	SIT	80A, 25V, 0.1A, 3V	F-21			
50AC40A	INR, INJ	50A, 400V, 0.2A, 2V	F-21			
50AC60A	INR, INJ	50A, 600V, 0.2A, 2V	F-21			
50AC80A	INR, INJ	50A, 800V, 0.2A, 2V	F-21			
50AC100A	INR, INJ	50A, 1kV, 0.2A, 2V	F-21			
50AC120A	INR, INJ	50A, 1.2kV, 0.2A, 2V	F-21			
50P1SF		50A, 100V	F-95			
50P1SG		50A, 100V	F-19			
50P1SP	NEC	80A, 100V, 0.1A, 3.5V	C-70			
50P2SF		50A, 200V	F-95			
50P2SG	NEC	50A, 200V, 0.07A, 1.5V	F-19			
50P2SP	NEC	80A, 200V, 0.1A, 3.5V	C-70			
50P3SF		50A, 300V	F-95			
50P3SG		50A, 300V	F-19			
50P3SP	NEC	80A, 300V, 0.1A, 3.5V	C-70			
50P4SF		50A, 400V	F-95			
50P4SP	NEC	80A, 400V, 0.1A, 3.5V	C-70			
50P4SG	NEC	50A, 400V, 0.07A, 1.5V	F-19			





















器件型号 Element type	厂名 Manufacturers	材料用途参数 Material Purpose Parameter	图号 Figure	国内外相似替换器件型号 Replace of similar type	备注 Notes	外形参考图 Reference shape
50P5SF		50A, 500V	F-95			
50P5SP	NEC	80A, 500V, 0.1A, 3.5V	C-70			
50P6SF		50A, 600V	F-95			
50P6SP	NEC	80A, 600V, 0.1A, 3.5V	C-70			
50P6SG	NEC	50A, 600V, 0.07A, 1.5V	F-19			
50P8SF		50A, 800V	F-95			
50P8SG	NEC	50A, 800V, 0.07A, 1.5V	F-19			
50P8SP	NEC	80A, 800V, 0.1A, 3.5V	C-70			
50P10SP	NEC	80A, 1kV, 0.1A, 3.5V	E-22			
50P10SG	NEC	50A, 1kV, 0.07A, 1.5V	F-21			
50P12SP	NEC	80A, 1.2kV, 0.1A, 3.5V	C-70			
50P16SP	NEC	80A, 1.6kV, 0.1A, 3.5V	C-70			
50R1A10		55A, 100V	F-47	MCR64-3		
50R1A20		55A, 200V	F-47	MCR64-4		
50R1A40		55A, 400V	F-47	MCR64-6		
50R1A60		55A, 600V	F-47	MCR64-8		
50R1A80		55A, 800V	F-47	MCR64-10		
50R1A100		40A, 1.4kV	F-49			
50R1A120		40A, 1.6kV	F-49			
50R1A140		40A, 1.4kV	F-49			
50R1A160		40A, 1.6kV	F-49			
50RBF10W	INR	50A, 100V, 0.2A, 2.5V	F-19			
50RBF20W	INR	50A, 200V, 0.2A, 2.5V	F-19			
50RBF30W	INR	50A, 300V, 0.2A, 2.5V	F-19			
50RBF40W	INR	50A, 400V, 0.2A, 2.5V	F-19			
50RBF50W	INR	50A, 500V, 0.2A, 2.5V	F-19			
50RBF60W	INR	50A, 600V, 0.2A, 2.5V	F-19			
50RCS5	SST	80A, 50V, 0.11A, 3V	F-21			











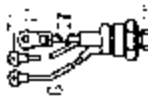



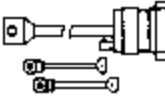

器件型号 Element type	厂名 Manufacturers	材料用途参数 Material Purpose Parameter	图号 Figure	国内外相似替换器件型号 Replace of similar type	备注 Notes	外形参考图 Reference shape
50RCS10	SST	80A, 100V, 0.11A, 3V	F-21			
50RCS20	SST	80A, 200V, 0.11A, 3V	F-21			
50RCS30	SST	80A, 300V, 0.11A, 3V	F-21			
50RCS40	SST	80A, 400V, 0.11A, 3V	F-21			
50RCS50	SST	80A, 500V, 0.11A, 3V	F-21			
50RCS60	SST	80A, 600V, 0.11A, 3V	F-21			
50RCS70	SST	80A, 700V, 0.11A, 3V	F-21			
50RCS80	SST	80A, 800V, 0.11A, 3V	F-21			
50RCS90	SST	80A, 900V, 0.11A, 3V	F-21			
50RCS100	SST	80A, 1kV, 0.11A, 3V	F-21			
50RCS110	SST	80A, 1.1kV, 0.11A, 3V	F-21			
50RCS120	SST	80A, 1.2kV, 0.11A, 3V	F-21			
50RIA5	INR	50A, 50V, 0.1A, 2.5V	F-21			
50RIA10	INR	50A, 100V, 0.1A, 2.5V	F-21	ECG55567		
50RIA20	INR	50A, 200V, 0.1A, 2.5V	F-21	ECG55567		
50RIA40	INR	50A, 400V, 0.1A, 2.5V	F-21	ECG55568		
50RIA60	INR	50A, 600V, 0.1A, 2.5V	F-21	ECG55568		
50RIA80	INR	50A, 800V, 0.1A, 2.5V	F-21	ECG55569		
50RIA100	INR	50A, 1kV, 0.1A, 2.5V	F-21	ECG55569		
50RIA110	INR	50A, 1.1kV, 0.1A, 2.5V	F-21	ECG55569		
50RIA120	INR	50A, 1.2kV, 0.1A, 2.5V	F-21	ECG55569		
50RIA20M	INR	50A, 200V, 0.1A, 2.5V	F-21	ECG55569		
50RIA40M	INR	50A, 400V, 0.1A, 2.5V	F-21			
50RIA60M	INR	50A, 600V, 0.1A, 2.5V	F-21			
50RIA80M	INR	50A, 800V, 0.1A, 2.5V	F-21			
50RIA100M	INR	50A, 1kV, 0.1A, 2.5V	F-21			
50RIA110M	INR	50A, 1.1kV, 0.1A, 2.5V	F-21			
50RIA120M	INR	50A, 1.2kV, 0.1A, 2.5V	F-21			



图 F-21

其他

器件型号 Element type	厂名 Manufacturers	材料用途参数 Material Purpose Parameter	图号 Figure	国内外相似替换器件型号 Replace of similar type	备注 Notes	外形参考图 Reference shape
50S2SP	NEC	80A, 200V, 0.1A, 3.5V	F-60			
50S3SP	NEC	80A, 300V, 0.1A, 3.5V	F-60			
50S4SP	NEC	80A, 400V, 0.1A, 3.5V	F-60			
50S5SP	NEC	80A, 500V, 0.1A, 3.5V	F-60			
50S6SP	NEC	80A, 600V, 0.1A, 3.5V	F-60			
50S8SP	NEC	80A, 800V, 0.1A, 3.5V	F-60			
50SS2SP	NEC	80A, 200V, 0.1A, 3.5V	F-60			
50SS3SP	NEC	80A, 300V, 0.1A, 3.5V	F-60			
50SS4SP	NEC	80A, 400V, 0.1A, 3.5V	F-60			
50SS5SP	NEC	80A, 500V, 0.1A, 3.5V	F-60			
50SS6SP	NEC	80A, 600V, 0.1A, 3.5V	F-60			
50SS8SP	NEC	80A, 800V, 0.1A, 3.5V	F-60			
50TO-220SG		50A, 1kV	F-19			
50TO-220SP		50A, 1kV	C-70			
51MT80K		3PH, 55A, 800V	B-70			
51MT100K		3PH, 55A, 1kV	B-70			
51MT120K		3PH, 55A, 1.2kV	B-70			
51MT140K		3PH, 55A, 1.4kV	B-70			
51MT160K		3PH, 55A, 1.6kV	B-70			
51RC10	INR	80A, 100V, 0.07A, 2.5V	F-71	ECG5570		
51RC20	INR	80A, 200V, 0.07A, 2.5V	F-71	ECG5570		
51RC30	INR	80A, 300V, 0.07A, 2.5V	F-71	ECG5572		
51RC40	INR	80A, 400V, 0.07A, 2.5V	F-71	ECG5572		
51RC50	INR	80A, 500V, 0.07A, 2.5V	F-71	ECG5572		
51RC60	INR	80A, 600V, 0.07A, 2.5V	F-71	ECG5572		
51RC70	INR	80A, 700V, 0.07A, 2.5V	F-71	ECG5572		

器件型号 Element type	厂名 Manufacturers	材料用途参数 Material Purpose Parameter	图号 Figure	国内外相似替换器件型号 Replace of similar type	备注 Notes	外形参考图 Reference shape
51RC80	INR	80A, 800V, 0.07A, 2.5V	F-71	ECG5574		
51RC100	INR	80A, 1kV, 0.07A, 2.5V	F-71			
51RC120	INR	80A, 1.2kV, 0.07A, 2.5V	F-71			
52MT80K	SCB	3PH, 55A, 800V	B-70			
52MT100K	SCB	3PH, 55A, 1kV	B-70			
52MT120K	SCB	3PH, 55A, 1.2kV	B-70			
52MT140K	SCB	3PH, 55A, 1.4kV	B-70			
52MT160K	SCB	3PH, 55A, 1.6kV	B-70			
53MT80K	SCB	3PH, 55A, 800V	B-70			
53MT100K	SCB	3PH, 55A, 1kV	B-70			
53MT120K	SCB	3PH, 55A, 1.2kV	B-70			
53MT140K	SCB	3PH, 55A, 1.4kV	B-70			
53MT160K	SCB	3PH, 55A, 1.6kV	B-70			
53TB16-CH00	HIN	190A, 1.6kV, 0.3A	E-12			
54MT80K	SCB	3PH, 50A, 800V	B-71			
54MT100K	SCB	3PH, 50A, 1kV	B-71			
54MT120K	SCB	3PH, 50A, 1.2kV	B-71			
54MT140K	SCB	3PH, 50A, 1.4kV	B-71			
54MT160K	SCB	3PH, 50A, 1.6kV	B-71			
55C05	SIT	86A, 50V, 0.1A, 3V	F-91	ECG5570		
55C10	SIT	86A, 100V, 0.1A, 3V	F-91	ECG5570		
55C15	SIT	86A, 150V, 0.1A, 3V	F-91	ECG5570		
55C20	SIT	86A, 200V, 0.1A, 3V	F-91	ECG5570		
55C25	SIT	86A, 250V, 0.1A, 3V	F-91	ECG5572		



器件型号 Element type	厂名 Manufacturers	材料用途参数 Material Purpose Parameter	图号 Figure	国内外相似替换器件型号 Replace of similar type	备注 Notes	外形参考图 Reference snape
55C30	SIT	86A, 300V, 0.1A, 3V	F-91	ECG5572		 图 F-91
55C35	SIT	86A, 350V, 0.1A, 3V	F-91	ECG5572		
55C40	SIT	86A, 400V, 0.1A, 3V	F-91	ECG5572		
55C45	SIT	86A, 450V, 0.1A, 3V	F-91	ECG5572		
55C50	SIT	86A, 500V, 0.1A, 3V	F-91	ECG5572		
55C60	SIT	86A, 600V, 0.1A, 3V	F-91	ECG5572		
55C70	SIT	86A, 700V, 0.1A, 3V	F-91	ECG5574		
55C80	SIT	86A, 800V, 0.1A, 3V	F-91	ECG5574		
55C90	SIT	86A, 900V, 0.1A, 3V	F-91	ECG5574		
55C100	SIT	86A, 1kV, 0.1A, 3V	F-91	ECG5574		
55C110	SIT	86A, 1.1kV, 0.1A, 3V	F-91	ECG5574		
55C120	SIT	86A, 1.2kV, 0.1A, 3V	F-91	ECG5574		
55C130	SIT	86A, 1.3kV, 0.1A, 3V	F-91	ECG5574		
55C150	SIT	86A, 1.5kV, 0.1A, 3V	F-91	ECG5574		
55C160	SIT	86A, 1.6kV, 0.1A, 3V	F-91	ECG5574		
55C170	SIT	86A, 1.7kV, 0.1A, 3V	F-91	ECG5579		
55C180	SIT	86A, 1.8kV, 0.1A, 3V	F-91			
56TB17	HIN	190A, 1.7kV, 0.3A	E-12			
56TB19	HIN	190A, 1.9kV, 0.3A	E-12			
56TB20	HIN	190A, 2kV, 0.3A	E-12			
57TB16	HIN	210A, 1.6kV, 0.3A	E-12			
57TB16-CH00	HIN	2A, 1.6kV, 0.3A	E-12			
57TB17	HIN	210A, 1.7kV, 0.3A	E-12			
57TB17-CH00	HIN	2A, 1.7kV, 0.3A	E-12			
57TB18	HIN	210A, 1.8kV, 0.3A	E-12			
57TB18-CH00	HIN	2A, 1.8kV, 0.3A	E-12			
57TB19	HIN	210A, 1.9kV, 0.3A	E-12			

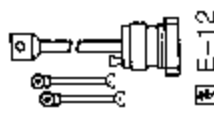
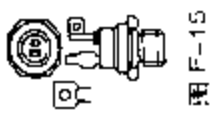

器件型号 Element type	厂名 Manufacturers	材料用途参数 Material Purpose Parameter	图号 Figure	国内外相似替换器件型号 Replace of similar type	备注 Notes	外形参考图 Reference shape
57TB19-CH00	HIN	2A, 1.9kV, 0.3A	E-12			 用 E-12
57TB20	HIN	210A, 2kV, 0.3A	E-12			
57TB20-CH00	HIN	2A, 2kV, 0.3A	E-12			
58TB13	HIN	225A, 1.3kV, 0.3A	E-12			 用 F-15
58TB14	HIN	225A, 1.4kV, 0.3A	E-12			
58TB15	HIN	225A, 1.5kV, 0.3A	E-12			
58TB16	HIN	225A, 1.6kV, 0.3A	E-12			
58TB17	HIN	225A, 1.7kV, 0.3A	E-12			
58TB18	HIN	225A, 1.8kV, 0.3A	E-12			
58TB19	HIN	225A, 1.9kV, 0.3A	E-12			
58TB20	HIN	225A, 2kV, 0.3A	E-12			
59RC20		50A, 200V	F-15			
59RC30		50A, 300V	F-15			
59RC40		50A, 400V	F-15			
59RC50		50A, 500V	F-15			
59RC60		50A, 600V	F-15			
59RC80		50A, 800V	F-15			
59RC100		50A, 1kV	F-15			
59RC120		50A, 1.2kV	F-15			
59RF20	SCR-H	50A, 200V	F-15			
59RF30	SCR-H	50A, 300V	F-15			
59RF40	SCR-H	50A, 400V	F-15			
59RF50	SCR-H	50A, 500V	F-15			
59RF60	SCR-H	50A, 600V	F-15			
59RF80	SCR-H	50A, 800V	F-15			



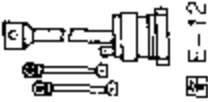



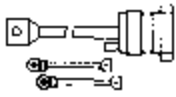

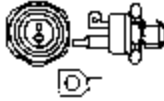
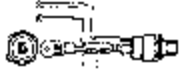

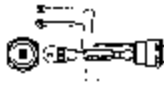
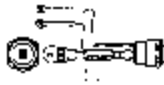

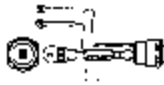

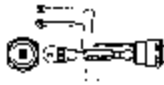
器件型号 Element type	厂名 Manufacturers	材料用途参数 Material Purpose Parameter	图号 Figure	国内外相似替换器件型号 Replace of similar type	备注 Notes	外形参考图 Reference shape
60AC80	INJ	60A, 800V, 0.5A, 2.5V	F 91			
61T20, 21	HIN	275A, 1.8KV, 0.4A	E-12			 图 F-91
61T22, 23	HIN	275A, 1.9KV, 0.4A	E-12			
61T24, 25, 26	HIN	275A, 2KV, 0.4A	E-12			
61T27, 28	HIN	275A, 2.1KV, 0.4A	E-12			
61T29	HIN	275A, 2.2KV, 0.4A	E-12			
61T30, 31	HIN	275A, 2.3KV, 0.4A	E-12			
61T32	HIN	275A, 2.4KV, 0.4A	E-12			
61T33, 34	HIN	275A, 2.5KV, 0.4A	E-12			
61T35	HIN	275A, 2.6KV, 0.4A	E-12			
61T36, 37	HIN	275A, 2.7KV, 0.4A	E-12			
61T38	HIN	275A, 2.8KV, 0.4A	E-12			
61T39	HIN	275A, 2.9KV, 0.4A	E-12			
61T40	HIN	275A, 3KV, 0.4A	E-12			
61TB1	HIN	275A, 100V, 0.3A	E-12			
61TB2	HIN	275A, 200V, 0.3A	E-12			
61TB3	HIN	275A, 300V, 0.3A	E-12			
61TB4	HIN	275A, 400V, 0.3A	E-12			
61TB5	HIN	275A, 500V, 0.3A	E-12			
61TB6	HIN	275A, 600V, 0.3A	E-12			
61TB7	HIN	275A, 700V, 0.3A	E-12			
61TB8	HIN	275A, 800V, 0.3A	E-12			
61TB9	HIN	275A, 900V, 0.3A	E-12			
61TB10	HIN	275A, 1KV, 0.3A	E-12			
61TB11	HIN	275A, 1.1KV, 0.3A	E-12			
61TB12	HIN	275A, 1.2KV, 0.3A	E-12			
61TB13	HIN	275A, 1.3KV, 0.3A	E-12			
61TB14	HIN	275A, 1.4KV, 0.3A	E-12			

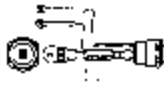
器件型号 Element type	厂名 Manufacturers	材料用途参数 Material Purpose Parameter	图号 Figure	国内外相似替换器件型号 Replace of similar type	备注 Notes	外形参考图 Reference shape
61TB15	HIN	275A, 1.5kV, 0.3A	E-12			 图 E-12
61TB16	HIN	275A, 1.6kV, 0.3A	E-12			
61TB17	HIN	275A, 1.7kV, 0.3A	E-12			
61TB18	HIN	275A, 1.8kV, 0.3A	E-12			
61TB19	HIN	275A, 1.9kV, 0.3A	E-12			
61TB20	HIN	275A, 2kV, 0.3A	E-12			
62T20, 21	HIN	315A, 1.8kV, 0.4A				
62T22, 23	HIN	315A, 1.9kV, 0.4A	E-12			
62T24, 25	HIN	315A, 2kV, 0.4A	E-12			
62T26	HIN	315A, 2kV, 0.4A	E-12			
62T27, 28	HIN	315A, 2.1kV, 0.4A	E-12			
62T29	HIN	315A, 2.2kV, 0.4A	E-12			
62T30, 31	HIN	315A, 2.3kV, 0.4A	E-12			
62T32	HIN	315A, 2.4kV, 0.4A	E-12			
62T33, 34	HIN	315A, 2.5kV, 0.4A	E-12			
62T35	HIN	315A, 2.6kV, 0.4A	E-12			
62T36, 37	HIN	315A, 2.7kV, 0.4A	E-12			
62T38	HIN	315A, 2.8kV, 0.4A	E-12			
62T39	HIN	315A, 2.9kV, 0.4A	E-12			
62T40	HIN	315A, 3kV, 0.4A	E-12			
62TB1	HIN	315A, 100V, 0.3A	E-12			
62TB2	HIN	315A, 200V, 0.3A	E-12			
62TB3	HIN	315A, 300V, 0.3A	E-12			
62TB4	HIN	315A, 400V, 0.3A	E-12			
62TB5	HIN	315A, 500V, 0.3A	E-12			
62TB6	HIN	315A, 600V, 0.3A	E-12			
62TB7	HIN	315A, 700V, 0.3A	E-12			
62TB8	HIN	315A, 800V, 0.3A	E-12			

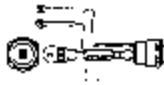

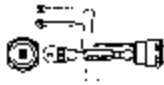
器件型号 Element type	厂名 Manufacturers	材料用途参数 Material Purpose Parameter	图号 Figure	国内外相似替换器件型号 Replace of similar type	备注 Notes	外形参考图 Reference shape
62TB9	HIN	315A, 900V, 0.3A	E-12			
62TB10	HIN	315A, 1kV, 0.3A	E-12			图 E-12
62TB11	HIN	315A, 1.1kV, 0.3A	E-12			
62TB12	HIN	315A, 1.2kV, 0.3A	E-12			图 F-84
62TB13	HIN	315A, 1.3kV, 0.3A	E-12			
62TB14	HIN	315A, 1.4kV, 0.3A	E-12			图 F-20
62TB15	HIN	315A, 1.5kV, 0.3A	E-12			
62TB16	HIN	315A, 1.6kV, 0.3A	E-12			图 F-91
62TB17	HIN	315A, 1.7kV, 0.3A	E-12			
62TB18	HIN	315A, 1.8kV, 0.3A	E-12			
62TB19	HIN	315A, 1.9kV, 0.3A	E-12			
62TB20	HIN	315A, 2kV, 0.3A	E-12			
68RP10		60A, 100V	F-84			
68RP20		60A, 200V	F-84			
68RP30		60A, 300V	F-84			
68RP40		60A, 400V	F-84			
68RP50		60A, 500V	F-84			
68RP60		60A, 600V	F-84			
68RP80		60A, 800V	F-84			
68RS100		60A, 1kV	F-84			
68RS120		60A, 1.2kV	F-84			
68RS140		60A, 1.4kV	F-84			
68RS160		60A, 1.6kV	F-84			
69RW30		60A, 300V	F-20			
69RW40		60A, 400V	F-20			
70C05	SIT	110A, 50V, 0.2A, 3V	F-91			
70C05B	SIT	110A, 50V, 0.15A, 3V	F-91			

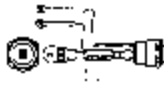
器件型号 Element type	厂名 Manufacturers	材料用途参数 Material Purpose Parameter	图号 Figure	国内外相似替换器件型号 Replace of similar type	备注 Notes	外形参考图 Reference shape
70C05BF	SIT	110A, 50V, 0.15A, 3V	B-74			
70C05F	SIT	110A, 50V, 0.2A, 3V	B-74			
70C10	SIT	110A, 100V, 0.2A, 3V	F-91	ECG5570		
70C10B	SIT	110A, 100V, 0.15A, 3V	F-91	ECG5570		
70C10BF	SIT	110A, 100V, 0.15A, 3V	B-74	ECG5575		
70C10F	SIT	110A, 100V, 0.2A, 3V	B-74	ECG5575		
70C15	SIT	110A, 150V, 0.2A, 3V	F-91	ECG5570		
70C15B	SIT	110A, 150V, 0.15A, 3V	F-91	ECG5570		
70C15BF	SIT	110A, 150V, 0.15A, 3V	B-74	ECG5575		
70C15F	SIT	110A, 150V, 0.2A, 3V	B-74	ECG5575		
70C20	SIT	110A, 200V, 0.2A, 3V	F-91	ECG5570		
70C20B	SIT	110A, 200V, 0.15A, 3V	F-91	ECG5570		
70C20BF	SIT	110A, 200V, 0.15A, 3V	B-74	ECG5575		
70C20F	SIT	110A, 200V, 0.2A, 3V	B-74	ECG5575		
70C25	SIT	110A, 25V, 0.2A, 3V	F-91			
70C25B	SIT	110A, 25V, 0.15A, 3V	F-91			
70C25BF	SIT	110A, 25V, 0.15A, 3V	B-74			
70C25F	SIT	110A, 25V, 0.2A, 3V	B-74			
70C25	SIT	110A, 250V, 0.2A, 3V	F-91	ECG5572		
70C25B	SIT	110A, 250V, 0.05A, 3V	F-91	ECG5572		
70C25BF	SIT	110A, 250V, 0.15A, 3V	B-74	ECG5577		
70C25F	SIT	110A, 250V, 0.2A, 3V	B-74	ECG5577		
70C30	SIT	110A, 300V, 0.2A, 3V	F-91	ECG5572		
70C30B	SIT	110A, 300V, 0.15A, 3V	F-91	ECG5572		
70C30BF	SIT	110A, 300V, 0.15A, 3V	B-74	ECG5577		
70C30F	SIT	110A, 300V, 0.2A, 3V	B-74	ECG5577		
70C35	SIT	110A, 350V, 0.2A, 3V	F-91	ECG5572		
70C35B	SIT	110A, 350V, 0.15A, 3V	F-91	ECG5572		
70C35BF	SIT	110A, 350V, 0.15A, 3V	B-74	ECG5577		
70C35F	SIT	110A, 350V, 0.15A, 3V	B-74	ECG5577		



器件型号 Element type	厂名 Manufacturers	材料用途参数 Material Purpose Parameter	图号 Figure	国内外相似替换器件型号 Replace of similar type	备注 Notes	外形参考图 Reference shape
70C35F	SIT	110A, 350V, 0.2A, 3V	B-74	ECG5577		 图 B-74
70C40	SIT	110A, 400V, 0.2A, 3V	F-91	ECG5572		
70C40B	SIT	110A, 400V, 0.15A, 3V	F-91	ECG5572		
70C40BF	SIT	110A, 400V, 0.15A, 3V	B-74	ECG5577		
70C40F	SIT	110A, 400V, 0.2A, 3V	B-74	ECG5577		
70C45	SIT	110A, 450V, 0.2A, 3V	F-91	ECG5572		
70C45B	SIT	110A, 450V, 0.15A, 3V	F-91	ECG5572		
70C45BF	SIT	110A, 450V, 0.15A, 3V	B-74	ECG5577		
70C45F	SIT	110A, 450V, 0.2A, 3V	B-74	ECG5577		
70C50	SIT	110A, 50V, 0.1A, 3V	F-91			
70C50B	SIT	110A, 50V, 0.1A, 3V	F-91			
70C50BF	SIT	110A, 50V, 0.1A, 3V	B-74			
70C50F	SIT	110A, 50V, 0.1A, 3V	B-74			
70C50	SIT	110A, 500V, 0.2A, 3V	F-91	ECG5572		
70C50B, BF	SIT	110A, 500V, 0.15A, 3V	F-91	ECG5572		
70C50F	SIT	110A, 500V, 0.2A, 3V	B-74	ECG5577		
70C60	SIT	110A, 600V, 0.2A, 3V	F-91	FCG5579		
70C60B	SIT	110A, 600V, 0.15A, 3V	F-91	ECG5572		
70C60BF	SIT	110A, 600V, 0.15A, 3V	B-74	ECG5577		
70C60F	SIT	110A, 600V, 0.2A, 3V	B-74	ECG5577		
70C70	SIT	110A, 700V, 0.2A, 3V	F-91	ECG5574		
70C70B	SIT	110A, 700V, 0.15A, 3V	F-91	ECG5574		
70C70BF	SIT	110A, 700V, 0.15A, 3V	B-74	ECG5579		
70C70F	SIT	110A, 700V, 0.2A, 3V	B-74	ECG5579		
70C80	SIT	110A, 800V, 0.2A, 3V	F-91	ECG5574		
70C80B	SIT	110A, 800V, 0.15A, 3V	F-91	ECG5574		
70C80BF	SIT	110A, 800V, 0.15A, 3V	B-74	ECG5579		
70C80F	SIT	110A, 800V, 0.2A, 3V	B-74	ECG5579		
70C90	SIT	110A, 900V, 0.2A, 3V	F-91	ECG5574		







图 F-91

器件型号 Element type	厂名 Manufacturers	材料用途参数 Material Purpose Parameter	图号 Figure	国内外相似替换器件型号 Replacc of similar type	备注 Notes	外形参考图 Reference sr.apc
70C90B	SIT	110A, 900V, 0.15A, 3V	F-91	ECG5574		 图 F-91
70C90BF	SIT	110A, 900V, 0.15A, 3V	B-74	ECG5579		
70C90F	SIT	110A, 900V, 0.2A, 3V	B-74	ECG5579		
70C100	SIT	110A, 1kV, 0.2A, 3V	F-91	ECG5574		 图 B-74
70C100B	SIT	110A, 1kV, 0.15A, 3V	F-91	ECG5574		
70C100BF	SIT	110A, 1kV, 0.15A, 3V	B-74	ECG5579		
70C100F	SIT	110A, 1kV, 0.2A, 3V	B-74	ECG5579		
70C110	SIT	110A, 1.1kV, 0.2A, 3V	F-91	ECG5574		
70C110B	SIT	110A, 1.1kV, 0.15A, 3V	F-91	ECG5574		
70C110BF	SIT	110A, 1.1kV, 0.15A, 3V	B-74	ECG5579		
70C110F	SIT	110A, 1.1kV, 0.2A, 3V	B-74	ECG5579		
70C120	SIT	110A, 1.2kV, 0.2A, 3V	F-91	ECG5574		
70C120B	SIT	110A, 1.2kV, 0.15A, 3V	F-91	ECG5574		
70C120BF	SIT	110A, 1.2kV, 0.15A, 3V	B-74	ECG5579		
70C120F	SIT	110A, 1.2kV, 0.2A, 3V	B-74	ECG5579		
70C130	SIT	110A, 1.3kV, 0.1A, 3V	F-91	ECG5574		
70C130B	SIT	110A, 1.3kV, 0.1A, 3V	F-91	ECG5574		
70C130BF	SIT	110A, 1.3kV, 0.1A, 3V	B-74	ECG5579		
70C130F	SIT	110A, 1.3kV, 0.1A, 3V	B-74	ECG5579		
70C150	SIT	110A, 1.5kV, 0.1A, 3V	F-91	ECG5574		
70C150B	SIT	110A, 1.5kV, 0.1A, 3V	F-91	ECG5574		
70C150BF	SIT	110A, 1.5kV, 0.1A, 3V	B-74	ECG5579		
70C150F	SIT	110A, 1.5kV, 0.1A, 3V	B-74	ECG5579		
70C160	SIT	110A, 1.6kV, 0.1A, 3V	F-91	ECG5574		
70C160B	SIT	110A, 1.6kV, 0.1A, 3V	F-91	ECG5574		
70C160BF	SIT	110A, 1.6kV, 0.1A, 3V	B-74	ECG5579		
70C160F	SIT	110A, 1.6kV, 0.1A, 3V	B-74	ECG5579		
70C170	SIT	110A, 1.7kV, 0.1A, 3V	F-91	ECG5574		
70C170B	SIT	110A, 1.7kV, 0.1A, 3V	F-91	ECG5574		

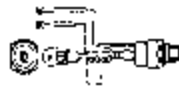
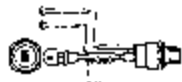

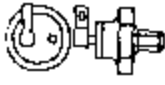
器件型号 Element type	厂名 Manufacturers	材料用途参数 Material Purpose Parameter	图号 Figure	国内外相似替换器件型号 Replace of similar type	备注 Notes	外形参考图 Reference shape	
70C170BF	SIT	110A, 1.7kV, 0.1A, 3V	B-74			 图 B-74	
70C170F	SIT	110A, 1.7kV, 0.1A, 3V	B-74				
70C180	SIT	110A, 1.8kV, 0.1A, 3V	F-91				
70C180B	SIT	110A, 1.8kV, 0.1A, 3V	F-91				
70C180BF	SIT	110A, 1.8kV, 0.1A, 3V	B-74				
70C180F	SIT	110A, 1.8kV, 0.1A, 3V	B-74				
70RIA10		110A, 100V	E-28			 图 F-91	
70RIA20		110A, 200V	E-28				
70RIA40		110A, 400V	E-28				
70RIA60		110A, 600V	E-28				
70RIA80		110A, 800V	E-28				
70RIA100		110A, 1kV	E-28				
70RIA120		110A, 1.2kV	E-28				
70TB1	HIN	355A, 100V, 0.3A	E-12				 图 E-28
70TB2	HIN	355A, 200V, 0.3A	E-12				
70TB3	HIN	355A, 300V, 0.3A	E-12				
70TB4	HIN	355A, 400V, 0.3A	E-12				
70TB5	HIN	355A, 500V, 0.3A	E-12				
70TB6	HIN	355A, 600V, 0.3A	E-12				
70TB7	HIN	355A, 700V, 0.3A	E-12				
70TB8	HIN	355A, 800V, 0.3A	E-12				
70TB9	HIN	355A, 900V, 0.3A	E-12				
70TB10	HIN	355A, 1kV, 0.3A	E-12				
70TB11	HIN	355A, 1.1kV, 0.3A	E-12				
70TB12	HIN	355A, 1.2kV, 0.3A	E-12				
70TB13	HIN	355A, 1.3kV, 0.3A	E-12				
70TB14	HIN	355A, 1.4kV, 0.3A	E-12				







图 E-12

器件型号 Element type	厂名 Manufacturers	材料用途参数 Material Purpose Parameter	图号 Figure	国内外相似替换器件型号 Replace of similar type	备注 Notes	外形参考图 Reference shape
70TB15	HIN	355A, 1.5kV, 0.3A	E-12			 图 E-12
70TB16	HIN	355A, 1.6kV, 0.3A	E-12			
70TB17	HIN	355A, 1.7kV, 0.3A	E-12			
70TB18	HIN	355A, 1.8kV, 0.3A	E-12			
70TB19	HIN	355A, 1.9kV, 0.3A	E-12			
70TB20	HIN	355A, 2kV, 0.3A	E-12			
71RA30	INR, INJ	70A, 300V, 0.15A, 2.5V	F-91			 图 F-91
71RA50	INR, INJ	70A, 500V, 0.15A, 2.5V	F-91	ECG5572		
71RA60	INR, INJ	70A, 600V, 0.15A, 2.5V	F-91	ECG5572		
71RA80	INR, INJ	70A, 800V, 0.15A, 2.5V	F-91	ECG5574		
71RA100	INR, INJ	70A, 1kV, 0.15A, 2.5V	F-91	ECG5574		
71RA110	INR, INJ	110A, 1.1kV, 0.15A, 2.5V	F-91	ECG5574		
71RA140	INR, INJ	70A, 1.4kV, 0.15A, 2.5V	F-91			
71RA150	INR, INJ	110A, 1.5kV, 0.15A, 2.5V	F-91			
71RA160	INR, INJ	110A, 1.6kV, 0.15A, 2.5V	F-91			
71RB50	INJ	70A, 500V, 0.15A, 2.5V	F-91	ECG5572		
71RB60	INJ	70A, 600V, 0.15A, 2.5V	F-91	ECG5572		
71RB80	INJ	110A, 800V, 0.15A, 2.5V	F-91	ECG5574		
71RB100	INJ	70A, 1kV, 0.15A, 2.5V	F-91	ECG5574		
71RB120	INJ	110A, 1.2kV, 0.15A, 2.5V	F-91	ECG5574		
71RB140	INJ	70A, 1.4kV, 0.15A, 2.5V	F-91			
71RB150	INJ	110A, 1.5kV, 0.15A, 2.5V	F-91			
71RB160	INJ	110A, 1.6kV, 0.15A, 2.5V	F-91			
71RC5A	INA, INJ	70A, 50V, 0.07A, 2.5V	F-91			 图 F-71
71RC10	INJ	110A, 100V, 0.07A, 2.5V	F-71			
71RC10A	INR, INJ	70A, 100V, 0.07A, 2.5V	F-91	ECG5570		
71RC10B	INR, INJ	70A, 100V, 0.07A, 2V	F-91			
71RC20	INJ	110A, 200V, 0.07A, 2.5V	F-71			

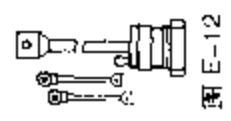
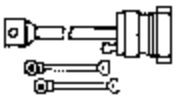

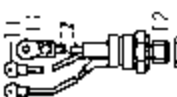
器件型号 Element type	厂名 Manufacturers	材料用途参数 Material Purpose Parameter	图号 Figure	国内外相似替换器件型号 Replace of similar type	备注 Notes	外形参考图 Reference shape
71RC20A	INR, INJ	70A, 200V, 0.07A, 2.5V	F-91	ECG5570		
71RC20B	INR, INJ	70, 200V, 0.07A, 2V	F-91			
71RC30	INJ	110A, 300V, 0.07A, 2.5V	F-71			
71RC30A	INR, INJ	70A, 300V, 0.07A, 2.5V	F-91	ECG5572		
71RC30B	INR, INJ	70A, 300V, 0.07A, 2V	F-91			
71RC40	INJ	110A, 400V, 0.07A, 2.5V	F-71			
71RC40A	INR, INJ	70A, 400V, 0.07A, 2.5V	F-91	ECG5572		
71RC40B	INR, INJ	70A, 400V, 0.07A, 2V	F-91			
71RC50	INJ	110A, 500V, 0.07A, 2.5V	F-71			
71RC50B	INR, INJ	70A, 500V, 0.07A, 2V	F-91			
71RC60	INJ	110A, 600V, 0.07A, 2.5V	F-71			
71RC60A	INR, INJ	70A, 600V, 0.07A, 2.5V	F-91	ECG55/2		
71RC60B	INR, INJ	70A, 600V, 0.07A, 2V	F-91			
71RC80	INJ	110A, 800V, 0.07A, 2.5V	F-71			
71RC80A	INR, INJ	70A, 800, 0.07A, 2.5V	F-91	ECG5574		
71RC100	INJ	110A, 1kV, 0.07A, 2.5V	F-71			
71RC100A	INR, INJ	110A, 1kV, 0.07A, 2.5V	B-74			
71RC110A	INR, INJ	110A, 1.1kV, 0.07A, 2.5V	B-74			
71RC120	INJ	110A, 1.2kV, 0.07A, 2.5V	F-71			
71RC120A	INR, INJ	110A, 1.2kV, 0.07A, 2.5V	B-74			
71REH60	INR, IN	70A, 600V, 0.15A, 2.5V	F-91	ECG5572		
71REH80	INR, INJ	70A, 800V, 0.15A, 2.5V	F-91	ECG5574		
71REH100	INR, INJ	70A, 1kV, 0.15A, 2.5V	F-91	ECG5574		
71REH110	INR, INJ	70A, 1.1kV, 0.15A, 2.5V	F-91	ECG5574		
71REH130	INR, INJ	70A, 1.3kV, 0.15A, 2.5V	F-91			
71RIA10	INR	70A, 100V, 0.1A, 2.5V	E-30			
71RIA20	INR	70A, 200V, 0.1A, 2.5V	E-30			
71RIA40	INR	70A, 400V, 0.1A, 2.5V	F-30			
71RIA60	INR	70A, 600V, 0.1A, 2.5V	E-30			

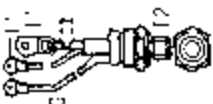
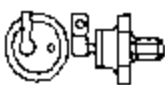
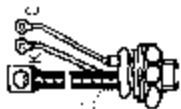
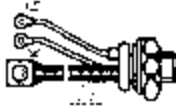
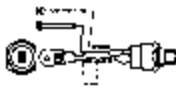
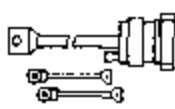
器件型号 Element type	厂名 Manufacturers	材料用途参数 Material Purpose Parameter	图号 Figure	国内外相似替换器作型号 Replace of similar type	备注 Notes	外形参考图 Reference shape	
71RIA80	INR	70A, 800V, 0.1A, 2.5V	E-30			 图 E-30	
71RIA100	INR	70A, 1kV, 0.1A, 2.5V	E-30				
71RIA110	INR	70A, 1.1kV, 0.1A, 2.5V	E-30				
71RIA120	INR	70A, 1.2kV, 0.15A, 2.5V	F-91				
71T20, 21	HIN	400A, 1.8kV, 0.4A	E-12			 图 F-91	
71T22, 23	HIN	400A, 1.9kV, 0.4A	E-12				
71T24, 25, 26	HIN	400A, 2kV, 0.4A	E-12				
71T27, 28	HIN	400A, 2.1kV, 0.4A	E-12				
71T29	HIN	400A, 2.2kV, 0.4A	E-12				
71T30, 31	HIN	400A, 2.3kV, 0.4A	E-12				
71T32	HIN	400A, 2.4kV, 0.4A	E-12				
71T33, 34	HIN	400A, 2.5kV, 0.4A	E-12				
71T35	HIN	400A, 2.6kV, 0.4A	E-12				
71T36, 37	HIN	400A, 2.7kV, 0.4A	E-12				
71T38	HIN	400A, 2.8kV, 0.4A	E-12				
71T39	HIN	400A, 2.9kV, 0.4A	E-12				
71T40	HIN	400A, 3kV, 0.4A	E-12				
71TB1	HIN	400A, 100V, 0.3A	E-12				 图 E-12
71TB2	HIN	400A, 200V, 0.3A	E-12				
71TB3	HIN	400A, 300V, 0.3A	E-12				
71TB4	HIN	400A, 400V, 0.3A	E-12				
71TB5	HIN	400A, 500V, 0.3A	E-12				
71TB6	HIN	400A, 600V, 0.3A	E-12				
71TB7	HIN	400A, 700V, 0.3A	E-12				
71TB8	HIN	400A, 800V, 0.3A	E-12				
71TB9	HIN	400A, 900V, 0.3A	E-12				
71TB10	HIN	400A, 1kV, 0.3A	E-12				
71TB11	HIN	400A, 1.1kV, 0.3A	E-12				



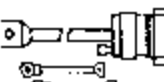

器件型号 Element type	厂名 Manufacturers	材料用途参数 Material Purpose Parameter	图号 Figure	国内外相似替换器件型号 Replace of similar type	备注 Notes	外形参考图 Reference shape
71TB12	HIN	400A, 1.2kV, 0.3A	E-12			
71TB13	HIN	400A, 1.3kV, 0.3A	E-12			
71TB14	HIN	400A, 1.4kV, 0.3A	E-12			
71TB15	HIN	400A, 1.5kV, 0.3A	E-12			
71TB16	HIN	400A, 1.6kV, 0.3A	E-12			
71TB17	HIN	400A, 1.7kV, 0.3A	E-12			
71TB18	HIN	400A, 1.8kV, 0.3A	E-12			
71TB19	HIN	400A, 1.9kV, 0.3A	E-12			
71TB20	HIN	400A, 2kV, 0.3A	E-12			
72RA30	INR, INJ	70A, 300V, 0.15A, 2.5V	B-74	EOG5577		图 E-12
72RA50	INR	110A, 500V, 0.15A, 2.5V	B-74	EOG5577		
72RA60	INR, INJ	110A, 600V, 0.15A, 2.5V	B-74	EOG5577		图 B-74
72RA80	INR, INJ	110A, 800V, 0.15A, 2.5V	B-74	EOG5579		
72RA100	INR, INJ	110A, 1kV, 0.15A, 2.5V	B-74	EOG579		
72RA150	INR, INJ	110A, 1.5kV, 0.15A, 2.5V	B-74			
72RA160	INR, INJ	110A, 1.6kV, 0.15A, 2.5V	B-74			
72RB50	INJ	110A, 500V, 0.15A, 2.5V	B-74	EOG5577		
72RB60	INJ	110A, 600V, 0.15A, 2.5V	B-74	EOG5577		
72RB80	INJ	110A, 800V, 0.15A, 2.5V	B-74	EOG5579		
72RB100	INJ	110A, 1kV, 0.15A, 2.5V	B-74	EOG5579		
72RB120	INJ	110A, 1.2kV, 0.15A, 2.5V	B-74	EOG5579		
72RB150	INJ	110A, 1.5kV, 0.15A, 2.5V	B-74			
72RB160	INJ	110A, 1.6kV, 0.15A, 2.5V	B-74			
72RC5A	INR, INJ	110A, 50V, 0.07A, 2.5V	B-74	EOG5575		
72RC10A	INR, INJ	70A, 100V, 0.07A, 2.5V	B-74			
72RC10B	INR, INJ	70A, 100V, 0.07A, 2V	B-74			
72RC20A	INR, INJ	70A, 200V, 0.07A, 2.5V	B-74	EOG5575		
72RC20B	INR, INJ	70A, 200V, 0.07A, 2V	B-74			

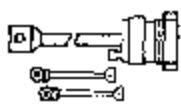

器件型号 Element type	厂名 Manufacturers	材料用途参数 Material Purpose Parameter	图号 Figure	国内外相似替换器件型号 Replace of similar type	备注 Notes	外形参考图 Reference shape
72RC30A	INR, INJ	70A, 300V, 0.07A, 2.5V	B-74	ECG5577		 图 B-74
72RC30B	INR, INJ	70A, 300V, 0.07A, 2V	B-74	ECG5577		
72RC40A	INR, INJ	70A, 400V, 0.07A, 2.5V	B-74	ECG5577		
72RC40B	INR, INJ	70A, 400V, 0.07A, 2V	B-74	ECG5577		
72RC50B	INR, INJ	70A, 500V, 0.07A, 2V	B-74	ECG5577		
72RC60A	INR, INJ	70A, 600V, 0.07A, 2.5V	B-74	ECG5579		
72RC60B	INR, INJ	70A, 600V, 0.07A, 2V	B-74	ECG5579		
72RC80A	INR, INJ	70A, 800V, 0.07A, 2.5V	B-74	ECG5579		
72RC100A	INJ	110A, 1kV, 0.07A, 2.5V	B-74			
72RC110A	INR, INJ	70A, 1.1kV, 0.07A, 2.5V	B-74			
72RC120A	INJ	110A, 1.2kV, 0.07A, 2.5V	B-74			
72REH60	INR, INJ	70A, 600V, 0.15A, 2.5V	B-74	ECG5577		
72REH80	INR, INJ	70A, 800V, 0.15A, 2.5V	B-74	ECG5579		
72REH100	INR, INJ	70A, 1kV, 0.15A, 2.5V	B-74	ECG5579		
72REH110	INR, INJ	70A, 1.1kV, 0.15A, 2.5V	B-74	ECG5579		
72REH130	INR, INJ	70A, 1.3kV, 0.15A, 2.5V	B-74			
72RIA10	INR	70A, 100V, 0.1A, 2.5V	F-65			
72RIA20	INR	70A, 200V, 0.1A, 2.5V	F-65			
72RIA40	INR	70A, 400V, 0.1A, 2.5V	F-65			
72RIA60	INR	70A, 600V, 0.1A, 2.5V	F-65			
72RIA80	INR	70A, 800V, 0.1A, 2.5V	F-65			
72RIA100	INR	70A, 1kV, 0.1A, 2.5V	F-65			
72RIA110	INR	70A, 1.1kV, 0.1A, 2.5V	F-65			
72RIA120	INR	70A, 1.2kV, 0.1A, 2.5V	F-65			
73T20, 21	HIN	430A, 1.8kV, 0.4A	E-12			 图 E-12
73T22, 23	HIN	430A, 1.9kV, 0.4A	E-12			
73T24, 25, 26	HIN	430A, 2kV, 0.4A	E-12			
73T27, 28	HIN	430A, 2.1kV, 0.4A	E-12			

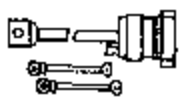
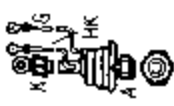



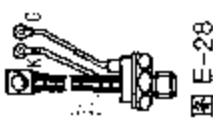

器件型号 Element type	厂名 Manufacturers	材料用途参数 Material Purpose Parameter	图号 Figure	国内外相似替换器件型号 Replace of similar type	备注 Notes	外形参考图 Reference shape
73TB29	HIN	430A, 2.2kV, 0.4A	E-12			 注: E-12
73TB30	HIN	430A, 2.3kV, 0.4A	E-12			
73TB1	HIN	430A, 100V, 0.3A	E-12			
73TB2	HIN	430A, 200V, 0.3A	E-12			
73TB3	HIN	430A, 300V, 0.3A	E-12			
73TB4	HIN	430A, 400V, 0.3A	E-12			
73TB5	HIN	430A, 500V, 0.3A	E-12			
73TB6	HIN	430A, 600V, 0.3A	E-12			
73TB7	HIN	430A, 700V, 0.3A	E-12			
73TB8	HIN	430A, 800V, 0.3A	E-12			
73TB9	HIN	430A, 900V, 0.3A	E-12			
73TB10	HIN	430A, 1kV, 0.3A	E-12			
73TB11	HIN	430A, 1.1kV, 0.3A	E-12			
73TB12	HIN	430A, 1.2kV, 0.3A	E-12			
73TB14	HIN	430A, 1.4kV, 0.3A	E-12			
73TB15	HIN	430A, 1.5kV, 0.3A	E-12			
73TB16	HIN	430A, 1.6kV, 0.3A	E-12			
73TB17	HIN	430A, 1.7kV, 0.3A	E-12			
73TB18	HIN	430A, 1.8kV, 0.3A	E-12			
73TB19	HIN	430A, 1.9kV, 0.3A	E-12			
73TB20	HIN	430A, 2kV, 0.3A	E-12			
74TB20, 21	HIN	470A, 1.8kV, 0.4A	E-12			
74TB22, 23	HIN	470A, 1.9kV, 0.4A	E-12			
74TB24, 25	HIN	470A, 2kV, 0.4A	E-12			
74TB1	HIN	470A, 100V, 0.3A	E-12			
74TB2	HIN	470A, 200V, 0.3A	E-12			
74TB3	HIN	470A, 300V, 0.3A	E-12			
74TB4	HIN	470A, 400V, 0.3A	E-12			

器件型号 Element type	厂名 Manufacturers	材料用途参数 Material Purpose Parameter	图号 Figure	国内外相似替换器件型号 Replace of similar type	备注 Notes	外形参考图 Reference shape
74TB5	HIN	470A, 500V, 0.3A	E-12			 图 E-12
74TB6	HIN	470A, 600V, 0.3A	E-12			
74TB7	HIN	470A, 700V, 0.3A	E-12			
74TB8	HIN	470A, 800V, 0.3A	E-12			
74TB9	HIN	470A, 900V, 0.3A	E-12			
74TB10	HIN	470A, 1kV, 0.3A	E-12			
74TB11	HIN	470A, 1.1kV, 0.3A	E-12			
74TB12	HIN	470A, 1.2kV, 0.3A	E-12			
74TB13	HIN	470A, 1.3kV, 0.3A	E-12			
74TB14	HIN	470A, 1.4kV, 0.3A	E-12			
74TB15	HIN	470A, 1.5kV, 0.3A	E-12			
74TB16	HIN	470A, 1.6kV, 0.3A	E-12			 图 F-83
74TB17	HIN	470A, 1.7kV, 0.3A	E-12			
74TB18	HIN	470A, 1.8kV, 0.3A	E-12			
74TB19	HIN	470A, 1.9kV, 0.3A	E-12			
74TB20	HIN	470A, 2kV, 0.3A	E-12			
80P1SP		80A, 100V	F-83			
80P2SP	LEJ	125A, 200V, 0.1A, 3.5V	F-83			
80P3SP	LEJ	125A, 300V, 0.1A, 3.5V	F-83			
80P4SP	LEJ	125A, 400V, 0.1A, 3.5V	F-83			
80P5SP	LEJ	125A, 500V, 0.1A, 3.5V	F-83			
80P6SP	LEJ	125A, 600V, 0.1A, 3.5V	F-83			
80P8SP	LEJ	125A, 800V, 0.1A, 3.5V	F-83			
80P10SP	LEJ	125A, 1kV, 0.1A, 3.5V	F-83			
80P12SP	LEJ	125A, 1.2kV, 0.1A, 3.5V	E-22			
80P16SP	LEJ	125A, 1.6kV, 0.1A, 3.5V	E-22			
80RIA10		125A, 100V	E-28			 图 E-28

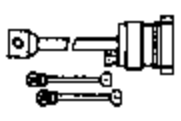

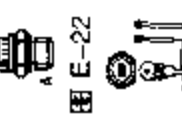
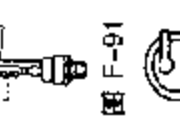
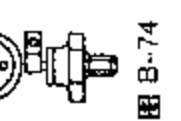
器件型号 Element type	厂名 Manufacturers	材料用途参数 Material Purpose Parameter	图号 Figure	国内外相似替换器件型号 Replacel of similar type	备注 Notes	外形参考图 Reference shape	
80RIA20		125A, 200V	E-28			 图 E-28	
80RIA40		125A, 400V	E-28				
80RIA60		125A, 600V	E-28				
80RIA80		125A, 800V	E-28				
80RIA100		125A, 1kV	E-28				
80RIA120		125A, 1.2kV	E-28				
80RK110		125A, 100V	E-28				
80RK120		125A, 200V	E-28				
80RK140		125A, 400V	E-28				
80RK160		125A, 600V	E-28				
80RK180		125A, 800V	E-28				
80RK1100		125A, 1kV	E-28				
80RK1120		125A, 1.2kV	E-28				
80S2SP	LEJ	125A, 200V, 0.1A, 3.5V	F-60			 图 F-60	
80S3SP	LEJ	125A, 300V, 0.1A, 3.5V	F-60				
80S4SP	LEJ	125A, 400V, 0.1A, 3.5V	F-60				
80S5SP	LEJ	125A, 500V, 0.1A, 3.5V	F-60				
80S6SP	LEJ	125A, 600V, 0.1A, 3.5V	F-60				
80S8SP	LEJ	125A, 800V, 0.1A, 3.5V	F-60				
80SS2SP	LEJ	125A, 200V, 0.1A, 3.5V	F-60				
80SS3SP	LEJ	125A, 300V, 0.1A, 3.5V	F-60				
80SS4SP	LEJ	125A, 400V, 0.1A, 3.5V	F-60				
80SS5SP	LEJ	125A, 500V, 0.1A, 3.5V	F-60				
80SS6SP	LEJ	125A, 600V, 0.1A, 3.5V	F-60				
80SS8SP	LEJ	125A, 800V, 0.1A, 3.5V	F-60				
80T20, 21	HIN	510A, 1.8kV, 0.4A	E-12				 图 E-12
80T22, 23	HIN	510A, 1.9kV, 0.4A	E-12				

器件型号 Element type	厂名 Manufacturers	材料用途参数 Material Purpose Parameter	图号 Figure	国内外相似替换器件型号 Replace of similar type	备注 Notes	外形参考图 Reference shape
80T24, 25	HIN	510A, 2kV, 0.4A	E-12			
80TB1	HIN	510A, 100V, 0.3A	E-12			
80TB2	HIN	510A, 200V, 0.3A	E-12			
80TB3	HIN	510A, 300V, 0.3A	E-12			
80TB4	HIN	510A, 400V, 0.3A	E-12			
80TB5	HIN	510A, 500V, 0.3A	E-12			
80TB6	HIN	510A, 600V, 0.3A	E-12			
80TB7	HIN	510A, 700V, 0.3A	E-12			
80TB8	HIN	510A, 800V, 0.3A	E-12			
80TB9	HIN	510A, 900V, 0.3A	E-12			
80TB10	HIN	510A, 1kV, 0.3A	E-12			
80TB11	HIN	510A, 1.1kV, 0.3A	E-12			
80TB12	HIN	510A, 1.2kV, 0.3A	E-12			
80TB13	HIN	510A, 1.3kV, 0.3A	E-12			
80TB14	HIN	510A, 1.4kV, 0.3A	E-12			
80TB15	HIN	510A, 1.5kV, 0.3A	E-12			
80TB16	HIN	510A, 1.6kV, 0.3A	E-12			
80TB17	HIN	510A, 1.7kV, 0.3A	E-12			
80TB18	HIN	510A, 1.8kV, 0.3A	E-12			
80TB19	HIN	510A, 1.9kV, 0.3A	E-12			
80TB20	HIN	510A, 2kV, 0.3A	E-12			
80TO-220SP		80A, 1kV	F 83			
81RDT100M	INR	80A, 1kV, 0.6A, 0.8V	E-22			
81RDT120M	INR	80A, 1.2kV, 0.8A, 0.8V	E-22			
81RK10	INR	80A, 100V, 0.15A, 2.5V	F-91			
81RK10M	INR	80A, 100V, 0.15A, 2.5V	B-74			
81RK20	INR	80A, 200V, 0.15A, 2.5V	F-91			
81RK20M	INR	80A, 200V, 0.15A, 2.5V	B-74			

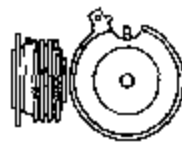

器件型号 Element type	厂名 Manufacturers	材料用途参数 Material Purpose Parameter	图号 Figure	国内外和似替换器件型号 Replace of similar type	备注 Notes	外形参考图 Reference shape
81RK40	INR	80A, 400V, 0.15A, 2.5V	C-11			 图 C-11
81RK40M	INR	80A, 400V, 0.15A, 2.5V	B-74			
81RK60	INR	80A, 600V, 0.15A, 2.5V	F-91			
81RK60M	INR	80A, 600V, 0.15A, 2.5V	B-74			
81RK60#	INR	80A, 800V, 0.15A, 2.5V	F-91			
81RK80M	INR	125A, 800V, 0.15A, 2.5V	F-71			
81RK100#	INR	80A, 1kV, 0.15A, 2.5V	F-91			
81RK120#	INR	80A, 1.2kV, 0.15A, 2.5V	F-91			
81RK120M	INR	125A, 1.2kV, 0.15A, 2.5V	B-74			
81RK160	INR, INN	125A, 1.6kV, 0.15A, 2.5V	B-74			
81RK160M	INR	125A, 1.6kV, 0.15A, 2.5V	B-74			
81RL10	INR	80A, 100V, 0.15A, 2.5V	E-10	ECG5371		
81RL20	INR	80A, 200V, 0.15A, 2.5V	E-10	ECG5371		
81RL30	INR	80A, 300V, 0.15A, 2.5V	E-10	ECG5371		
81RL40	INR	80A, 400V, 0.15A, 2.5V	E-10	ECG5371		
81RL50	INR, INJ	80A, 500V, 0.15A, 2.5V	E-10	ECG5371		
81RL60	INR, INJ	80A, 600V, 0.15A, 2.5V	E-10	ECG5371		
81RL80	INR, INJ	80A, 800V, 0.15A, 2.5V	E-10	ECG5372		
81RL100	INR, INJ	80A, 1kV, 0.15A, 2.5V	E-10	ECG5372		
81RL110	INR, INJ	80A, 1.1kV, 0.15A, 2.5V	E-10	ECG5372		
81RL120	INR, INJ	80A, 1.2kV, 0.15A, 2.5V	E-10	ECG5372		
81RLA60	INR, INJ	80A, 600V, 0.15A, 3V	F-91	ECG5372		
81RLA80	INR, INJ	80A, 800V, 0.15A, 3V	F-91	ECG5374		
81RLA100	INR, INJ	80A, 1kV, 0.15A, 3V	F-91	ECG5374		
81RLA120	INR, INJ	80A, 1.2kV, 0.15A, 3V	F-91	ECG5374		
81RLA150	INR, INJ	80A, 1.5kV, 0.15A, 3V	F-91			
81RLA160	INR, INJ	80A, 1.6kV, 0.15A, 3V	F-91			
81RLB50	INR, INJ	80A, 500V, 0.15A, 2.5V	E-10	ECG571		
81RLB60	INR, INJ	80A, 600V, 0.15A, 2.5V	E-10	ECG571		



图 F-91



图 E-10



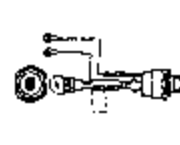

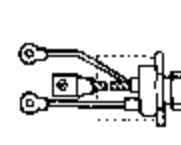

图 B-74

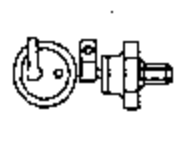
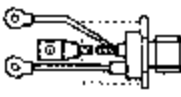
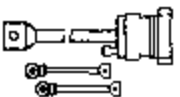

器件型号 Element type	厂名 Manufacturers	材料用途参数 Material Purpose Parameter	图号 Figure	国内外相似替换器件型号 Replacc of similar type	备注 Notes	外形参考图 Reference shape	
81RLB80	INR, INJ	80A, 800V, 0.15A, 2.5V	E-10	ECG572		 图 E-10	
81RLB100	INR, INJ	80A, 1kV, 0.15A, 2.5V	E-10	ECG572			
81RLB110	INR, INJ	80A, 1.1kV, 0.15A, 2.5V	E-10	ECG572			
81RLB120	INR, INJ	80A, 1.2kV, 0.15A, 2.5V	E-10	ECG572			
81RM10	INR, INJ	80A, 100V, 0.15A, 2.5V	E-10	ECG5371			
81RM20	INR, INJ	80A, 200V, 0.15A, 2.5V	E-10	ECG5371			
81RM30	INR, INJ	80A, 300V, 0.15A, 2.5V	E-10	ECG5371			
81RM40	INR, INJ	80A, 400V, 0.15A, 2.5V	E-10	ECG5371			
81RM50	INR, INJ	80A, 500V, 0.15A, 2.5V	E-10	ECG5371			
81RM60	INR, INJ	80A, 600V, 0.15A, 2.5V	E-10	ECG5371			
81RM70	INR	125A, 700V, 0.15A, 3V	E-10	ECG5372			
81RM80	INR, INJ	80A, 800V, 0.15A, 2.5V	E-10	ECG5372			
81RM90	INR	125A, 900V, 0.15A, 3V	E-10	ECG5372			
81RM100	INR, INJ	80A, 1kV, 0.15A, 2.5V	E-10	ECG5372			
81TB20, 21	HIN	550A, 1.8kV, 0.4A	E-12				 图 E-12
81TB22, 23	HIN	550A, 1.9kV, 0.4A	E-12				
81TB24, 25	HIN	550A, 2kV, 0.4A	E-12				
81TB1	HIN	550A, 100V, 0.3A	E-12				
81TB2	HIN	550A, 200V, 0.3A	E-12				
81TB3	HIN	550A, 300V, 0.3A	E-12				
81TB4	HIN	550A, 400V, 0.3A	E-12				
81TB5	HIN	550A, 500V, 0.3A	E-12				
81TB6	HIN	550A, 600V, 0.3A	E-12				
81TB7	HIN	550A, 700V, 0.3A	E-12				
81TB8	HIN	550A, 800V, 0.3A	E-12				
81TB9	HIN	550A, 900V, 0.3A	E-12				
81TB10	HIN	550A, 1kV, 0.3A	E-12				
81TB11	HIN	550A, 1.1kV, 0.3A	E-12				



器件型号 Element type	厂名 Manufacturers	材料用途参数 Material Purpose Parameter	图号 Figure	国内外相似替换器件型号 Replace of similar type	备注 Notes	外形参考图 Reference shape
81TB12	HIN	550A, 1.2kV, 0.3A	E-12			
81TB13	HIN	550A, 1.3kV, 0.3A	E-12			
81TB14	HIN	550A, 1.4kV, 0.3A	E-12			
81TB15	HIN	550A, 1.5kV, 0.3A	E-12			
81TB16	HIN	550A, 1.6kV, 0.3A	E-12			
81TB17	HIN	550A, 1.7kV, 0.3A	E-12			
81TB18	HIN	550A, 1.8kV, 0.3A	E-12			
81TB19	HIN	550A, 1.9kV, 0.3A	E-12			
81TB20	HIN	550A, 2kV, 0.3A	E-12			
82RL10	INR	80A, 100V, 0.06A, 1.6V	B-74	ECG5368		图 E-12
82RL20	INR	80A, 200V, 0.06A, 1.6V	B-74	ECG5368		
82RL30	INR	80A, 300V, 0.06A, 1.6V	B-74	ECG5368		图 B-74
82RL40	INR	80A, 400V, 0.06A, 1.6V	B-74	ECG5368		
82RL50	INR, INJ	80A, 500V, 0.06A, 3V	B-74	ECG5368		
82RL60	INR, INJ	80A, 600V, 0.06A, 3V	B-74	ECG5368		
82RL80	INR	80A, 800V, 0.06A, 3V	B-74	ECG5369		
82RL100	INR, INJ	80A, 1kV, 0.06A, 3V	B-74	ECG5369		
82RL110	INR	80A, 1.1kV, 0.06A, 3V	B-74	ECG5369		
82RL120	INR, INJ	80A, 1.2kV, 0.06A, 3V	B-74	ECG5369		
82RLA50	INJ	125A, 500V, 0.15A, 3V	B-74	ECG5577		
82RLA60	INR, INJ	80A, 600V, 0.15A, 3V	B-74	ECG5577		
82RLA80	INR, INJ	80A, 800V, 0.15A, 3V	B-74	ECG5579		
82RLA100	INR, INJ	80A, 1kV, 0.15A, 3V	B-74	ECG5579		
82RLA110	INJ	125A, 1.1kV, 0.15A, 3V	B-74	ECG5579		
82RLA120	INR, INJ	80A, 1.2kV, 0.15A, 3V	B-74	ECG5579		
82RLA130	INR, INJ	80A, 1.3kV, 0.15A, 3V	B-74	ECG5579		
82RLA150	INR	80A, 1.5kV, 0.15A, 3V	B-74	ECG5579		
82RLA160	INR	80A, 1.6kV, 0.15A, 3V	B-74	ECG5579		



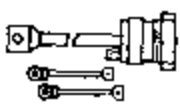

器件型号 Element type	厂名 Manufacturers	材料用途参数 Material Purpose Parameter	图号 Figure	国内外相似替换器件型号 Replace of similar type	备注 Notes	外形参考图 Reference shape
82RLB50	INR, INJ	80A, 500V, 0.15A, 3V	B-74	ECG5368		 图 B-74
82RLB60	INR, INJ	80A, 600V, 0.15A, 3V	B-74	ECG5368		
82RLB80	INR, INJ	80A, 800V, 0.15A, 3V	B-74	ECG5369		
82RLB100	INR, INJ	80A, 1kV, 0.15A, 3V	B-74	ECG5369		
82RLB110	INR, INJ	80A, 1.1kV, 0.15A, 3V	B-74	ECG5369		
82RLB120	INR, INJ	80A, 1.2kV, 0.15A, 3V	B-74	ECG5369		
82RM10	INR, INJ	80A, 100V, 0.15A, 3V	B-74	ECG5368		
82RM20	INR, INJ	80A, 200V, 0.15A, 3V	B-74	ECG5368		
82RM30	INR, INJ	80A, 300V, 0.15A, 3V	B-74	ECG5368		
82RM40	INR, INJ	80A, 400V, 0.15A, 3V	B-74	ECG5368		
82RM50	INR, INJ	80A, 500V, 0.15A, 3V	B-74	ECG5368		
82RM60	INR, INJ	80A, 600V, 0.15A, 3V	B-74	ECG5368		
82RM70	INR, INJ	125A, 700V, 0.15A, 3V	B-74	ECG5368		
82RM80	INR, INJ	80A, 800V, 0.15A, 3V	B-74	ECG5369		
82RM90	INR	125A, 900V, 0.15A, 3V	B-74	ECG5369		
82RM100	INR, INJ	80A, 1kV, 0.15A, 3V	B-74	ECG5369		
84RDT100M	INR	80A, 1kV, 0.8A, 0.8V	E-21			 图 E-21
84RDT120M	INR	80A, 1.2kV, 0.8A, 0.8V	E-21			
84TB1	HIN	605A, 100V, 0.25A	F-60			 图 F-60
84TB2	HIN	605A, 200V, 0.25A	F-60			
84TB3	HIN	605A, 300V, 0.25A	F-60			
84TB4	HIN	605A, 400V, 0.25A	F-60			
84TB5	HIN	605A, 500V, 0.25A	F-60			
84TB6	HIN	605A, 600V, 0.25A	F-60			
84TB7	HIN	605A, 700V, 0.25A	F-60			
84TB8	HIN	805A, 800V, 0.25A	F-60			
84TB9	HIN	605A, 900V, 0.25A	F-60			

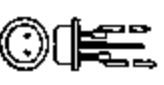

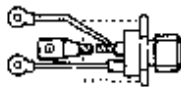

器件型号 Element type	厂名 Manufacturers	材料用途参数 Material Purpose Parameter	图号 Figure	国内外相似替换器件型号 Replace of similar type	备注 Notes	外形参考图 Reference shape
84TB11	HIN	605A, 1.1kV, 0.25A	F-60			 图 F-60
84TB12	HIN	605A, 1.2kV, 0.25A	F-60			
84TB13	HIN	605A, 1.3kV, 0.25A	F-60			
84TB14	HIN	605A, 1.4kV, 0.25A	F-60			
84TB15	HIN	505A, 1.5kV, 0.3A	E-12			
88RLD10	SCR-H	80A, 100V	F-84			 图 F-12
88RLD20	SCR-H	80A, 200V	F-84			
88RLD30	SCR-H	80A, 300V	F-84			
88RLD40	SCR-H	80A, 400V	F-84			
88RLE10	SCR-H	80A, 100V	F-84			
88RLE20	SCR-H	80A, 200V	F-84			
88RLE30	SCR-H	80A, 300V	F-84			
88RLE40	SCR-H	80A, 400V	F-84			
88RLE50	SCR-H	80A, 200V	F-84			
88RLE60	SCR-H	80A, 300V	F-84			
88RLE80	SCR-H	80A, 400V	F-84			
88RLF60	SCR-H	80A, 300V	F-84			
88RLF80	SCR-H	80A, 400V	F-84			
88RLG100	SCR-H	80A, 1kV	F-84			
88RLG120	SCR-H	80A, 1.2kV	F-84			
88RLH100	SCR-H	80A, 1kV	F-84			
88RLH120	SCR-H	80A, 1.2kV	F-84			
88RP10	SCR-H	80A, 100V	F-84			 图 F-84
88RP20	SCR-H	80A, 200V	F-84			
88RP30	SCR-H	80A, 300V	F-84			
88RP40	SCR-H	80A, 400V	F-84			
88RP50	SCR-H	80A, 500V	F-84			
88RP60	SCR-H	80A, 600V	F-84			

器件型号 Element type	厂名 Manufacturers	材料用途参数 Material Purpose Parameter	图号 Figure	国内外相似替换器件型号 Replace of similar type	备注 Notes	外形参考图 Reference shape
88RP80		80A, 800V	F-84			
88RS100		80A, 1kV	F-84			
88RS120		80A, 1.2kV	F-84			
88RS140		80A, 1.4kV	F-84			
88RS160		80A, 1.6kV	F-84			
88RW30		80A, 300V	F-84			
88RW40		80A, 400V	F-84			
91MT80K	SCB	3PH, 90A, 800V	B-70			
91MT100K	SCB	3PH, 90A, 1kV	B-70			
91MT120K	SCB	3PH, 90A, 1.2kV	B-70			
91MT140K	SCB	3PH, 90A, 1.4kV	R-70			
91MT160K	SCB	3PH, 90A, 1.6kV	B-70			
91RC5	INR, INJ	90A, 50V, 0.1A, 2V	F-91	ECG5570		
91RC10	INR, INJ	90A, 100V, 0.1A, 2V	F-91	ECG5570		
91RC20	INR, INJ	90A, 200V, 0.1A, 2V	F-91	ECG5570		
91RC30	INR, INJ	90A, 300V, 0.1A, 2V	F-91	ECG5572		
91RC40	INR, INJ	90A, 400V, 0.1A, 2V	F-91	ECG5572		
91RC60	INR, INJ	90A, 600V, 0.1A, 2V	F-91	ECG5572		
91RC80	INR, INJ	90A, 800V, 0.1A, 2V	F-91	ECG5574		
91RC100	INR, INJ	90A, 1kV, 0.1A, 2V	F-91	ECG5574		
91RC110	INR, INJ	90A, 1.1kV, 0.1A, 2V	F-91	ECG5574		
91RC120	INR, INJ	90A, 1.2kV, 0.1A, 2V	F-91	ECG5574		
91RL10	INR, INJ	95A, 100V, 0.15A, 2.5V	E-10			
91RL20	INR, INJ	95A, 200V, 0.15A, 2.5V	E-10			
91RL30	INR, INJ	95A, 300V, 0.15A, 2.5V	E-10			
91RL40	INR, INJ	95A, 400V, 0.15A, 2.5V	E-10			
91RL50	INR, INJ	95A, 500V, 0.15A, 2.5V	E-10			
91RL60	INR, INJ	95A, 600V, 0.15A, 2.5V	E-10			

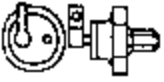

器件型号 Element type	厂名 Manufacturers	材料用途参数 Material Purpose Parameter	图号 Figure	国内外相似替换器件型号 Replace of similar type	备注 Notes	外形参考图 Reference shape
91RM10	INR, INJ	95A, 100V, 0.15A	E-10			
91RM20	INR, INJ	95A, 200V, 0.15A	E-10			
91RM30	INR, INJ	95A, 300V, 0.15A	E-10			
91RM40	INR, INJ	95A, 400V, 0.15A	E-10			
91RM50	INR, INJ	95A, 500V, 0.15A	E-10			
91RM60	INR, INJ	95A, 600V, 0.15A	E-10			
91TB1	HIN	655A, 100V, 0.25A	F-60			
91TB2	HIN	655A, 200V, 0.25A	F-60			
91TB3	HIN	655A, 300V, 0.25A	F-60			
91TB4	HIN	655A, 400V, 0.25A	F-60			
91TB5	HIN	655A, 500V, 0.25A	F-60			
91TB6	HIN	655A, 600V, 0.25A	F-60			
91TB7	HIN	655A, 700V, 0.25A	F-60			
91TB8	HIN	655A, 800V, 0.25A	F-60			
91TB9	HIN	655A, 900V, 0.25A	F-60			
91TB10	HIN	655A, 1kV, 0.25A	F-60			
91TB11	HIN	655A, 1.1kV, 0.25A	F-60			
91TB12	HIN	655A, 1.2kV, 0.25A	F-60			
92MT80K		SCB	B-70			
92MT100K		SCB	B-70			
92MT120K		SCB	B-70			
92MT140K		SCB	B-70			
92MT160K		SCB	B-70			
92RC10	INR, INJ	90A, 100V, 0.1A, 2V	B-74			
92RC20	INR, INJ	90A, 200V, 0.1A, 2V	B-74			
92RC30	INR, INJ	90A, 300V, 0.1A, 2V	B-74			

器件型号 Element type	厂名 Manufacturers	材料用途参数 Material Purpose Parameter	图号 Figure	国内外相似替换器型号 Replaco of similar type	备注 Notes	外形参考图 Reference shape
92RC40	INR, INJ	90A, 400V, 0.1A, 2V	B-74			 图 B-74
92RC60	INR, INJ	90A, 600V, 0.1A, 2V	B-74			
92RC80	INR, INJ	90A, 600V, 0.1A, 2V	B-74			
92RC100	INR, INJ	90A, 1kV, 0.1A, 2V	B-74			
92RC110	INR, INJ	90A, 1.1kV, 0.1A, 2V	B-74			
92RC120	INR, INJ	90A, 1.2kV, 0.1A, 2V	B-74			
92RL10	INR, INJ	95A, 100V, 0.15A, 3V	B-74			
92RL20	INR, INJ	95A, 200V, 0.15A, 3V	B-74			
92RL30	INR, INJ	95A, 300V, 0.15A, 3V	B-74			
92RL40	INR, INJ	95A, 400V, 0.15A, 3V	B-74			
92RL50	INR, INJ	95A, 500V, 0.15A, 3V	B-74			
92RL60	INR, INJ	95A, 600V, 0.15A, 3V	B-74			
92RM10	INR, INJ	95A, 100V, 0.15A, 3V	B-74			 图 B-70
92RM20	INR, INJ	95A, 200V, 0.15A, 3V	B-74			
92RM30	INR, INJ	95A, 300V, 0.15A, 3V	B-74			
92RM40	INR, INJ	95A, 400V, 0.15A, 3V	B-74			
92RM50	INR, INJ	95A, 500V, 0.15A, 3V	B-74			
92RM60	INR, INJ	95A, 600V, 0.15A, 3V	B-74			
93MT80K		SCB 3PH, 90A, 800V	B-70			
93MT100K		SCB 3PH, 90A, 1kV	B-70			
93MT120K		SCB 3PH, 90A, 1.2kV	B-70			
93MT140K		SCB 3PH, 90A, 1.4kV	B-70			
93MT160K		SCB 3PH, 90A, 1.6kV	B-70			
94MT80K		SCB 3PH, 90A, 800V	B-71			
94MT100K		SCB 3PH, 90A, 1kV	B-71			
94MT120K		SCB 3PH, 90A, 1.2kV	B-71			
94MT140K		SCB 3PH, 90A, 1.4kV	B-71			





器件型号 Element type	厂名 Manufacturers	材料用途参数 Material Purpose Parameter	图号 Figure	国内外相似替换器件型号 Replace of similar type	备注 Notes	外形参考图 Reference shape
94MT150K	SCB	3PH, 90A, 1.6kV	B-71			 图 B-71
94TB1	HIN	725A, 100V, 0.25A	F-60			
94TB2	HIN	725A, 200V, 0.25A	F-60			
94TB3	HIN	725A, 300V, 0.25A	F-60			
94TB4	HIN	725A, 400V, 0.25A	F-60			
94TB5	HIN	725A, 500V, 0.25A	F-60			
94TB6	HIN	725A, 600V, 0.25A	F-60			
94TB7	HIN	725A, 700V, 0.25A	F-60			
94TB8	HIN	725A, 800V, 0.25A	F-60			
94TB9	HIN	725A, 900V, 0.25A	F-60			
94TB10	HIN	725A, 1kV, 0.25A	F-60			
100C05	SIT	160A, 50V, 0.15A, 3V	F-91	ECG5580		
100C10	SIT	160A, 100V, 0.15A, 3V	F-91	ECG5580		
100C15	SIT	160A, 150V, 0.15A, 3V	F-91	ECG5580		
100C20	SIT	160A, 200V, 0.15A, 3V	F-91	ECG5580		
100C25	SIT	160A, 25V, 0.15A, 3V	F-91	ECG5582		
100C25	SIT	160A, 250V, 0.15A, 3V	F-91	ECG5582		
100C30	SIT	160A, 300V, 0.15A, 3V	F-91	ECG5582		
100C35	SIT	160A, 350V, 0.15A, 3V	F-91	ECG5582		
100C40	SIT	160A, 400V, 0.15A, 3V	F-91	ECG5582		
100C45	SIT	160A, 450V, 0.15A, 3V	F-91	ECG5582		
100C50	SIT	160A, 500V, 0.15A, 3V	F-91	ECG5582		
100C60	SIT	160A, 600V, 0.15A, 3V	F-91	ECG5584		
100C70	SIT	160A, 700V, 0.15A, 3V	F-91	ECG5584		
100C80	SIT	160A, 800V, 0.15A, 3V	F-91	ECG5584		
100C90	SIT	160A, 900V, 0.15A, 3V	F-91	ECG5584		
100C90B	SIT	160A, 900V, 0.15A, 3V	F-91	ECG5584		



图 F-60

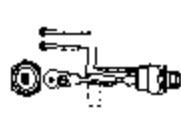
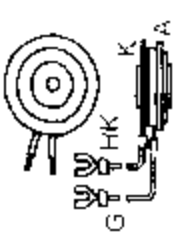

图 F-01

器件型号 Element type	厂名 Manufacturers	材料用途参数 Material Purpose Parameter	图号 Figure	国内外相似替换器件型号 Replace of similar type	备注 Notes	外形参考图 Reference shape
100C100	SIT	160A, 1kV, 0.15A, 3V	F-91	ECG5584		 <p>图 F-91</p>  <p>图 C-70</p>  <p>图 F-89</p>
100C110	SIT	160A, 1.1kV, 0.15A, 3V	F-91	ECG5584		
100C120	SIT	160A, 1.2kV, 0.15A, 3V	F-91	ECG5584		
100C130	SIT	160A, 1.3kV, 0.15A, 3V	F-91			
100C150	SIT	160A, 1.5kV, 0.15A, 3V	F-91			
100C160	SIT	160A, 1.6kV, 0.15A, 3V	F-91			
100C170	SIT	160A, 1.7kV, 0.15A, 3V	F-91			
100C180	SIT	160A, 1.8kV, 0.15A, 3V	F-91			
100P4H	NEJ	157A, 400V, 0.15A, 3V	C 70			
100P6H	NEJ	157A, 600V, 0.15A, 3V	C-70			
100P8H	NEJ	157A, 800V, 0.15A, 3V	C-70			
100P10H	NEJ	157A, 1kV, 0.15A, 3V	C-70			
100P12H	NEJ	157A, 1.2kV, 0.15A, 3V	C-70			
100P16H	NEJ	157A, 1.6kV, 0.15A, 3V	C-70			
100S5SP	NEJ	157A, 500V, 0.2A, 3V	F-89			
100S10SP	NEJ	157A, 1kV, 0.2A, 3V	F-89			
100S12SP	NEJ	157A, 1.2kV, 0.2A, 3V	F-89			
100SS5SP	NEJ	157A, 500V, 0.2A, 3V	F-89			
100SS6SP	NEJ	157A, 600V, 0.2A, 3V	F-89			
100SS10SP	NEJ	157A, 1kV, 0.2A, 3V	F-89			
100SS12SP	NEJ	157A, 1.2kV, 0.2A, 3V	F-89			
101RA50	SST	160A, 500V, 0.25A, 2.5V	F-91	ECG5582		
101RA60	SST	160A, 600V, 0.25A, 2.5V	F-91	ECG5582		
101RA80	SST	160A, 800V, 0.25A, 2.5V	F-91	ECG5584		
101RA100	SST	160A, 1kV, 0.25A, 2.5V	F-91	ECG5584		
101RA110	SST	160A, 1.1kV, 0.25A, 2.5V	F-91	ECG5584		







器件型号 Element type	厂名 Manufacturers	材料用途参数 Material Purpose Parameter	图号 Figure	国内外相似替换器件型号 Replace of similar type	备注 Notes	外形参考图 Reference shape
101RA130	SST	160A, 1.3kV, 0.25A, 2.5V	F-91			
101RC10	SST	160A, 100V, 0.15A, 2.5V	F-91	ECG5580		
101RC20	SST	160A, 200V, 0.15A, 2.5V	F-91	ECG5580		
101RC30	SST	160A, 300V, 0.15A, 2.5V	F-91	ECG5582		
101RC40	SST	160A, 400V, 0.15A, 2.5V	F-91	ECG5582		
101RC50	SST	160A, 500V, 0.15A, 2.5V	F-91	ECG5582		
101RC60	SST	160A, 600V, 0.15A, 2.5V	F-91	ECG5582		
101RC80	SST	160A, 800V, 0.15A, 2.5V	F-91	ECG5582		
101RC120	SST	160A, 1.2kV, 0.15A, 3.5V	F-71	ECG5584		
103PA100		100A, 1kV	C-35			
103PA120		100A, 1.2kV	C-35			
103PA140		100A, 1.4kV	C-35			
103PA180		100A, 1.6kV	C-35			
103PLE20	SCR-H	100A, 200V	C-35			
103PLE30	SCR-H	100A, 300V	C-35			
103PLE40	SCR-H	100A, 400V	C-35			
103PLE60	SCR-H	100A, 600V	C-35			
103PLE80	SCR-H	100A, 800V	C-35			
103PLG100	SCR-H	100A, 1kV	C-35			
103PLG120	SCR-H	100A, 1.2kV	C-35			
103PLH100	SCR-H	100A, 1kV	C-35			
103PLH120	SCR-H	100A, 1.2kV	C-35			
104MTB0K	SCB	3PH, 100A, 800V	B-71			
104MT100K	SCB	3PH, 100A, 1kV	B-71			
104MT120K	SCB	3PH, 100A, 1.2kV	B-71			
104MT140K	SCB	3PH, 100A, 1.4kV	B-71			
104MT160K	SCB	3PH, 100A, 1.6kV	B-71			









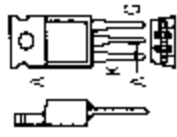
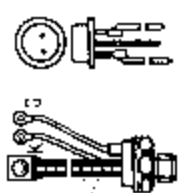
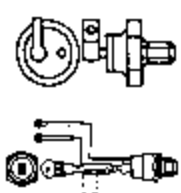



图 C-35

图 B-71

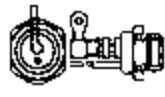

器件型号 Element type	厂名 Manufacturers	材料用途参数 Material Purpose Parameter	图号 Figure	国内外相似替换器型号 Replace of similar type	备注 Notes	外形参考图 Reference shape
108RLE10		100A, 100V	B-91			 图 B-91 图 F-84
108RLE20		100A, 200V	B-91			
108RLE30		100A, 300V	B-91			
108RLE40		100A, 400V	B-91			
108RP-10		100A, 100V	F-84			
108RP-20		100A, 200V	F-84			
108RP-30		100A, 300V	F-84			
108RP-40		100A, 400V	F-84			
108RP-50		100A, 500V	F-84			
108RP-60		100A, 600V	F-84			
108RP-80		100A, 800V	F-84			
110RK10		172A, 100V	E-28			 图 E-28 图 B-70
110RK120		172A, 200V	E-28			
110RK140		172A, 400V	E-28			
110RK160		172A, 600V	E-28			
110RK180		172A, 800V	E-28			
110RK100		172A, 1kV	E-28			
110RK120		172A, 1.2kV	E-28			
111MT80K	SCB	3PH, 110A, 800V	B-70			
111MT100K	SCB	3PH, 110A, 1kV	B-70			
111MT120K	SCB	3PH, 110A, 1.2kV	B-70			
111MT140K	SCB	3PH, 110A, 1.4kV	B-70			
111MT160K	SCB	3PH, 110A, 1.6kV	B-70			
111RK10	INR	100A, 100V, 0.15A, 2.5V	F-91			 图 F-91 图 B-74
111RK10M	INR	100A, 100V, 0.15A, 2.5V	B-74			
111RK20	INR	100A, 200V, 0.15A, 2.5V	F-91			



其他

器件型号 Element type	厂名 Manufacturers	材料用途参数 Material Purpose Parameter	图号 Figure	国内外相似替换器件型号 Replace of similar type	备注 Notes	外形参考图 Reference shape	
111RK20M	INR	100A, 200V, 0.15A, 2.5V	B-74			 图 B-74	
111RK40	INR	100A, 400V, 0.15A, 2.5V	F-91				
111RK40M	INR	100A, 400V, 0.15A, 2.5V	B-74				
111RK60	INR	100A, 600V, 0.15A, 2.5V	F-91				
111RK60M	INR	100A, 600V, 0.15A, 2.5V	B-74				
111RK80	INR	170A, 800V, 0.15A, 2.5V	F-91				
111RK80M	INR	170A, 800V, 0.15A, 2.5V	B-74				
111RK100	INR	170A, 1kV, 0.15A, 2.5V	F-91				
111RK100M	INR	170A, 1kV, 0.15A, 2.5V	B-74				
111RK120	INR	170A, 1.2kV, 0.15A, 2.5V	F-91				
111RK120M	INR	170A, 1.2kV, 0.15A, 2.5V	B-74				
111RLA60	INU	110A, 600V, 0.15A, 3V	F-91				 图 F-91
111RLA80	INU	110A, 800V, 0.15A, 3V	F-91				
111RLA100	INU	110A, 1kV, 0.15A, 3V	F-91				
111RLA120	INU	110A, 1.2kV, 0.15A, 3V	F-91				
112MT80K		SCB 3PH, 110A, 800V	B-70				
112MT100K		SCB 3PH, 110A, 1kV	B-70				
112MT120K		SCB 3PH, 110A, 1.2kV	B-70				
112MT140K		SCB 3PH, 110A, 1.4kV	B-70				
112MT160K		SCB 3PH, 110A, 1.6kV	B-70				
112RLA60	INU	110A, 600V, 0.15A, 3V	B-74				
112RLA80	INU	110A, 800V, 0.15A, 3V	B-74				
112RLA100	INR, INU	110A, 1kV, 0.15A, 3V	B-74				
112RLA120	INR, INU	110A, 1.2kV, 0.15A, 3V	B-74				
113MT80K		SCB 3PH, 110A, 800V	B-70				
113MT100K		SCB 3PH, 110A, 1kV	B-70				
113MT120K		SCB 3PH, 110A, 1.2kV	B-70				



器件型号 Element type	厂名 Manufacturers	材料用途参数 Material Purpose Parameter	图号 Figure	国内外相似替换器件型号 Replace of similar type	备注 Notes	外形参考图 Reference snape
113MT140K	SCB	3PH, 110A, 1.4KV	B-70			
113MT160K	SCB	3PH, 110A, 1.6KV	B-70			
128RS100		120A, 1KV	F-84			
128RS120		120A, 1.2KV	F-84			
128RS140		120A, 1.4KV	F-84			
128RS160		120A, 1.6KV	F-84			
129RW30		120A, 300V	F-13			
129RW40		120A, 400V	F-13			
130PKL20S	INR	1.3KA, 200V, 0.15A, 3V	C-11			
130PKL20W	INR	1.3KA, 200V, 0.2A, 3V	C-5			
130PKL30S	INR	1.3KA, 300V, 0.15A, 3V	C-11			
130PKL30T	INJ	1.3KA, 300V, 0.15A, 3V	C-5			
130PKL30W	INR	1.3KA, 300V, 0.2A, 3V	C-11			
130PKL40S	INR	1.3KA, 400V, 0.15A, 3V	C-5			
130PKL40T	INJ	1.3KA, 400V, 0.15A, 3V	C-11			
130PKL40W	INR	1.3KA, 400V, 0.2A, 3V	C-5			
130PKL50S	INR	1.3KA, 500V, 0.15A, 3V	C-11			
130PKL50T	INJ	1.3KA, 500V, 0.15A, 3V	C-5			
130PKL50W	INR	1.3KA, 500V, 0.2A, 3V	C-11			
130PKL60S	INR	1.3KA, 600V, 0.15A, 3V	C-5			
130PKL60T3	INJ	1.3KA, 600V, 0.15A, 3V	C-11			
130PKL60W	INR	1.3KA, 600V, 0.2A, 3V	C-5			
150C05	SIT	235A, 50V, 0.2A, 3V	F-91	ECG5580		
150C10	SIT	235A, 100V, 0.2A, 3V	F-91	ECG5580		
150C15	SIT	235A, 150V, 0.2A, 3V	F-91	ECG5580		

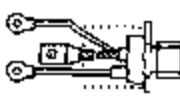



器件型号 Element type	厂名 Manufacturers	材料用途参数 Material Purpose Parameter	图号 Figure	国内外相似替换器件型号 Replace of similar type	备注 Notes	外形参考图 Reference shape
150C20	SIT	235A, 200V, 0.2A, 3V	F-91	ECG5580		 图 F-91
150C25	SIT	235A, 250V, 0.2A, 3V	F-91			
150C30	SIT	235A, 300V, 0.2A, 3V	F-91	ECG5582		
150C35	SIT	235A, 350V, 0.2A, 3V	F-91	ECG5582		
150C40	SIT	235A, 400V, 0.2A, 3V	F-91	ECG5582		
150C45	SIT	235A, 450V, 0.2A, 3V	F-91	ECG5582		
150C50	SIT	235A, 500V, 0.2A, 3V	F-91	ECG5582		
150C60	SIT	235A, 600V, 0.2A, 3V	F-91	ECG5582		
150C70	SIT	235A, 700V, 0.2A, 3V	F-91	ECG5584		
150C80	SIT	235A, 800V, 0.2A, 3V	F-91	ECG5584		
150C90	SIT	235A, 900V, 0.2A, 3V	F-91	ECG5584		
150C100	SIT	235A, 1kV, 0.2A, 3V	F-91	ECG5584		
150C110	SIT	235A, 1.1kV, 0.2A, 3V	F-91	ECG5584		
150C130	SIT	235A, 1.3kV, 0.2A, 3V	F-91			
150C140	SIT	235A, 1.4kV, 0.2A, 3V	F-91			
150C150	SIT	235A, 1.5kV, 0.2A, 3V	F-91			
150C160	SIT	235A, 1.6kV, 0.2A, 3V	F-91			
150C170	SIT	235A, 1.7kV, 0.2A, 3V	F-91			
150C180	SIT	235A, 1.8kV, 0.2A, 3V	F-91			
150P1SP	NEJ	235A, 100V, 0.125A, 3V	F-89			 图 F-89
150P2SP	NEJ	235A, 200V, 0.125A, 3V	F-89			
150P3SP	NEJ	235A, 300V, 0.125A, 3V	F-89			
150P4SP	NEJ	235A, 400V, 0.125A, 3V	F-89			
150P5SP	NEJ	235A, 500V, 0.125A, 3V	F-89			
150P6SP	NEJ	235A, 600V, 0.125A, 3V	F-89			
150P8SP	NEJ	235A, 800V, 0.125A, 3V	F-89			
150P10SP	NEJ	235A, 1kV, 0.125A, 3V	F-89			
150P12SP	NEJ	150A, 1.2kV, 0.125A, 3V	F-89			

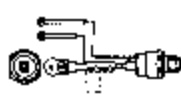

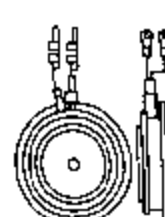
器件型号 Element type	厂名 Manufacturers	材料用途参数 Material Purpose Parameter	图号 Figure	国内外相似替换器件型号 Replace of similar type	备注 Notes	外形参考图 Reference shape
150P16SP	NEJ	235A, 1.6kV, 0.125A, 3V	F-89			
150S2SP	NEJ	235A, 200V, 0.125A, 3V	F-89			
150S3SP	NEJ	235A, 300V, 0.125A, 3V	F-89			
150S4SP	NEJ	235A, 400V, 0.125A, 3V	F-89			
150S5SP	NEJ	235A, 500V, 0.125A, 3V	F-89			
150S6SP	NEJ	235A, 600V, 0.125A, 3V	F-89			
150S8SP	NEJ	235A, 800V, 0.125A, 3V	F-89			
150SS2SP	NEJ	235A, 200V, 0.125A, 3V	F-89			
150SS3SP	NEJ	235A, 300V, 0.125A, 3V	F-89			
150SS4SP	NEJ	235A, 400V, 0.125A, 3V	F-89			
150SS5SP	NEJ	235A, 500V, 0.125A, 3V	F-89			
150SS6SP	NEJ	235A, 600V, 0.125A, 3V	F-89			
150SS8SP	NEJ	235A, 800V, 0.125A, 3V	F-89			
150TO-220SP		150A, 1kV	F-89			
151RA10	INR	170A, 100V, 0.15A, 2.5V	E-10			
151RA20	INR	235A, 200V, 0.15A, 2.5V	F-91			
151RA30	INR	170A, 300V, 0.15A, 2.5V	E-10			
151RA40	INR	235A, 400V, 0.15A, 2.5V	F-91			
151RA50	SST	235A, 500V, 0.15A, 2.5V	F-91			
151RA60	INR, SST	170A, 600V, 0.15A, 2.5V	E-10			
151RA80	INR, SST	170A, 800V, 0.15A, 2.5V	E-10			
151RA100	INR, SST	170A, 1kV, 0.15A, 2.5V	E-10			
151RA110	SST	235A, 1.1kV, 0.15A, 2.5V	F-91			
151RA120	INR, INJ	170A, 1.2kV, 0.15A, 2.5V	E-10			
151RA150	INR, INJ	170A, 1.5kV, 0.15A, 2.5V	E-10			
151RA160	INR, INJ	170A, 1.6kV, 0.15A, 2.5V	E-10			
151RB50	INJ	235A, 500V, 0.2A, 2.5V	F-91			
				ECG5582		
				ECG5582		
				ECG5581		
				ECG5584		
				ECG5584		
				ECG5584		

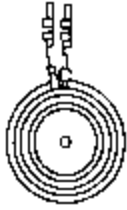
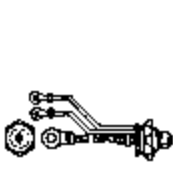

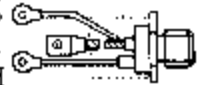

其他

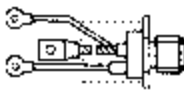

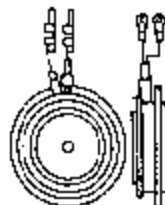

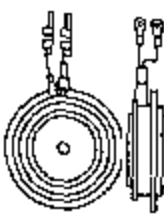

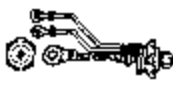
器件型号 Element type	厂名 Manufacturers	材料用途参数 Material Purpose Parameter	图号 Figure	国内外相似替换器件型号 Replace of similar type	备注 Notes	外形参考图 Reference shape
151RB60	INJ	150A, 600V, 0.2A, 2.5V	F-91	ECG5582		 图 F-91
151RB80	INJ	150A, 800V, 0.2A, 2.5V	F-91	ECG5584		
151RB100	INJ	150A, 1kV, 0.2A, 2.5V	F-91	ECG5584		
151RB120	INJ	150A, 1.2kV, 0.2A, 2.5V	F-91	ECG5584		
151RB150	INJ	150A, 1.5kV, 0.2A, 2.5V	F-91	ECG5584		
151RC10	INJ	150A, 100V, 0.15A, 2.5V	F-91	ECG5580		 图 F-7:
151RC20	INJ	150A, 200V, 0.15A, 2.5V	F-91	ECG5580		
151RC30	INJ	150A, 300V, 0.15A, 2.5V	F-91	ECG5582		
151RC40	INJ	150A, 400V, 0.15A, 2.5V	F-91	ECG5582		
151RC50	INJ	150A, 500V, 0.15A, 2.5V	F-91	ECG5582		
151RC60	INJ	150A, 600V, 0.15A, 2.5V	F-91	ECG5582		
151RC80	INJ	150A, 800V, 0.15A, 2.5V	F-91	ECG5582		
151RC100	INJ	150A, 1kV, 0.1A, 2.5V	F-71	ECG5584		
151RC120	INJ	150A, 1.2kV, 0.1A, 2.5V	F-71	ECG5584		
151REB60	INJ	235A, 600V, 0.15A, 2.5V	F-91			
151REB70	INJ	235A, 700V, 0.15A, 2.5V	F-91			
151REB80	INJ	235A, 800V, 0.15A, 2.5V	F-91			
151REB90	INJ	235A, 900V, 0.15A, 2.5V	F-91			
151REB100	INJ	235A, 1kV, 0.15A, 2.5V	F-91			
151REB110	INJ	235A, 1.1kV, 0.15A, 2.5V	F-91			
151REB120	INJ	235A, 1.2kV, 0.15A, 2.5V	F-91			
151REB130	INJ	235A, 1.3kV, 0.15A, 2.5V	F-91			
151RL50	INR, INJ	165A, 500V, 0.2A, 2.5V	C-50	ECG5374		 图 C-50
151RL60	INR, INJ	165A, 600V, 0.2A, 2.5V	C-50	ECG5374		
151RL80	INR, INJ	165A, 800V, 0.2A, 2.5V	C-50	ECG5375		
151RL110	INR, INJ	165A, 1.1kV, 0.2A, 2.5V	C-50	ECG5375		
151RL120	INR, INJ	165A, 1.2kV, 0.2A, 2.5V	C-50	ECG5375		
151RM10	INR, INJ	165A, 100V, 0.2A, 2.5V	C-50	ECG5374		
151RM20	INR, INJ	165A, 200V, 0.2A, 2.5V	C-50	ECG5374		

器件型号 Element type	厂名 Manufacturers	材料用途参数 Material Purpose Parameter	图号 Figure	国内外相似替换器件型号 Replace of similar type	备注 Notes	外形参考图 Reference shape
151RM30	INR, INJ	165A, 300V, 0.2A, 2.5V	C-50	ECG5374		 图 C-50
151RM40	INR, INJ	165A, 400V, 0.2A, 2.5V	C-50	ECG5374		
151RM50	INR, INJ	165A, 500V, 0.2A, 2.5V	C-50	ECG5374		
151RM60	INR, INJ	165A, 600V, 0.2A, 2.5V	C-50	ECG5374		
151RM80	INR, INJ	165A, 800V, 0.2A, 2.5V	C-50	ECG5375		
151RM100	INR, INJ	165A, 1kV, 0.2A, 2.5V	C-50	ECG5375		
158RP10		150A, 100V	F-84			 图 F-84
158RP20		150A, 200V	F-84			
158RP30		150A, 300V	F-84			
158RP40		150A, 400V	F-84			
158RP50		150A, 500V	F-84			 图 C-31
158RP60		150A, 600V	F-84			
158RP80		150A, 800V	F-84			
160PFT100	INR	160A, 1kV, 4A, 1V	C-31			
160PFT120	INR	160A, 1.2kV, 4A, 1V	C-31			
161RDF10	INR	165A, 100V, 0.2A, 2.5V	F-91			 图 F-91
161RDF20	INR	165A, 200V, 0.2A, 2.5V	F-91			
161RDF40	INR	165A, 400V, 0.2A, 2.5V	F-91			
161RDF50	INR	165A, 600V, 0.2A, 2.5V	F-91			
161RDF80	INR	165A, 800V, 0.2A, 2.5V	F-91			
161RDF100	INR	165A, 1kV, 0.2A, 2.5V	F-91			
161RDF120	INR	165A, 1.2kV, 0.2A, 2.5V	F-91			
161RL10	INR, INJ	195A, 100V, 0.2A, 2.5V	E-10			 图 E-10
161RL20	INR, INJ	195A, 200V, 0.2A, 2.5V	E-10			
161RL30	INR, INJ	195A, 300V, 0.2A, 2.5V	E-10			
161RL40	INR, INJ	195A, 400V, 0.2A, 2.5V	E-10			
161RL50	INR, INJ	195A, 500V, 0.2A, 2.5V	E-10			

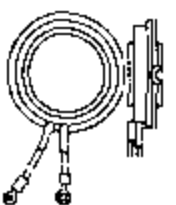

器件型号 Element type	厂名 Manufacturers	材料用途参数 Material Purpose Parameter	图号 Figure	国内外相似替换器件型号 Replace of similar type	备注 Notes	外形参考图 Reference shape
161RL60	INR, INJ	195A, 600V, 0.2A, 2.5V	E-10			 图 E-10
161RM10	INR, INJ	195A, 100V, 0.2A, 2.5V	E-10			
161RM20	INR, INJ	195A, 200V, 0.2A, 2.5V	E-10			
161RM30	INR, INJ	195A, 300V, 0.2A, 2.5V	E-10			
161RM40	INR, INJ	195A, 400V, 0.2A, 2.5V	E-10			
161RM50	INR, INJ	195A, 500V, 0.2A, 2.5V	E-10			
161RM60	INR, INJ	195A, 600V, 0.2A, 2.5V	E-10			
171RC10A	INR	170A, 100V, 0.15A, 2.5V	F-91			 图 F-91
171RC20A	INR	170A, 200V, 0.15A, 2.5V	F-91			
171RC40A	INR	170A, 400V, 0.15A, 2.5V	F-91			
171RC60A	INR	170A, 600V, 0.15A, 2.5V	F-91			
171RC80A	INR	170A, 800V, 0.15A, 2.5V	F-91			
171RK80A	INR	170A, 800V, 0.15A, 2.5V	F-91			
171RK100A	INR	170A, 1kV, 0.15A, 2.5V	F-91			
171RK120A	INR	170A, 1.2kV, 0.15A, 2.5V	F-91			
171RK160A	INR	170A, 1.6kV, 0.15A, 2.5V	F-91			
175PA50	INJ	275A, 500V, 0.2A, 2.5V	C-50	ECG5591		
175PA60	INR, INJ	175A, 600V, 0.2A, 2.5V	C-50	ECG5591		
175PA80	INR, INJ	175A, 800V, 0.2A, 2.5V	C-50	ECG5592		
175PA100	INR, INJ	175A, 1kV, 0.2A, 2.5V	C-50	ECG5592		
175PA110	INJ	275A, 1.1kV, 0.2A, 2.5V	C-50	ECG5592		
175PA120	INR, INJ	175A, 1.2kV, 0.2A, 2.5V	C-50	ECG5592		
175PA150	INR, INJ	175A, 1.5kV, 0.2A, 2.5V	C-50	ECG5592		
175PAK50	INJ	275A, 500V, 0.2A, 2.5V	C-50			 图 C-50
175PAK60	INJ	275A, 600V, 0.2A, 2.5V	C-50			
175PAK60	INJ	275A, 800V, 0.2A, 2.5V	C-50			
175PAK100	INJ	275A, 1kV, 0.2A, 2.5V	C-50			
175PAK110	INJ	275A, 1.1kV, 0.2A, 2.5V	C-50			
175PAK110	INJ	275A, 1.1kV, 0.2A, 2.5V	C-50			

器件型号 Element type	厂名 Manufacturers	材料用途参数 Material Purpose Parameter	图号 Figure	国内外相似替换器件型号 Replace of similar type	备注 Notes	外形参考图 Reference shape
175PAK120	INJ	275A, 1.2kV, 0.2A, 2.5V	C-50			 图 C-50
175PAK130	INJ	275A, 1.3kV, 0.2A, 2.5V	C-50			
175PAK140	INJ	275A, 1.4kV, 0.2A, 2.5V	C-50			
175PAK150	INJ	275A, 1.5kV, 0.2A, 2.5V	C-50			
175PAK160	INJ	275A, 1.6kV, 0.2A, 2.5V	C-50			
175RC10	INJ	175A, 100V, 0.15A, 2.5V	F-91	ECG5587		
175RC20	INJ	175A, 200V, 0.15A, 2.5V	F-91	ECG5587		
175HC30	INJ	175A, 300V, 0.15A, 2.5V	F-91	ECG5587		
175RC40	INJ	175A, 400V, 0.05A, 1.3V	F-91	ECG5587		
175RC60	INJ	175A, 600V, 0.15A, 2.5V	F-91	ECG5587		
175RC80	INJ	175A, 800V, 0.15A, 2.5V	F-91	ECG5589		
178R9100	SCR-H	175A, 1kV	F-84			 图 F-91
178R9120	SCR-H	175A, 1.2kV	F-84			
178R9140	SCR-H	175A, 1.4kV	F-84			
178R9160	SCR-H	175A, 1.6kV	F-84			
178RLD10	SCR-H	150A, 100V	F-84			
178RLD20	SCR-H	150A, 200V	F-84			
178RLD30	SCR-H	150A, 300V	F-84			
178RLD40	SCR-H	150A, 400V	F-84			 图 F-84
178RLE10	SCR-H	150A, 100V	F-84			
178RLE20	SCR-H	150A, 200V	F-84			
178RLE30	SCR-H	150A, 300V	F-84			
178RLE40	SCR-H	150A, 400V	F-84			
178RLE60	SCR-H	150A, 600V	F-84			
178RLE80	SCR-H	150A, 800V	F-84			
178RLF60	SCR-H	175A, 600V	F-84			 其他
178RLF80	SCR-H	175A, 800V	F-84			

器件型号 Element type	厂名 Manufacturers	材料 Material	用途 Purpose	参数 Parameter	图号 Figure	国内外相似替换器件型号 Replace of similar type	备注 Notes	外形参考图 Reference snacc
178RLG100	SCR-H	175A, 1kV			F-84			 图 F-84  图 F-84  图 F-98  图 F-89  图 E-28  图 C-35
178RLG120	SCR-H	175A, 1.2kV			F-84			
178RLH100	SCR-H	175A, 1kV			F-84			
178RLH120	SCR-H	175A, 1.2kV			F-84			
178RS100		175A, 1kV			F-98			
178RS120		175A, 1.2kV			F-98			
178RS140		175A, 1.4kV			F-98			
178RS160		175A, 1.6kV			F-98			
180P1SP	NEJ	285A, 100V, 0.125A, 3V			F-89			
180P2SP	NEJ	285A, 200V, 0.125A, 3V			F-89			
180P3SP	NEJ	285A, 300V, 0.125A, 3V			F-89			
180P4SP	NEJ	285A, 400V, 0.125A, 3V			F-89			
180P5SP	NEJ	285A, 500V, 0.125A, 3V			F-89			
180P6SP	NEJ	285A, 600V, 0.125A, 3V			F-89			
180P8SP	NEJ	285A, 800V, 0.125A, 3V			F-89			
180P10SP	NEJ	285A, 1kV, 0.125A, 3V			F-89			
180P12SP	NEJ	285A, 1.2kV, 0.125A, 3V			F-89			
180P16SP	NEJ	285A, 1.6kV, 0.125A, 3V			F-89			
180RK120		285A, 200V			E-28			
180RK140		285A, 400V			E-28			
180RK160		285A, 600V			E-28			
180RK180		285A, 800V			E-28			
180RK100		285A, 1kV			E-28			
180TO-220SP	SCR-H	180A, 1kV			F-89			
203PLAG100	SCR-H	200A, 1kV			C-35			
203PLAG120	SCR-H	200A, 1.2kV			C-35			

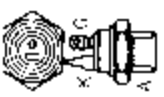
器件型号 Element type	厂名 Manufacturers	材料 Material	用途 Purpose	参数 Parameter	图号 Figure	国内外相似替换器件型号 Replace of similar type	备注 Notes	外形参考图 Reference shape
208RLE10	SCR-H	200A, 100V			F-23			
208RLE20	SCR-H	200A, 200V			F-23			
208RLE30	SCR-H	200A, 300V			F-23			
208RLE40	SCR-H	200A, 400V			F-23			
208RP10		200A, 100V			F-84			
208RP20		200A, 200V			F-98			
208RP30		200A, 300V			F-98			
208RP40		200A, 400V			F-98			
208RP50		200A, 500V			F-98			
208RP60		200A, 600V			F-98			
208RP80		200A, 800V			F-98			
211RDF10	INR	210A, 100V, 0.2A, 2.45V			F-91			
211RDF20	INR	210A, 200V, 0.2A, 2.45V			F-91			
211RDF40	INR	210A, 400V, 0.2A, 2.45V			F-91			
211RDF60	INR	210A, 600V, 0.2A, 2.45V			F-91			
214C40		16A, 400V			F-15			
214C50		16A, 500V			F-15			
231RC10A	INR	230A, 100V, 0.15A, 2.5V			F-91			
231RC20A	INR	230A, 200V, 0.15A, 2.5V			F-91			
231RC40A	INR	230A, 400V, 0.15A, 2.5V			F-91			
231RC60A	INR	230A, 600V, 0.15A, 2.5V			F-91			
231RC80A	INR	230A, 800V, 0.15A, 2.5V			F-91			
231RK100A	INR	230A, 1kV, 0.15A, 2.5V			F-91			
231RK120A	INR	230A, 1.2kV, 0.15A, 2.5V			F-91			
240PAL50	INR, INJ	285A, 500V, 0.2A, 2.5V			C-50	ECG6380		



图 F-23

图 F-84



图 F-91

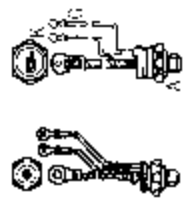

图 C-50

其他

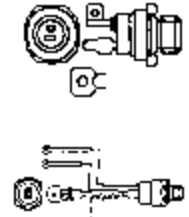

器件型号 Element type	厂名 Manufacturers	材料用途参数 Material Purpose Parameter	图号 Figure	国内外相似替换器型号 Replace of similar type	备注 Notes	外形参考图 Reference shape
240PAL60	INR, INJ	285A, 600V, 0.2A, 2.5V	C-50	ECG5380		 图 C-50
240PAL80	INR, INJ	285A, 800V, 0.2A, 2.5V	C-50	ECG5381		
240PAL100	INR, INJ	285A, 1kV, 0.2A, 2.5V	C-50	ECG5381		
240PAL110	INR, INJ	285A, 1.1kV, 0.2A, 2.5V	C-50	ECG5381		
240PAL120	INR, INJ	285A, 1.2kV, 0.2A, 2.5V	C-50	ECG5381		
240PAM10	INR, INJ	285A, 100V, 0.2A, 2.5V	C-50	ECG5380		
240PAM20	INR, INJ	285A, 200V, 0.2A, 2.5V	C-50	ECG5380		
240PAM30	INR, INJ	285A, 300V, 0.2A, 2.5V	C-50	ECG5380		
240PAM50	INR, INJ	285A, 500V, 0.2A, 2.5V	C-50	ECG5380		
240PAM60	INR, INJ	285A, 600V, 0.2A, 2.5V	C-50	ECG5380		
240PAM80	INR, INJ	285A, 800V, 0.2A, 2.5V	C-50	ECG5381		
240PAM100	INR, INJ	285A, 1kV, 0.2A, 2.5V	C-50	ECG5381		
250P4H	NEJ	390A, 400V, 0.15A, 3V	C-70			 图 C-70
250P6H	NEJ	390A, 600V, 0.15A, 3V				
250P8H	NEJ	390A, 800V, 0.15A, 3V				
250P10H	NEJ	390A, 1kV, 0.15A, 3V				
250P12H	NEJ	390A, 1.2kV, 0.15A, 3V	F-92			
250P16H	NEJ	390A, 1.6kV, 0.15A, 3V				
250PA10	INR	250A, 100V, 0.15A, 2.5V	C-50			
250PA20	INR	250A, 200V, 0.15A, 2.5V	C-50			
250PA30	INR	250A, 300V, 0.15A, 2.5V	C-50			
250PA40	INR	250A, 400V, 0.15A, 2.5V	C-50			
250PA60	INR	250A, 600V, 0.15A, 2.5V	C-50	ECG5591		
250PA80	INR, INJ	250A, 800V, 0.15A, 2.5V	C-50	ECG5592		
250PA100	INR, INJ	250A, 1kV, 0.15A, 2.5V	C-50	ECG5592		
250PA140	INR, INJ	250A, 1.4kV, 0.15A, 3V	F-71			
250PA150	INR, INJ	250A, 1.5kV, 0.15A, 2.5V	C-50			
250PA160	INR, INJ	250A, 1.6kV, 0.15A, 2.5V	C-50			

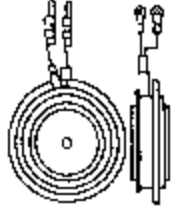

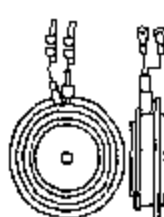
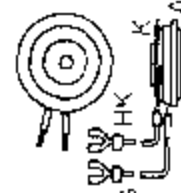

图 F-92

图 F-71

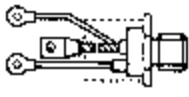
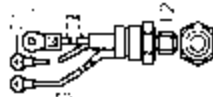
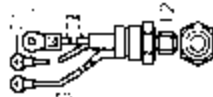
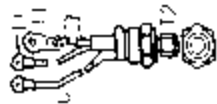
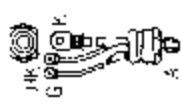
器件型号 Element type	厂名 Manufacturers	材料用途参数 Material Purpose Parameter	图号 Figure	国内外相似替换器件型号 Replace of similar type	备注 Notes	外形参考图 Reference shape	
250PAC10	INJ	250A, 100V, 0.15A, 2.5V	C-50	ECG5590		 图 C-50	
250PAC20	INJ	250A, 200V, 0.15A, 2.5V	C-50	ECG5590			
250PAC30	INJ	250A, 300V, 0.15A, 2.5V	C-50	ECG5591			
250PAC40	INJ	250A, 400V, 0.15A, 2.5V	C-50	ECG5591			
250PAC50	INJ	250A, 500V, 0.15A, 2.5V	C-50	ECG5591			
250PAC60	INJ	250A, 600V, 0.15A, 2.5V	C-50	ECG5591			
250PAL10	INR, INJ	330A, 100V, 0.2A, 2.5V	E-10	ECG5380		 图 E-10	
250PAL20	INR, INJ	330A, 200V, 0.2A, 2.5V	E-10	ECG5380			
250PAL30	INR, INJ	330A, 300V, 0.2A, 2.5V	E-10	ECG5380			
250PAL40	INR, INJ	330A, 400V, 0.2A, 2.5V	E-10	ECG5380			
250PAL50	INR, INJ	330A, 500V, 0.2A, 2.5V	E-10	ECG5380			
250PAL60	INR, INJ	330A, 600V, 0.2A, 2.5V	E-10	ECG5380			
250PAM10	INR, INJ	330A, 100V, 0.2A, 2.5V	E-10	ECG5380		 图 F-71	
250PAM20	INR, INJ	330A, 200V, 0.2A, 2.5V	E-10	ECG5380			
250PAM30	INR, INJ	330A, 300V, 0.2A, 2.5V	E-10	ECG5380			
250PAM40	INR, INJ	330A, 400V, 0.2A, 2.5V	E-10	ECG5380			
250PAM50	INR, INJ	330A, 500V, 0.2A, 2.5V	E-10	ECG5380			
250PAM60	INR, INJ	330A, 600V, 0.2A, 2.5V	E-10	ECG5380			
250RA10	INR, INJ	250A, 100V, 0.15A, 3V	F-71			 图 F-71	
250RA20	INR, INJ	250A, 200V, 0.15A, 3V	F-71				
250RA30	INR, INJ	250A, 300V, 0.15A, 3V	F-71				
250RA40	INR, INJ	250A, 400V, 0.15A, 3V	F-71				
250RA60	INR	250A, 600V, 0.15A, 3V	F-71	ECG587			
250RA70	INJ	250A, 700V, 0.15A, 3V	F-71				
250RA80	INR, INJ	250A, 800V, 0.15A, 3V	F-71	ECG5589			
250RA100	INR, INJ	250A, 1kV, 0.15A, 3V	F-71	ECG5589			
250RA150	INR, INJ	250A, 1.5kV, 0.15A, 3V	F-71				
250RA160	INR, INJ	250A, 1.6kV, 0.15A, 3V	F-71				

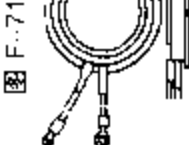
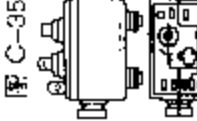

器件型号 Element type	厂名 Manufacturers	材料用途参数 Material Purpose Parameter	图号 Figure	国内外相似替换器件型号 Replace of similar type	备注 Notes	外形参考图 Reference shape	
250RA170	INR, INJ	250A, 1.7kV, 0.15A, 3V	F-71			 图 F-71	
250RA180	INR, INJ	250A, 1.8kV, 0.15A, 3V	F-71				
250RA190	INR, INJ	250A, 1.9kV, 0.15A, 3V	F-71				
250RA200	INR, INJ	250A, 2kV, 0.15A, 3V	F-71				
250RL60	INR, INJ	285A, 600V, 0.2A, 2.5V	F-71	ECG5377			
250RL80	INR, INJ	285A, 800V, 0.2A, 2.5V	F-71	ECG5378			
250RL100	INR, INJ	285A, 1kV, 0.2A, 2.5V	F-71	ECG5378			
250RL110	INR, INJ	285A, 1.1kV, 0.2A, 2.5V	F-71	ECG5378			
250RL120	INR, INJ	285A, 1.2kV, 0.2A, 2V	F-71	ECG5378			
250RM60	INR, INJ	285A, 600V, 0.2A, 2.5V	F-71	ECG5377			
250RM80	INR, INJ	285A, 800V, 0.2A, 2.5V	F-71	ECG5378			
250RM100	INR, INJ	285A, 1kV, 0.2A, 2.5V	F-71	ECG5378			
250RM110	INR, INJ	285A, 1.1kV, 0.2A, 2.5V	F-71	ECG5378			
250RM120	INR, INJ	285A, 1.2kV, 0.2A, 2V	F-71	ECG5378			
251RA10	INR, INJ	250A, 100V, 0.15A, 3V	F-71				 图 F-74
251RA20	INR, INJ	250A, 200V, 0.15A, 3V	F-71				
251RA30	INR, INJ	250A, 300V, 0.15A, 3V	F-71				
251RA40	INR	250A, 400V, 0.15A, 3V	F-71				
251RA60	INR	250A, 600V, 0.15A, 3V	F-71	ECG5587			
251RA80	INR	250A, 800V, 0.15A, 3V	F-71	ECG5589			
251RA100	INR	250A, 1kV, 0.15A, 3V	F-71	ECG5589			
251RA120	INR	250A, 1.2kV, 0.2A, 3V	F-71	ECG5589			
251RA150	INR	250A, 1.5kV, 0.15A, 3V	F-71				
251RA160	INR	250A, 1.6kV, 0.15A, 3V	F-71				
251RA180	INR	250A, 1.6kV, 0.15A, 3V	F-71				
251RA190	INR, INJ	250A, 1.7kV, 0.15A, 3V	F-71				
251RA200	INR, INJ	250A, 1.8kV, 0.15A, 3V	F-71				
251RC10	INJ	400A, 100V, 0.15A, 2.5V	F-74	ECG5587			

器件型号 Element type	厂名 Manufacturers	材料用途参数 Material Purpose Parameter	图号 Figure	国内外相似替换器件型号 Replace of similar type	备注 Notes	外形参考图 Reference shape
251RC20	INJ	400A, 200V, 0.15A, 2.5V	F-74	ECG5587		     
251RC30	INJ	400A, 300V, 0.15A, 2.5V	F-74	ECG5587		
251RC40	INJ	400A, 400V, 0.15A, 2.5V	F-74	ECG5587		
251RC50	INJ	400A, 500V, 0.15A, 2.5V	F-74	ECG5587		
251RC60	INJ	400A, 600V, 0.15A, 2.5V	F-74	ECG5587		
251RC80	INJ	400A, 800V, 0.15A, 2.5V	F-74	ECG5589		
251RC100	INJ	400A, 1KV, 0.15A, 2.5V	F-74			
251RC120	INJ	400A, 1.2KV, 0.15A, 2.5V	F-74			
251RL60	INR	285A, 600V, 0.2A, 2.5V	F-71	ECG5377		
251RL80	INR	285A, 800V, 0.2A, 2.5V	F-71	ECG5378		
251RL100	INR	450A, 1KV, 0.15A, 3V	F-71	ECG5378		
251RL110	INR	450A, 1.1KV, 0.15A, 3V	F-71	ECG5378		
251RL120	INR	285A, 1.2KV, 0.2A, 2.5V	F-71	ECG5378		
251RM60	INR	285A, 600V, 0.2A, 2.5V	F-71	ECG5377		
251RM80	INR	285A, 800V, 0.2A, 2.5V	F-71	ECG5378		
251RM100	INR	285A, 1KV, 0.2A, 2.5V	F-71	ECG5378		
251RM110	INR	285A, 1.1KV, 0.2A, 2.5V	F-71	ECG5378		
251RM120	INR	285A, 1.2KV, 0.2A, 2.5V	F-71	ECG5378		
253PA100		250A, 1KV	C-35			
253PA120		250A, 1.2KV	C-35			
253PA140		250A, 1.4KV	H-9			
253PA160		250A, 1.6KV	C-35			
253PLE20	SCR-H	250A, 200V	F-94			
253PLE30	SCR-H	250A, 300V	F-94			
253PLE40	SCR-H	250A, 400V	F-94			
253PLE60	SCR-H	250A, 600V	F-94			
253PLE80	SCR-H	250A, 800V	F-94			
253PLH100	SCR-H	250A, 1KV				



器件型号 Element type	厂名 Manufacturers	材料用途参数 Material Purpose Parameter	图号 Figure	国内外相似替换器件型号 Replace of similar type	备注 Notes	外形参考图 Reference shape
253PLH120	SCR-H	250A, 1.2kV				
253RA10	INR	250A, 100V, 0.4A, 1.2V	F-71			
253RA20	INR	250A, 200V, 0.4A, 1.2V	F-71			
253RA30	INR	350A, 300V, 0.15A, 3V	D-37			
253RA40	INR	250A, 400V, 0.4A, 1.2V	F-71			
253RA60	INR	250A, 600V, 0.4A, 1.2V	F-71			
253RA80	INR	250A, 800V, 0.4A, 1.2V	F-71			
253RA100	INR	250A, 1kV, 0.4A, 1.2V	F-71			
253RA150	INR	250A, 1.5kV, 0.4A, 1.2V	F-71			
253RA160	INR	250A, 1.6kV, 0.4A, 1.2V	F-71			
253RA170	INR	250A, 1.7kV, 0.4A, 1.2V	F-71			
253RA180	INR	250A, 1.8kV, 0.15A, 3V	F-71			
253RA190	INR	250A, 1.9kV, 0.15A, 3V	F-71			
253RA200	INR	250A, 2kV, 0.15A, 3V	F-71			
253RL60	INR	285A, 600V, 0.2A, 2.5V	F-71			
253RL80	INR	285A, 800V, 0.2A, 2.5V	F-71			
253RL100	INR	450A, 1kV, 0.15A, 3V	D-37			
253RL110	INR	285A, 1.1kV, 0.2A, 2.5V	F-71			
253RL120	INR	285A, 1.2kV, 0.2A, 2V	F-71			
253RM60	INR	285A, 600V, 0.2A, 2.5V	F-71			
253RM80	INR	285A, 800V, 0.2A, 2.5V	F-71			
253RM100	INR	285A, 1kV, 0.2A, 2.5V	F-71			
253RM110	INR	285A, 1.1kV, 0.2A, 2.5V	F-71			
253RM120	INR	285A, 1.2kV, 0.2A, 2V	F-71			
258RLD10	SCR-H	250A, 100V	F-22			
258RLD20	SCR-H	250A, 200V	F-22			
258RLD30	SCR-H	250A, 300V	F-22			
258RLD40	SCR-H	250A, 400V	F-22			

图 F-71





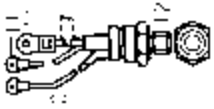

图 D-37

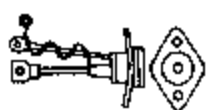

图 F-22

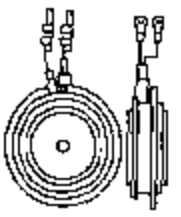
器件型号 Element type	厂名 Manufacturers	材料 Material	用途 Purpose	参数 Parameter	图号 Figure	国内外相似替换器件型号 Replace of similar type	备注 Notes	外形参考图 Reference shape
258RLG100	SCR-H	250A, 1kV			F-22			 图 F-22
258RLG200	SCR-H	250A, 1.2kV			F-22			
259RW30		250A, 300V			F-61			 图 F-61
259RW40		250A, 400V			F-61			
270PAF10V	INR			270A, 100V, 0.2A, 2.5V	C-50			 图 C-50
270PAF20V	INR			270A, 200V, 0.2A, 2.5V	C-50			
270PAF40V	INR			270A, 400V, 0.2A, 2.5V	C-50			
270PAF60V	INR			270A, 600V, 0.2A, 2.5V	C-50			
270PAF80V	INR			270A, 800V, 0.2A, 2.5V	C-50			
270PAF100V	INR			270A, 1kV, 0.2A, 2.5V	C-50			
270PAF120V	INR			270A, 1.2kV, 0.2A	C-50			
278RS100		270A, 1kV			F-98			
278RS120		270A, 1.2kV			F-98			
278RS140		270A, 1.4kV			F-98			
278RS160		270A, 1.6kV			F-98			
300PA10	INR			300A, 100V, 0.15A, 2.5V	C-50			 图 F-98
300PA20	INR			300A, 200V, 0.15A, 2.5V	C-50			
300PA30	INR			300A, 300V, 0.15A, 2.5V	C-50			
300PA40	INR			300A, 400V, 0.15A, 2.5V	C-50			
300PA50	INU			470A, 500V, 0.15A, 2.5V	C-50			
300PA60	INR, INU			300A, 600V, 0.15A, 2.5V	C-50	EOG5591		
300PA80	INR, INU			300A, 800V, 0.15A, 2.5V	C-50	EOG5592		
300PA100	INR, INU			300A, 1kV, 0.15A, 2.5V	C-50	EOG5592		
300PA120	INR, INU			300A, 1.2kV, 0.15A, 2.5V	C-50	EOG5592		
300PA140	INR, INU			300A, 1.4kV, 0.15A, 2.5V	C-50	EOG5592		

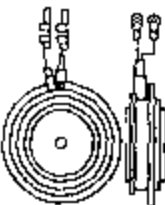
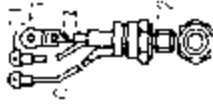

器件型号 Element type	厂名 Manufacturers	材料用途参数 Material Purpose Parameter	图号 Figure	国内外相似替换器件型号 Replace of similar type	备注 Notes	外形参考图 Reference shape
300PA150	INR, INJ	300A, 1.5kV, 0.15A, 2.5V	C-50			 <p>E C 50</p>
300PA160	INR, INJ	300A, 1.6kV, 0.15A, 2.5V	C-50			
300PAC10	INR, INJ	300A, 100V, 0.15A, 2.5V	C-50	ECG5590		
300PAC20	INR, INJ	300A, 200V, 0.15A, 2.5V	C-50	ECG5590		
300PAC30	INR, INJ	300A, 300V, 0.15A, 2.5V	C-50	ECG5591		
300PAC40	INR, INJ	300A, 400V, 0.15A, 2.5V	C-50	ECG5591		
300PAC50	INR, INJ	300A, 500V, 0.15A, 2.5V	C-50	ECG5591		 <p>F-71</p>
300PAC60	INR, INJ	300A, 600V, 0.15A, 2.5V	C-50	ECG5591		
300RA10	INR, INJ	300A, 100V, 0.15A, 3V	F-71			
300RA20	INR, INJ	300A, 200V, 0.15A, 3V	F-71			
300RA30	INR, INJ	300A, 300V, 0.15A, 3V	F-71			
300RA40	INR, INJ	300A, 400V, 0.15A, 3V	F-71			
300RA60	INR, INJ	300A, 600V, 0.15A, 3V	F-71	ECG5587		
300RA80	INR, INJ	300A, 800V, 0.15A, 3V	F-71	ECG5589		
300RA100	INR, INJ	300A, 1kV, 0.15A, 3V	F-71	ECG5589		
300RA120	INR, INJ	300A, 1.2kV, 0.15A, 3V	F-71	ECG5589		
300RA130	INR, INJ	300A, 1.3kV, 0.13A, 3V	F-71			
300RA140	INR, INJ	300A, 1.4kV, 0.14A, 3V	F-71			
300RA150	INR, INJ	300A, 1.5kV, 0.14A, 3V	F-71			
300RA160	INR, INJ	300A, 1.6kV, 0.15A, 3V	F-71			
300RA170	INR, INJ	300A, 1.7kV, 0.15A, 3V	F-71			
300RA180	INR, INJ	300A, 1.8kV, 0.15A, 3V	F-71			
300RA190	INR, INJ	300A, 1.9kV, 0.15A, 3V	F-71			
300RA200	INR, INJ	300A, 2kV, 0.15A, 3V	F-71			
300RB10	INJ	300A, 100V, 0.15A, 3V	F-71			
300RB20	INJ	300A, 200V, 0.15A, 3V	F-71			
300RB30	INJ	300A, 300V, 0.15A, 3V	F-71			
300RB40	INJ	300A, 400V, 0.15A, 3V	F-71			

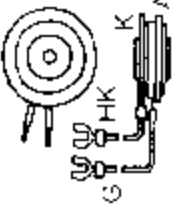

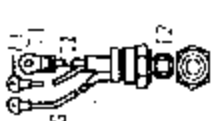
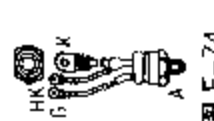

器件型号 Element type	厂名 Manufacturers	材料用途参数 Material Purpose Parameter	图号 Figure	国内外相似替换器件型号 Replace of similar type	备注 Notes	外形参考图 Reference shape	
300RB50	INJ	470A, 500V, 0.15A, 3V	F-71	ECG5587		 图 F-71	
300RB60	INJ	470A, 600V, 0.15A, 3V	F-71	ECG5587			
300RB70	INJ	470A, 700V, 0.15A, 3V	F-71				
300RB80	INJ	470A, 800V, 0.15A, 3V	F-71	ECG5589			
300RB90	INJ	470A, 900V, 0.15A, 3V	F-71				
300RB100	INJ	470A, 1KV, 0.15A, 3V	F-71	ECG5589			
300RB110	INJ	470A, 1.1KV, 0.15A, 3V	F-71	ECG5589			
300RB120	INJ	470A, 1.2KV, 0.15A, 3V	F-71	ECG5589			
300RB130	INJ	300A, 1.3KV, 0.15A, 3V	F-71	ECG5589			
300RB140	INJ	470A, 1.4KV, 0.15A, 3V	F-71				
300RB150	INJ	300A, 1.5KV, 0.15A, 3V	F-71				
300RB160	INJ	300A, 1.6KV, 0.15A, 3V	F-71				
300RB170	INJ	300A, 1.7KV, 0.15A, 3V	F-71				
300RB180	INJ	300A, 1.7KV, 0.15A, 3V	F-71				
300RB190	INJ	300A, 1.8KV, 0.15A, 3V	F-71				
300RB200	INJ	300A, 1.9KV, 0.15A, 3V	F-71				
300S5H	NEJ	SCR-H 470A, 500V, 0.2A, 3V	C-70				 图 C-70
300S6H	NEJ	SCR-H 470A, 600V, 0.2A, 3V	C-70				
300S8H	NEJ	SCR-H 470A, 800V, 0.2A, 3V	C-70				
300S10H	NEJ	SCR-H 470A, 1KV, 0.2A, 3V	C-70				
300S12H	NEJ	SCR-H 470A, 1.2KV, 0.2A, 3V	C-70				
300SS5H		SCR-H 300A, 500V	C-70				
300SS6H		SCR-H 300A, 600V	C-70				
300SS8H		SCR-H 300A, 800V	C-70				
300SS10H		SCR-H 300A, 1KV	C-70				
300SS12H		SCR-H 300A, 1.2KV	C-70				
301RA10	INR, INJ	300A, 100V, 0.15A, 3V	F-71				
301RA20	INR, INJ	300A, 200V, 0.15A, 3V	F-71				

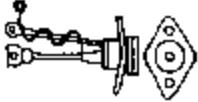
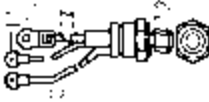

器件型号 Element type	厂名 Manufacturers	材料用途参数 Material Purpose Parameter	图号 Figure	国内外相似替换器件型号 Replace of similar type	备注 Notes	外形参考图 Reference shape
301RA30	INR, INJ	300A, 300V, 0.15A, 3V	F-71			 图 F-71
301RA40	INR, INJ	300A, 400V, 0.15A, 3V	F-71			
301RA60	INR, INJ	300A, 500V, 0.15A, 3V	F-71	ECG5587		
301RA80	INJ	300A, 600V, 0.15A, 3V	F-71	ECG5589		
301RA100	INJ	300A, 800V, 0.15A, 3V	F-71			
301RA120	INJ	300A, 1kV, 0.15A, 3V	F-71	ECG5589		
301RA130	INJ	300A, 1.2kV, 0.15A, 3V	F-71			
301RA140	INJ	300A, 1.3kV, 0.15A, 3V	F-71			
301RA160	INJ	300A, 1.5kV, 0.15A, 3V	F-71			
301RA170	INJ	300A, 1.6kV, 0.15A, 3V	F-71			
301RA180	INJ	300A, 1.7kV, 0.15A, 3V	F-71			
301RA190	INJ	300A, 1.8kV, 0.15A, 3V	F-71			
301RA200	INJ	300A, 1.9kV, 0.15A, 3V	F-71			
301RB10	INJ	300A, 100V, 0.15A, 3V	F-71			
301RB20	INJ	300A, 200V, 0.15A, 3V	F-71			
301RB30	INJ	300A, 300V, 0.15A, 3V	F-71			
301RB40	INJ	300A, 400V, 0.15A, 3V	F-71			
301RB160	INJ	300A, 1.7kV, 0.15A, 3V	F-71			
301RB190	INJ	300A, 1.8kV, 0.15A, 3V	F-71			
301RB200	INJ	300A, 1.9kV, 0.15A, 3V	F-71			
301RC10	INJ	470A, 100V, 0.15A, 2.5V	F-74	ECG5587		 图 F-74
301RC20	INJ	470A, 200V, 0.15A, 2.5V	F-74	ECG5587		
301RC30	INJ	470A, 300V, 0.15A, 2.5V	F-74	ECG5587		
301RC40	INJ	470A, 400V, 0.15A, 2.5V	F-74	ECG5587		
301RC50	INJ	470A, 500V, 0.15A, 2.5V	F-74	ECG5587		
301RC60	INJ	470A, 600V, 0.15A, 2.5V	F-74	ECG5587		
301RC80	INJ	470A, 800V, 0.15A, 2.5V	F-74	ECG5587		
301RC100	INJ	470A, 1kV, 0.15A, 2.5V	F-74	ECG5589		
301RC120	INJ	470A, 1.2kV, 0.15A, 2.5V	F-74			

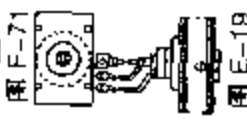

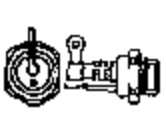
器件型号 Element type	厂名 Manufacturers	材料用途参数 Material Purpose Parameter	图号 Figure	国内外相似替换器件型号 Replace of similar type	备注 Notes	外形参考图 Reference shape	
303RA10	INR, INJ	300A, 100V, 0.15A, 3V	D-37			 图 D-37	
303RA20	INR, INJ	300A, 200V, 0.15A, 3V	D-37				
303RA30	INR, INJ	300A, 300V, 0.15A, 3V	D-37				
303RA40	INR, INJ	300A, 400V, 0.15A, 3V	D-37				
303RA60, 80	INR, INJ	300A, 600V, 0.15A, 3V	D-37				
303RA100	INR, INJ	300A, 800V, 0.15A, 3V	D-37				
303RA120	INR, INJ	300A, 1kV, 0.15A, 3V	D-37				
303RA130	INR, INJ	300A, 1.2kV, 0.15A, 3V	F-71				
303RA140	INR, INJ	300A, 1.4kV, 0.15A, 3V	D-37				
303RA150	INR, INJ	300A, 1.4kV, 0.15A, 3V	D-37				
303RA170	INR, INJ	300A, 1.6kV, 0.15A, 3V	D-37				
303RA180	INR, INJ	300A, 1.7kV, 0.15A, 3V	D-37				
303RA190	INR, INJ	300A, 1.8kV, 0.15A, 3V	D-37				
303RA200	INR, INJ	300A, 1.9kV, 0.15A, 3V	D-37				
303RB10	INJ	300A, 100V, 0.15A, 3V	F-71				 图 F-71
303RB20	INJ	300A, 200V, 0.15A, 3V	F-71				
303RB30	INJ	300A, 300V, 0.15A, 3V	F-71				
303RB40	INJ	300A, 400V, 0.15A, 3V	F-71				
303RB60	INJ	300A, 600V, 0.15A, 3V	F-71				
303RB80	INJ	300A, 800V, 0.15A, 3V	F-71				
303RB100	INJ	300A, 1kV, 0.15A, 3V	F-71				
303RB120	INJ	300A, 1.2kV, 0.15A, 3V	F-71				
303RB130	INJ	300A, 1.3kV, 0.15A, 3V	F-71				
303RB150	INJ	300A, 1.4kV, 0.15A, 3V	F-71				
303RB160	INJ	300A, 1.5kV, 0.15A, 3V	D-37				
303RB170	INJ	300A, 1.6kV, 0.15A, 3V	D-37				
303RB180	INJ	300A, 1.7kV, 0.15A, 3V	D-37				
303RB190	INJ	300A, 1.8kV, 0.15A, 3V	D-37				
303RB200	INJ	300A, 1.9kV, 0.15A, 3V	D-37				

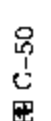

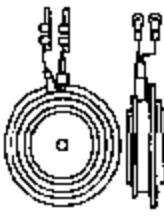
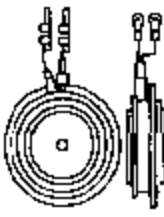
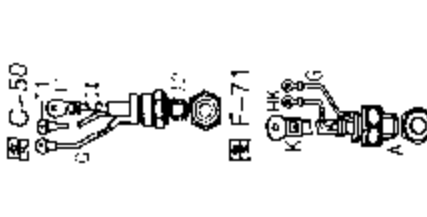
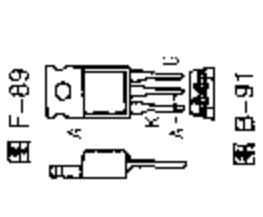
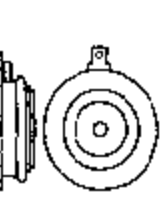
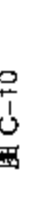

器件型号 Element type	厂名 Manufacturers	材料用途参数 Material Purpose Parameter	图号 Figure	国内外相似替换器件型号 Replace of similar type	备注 Notes	外形参考图 Reference shape
304RA60	INR, INJ	300A, 600V, 0.15A, 3V	F-71			     
304RA80	INR, INJ	470A, 800V, 0.15A, 3V	F-71			
304RA100	INR, INJ	300A, 1kV, 0.15A, 3V	F-71			
304RA130	INR, INJ	470A, 1.3kV, 0.15A, 3V	E-19			
304RA140	INR, INJ	470A, 1.4kV, 0.15A, 3V	F-71			
304RA150	INR, INJ	470A, 1.5kV, 0.15A, 3V	E-19			
304RA160	INR, INJ	300A, 1.6kV, 0.15A, 3V	F-71			
304RA170	INR, INJ	470A, 1.7kV, 0.15A, 3V	E-19			
308RLE10	SCR-H	300A, 100V	F-84			
308RLE20	SCR-H	300A, 200V	F-84			
308RLE30	SCR-H	300A, 300V	F-84			
308RLE40	SCR-H	300A, 400V	F-84			
308RLE60	SCR-H	300A, 600V	F-84			
308RLE80	SCR-H	300A, 800V	F-84			
308RLF60	SCR-H	300A, 600V	F-84			
308RLF80	SCR H	300A, 800V	F-84			
308RP10		300A, 100V	F-84			
308RP20		300A, 200V	F-84			
308RP30		300A, 300V	F-84			
308RP40		300A, 400V	F-84			
308RP50		300A, 500V	F-84			
308RP60		300A, 600V	F-84			
308RP80		300A, 800V	F-84			
309RW30		300A, 300V	F-13			
309RW40		300A, 400V	F-13			
325PAH60	INR, INJ	325A, 600V, 0.15A, 2.5V	C-50			

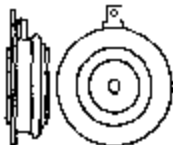



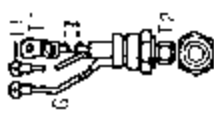





















器件型号 Element type	厂名 Manufacturers	材料用途参数 Material Purpose Parameter	图号 Figure	国内外相似替换器件型号 Replace of similar type	备注 Notes	外形参考图 Reference shape
325PAH80	INR, INJ	325A, 800V, 0.15A, 2.5V	C-50			
325PAH100	INR, INJ	325A, 1kV, 0.15A, 2.5V	C-50			
325PAH110	INR, INJ	325A, 1.1kV, 0.15A, 2.5V	C-50			
325PAH120	INR, INJ	325A, 1.2kV, 0.15A, 2.5V	C-50			
340RA10	INJ	300A, 100V, 0.15A, 3V	F-71	ECG5587		    
340RA20	INJ	300A, 200V, 0.15A, 3V	F-71	ECG5587		
340RA30	INJ	300A, 300V, 0.15A, 3V	F-71	ECG5587		
340RA40	INJ	300A, 400V, 0.15A, 3V	F-71	ECG5587		
340RA60	INJ	300A, 500V, 0.15A, 3V	F-71	ECG5587		
341RA10	INJ	300A, 100V, 0.15A, 3V	F-71			
341RA20	INJ	300A, 200V, 0.15A, 3V	F-71			
341RA30	INJ	300A, 300V, 0.15A, 3V	F-71			
341RA40	INJ	300A, 400V, 0.15A, 3V	F-71			
341RA60	INJ	300A, 500V, 0.15A, 3V	F-71			
350P2SP	NEC	550A, 200V, 0.125A, 3V	F-89			
350P4SP	NEC	550A, 400V, 0.125A, 3V	F-89			
350P6SP	NEC	550A, 600V, 0.125A, 3V	F-89			
350P8SP	NEC	550A, 800V, 0.125A, 3V	F-89			
350P10SP	NEC	550A, 1kV, 0.125A, 3V	F-89			
350P12SP		350A, 1.2kV	F-89			
350P16SP		350A, 1.6kV	F-89			
350PAF10V	INR	350A, 100V, 0.2A, 2.5V	C-50			
350PAF20V	INR	350A, 200V, 0.2A, 2.5V	C-50			
350PAF40V	INR	350A, 400V, 0.2A, 2.5V	B-91			
350PAF60V	INR	350A, 600V, 0.2A, 2.5V				
350PEQ60W	INR	330A, 500V, 0.2A, 2.5V	C-10			



器件型号 Element type	厂名 Manufacturers	材料用途参数 Material Purpose Parameter	图号 Figure	国内外相似替换器件型号 Replace of similar type	备注 Notes	外形参考图 Reference shape	
350PEQ60W	INR	330A, 600V, 0.2A, 2.5V	C-10			 图 C-10	
350PEQ70W	INR	330A, 700V, 0.2A, 2.5V	C-10				
350PEQ80W	INR	330A, 800V, 0.2A, 2.5V	C-10				
350PEQ90W	INR	330A, 900V, 0.2A, 2.5V	C-10				
350PEQ100W	INR	330A, 1kV, 0.2A, 2.5V	C-10				
350PEQ110W	INR	330A, 1.1kV, 0.15A, 3V	C-10				
350PEQ120W	INR	330A, 1.2kV, 0.15A, 3V	C-10				
350RA10	INR, INJ	350A, 100V, 0.15A, 3V	F-71				 图 F-71
350RA20	INR, INJ	350A, 200V, 0.15A, 3V	F-71				
350RA30	INR, INJ	350A, 300V, 0.15A, 3V	F-71				
350RA40	INR, INJ	350A, 400V, 0.15A, 3V	F-71				
350RA60	INR, INJ	350A, 600V, 0.15A, 3V	F-71	ECG5587			
350RA80	INR, INJ	350A, 800V, 0.15A, 3V	F-71	ECG5589			
350RA100	INR, INJ	350A, 1kV, 0.15A, 3V	F-71	ECG5589			
350RA120	INR, INJ	350A, 1.2kV, 0.15A, 3V	F-71	ECG5589			
350RA130	INR, INJ	350A, 1.3kV, 0.15A, 3V	F-71				
350RA140	INR, INJ	350A, 1.4kV, 0.15A, 3V	F-71				
350RA150	INR, INJ	350A, 1.5kV, 0.15A, 3V	F-71				
350RA160	INR, INJ	350A, 1.6kV, 0.15A, 3V	F-71				
350RA170	INR, INJ	350A, 1.7kV, 0.15A, 3V	F-71				
350RA180	INR, INJ	350A, 1.8kV, 0.15A, 3V	F-71				
350TC-220SP		350A, 1kV	F-89			 图 F-89	
351RA10	INR, INJ	360A, 100V, 0.15A, 3V	F-71				
351RA20	INR, INJ	360A, 200V, 0.15A, 3V	F-71				
351RA30	INR, INJ	360A, 300V, 0.15A, 3V	F-71				
351RA40	INR, INJ	360A, 400V, 0.15A, 3V	F-71				
351RA60	INR, INJ	360A, 500V, 0.15A, 3V	F-71				

器件型号 Element type	厂名 Manufacturers	材料用途参数 Material Purpose Parameter	图号 Figure	国内外相似替换器件型号 Replace of similar type	备注 Notes	外形参考图 Reference shape	
351RA80	INR, INJ	350A, 600V, 0.15A, 3V	F-71			 图 F-71	
351RA100	INR, INJ	350A, 800V, 0.15A, 3V	F-71				
351RA120	INR, INJ	350A, 1kV, 0.15A, 3V	F-71				
351RA150	INR, INJ	350A, 1.4kV, 0.15A, 3V	F-71				
351RA160	INR, INJ	350A, 1.5kV, 0.15A, 3V	F-71				
351RA170	INR, INJ	350A, 1.6kV, 0.15A, 3V	F-71				
351RA180	INR, INJ	350A, 1.7kV, 0.15A, 3V	F-71				
353RA10	INR, INJ	350A, 100V, 0.15A, 3V	D-37				 图 D-37
353RA20	INR, INJ	350A, 200V, 0.15A, 3V	D-37				
353RA40	INR, INJ	350A, 400V, 0.15A, 3V	D-37				
353RA60	INR, INJ	350A, 600V, 0.15A, 3V	D-37				
353RA80	INR, INJ	350A, 800V, 0.15A, 3V	D-37				
353RA100	INR, INJ	350A, 1kV, 0.15A, 3V	D-37				
353RA120	INR, INJ	350A, 1.2kV, 0.15A, 3V	F-71				
353RA130	INR, INJ	0.15A, 3V	D-37				
353RA140	INR, INJ	350A, 1.4kV, 0.15A, 3V	D-37				
353RA150	INR, INJ	350A, 1.5kV, 0.15A, 3V	D-37				
353RA160	INR, INJ	350A, 1.6kV, 0.15A, 3V	D-37				
353RA170	INR, INJ	350A, 1.7kV, 0.15A, 3V	D-37				
353RA180	INR, INJ	350A, 1.8kV, 0.15A, 3V	D-37				
358RLE10	SCR-H	350A, 100V	F-84			 图 F-84	
358RLE20	SCR-H	350A, 200V	F-84				
358RLE30	SCR-H	350A, 300V	F-84				
358RLE40	SCR-H	350A, 400V					
358RS100		350A, 1kV					
358RS120		350A, 1.2kV	F-84				
358RS140		350A, 1.4kV	F-84				



器件型号 Element type	厂名 Manufacturers	材料用途参数 Material Purpose Parameter	图号 Figure	国内外相似替换器件型号 Replace of similar type	备注 Notes	外形参考图 Reference shape
358RS160		350A, 1.6kV	F-84			
400P2S	NEJ	628A, 200V, 0.125A, 3V	F-67			
400P2SP		400A, 200V	F-89			
400P4SP	NEJ	628A, 400V, 0.125A, 3V	F-89			
400P6SP	NEJ	628A, 600V, 0.125A, 3V	F-89			
400P8SP	NEJ	628A, 800V, 0.125A, 3V	F-89			
400PAH10	INR	400A, 100V, 0.15A, 2.5V	C-50			
400PAH20	INR	400A, 200V, 0.15A, 2.5V	C-50			
400PAH30	INR	400A, 300V, 0.15A, 2.5V	C-50			
400PAH40	INR	400A, 400V, 0.15A, 2.5V	C-50			
400PAH50	INR	400A, 500V, 0.15A, 2.5V	C-50			
400PAH60	INR	400A, 600V, 0.15A, 2.5V	C-50			
400S2SP	NEJ	628A, 200V, 0.125A, 3V	F-89			
400S3SP	NEJ	628A, 300V, 0.125A, 3V	F-89			
400S4SP	NEJ	628A, 400V, 0.125A, 3V	F-89			
400S5SP	NEJ	628A, 500V, 0.125A, 3V	F-89			
400S6SP	NEJ	628A, 600V, 0.125A, 3V	F-89			
400S8SP	NEJ	628A, 800V, 0.125A, 3V	F-89			
400SS2SP	NEJ	628A, 200V, 0.125A, 3V	F-89			
400SS3SP	NEJ	628A, 300V, 0.125A, 3V	F-89			
400SS4SP	NEJ	628A, 400V, 0.125A, 3V	F-89			
400SS5SP	NEJ	628A, 500V, 0.125A, 3V	F-89			
400SS6SP	NEJ	628A, 600V, 0.125A, 3V	F-89			
400SS8SP	NEJ	628A, 800V, 0.125A, 3V	F-89			
403PAB160		400A, 1.8kV	C-35			
403PAB200		400A, 2kV	C-35			

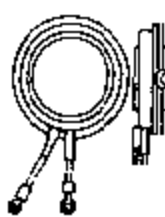
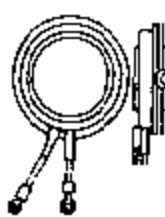
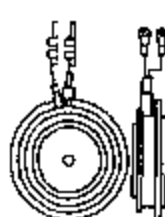

器件型号 Element type	厂名 Manufacturers	材料用途参数 Material Purpose Parameter	图号 Figure	国内外相似替换器件型号 Replace of similar type	备注 Notes	外形参考图 Reference shape
403PAB250		400A, 2.5KV	C-35			
408RP10		400A, 100V	F-84			
408RP20		400A, 200V	F-84			
408RP30		400A, 300V	F-84			
408RP40		400A, 400V	F-84			
408RP50		400A, 500V	F-84			
408RP60		400A, 600V	F-84			
408RP80		400A, 800V	F-84			
420PB30	INR	420A, 300V, 0.15A, 3V	C-50	ECG5595		
420PB50	INR, INJ	420A, 500V, 0.15A, 3V	C-50	ECG5595		
420PB60	INR, INJ	420A, 600V, 0.15A, 3V	C-50	ECG5595		
420PB80	INR, INJ	420A, 800V, 0.15A, 3V	C-50	ECG5595		
420PB100	INR, INJ	420A, 1KV, 0.15A, 3V	C-50	ECG5596		
420PB110	INR, INJ	660A, 1.1KV, 0.15A, 3V	C-50	ECG5596		
420PB120	INR, INJ	420A, 1.2KV, 0.15A, 3V	C-50	ECG5596		
420PB130	INR, INJ	660A, 1.3KV, 0.15A, 3V	C-50	ECG5596		
420PB140	INR, INJ	420A, 1.4KV, 0.15A, 3V	C-50	ECG5596		
420PB150	INR, INJ	420A, 1.5KV, 0.15A, 3V	C-50	ECG5596		
420PB160	INR, INJ	420A, 1.6KV, 0.15A, 3V	C-50	ECG5596		
420PB170	INR, INJ	420A, 1.7KV, 0.15A, 3V	C-50	ECG5596		
420PB180	INR	420A, 1.8KV, 0.15A, 3V	C-50	ECG5596		
420PB190	INR	420A, 1.9KV, 0.15A, 3V	C-50	ECG5596		
420PB200	INR	420A, 2KV, 0.15A, 3V	C-50	ECG5596		
420PBL50	INR, INJ	440A, 500V, 0.2A, 2.5V	C-50	ECG5386		
420PBL60	INR, INJ	420A, 600V, 0.2A, 2.5V	C-50	ECG5386		
420PBL80	INR, INJ	420A, 800V, 0.2A, 2.5V	C-50	ECG5387		
420PBL100	INR, INJ	420A, 1KV, 0.2A, 2.5V	C-50	ECG5387		

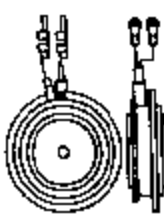
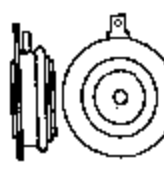

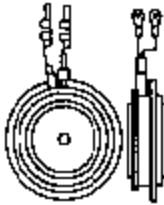
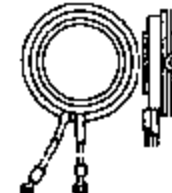
器件型号 Element type	厂名 Manufacturers	材料用途参数 Material Purpose Parameter	图号 Figure	国内外相似替换器件型号 Replace of similar type	备注 Notes	外形参考图 Reference shape
420PBL110	INR, INJ	420A, 1.1kV, 0.2A, 2.5V	C-50	ECG5387		 图 C-50
420PBL120	INR, INJ	420A, 1.2kV, 0.2A, 2.5V	C-50	ECG5387		
420PBM50	INR, INJ	420A, 500V, 0.2A, 2.5V	C-50	ECG5386		
420PBM60	INR, INJ	420A, 600V, 0.2A, 2.5V	C-50	ECG5386		
420PBM80	INR, INJ	420A, 800V, 0.2A, 2.5V	C-50	ECG5387		
420PBM100	INR, INJ	420A, 1kV, 0.2A, 2.5V	C-50	ECG5387		
420PBM110	INR, INJ	420A, 1.1kV, 0.2A, 2.5V	C-50	ECG5387		
420PBM120	INR, INJ	420A, 1.2kV, 0.2A, 2.5V	C-50	ECG5387		
450PEF80W	INR	450A, 800V, 0.2A, 2.5V	C-10			
450PEF100W	INR	450A, 1kV, 0.2A, 2.5V	C-10			
450PEF110W	INR	450A, 1.1kV, 0.2A, 2.5V	C-10			
450PEF120W	INR	450A, 1.2kV, 0.2A, 2.5V	C-10			
450PEF130W	INR	450A, 1.3kV, 0.2A, 2.5V	C-10			
450PEF140W	INR	450A, 1.4kV, 0.2A, 2.5V	C-10			
450PEF150W	INR	450A, 1.5kV, 0.2A, 2.5V	C-10			
450PEF160W	INR	450A, 1.6kV, 0.2A, 2.5V	C-10			
450PEF170W	INR	450A, 1.7kV, 0.2A, 2.5V	C-10			
450PEF180W	INR	450A, 1.8kV, 0.2A, 2.5V	C-10			
470PB30	INR, INJ	470A, 300V, 0.15A, 3V	C-50	FCG5595		 图 C-10
470PB40	INR	740A, 400V, 0.15A, 3V	C-50	ECG5595		
470PB50	INR, INJ	470A, 500V, 0.15A, 3V	C-50	ECG5595		
470PB60	INR, INJ	470A, 600V, 0.15A, 3V	C-50	ECG5596		
470PB80	INR, INJ	470A, 800V, 0.15A, 3V	C-50	ECG5596		
470PB100	INR, INJ	470A, 1kV, 0.15A, 3V	C-50	ECG5596		
470PB110	INR	470A, 1.1kV, 0.15A, 3V	C-50	ECG5596		
470PB120	INR, INJ	470A, 1.2kV, 0.15A, 3V	C-50	ECG5596		
470PB130	INJ	470A, 1.3kV, 0.15A, 3V	C-50	ECG5596		

器件型号 Element type	厂名 Manufacturers	材料用途参数 Material Purpose Parameter	图号 Figure	国内外相似替换器件型号 Replace of similar type	备注 Notes	外形参考图 Reference shape
470PB140	INR, INJ	470A, 1.4kV, 0.15A, 3V	C-50			 <p>图 C-50</p>
470PB150	INR, INJ	470A, 1.5kV, 0.15A, 3V	C-50			
470PB160	INR, INJ	470A, 1.6kV, 0.15A, 3V	C-50			
470PB170	INR, INJ	470A, 1.7kV, 0.15A, 3V	C-50			
470PB180	INR	470A, 1.8kV, 0.15A, 3V	C-50			
470PB190	INR	470A, 1.9kV, 0.15A, 3V	C-50			
470PB200	INR	470A, 2kV, 0.15A, 3V	C-50			
500P8H		500A, 800V	C-70			
500P12H	NEJ	785A, 1.2kV, 0.15A, 3V	C-70			
500P16H	NEJ	863A, 1.6kV, 0.15A, 3V	C-70			
500P20H	NEJ	785A, 2kV, 0.15A, 3V	C-70			
500P25H	NEJ	785A, 2.5kV, 0.15A, 3V	C-70			
500PA10	INR	785A, 100V, 0.25A, 3V	C-50			
500S10H	NEJ	785A, 1kV, 0.2A, 3V	C-70			
500S12H	NEJ	785A, 1.2kV, 0.2A, 3V	C-70			
500SS10H	NEJ	785A, 1kV, 0.2A, 3V	C-70			 <p>图 C-35</p>
501PBQ50	INJ	785A, 500V, 0.15A, 4V	C-50			
501PBQ60	INJ	785A, 600V, 0.15A, 4V	C-50			
501PBQ70	INJ	785A, 700V, 0.15A, 4V	C-50			
501PBQ80	INJ	785A, 800V, 0.15A, 4V	C-50			
501PBQ90	INJ	785A, 900V, 0.15A, 4V	C-50			
501PBQ100	INJ	785A, 1kV, 0.15A, 4V	C-50			
501PBQ110	INJ	785A, 1.1kV, 0.15A, 4V	C-50			
501PBQ120	INJ	785A, 1.2kV, 0.15A, 4V	C-50			
503PA100		500A, 1kV	C-35			

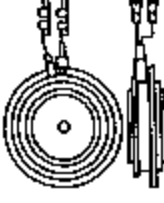

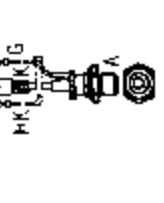

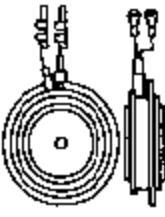
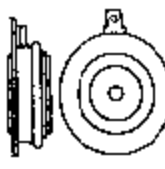
器件型号 Element type	厂名 Manufacturers	材料用途参数 Material Purpose Parameter	图号 Figure	国内外相似替换器件型号 Replace of similar type	备注 Notes	外形参考图 Reference shape
503PA120		500A, 1.2kV	C-35			 图 C-35
503PA140		500A, 1.4kV	C-35			
503PA160		500A, 1.6kV	C-35			
540PB30	INJ	550A, 300V, 0.15A, 3V	C-50			 图 C-50
540PB50	INJ	550A, 500V, 0.15A, 3V	C-50			
540PB60	INJ	550A, 600V, 0.15A, 3V	C-50			
550P4H	NEJ	863A, 400V, 0.15A, 3V	C-70			 图 C-70
550P6H	NEJ	863A, 600V, 0.15A, 3V	C-70			
550P8H	NEJ	863A, 800V, 0.15A, 3V	C-70			
550P10H	NEJ	863A, 1kV, 0.15A, 3V	C-70			
550P12H	NEJ	863A, 1.2kV, 0.15A, 3V	F-92			
550P16H	NEJ	550A, 1.6kV	C-70			
553PA60		550A, 600V	C-35			 图 C-70
553PA120		550A, 1.2kV	C-35			
600PBQ120	INR	550A, 1.2kV, 0.15A, 3V	C-50			 图 F-92
600PBQ140	INR	550A, 1.4kV, 0.15A, 3V	C-50			
600PBQ150	INR	550A, 1.5kV, 0.15A, 3V	C-50			
600PBQ160	INR	550A, 1.6kV, 0.15A, 2.5V	C-50			
600PBQ170	INR	550A, 1.7kV, 0.2A, 2.5V	C-50			
600PBQ180	INR	550A, 1.8kV, 0.2A, 2.5V	C-50			
600PE80	INR	GTO, 600A, 800V, 0.2A, 2.5V	C-15			
600PE120	INR	GTO, 600A, 1.2kV, 0.15A, 2.5V	C-15			
600PE140	INR	GTO, 600A, 1.4kV, 0.15A, 2.5V	C-15			
600PE160	INR	GTO, 600A, 1.6kV, 0.15A, 2.5V	C-15			
600PE180	INR	GTO, 600A, 1.8kV, 0.15A, 2.5V	C-15			

器件型号 Element type	厂名 Manufacturers	材料用途参数 Material Purpose Parameter	图号 Figure	国内外相似替换器件型号 Replace of similar type	备注 Notes	外形参考图 Reference shape
650PBQ50	INR, INJ	700A, 500V, 0.2A, 2.5V	C-50			 图 C-50
650PBQ60	INR, INJ	700A, 600V, 0.2A, 2.5V	C-50			
650PBQ70	INR, INJ	700A, 700V, 0.2A, 2.5V	C-50			
650PBQ80	INR, INJ	700A, 800V, 0.2A, 2.5V	C-50			
650PBQ90	INR, INJ	700A, 900V, 0.2A, 2.5V	C-50			
650PBQ100	INR, INJ	700A, 1kV, 0.2A, 2.5V	C-50			
650PBQ110	INR, INJ	700A, 1.1kV, 0.2A, 2.5V	C-50			
650PBQ120	INR, INJ	700A, 1.2kV, 0.2A, 2.5V	C-50			
650PEH50	INR	630A, 500V, 0.2A, 2V	C-10			
650PEH60	INR	630A, 600V, 0.2A, 2V	C-10			
650PEH80	INR	630A, 800V, 0.2A, 2V	C-10			
650PEH100	INR	630A, 1kV, 0.2A, 2V	C-10			
650PEH120	INR	630A, 1.2kV, 0.2A, 2V	C-10			
650PEH130	INR	630A, 1.3kV, 0.2A, 2V	C-10			
700PBQ10	INR	800A, 100V, 0.25A, 2.5V	C-50			 图 C-10
700PBQ20	INR	800A, 200V, 0.25A, 2.5V	C-50			
700PBQ30	INR	800A, 300V, 0.25A, 2.5V	C-50			
700PBQ40	INR	800A, 400V, 0.25A, 2.5V	C-50			
700PBQ50	INR	800A, 500V, 0.25A, 2.5V	C-50			
700PBQ60	INR	800A, 600V, 0.25A, 2.5V	C-50			
700PE10	INR	700A, 100V, 0.15A, 2.5V	C-10			
700PE20	INR	700A, 200V, 0.15A, 2.5V	C-10			
700PE40	INR	700A, 400V, 0.15A, 2.5V	C-10			
700PE60	INR	700A, 600V, 0.15A, 2.5V	C-10			
700PE80	INR	700A, 800V, 0.15A, 2.5V	C-10			
700PE100	INR	700A, 1kV, 0.15A, 2.5V	C-10			
700PK50	INR, INJ	800A, 500V, 0.15A, 2.5V	C-5			
700PK60	INR, INJ	800A, 600V, 0.15A, 2.5V	C-5			

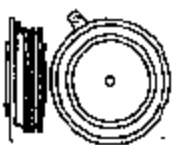
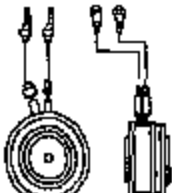
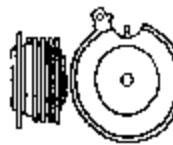

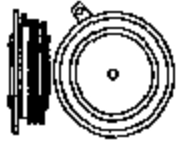
器件型号 Element type	厂名 Manufacturers	材料用途参数 Material Purpose Parameter	图号 Figure	国内外相似替换器件型号 Replace of similar type	备注 Notes	外形参考图 Reference shape
700PK80	INR, INJ	800A, 800V, 0.15A, 2.5V	C-5			 图 C-5
700PK100	INR, INJ	800A, 1kV, 0.15A, 2.5V	C-5			
700PK120	INR, INJ	800A, 1.2kV, 0.15A, 2.5V	C-5			
700PK140	INR, INJ	800A, 1.4kV, 0.15A, 2.5V	C-5			 图 C-44
700PK150	INR, INJ	800A, 1.5kV, 0.15A, 2.5V	C-44			
700PK160	INR, INJ	800A, 1.6kV, 0.15A, 2.5V	C-5			
700PK180	INR, INJ	800A, 1.8kV, 0.15A, 2.5V	C-5			 图 C-11
700PK200	INR, INJ	800A, 2kV, 0.15A, 2.5V	C-5			
700PK210	INR, INJ	800A, 2.1kV, 0.15A, 2.5V	C-5			
700PK230	INR, INJ	800A, 2.3kV, 0.15A, 2.5V	C-5			
700PK240	INR, INJ	800A, 2.4kV, 0.15A, 2.5V	C-5			
700PK250	INR, INJ	800A, 2.5kV, 0.15A, 2.5V	C-5			
700PK260	INR, INJ	800A, 2.6kV, 0.15A, 2.5V	C-5			
700PK270	INR, INJ	800A, 2.7kV, 0.15A, 2.5V	C-5			
700PK280	INR, INJ	800A, 2.8kV, 0.15A, 2.5V	C-5			
700PK290	INR, INJ	800A, 2.9kV, 0.15A, 2.5V	C-5			
700PK300	INR, INJ	800A, 3kV, 0.15A, 2.5V	C-5			
700PKL140W	INR	700A, 1.4kV, 0.2A, 3V	C-5			
700PKL150W	INR	700A, 1.5kV, 0.2A, 3V	C-5			
700PKL160S	INR	700A, 1.6kV, 0.15A, 3V	C-11			
700PKL160T	INR, INJ	700A, 1.6kV, 0.15A, 3V	C-5			
700PKL160W	INR	700A, 1.6kV, 0.2A, 3V	C-5			
700PKL170W	INR	700A, 1.7kV, 0.2A, 3V	C-5			
700PKL180S	INR, INJ	700A, 1.8kV, 0.15A, 3V	C-11			
700PKL180T	INR	700A, 1.8kV, 0.15A, 3V	C-5			
700PKL180W	INR	700A, 1.8kV, 0.2A, 3V	C-5			
700PKL190S	INR, INJ	700A, 1.9kV, 0.15A, 3V	C-5			
700PKL190T	INR, INJ	700A, 1.9kV, 0.15A, 3V	C-5			
700PKL190W	INR	700A, 1.9kV, 0.2A, 3V	C-5			

器件型号 Element type	厂名 Manufacturers	材料用途参数 Material Purpose Parameter	图号 Figure	国内外相似替换器件型号 Replace of similar type	备注 Notes	外形参考图 Reference shape	
700PKL200S	INR, INJ	700A, 2kV, 0.15A, 3V	C-5			 图 C-5	
700PKL200T	INR, INJ	700A, 2kV, 0.15A, 3V					
700PKL200W	INR	700A, 2kV, 0.2A, 3V					
700PKL210S	INR, INJ	700A, 2.1kV, 0.15A, 3V					
700PKL210T	INR, INJ	700A, 2.1kV, 0.15A, 3V					
700PKL220S	INR, INJ	700A, 2.2kV, 0.15A, 3V					
700PKL220T	INR, INJ	700A, 2.2kV, 0.15A, 3V					
750PEF10V	INR	750A, 100V, 0.2A, 2.5V		C-15			
750PEF20V	INR	750A, 200V, 0.2A, 2.5V	C-15				
750PEF40V	INR	750A, 400V, 0.2A, 2.5V	C-15				
750PEF60V	INR	750A, 600V, 0.2A, 2.5V	C-15				
750PEH10	INR	750A, 100V, 0.2A, 2V	C-10				
750PEH20	INR	750A, 200V, 0.2A, 2V	C-10				
750PEH30	INR	750A, 300V, 0.2A, 2V	C-10				
750PEH40	INR	750A, 400V, 0.2A, 2V	C-10				
750PEH50	INR	750A, 500V, 0.2A, 2V	C-10				
750PEH60	INR	750A, 600V, 0.2A, 2V	C-10				
803PA20		800A, 200V	C-35			 图 C-35	
803PA30		800A, 300V	C-35				
803PA40		800A, 400V	C-35				
803PA50		800A, 500V	C-35				
803PA60		800A, 600V	C-35				
803PA80		800A, 800V	C-35				
803PA100		800A, 1kV	C-35				
803PA120		800A, 1.2kV	C-35				
850PK50	INR, INJ	1kA, 500V, 0.15A, 3V	C-5	ECG5596			



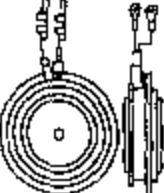
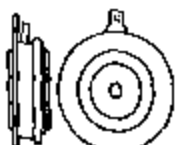
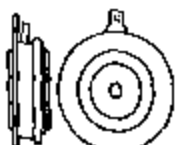
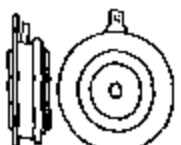
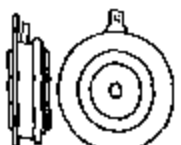
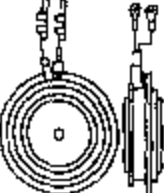
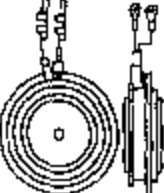
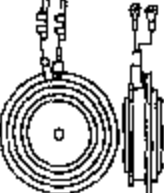
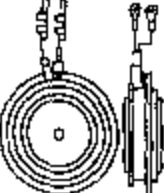
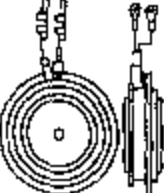
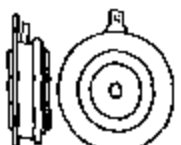
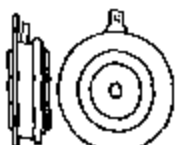

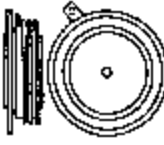
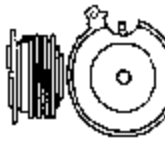
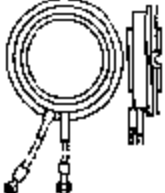
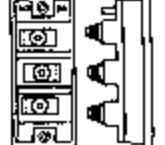
器件型号 Element type	厂名 Manufacturers	材料用途参数 Material Purpose Parameter	图号 Figure	国内外相似替换器件型号 Replace of similar type	备注 Notes	外形参考图 Reference shape
850PK60	INR, INJ	1kA, 600V, 0.15A, 3V	C-5	ECG5598		 图 C-5
850PK80	INR, INJ	1kA, 800V, 0.15A, 3V	C-5	ECG5599		
850PK100	INR, INJ	1kA, 1kV, 0.15A, 3V	C-5	ECG5599		 图 C-5
850PK120	INR, INJ	1kA, 1.2kV, 0.15A, 3V	C-5	ECG5599		
850PK140	INR, INJ	1kA, 1.4kV, 0.15A, 3V	C-5			 图 C-10
850PK150	INR, INJ	1kA, 1.5kV, 0.15A, 3V	C-5			
850PK160	INR, INJ	1kA, 1.6kV, 0.15A, 3V	C-5			 图 C-10
850PK200	INR, INJ	1kA, 2kV, 0.15A, 3V	C-5			
850PK210	INR, INJ	1kA, 2.1kV, 0.15A, 3V	C-5			 图 C-10
850PK220	INR, INJ	1kA, 2.2kV, 0.15A, 3V	C-5			
850PK230	INR	1kA, 2.3kV, 0.15A, 3V	C-5			 图 C-10
850PK240	INR	1kA, 2.4kV, 0.15A, 3V	C-5			
900PB10	INR	900A, 100V, 0.15A, 3V	C-50			 图 C-50
900PB20	INR	900A, 200V, 0.15A, 3V	C-50			
900PB30	INR	900A, 300V, 0.15A, 3V	C-50			 图 C-50
900PB40	INR	900A, 400V, 0.15A, 3V	C-50			
900PB50	INR	900A, 500V, 0.15A, 3V	C-50			 图 C-50
900PB60	INR	900A, 600V, 0.15A, 3V	C-50			
900PB80	INR	900A, 600V, 0.15A, 3V	C-50			 图 C-50
900PB100	INR	900A, 1kV, 0.15A, 3V	C-50			
900PB120	INR	900A, 1.2kV, 0.15A, 3V	C-50			 图 C-50
900PE10	INR	885A, 100V, 0.15A, 2.5V	C-10			
900PE20	INR	885A, 200V, 0.15A, 2.5V	C-10			 图 C-10
900PE40	INR	885A, 400V, 0.15A, 2.5V	C-10			
900PE60	INR	885A, 600V, 0.15A, 2.5V	C-10			 图 C-10
1000PK50	INR, INJ	1.2kA, 500V, 0.15A, 3V	C-5			
1000PK60	INR, INJ	1.2kA, 600V, 0.15A, 3V	C-5			

器件型号 Element type	厂名 Manufacturers	材料用途参数 Material Purpose Parameter	图号 Figure	国内外相似替换器件型号 Replace of similar type	备注 Notes	外形参考图 Reference shape	
1000PK80	INR, INJ	1.2kA, 800V, 0.15A, 3V	C-5			 图 C-5	
1000PK100	INR, INJ	1.2kA, 1kV, 0.15A, 3V	C-5				
1000PK140	INR, INJ	1.2kA, 1.4kV, 0.15A, 3V	C-5				
1000PK160	INR, INJ	1.2kA, 1.6kV, 0.15A, 3V	C-5				
1000PK170	INR	1.2kA, 1.7kV, 0.15A, 3V	C-11				
1000PK180	INR	1.2kA, 1.8kV, 0.15A, 3V	C-5				
1000PKL60S	INR, INJ	1kA, 600V, 0.15A, 3V					
1000PKL60T	INR, INJ	1kA, 600V, 0.15A, 3V					
1000PKL60W	INR	1kA, 600V, 0.2A, 3V	C-5				
1000PKL80S	INR, INJ	1kA, 800V, 0.15A, 3V					
1000PKL80T	INR, INJ	1kA, 800V, 0.15A, 3V					
1000PKL80W	INR	1kA, 800V, 0.2A, 3V	C-5			 图 C-11	
1003PA100		1kA, 1kV	C-35				
1003PA120		1kA, 1.2kV	C-35				
1003PA140		1kA, 1.4kV	C-35				
1003PA160		1kA, 1.6kV	C-35				
1003PAB180		1kA, 1.8kV	C-35				
1003PAB200		1kA, 2kV	C-35				
1003PAB250		1kA, 2.5kV	C-35				
1200PN150	INR, INJ	1.2kA, 500V, 0.15A, 3V	C-5				 图 C-35
1200PN160	INR, INJ	1.2kA, 600V, 0.15A, 3V	C-5				
1200PN180	INR, INJ	1.2kA, 800V, 0.15A, 3V	C-5				
1200PN100	INR, INJ	1.2kA, 1kV, 0.15A, 3V	C-5				
1200PN120	INR, INJ	1.2kA, 1.2kV, 0.15A, 3V	C-5				
1200PN140	INR, INJ	1.2kA, 1.4kV, 0.15A, 3V	H-19				
1200PN150	INR, INJ	1.2kA, 1.5kV, 0.15A, 3V	C-5				
1200PN160	INR, INJ	1.2kA, 1.6kV, 0.15A, 3V	C-5				
						 图 H-19	

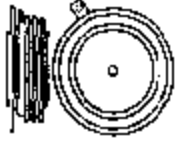
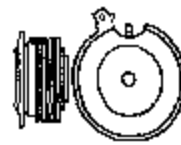

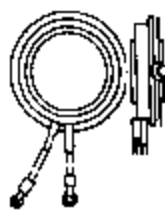
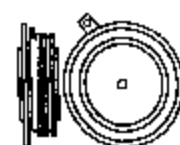
器件型号 Element type	厂名 Manufacturers	材料用途参数 Material Purpose Parameter	图号 Figure	国内外相似替换器件型号 Replace of similar type	备注 Notes	外形参考图 Reference shape	
1200PN180	INR, INJ	1.2kA, 1.8kV, 0.15A, 3V	C-5			 图 C-5	
1200PN200	INR, INJ	1.2kA, 2kV, 0.15A, 3V	C-5				
1200PN210	INR, INJ	1.2kA, 2.1kV, 0.15A, 3V	C-5				
1200PN220	INR, INJ	1.2kA, 2.2kV, 0.15A, 3V	C-5				
1200PN230	INR, INJ	1.2kA, 2.3kV, 0.15A, 3V	C-5				
1200PN240	INR, INJ	1.2kA, 2.4kV, 0.15A, 3V	C-5				
1200PN250	INR, INJ	1.2kA, 2.5kV, 0.15A, 3V	C-5				
1300PKL20S	INR	1.3kA, 200V, 0.15A, 3V	C-11				 图 C-11
1300PKL20W	INR	1.3kA, 200V, 0.2A, 3V	C-5				
1300PKL30S	INR	1.3kA, 300V, 0.15A, 3V	C-11				
1300PKL30T	INJ	1.3kA, 300V, 0.15A, 3V					
1300PKL30W	INR	1.3kA, 300V, 0.2A, 3V	C-5				
1300PKL40S	INR	1.3kA, 400V, 0.15A, 3V	C-11				
1300PKL40T	INJ	1.3kA, 400V, 0.15A, 3V					
1300PKL40W	INR	1.3kA, 400V, 0.2A, 3V	C-5				
1300PKL50S	INR	1.3kA, 500V, 0.15A, 3V	C-11				
1300PKL50T	INJ	1.3kA, 500V, 0.15A, 3V					
1300PKL50W	INR	1.3kA, 500V, 0.2A, 3V	C-5				
1300PKL60S	INR	1.3kA, 600V, 0.15A, 3V	C-11				
1300PKL60T	INJ	1.3kA, 600V, 0.15A, 3V					
1300PKL60W	INR	1.3kA, 600V, 0.2A, 3V	C-5				
1500PK10	INR	1.5kA, 100V, 0.15A, 3V	C-5				
1500PK20	INR	1.5kA, 200V, 0.15A, 3V	C-5				
1500PK30	INR	1.5kA, 300V, 0.15A, 3V	C-5				
1500PK40	INR	1.5kA, 400V, 0.15A, 3V	C-5				
1500PK50	INR	1.5kA, 500V, 0.15A, 3V	C-5				
1500PK60	INR	1.5kA, 600V, 0.15A, 3V	C-5				



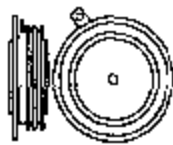
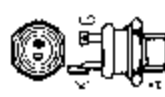

器件型号 Element type	厂名 Manufacturers	材料用途参数 Material Purpose Parameter	图号 Figure	国内外相似替换器件型号 Replace of similar type	备注 Notes	外形参考图 Reference shape
1503PA40		1.5kA, 400V	C-35			 图 C-35
1503PA50		1.5kA, 500V	C-35			
1503PA60		1.5kA, 600V	C-35			
1503PA80		1.5kA, 800V	C-35			
1503PA100		1.5kA, 1kV	C-35			
1503PA120		1.5kA, 1.2kV	C-35			
1900PN10	INR	1.9kA, 100V, 0.15A, 3V	C-5			 图 C-5
1900PN20	INR	1.9kA, 200V, 0.15A, 3V	C-5			
1900PN30	INR	1.9kA, 300V, 0.15A, 3V	C-5			
1900PN40	INR	1.9kA, 400V, 0.15A, 3V	C-5			
1900PN50	INR	1.9kA, 500V, 0.15A, 3V	C-5			
1900PN60	INR	1.9kA, 600V, 0.15A, 3V	C-5			
02201	SIT	35A, 100V, 0.04A, 2V	F-47			 图 F-47
02202	SIT	36A, 200V, 0.04A, 2V	F-47			
02203	SIT	36A, 300V, 0.04A, 2V	F-47			
02204	SIT	36A, 400V, 0.04A, 2V	F-47			
02205	SIT	36A, 500V, 0.04A, 2V	F-47			
02206	SIT	36A, 600V, 0.04A, 2V	F-47			
02301	SIT	36A, 100V, 0.04A, 2V	F-47			 图 F-47
02302	SIT	36A, 200V, 0.04A, 2V	F-47			
02303	SIT	36A, 300V, 0.04A, 2V	F-47			
02304	SIT	36A, 400V, 0.04A, 2V	F-47			
02305	SIT	36A, 500V, 0.04A, 2V	F-47			
02306	SIT	36A, 600V, 0.04A, 2V	F-47			
2500PR50	INR	2.5kA, 500V, 0.15A, 3V	C-5			





器件型号 Element type	厂名 Manufacturers	材料用途参数 Material Purpose Parameter	图号 Figure	国内外相似替换器件型号 Replace of similar type	备注 Notes	外形参考图 Reference shape	
2500PR60	INR	2.5kA, 600V, 0.15A, 3V	C-5			 图 C-5	
2500PR80	INR	2.5kA, 800V, 0.15A, 3V	C-5				
2500PR100	INR	2.5kA, 1kV, 0.15A, 3V	C-5				
2500PR120	INR	2.5kA, 1.2kV, 0.15A, 3V	C-5				
2500PR140	INR	2.5kA, 1.4kV, 0.15A, 3V	C-5				
2500PR150	INR	2.5kA, 1.5kV, 0.15A, 3V	C-5				
2500PR180	INR	2.5kA, 1.8kV, 0.15A, 3V	C-5				
03507	SIT	63A, 700V, 0.15A, 3V	F-21				 图 F-21
03508	SIT	63A, 800V, 0.15A, 3V	F-21				
03508GUF	SIT	55A, 800V, 0.15A, 1.1V	F-21				
03509	SIT	63A, 900V, 0.15A, 3V	F-21				
03509GUF	SIT	55A, 900V, 0.15A, 1.1V	F-21				
03510	SIT	63A, 1kV, 0.15A, 3V	F-21				
03510GUF	SIT	55A, 1kV, 0.15A, 1.1V	F-21				
03511	SIT	63A, 1.1kV, 0.15A, 3V	F-21				
03511GUF	SIT	55A, 1.1kV, 0.15A, 1.1V	F-21				
03512	SIT	63A, 1.2kV, 0.15A, 3V	F-21				
03512GUF	SIT	55A, 1.2kV, 0.15A, 1.1V	F-21				
03901FPF, GPF, HPF, HRF, HUJ	SIT	63A, 100V, 0.15A, 3V	F-21				
03901FUF, HRF, GUF	SIT	35A, 100V, 0.15A, 3V	F-21				
03902FPF, GPF, HPF, HRF, HUJ	SIT	63A, 200V, 0.15A, 3V	F-21				
03902FRF, FUF, GRF, GUF	SIT	40A, 200V, 0.15A, 3V	F-21				



器件型号 Element type	厂名 Manufacturers	材料用途参数 Material Purpose Parameter	图号 Figure	国内外相似替换器件型号 Replace of similar type	备注 Notes	外形参考图 Reference shape
03903FPF, GPF, HPF, HRF, HUF	SIT	63A, 300V, 0.15A, 3V	F-21			 图 F-21
03903FRF, FUF, GRF, GUF	SIT	40A, 300V, 0.15A, 3V	F-21			
03904FPF, GPT, HPF, HRF, HUF	SIT	63A, 400V, 0.15A, 3V	F-21			
03904FRF, FUF, GRF, GUF	SIT	40A, 400V, 0.15A, 3V	F-21			
03905FPF, GPF, HPF, HRF, HUF	SIT	63A, 500V, 0.15A, 3V	F-21			
03905FRF, FUF, GRF, GUF	SIT	40A, 500V, 0.15A, 3V	F-21			
03906FPF, GPF, HPF, HRF, HUF	SIT	63A, 600V, 0.15A, 3V	F-21			
03906FRF, FUF, GRF, GUF	SIT	40A, 600V, 0.15A, 3V	F-21			
4120-9	AEI	1.7kA, 800V, 0.15A, 3.5V				
05001	SIT	80A, 100V, 0.1A, 3V	F-21			
05002	SIT	80A, 200V, 0.1A, 3V	F-21			
05003	SIT	80A, 300V, 0.1A, 3V	F-21			
05004	SIT	80A, 400V, 0.1A, 3V	F-21			
05005	SIT	80A, 500V, 0.1A, 3V	F-21			
05006	SIT	80A, 600V, 0.1A, 3V	F-21			
05007	SIT	80A, 700V, 0.1A, 3V	F-21			
05008	SIT	80A, 800V, 0.1A, 3V	F-21			
05009	SIT	80A, 900V, 0.1A, 3V	F-21			
05010	SIT	80A, 1kV, 0.1A, 3V	F-21			



器件型号 Element type	厂名 Manufacturers	材料用途参数 Material Purpose Parameter	图号 Figure	国内外相似替换器件型号 Replace of similar type	备注 Notes	外形参考图 Reference shape	
05011	SIT	80A, 1.1kV, 0.1A, 3V	F-21			 图 F-21	
05012	SIT	80A, 1.2kV, 0.1A, 3V	F-21				
05201	SIT	85A, 100V, 0.1A, 3V	F-91			 图 F-91	
05202	SIT	85A, 200V, 0.1A, 3V	F-91				
05203	SIT	85A, 300V, 0.1A, 3V	F-91				
05204	SIT	85A, 400V, 0.1A, 3V	F-91				
05205	SIT	85A, 500V, 0.1A, 3V	F-91				
05206	SIT	85A, 600V, 0.1A, 3V	F-91				
07101GOA, OOA	SIT	110A, 100V, 0.1A, 3V	F-91			 图 F-91	
07101GOD, OOD	SIT	110A, 100V, 0.1A, 3V	B-74				
07102GOA, OOA	SIT	110A, 200V, 0.1A, 3V	F-91				
07102GOD, OOD	SIT	110A, 200V, 0.1A, 3V	B-74				
07103GOA, OOA	SIT	110A, 300V, 0.1A, 3V	F-91				
07103GOD, OOD	SIT	110A, 300V, 0.1A, 30V	B-74				
07104GOA, OOA	SIT	110A, 400V, 0.1A, 3V	F-91				
07104GOD, OOD	SIT	110A, 400V, 0.1A, 3V	B-74				
07105GOA, OOA	SIT	110A, 500V, 0.1A, 3V	F-91				
07105GOD, OOD	SIT	110A, 500V, 0.1A, 3V	B-74				
07106GOA, OOA	SIT	110A, 600V, 0.1A, 3V	F-91				
07106GOD, OOD	SIT	110A, 600V, 0.1A, 30V	B-74				
07607GUA, GWA, GXA, HUA, HWA, HXA, IUA, IWA, IXA	SIT	70A, 700V, 0.15A, 3.5V	F-91				 图 B-74
07607GUD, GXD, HUD, HWS, HXD, IUD, IWD, IXD	SIT	70A, 700V, 0.15A, 3.5V	B-74				

器件型号 Element type	厂名 Manufacturers	材料用途参数 Material Purpose Parameter	图号 Figure	国内外相似替换器型号 Replace of similar type	备注 Notes	外形参考图 Reference shape
07608GUA, GXA, HUA, HWA, HXA, IUA, IWA, IXA	SIT	70A, 800V, 0.15A, 3.5V	F-91			 图 F-91
07608GUD, GWD, GXD, HUD, HWD, HXD, IUD, IWD, IXD	SIT	70A, 800V, 0.15A, 3.5V	B-74			 图 B-74
07609GUA, GEA, GXA, HUA, HEA, HXA, IUA, IEA, IXA	SIT	70A, 900V, 0.15A, 3.5V	F-91			
07609GUD, GED, GXD, HUD, HWD, HXD, IUD, IWD, IXD	SIT	70A, 900V, 0.15A, 3.5V	B-74			
07610GUA, GWA, GXA, HUA, HWA, HXA, IUA, IWA, IXA	SIT	70A, 1kV, 0.15A, 3.5V	F-91			
07610GUD, GWD, GXD, HUD, HWD, HXD, IUD, IWD, IXD	SIT	70A, 1kV, 0.15A, 3.5V	B-74			
07611GUA, GWA, GXA, HUA, HWA, HXA, IUA, IWA, IXA	SIT	70A, 1.1kV, 0.15A, 3.5V	F-91			
07611GUD, GWD, GXD, HUD, HWD, HXD, IUD, IWD, IXD	SIT	70A, 1.1kV, 0.15A, 3.5V	B-74			
07612GUA, GWA, GXA, HUA, HWA, HXA, IUA, IWA, IXA	SIT	70A, 1.2kV, 0.15A, 3.5V	F-91			

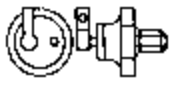

器件型号 Element type	厂名 Manufacturers	材料用途参数 Material Purpose Parameter	图号 Figure	国内外相似替换器件型号 Replace of similar type	备注 Notes	外形参考图 Reference shape
07612GUD, GWD, GXD, HUD, HWD, HXD, IUD, IWD, IXD	SIT	70A, 1.2kV, 0.15A, 3.5V	B-74			
07901GRA, GWA, HRA, HUA, HWA, IRA, IUA	SIT	125A, 100V, 0.15A, 3V	F-91			
07901GRD, GWD, HRD, HUD, HWD, IRD, IUD	SIT	12A, 100V, 0.15A, 3V	B-74			
07902GRA, GWA, HRA, HUA, HWA, IRA, IUA	SIT	125A, 200V, 0.15A, 3V	F-91			
07902GRD, GWD, HRD, HUD, HWD, IRD, IUD	SIT	12A, 200V, 0.15A, 3V	B-74			
07903GRA, GWA, HRA, HUA, HWA, IRA, IUA	SIT	125A, 300V, 0.15A, 3V	F-91			
07903GRD, GWD, HRD, HUD, HWD, IRD, IUD	SIT	12A, 300V, 0.15A, 3V	B-74			
07904GRA, GWA, HRA, HUA, HWA, IRA, IUA	SIT	125A, 400V, 0.15A, 3V	F-91			
07904GRD, GWD, HRD, HUD, HWD, IRD, IUD	SIT	12A, 400V, 0.15A, 3V	B-74			

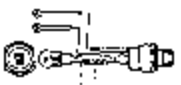
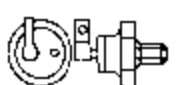
器件型号 Element type	厂名 Manufacturers	材料用途参数 Material Purpose Parameter	图号 Figure	国内外相似替换器件型号 Replace of similar type	备注 Notes	外形参考图 Reference shape
07905GRA, GWA, HRA, HUA, HWA, IRA, IUA	SIT	125A, 500V, 0.15A, 3V	F-91			 图 F-91
07905GRD, GWD, HRD, HUD, HWD, IRD, IUD	SIT	12A, 500V, 0.15A, 3V	B-74			
07906GRA, GWA, HRA, HUA, HWA, IRA, IUA	SIT	125A, 600V, 0.15A, 3V	F-91			
07906GRD, GWD, HRD, HUD, HWD, IRD, IUD	SIT	12A, 600V, 0.15A, 3V	B-74			 图 B-74
08001GOA	SIT	125A, 100V, 0.1A, 3V	F-91			
08001GOD	SIT	125A, 100V, 0.1A, 3V	B-74			
08002GOA	SIT	125A, 200V, 0.1A, 3V	F-91			
08002GOD	SIT	125A, 200V, 0.1A, 3V	B-74			
8003GOA, OOA	SIT	125A, 300V, 0.1A, 3V	F-91			
8003GOD, OOD	SIT	125A, 300V, 0.1A, 3V	B-74			
8004GOA, OOA	SIT	125A, 400V, 0.1A, 3V	F-91			
8004GOD, OOD	SIT	125A, 400V, 0.1A, 3V	B-74			
8005GOA, OOA	SIT	125A, 500V, 0.1A, 3V	F-91			
8005GOD, OOD	SIT	125A, 500V, 0.1A, 3V	B-74			
8006GOA, OOA	SIT	125A, 600V, 0.1A, 3V	F-91			
8006GOD, OOD	SIT	125A, 600V, 0.1A, 3V	B-74			
10101GOA, OOA	SIT	160A, 100V, 0.15A, 3V	F-91			
10102GOA, OOA	SIT	160A, 200V, 0.15A, 3V	F-91			
10103GOA, OOA	SIT	160A, 300V, 0.15A, 3V	F-91			

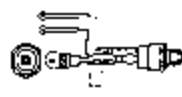
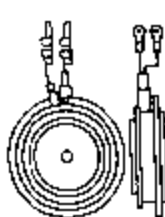

器件型号 Element type	厂名 Manufacturers	材料用途参数 Material Purpose Parameter	图号 Figure	国内外相似替换器件型号 Replace of similar type	备注 Notes	外形参考图 Reference shape
10104GOA, OOA	SIT	160A, 400V, 0.15A, 3V	F-91			 图 F-91
10105GOA, OOA	SIT	160A, 500V, 0.15A, 3V	F-91			
10106GOA, 100A	SIT	160A, 600V, 0.15A, 3V	F-91			
15101GOA, OOA	SIT	235A, 100V, 0.15A, 3V	F-91			 图 C-50
15102GOA, OOA	SIT	235A, 200V, 0.15A, 3V	F-91			
15103GOA, OOA	SIT	235A, 300V, 0.15A, 3V	F-91			
15104GOA, OOA	SIT	235A, 400V, 0.15A, 3V	F-91			
15105GOA, OOA	SIT	235A, 500V, 0.15A, 3V	F-91			
15106GOA, OOA	SIT	235A, 600V, 0.15A, 3V	F-91			
15607GWF, GXF, HWF, HXF	SIT	150A, 700V, 0.15A, 3V	C-50			
15608GWF, GXF, HWF, HXF	SIT	150A, 800V, 0.15A, 3V	C-50			
15609GWF, GXF, HWF, HXF	SIT	150A, 900V, 0.15A, 3V	C-50			
15610GWF, GXF, HWF, HXF	SIT	150A, 1kV, 0.15A, 3V	C-50			
15611GWF, GXF, HWF, HXF	SIT	150A, 1.1kV, 0.15A, 3V	C-50			
15612GWF, GXF, HWF, HXF	SIT	150A, 1.2kV, 0.15A, 3V	C-50			
15901GPF, GRF, GUF, HPF, HRF, HUF	SIT	175A, 100V, 0.15A, 3V	C-50			

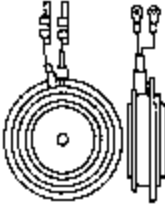
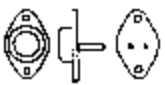

器件型号 Element type	厂名 Manufacturers	材料用途参数 Material Purpose Parameter	图号 Figure	国内外相似替换器件型号 Replace of similar type	备注 Notes	外形参考图 Reference shape
15902GPF, GRF, GUF, HPF, HRF, HUF	SIT	175A, 200V, 0.15A, 3V	C-50			 图 C-50
15903GPF, GRF, GUF, HPF, HRF, HUF	SIT	175A, 300V, 0.15A, 3V	C-50			
15904GPF, GRF, GUF, HPF, HRF, HUF	SIT	175A, 400V, 0.15A, 3V	C-50			 图 D-9
15905GPF, GRF, GUF, HPF, HRF, HUF	SIT	175A, 500V, 0.15A, 3V	C-50			
15906GPF, GRF, GUF, HPF, HRF, HUF	SIT	175A, 600V, 0.15A, 3V	C-50			
15907GRF, GUE, GUF	SIT	175A, 700V, 0.15A, 3V	C-50			
15908GRF, GUE, GUF	SIT	175A, 800V, 0.15A, 3V	C-50			
15909GRF, GUF	SIT	175A, 900V, 0.15A, 3V	C-50			
15910GRF, GUF	SIT	175A, 1kV, 0.15A, 3V	C-50			
15911GRF, GUF	SIT	175A, 1.1kV, 0.15A, 3V	C-50			
15912GRF, GUF	SIT	175A, 1.2kV, 0.15A, 3V	C-50			
16090		SCR-H 3.2A, 750V	D-9	S3703SF		
16091		SCR-H 3.2A, 700V	D-9	S3702S		
16121		SCR-H 3.2A, 750V	D-9	S3703SF		
16122		SCR-H 3.2A, 700V	D-9	S3702S		
16152		SCR-H 3.2A, 750V	D-9	S3703SF		

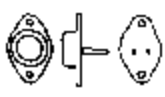
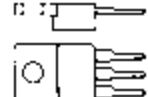

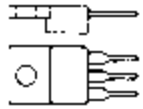

器件型号 Element type	厂名 Manufacturers	材料 Material	用途 Purpose	参数 Parameter	图号 Figure	国内外相似替换器件型号 Replace of similar type	备注 Notes	外形参考图 Reference shape
16157	SCR-H	3.2A, 700V		D-9	S3702S			 图 D-9
16410	SCR-H	3.2A, 750V		D-9	S3703SF			
16411	SCR-H	3.2A, 700V		D-9	S3702S			
16420	SCR-H	3.2A, 750V		D-9	S3703SF			
16421	SCR-H	3.2A, 700V		D-9	S3702S			
16443	SCR-H	3.2A, 600V, 200 μ A, 1.2V		B-11	TC106M			
16461	SCR-H	3.2A, 700V		D-9	S3702S			
16476	SCR-H	3.2A, 750V		D-9	S3703SF			
16477	SCR-H	3.2A, 700V		D-9	S3702S			
16488	50Hz-Thy	3.5A, 600V		B-11	TAG626-600			
16490	SCR-H	3.2A, 750V		D-9	S3703SF			
16491	SCR-H	3.2A, 700V		D-9	S3702S			
16640	SCR-H	3.2A, 750V		D-9	S3703SF			
16641	SCR-H	3.2A, 700V		D-9	S3702S			
16690	SCR-H	3.2A, 750V		D-9	S3703SF			
16691	SCR-H	3.2A, 700V		D-9	S3702S			
16837	50Hz-Thy	3.2A, 600V, 0.03A, 3V		D-9	2N4101			 图 B-11
16888	SCR-H	3.2A, 750V		D-9	S3703SF			
16889	SCR-H	3.2A, 700V		D-9	S3702S			
17016		8A, 700V, 0.04A, 4V		B-11	S3900S			
17019		8A, 750V, 0.04A, 4V		B-11	S3901S			
17020		8A, 700V, 0.04A, 4V		B-11	S3900S			
17021		8A, 750V, 0.04A, 4V		B-11	S3901S			
17022		8A, 700V, 0.04A, 4V		B-11	S3900S			
17023		8A, 750V, 0.04A, 4V		B-11	S3901S			
17024		8A, 700V, 0.04A, 4V		B-11	S3900S			
17025		8A, 750V, 0.04A, 4V		B-11	S3901S			
17026		8A, 700V, 0.04A, 4V		B-11	S3900S			
17027		8A, 750V, 0.04A, 4V		B-11	S3901S			

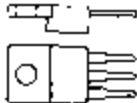
器件型号 Element type	厂名 Manufacturers	材料用途参数 Material Purpose Parameter	图号 Figure	国内外相似替换器件型号 Replace of similar type	备注 Notes	外形参考图 Reference shape
17028		8A, 700V, 0.04A, 4V	B-11	S3900S		 图 B-11
17029		8A, 750V, 0.04A, 4V	B-11	S3901S		
17030		8A, 700V, 0.04A, 4V	B-11	S3900S		
17031		8A, 750V, 0.04A, 4V	B-11	S3901S		
17032		8A, 700V, 0.04A, 4V	B-11	S3900S		
17033		8A, 750V, 0.04A, 4V	B-11	S3901S		
17034		8A, 700V, 0.04A, 4V	B-11	S3900S		
17035		8A, 750V, 0.04A, 4V	B-11	S3901S		
17036		8A, 700V, 0.04A, 4V	B-11	S3900S		
17037		8A, 750V, 0.04A, 4V	B-11	S3901S		
17040		8A, 700V, 0.04A, 4V	B-11	S3900S		
17041		8A, 750V, 0.04A, 4V	B-11	S3901S		
17052		8A, 700V, 0.04A, 4V	B-11	S3900S		
17053		8A, 750V, 0.04A, 4V	B-11	S3901S		
17054		8A, 700V, 0.04A, 4V	B-11	S3900S		
17055		8A, 750V, 0.04A, 4V	B-11	S3901S		
17056		8A, 700V, 0.04A, 4V	B-11	S3900S		
17057		8A, 750V, 0.04A, 4V	B-11	S3901S		
17058		8A, 700V, 0.04A, 4V	B-11	S3900S		
17058F		8A, 700V, 0.04A, 4V	B-11	S3900S		
17059		8A, 750V, 0.04A, 4V	B-11	S3901S		
17062		8A, 700V, 0.04A, 4V	B-11	S3900S		
17063		8A, 750V, 0.04A, 4V	B-11	S3901S		
17065		8A, 700V, 0.04A, 4V	B-11	S3900S		
17066		8A, 750V, 0.04A, 4V	B-11	S3901S		
17074		8A, 700V, 0.04A, 4V	B-11	S3900S		
17075		8A, 750V, 0.04A, 4V	B-11	S3901S		
17076		8A, 700V, 0.04A, 4V	B-11	S3900S		
17077		8A, 750V, 0.04A, 4V	B-11	S3901S		

其他

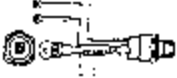
器件型号 Element type	厂名 Manufacturers	材料用途参数 Material Purpose Parameter	图号 Figure	国内外相似替换器件型号 Replace of similar type	备注 Notes	外形参考图 Reference shape	
17078		8A, 700V, 0.04A, 4V	B-11	S3900S		 图 B-11	
17079		8A, 750V, 0.04A, 4V	B-11	S3901S			
17080		8A, 700V, 0.04A, 4V	B-11	S3900S			
17085		8A, 700V, 0.04A, 4V	B-11	S3900S			
17087		8A, 750V, 0.04A, 4V	B-11	S3901S			
17088		8A, 700V, 0.04A, 4V	B-11	S3900S			
17089		8A, 750V, 0.04A, 4V	B-11	S3901S			
17401GOA	SIT	275A, 100V, 0.15A, 3V	F-91				 图 F-91
17402GOA	SIT	275A, 200V, 0.15A, 3V	F-91				
17403GOA	SIT	275A, 300V, 0.15A, 3V	F-91				
17404GOA	SIT	275A, 400V, 0.15A, 3V	F-91				
17405GOA	SIT	275A, 500V, 0.15A, 3V	F-91				
17406GOA	SIT	275A, 600V, 0.15A, 3V	F-91				
17407GOA	SIT	275A, 700V, 0.15A, 3V	F-91				
17408GOA	SIT	275A, 800V, 0.15A, 3V	F-91				
17409GOA	SIT	275A, 900V, 0.15A, 3V	F-91				
17410GOA	SIT	275A, 1kV, 0.15A, 3V	F-91				
17411GOA	SIT	275A, 1.1kV, 0.15A, 3V	F-91				
17412GOA	SIT	275A, 1.2kV, 0.15A, 3V	F-91				
17607IWA	SIT	235A, 700V, 0.15A, 3V	F-91				
17607IXA	SIT	235A, 700V, 0.15A, 3V	F-91				
17608IWA	SIT	235A, 800V, 0.15A, 3V	F-91				
17608IXA	SIT	235A, 800V, 0.15A, 3V	F-91				
17609IWA	SIT	235A, 900V, 0.15A, 3V	F-91				
17609IXA	SIT	235A, 900V, 0.15A, 3V	F-91				
17610IWA	SIT	235A, 1kV, 0.15A, 3V	F-91				
17611IWA	SIT	235A, 1.1kV, 0.15A, 3V	F-91				

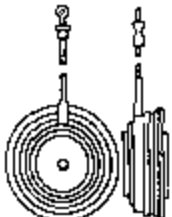



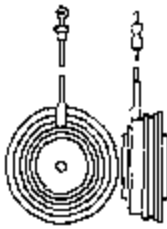

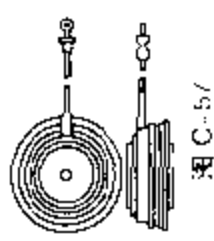
器件型号 Element type	厂名 Manufacturers	材料用途参数 Material Purpose Parameter	图号 Figure	国内外相似替换器件型号 Replace of similar type	备注 Notes	外形参考图 Reference shape
17611XA	SIT	235A, 1.1KV, 0.15A, 3V	F-91			 图 F-91
17901HRA	SIT	275A, 100V, 0.15A, 3V	F-91			
17901HUA	SIT	275A, 100V, 0.15A, 3V	F-91			
17902HRA	SIT	275A, 200V, 0.15A, 3V	F-91			
17902HUA	SIT	275A, 200V, 0.15A, 3V	F-91			
17903HRA	SIT	275A, 300V, 0.15A, 3V	F-91			
17903HUA	SIT	275A, 300V, 0.15A, 3V	F-91			
17904HRA	SIT	275A, 400V, 0.15A, 3V	F-91			
17904HUA	SIT	275A, 400V, 0.15A, 3V	F-91			
17905HRA	SIT	275A, 500V, 0.15A, 3V	F-91			
17905HUA	SIT	275A, 500V, 0.15A, 3V	F-91			
17906HRA	SIT	275A, 600V, 0.15A, 3V	F-91			
17906HUA	SIT	275A, 600V, 0.15A, 3V	F-91			
18022		8A, 700V, 0.04A, 4V	B-11	S3900S		
18052		8A, 700V, 0.04A, 4V	B-11	S3900S		
18051		8A, 750V, 0.04A, 4V	B-11	S3901S		 图 B-11
24001GOF	SIT	400A, 100V, 0.15A, 3V	C-57			
24001IOF	SIT	400A, 100V, 0.15A, 3V	C-57			
24002GOF	SIT	400A, 200V, 0.15A, 3V	C-57			
24002IOF	SIT	400A, 200V, 0.15A, 3V	C-57			
24003GOF	SIT	400A, 300V, 0.15A, 3V	C-57			
24003IOF	SIT	400A, 300V, 0.15A, 3V	C-57			
24004GOF	SIT	400A, 400V, 0.15A, 3V	C-57			
24004IOF	SIT	400A, 400V, 0.15A, 3V	C-57			
24005GOF	SIT	400A, 500V, 0.15A, 3V	C-57			
24005IOF	SIT	400A, 500V, 0.15A, 3V	C-57			 图 C-57



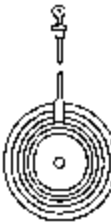

器件型号 Element type	厂名 Manufacturers	材料用途参数 Material Purpose Parameter	图号 Figure	国内外相似替换器件型号 Replace of similar type	备注 Notes	外形参考图 Reference shape
24005GOF	SIT	400A, 600V, 0.15A, 3V	C-57			 <p>图 C-57</p>
24006IOF	SIT	400A, 600V, 0.15A, 3V	C-57			
24007GOF	SIT	400A, 700V, 0.15A, 3V	C-57			
24007IOF	SIT	400A, 700V, 0.15A, 3V	C-57			
24008GOF	SIT	400A, 800V, 0.15A, 3V	C-57			
24008IOF	SIT	400A, 800V, 0.15A, 3V	C-57			
24009GOF	SIT	400A, 900V, 0.15A, 3V	C-57			
24009IOF	SIT	400A, 900V, 0.15A, 3V	C-57			
24010GOF	SIT	400A, 1kV, 0.15A, 3V	C-57			
24010IOF	SIT	400A, 1kV, 0.15A, 3V	C-57			
24011GOF	SIT	400A, 1.1kV, 0.15A, 3V	C-57			
24011IOF	SIT	400A, 1.1kV, 0.15A, 3V	C-57			
24012GOF	SIT	400A, 1.2kV, 0.15A, 3V	C-57			
24012IOF	SIT	400A, 1.2kV, 0.15A, 3V	C-57			
24013GOF	SIT	400A, 1.3kV, 0.15A, 3V	C-57			
24013IOF	SIT	400A, 1.3kV, 0.15A, 3V	C-57			
27901XF	SIT	430A, 100V, 0.15A, 3V	C-57			
27902XF	SIT	430A, 200V, 0.15A, 3V	C-57			
27903XF	SIT	430A, 300V, 0.15A, 3V	C-57			
27904XF	SIT	430A, 400V, 0.15A, 3V	C-57			
27905XF	SIT	430A, 500V, 0.15A, 3V	C-57			
27906XF	SIT	430A, 600V, 0.15A, 3V	C-57			
27907WFF	SIT	430A, 700V, 0.15A, 3V	C-57			
27908WFF	SIT	430A, 800V, 0.15A, 3V	C-57			
27909WFF	SIT	430A, 900V, 0.15A, 3V	C-57			
279010WFF	SIT	430A, 1kV, 0.15A, 3V	C-57			
279011WFF	SIT	430A, 1.1kV, 0.15A, 3V	C-57			
279012WFF	SIT	430A, 1.2kV, 0.15A, 3V	C-57			





























器件型号 Element type	厂名 Manufacturers	材料用途参数 Material Purpose Parameter	图号 Figure	国内外相似替换器件型号 Replace of similar type	备注 Notes	外形参考图 Reference shape
30001GOF	SIT	470A, 100V, 0.15A, 3V	C-57			 <p>图 C-57</p>
30001IOF	SIT	470A, 100V, 0.15A, 3V	C-57			
30002GOF	SIT	470A, 200V, 0.15A, 3V	C-57			
30002IOF	SIT	470A, 200V, 0.15A, 3V	C-57			
30003GOF	SIT	470A, 300V, 0.15A, 3V	C-57			
30003IOF	SIT	470A, 300V, 0.15A, 3V	C-57			
30004GOF	SIT	470A, 400V, 0.15A, 3V	C-57			
30004IOF	SIT	470A, 400V, 0.15A, 3V	C-57			
30005GOF	SIT	470A, 500V, 0.15A, 3V	C-57			
30005IOF	SIT	470A, 500V, 0.15A, 3V	C-57			
30006GOF	SIT	470A, 600V, 0.15A, 3V	C-57			
30006IOF	SIT	470A, 600V, 0.15A, 3V	C-57			
30007GOF	SIT	470A, 700V, 0.15A, 3V	C-57			
30007IOF	SIT	470A, 700V, 0.15A, 3V	C-57			
30008GOF	SIT	470A, 800V, 0.15A, 3V	C-57			
30008IOF	SIT	470A, 800V, 0.15A, 3V	C-57			
30009GOF	SIT	470A, 900V, 0.15A, 3V	C-57			
30009IOF	SIT	470A, 900V, 0.15A, 3V	C-57			
30010GOF	SIT	470A, 1KV, 0.15A, 3V	C-57			
30010IOF	SIT	470A, 1KV, 0.15A, 3V	C-57			
30011GOF	SIT	470A, 1.1KV, 0.15A, 3V	C-57			
30011IOF	SIT	470A, 1.1KV, 0.15A, 3V	C-57			
30012GOF	SIT	470A, 1.2KV, 0.15A, 3V	C-57			
30012IOF	SIT	470A, 1.2KV, 0.15A, 3V	C-57			
30013GOF	SIT	470A, 1.3KV, 0.15A, 3V	C-57			
30013IOF	SIT	470A, 1.3KV, 0.15A, 3V	C-57			
30014GOF	SIT	470A, 1.4KV, 0.15A, 3V	C-57			
30014IOF	SIT	470A, 1.4KV, 0.15A, 3V	C-57			



器件型号 Element type	厂名 Manufacturers	材料用途参数 Material Purpose Parameter	图号 Figure	国内外相似替换器件型号 Replace of similar type	备注 Notes	外形参考图 Reference shape
30901HRF	SIT	430A, 100V, 0.15A, 3V	C-57			  <p>图 C-57</p>  <p>图 F-55</p>  <p>图 B-62</p>   <p>图 B-71</p>  <p>图 D-9</p>
30901HUF	SIT	430A, 100V, 0.15A, 3V	C-57			
30902HRF	SIT	430A, 200V, 0.15A, 3V	C-57			
30902HUF	SIT	430A, 200V, 0.15A, 3V	C-57			
30903HRF	SIT	430A, 300V, 0.15A, 3V	C-57			
30903HUF	SIT	430A, 300V, 0.15A, 3V	C-57			
30904HRF	SIT	430A, 400V, 0.15A, 3V	C-57			
30904HUF	SIT	430A, 400V, 0.15A, 3V	C-57			
30905HRF	SIT	430A, 500V, 0.15A, 3V	C-57			
30905HUF	SIT	430A, 500V, 0.15A, 3V	C-57			
30906HRF	SIT	430A, 600V, 0.15A, 3V	C-57			
30906HUF	SIT	430A, 600V, 0.15A, 3V	C-57			
40216		35A, 600V	F-55	S6431M		
40378		50Hz-Thy 4.5A, 200V, 0.015A, 1.5V	D-62	S2600B		
40379		50Hz-Thy 4.5A, 400V, 0.015A, 1.5V	B-62	S2600D		
40431		6A, 200V, 0.03A	B-62			
40432		6A, 400V, 0.03A	B-62			
40485	SPE	6A, 200V, 0.025A, 2.2V	B-71			
40486		6A, 400V, 0.025A	B-62			
40502		6A, 200V, 0.025A, 2.2V	D-9	T2710B		
40503		6A, 400V, 0.025A, 2.2V	D-9	T2710D		
40504		50Hz-Thy 6A, 200V, 0.025A, 2.2V	D-9	S2710B		
40505		50Hz-Thy 6A, 400V, 0.025A, 2.2V	D-9	S2710D		
40506		50Hz-Thy 6A, 600V, 0.025A, 2.2V	D-9	S2710M		
40507		50Hz-Thy 4.5A, 200V, 0.015A, 1.5V	B-62	S2600B		
40508		50Hz-Thy 4.5A, 400V, 0.015A, 1.5V	B-62	S2600D		
40509		Triac 6A, 200V, 0.025A, 2.2V	B-62	40485		
40510		Triac 6A, 400V	B-62	40486		

器件型号 Element type	厂名 Manufacturers	材料用途参数 Material Purpose Parameter	图号 Figure	国内外相似替换器件型号 Replace of similar type	备注 Notes	外形参考图 Reference shape
40511	Triac	6A, 200V, 0.025A, 2.2V	B-62	40431		 图 B-62
40512	Triac	6A, 400V	B-62	40432		
40525	Triac	2.5A, 100V, 0.003A, 2.2V	B-62	T2300A		
40526	Triac	2.5A, 200V, 0.003A, 2.2V	B-62	T2300B		 图 D-9
40527	Triac	2.5A, 400V, 0.003A, 2.2V	B-62	T2300D		
40528	Triac	2.5A, 100V, 0.01A, 2.2V	B-62	T2302A		
40529	Triac	2.5A, 200V, 0.01A, 2.2V	B-62	T2302B		
40530	Triac	2.5A, 400V, 0.01A, 2.2V	B-62	T2302D		
40531	Triac	1.9A, 100V, 0.003A, 2.2V	B-62	T2310A		
40532	Triac	1.9A, 200V, 0.003A, 2.2V	B-62	T2310B		
40533	Triac	1.9A, 400V, 0.003A, 2.2V	B-62	T2310D		
40534	Triac	4A, 100V	B-62	T2312A		
40535	Triac	4A, 200V	B-62	T2312B		
40536	Triac	4A, 400V	B-62	T2312D		
40553	SCR-H	3.2A, 200V, 0.04A, 3.5V	D-9	S3700B		
40554	SCR-H	3.2A, 400V, 0.04A, 3.5V	D-9	S3700D		
40555	SCR-H	3.2A, 600V, 0.04A, 3.5V	D-9	S3700M		
40575	Triac	15A, 200V, 0.03A, 2.5V	D-9	T4700R		
40576	Triac	15A, 400V, 0.03A, 2.5V	D-9	T4700D		
40638	Triac	6A, 200V, 0.025A, 2.2V	B-62	40485		
40639	Triac	6A, 400V	B-62	40486		
40640	SCR-H	5A, 600V, 0.032A, 4V	D-9	S3705M		
40641	SCR-H	5A, 800V, 0.045A, 4V	D-9	S3706M		
40654	50Hz-Thy	4.5A, 200V, 0.015A, 2.5V	B-62	S2600B		
40655	50Hz-Thy	4.5A, 400V, 0.015A, 2.5V	B-62	S2600D		
40656	50Hz-Thy	10A, 200V	B-62	S2620B		
40657	50Hz-Thy	10A, 400V	B-62	S2620D		
40658	50Hz-Thy	10A, 200V	B-62	S2610B		
40659	50Hz-Thy	10A, 400V	B-62	S2610D		



器件型号 Element type	厂名 Manufacturers	材料 Material	用途 Purpose	参数 Parameter	图号 Figure	国内外相似替换器件型号 Replace of similar type	备注 Notes	外形参考图 Reference shape
40660	Triac	30A, 200V	0.05A, 2.5V	D-14	T6401B			
40661	Triac	30A, 400V	0.05A, 2.5V	D-14	T6401D			
40662	Triac	30A, 200V	0.05A, 2.5V	D-14	T6411B			
40663	Triac	30A, 400V	0.05A, 2.5V	D-14	T6411D			
40664	Triac	6A, 450V		B-62				
40667	Triac	6A, 450V		B-62				
40668	Triac	8A, 200V	0.025A, 2.5V	B-11	T2800B			
40669	Triac	8A, 400V	0.025A, 2.5V	B-11	T2800D			
40670	Triac	8A, 600V	0.025A, 2.5V	B-11	T2800M			
40671	Triac	30A, 600V	0.05A, 2.5V	D-14	T6401M			
40672	Triac	40A, 600V		F-55	T6411M			
40680	Triac	22A, 100V	0.04A, 2V	E-8	S6420A			
40681	Triac	22A, 200V	0.04A, 2V	E-8	S6420B			
40682	Triac	22A, 400V	0.04A, 2V	E-8	S6420D			
40683	Triac	22A, 600V	0.04A, 2V	E-8	S6420M			
40684	Triac	3A, 100V		B-62	T2313A			
40685	Triac	3A, 200V		B-62	T2313B			
40686	Triac	3A, 400V		B-62	T2313D			
40687	Triac	3A, 600V		B-62	T2313M			
40688	Triac	30A, 200V	0.05A, 2.5V	E-8	T6420B			
40689	Triac	30A, 400V	0.05A, 2.5V	E-8	T6420D			
40690	Triac	40A, 600V		E-8	T6420M			
40691	Triac	2.5A, 200V	0.004A, 2.2V	B-62	T230AB			
40692	Triac	2.5A, 400V	0.004A, 2.2V	B-62	T2301D			
40693	Triac	1.9A, 100V	0.003A, 2.2V	B-62	T2316A			
40694	Triac	1.9A, 200V	0.003A, 2.2V	B-62	T2316B			
40695	Triac	1.9A, 400V	0.003A, 2.2V	B-62	T2316D			
40696	Triac	4A, 200V		B-62	T2306A			
40697	Triac	3A, 200V		B-62	T2306B			







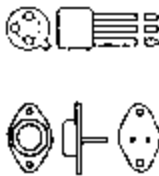
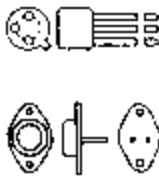
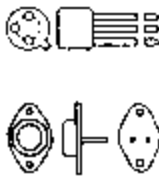
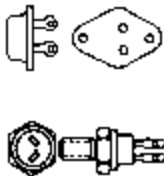
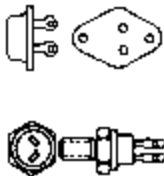
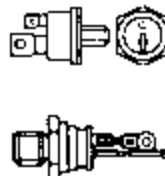
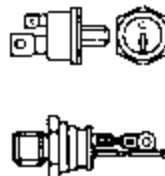



器件型号 Element type	厂名 Manufacturers	材料用途参数 Material Purpose Parameter	图号 Figure	国内外相似替换器件型号 Replace of similar type	备注 Notes	外形参考图 Reference shape
40698	Triac	3A, 400V	B-62	T2306D		
40699	Triac	40A, 200V, 0.05A, 2.5V	D-14	T6406B		
40700	Triac	40A, 400V, 0.05A, 2.5V	D-14	T6406D		
40701	Triac	40A, 600V, 0.05A, 2.5V	D-14	T6406M		
40702	Triac	40A, 200V	F-55	T6416B		
40703	Triac	40A, 400V	F-55	T6416D		
40704	Triac	40A, 600V	F-55	T6416M		
40705	Triac	30A, 200V, 0.045A, 2.5V	D-14	T6407B		
40756	Triac	30A, 400V, 0.045A, 2.5V	D-14	T6407D		
40707	Triac	30A, 200V, 0.05A, 2.5V	F-55	T6417B		
40708	Triac	30A, 400V, 0.05A, 2.5V	F-55	T6417D		
40709	Triac	30A, 600V, 0.05A, 2.5V	D-14	T6407M		
40710	Triac	30A, 600V, 0.05A, 2.5V	D-14	T6407M		
40711	Triac	15A, 200V, 0.045A, 1.5V	D-14	T4106B		
40712	Triac	15A, 400V, 0.045A, 1.5V	D-14	T4106D		
40713	Triac	15A, 200V, 0.045A, 1.5V	F-55	T4116B		
40714	Triac	15A, 400V, 0.045A, 1.5V	F-55	T4116D		
40715	Triac	15A, 200V	D-9	T4706B		
40716	Triac	15A, 400V	D-9	T4706D		
40717	Triac	10A, 200V	D-14	T4107B		
40718	Triac	10A, 400V	D-14	T4107D		
40719	Triac	10A, 200V, 0.045A, 1.5V	F-55	T4117B		
40720	Triac	10A, 400V, 0.045A, 1.5V	F-55	T4117D		
40721	Triac	8A, 200V	B-11	T2806B		
40722	Triac	8A, 400V, 0.045A, 1.5V	B-11	T2806D		
40723	Triac	6A, 450V	B-62	T2606DF		
40724	Triac	6A, 450V	B-62	T2616DF		
40725	Triac	6A, 200V	B-62	T2606B		
40726	Triac	6A, 400V	B-62	T2606D		











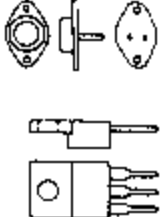

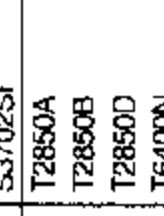
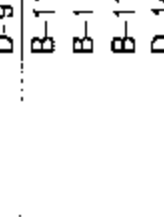
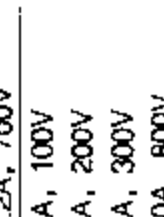
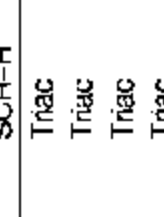
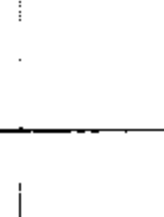
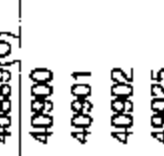
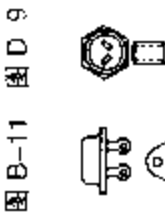
器件型号 Element type	厂名 Manufacturers	材料用途参数 Material Purpose Parameter	图号 Figure	国内外相似替换器件型号 Replace of similar type	备注 Notes	外形参考图 Reference shape
40727		Triac 6A, 200V, 0.025A, 2.2V	D-9	I2706B		 图 D-9 图 B-62
40728		Triac 6A, 400V, 0.025A, 2.2V	D-9	T2706D		
40729		Triac 6A, 200V, 0.025A, 2.2V	D-9	T2716B		
40730		Triac 6A, 400V, 0.025A, 2.2V	D-9	T2716D		
40731		Triac 6A, 200V, 0.025A, 2.2V	B-62			 图 D-9 图 B-62
40732		Triac 6A, 400V, 0.045A	B-62			
40733		Triac 6A, 200V, 0.025A, 2.2V	B-62			
40734		Triac 6A, 400V, 0.045A	B-62			
40735		Triac 16A, 600V, 0.5A, 4.5V	F-55	S7430M, 2N3653		 图 D-9 图 B-62
40737		50Hz-Thy 6.3A, 100V, 0.015A	D-14	BSID4026, S6200A, T6N100H, T8N100H		
40738		50Hz-Thy 6.3A, 200V, 0.015A	D-14	BSID4026, S6200B, T6N200H, T8N200H		
40739		50Hz-Thy 6.3A, 400V, 0.015A	D-14	BSID4026, S6200D, T6N400H, T8N400H		
40740		50Hz-Thy 6.3A, 600V, 0.015A	D-14	BSID4040, S6200M, T6N600H, T8N600H		 图 F-55 图 D-14
40741		50Hz-Thy 6.3A, 100V, 0.015A	F-55	BSID4126, S6200A, T6N100C, T8N100C		
40742		50Hz-Thy 6.3A, 200V, 0.015A	F-55	BSID4126, S6200B, T6N200C, T8N200C		
40743		50Hz-Thy 6.3A, 400V, 0.015A	F-55	BSID4126, S6200D, T6N400C, T8N400C		
40744		50Hz Thy 6.3A, 600V, 0.015A	F-55	BSID4140, S6200M, T6N600C, T8N600C		 图 F-55 图 D-14
40745		50Hz-Thy 6.3A, 100V, 0.015A	E-8	C230A3, S6220A		
40746		50Hz-Thy 6.3A, 200V, 0.015A	E-8	C230B3, S6220B		
40747		50Hz-Thy 6.3A, 400V, 0.015A	E-8	C230D3, S6220D		
40748	SPE	50Hz-Thy 6.3A, 600V, 0.015A, 2V	F-49	C230M3, S6220M, SK3504, SK5508		 图 E-8 图 F-49
40749		50Hz-Thy 20A, 100V, 0.015A, 2V	D-14	S6200A		
40750		50Hz-Thy 20A, 200V, 0.015A, 2V	D-14	S6200B		
40751		50Hz-Thy 20A, 400V, 0.015A, 2V	D-14	S6200D		
40752		50Hz-Thy 20A, 600V, 0.015A, 2V	D-14	S6200M		 图 E-8 图 F-49
40753		50Hz-Thy 20A, 100V, 0.015A, 2V	F-55	S6210A		
40754		50Hz-Thy 20A, 200V, 0.015A, 2V	F-55	S6210B		
40755		50Hz-Thy 20A, 400V, 0.015A, 2V	F-55	S6210D		
40756		50Hz-Thy 20A, 600V, 0.015A, 2V	F-55	S6210M		

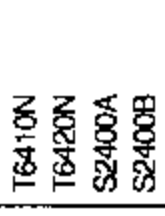
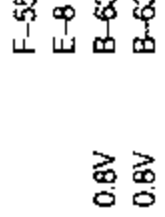
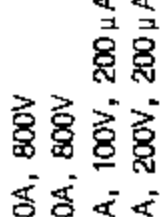
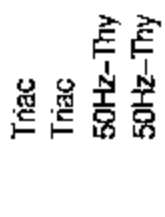
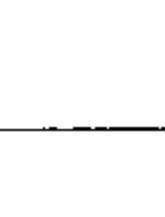
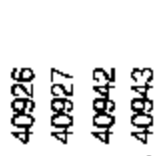
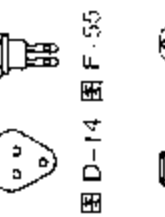
器件型号 Element type	厂名 Manufacturers	材料用途参数 Material Purpose Parameter	图号 Figure	国内外相似替换器件型号 Replace of similar type	备注 Notes	外形参考图 Reference shape
40757		50Hz-Thy 20A, 100V, 0.015A, 2V	E-8	S6220A		
40758		50Hz-Thy 20A, 200V, 0.015A, 2V	E-8	S6220B		
40759		50Hz-Thy 20A, 400V, 0.015A, 2V	E-8	S6220D		
40760		50Hz-Thy 20A, 600V, 0.015A, 2V	E-8	S6220M		
40761		Triac 1.9A, 200V, 0.004A, 2.2V	B-62	T2311B		
40762		Triac 1.9A, 400V, 0.004A, 2.2V	B-62	T2311D		
40766		Triac 2.5A, 100V, 0.004A, 2.2V	B-62	T2301A		
40767		Triac 4A, 200V	B-62	T2311A		
40768		SCR-H 5A, 600V	D-9	S3701M		
40769		Triac 4A, 200V	B-62	T2304B		
40770		Triac 4A, 400V	B-62	T2304D		
40771		Triac 4A, 200V	B-62	T2305B		
40772		Triac 4A, 400V	B-62	T2305D		
40773		Triac 2.5A, 200V, 0.04A	B-62	T2303B, T2306B, TAG208-200		
40774		Triac 2.5A, 400V, 0.04A	B-62	T2303D, T2306D, TAG208-400		
40775		Triac 6A, 200V	D-14	T4105B		
40776		Triac 6A, 400V	D-14	T4105D		
40777		Triac 6A, 200V	F-55	T4115B		
40778		Triac 6A, 400V	F-55	T4115D		
40779		Triac 10A, 200V	D-14	T4104B		
40780		Triac 10A, 600V	D-14	T4104D		
40781		Triac 10A, 200V	F-55	T411B		
40782		Triac 10A, 400V	F-55	T411D		
40783		Triac 15A, 200V	D-14	T4103B		
40784		Triac 15A, 400V	D-14	T4103D		
40785		Triac 15A, 200V	F-55	T4113B		
40786		Triac 15A, 400V	F-55	T4113D		
40787		Triac 25A, 200V	D-14	T6405B		
40788		Triac 25A, 400V	D-14	T6405D		

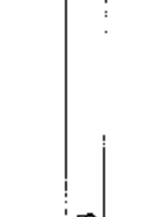
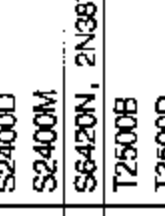

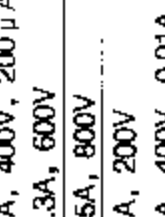
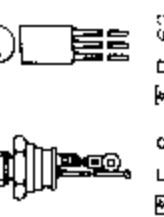
器件型号 Element type	名称 Manufacturers	材料用途参数 Material Purpose Parameter	图号 Figure	国内外相似替换器件型号 Replace of similar type	备注 Notes	外形参考图 Reference shape
40789	Triac	25A, 200V	F-55	T6415B		
40790	Triac	25A, 400V	F-55	T6415D		
40791	Triac	40A, 200V	D-14	T6404B		
40792	Triac	40A, 400V	D-14	T6404D		
40793	Triac	40A, 200V	F-55	T6414B		
40794	Triac	25A, 400V	F-55	T6414D		
40795	Triac	15A, 600V, 0.05A, 2.5V	D-14	T4101M		
40796	Triac	10A, 600V, 0.025A, 2.5V	F-55	T4111M		
40797	Triac	15A, 600V, 0.05A, 2.5V	D-14	T4100M		
40798	Triac	15A, 600V, 0.05A, 2.5V	F-55	T4110M		
40799	Triac	10A, 200V, 0.025A, 2.5V	E-8	T4121B		
40800	Triac	10A, 400V, 0.025A, 2.5V	E-8	T4121D		
40801	Triac	10A, 600V, 0.025A, 2.5V	E-8	T4121M		
40802	Triac	15A, 200V, 0.05A, 2.5V	E-8	T4120B		
40803	Triac	15A, 400V, 0.05A, 2.5V	E-8	T4120D		
40894	Triac	15A, 600V, 0.05A, 2.5V	E-8	T4120M		
40805	Triac	30A, 200V, 0.05A, 2.5V	E-8	T6421B		
40806	Triac	30A, 400V, 0.05A, 2.5V	E-8	T6421D		
40807	Triac	30A, 600V, 0.05A, 2.5V	E-8	T6421M		
40810	50Hz Thy	1.5A, 100V, 0.015A	B-62	TAG606-100, TAG612-100, TAG613-100		
40811	50Hz-Thy	1.5A, 200V, 0.015A	B-62	TAG606 200, TAG612-200, TAG613 200		
40812	50Hz-Thy	1.5A, 400V, 0.015A	B-62	TAG606-400, TAG612-400, TAG613-400		
40813	50Hz-Thy	1.5A, 600V, 0.015A	B-62	TAG606-600, TAG612-600, TAG613 600		
40833	50Hz-Thy	8A, 600V	B-62	S2600M		
40834	50Hz-Thy	10A, 600V	B-62	S2620M		
40835	50Hz-Thy	10A, 600V	B-62	S2610M		
40482	Triac	6A, 450V, 0.08A, 4V	B-11	T2801DF		
40867	50Hz-Thy	10A, 100V, 0.015A, 1.5V	B-11	S2800A		
40868	50Hz-Thy	10A, 200V, 0.015A, 1.5V	B-11	S2800B		

器件型号 Element type	厂名 Manufacturers	材料用途参数 Material Purpose Parameter	图号 Figure	国内外相似替换器件型号 Replace of similar type	备注 Notes	外形参考图 Reference shape
40869		50Hz-Thy 10A, 400V, 0.015A, 1.5V	B-11	S2800D		
40888(U)		SCR-H 3.2A, 750V	D-9	S3703SF		
40889(U)		SCR-H 3.2A, 700V	D-9	S3702SF		
40900		Triac 8A, 100V	B-11	T2850A		
40901		Triac 8A, 200V	B-11	T2850B		
40902		Triac 8A, 300V	B-11	T2850D		
49025		Triac 40A, 800V	D-14	T6400N		
40926		Triac 40A, 800V	F-55	T6410N		
40927		Triac 40A, 800V	E-8	T6420N		
40942		50Hz-Thy 3A, 100V, 200 μA, 0.8V	B-63	S2400A		
40943		50Hz-Thy 3A, 200V, 200 μA, 0.8V	B-63	S2400B		
40944		50Hz-Thy 3A, 400V, 200 μA, 0.8V	B-63	S2400D		
40945		50Hz-Thy 3.3A, 600V	B-63	S2400M		
40952		50Hz Thy 35A, 800V	E-8	S6420N, 2N3673		
41014		Triac 6A, 200V	B-11	T2500B		
41015		Triac 6A, 400V, 0.01A, 2.5V	B-11	T2500D		
41017		3.2A, 750V	D-9	S3800SF		
41018		3.2A, 650V	D-9	S3800MF		
41019		3.2A, 500V	D-9	S3800E		
41020		3.2A, 700V	D-9	S3800S		
41021		3.2A, 600V	D-9	S3800M		
41022		3.2A, 550V	D-9	S3800EF		
41023		3.2A, 400V	D-9	S3800D		
41420		3.2A, 700V	D-9	BSIC0146R		
55002GOF	SIT	865A, 200V, 0.3A, 3V	C-60			
55003COF	SIT	865A, 300V, 0.3A, 3V	C-60			
60811		SCR-H 3.2A, 750V	D-9	S3703SF		

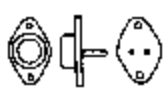
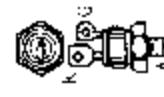

器件型号 Element type	厂名 Manufacturers	材料用途参数 Material Purpose Parameter	图号 Figure	国内外相似替换器件型号 Replace of similar type	备注 Notes	外形参考图 Reference shape
60912	SCR-H	3.2A, 700V	D-9	S370PS		
0220100F		35A, 100V	F-47	C228A		 图 D-9
0220200F		35A, 200V	F-47	C228B		
0220300F		35A, 400V	F-47	C228D		
0220400F		35A, 400V	F-47	C228D		
0220500F		35A, 600V	F-47	C228M		
0220600F		35A, 600V	F-47	C228M		
0230100F		35A, 100V	F-47	C228A		
0230200F		35A, 200V	F-47	C228B		
0230400		35A, 400V	F-47	C228D		
0230500		35A, 400V	F-47	C228D		
0230600		35A, 600V	F-47	C228M		
0230600F		35A, 200V	F-47	C228B		
						 图 F-47

其他类外形参考图索引



图 A-1



图 A-2

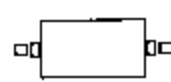

图 A-4

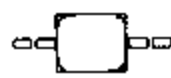

图 B-1



图 B-9



图 B-10

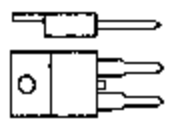

图 B-11

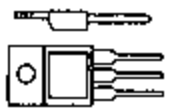

图 B-19



图 B-21

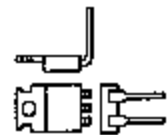

图 B-23

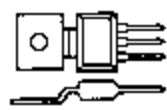

图 B-25

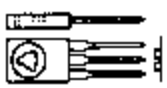

图 B-34

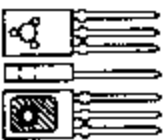

图 B-36



图 B-50

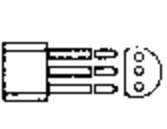

图 B-51

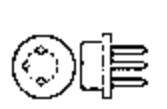

图 B-52



图 B-53



图 B-55

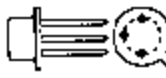

图 B-60

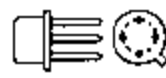

图 B-62



图 B-63



图 B-65

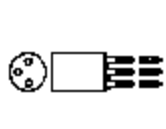

图 B-67



图 B-68

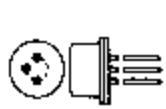

图 B-69



图 B-70

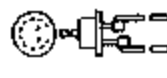

图 B-71

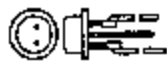

图 B-72



图 B-74



图 B-81

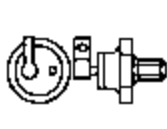

图 B-87



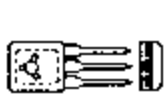

图 B-89

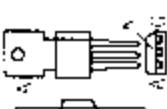

图 B-91

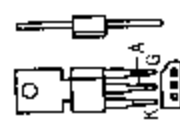

图 B-94

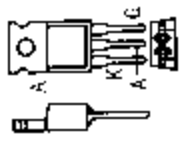

图 B-97

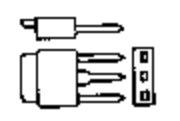

图 B-98

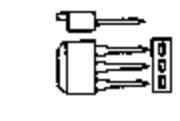

图 B-100

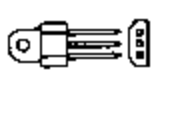

图 B-104

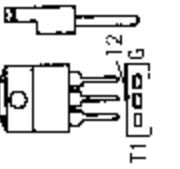

图 C-5

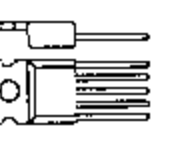

图 C-10

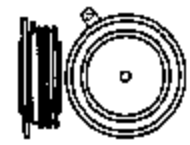

图 C-11

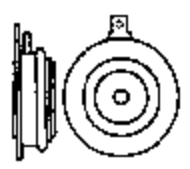

图 C-15

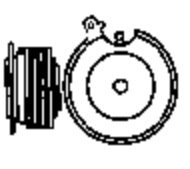

图 C-31

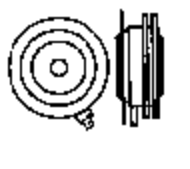

图 C-35

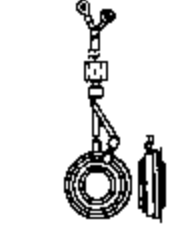

图 C-44

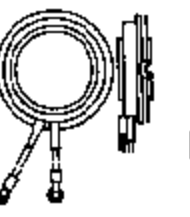

图 C-50

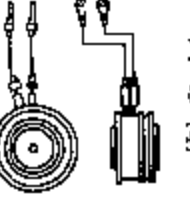

图 C-57

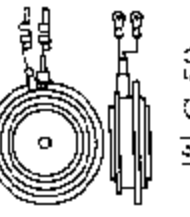

图 C-60

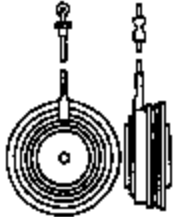

图 C-64

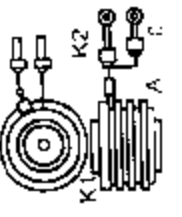

图 C-70

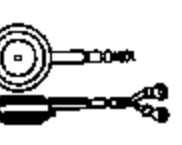

图 C-76

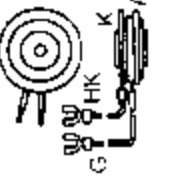

图 C-85

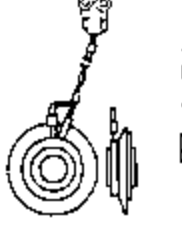

图 C-88

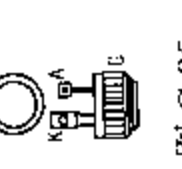

图 D-9

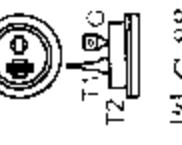

图 D-14

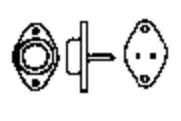

图 D-21

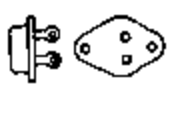

图 D-25

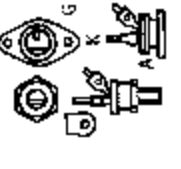

图 D-28

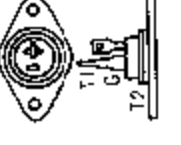

图 D-37

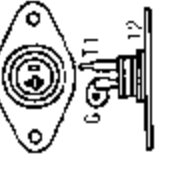

图 E-2



图 E-19



图 F-18

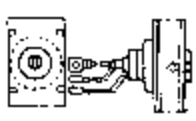

图 E-14

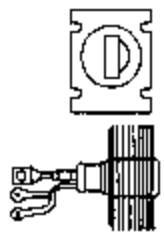

图 E-12

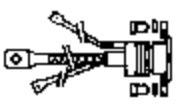

图 E-10

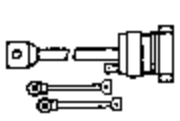

图 E-9

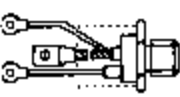

图 E-8

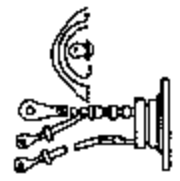

图 E-6



图 F-8



图 F-1

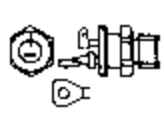

图 F-27



图 F-23

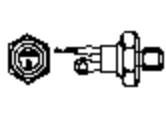

图 F-22



图 F-21

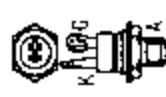

图 F-20



图 F-19

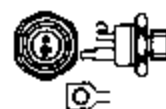

图 F-15



图 F-13

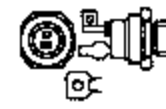

图 F-57



图 F-55

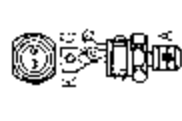

图 F-52



图 F-50



图 F-49

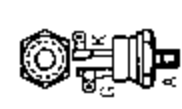

图 F-48

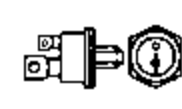

图 F-47

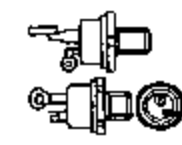

图 F-31



图 E-20



图 F-22

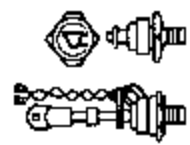

图 E-28

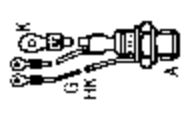

图 E-30

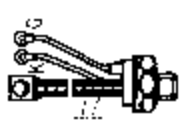

其他



图 F-59



图 F-60



图 F-61



图 F-63



图 F-65



图 F-67



图 F-71

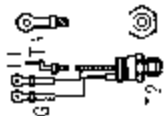

图 F-74

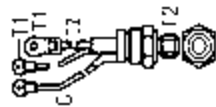

图 F-75



图 F-83



图 F-84

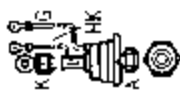

图 F-89



图 F-91



图 F-92



图 F-94

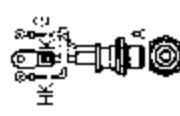

图 F-95



图 F-98



图 F-100

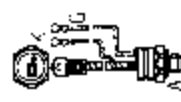

图 G-2

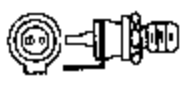

图 G-4



图 G-5

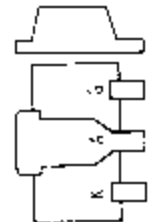

图 H-13

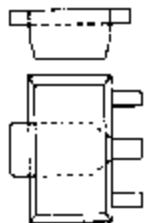

图 H-19

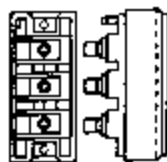

图 H-29



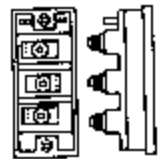

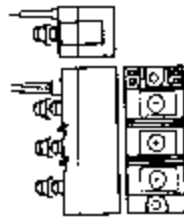

图 H-9

<p>A-1</p> 	<p>A-2</p> 	<p>A-3</p> 	<p>A-4</p> 
<p>A-5</p> 	<p>A-6</p> 	<p>A-7</p> 	<p>A-8</p> 

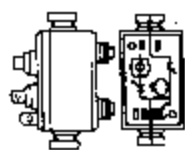
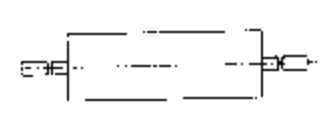
外形图

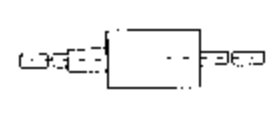
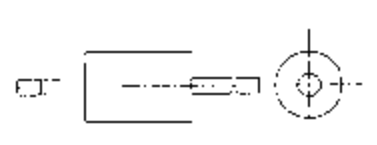
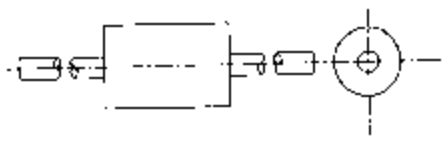
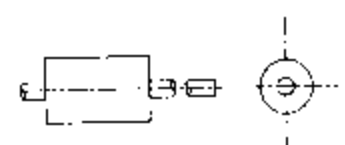
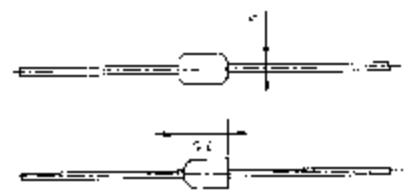
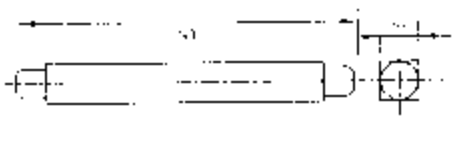
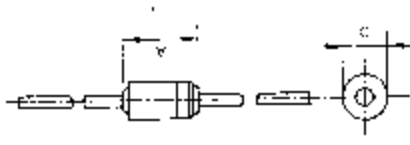
A-9 	A-10 	A-11 	A-12 	A-13 
--	---	---	---	---

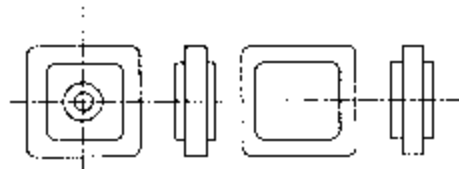
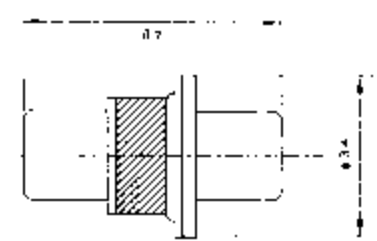
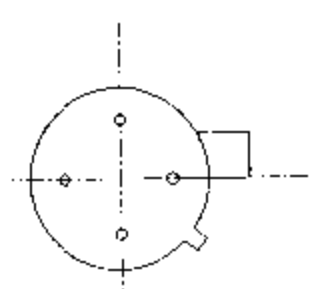
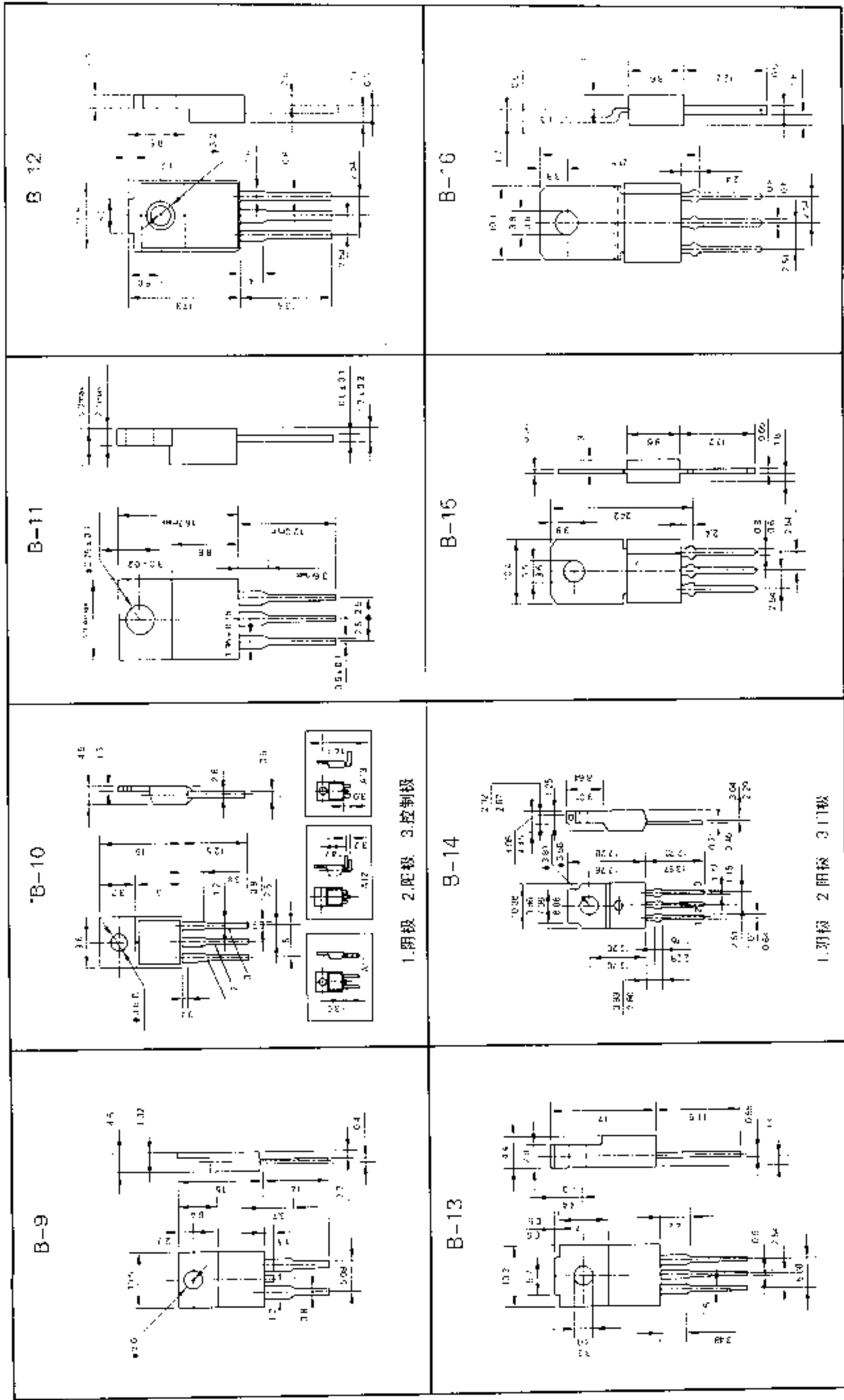

1. 阴极 2. 靶极 3. 控制极

B-33

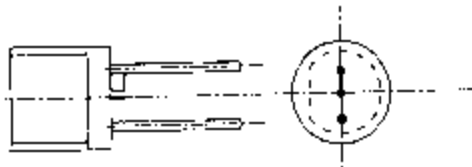

B-34

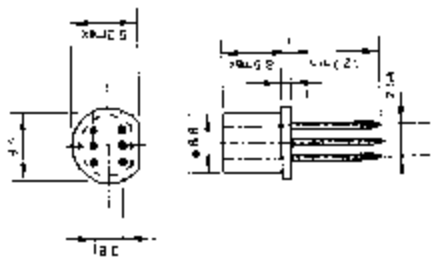

B-37

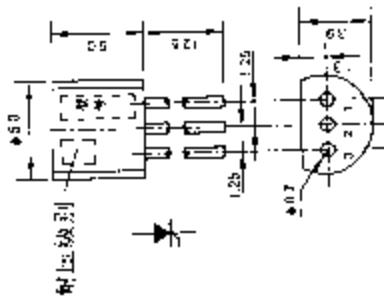

1. 阴极 2. 阳极 3. 控制极

B-38

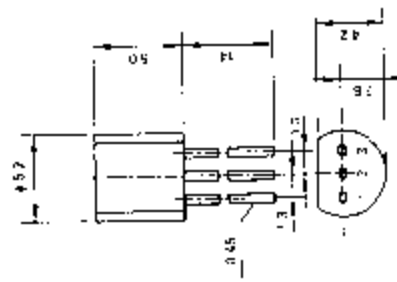

1. T1 2. 控制极 3. T2

B-35

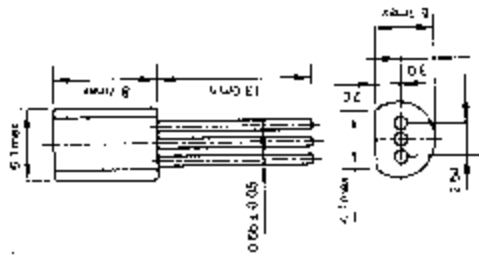

1. 控制极 2. 阳极 3. 阴级

B-36

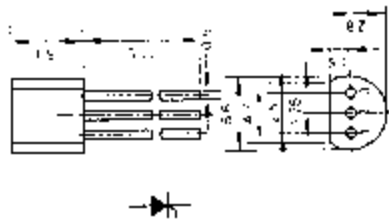

1. 控制极 2. 阳极 3. 阴级

B-40

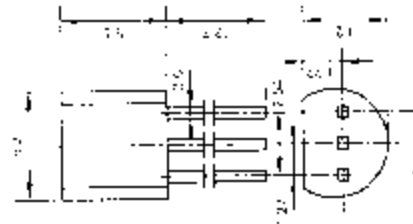

外形图

B-49

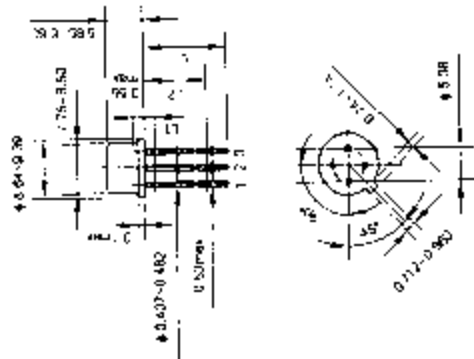

B-50

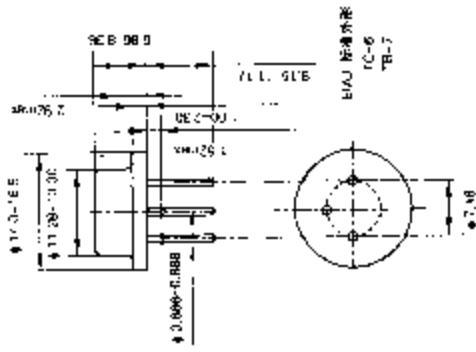

B-53

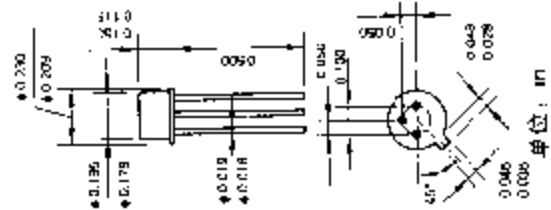

B-54

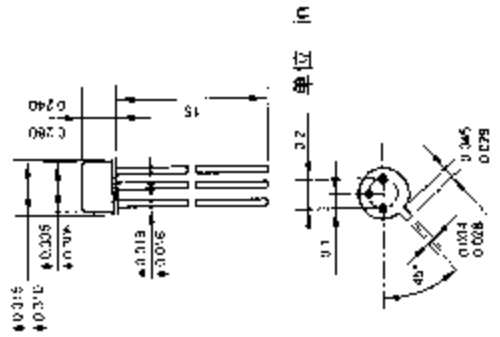

B-51

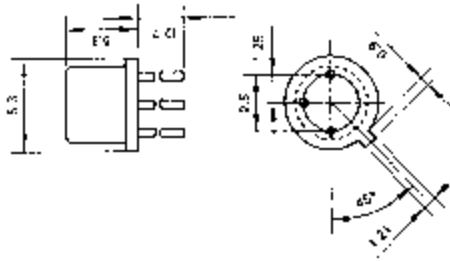

B-55

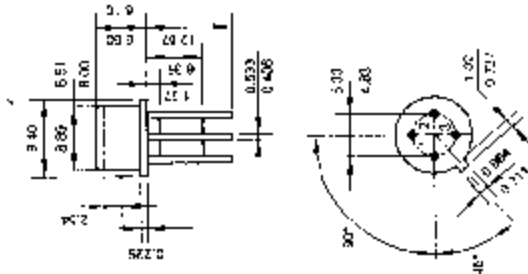

B-56

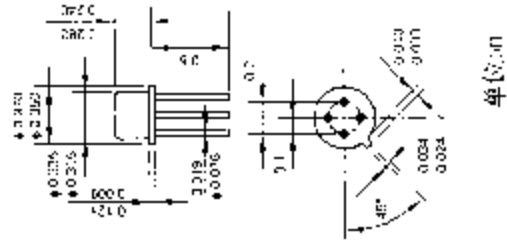

B-52

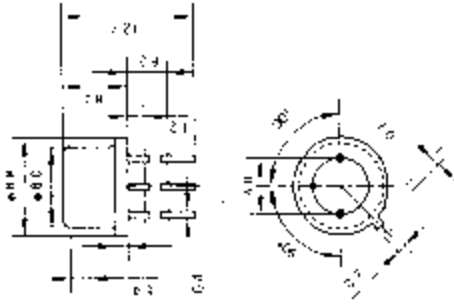

B-57

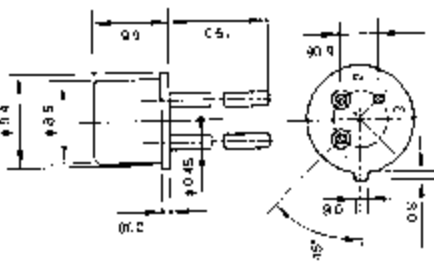

1. 阴极 2. 控制极 3. 阳极 (壳)

B-58

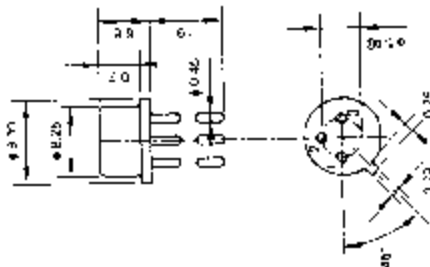

1. 阳极 2. 控制极 3. 阴极 (壳)

B-61

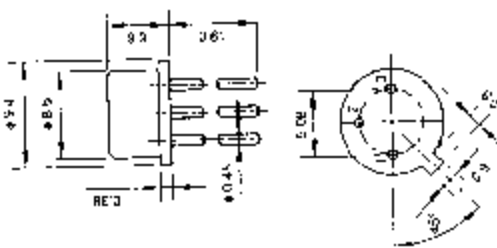

1. 阳极 2. 控制极 3. 阴极

B-59

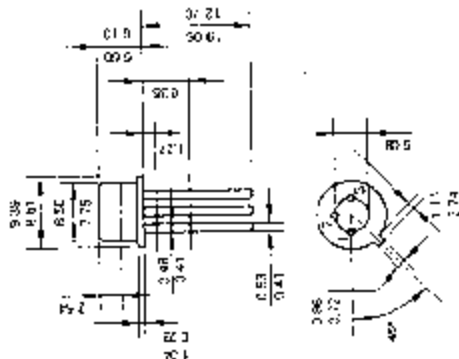

1. 阴极 2. 门极 3. 阳极

B-63

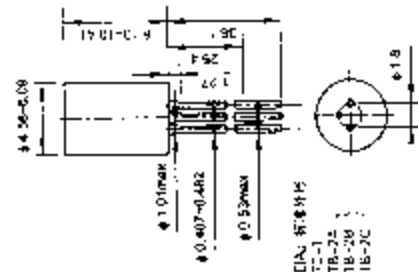

材料: 45号钢
1: 1:1
TR-72
TR-73
TR-7C

B-60

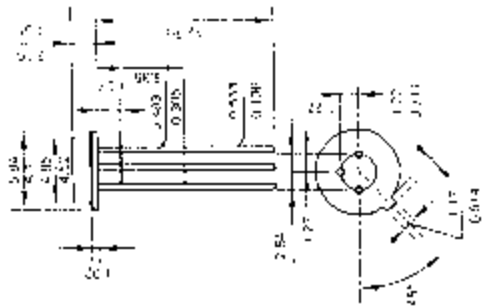

B-64

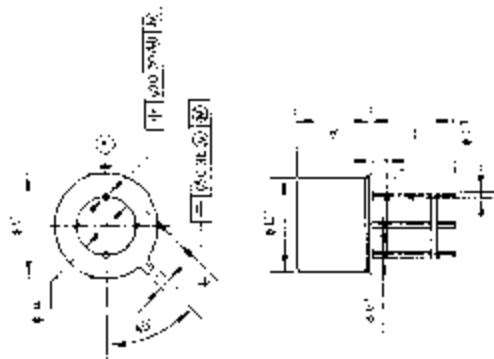

B-68

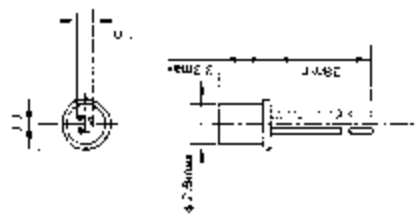

B-72

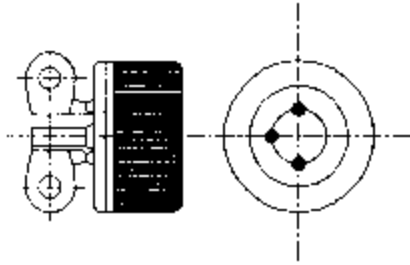

B-67

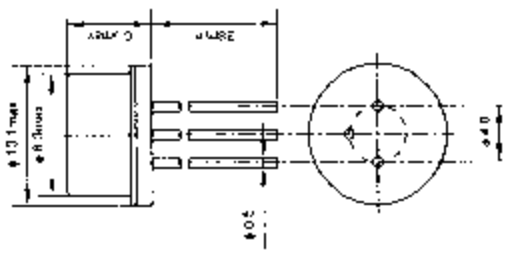

B-71

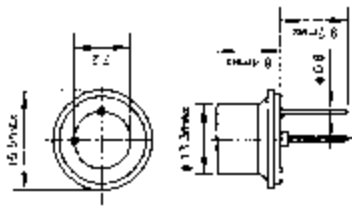

B-66

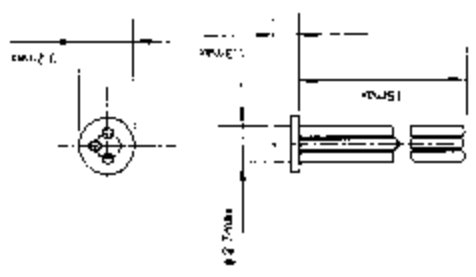

B-70

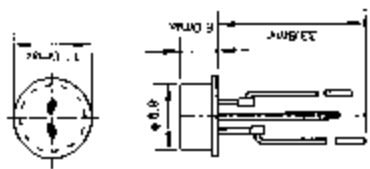

B-65

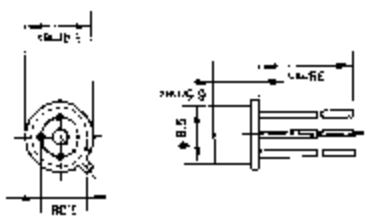

B-69

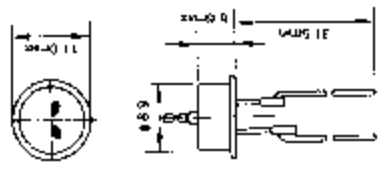

<p>B-73</p>	<p>B-74</p>	<p>B-75</p>	<p>B-76</p>
<p>B-77</p>	<p>B-78</p>	<p>B-79</p>	<p>B-80</p>
		<p>1. 阴极 2. 阳极 3. 控制极 4. 阳板</p>	<p>1. 阴极 2. 阳板 3. 门极</p>

B-105

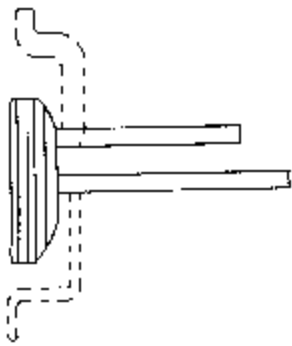

B-109

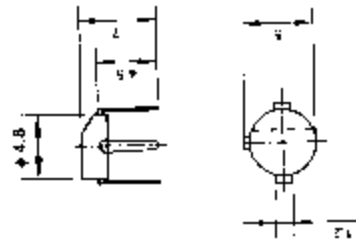

B-106

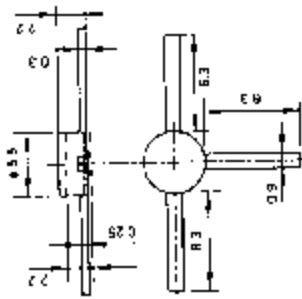

B-107

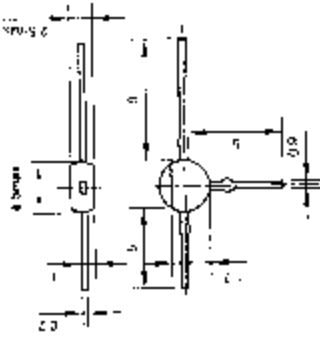

B-108

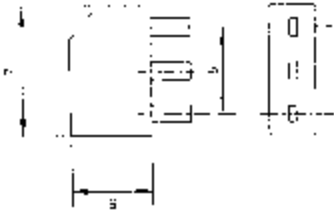

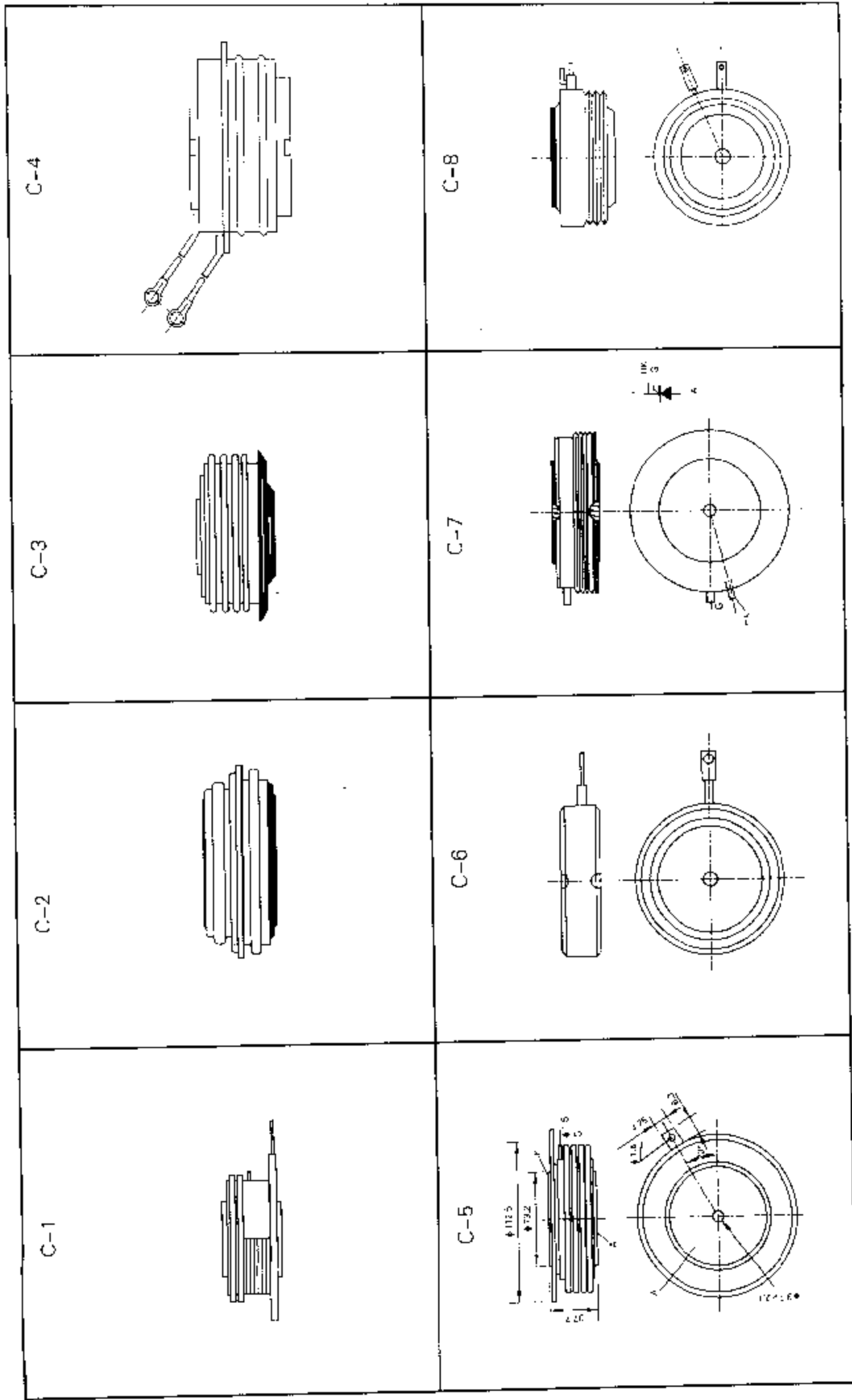

外形图

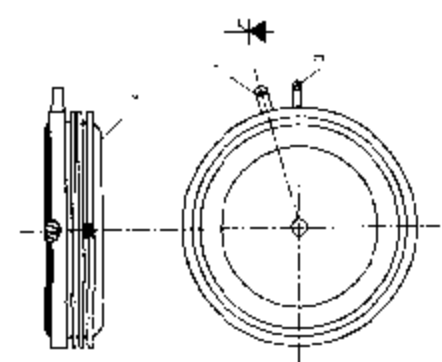
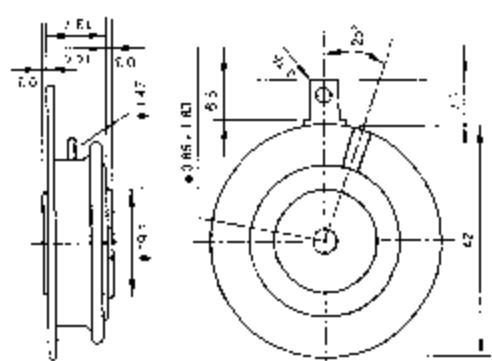
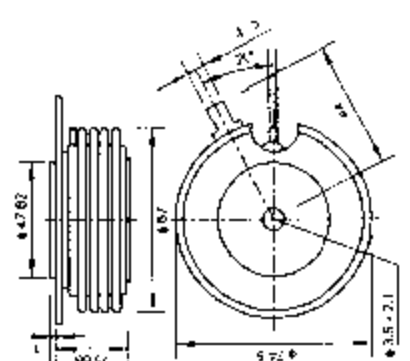
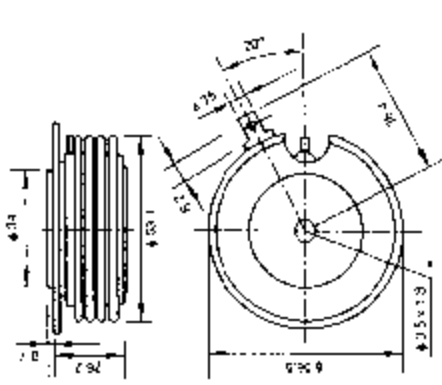
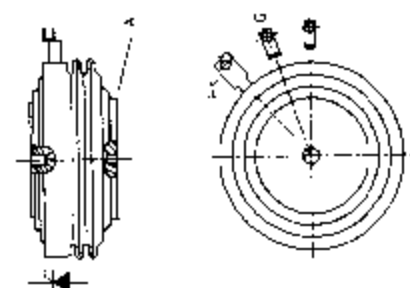
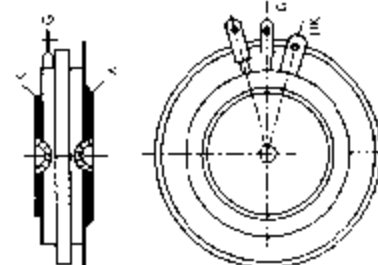
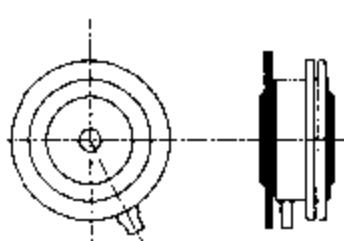
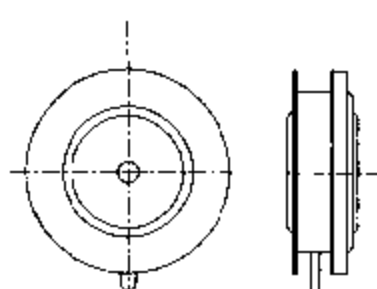
<p>C-9</p>  <p>1. 附板 2. 阳极 3. 控制板</p>	<p>C-10</p> 	<p>C-11</p> 	<p>C-12</p> 
<p>C-13</p> 	<p>C-14</p> 	<p>C-15</p> 	<p>C-16</p> 

C 17

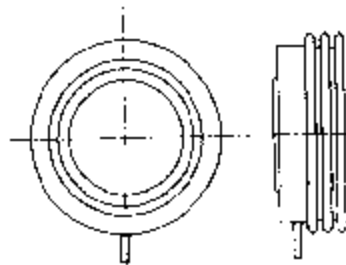

C-18

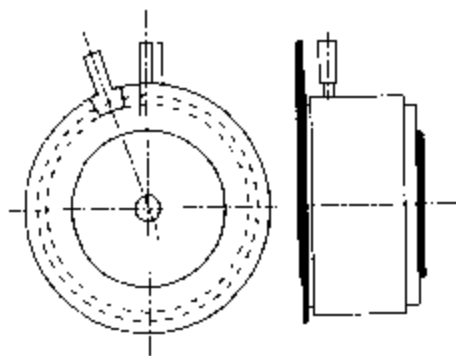

C-19

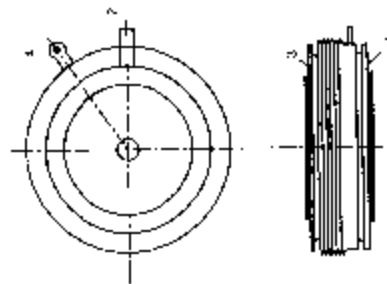

1. 阴极 2. 辅助阳极 3. 阳极 4. 控制极

C-20

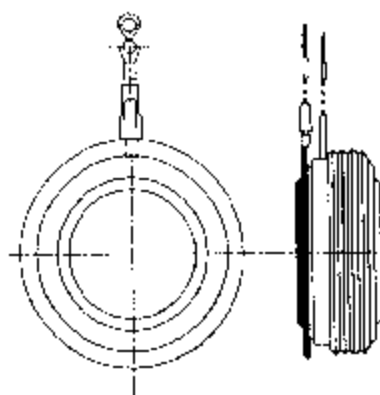

C-21

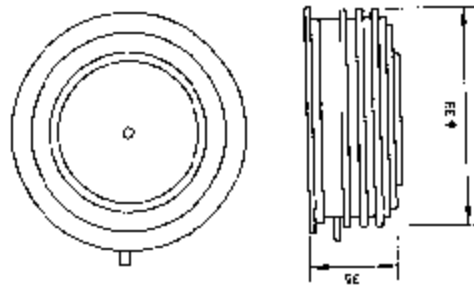

C-22

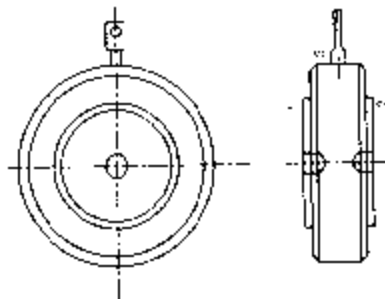

1. 阳极 2. 阴极 3. 控制极

C-23

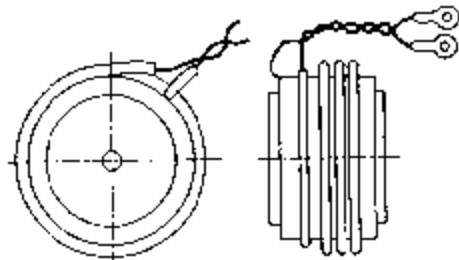

C-24

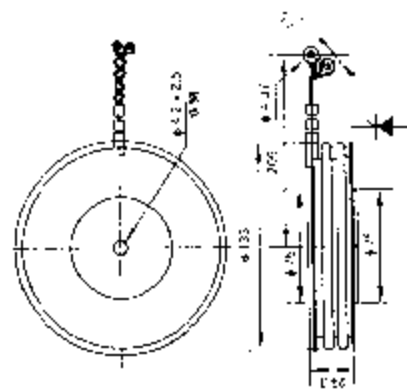

外形图

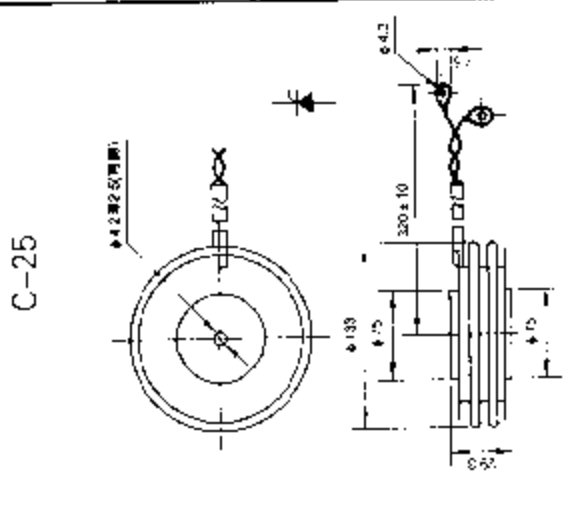
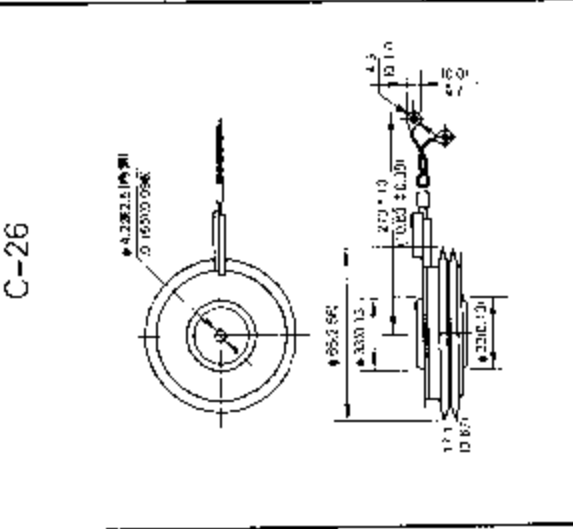
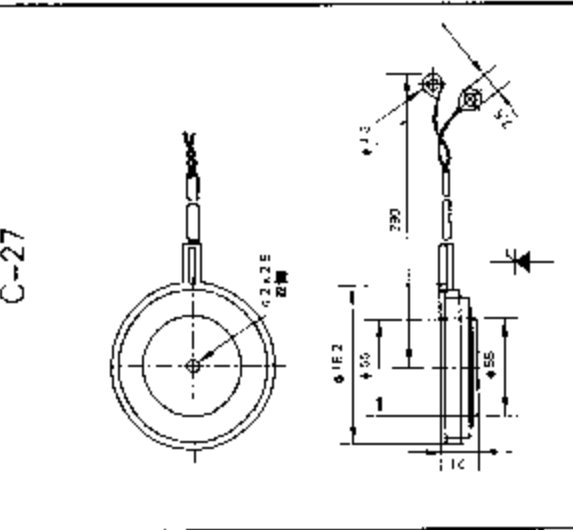
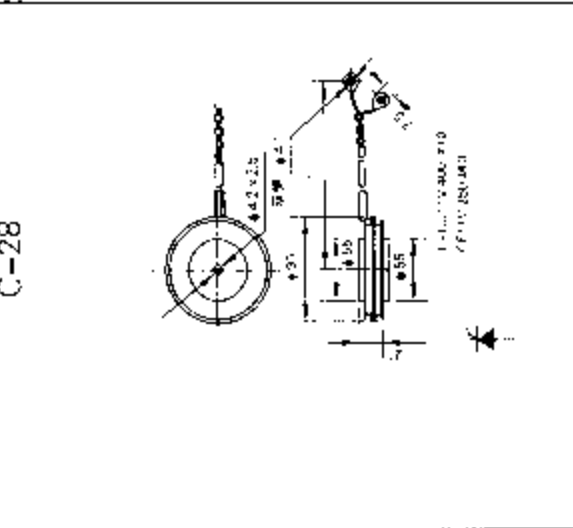
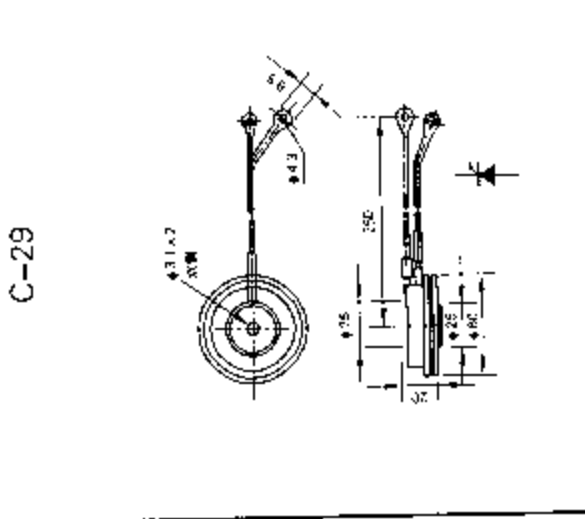
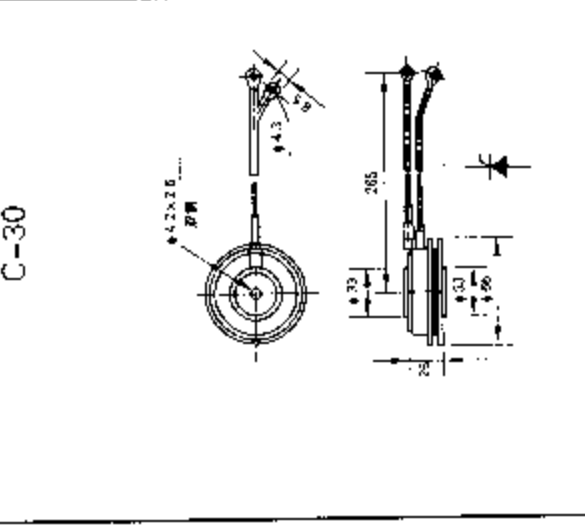
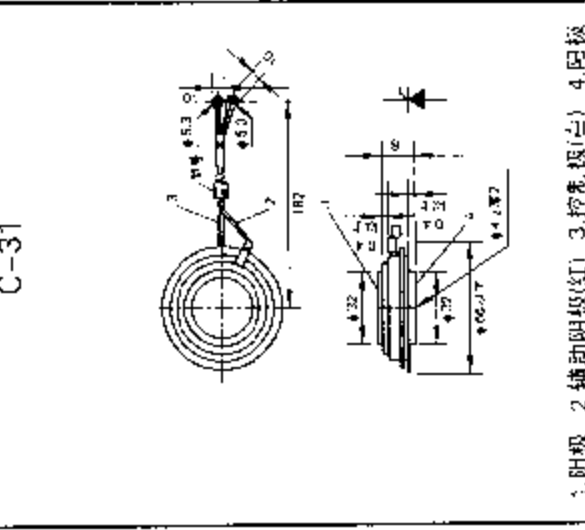
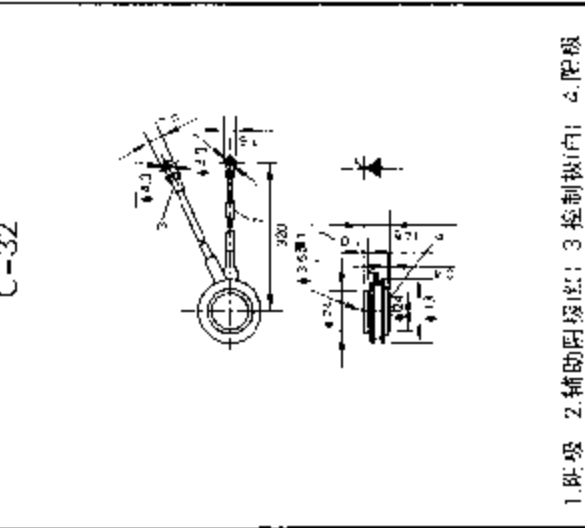
<p>C-25</p> 	<p>C-26</p> 	<p>C-27</p> 	<p>C-28</p> 
<p>C-29</p> 	<p>C-30</p> 	<p>C-31</p> 	<p>C-32</p> 

1. 阴级 2. 辅助阴级底; 3. 控制板(白); 4. 阳级

1. 阴级 2. 辅助阴级(红); 3. 控制板(白); 4. 阳级

<p>C-41</p> <p>1. 阴极 2. 阴极(黑) 3. 阳极 4. 控制极(白)</p>	<p>C-42</p> <p>1. 阴极 2. 阴极 3. 阳极 4. 控制极(白)</p>	<p>C-43</p> <p>1. 阴极 2. 阴极(黑) 3. 阳极 4. 控制极(白)</p>	<p>C-44</p> <p>1. 阴极 2. 阴极(黑) 3. 阳极 4. 控制极(白)</p>
<p>C-45</p> <p>1. 阴极 2. 阴极(黑) 3. 阳极 4. 控制极(白)</p>	<p>C-46</p> <p>1. 阴极 2. 阴极(黑)</p>	<p>C-47</p> <p>1. 阴极 2. 阴极(黑) 3. 阳极 4. 控制极(白)</p>	<p>C-48</p> <p>1. 阴极 2. 阴极(黑) 3. 阳极 4. 控制极(白)</p>

C-40

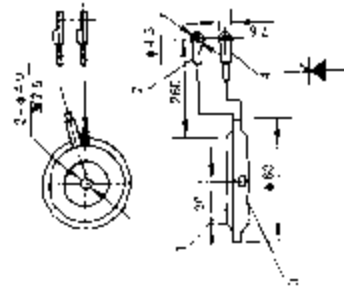

1. 阴极 2. 阳极(黑) 3. 阳极 4. 控制极(白)

C-50

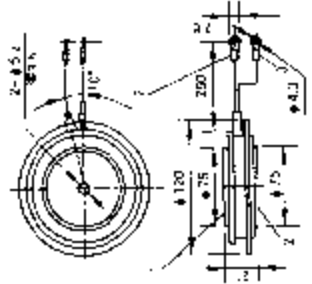

1. 阴极 2. 阴极(黑) 3. 阳极 4. 控制极(白)

C-53

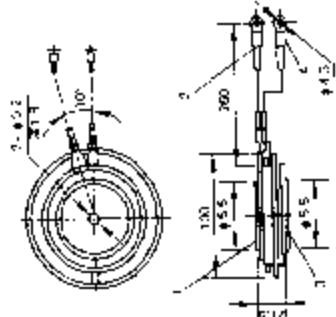

1. 阴极 2. 阴极(黑) 3. 阳极 4. 控制极(白)

C-54

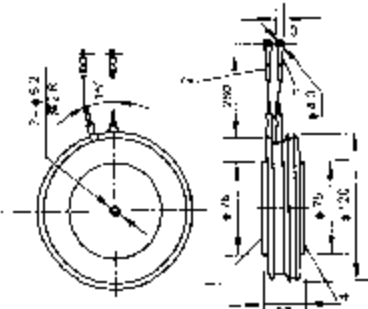

1. 阴极 2. 阳极(黑) 3. 控制极 4. 阳极

C-51

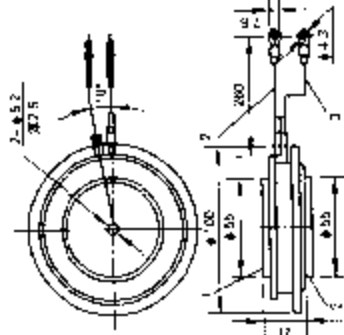

1. 阴极 2. 阴极(黑) 3. 阳极 4. 控制极(白)

C-55

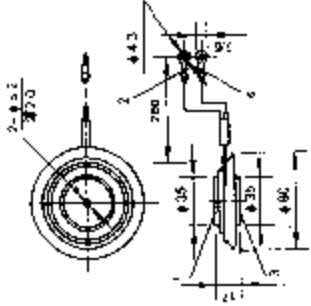

1. 阴极 2. 阴极(黑) 3. 阳极 4. 控制极(白)

C-56

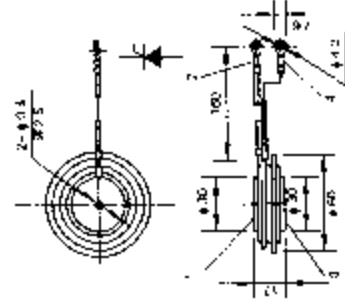

1. 阴极 2. 阴极(黑) 3. 阳极 4. 控制极(白)

C-52

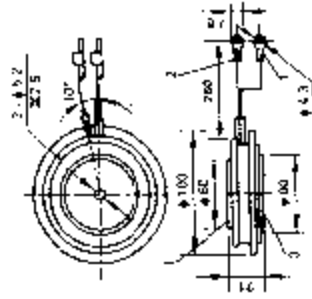

1. 阴极 2. 阴极(黑) 3. 阳极 4. 控制极(白)

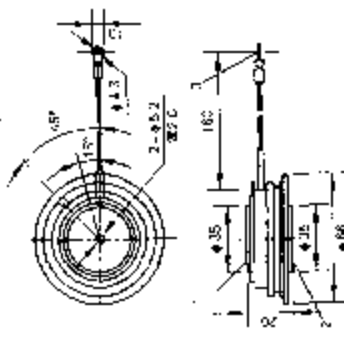
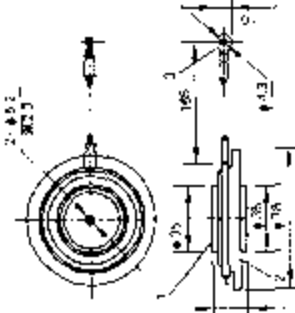
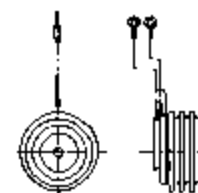
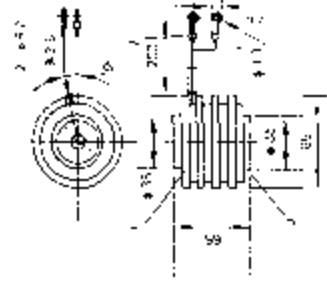
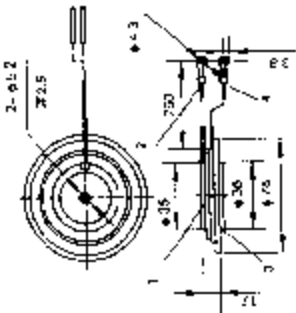
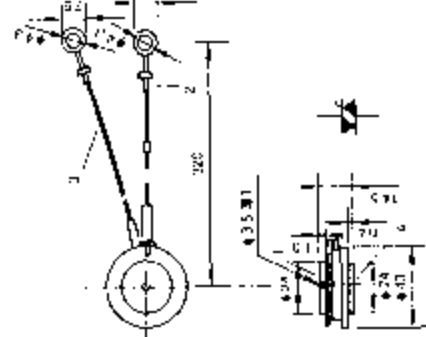
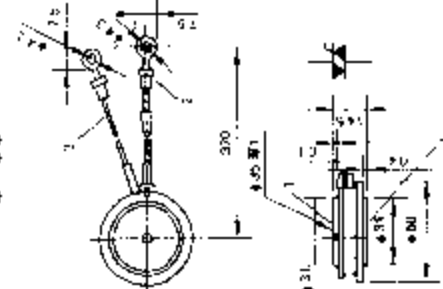
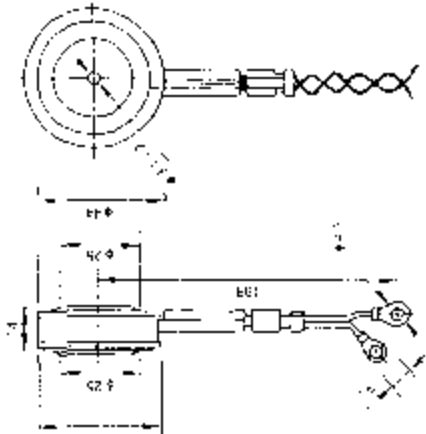
<p>C-57</p> 	<p>C-58</p> 	<p>C-59</p> 	<p>C-60</p> 
<p>C-61</p> 	<p>C-62</p> 	<p>C-63</p> 	<p>C-64</p> 

1.阴极 2.阳极 3.黑 4.控制极(白)

1.阴极 2.阳极 3.控制极(白)

1.阴极 2.阳极 3.控制极(白)

1.T1 2.辅助T1(红) 3.控制极(H) 4.阳极

1.T1 2.辅助T1(红) 3.控制极(白) 4.T2

1.阳极 2.阴极(黑) 3.阳极 4.控制极

C-73

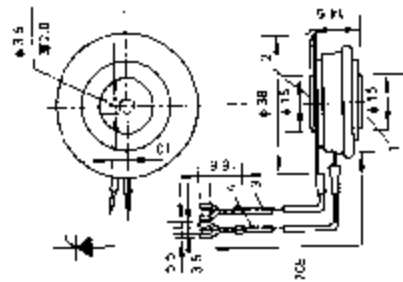

1. 阳极 2. 阴极 3. 第二阴极 4. 控制极

C-77

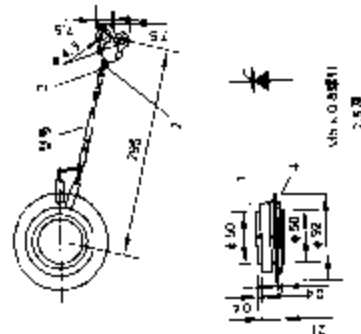

1. 阴极 2. 辅助阴极 (红) 3. 控制极 (白) 4. 阳极

C-74

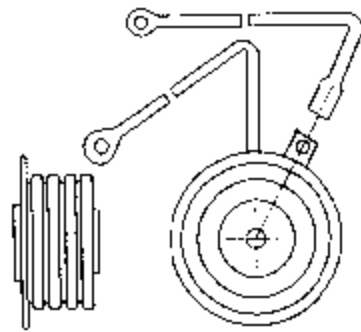

1. 阴极 2. 辅助阴极 (红) 3. 控制极 (白) 4. 阳极

C-78

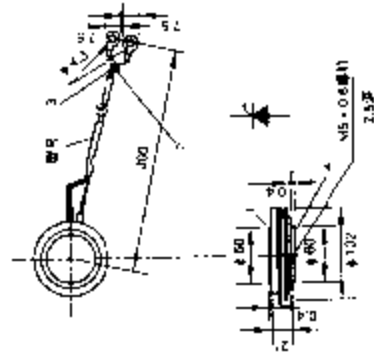

1. 阴极 2. 辅助阴极 (红) 3. 控制极 (白) 4. 阳极

C-75

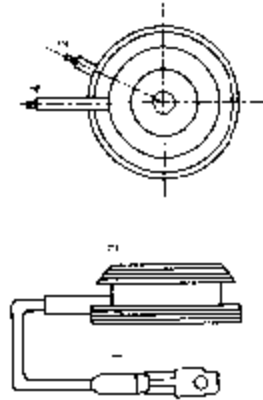

1. 阳极 2. 辅助阴极 3. 阳极 4. 控制极

C-76

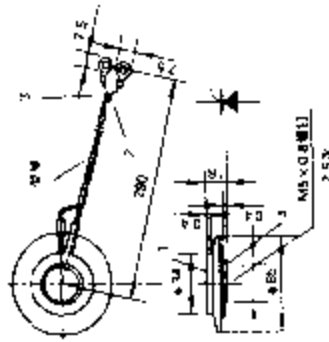

1. 阴极 2. 辅助阴极 (红) 3. 控制极 4. 阳极

C-80

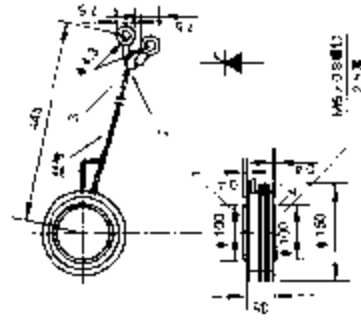

1. 阴极 2. 辅助阴极 (红) 3. 控制极 (白) 4. 阳极

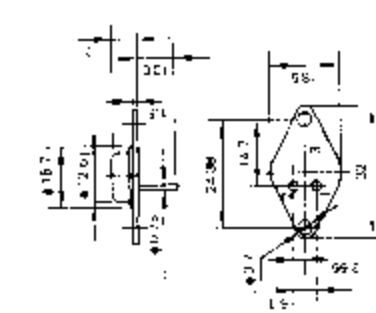
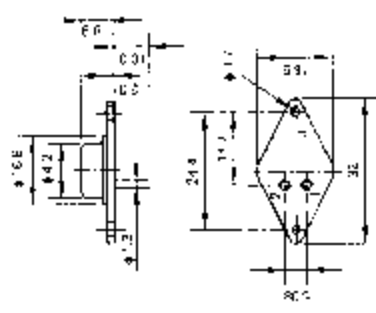
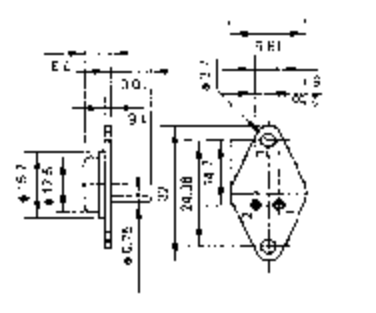
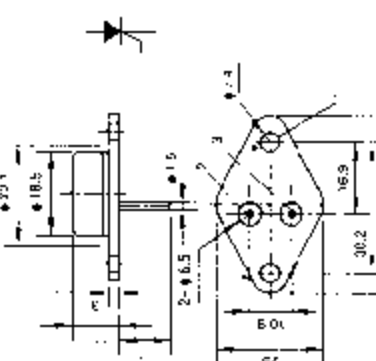
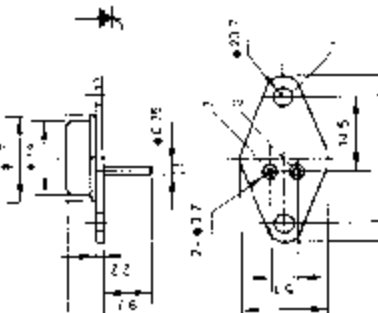
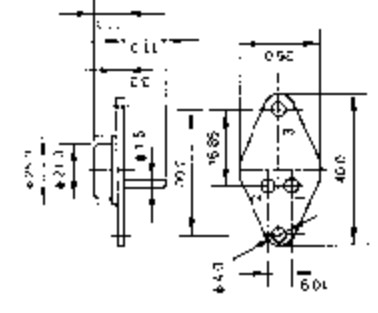
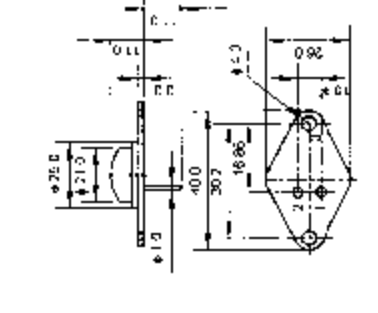
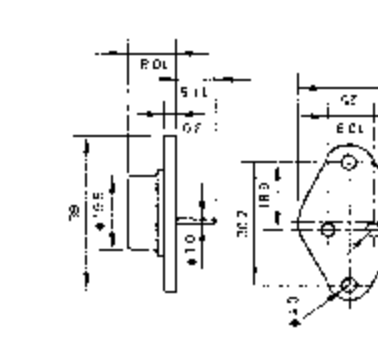
<p>D-1</p>  <p>1. 控制极 2. 阴极 3. 阳极 (壳)</p>	<p>D-2</p>  <p>1. 控制极 2. 阴极 3. 阳极 (壳)</p>	<p>D-3</p>  <p>1. 控制极 2. 阴极 3. 阳极 (壳)</p>	<p>D-4</p>  <p>1. 阳极 2. 阴极 3. 控制极</p>
<p>D-5</p>  <p>1. 阳极 2. 阴极 3. 控制极</p>	<p>D-6</p>  <p>1. 控制极 2. 阴极 3. 阳极 (壳)</p>	<p>D-7</p>  <p>1. 门极 2. 阴极 3. 阳极 (壳)</p>	<p>D-8</p> 



D-9

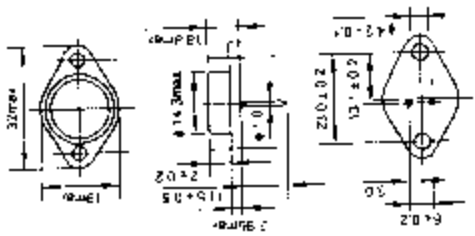

D-10

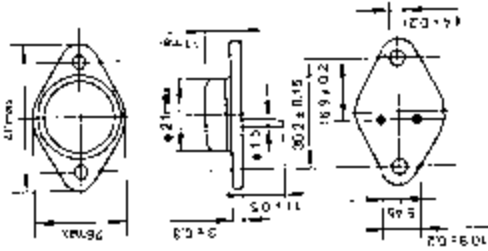

D-11

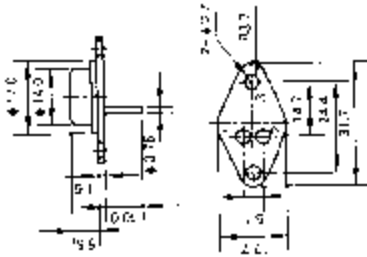

1. 阴极 2. 控制极 3. 阳极

D-12

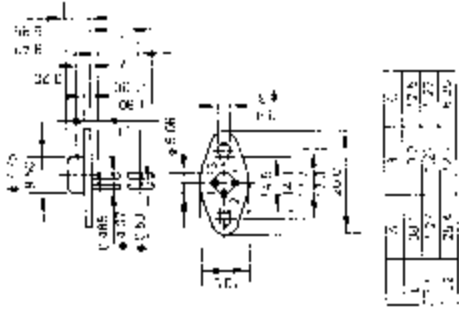

D-13

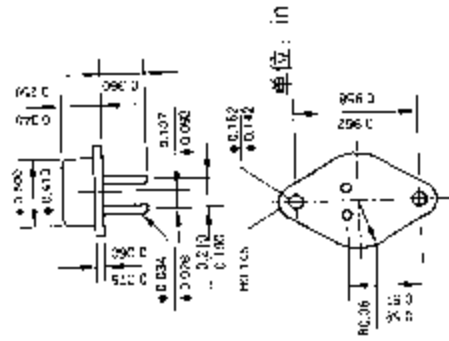

单位: in

D-14

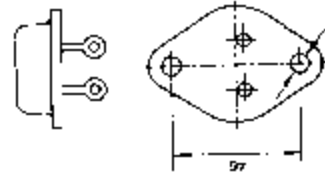

D-15

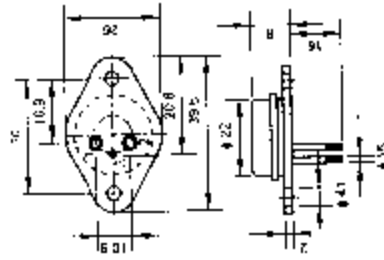

D-16

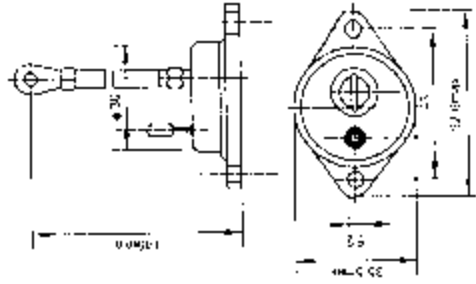

D-17

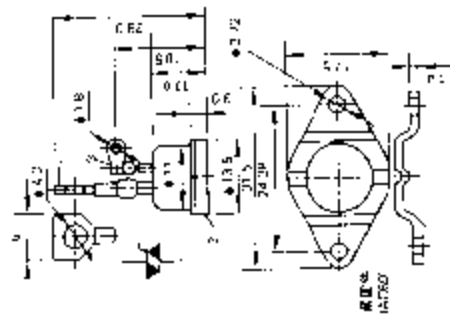

1.原板 2.面板 3.门板

D-18

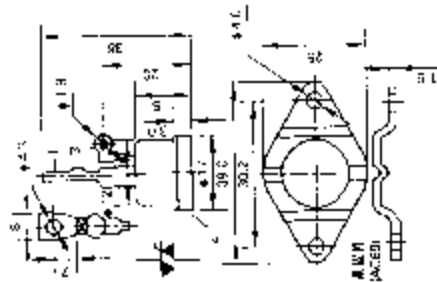

1.阴板 2.阳板 3.门板

D-19

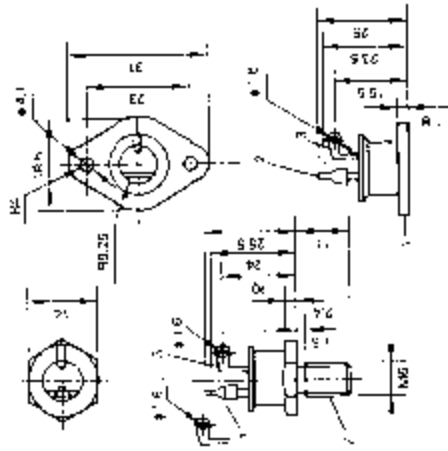

1.阳板 2.阴板 3.门板

D-20

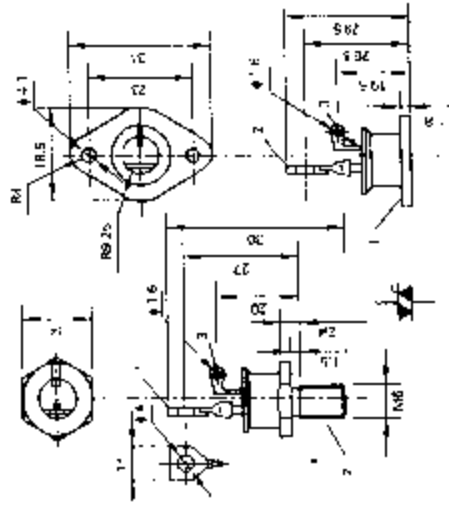

1.门 2.T2 3.控制板

D-21

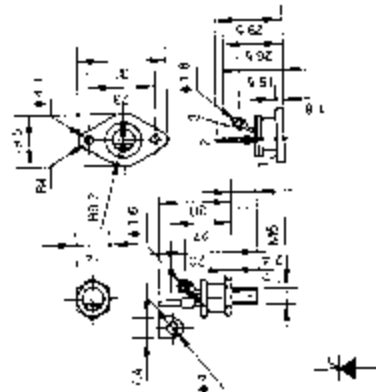

1.阳板 2.阴板 3.控制板

D-23

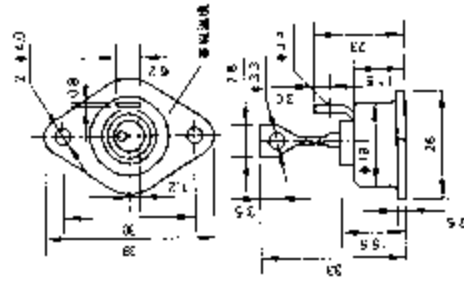

D-24

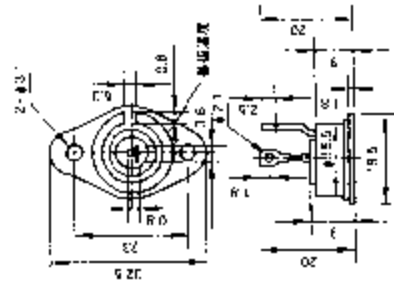

外形图

D-33

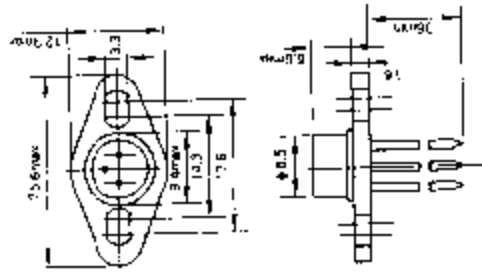

D-34

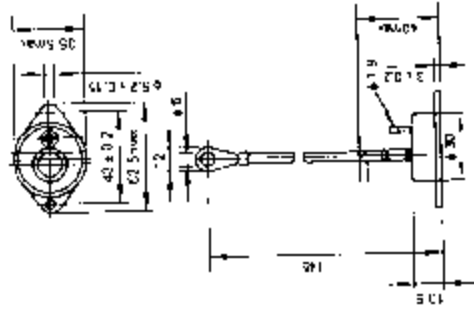

D-35

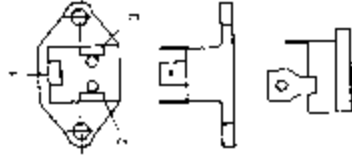

1. 阴极 2. 阴极 3. 门极

D-37

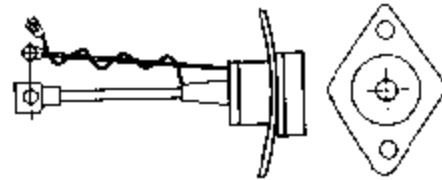

D-38

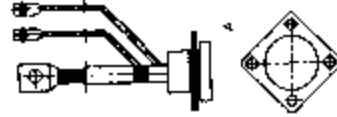

D-39



D-40

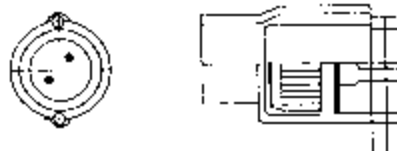

D-36

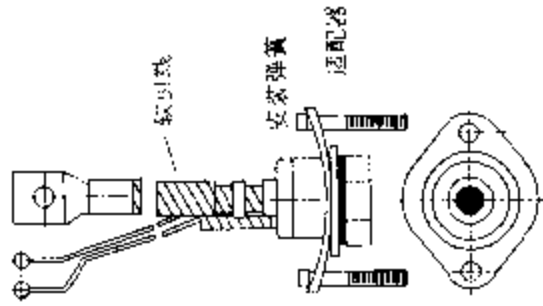

外形图

E-1

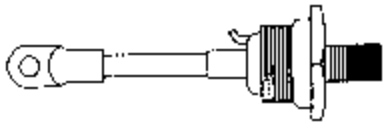

E-2

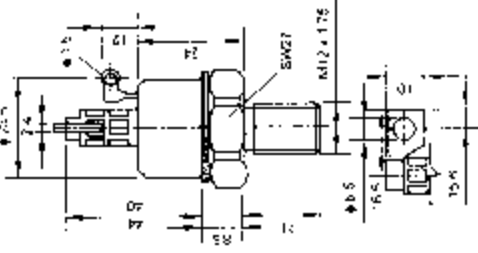

E-3

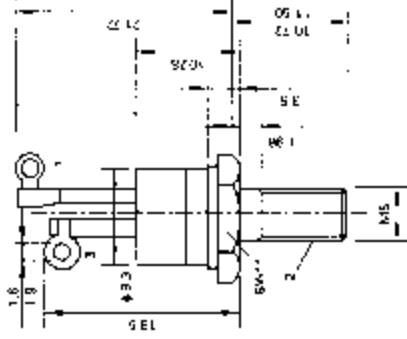

1. 阴极 2. 阳极 3. 控制板

E-4

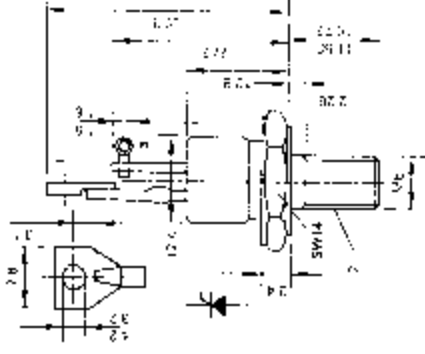

1. 阴极 2. 阳极 3. 控制板

E-5

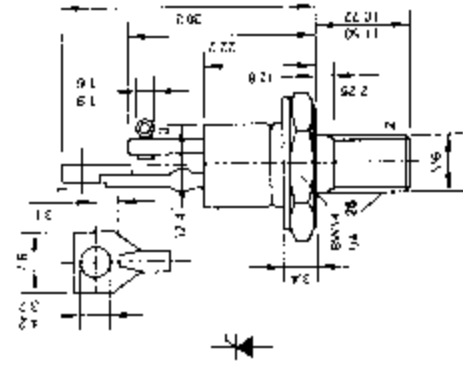

1. 阴极 2. 阳极 3. 控制板

E-6

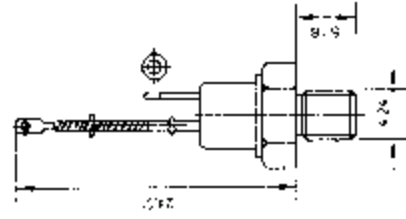

E-7

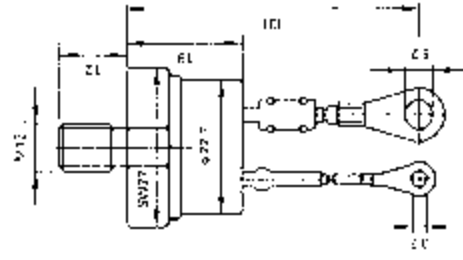

E-8

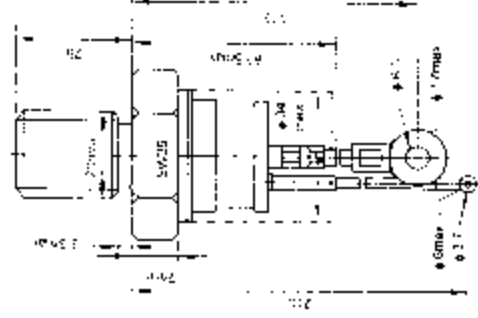

E-9

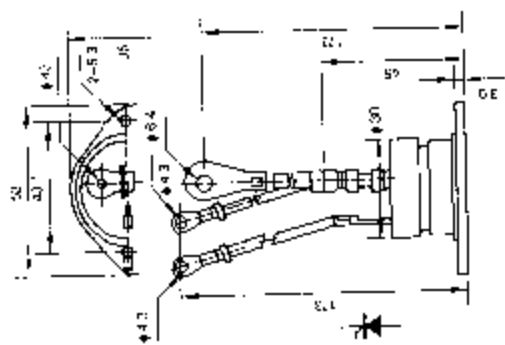

E-10

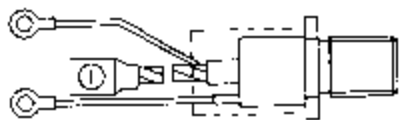

E-13



E-14

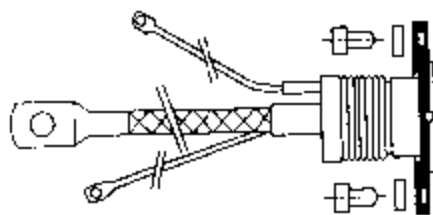

E-15

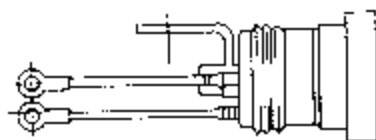

E-16

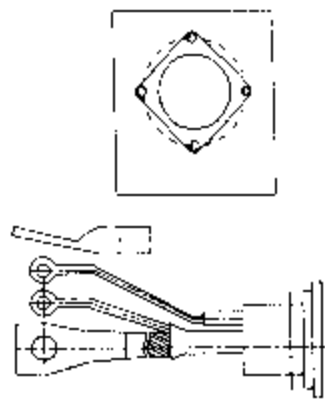

E-11

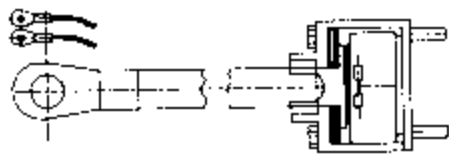

E-12

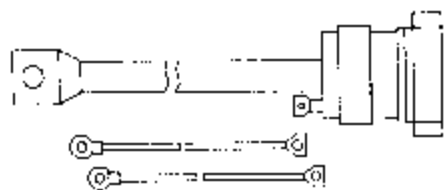

E-33

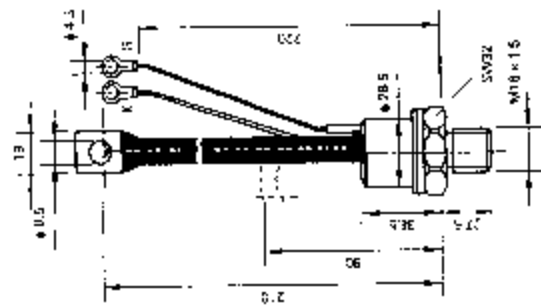

E-34

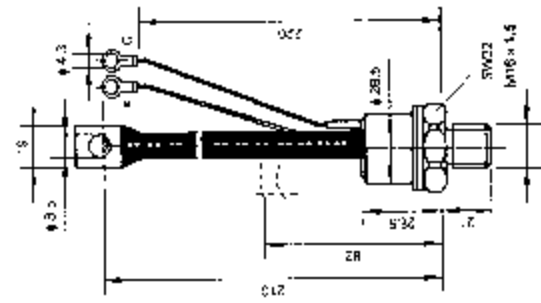

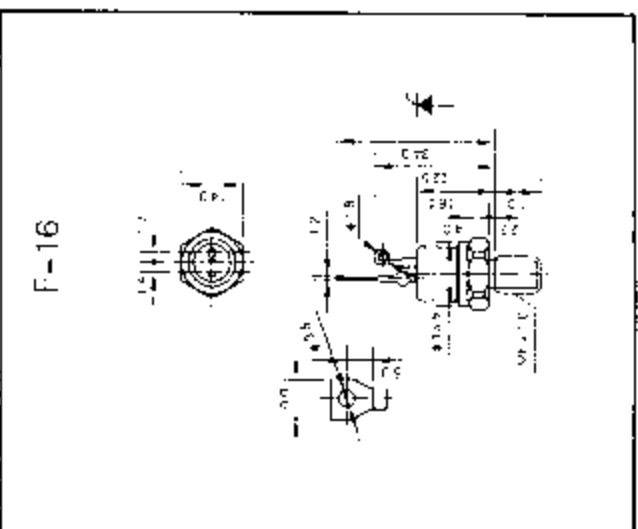
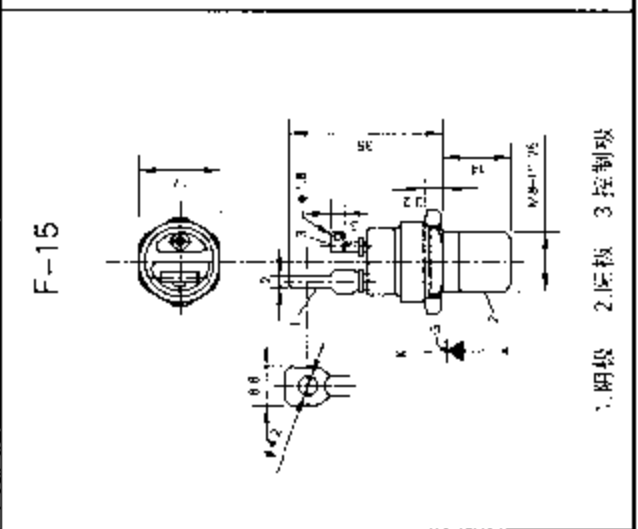
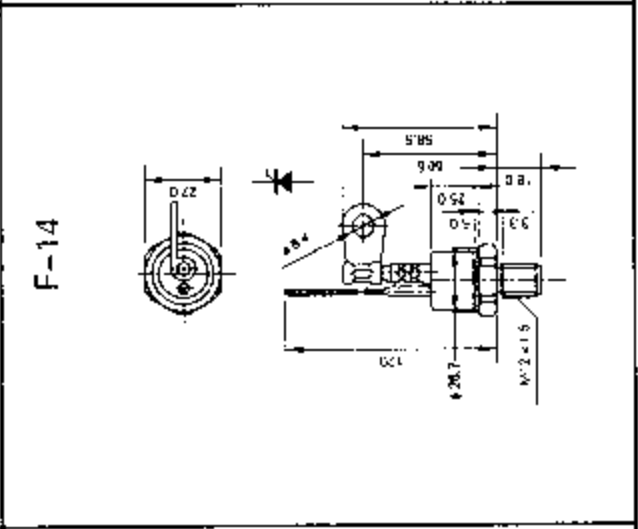
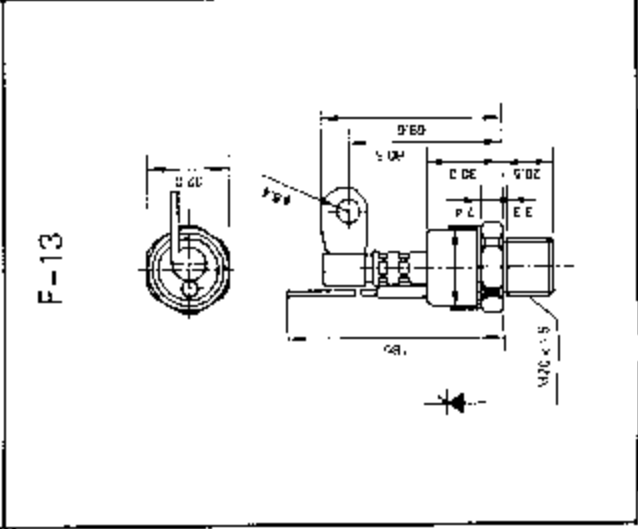
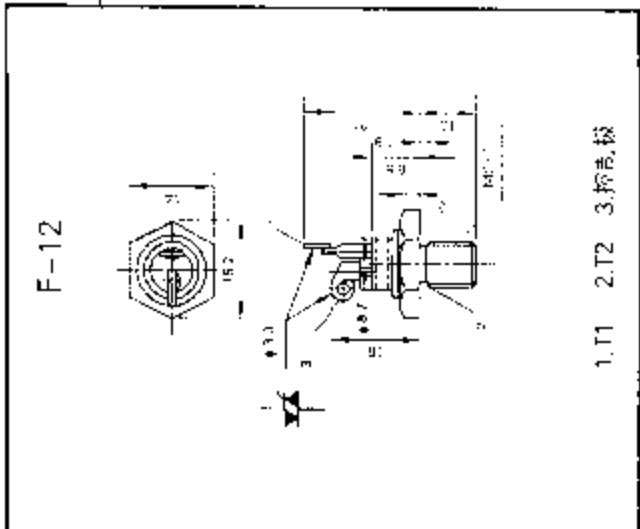
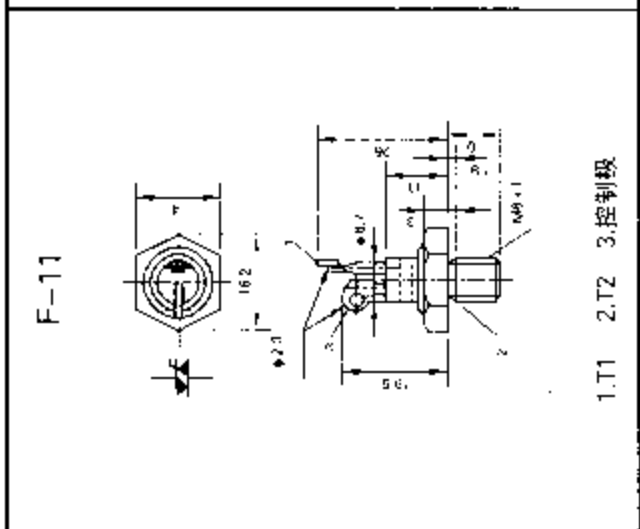
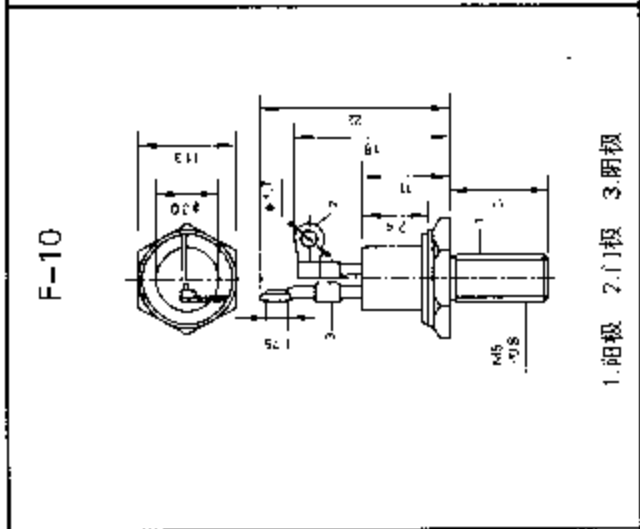
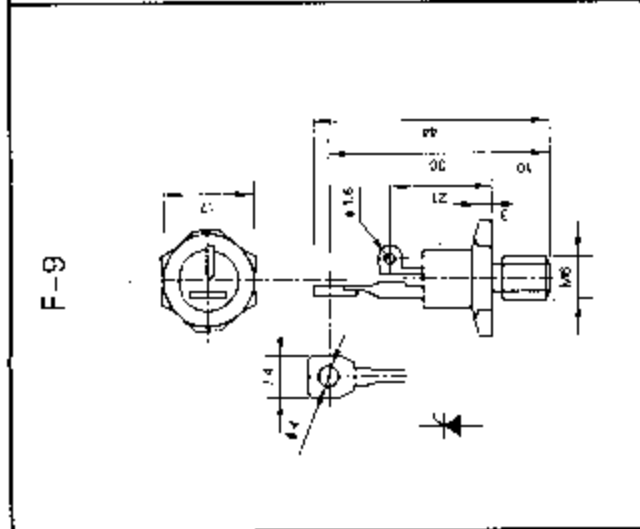

1. T1 2. T2 3. 控制极

1. T1 2. T2 3. 控制极

1. T1 2. T2 3. 控制极

1. 阳极 2. 阴极 3. 控制极

1. 阳极 2. 阴极 3. 控制极

1. 阳极 2. 阴极 3. 控制极

1. 阳极 2. 阴极 3. 控制极

1. 阳极 2. 阴极 3. 控制极

1. 阳极 2. 阴极 3. 控制极

1. 阳极 2. 阴极 3. 控制极

1. 阳极 2. 阴极 3. 控制极

1. 阳极 2. 阴极 3. 控制极

1. 阳极 2. 阴极 3. 控制极

1. 阳极 2. 阴极 3. 控制极

F-17

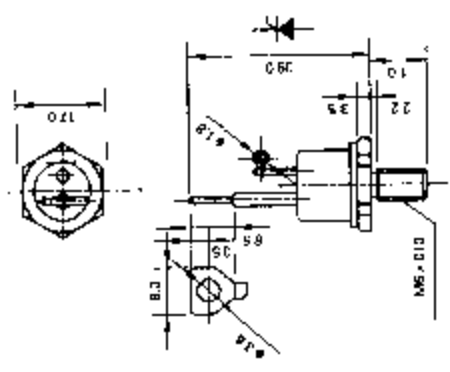

F-18

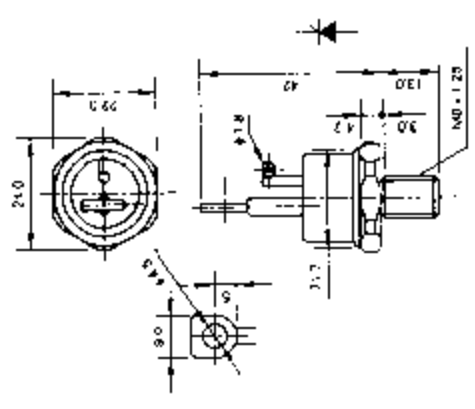

F-19

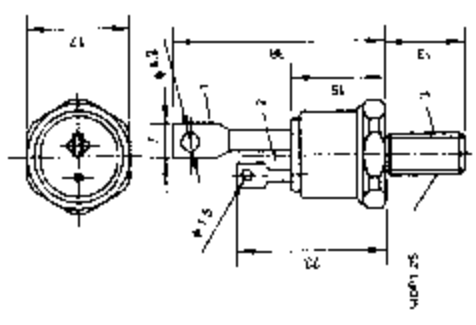

1. 阴极 2. 控制极 3. 阳极

F-20

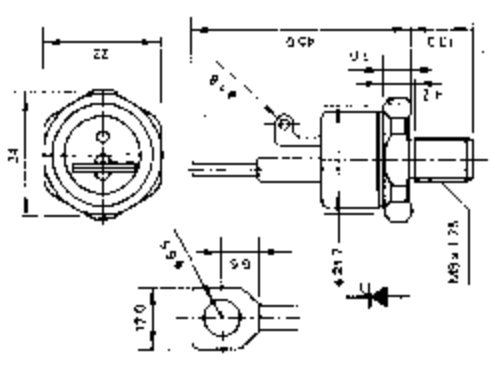

F-21

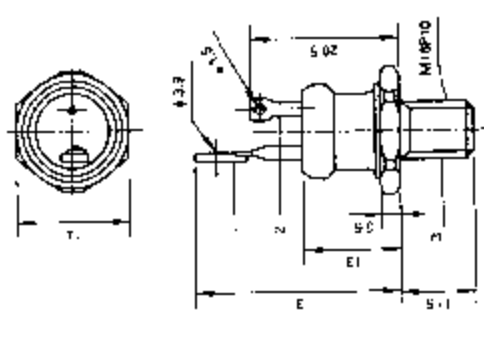

1. 阴极 2. 控制极 3. 阳极

F-22

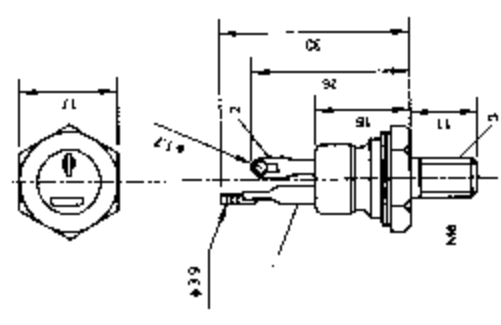

1. 阴极 2. 控制极 3. 阳极

F-23

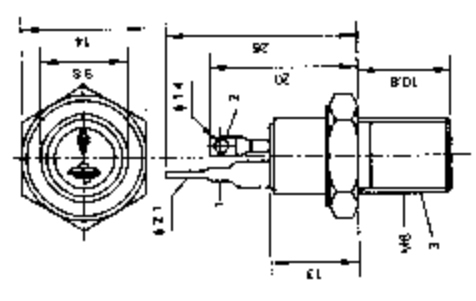

1. 阴极 2. 控制极 3. 阳极

F-24

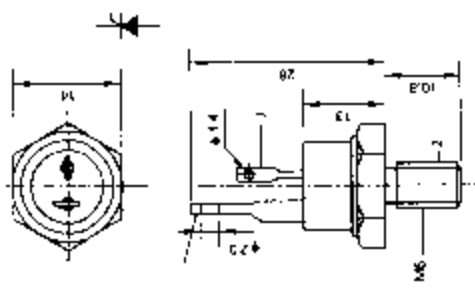

1. 阴极 2. 阴极 3. 控制极



F-25

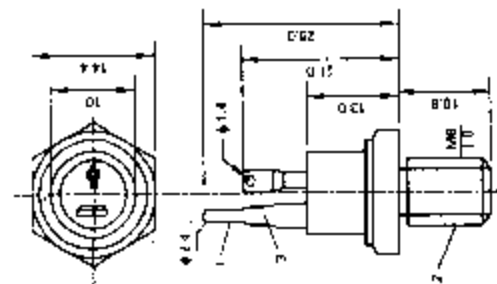

1. 阴极 2. 阳极 3. 门极

F-29

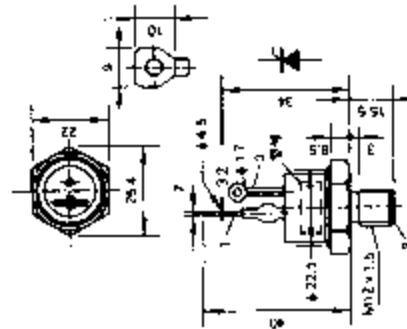

1. 阴极 2. 阳极 3. 控制极

F-26

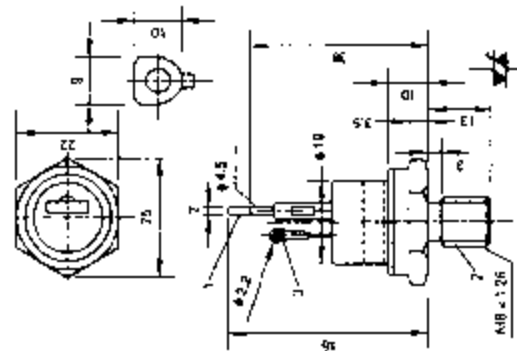

1. T1 2. T2 3. 门极

F-30

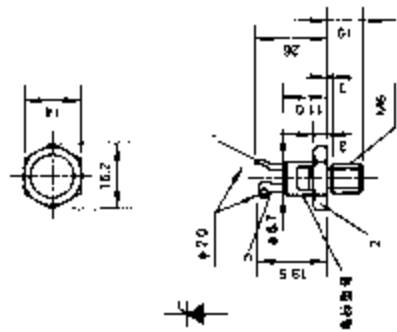

1. 阴极 2. 阳极 3. 门极

F-27

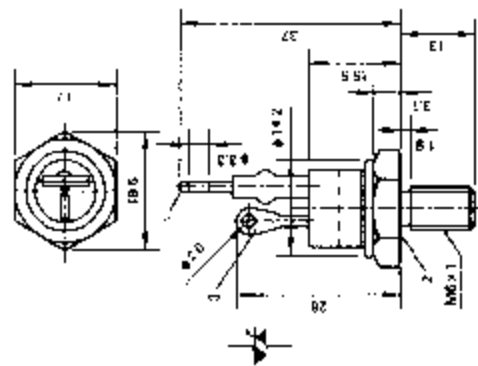

1. T1 2. T2 3. 门极

F-31

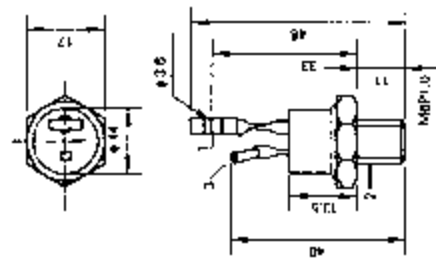

1. T1 2. T2 3. 控制极

F-28

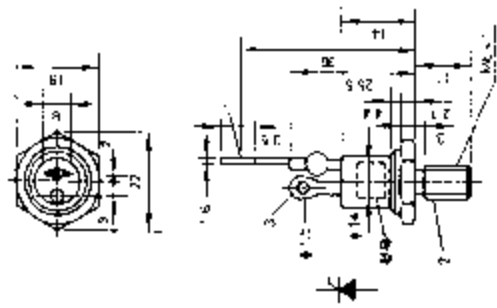

1. 阴极 2. 阳极 3. 控制极

F-32

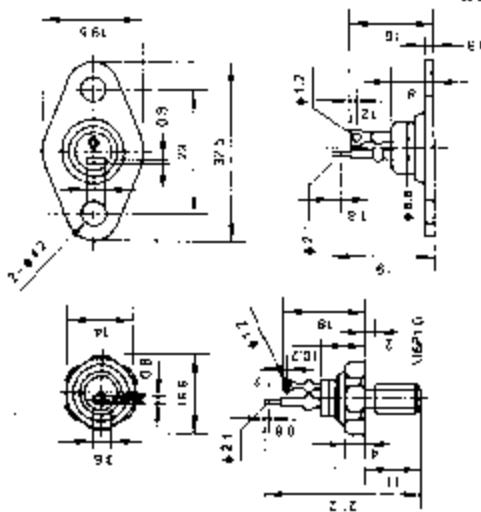

1. 阴极 2. 阳极 3. 控制极

F-36

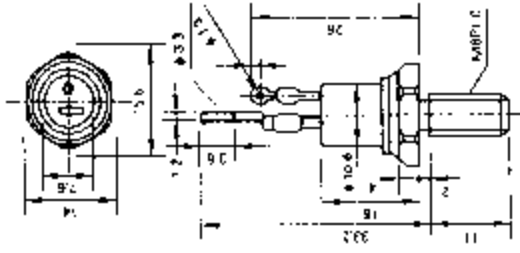

F-40

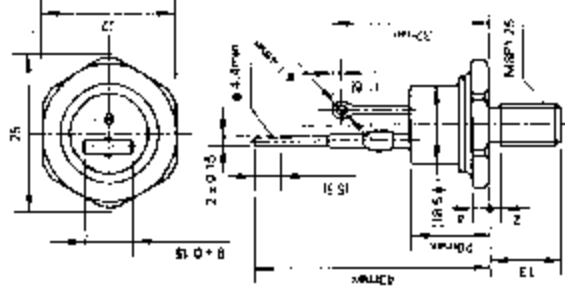

F-35

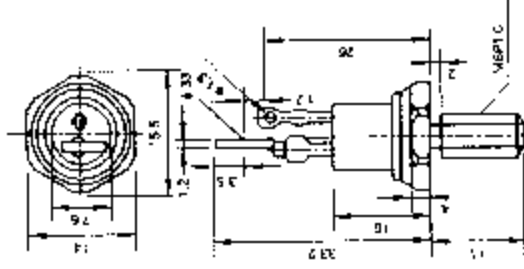

F-39

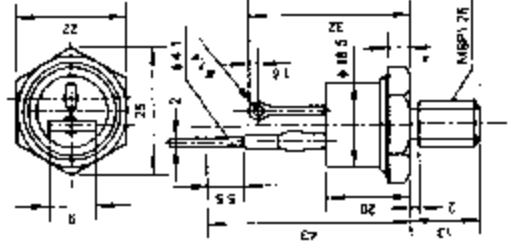

F-34

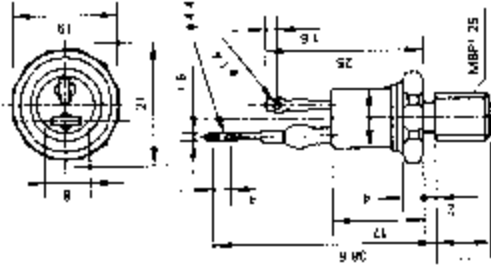

F-38

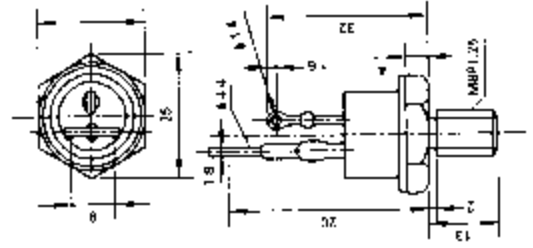

F-33

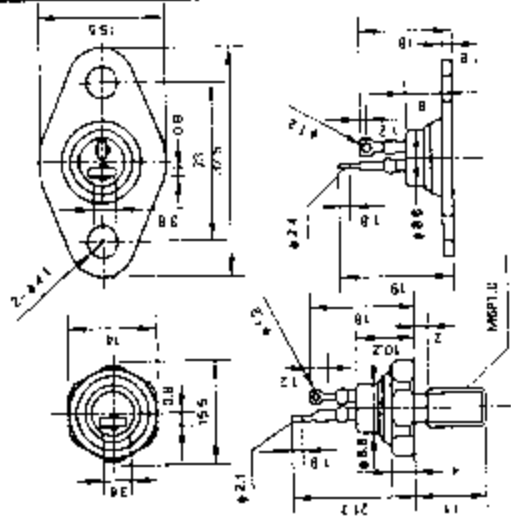

F-37

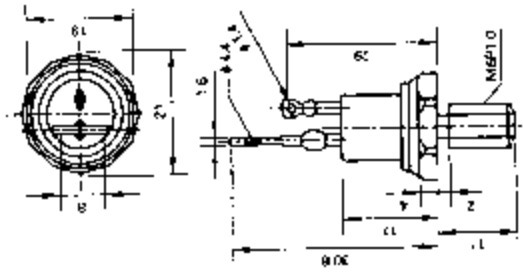

外形图

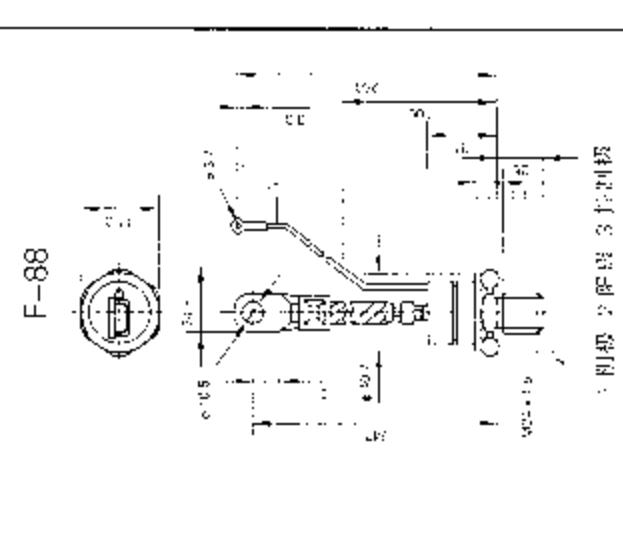
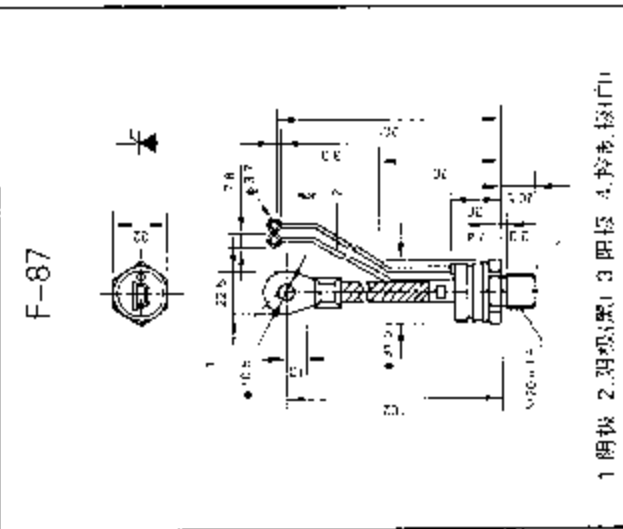
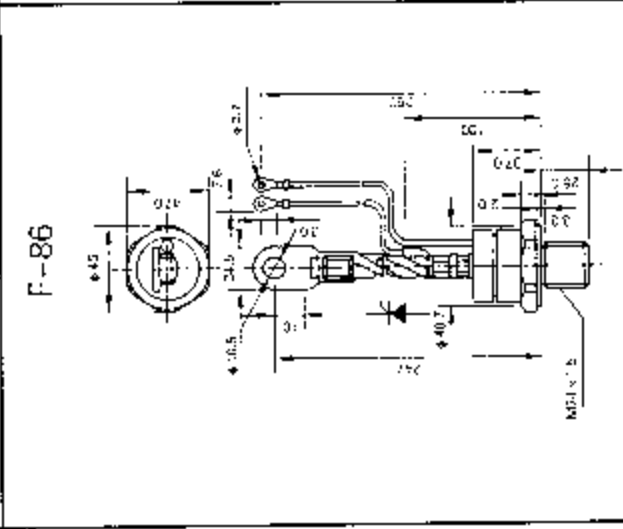
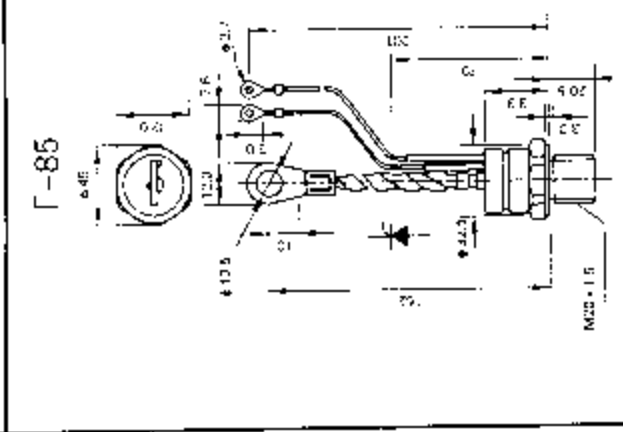
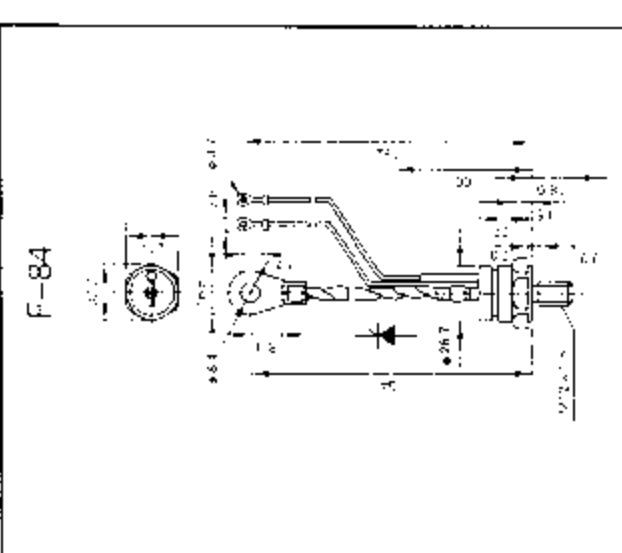
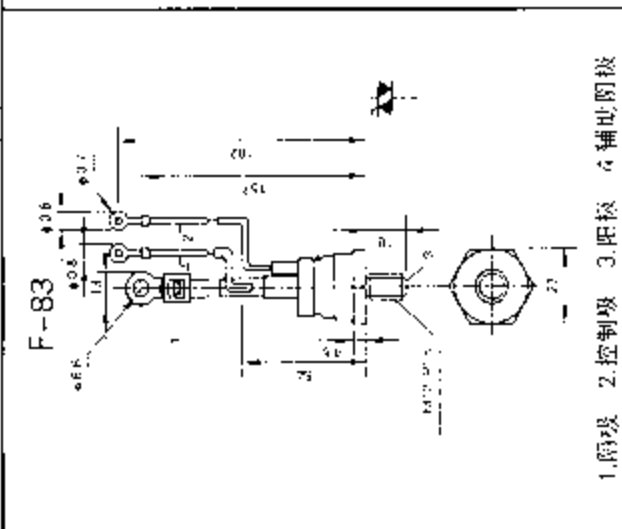
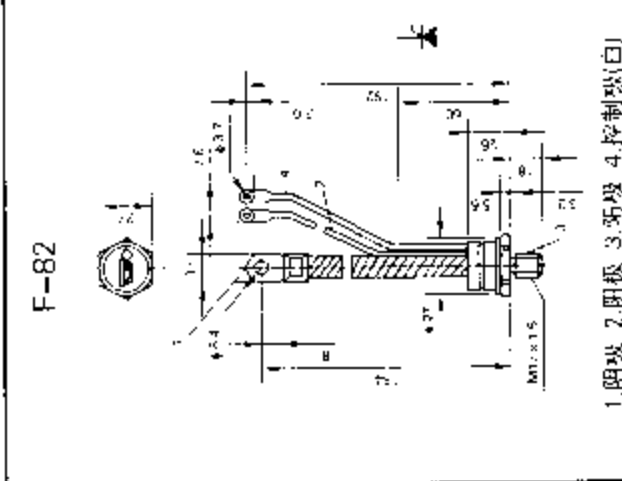
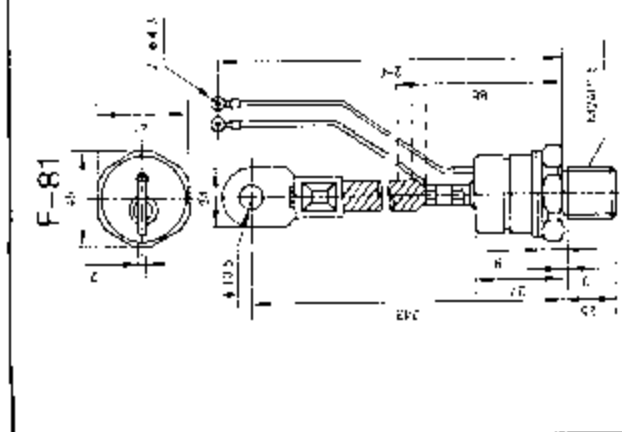

F-81 1.阴极 2.阳极 3.新级 4.控制极(白)
 F-82 1.阴极 2.阳极 3.新级 4.控制极(白)
 F-83 1.阴极 2.控制极 3.阳极 4.辅助阴极
 F-84 1.阴极 2.阳极 3.控制极
 F-85 1.阴极 2.阳极 3.新级 4.控制极(白)
 F-86 1.阴极 2.阳极 3.新级 4.控制极(白)
 F-87 1.阴极 2.阳极 3.新级 4.控制极(白)
 F-88 1.阴极 2.阳极 3.控制极

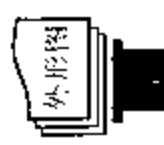

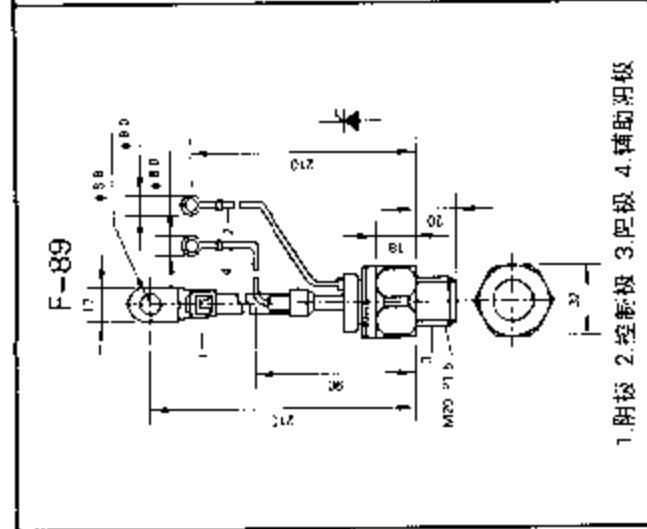

1. 阴极 2. 控制极 3. 阳极 4. 辅助阳极

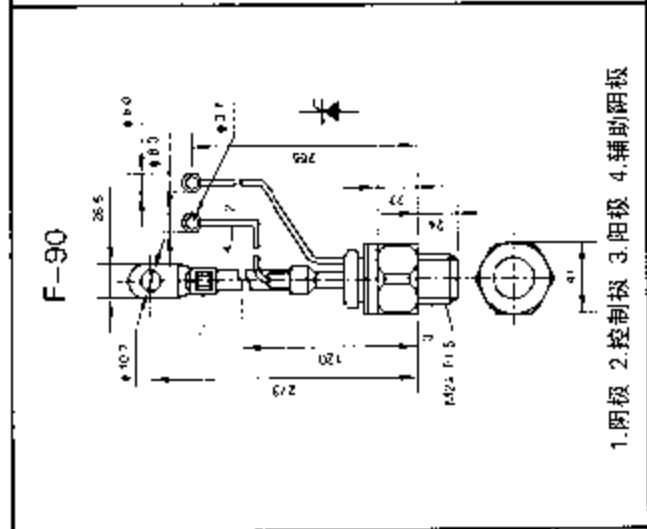

1. 阴极 2. 控制极 3. 阳极 4. 辅助阴极

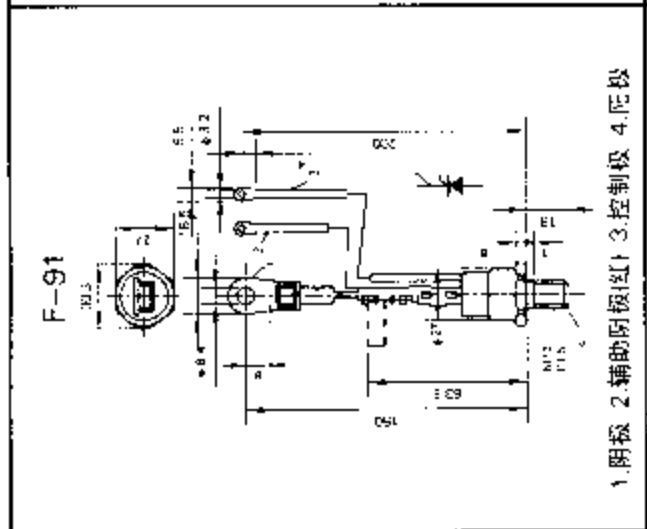

1. 阴极 2. 辅助阳极 3. 控制极 4. 阳极

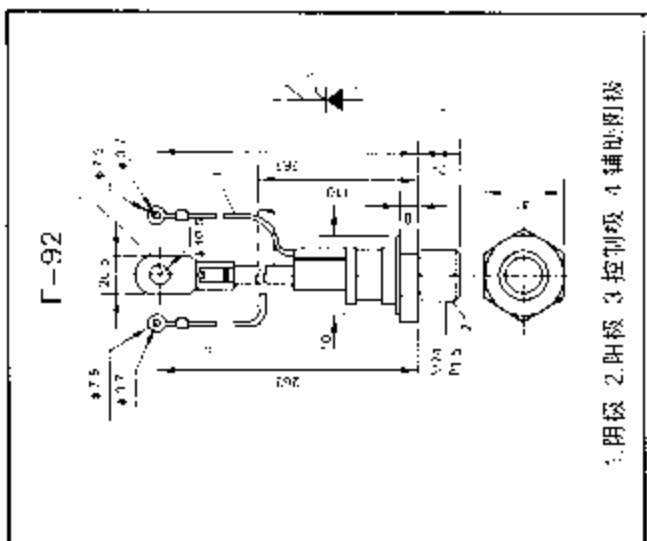

1. 阴极 2. 阳极 3. 控制极 4. 辅助阳极

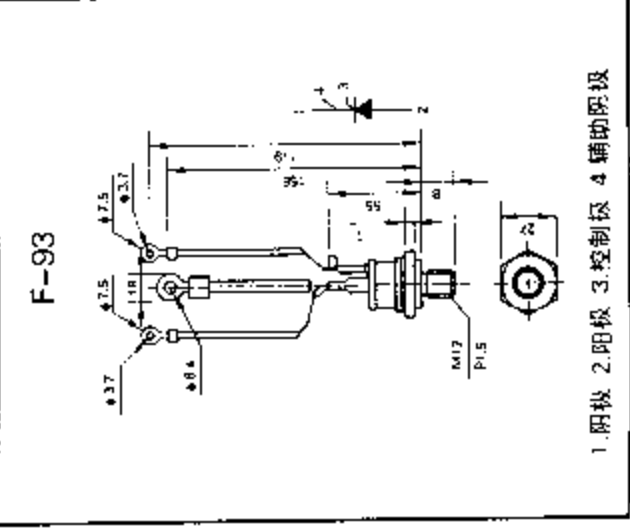

1. 阴极 2. 阳极 3. 控制极 4. 辅助阳极

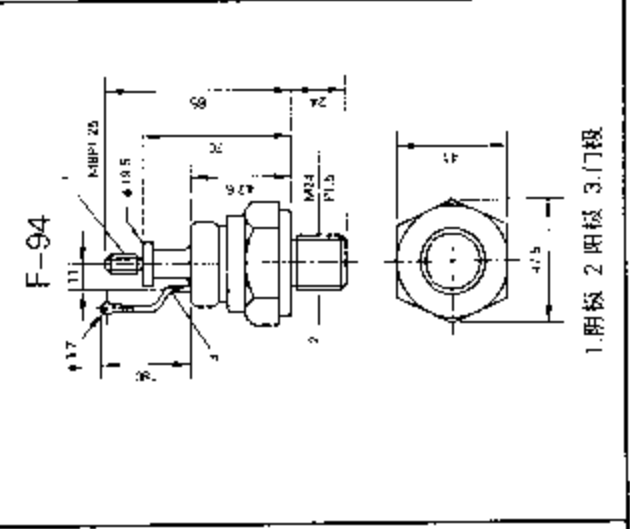

1. 阴极 2. 阳极 3. 门极

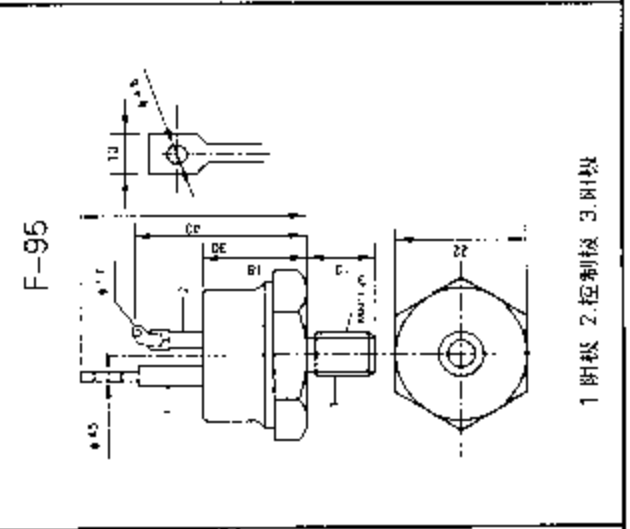

1. 阴极 2. 控制极 3. 阳极

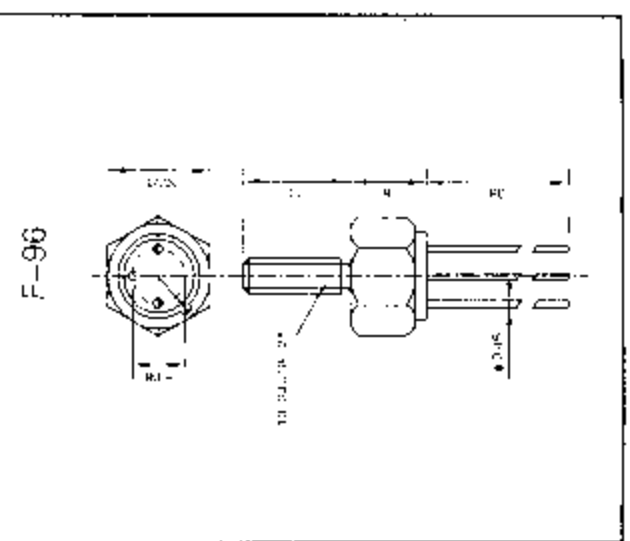

1. 阴极 2. 控制极 3. 阳极

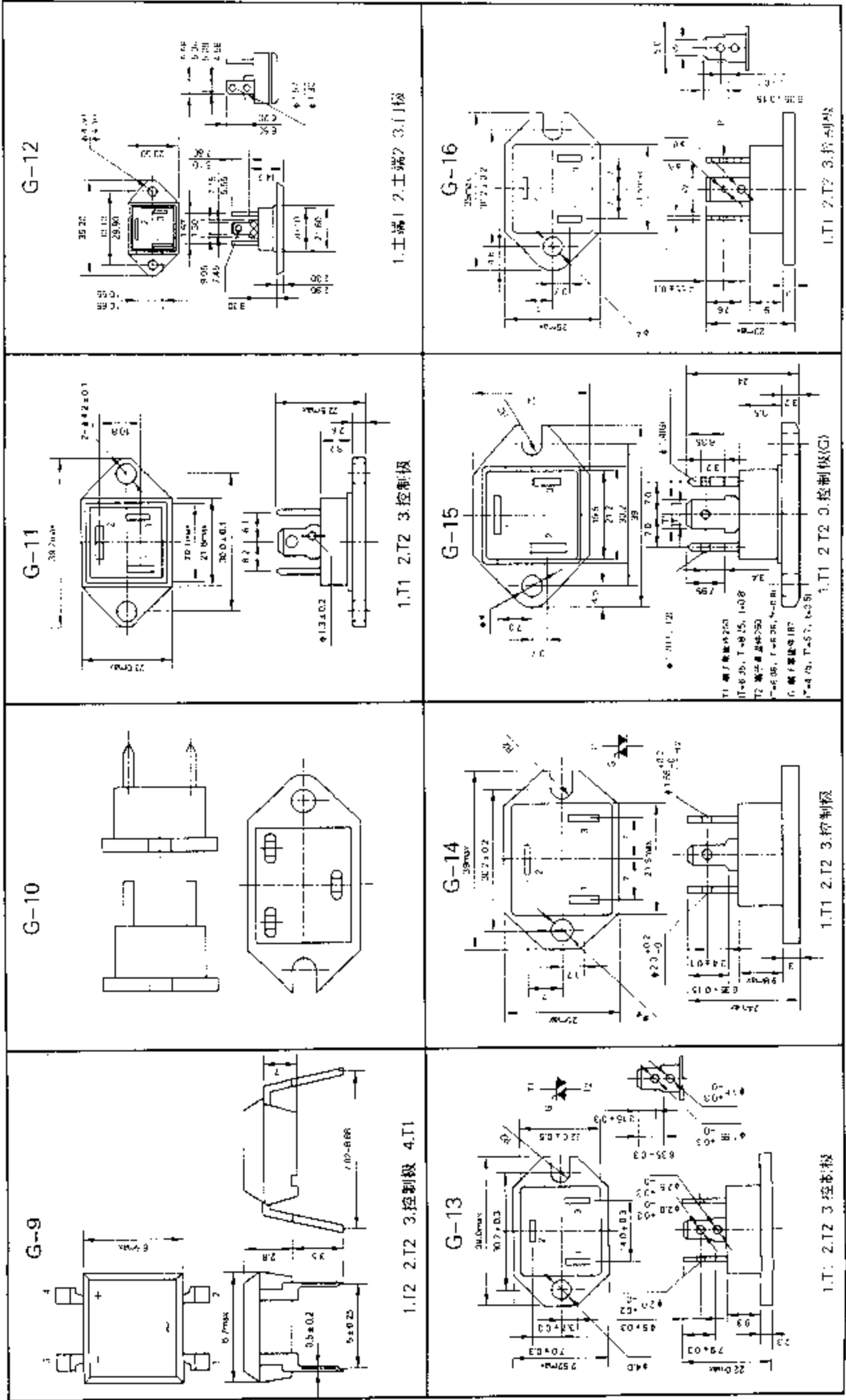

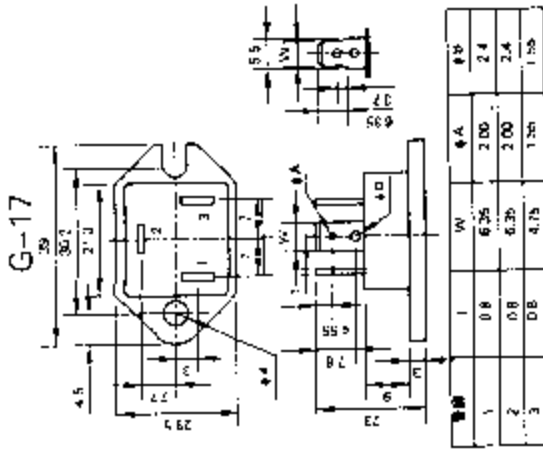

1.T1 2.T2 3.控制极

G-21

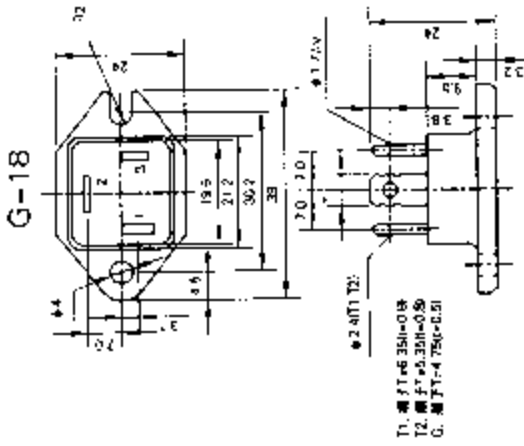
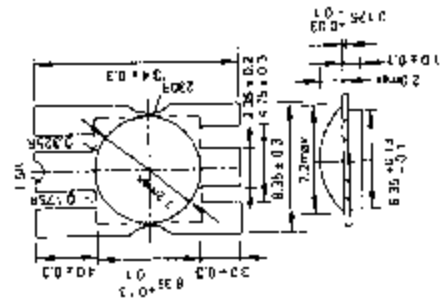

1.T1 2.T2 3.控制极(G)

G-22

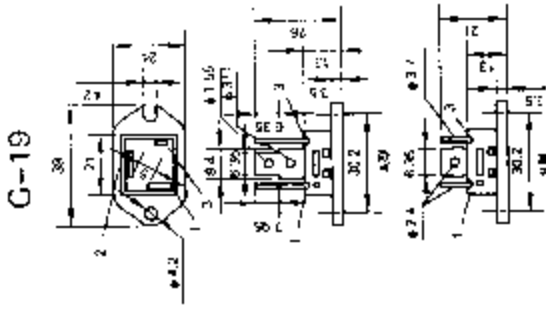
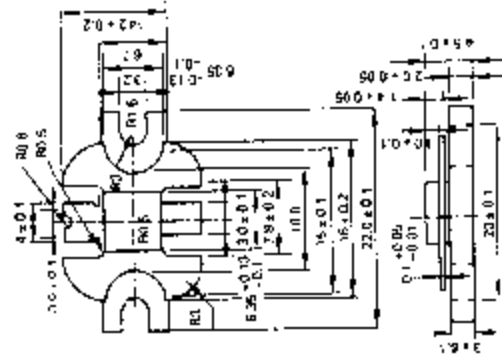

1.T1 2.T2 3.控制极

G-23

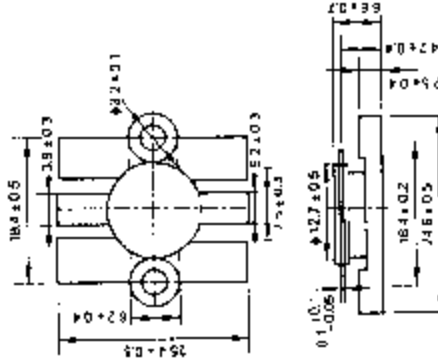

G-20

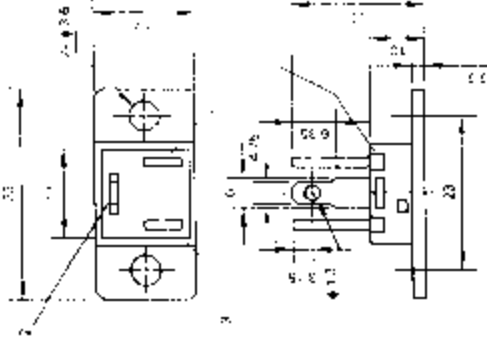

1.T1 2.T2 3.控制极

G-24

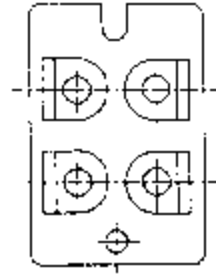

H-1

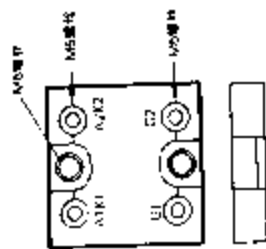

H-2

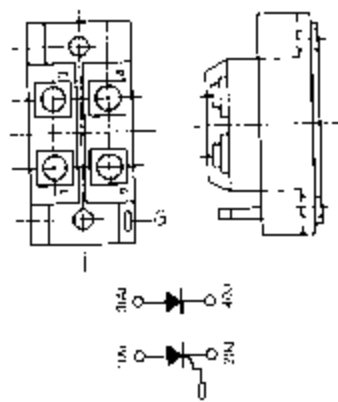

H-5

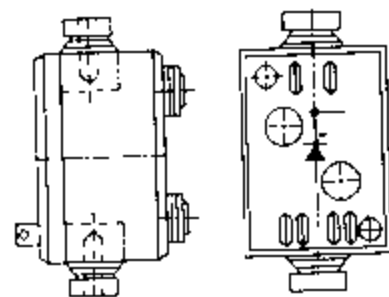

H-6

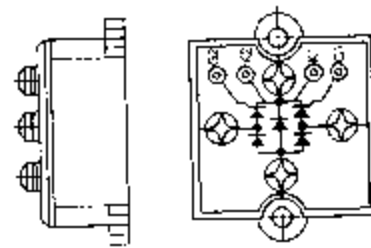

H-7

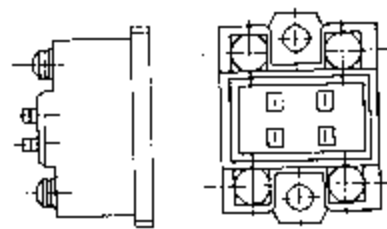

H-3

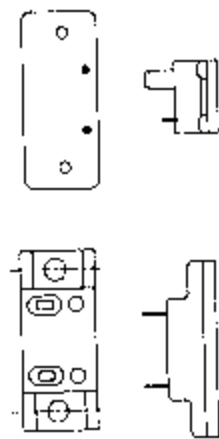

H-4

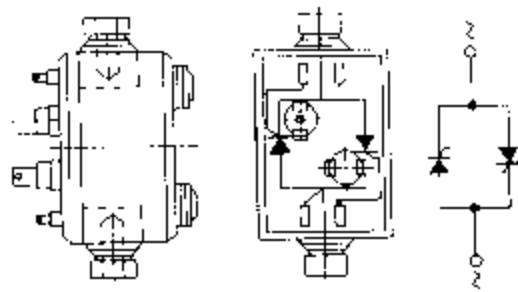

H-8

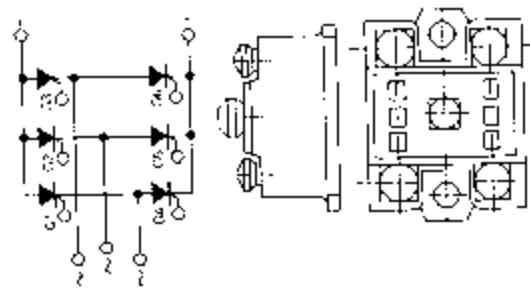

外形图

H-17

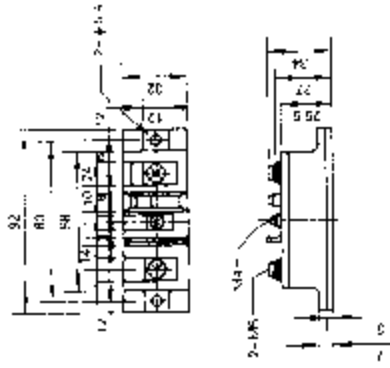

H-18

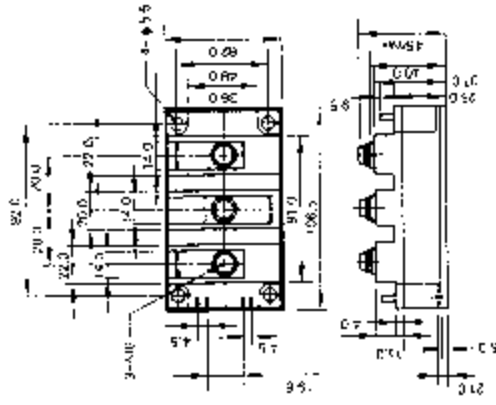

H-21

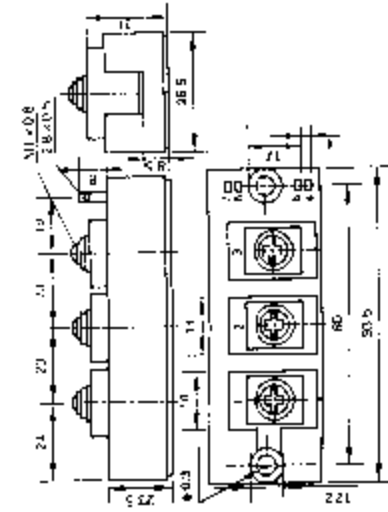

H-22

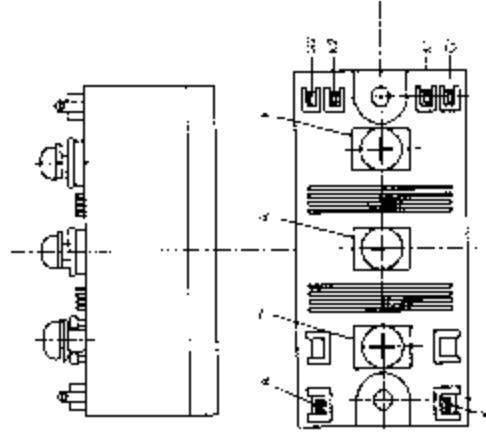

H-19

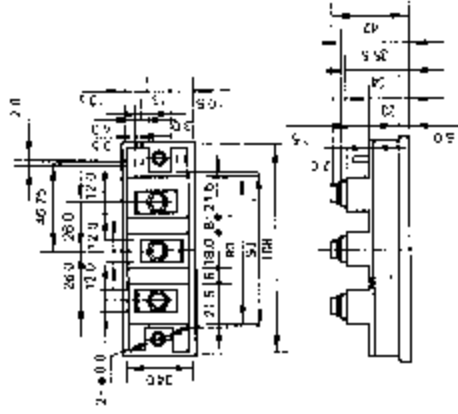

H-23

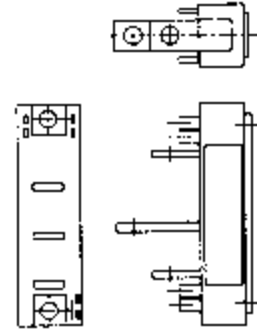

H-20

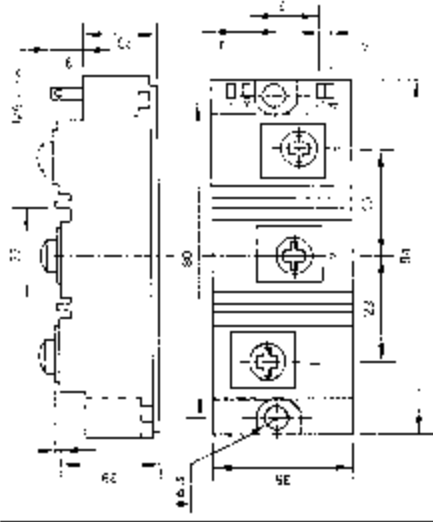

H-24

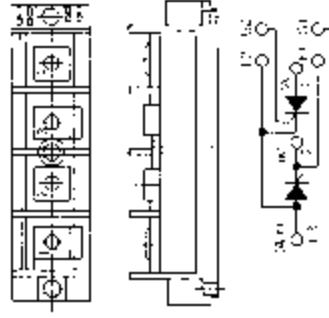

H-30

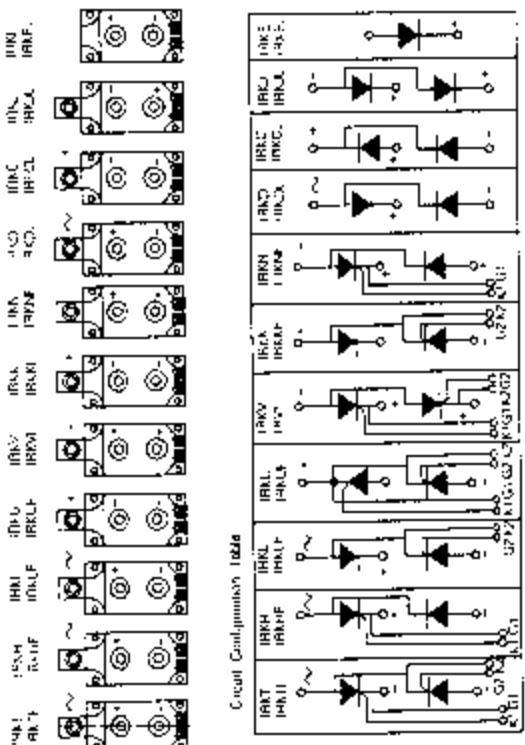
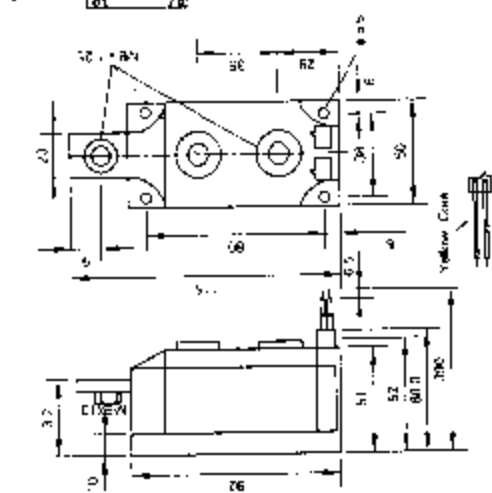

H-31

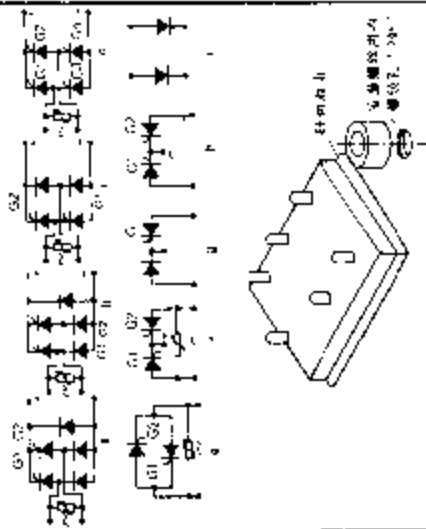

H-32

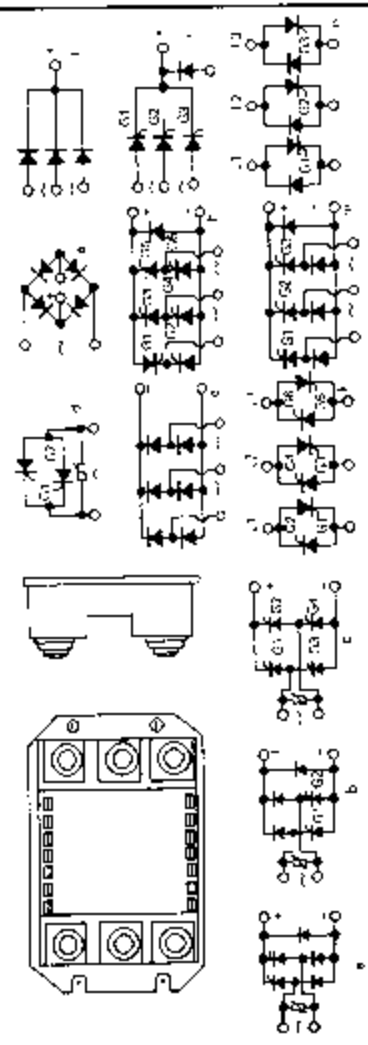

H-33

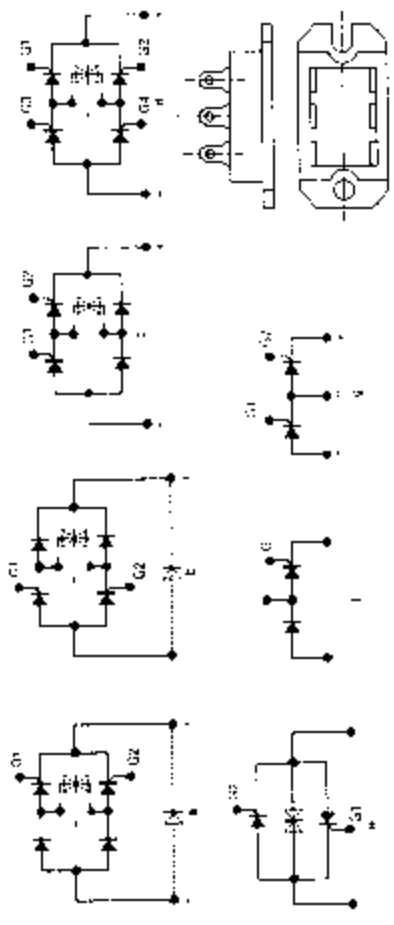

外形图