

DX100 OPERATOR'S MANUAL

**FOR MATERIAL HANDLING, PRESS TENDING, CUTTING,
AND OTHER APPLICATIONS**

Upon receipt of the product and prior to initial operation, read these instructions thoroughly, and retain for future reference.

MOTOMAN INSTRUCTIONS

MOTOMAN-□□□ INSTRUCTIONS

DX100 INSTRUCTIONS

DX100 OPERATOR'S MANUAL

DX100 MAINTENANCE MANUAL

The DX100 operator's manuals above correspond to specific usage.
Be sure to use the appropriate manual.

Do not submit this electronic data to the customer.

THIS MATERIAL IS FOR STUDY PURPOSE ONLY.
YOU MUST READ THE MANUAL WHICH ENCLOSED
WITH A ROBOT.





MANDATORY

- This manual explains the various components of the DX100 system and general operations. Read this manual carefully and be sure to understand its contents before handling the DX100.
- General items related to safety are listed in Section 1: Safety of the DX100 Instructions. To ensure correct and safe operation, carefully read the DX100 Instruction before reading this manual.



CAUTION

- Some drawings in this manual are shown with the protective covers or shields removed for clarity. Be sure all covers and shields are replaced before operating this product.
- The drawings and photos in this manual are representative examples and differences may exist between them and the delivered product.
- YASKAWA may modify this model without notice when necessary due to product improvements, modifications, or changes in specifications. If such modification is made, the manual number will also be revised.
- If your copy of the manual is damaged or lost, contact a YASKAWA representative to order a new copy. The representatives are listed on the back cover. Be sure to tell the representative the manual number listed on the front cover.
- YASKAWA is not responsible for incidents arising from unauthorized modification of its products. Unauthorized modification voids your product's warranty.

Notes for Safe Operation

Read this manual carefully before installation, operation, maintenance, or inspection of the DX100.

In this manual, the Notes for Safe Operation are classified as “WARNING,” “CAUTION,” “MANDATORY,” or “PROHIBITED.”



WARNING

Indicates a potentially hazardous situation which, if not avoided, could result in death or serious injury to personnel.



CAUTION

Indicates a potentially hazardous situation which, if not avoided, could result in minor or moderate injury to personnel and damage to equipment. It may also be used to alert against unsafe practices.



MANDATORY

Always be sure to follow explicitly the items listed under this heading.



PROHIBITED

Must never be performed.

Even items described as “CAUTION” may result in a serious accident in some situations.

At any rate, be sure to follow these important items.



To ensure safe and efficient operation at all times, be sure to follow all instructions, even if not designated as “CAUTION” and “WARNING.”



WARNING

- Before operating the manipulator, check that servo power is turned off when the emergency stop buttons on the front door of the DX 100 and programing pendant are pressed. When the servo power is turned off, the SERVO ON LED on the programing pendant is turned off.

Injury or damage to machinery may result if the emergency stop circuit cannot stop the manipulator during an emergency. The manipulator should not be used if the emergency stop buttons do not function.

Fig. : Emergency Stop Button



- Once the emergency stop button is released, clear the cell of all items which could interfere with the operation of the manipulator. Then turn the servo power ON.

Injury may result from unintentional or unexpected manipulator motion.

Fig. : Release of EM



- Observe the following precautions when performing teaching operations within the P-point maximum envelope of the manipulator:
 - View the manipulator from the front whenever possible.
 - Always follow the predetermined operating procedure.
 - Ensure that you have a safe place to retreat in case of emergency.

Improper or unintended manipulator operation may result in injury.

- Confirm that no person is present in the P-point maximum envelope of the manipulator and that you are in a safe location before:
 - Turning on the power for the DX100.
 - Moving the manipulator with the programming pendant.
 - Running the system in the check mode.
 - Performing automatic operations.

Injury may result if anyone enters the working envelope of the manipulator during operation. Always press an emergency stop button immediately if there are problems.

The emergency stop button is located on the right of the front door of the DX 100 and programing pendant.



CAUTION

- Perform the following inspection procedures prior to conducting manipulator teaching. If problems are found, repair them immediately, and be sure that all other necessary processing has been performed.
 - Check for problems in manipulator movement.
 - Check for damage to insulation and sheathing of external wires.
- Always return the programming pendant to the hook on the cabinet of the DX100 after use.

The programming pendant can be damaged if it is left in the manipulator's work area, on the floor, or near fixtures.

- Read and understand the Explanation of Warning Labels in the DX100 Instructions before operating the manipulator.

Definition of Terms Used Often in This Manual

The MOTOMAN manipulator is the YASKAWA industrial robot product.

The MOTOMAN usually consists of the manipulator, the controller, the programming pendant, and supply cables.

In this manual, the equipment is designated as follows.

Equipment	Manual Designation
DX100 controller	DX100
DX100 programming pendant	Programming pendant
Cable between the manipulator and the controller	Manipulator cable

Descriptions of the programming pendant keys, buttons, and displays are shown as follows:

Equipment		Manual Designation
Programming Pendant	Character Keys	The keys which have characters printed on them are denoted with []. ex. [ENTER]
	Symbol Keys	The keys which have a symbol printed on them are not denoted with [] but depicted with a small picture. ex. page key  The cursor key is an exception, and a picture is not shown.
	Axis Keys Numeric Keys	“Axis Keys” and “Numeric Keys” are generic names for the keys for axis operation and number input.
	Keys pressed simultaneously	When two keys are to be pressed simultaneously, the keys are shown with a “+” sign between them, ex. [SHIFT]+[COORD]
	Displays	The menu displayed in the programming pendant is denoted with { }. ex. {JOB}

Description of the Operation Procedure

In the explanation of the operation procedure, the expression "Select •••" means that the cursor is moved to the object item and the SELECT key is pressed, or that the item is directly selected by touching the screen.

Registered Trademark

In this manual, names of companies, corporations, or products are trademarks, registered trademarks, or brand names for each company or corporation. The indications of (R) and TM are omitted.

1	Introduction	1-1
1.1	DX100 Overview.....	1-1
1.2	Programming Pendant.....	1-2
1.2.1	Programming Pendant Overview.....	1-2
1.2.2	Key Description	1-3
1.2.2.1	Character Keys	1-3
1.2.2.2	Symbol Keys	1-3
1.2.2.3	Axis Keys and Numeric Keys	1-3
1.2.2.4	Keys Pressed Simultaneously.....	1-3
1.2.3	Programming Pendant Keys.....	1-4
1.2.4	Programming Pendant Display.....	1-11
1.2.4.1	Five Display Areas	1-11
1.2.4.2	General-purpose Display Area	1-12
1.2.4.3	Main Menu Area.....	1-13
1.2.4.4	Status Display Area.....	1-13
1.2.4.5	Human Interface Display Area	1-16
1.2.4.6	Menu Area.....	1-16
1.2.5	Screen Descriptions	1-17
1.2.6	Character Input Operation	1-18
1.2.6.1	Character Input	1-18
1.2.6.2	Operation	1-18
1.2.6.3	Alphanumeric Input	1-19
1.2.6.4	Symbol Input	1-20
1.3	Mode.....	1-21
1.3.1	Teach Mode	1-21
1.3.2	Play Mode	1-21
1.3.3	Remote Mode.....	1-21
1.3.4	Teach Mode Priority	1-21
1.4	Security Mode.....	1-22
1.4.1	Types of Security Modes	1-22
1.4.2	Changing Security Modes	1-26
2	Manipulator Coordinate Systems and Operations	2-1
2.1	Control Groups and Coordinate Systems	2-1
2.1.1	Control Group.....	2-1
2.1.2	Types of Coordinate Systems	2-2
2.2	General Operations	2-3
2.2.0.1	Check Safety.....	2-3
2.2.0.2	Select Teach Mode	2-3

2.2.0.3	Select Control Group	2-3
2.2.0.4	Select Coordinate System	2-3
2.2.0.5	Select Manual Speed	2-4
2.2.0.6	Servo ON	2-4
2.2.0.7	Axis Operation	2-4
2.2.0.8	HIGH SPEED	2-4
2.3	Coordinate Systems and Axis Operation	2-5
2.3.1	Joint Coordinates	2-5
2.3.2	Cartesian Coordinates	2-6
2.3.3	Cylindrical Coordinates	2-7
2.3.4	Tool Coordinates	2-9
2.3.4.1	Selecting Tool	2-11
2.3.5	User Coordinates	2-12
2.3.5.1	Selecting User Coordinates	2-13
2.3.5.2	Examples of User Coordinate Utilization	2-14
2.3.6	External Axis	2-14
2.3.7	Control Point Operation	2-15
2.3.7.1	Control Point Change	2-18
3	Teaching	3-1
3.1	Preparation for Teaching	3-1
3.1.1	Checking Emergency Stop Buttons	3-1
3.1.2	Setting the Teach Lock	3-1
3.1.3	Registering a Job	3-2
3.1.3.1	Registering Job Names	3-2
3.1.3.2	Registering Jobs	3-2
3.1.3.3	Registering Comments	3-3
3.1.3.4	Registering Control Groups	3-3
3.1.3.5	Switching to the Teaching Window	3-4
3.2	Teaching Operation	3-5
3.2.1	Teaching Window	3-5
3.2.2	Interpolation Type and Play Speed	3-6
3.2.2.1	Joint Interpolation	3-6
3.2.2.2	Linear Interpolation	3-7
3.2.2.3	Circular Interpolation	3-8
3.2.2.4	Spline Interpolation	3-9
3.2.3	Teaching Steps	3-11
3.2.3.1	Registering Move Instructions	3-11
3.2.3.2	Registering Reference Point Instructions	3-17
3.2.3.3	Registering Timer Instructions	3-18
3.2.4	Overlapping the First and Last Steps	3-21

3.3	Checking Steps.....	3-22
3.3.1	FWD/BWD Key Operations	3-22
3.3.1.1	Precautions When Using FWD / BWD Operations.....	3-23
3.3.1.2	Selecting Manual Speed	3-25
3.3.1.3	Moving to Reference Point.....	3-26
3.3.1.4	Test Operations.....	3-26
3.3.1.5	Machine Lock Operation	3-27
3.4	Modifying Steps	3-28
3.4.1	Displaying the JOB CONTENT Window for Editing.....	3-32
3.4.1.1	Currently Called Up Job	3-32
3.4.1.2	Calling Up Other Jobs	3-32
3.4.2	Inserting Move Instructions.....	3-33
3.4.3	Deleting Move Instructions	3-35
3.4.4	Modifying Move Instructions	3-36
3.4.4.1	Modifying Position Data.....	3-36
3.4.4.2	Modifying Interpolation Type	3-36
3.4.5	Undo Operation	3-37
3.4.6	Modifying Reference Point Instructions	3-38
3.4.6.1	Deleting Reference Point Instructions	3-38
3.4.6.2	Modifying Reference Point Instructions.....	3-38
3.4.7	Modifying Timer Instructions.....	3-39
3.4.7.1	Deleting Timer Instructions.....	3-39
3.4.7.2	Modifying Timer Instructions	3-39
3.5	Modifying Jobs.....	3-40
3.5.1	Calling Up a Job	3-40
3.5.2	Windows Related to Job.....	3-40
3.5.3	JOB HEADER Window.....	3-41
3.5.4	JOB CONTENT Window	3-42
3.5.4.1	COMMAND POSITION Window	3-43
3.5.5	JOB CAPACITY Window.....	3-44
3.6	Editing Instructions	3-45
3.6.1	Instruction Group.....	3-46
3.6.2	Inserting Instructions	3-47
3.6.3	Deleting Instructions	3-50
3.6.4	Modifying Instructions.....	3-50
3.6.5	Modifying Additional Numeric Data	3-54
3.6.6	Modifying Additional Items.....	3-55
3.6.7	Inserting Additional Items	3-56

3.6.8	Deleting Additional Items	3-57
3.7	Editing Jobs	3-58
3.7.1	Selecting the Range	3-60
3.7.2	Copying	3-61
3.7.3	Cutting	3-61
3.7.4	Pasting.....	3-62
3.7.5	Reverse Pasting	3-63
3.8	Test Operations	3-64
3.8.1	Test Operation Procedures.....	3-64
3.9	Other Job-editing Functions.....	3-65
3.9.1	Editing Play Speed	3-65
3.9.1.1	Modification of Speed Type	3-65
3.9.1.2	Relative Modification	3-65
3.9.1.3	Modification by TRT (Traverse Time).....	3-67
3.9.2	Editing Interpolation Type	3-69
3.9.3	Editing Condition Files.....	3-70
3.9.4	User Variables	3-71
3.9.4.1	Setting Byte, Integer, Double Precision Integer, and Real Type Variables.....	3-72
3.9.4.2	Setting Character Type Variables.....	3-74
3.9.4.3	Registering Variable Name.....	3-75
3.9.4.4	Displaying Position Variables	3-76
3.9.4.5	Setting Position Variables.....	3-77
3.9.4.6	Setting Position Variables Using the Numeric Keys.....	3-78
3.9.4.7	Setting Position Variables Using the Axis Keys.....	3-80
3.9.4.8	Deleting Data Set of Position Variables.....	3-81
3.9.4.9	Checking Positions by Position Variables	3-81
3.9.4.10	Manipulator Types	3-82
3.9.5	Flip/No Flip.....	3-83
3.9.6	R-axis Angle	3-83
3.9.7	T-axis Angle.....	3-84
3.9.8	Front/Back	3-84
3.9.9	Upper Arm/Lower Arm	3-86
3.9.10	S-axis Angle.....	3-86
3.9.11	Editing Local Variables	3-87
3.9.11.1	Setting the Number of Local Variables	3-89
3.9.12	Search	3-90
3.9.12.1	Line Search	3-91
3.9.12.2	Step Search.....	3-92
3.9.12.3	Label Search	3-93

3.9.12.4	Instruction Search	3-95
3.9.12.5	Tag Search.....	3-97
4	Playback	4-1
4.1	Preparation for Playback	4-1
4.1.1	Selecting a Job.....	4-1
4.1.1.1	Calling a Job	4-1
4.1.1.2	Registering the Master Job	4-2
4.1.1.3	Calling the Master Job.....	4-4
4.1.2	The PLAYBACK Window.....	4-6
4.1.2.1	Display of Cycle Time.....	4-6
4.1.2.2	Operation Cycle	4-7
4.2	Playback	4-10
4.2.1	Playback Operation	4-10
4.2.1.1	Selecting the Start Device	4-10
4.2.1.2	Servo On	4-10
4.2.1.3	Start Operation.....	4-10
4.2.2	Special Playback Operations.....	4-11
4.2.2.1	Low Speed Operation	4-11
4.2.2.2	Limited Speed Operations.....	4-12
4.2.2.3	Dry-run Speed Operations	4-12
4.2.2.4	Machine Lock Operation	4-13
4.2.2.5	Check Mode Operation	4-13
4.2.2.6	Weaving Prohibit Setting during Check Mode Operation	4-13
4.2.2.7	Cancel All Special Operations.....	4-14
4.3	Stop and Restart.....	4-15
4.3.1	Hold	4-15
4.3.1.1	Using the Programming Pendant	4-15
4.3.1.2	Using an External Input Signal (System Input).....	4-15
4.3.2	Emergency Stop	4-16
4.3.2.1	Restart After Emergency Stop.....	4-17
4.3.3	Stop by Alarm.....	4-18
4.3.4	Others.....	4-19
4.3.4.1	Temporary Stop by Mode Change	4-19
4.3.4.2	Temporary Stop by the PAUSE Instruction	4-19
4.4	Modifying Play Speed	4-20
4.4.1	Speed Override	4-20
4.4.1.1	Setting Speed Overrides	4-21
4.4.1.2	Modifying Play Speed	4-22
4.4.1.3	Cancelling Speed Override Settings	4-22
4.5	Playback with Reserved Start.....	4-23

4.5.1	Preparation for Reserved Start.....	4-23
4.5.1.1	Enabling Reserved Start.....	4-24
4.5.1.2	Registering Reserved Start I/O Signal.....	4-26
4.5.1.3	Registering Jobs to Stations.....	4-28
4.5.1.4	Deleting Registered Jobs from Stations.....	4-30
4.5.2	Playback from Reserved Start.....	4-31
4.5.2.1	Start Operation.....	4-31
4.5.2.2	Checking Job Reservation Status.....	4-32
4.5.2.3	Resetting Job Reservation.....	4-33
4.5.3	Hold Operation.....	4-34
4.5.3.1	[HOLD] on the Programming Pendant.....	4-34
4.5.3.2	Hold by External Input Signal (System Input).....	4-34
4.5.3.3	Hold at the Station.....	4-35
4.6	Displaying Job Stack.....	4-36
5	Editing Jobs.....	5-1
5.1	Copying Jobs.....	5-2
5.1.0.1	Copying Jobs on the JOB CONTENT Window.....	5-2
5.1.0.2	Copying Jobs on the JOB LIST Window.....	5-4
5.2	Deleting Jobs.....	5-6
5.2.0.1	Deleting Jobs on the JOB CONTENT Window.....	5-6
5.2.0.2	Deleting Jobs on the JOB LIST Window.....	5-7
5.3	Modifying Job Names.....	5-8
5.3.0.1	Modifying Job Names on the JOB CONTENT Window.....	5-8
5.3.0.2	Modifying Job Names on the JOB LIST Window.....	5-10
5.4	Editing Comments.....	5-12
5.5	Setting Edit Lock on Individual Job Units.....	5-14
5.6	Enabling the Modification of Position Data Only.....	5-15
6	Convenient Functions.....	6-1
6.1	One-touch Operation "Direct Open".....	6-1
6.2	Parallel Shift Function.....	6-3
6.2.1	Function Overview.....	6-3
6.2.1.1	Parallel Shift of Step.....	6-4
6.2.1.2	Parallel Shift of Job.....	6-4
6.2.2	Setting the Shift Value.....	6-5
6.2.2.1	Coordinate Systems.....	6-5
6.2.2.2	Setting the Shift Value.....	6-5
6.2.3	Registering Shift Instructions.....	6-7
6.2.3.1	SFTON Instruction.....	6-8
6.2.3.2	SFTOF Instruction.....	6-10

6.2.3.3	MSHIFT Instruction	6-11
6.2.4	Continuation of the Parallel Shift Function	6-13
6.2.5	Examples of Use	6-14
6.2.5.1	Example of Use of Shift Addition/Subtraction.....	6-14
6.2.5.2	Example of Use of MSHIFT Instruction	6-15
6.3	Parallel Shift Job Conversion Function.....	6-16
6.3.1	Function Overview.....	6-16
6.3.2	Coordinate Systems for Conversion.....	6-17
6.3.3	Executing the Parallel Shift Job Conversion.....	6-21
6.3.3.1	Window Display.....	6-21
6.3.3.2	Parallel Shift Job Conversion Operation	6-23
6.3.4	Specifying the Shift Value by Position Variables	6-29
6.3.4.1	Window Display.....	6-29
6.3.4.2	Jobs Targeted for Conversion	6-31
6.3.4.3	Conversion of Coordinated Jobs	6-32
6.3.4.4	Operation Procedure	6-35
6.4	PAM Function	6-37
6.4.1	Function Overview.....	6-37
6.4.1.1	Input Ranges for Adjustment Data	6-37
6.4.2	Operating Methods.....	6-39
6.4.2.1	Setting Adjustment Data	6-39
6.4.2.2	Executing the Adjustment	6-41
6.5	Mirror Shift Function	6-45
6.5.1	Function Overview.....	6-45
6.5.2	Pulse Mirror-shift Function.....	6-46
6.5.2.1	Parameter Setting	6-46
6.5.2.2	Object Job	6-46
6.5.2.3	Group Axes Specification.....	6-46
6.5.2.4	Position Variables	6-46
6.5.3	Robot-coordinates Mirror-shift Function	6-47
6.5.3.1	Object Job	6-47
6.5.3.2	Group Axes Specification.....	6-47
6.5.3.3	Position Variables	6-47
6.5.4	User-coordinates Mirror-shift Function	6-48
6.5.4.1	Object Job	6-48
6.5.4.2	Group Axes Specification.....	6-48
6.5.4.3	Position Variables	6-48
6.5.5	Notes on the Mirror Shift Function.....	6-49
6.5.6	Operation Procedures	6-50
6.5.6.1	Calling Up the JOB CONTENT Window.....	6-50
6.5.6.2	Mirror Shift Conversion.....	6-50

6.5.6.3	Explanation of the Mirror Shift Window	6-51
6.6	Multi Window Function.....	6-53
6.6.1	Function Overview	6-53
6.6.2	Setting the Dividing Pattern of the General-Purpose Display Area	6-53
6.6.2.1	Calling Up and Operating Methods of the Display Dividing Pattern Setting Window.....	6-54
6.6.3	Displaying the Multi Window.....	6-58
6.6.3.1	Multi Window Mode and Single Window Mode	6-58
6.6.3.2	Displaying the Status of Plural (more than two) Window Dividing Pattern Setting.....	6-58
6.6.3.3	Displaying of Active Window and Non-Active Window	6-59
6.6.3.4	Limited Matters in Multi Window Mode.....	6-59
6.6.4	Operation of Multi Window.....	6-60
6.6.4.1	Switching of Multi Window Mode and Single Window Mode	6-60
6.6.4.2	Switching of Active Window.....	6-62
6.6.5	Switching the Axis Operation Control Group	6-64
6.6.5.1	S2C540 “Choosing Method of Notifying the Change of Axis Operation Control Group when Switching the Active Window”	6-64
7	External Memory Devices	7-1
7.1	Memory Devices	7-1
7.1.1	Compact Flash (CF Cards).....	7-2
7.1.1.1	Recommended Compact Flash Cards	7-2
7.1.1.2	Notes on handling Compact Flash	7-2
7.1.1.3	Inserting a Compact Flash.....	7-3
7.1.2	USB Memory Stick.....	7-4
7.1.2.1	Recommended USB Memory Stick	7-4
7.1.2.2	Notes on handling USB Memory Stick	7-4
7.1.2.3	Inserting a USB Memory Stick.....	7-5
7.2	Handling Data	7-6
7.2.1	Data Classification	7-6
7.2.2	File Existence	7-9
7.2.2.1	Saving by Overwriting.....	7-10
7.3	Operation Flow.....	7-11
7.3.0.1	Operating a Folder	7-12
7.3.0.2	Saving Data	7-16
7.3.0.3	Loading Data	7-28
7.3.0.4	Verifying Data.....	7-38
7.3.0.5	Deleting Data.....	7-41
7.3.0.6	Job Selection Mode.....	7-43
8	Parameter	8-1
8.1	Parameter Configuration.....	8-1

8.2	Motion Speed Setting Parameters.....	8-2
8.2.0.1	S1CxG000: IN-GUARD SAFE OPERATION MAX. SPEED	8-2
8.2.0.2	S1CxG001: DRY-RUN SPEED	8-2
8.2.0.3	S1CxG002 to S1CxG009: JOINT SPEED FOR REGISTRATION	8-2
8.2.0.4	S1CxG010 to S1CxG017: LINEAR SPEED FOR REGISTRATION	8-3
8.2.0.5	S1CxG018 to S1CxG025: POSITION ANGLE SPEED.....	8-3
8.2.0.6	S1CxG026 to S1CxG029: JOG OPERATION ABSOLUTE VALUE SPEED	8-3
8.2.0.7	S1CxG030 to S1CxG032: INCHING MOVE AMOUNT.....	8-4
8.2.0.8	S1CxG033 to S1CxG040: POSITIONING ZONE.....	8-4
8.2.0.9	S1CxG044: LOW-SPEED START	8-6
8.2.0.10	S1CxG045 to S1CxG048: JOG OPERATION LINK SPEED	8-6
8.2.0.11	S1CxG056: WORK HOME POSITION RETURN SPEED	8-6
8.2.0.12	S1CxG057: SEARCH MAX. SPEED.....	8-6
8.2.0.13	S2C201: POSTURE CONTROL AT CARTESIAN OPERATION OF JOG	8-6
8.2.0.14	S2C202: OPERATION IN USER COORDINATE SYSTEM (WHEN EXTERNAL REFERENCE POINT CONTROL FUNCTION USED).....	8-6
8.2.0.15	S2C320: CONTROLLED GROUP JOB TEACHING POSITION CHANGE	8-7
8.2.0.16	S2C422: OPERATION AFTER RESET FROM PATH DEVIATION.....	8-7
8.2.0.17	S2C423: OPERATION AFTER JOB	8-7
8.2.0.18	S2C424: DEVIATED POSITION	8-8
8.2.0.19	S2C425: CIRCULAR INTERPOLATION TOOL POSITION CONTROL....	8-9
8.2.0.20	S2C653: EMERGENCY STOP CURSOR ADVANCE CONTROL FUNCTION.....	8-9
8.2.0.21	S2C654: EMERGENCY STOP CURSOR ADVANCE CONTROL FUNCTION CONT PROCESS COMPLETION POSITION.....	8-10
8.2.0.22	S2C655: EMERGENCY STOP ADVANCE CONTROL FUNCTION WORK START INSTRUCTION STEP MOTION COMPLETION DELAY TIME	8-10
8.2.0.23	S2C698: BASE AXIS OPERATION KEY ALLOCATION SETTING....	8-10
8.2.0.24	S3C1098 to S3C1102: POSITION CORRECTING FUNCTION DURING PLAYBACK	8-11
8.3	Mode Operation Setting Parameters	8-12
8.3.0.1	S2C195: SECURITY MODE WHEN CONTROL POWER SUPPLY IS TURNED ON.....	8-12
8.3.0.2	S2C196: SELECTION OF CARTESIAN/CYLINDRICAL.....	8-12
8.3.0.3	S2C197: COORDINATE SWITCHING PROHIBITED.....	8-12
8.3.0.4	S2C198: EXECUTION UNITS AT "FORWARD" OPERATION.....	8-12
8.3.0.5	S2C199: INSTRUCTION (EXCEPT FOR MOVE) EXECUTION AT "FORWARD" OPERATION	8-13
8.3.0.6	S2C203: CHANGING STEP ONLY.....	8-13
8.3.0.7	S2C204: MANUAL SPEED STORING FOR EACH COORDINATE	8-13
8.3.0.8	S2C206: ADDITIONAL STEP POSITION	8-13
8.3.0.9	S2C207: MASTER JOB CHANGING OPERATION.....	8-14
8.3.0.10	S2C208: CHECK AND MACHINE-LOCK KEY OPERATION IN PLAY MODE	8-14
8.3.0.11	S2C209: RESERVED WORK JOB CHANGING OPERATION.....	8-14
8.3.0.12	S2C210: MASTER OR SUBMASTER CALL OPERATION IN PLAY MODE.....	8-14

8.3.0.13	S2C211: LANGUAGE LEVEL	8-15
8.3.0.14	S2C214: INSTRUCTION INPUT LEARNING FUNCTION	8-15
8.3.0.15	S2C215: ADDRESS SETTING WHEN CONTROL POWER IS TURNED ON	8-15
8.3.0.16	S2C216: JOB LIST DISPLAY METHOD AT JOB SELECTION	8-15
8.3.0.17	S2C217: INITIAL OPERATION OF MANIPULATOR	8-16
8.3.0.18	S2C218: PLAYBACK EXECUTION AT CYCLE MODE "1- STEP"	8-16
8.3.0.19	S2C219: EXTERNAL START	8-16
8.3.0.20	S2C220: PROGRAMMING PENDANT START	8-16
8.3.0.21	S2C221: SPEED DATA INPUT FORM	8-17
8.3.0.22	S2C222: RESERVED START	8-17
8.3.0.23	S2C224: JOB SELECTION AT REMOTE FUNCTION (PLAY MODE)	8-17
8.3.0.24	S2C225: EXTERNAL MODE SWITCH	8-17
8.3.0.25	S2C227: EXTERNAL CYCLE SWITCHING	8-17
8.3.0.26	S2C228: PROGRAMMING PENDANT CYCLE SWITCHING	8-18
8.3.0.27	S2C229: SERVO ON FROM EXTERNAL PP PROHIBITION	8-18
8.3.0.28	S2C230: PROGRAMMING PENDANT OPERATION WHEN "IO" IS SELECTED FOR REMOTE MODE	8-18
8.3.0.29	S2C234: STEP REGISTRATION AT TOOL NO. CHANGE	8-19
8.3.0.30	S2C293: REMOTE FIRST CYCLE MODE	8-19
8.3.0.31	S2C294: LOCAL FIRST CYCLE MODE	8-19
8.3.0.32	S2C312: POWER ON FIRST CYCLE MODE	8-19
8.3.0.33	S2C313: TEACH MODE FIRST CYCLE MODE	8-20
8.3.0.34	S2C314: PLAY MODE FIRST CYCLE MODE	8-21
8.3.0.35	S2C316: START CONDITION AFTER ALARM-4107 ("OUT OF RANGE (ABSO DATA)")	8-21
8.3.0.36	S2C395: SIGNAL NAME ALIAS FUNCTION	8-22
8.3.0.37	S2C396: VARIABLE NAME ALIAS FUNCTION	8-23
8.3.0.38	S2C397: I/O VARIABLE CUSTOMIZE FUNCTION	8-24
8.3.0.39	S2C415 to S2C419: TIME RESET	8-25
8.3.0.40	S2C431: TOOL NO. SWITCHING	8-25
8.3.0.41	S2C433: POSITION TEACHING BUZZER	8-25
8.3.0.42	S2C434: JOB LINKING DESIGNATION (When Twin Synchronous Function Used)	8-25
8.3.0.43	S2C437: PLAYBACK OPERATION CONTINUATION FUNCTION	8-27
8.4	Parameters according to Interference Area	8-28
8.4.0.1	S1CxG400 to S1CxG415: PULSE SOFT LIMIT	8-28
8.4.0.2	S2C001: CUBE SOFT LIMIT CHECK	8-28
8.4.0.3	S2C002: S-AXIS INTERFERENCE CHECK	8-29
8.4.0.4	S2C003 to S2C066: CUBE/AXIS INTERFERENCE CHECK	8-30
8.4.0.5	S2C067 to S2C194: CUBE USING METHOD	8-32
8.4.0.6	S3C000 to S3C047: CUBE SOFT LIMIT	8-34
8.4.0.7	S3C048 to S3C063: S-AXIS INTERFERENCE AREA	8-34
8.4.0.8	S3C064 to S3C1087: CUBIC INTERFERENCE AREA	8-34
8.4.0.9	S3C1089 to S3C1096: ROBOT INTERFERENCE AREA	8-34
8.4.0.10	S3C1097: A SIDE LENGTH OF WORK-HOME-POSITION CUBE	8-34
8.5	Parameters according to Status I/O	8-35

8.5.0.1	S2C235: USER OUTPUT RELAY WHEN CONTROL POWER IS ON	8-35
8.5.0.2	S4C000 to S4C015: PARITY OF USER INPUT GROUPS	8-35
8.5.0.3	S4C016 to S4C031: PARITY OF USER OUTPUT GROUPS	8-36
8.5.0.4	S4C032 to S4C047: DATA OF USER INPUT GROUPS	8-37
8.5.0.5	S4C048 to S4C063: DATA OF USER OUTPUT GROUPS	8-38
8.5.0.6	S4C064 to S4C079: USER OUTPUT GROUP TO BE INITIALIZED AT SWITCHING MODE	8-39
8.5.0.7	S4C240: USER OUTPUT NO. WHEN MANIPULATOR DROP ALLOWABLE RANGE ERROR OCCURS	8-39
8.6	Parameters according to Coordinated or Synchronized Operation	8-40
8.6.0.1	S2C212: +MOV or +SMOV INSTRUCTION SPEED INPUT	8-40
8.6.0.2	S2C213: +MOV INSTRUCTION INTERPOLATION INPUT	8-40
8.6.0.3	S2C231: OPERATION METHOD AT FWD/BWD OPERATION OR TEST RUN BY INDEPENDENT CONTROL	8-40
8.6.0.4	S2C232: JOB AT CALLING MASTER OF SUBTASK 1, 2, 3, 4, 5, 6, 7 BY INDEPENDENT CONTROL	8-41
8.6.0.5	S2C264: STATION AXIS CURRENT VALUE DISPLAY FUNCTION	8-41
8.6.0.6	S2C265 to S2C288: STATION AXIS DISPLAYED UNIT	8-41
8.6.0.7	S2C420: POSTURE CONTROL OF SYNCHRONIZED MANIPULATOR (When Twin Synchronous Function Used)	8-42
8.6.0.8	S2C421: POSTURE CONTROL OF MANIPULATOR IN MULTI-JOB (When Twin Synchronous Function Used)	8-42
8.6.0.9	S2C687: OPERATION OF JOB WITHOUT CONTROL GROUP SPECIFICATION	8-43
8.6.0.10	S2C688: EXECUTION OF "BWD" OPERATION	8-43
8.6.0.11	S3C1101: MAXIMUM DEVIATION ANGLE OF CURRENT STATION POSITION (When Twin Synchronous Function Used)	8-43
8.7	Parameters for Other Functions or Applications	8-44
8.7.0.1	S1CxG049 to S1CxG051: SMALL CIRCLE CUTTING	8-44
8.7.0.2	S1CxG052 to S1CxG053: SMALL CIRCLE CUTTING DIRECTION LIMIT VALUE	8-44
8.7.0.3	S1CxG054 to S1CxG055: SMALL CIRCLE CUTTING OVERLAP VALUE	8-44
8.7.0.4	S1CxG063, S1CxG064: PATTERN CUTTING DIMENSION	8-44
8.7.0.5	S1CxG065: MIRROR SHIFT SIGN INVERSION	8-44
8.7.0.6	S2C430: RELATIVE JOB OPERATION METHOD	8-44
8.7.0.7	S3C1111 to S3C1190: ANALOG OUTPUT FILTER CONSTANT (When analog output corresponding to speed function is used)	8-45
8.7.0.8	S3C1191: CUT WIDTH CORRECTION VALUE (When form cutting function is used)	8-45
8.8	Hardware Control Parameters	8-46
8.8.0.1	S2C646: ANTICIPATOR FUNCTION	8-46
8.8.0.2	S2C786 to S2C788: COOLING FAN ALARM DETECTION	8-47
8.8.0.3	S4C327 to S4C390: SETTING OF OPERATING RELAY NO.	8-47
8.8.0.4	S4C391 to S4C454: OPERATING METHOD OF RELAYS	8-47
8.8.0.5	S2C789 to S2C792: COOLING FAN ALARM 1 OPERATION	8-48
8.8.0.6	S2C793 to S2C796: COOLING FAN ALARM 2 OPERATION	8-48
8.8.0.7	S2C797 to S2C800: COOLING FAN ALARM 3 OPERATION	8-48
8.8.0.8	S2C801 to S2C804: FAN ALARM 1 POWER SOURCE STATUS	8-48

8.8.0.9	S2C805 to S2C808: FAN ALARM 2 POWER SOURCE STATUS.....	8-48
8.8.0.10	S2C809 to S2C812: FAN ALARM 3 POWER SOURCE STATUS.....	8-48
8.9	TRANSMISSION PARAMETERS.....	8-49
8.10	Application Parameters.....	8-49
8.10.1	Arc Welding	8-49
8.10.1.1	AxP000: APPLICATION	8-49
8.10.1.2	AxP003: WELDING ASSIGNMENT OF WELDING START CONDITION FILE.....	8-49
8.10.1.3	AxP004: WELDING ASSIGNMENT OF WELDING END CONDITION FILES	8-49
8.10.1.4	AxP005: WELDING SPEED PRIORITY	8-49
8.10.1.5	AxP009: WORK CONTINUING	8-49
8.10.1.6	AxP010: WELDING INSTRUCTION OUTPUT	8-50
8.10.1.7	AxP011, AxP012: MANUAL WIRE OPERATION SPEED.....	8-50
8.10.1.8	AxP013, AxP014: WELDING CONTROL TIME	8-50
8.10.1.9	AxP015 to AxP017: NUMBER OF WELDING CONTROL	8-50
8.10.1.10	AxP026 to AxP029: TOOL ON/OFF USER OUTPUT NO. (Jigless system).....	8-50
8.10.2	Handling Application.....	8-50
8.10.2.1	AxP002, AxP004: f1 KEY FUNCTION.....	8-50
8.10.2.2	AxP003, AxP005: f2 KEY FUNCTION.....	8-50
8.10.3	Spot Welding	8-50
8.10.3.1	AxP003: MAXIMUM NUMBER OF CONNECTED POWER SOURCES.....	8-50
8.10.3.2	AxP004: GUN FULL OPEN STROKE ON/OFF SIGNAL	8-51
8.10.3.3	AxP005: STROKE CHANGE ANSWER TIME LIMIT	8-51
8.10.3.4	AxP006: PARITY SPECIFICATION FOR WELDING CONDITIONS.....	8-51
8.10.3.5	AxP007: ANTICIPATE TIME	8-51
8.10.3.6	AxP015: WELDING ERROR RESET OUTPUT TIME.....	8-51
8.10.3.7	AxP016, AxP017: ELECTRODE WEAR AMOUNT ALARM VALUE ...	8-51
8.10.4	General-purpose Application	8-52
8.10.4.1	AxP009: WORK CONTINUE PROHIBIT	8-52
9	General Purpose Application	9-1
9.1	Simplified Teaching and Playback.....	9-1
9.1.1	Teaching.....	9-1
9.1.1.1	Preparation for Teaching.....	9-1
9.1.1.2	Teaching Procedure	9-4
9.1.1.3	Path Confirmation.....	9-13
9.1.1.4	Correcting a Job	9-14
9.1.1.5	Changing the Position Data.....	9-15
9.1.2	Playback	9-19
9.1.2.1	Preparation Before Playback.....	9-19
9.1.2.2	Playback Procedure	9-19
9.1.3	Example for General Purpose Application.....	9-20

9.1.3.1	Example Job	9-20
9.1.3.2	Teaching Procedure	9-21
9.1.3.3	Confirmation of Cutting Operation (Speed Limitation Drive)	9-24
9.2	Operation for Tool Control	9-25
9.2.1	Function Keys.....	9-25
9.2.2	Tool Control Settings.....	9-26
9.2.3	Work Instructions.....	9-27
9.2.3.1	TOOLON/TOOLOF Instructions.....	9-27
9.2.3.2	CALL Instruction.....	9-28
9.2.3.3	WVON Instruction.....	9-29
9.2.3.4	WVOF Instruction.....	9-29
9.3	Using Files.....	9-30
9.3.1	Weaving Basic Coordinate System	9-30
9.3.2	WEAVING CONDITION Window.....	9-31
9.3.3	Operation Method.....	9-34
9.3.3.1	Displaying a Weaving File	9-34
9.3.3.2	Editing Condition Data	9-34
9.3.3.3	Cases that Require the Registration of Reference Points.....	9-34
9.3.3.4	Prohibiting Weaving	9-35
9.3.3.5	Method to Prohibit Weaving in the Check Mode	9-35
9.3.3.6	Method to Prohibit Weaving During a "TEST RUN" or FWD Operation ...	9-36
9.3.3.7	Prohibiting Weaving By Means of a System Input Signal	9-36
9.4	Table of Work Instructions.....	9-37
10	Handling Application.....	10-1
10.1	Outlines	10-1
10.1.1	Function Keys.....	10-1
10.1.2	HAND Instruction.....	10-2
10.1.2.1	Function	10-2
10.1.2.2	Instruction and Additional Items	10-2
10.1.3	HSEN (Gripper Sensor) Instruction	10-3
10.1.3.1	Function	10-3
10.1.3.2	Instruction and Additional Items	10-3
10.1.3.3	Examples	10-4
10.1.4	Handling Window.....	10-4
10.1.5	Shock Sensor Function	10-6
10.1.6	Shock Sensor Input Signal	10-6
10.1.7	Shock Sensor Input Reset.....	10-6
10.1.8	Low Air Pressure Input Signal	10-6
10.2	Registering Instructions	10-7

10.2.1	HAND Instruction	10-7
10.2.2	HSEN Instruction	10-9
10.3	Table of Work Instructions	10-12
11	Table of Basic Instructions	11-1
11.1	Move Instructions	11-1
11.2	I/O Instructions	11-3
11.3	Control Instructions	11-5
11.4	Shift Instructions	11-7
11.5	Operating Instructions	11-8

1 Introduction

1.1 DX100 Overview

The main power switch and the door lock are located on the front of the DX100 controller. The emergency stop button is installed in the upper right corner of the cabinet door and the programming pendant hangs from a hook below the button.

For information on setup, installation, and connection of the DX100 system, refer to the “DX100 INSTRUCTIONS.”

Fig. 1-1: DX100 Front View

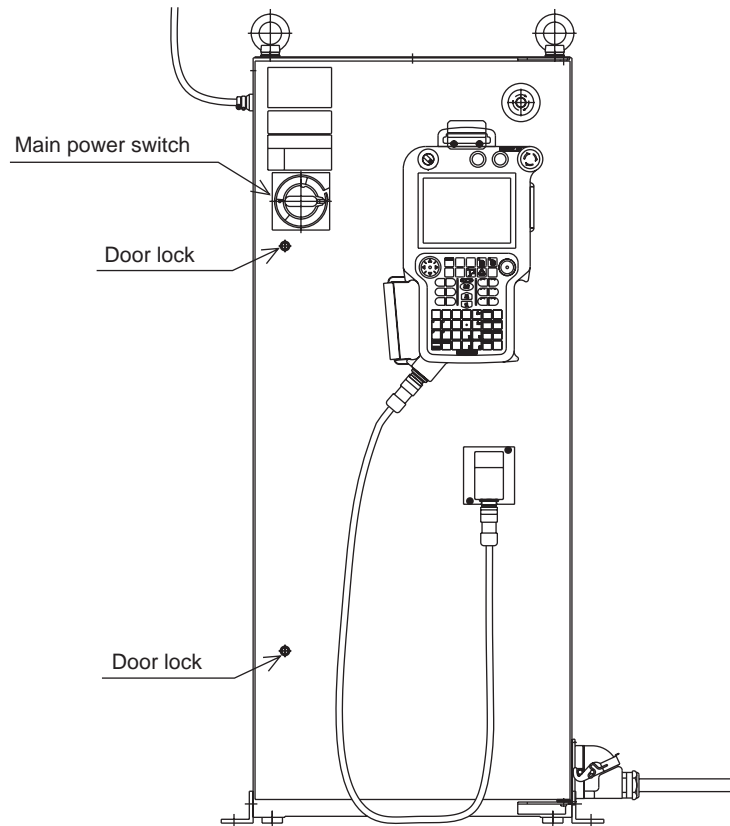

1.2 Programming Pendant

1.2.1 Programming Pendant Overview

The programming pendant is equipped with the keys and buttons used to conduct manipulator teaching operations and to edit jobs.

Fig. 1-2: PP Overview

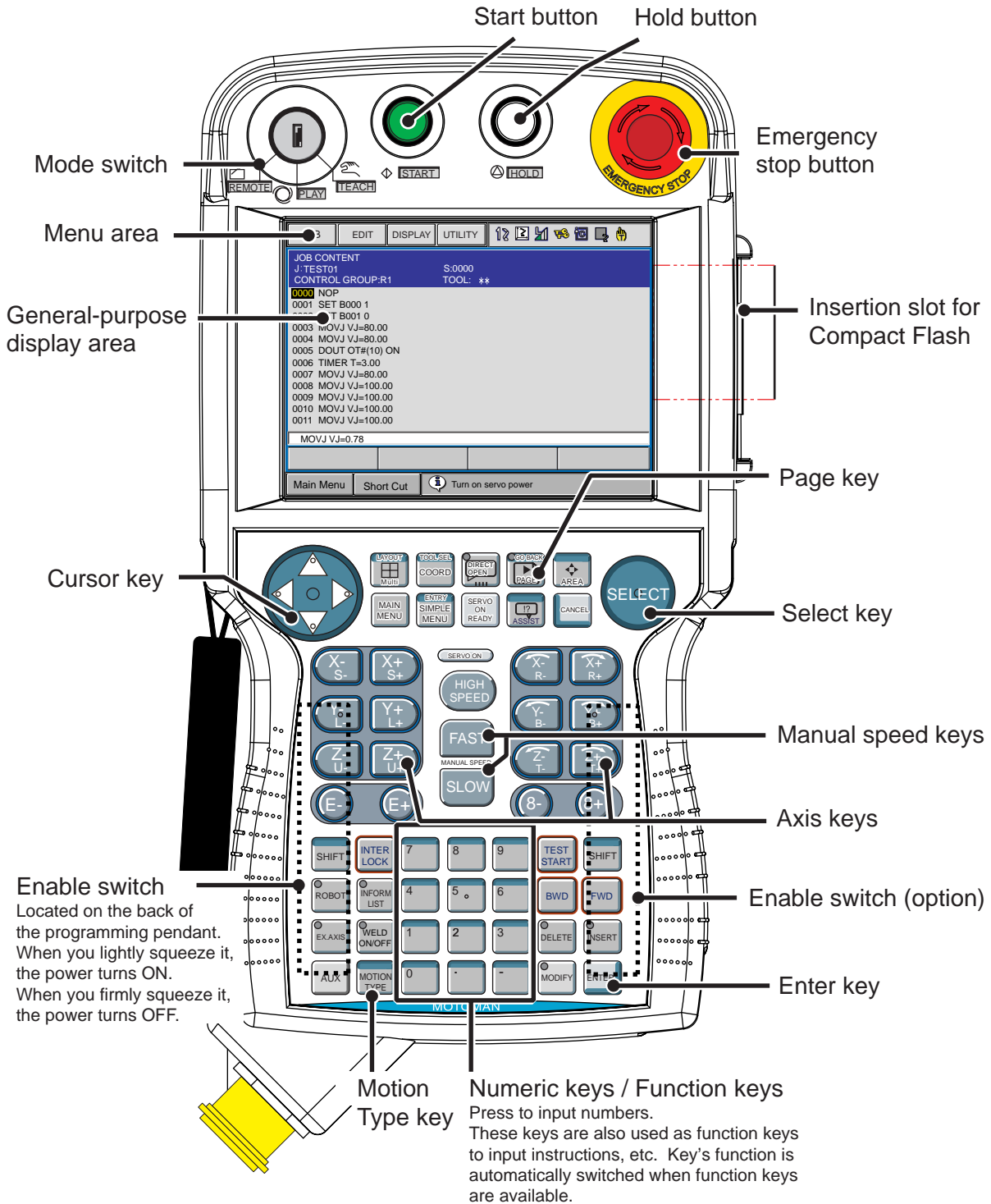

1.2.2 Key Description

1.2.2.1 Character Keys

The keys which have characters printed on them are denoted with []. For example,  is shown as [ENTER].

The Numeric keys have additional functions along with their number values. Dual function keys are used in the context of the operation being performed. For example:  may be described in the text as [1] or [TIMER].

1.2.2.2 Symbol Keys

The keys which have a symbol printed on them are not denoted with [] but depicted with a small picture, with the exception of the cursor key, which is not shown with a picture.



Cursor



Emergency Stop button



Direct Open key



Page key

1.2.2.3 Axis Keys and Numeric Keys

The keys pictured in the following are referred to as the axis keys and Numeric keys when described.

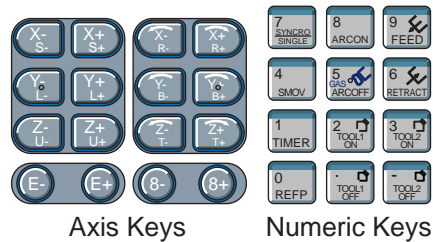





Axis Keys





Numeric Keys





1.2.2.4 Keys Pressed Simultaneously





When two keys are to be pressed simultaneously, the keys are shown with a “+” sign between them, such as [SHIFT]+[COORD].





1.2.3 Programming Pendant Keys







<p>[START]</p> 	<p>Starts the manipulator motion in playback operation.</p> <ul style="list-style-type: none"> The lamp on this button is lit during the play operation. <p>The lamp also lights when the playback operation is started by the system input START signal. The lamp turns OFF when the playback operation is stopped by alarm occurrence, HOLD signal, or mode change.</p>
<p>[HOLD]</p> 	<p>Holds the manipulator motion.</p> <ul style="list-style-type: none"> This button is enabled in any mode. The lamp on this button is lit only while the button is being pressed. Although the lamp turns OFF when the button is released, the manipulator stays stopped until a START command is input. The HOLD lamp automatically lights in the following cases to indicate that the system is in HOLD status. The start and axis operations are disabled while the lamp is lit. <ol style="list-style-type: none"> The HOLD signal of system input is ON. The HOLD request is being sent from an external device in remote mode. In the HOLD status caused by an error occurred in working process such as wire sticking at arc welding.
<p>E.STOP Button</p> 	<p>Turns OFF the servo power.</p> <ul style="list-style-type: none"> When the servo power is turned OFF, the SERVO ON LED on the programming pendant will extinguish. An emergency stop message is displayed on the screen.
<p>[MODE]</p> 	<p>Selects the Play mode, Teach mode, or Remote mode.</p> <hr/> <p>PLAY: Play Mode The playback of taught job is enabled. The START signal from an external device is disabled.</p> <hr/> <p>TEACH: Teach Mode The axis operation and edition from the programming pendant are enabled. The START signal from an external device is disabled.</p> <hr/> <p>REMOTE: Remote Mode The operation by external signals is enabled. [START] is invalid during the remote mode.</p>





Enable Switch	Turns ON the servo power. The Enable switch is active only when the SERVO ON LED is blinking, the safety plug is ON, and the Mode Switch is set to "TEACH." When this switch is lightly squeezed, the power turns ON. When firmly squeezed, the power turns OFF.
[SELECT] 	Works as described below. <ul style="list-style-type: none"> • Selects menu items in the main menu area and the pull-down menu area. • Makes the selected item ready to be set in the general-purpose display area. • Displays multiple messages in the message area.
Cursor 	Moves the cursor in the direction of the arrow. <ul style="list-style-type: none"> • The size of the cursor and the range/place where the cursor can move will vary depending on the window. • If the UP cursor button is pressed when the cursor is on the first line, the cursor will move to the last line of the job. Conversely, if the cursor is on the last line of the job and the DOWN cursor button is pressed, the cursor will jump to the first line of the job. <p>[SHIFT] + UP Scrolls the screen upward.</p> <p>[SHIFT] + DOWN Scrolls the screen downward.</p> <p>[SHIFT] + RIGHT Scrolls the screen to the right.</p> <p>[SHIFT] + LEFT Scrolls the screen to the left.</p>
[MAIN MENU] 	Displays the main menu. If this button is pressed while the main menu is displayed, the main menu disappears. <p>[MAIN MENU] + UP Increases the brightness of the screen.</p> <p>[MAIN MENU] + DOWN Decreases the brightness of the screen.</p>
[SIMPLE MENU] 	Displays the simple menu. If this button is pressed while the simple menu is displayed, the simple menu disappears.

<p>[SERVO ON READY]</p> 	<p>Enables the servo power supply to be turned ON. Press this button to enable the servo power supply to be turned ON if the servo power supply is shut OFF by the emergency stop or overrun signal. When this button is pressed:</p> <ul style="list-style-type: none"> • In the play mode, the servo power supply is turned ON if the safeguarding is securely closed. • In the teach mode, the SERVO ON lamp flashes and the servo power supply is turned ON when the Enable switch is ON. • The SERVO ON lamp is lit while the servo power is ON.
<p>[ASSIST]</p> 	<p>Displays the menu to assist the operation for the currently displayed window. Pressing this button with [SHIFT] or [INTERLOCK] displays the help guidance for the operation.</p> <ul style="list-style-type: none"> • [SHIFT] + [ASSIST] The function list of key combinations with [SHIFT] appears. • [INTERLOCK] + [ASSIST] The function list of key combinations with [INTERLOCK] appears.
<p>[CANCEL]</p> 	<p>Cancels the current status.</p> <ul style="list-style-type: none"> • Deletes the sub menu in the main menu area and the pull-down menu area. • Cancels the input data or the input status in the general-purpose display area. • Cancels the multiple views in the message area. • Cancels the occurred error.
<p>[MULTI]</p> 	<p>Works for the multi mode. If this button is pressed when the multi mode is ON, the active window switches.</p> <p>[SHIFT] + [MULTI] Switches between the multi-window display and the single-window display when the multi mode is ON.</p>
<p>[COORD]</p> 	<p>Select the operation coordinate system when the manipulator is operated manually.</p> <ul style="list-style-type: none"> • Five coordinate systems (joint, cartesian, cylindrical, tool and user) can be used. Each time this key is pressed, the coordinate system is switched in the following order: "JOINT"→"WLD/CYL"→"TOOL"→"USER" • The selected coordinate system is displayed on the status display area. <p>[SHIFT] + [COORD] The coordinate number can be changed when the "TOOL" or "USER" coordinate system is selected.</p>

<p>[DIRECT OPEN]</p> 	<p>Displays the content related to the current line.</p> <ul style="list-style-type: none"> To display the content of a CALL job or condition file, move the cursor to the next line and press [DIRECT OPEN]. The file will be displayed for the selected line. Display content will vary depending on the type of instruction used in the job. <p>Example: For a CALL instruction, the content of the called job will be displayed. For a work instruction, the content of the condition file will be displayed. For Input/output instructions, the input/output condition will be displayed.</p> <ul style="list-style-type: none"> The lamp on this button is lit while the direct open is ON. Press this button while the lamp is lit to return to the previous window.
<p>[PAGE]</p> 	<p>Displays the next page.</p> <p>The page can be switched only when the lamp on this button is lit. [SHIFT] + [PAGE] Switches to the previous page.</p>
<p>[AREA]</p> 	<p>Moves the cursor in the following order : "Menu Area" → "General-Purpose Display Area" → "Message Area" → "Main Menu Area". If no item is displayed, the cursor does not move.</p> <p>[SHIFT] + [AREA] The language can be switched when the bilingual function is valid. (Bilingual function is optional.) [AREA] + DOWN Moves the cursor from the general-purpose display area to the operation button when the operation button is displayed. [AREA] + UP Moves the cursor to the general-purpose display area when the cursor is on the operation button.</p>
<p>[SHIFT]</p> 	<p>Changes the functions of other keys by pressing together.</p> <p>Can be used with [MAIN MENU], [ASSIST], [COORD], [AREA], [MOTION TYPE], cursor key or Numeric key to access alternate functions. Refer to the description of each key for the alternate [SHIFT] functions.</p>
<p>[INTERLOCK]</p> 	<p>Changes the functions of other keys by pressing together.</p> <p>Can be used with [ASSIST], [MULTI], [TEST START], [FWD], or Numeric key (Numeric key customize function). Refer to the description of each key for the alternate [INTERLOCK] functions.</p>

<p>[INFORM LIST]</p> 	<p>Displays instruction lists of commands available for job editing.</p>
<p>[ROBOT]</p> 	<p>Enables the robot axis operation.</p> <p>[ROBOT] is active for the system where multiple manipulators are controlled by one DX100 or the system with external axes.</p>
<p>[EX. AXIS]</p> 	<p>Enables the external axis (base axis or station axis) operation.</p> <p>[EX.AXIS] is active for the system with external axes.</p>
<p>[MOTION TYPE]</p> 	<p>Selects the interpolation type for playback operation.</p> <p>The selected interpolation type is shown in the status display area on the screen.</p> <ul style="list-style-type: none"> Each time this key is pressed, the interpolation type changes in the following order: "MOVJ" → "MOVL" → "MOVC" → "MOVS" <p>[SHIFT] + [MOTION TYPE] The interpolation mode changes in the following order: "STANDARD" → "EXTERNAL REFERENCE POINT"* → "CONVEYOR"*</p> <p>Interpolation type can be changed in any mode.</p> <p>*: These modes are purchased options.</p>
<p>[TEST START]</p> 	<p>Moves the manipulator through taught steps in a continuous motion when [TEST START] and [INTERLOCK] are simultaneously pressed.</p> <p>The manipulator can be moved to check the path of taught steps. Operation stops immediately when this key is released.</p> <ul style="list-style-type: none"> The manipulator operates according to the currently selected operation cycle: "AUTO," "1CYCLE," or "STEP." The manipulator operates at the taught speed. However, if the taught speed exceeds the maximum teaching speed, the operation proceeds at the maximum teaching speed.

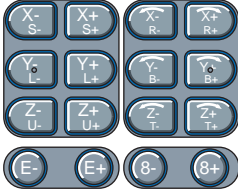
<p>[FWD]</p> 	<p>Moves the manipulator through the taught steps while this key is pressed.</p> <ul style="list-style-type: none"> • Only move instructions are executed (one instruction at a time, no welding instructions). <p>[INTERLOCK] + [FWD] All instructions are executed.</p> <p>[REFP] + [FWD] Moves to the reference point of the cursor line. See <i>chapter 3.3.1.3 "Moving to Reference Point" at page 3-26</i>.</p> <p>The manipulator operates at the selected manual speed. Make sure that the selected manual speed is the desired one before starting operation.</p>
<p>[BWD]</p> 	<p>Moves the manipulator through the taught steps in the reverse direction while this key is pressed.</p> <ul style="list-style-type: none"> • Only move instructions are executed (no weld commands). <p>The manipulator operates at the selected manual speed. Make sure that the selected manual speed is the desired one before starting operation.</p>
<p>[DELETE]</p> 	<p>Deletes the registered instruction.</p> <ul style="list-style-type: none"> • Deletion completes when [ENTER] is pressed while this key lamp is lit.
<p>[INSERT]</p> 	<p>Inserts a new instruction.</p> <ul style="list-style-type: none"> • Insertion completes when [ENTER] is pressed while this key lamp is lit.
<p>[MODIFY]</p> 	<p>Modifies the taught position data or instruction.</p> <ul style="list-style-type: none"> • Modification completes when [ENTER] is pressed while this key lamp is lit.
<p>[ENTER]</p> 	<p>Registers instructions, data, current position of the manipulator, etc.</p> <ul style="list-style-type: none"> • When [ENTER] is pressed, the instruction or data displayed in the input buffer line moves to the cursor position to complete a registration, insertion, or modification.

<p>MANUAL SPEED keys</p> 	<p>Sets the speed for manual operation. This speed is also valid for operations with [FWD] and [BWD].</p> <ul style="list-style-type: none"> • There are four speed levels (slow, medium, fast, and inching). The speed changes as described below. The selected speed is displayed on the status area. <p>Each time [FAST] is pressed, manual speed changes in the following order: "INCH" → "SLOW" → "MED" → "FST".</p> <p>Each time [SLOW] is pressed, manual speed changes in the following order: "FST" → "MED" → "SLOW" → "INCH"</p>
<p>[HIGH SPEED]</p> 	<p>Makes the manipulator move at high speed while this button and one of the axis keys are pressed simultaneously during manual operation. No need to change the setting of speed.</p> <ul style="list-style-type: none"> • The speed for [HIGH SPEED] is specified in advance.
<p>Axis Key</p> 	<p>Moves specified axes on manipulator.</p> <ul style="list-style-type: none"> • The manipulator axes only move while the key is pressed. • Multiple axes can be operated simultaneously by pressing two or more keys at the same time. <p>The manipulator operates in the selected coordinate system at the selected manual speed. Make sure that the selected coordinate system and the manual speed are the desired ones before starting the axis operation.</p>
<p>Numeric Key</p> 	<p>Enters the number or symbol when the ">" prompt appears on the input line.</p> <ul style="list-style-type: none"> • "." is the decimal point. "-" is a minus sign or hyphen. <p>The Numeric keys are also used as function keys. Refer to the explanation of each function for details.</p>

1.2.4 Programming Pendant Display

The programming pendant display is a 5.7 inch color display. Alphanumeric characters can be used.

1.2.4.1 Five Display Areas

The general-purpose display area, menu area, human interface display area, and main menu area among the following five areas can be moved by pressing [AREA], or can be selected by directly touching the screen.

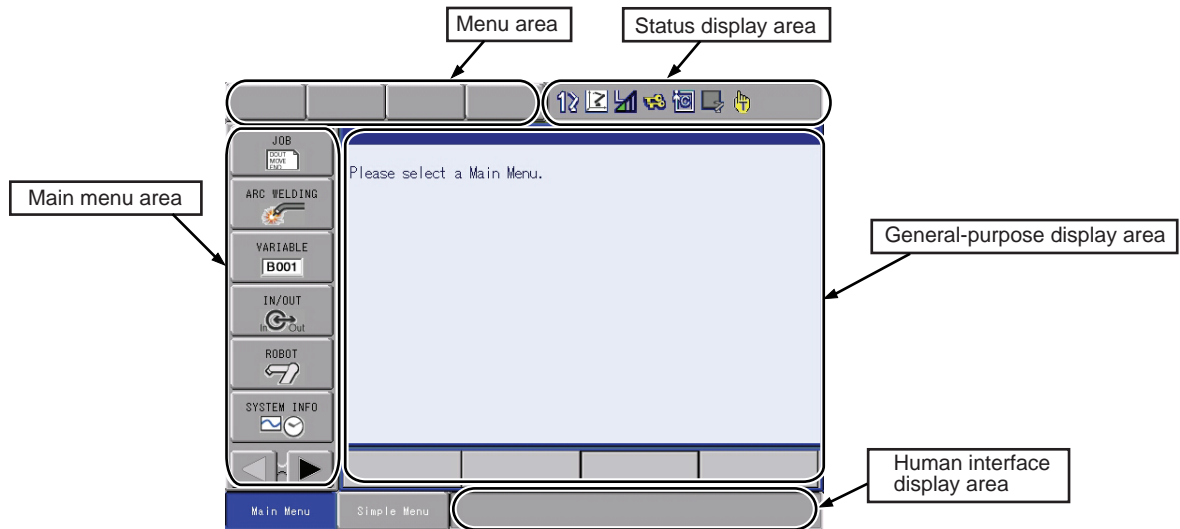

Each window displayed during operations is provided with its name on the upper left of the general-purpose display area.

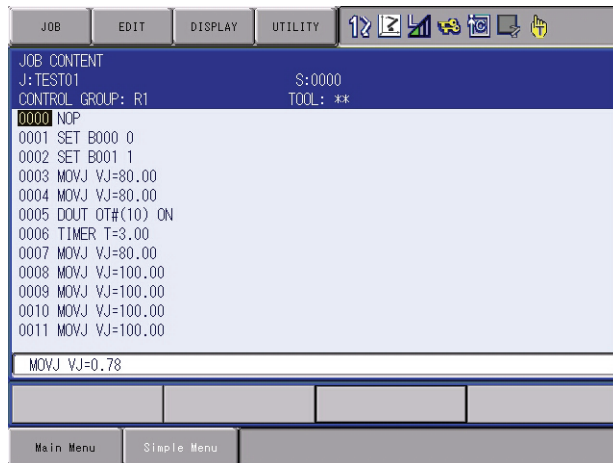

1.2.4.2 General-purpose Display Area

On the general-purpose display area, various settings and contents such as jobs and characteristics files can be displayed and edited.

The operation buttons are also displayed at the bottom of the window according to the window contents.

- To move the cursor to the operation button, press [AREA] + DOWN cursor key.
- To move the cursor to the general-purpose display area, press [AREA] + UP cursor key or press [CANCEL].
- To move the cursor between the operation buttons, use the RIGHT or LEFT cursor key.
- To execute the operation button, move the cursor to the button and press [SELECT].

- | | |
|----------|--|
| EXECUTE | : Continues operation with the displayed contents. |
| CANCEL | : Cancels the displayed contents and returns to the previous window. |
| COMPLETE | : Completes the setting operation displayed on the general-purpose display area. |
| STOP | : Stops operation when loading, saving, or verifying with an external memory device. |
| RELEASE | : Releases the overrun and shock sensor function. |
| RESET | : Resets an alarm. (Cannot reset major alarms.) |
| PAGE | : Jumps to the appropriate page if the page can be switched. |
- When the page can be switched by specifying the page number, the following input box appears when "DIRECT PAGE" is selected. Directly type the desired page number and press [ENTER].

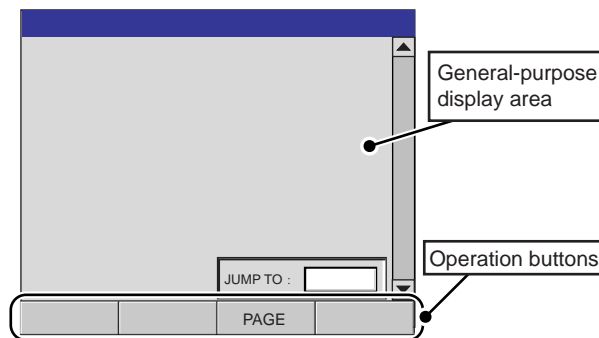

- When the page can be switched by selecting an item, the following selection list appears when "DIRECT PAGE" is selected. Select a desired item using the UP and DOWN cursor key and press [ENTER].

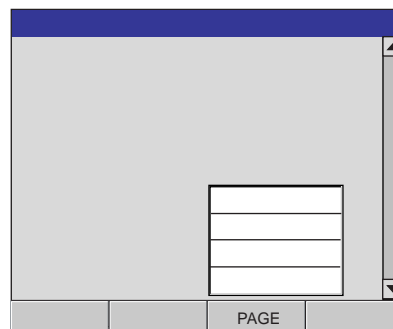

1.2.4.3 Main Menu Area

Each menu and submenu are displayed in the main menu area. Press [MAIN MENU] or touch {Main Menu} on the left bottom of the window to display the main menu.

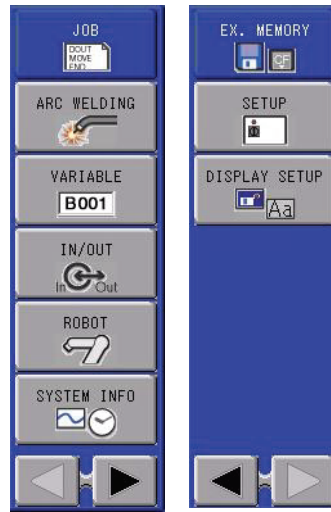

1.2.4.4 Status Display Area

The Status Display area shows controller status. The displayed information will vary depending on the controller mode (Play/Teach).

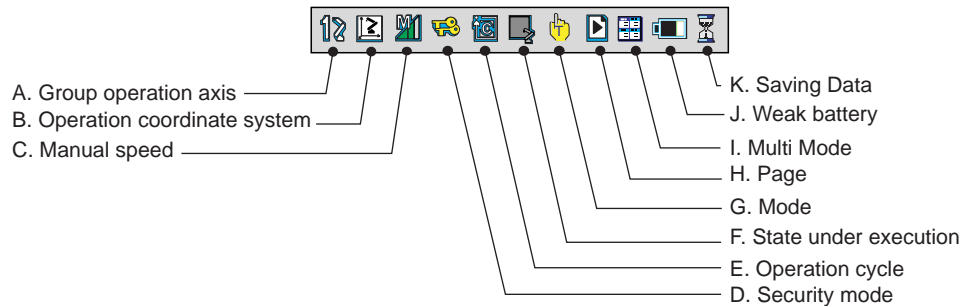

A. Control Group

Displays the active control group for systems equipped with station axes or several robot axes.

to : Robot Axes

to : Base Axes

to : Station Axes

B. Operation Coordinate System

Displays the selected coordinate system. Switched by pressing [COORD].

 : Joint Coordinates

 : Cartesian Coordinates

 : Cylindrical Coordinates

 : Tool Coordinates

 : User Coordinates

C. Manual Speed

Displays the selected speed. For details, refer to *chapter 2.2.0.5 "Select Manual Speed" at page 2-4.*

 : Inching

 : Low Speed

 : Medium Speed

 : High Speed

D. Security Mode

 : Operation Mode

 : Edit Mode

 : Management Mode

E. Operation Cycle

Displays the present operation cycle.

 : Step

 : Cycle

 : Continuous

F. State Under Execution

Displays the present system status (STOP, HOLD, ESTOP, ALARM, or RUN).

 : Stop Status

 : Hold Status

 : Emergency Stop Status

 : Alarm Status

 : Operating Status

G. Mode

 : Teach mode

 : Play mode

H. Page

 : Displayed when the page can be switched.

I. Multi Mode

 : Displayed when the multi window mode is set.

J. Weak Battery of Memory

 : Displayed when the battery of memory is weak.

K. Saving Data

 : Displayed while saving the data.

1.2.4.5 Human Interface Display Area

An error(s) or a message(s) is displayed in the human interface display area.

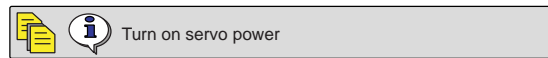

When an error is displayed, operations cannot be performed until the error is canceled. Press [CANCEL] to allow for operations.

When two or more errors occur,  appears in the message display area. Activate the message display area and press [SELECT] to view the list of current errors.

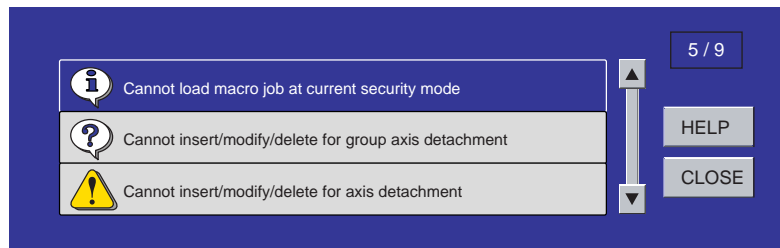

To close the error list, select "CLOSE" or press [CANCEL].

1.2.4.6 Menu Area

The menu area is used to edit a job, manage jobs, and execute various utilities.



1.2.5 Screen Descriptions

- The menu displayed in the programming pendant is denoted with { }.



The above menu items are denoted with {DATA}, {EDIT}, {DISPLAY}, AND {UTILITY}.

- The window can be displayed according to the view desired.

Fig. 1-3: Full Window View

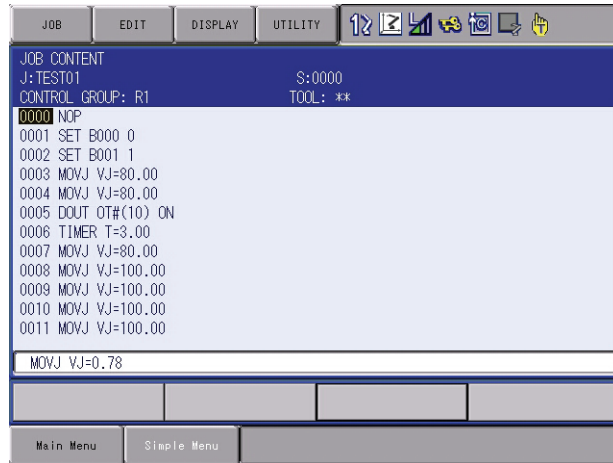

Fig. 1-4: Upper Window View



Fig. 1-5: Middle Window View

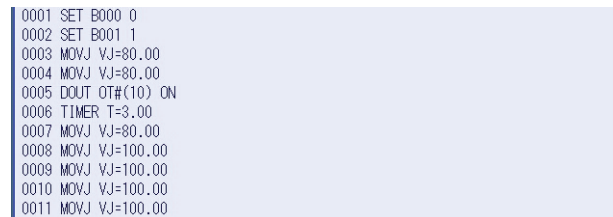
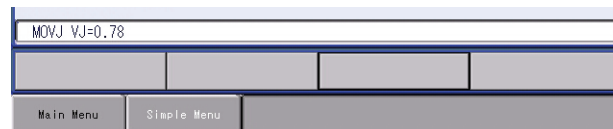

Fig. 1-6: Lower Window View



1.2.6 Character Input Operation







Move the cursor to the data for which characters are to be input, and press [SELECT] to display the software keypad.

1.2.6.1 Character Input

To input characters, the software keypad is shown on the programming pendant display.

There are three types of software keypads: the alphanumeric keypads each for upper-case and lower-case characters and the symbol keypad. To switch between the alphanumeric keypads and the symbol keypad, touch the button tab on the screen or press [PAGE]. To switch the alphanumeric keypads between upper-case and lower-case characters, touch “CapsLock OFF” or “CapsLock ON.”

1.2.6.2 Operation

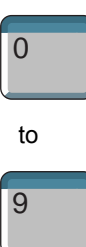
Keypad	Button on the Programming Pendant	Explanation
Cursor		Moves the cursor (focus).
[SELECT]		Selects a character.
[CANCEL]		Clears all the characters being typed. Pressing this second time cancels the software keypad.
[ENTER]		Enters the input characters.
Button Tab		Switches the keypads displayed on the programming pendant.
		Closes the software keypad.
Numeric Keys		Enters numbers.

1.2.6.3 Alphanumeric Input

Number input is performed with the Numeric keys or on the following alphanumeric input window. Numbers include 0 to 9, the decimal point (.), and the minus sign/hyphen (-).

Note however, that the decimal point cannot be used in job names.

Press the page key  to display the alphanumeric input window. Move the cursor to the desired letter and press [SELECT] to enter the letter.

Fig. 1-7: For Numbers and Upper-case Characters

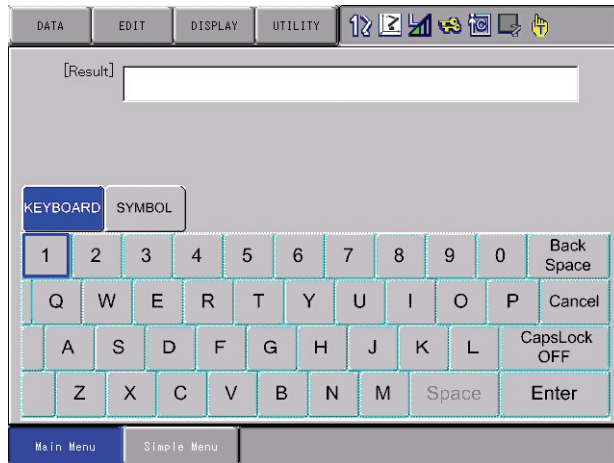
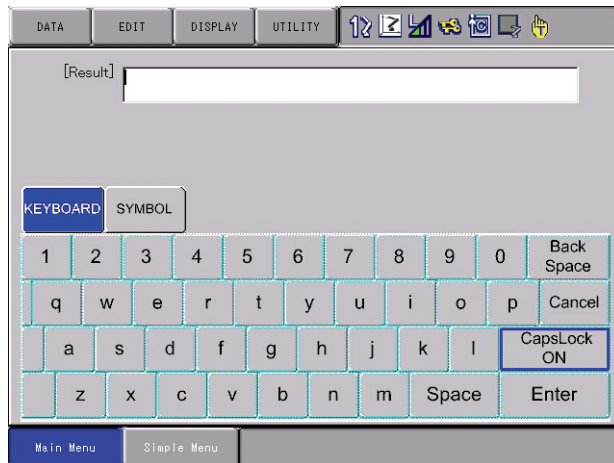

Fig. 1-8: For Numbers and Lower-case Characters



1.2.6.4 Symbol Input

Press the page key  to display the symbol input window.

Move the cursor to the desired symbol and press [SELECT] to enter the symbol.

Note that only some symbols are available for naming jobs.

Fig. 1-9: For Symbols

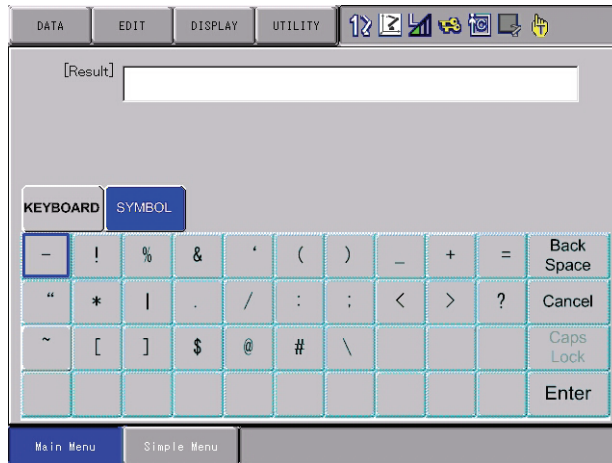

DX100	1	Introduction
	1.3	Mode

1.3 Mode

The following three modes are available for DX100.

- Teach Mode
- Play Mode
- Remote Mode

1.3.1 Teach Mode

In the teach mode, the following can be done.

- Preparation and teaching of a job
- Modification of a registered job
- Setting of various characteristic files and parameters

1.3.2 Play Mode

In the play mode, the following can be done.

- Playback of a taught job
- Setting, modification, or deletion of various condition files

1.3.3 Remote Mode

In the remote mode, the operations such as Servo ON Ready, Start, Cycle Change, Call Master Job can be commanded by external input signals.

The operations by external input signals become enabled in the remote mode, while [START] on the programming pendant becomes disabled.

The data transmission function (optional function) is also available in the remote mode.

The following table shows how each operation is input in each mode.

Operation	Mode	Teach Mode	Play Mode	Remote Mode
Servo ON Ready		PP	PP	External input signal
Start		Invalid	PP	External input signal
Cycle Change		PP	PP	External input signal
Call Master Job		PP	PP	External input signal

Note: "PP" indicates the programming pendant.

1.3.4 Teach Mode Priority

In the teach mode, following operations are disabled:

1. Playback using [START].
2. Playback from external input signals.

	1	Introduction
DX100	1.4	Security Mode

1.4 Security Mode

1.4.1 Types of Security Modes

The following three types of security modes are available for DX100.

Any operation in the edit mode and the management mode requires a password. The password must contain between 4 and 8 letters, numbers, or symbols.

- **Operation Mode**
The operator can monitor the line operation and start and stop the manipulator. Repairs, etc. can be performed if any abnormalities are detected.
- **Edit Mode**
Teaching, robot jog operations, and editing of jobs and various condition files can be performed in addition to the operations enabled in the operation mode.
- **Management Mode**
The operator who performs setup and maintenance for the system can set the machine control parameter, set the time, change the password, etc. in addition to the operations enabled in the edit mode.

DX100	1	Introduction
	1.4	Security Mode

Table 1-1: Menu & Security Mode

Main Menu	Sub Menu	Security Mode	
		DISPLAY	EDIT
JOB	JOB	Operation	Edit
	SELECT JOB	Operation	Operation
	CREATE NEW JOB ¹⁾	Edit	Edit
	MASTER JOB	Operation	Edit
	JOB CAPACITY	Operation	-
	RES. START(JOB) ¹⁾	Edit	Edit
	RES. STATUS ²⁾	Operation	-
	CYCLE	Operation	Operation
VARIABLE	BYTE	Operation	Edit
	INTEGER	Operation	Edit
	DOUBLE	Operation	Edit
	REAL	Operation	Edit
	STRING	Operation	Edit
	POSITION(ROBOT)	Operation	Edit
	POSITION(BASE)	Operation	Edit
	POSITION(ST)	Operation	Edit
	LOCAL VARIABLE	Operation	-
IN/OUT	EXTERNAL INPUT	Operation	-
	EXTERNAL OUTPUT	Operation	-
	UNIVERSAL INPUT	Operation	Edit
	UNIVERSAL OUTPUT	Operation	Edit
	SPECIFIC INPUT	Operation	-
	SPECIFIC OUTPUT	Operation	-
	RIN	Operation	-
	CPRIN	Operation	-
	REGISTER	Operation	-
	AUXILIARY RELAY	Operation	-
	CONTROL INPUT	Operation	-
	PSEUDO INPUT SIG	Operation	Management
	NETWORK INPUT	Operation	-
	NETWORK OUTPUT	Operation	-
	ANALOG OUTPUT	Operation	-
	SV POWER STATUS	Operation	-
	LADDER PROGRAM	Management	Management
	I/O ALARM	Management	Management
I/O MESSAGE	Management	Management	

DX100	1	Introduction
	1.4	Security Mode

Table 1-1: Menu & Security Mode (Continued)

Main Menu	Sub Menu	Security Mode	
		DISPLAY	EDIT
ROBOT	CURRENT POSITION	Operation	-
	COMMAND POSITION	Operation	-
	SERVO MONITOR	Management	-
	WORK HOME POS	Operation	Edit
	SECOND HOME POS	Operation	Edit
	DROP AMOUNT	Management	Management
	POWER ON/OFF POS	Operation	-
	TOOL	Edit	Edit
	INTERFERENCE	Management	Management
	SHOCK SENS LEVEL	Operation	Management
	USER COORDINATE	Edit	Edit
	HOME POSITION	Management	Management
	MANIPULATOR TYPE	Management	-
	ANALOG MONITOR	Management	Management
	OVERRUN&S-SENSOR ¹⁾	Edit	Edit
	LIMIT RELEASE ¹⁾	Edit	Edit
	ARM CONTROL ¹⁾	Management	Management
SHIFT VALUE	Operation	-	
SYSTEM INFO	VERSION	Operation	-
	MONITORING TIME	Operation	Management
	ALARM HISTORY	Operation	Management
	I/O MSG HISTORY	Operation	Management
	SECURITY	Operation	Operation
FD/CF	LOAD	Edit	-
	SAVE	Operation	-
	VERIFY	Operation	-
	DELETE	Operation	-
	DEVICE	Operation	Operation
	FOLDER	Edit	Edit
	FORMAT ¹⁾	Operation	Operation
PARAMETER	S1CxG	Management	Management
	S2C	Management	Management
	S3C	Management	Management
	S4C	Management	Management
	A1P	Management	Management
	A2P	Management	Management
	A3P	Management	Management
	A4P	Management	Management
	RS	Management	Management
	S1E	Management	Management
	S2E	Management	Management
	S3E	Management	Management
	S4E	Management	Management

DX100	1	Introduction
	1.4	Security Mode

Table 1-1: Menu & Security Mode (Continued)

Main Menu	Sub Menu	Security Mode	
		DISPLAY	EDIT
SETUP	TEACHING COND	Edit	Edit
	OPERATE COND	Management	Management
	DATE/TIME	Management	Management
	GRP COMBINATION ²⁾	Management	Management
	RESERVE JOB NAME	Edit	Edit
	USER ID	Edit	Edit
	SET SPEED	Management	Management
	KEY ALLOCATION	Management	Management
	RES. START(CNCT)	Management	Management
	AUTO BACKUP SET	Management	Management
	WRONG DATA LOG	Operation	Management
ARC WELDING	ARC START COND.	Operation	Edit
	ARC END COND.	Operation	Edit
	ARC AUX COND.	Operation	Edit
	POWER SOURCE COND.	Operation	Edit
	ARC WELD DIAG.	Operation	Edit
	WEAVING	Operation	Edit
	ARC MONITOR	Operation	-
ARC MONITOR (SAMPLING)	Operation	-	
HANDLING	HANDLING DIAG.	Operation	Edit
SPOT WELDING	WELD DIAGNOSIS	Operation	Edit
	I/O ALLOCATION	Management	Management
	GUN CONDITION	Management	Management
	CLEARANCE SETTING	Operation	Edit
	SPOT POWER SOURCE COND.	Management	Management
SPOT WELDING (MOTOR GUN)	WELD DIAGNOSIS	Operation	Edit
	GUN PRESSURE	Edit	Edit
	PRESSURE	Edit	Edit
	I/O ALLOCATION	Management	Management
	GUN CONDITION	Management	Management
	CLEARANCE SETTING	Operation	Edit
	SPOT POWER SOURCE COND.	Management	Management
TIP INSTALLATION	Operation	Management	
GENERAL	WEAVING	Operation	Edit
	GENERAL DIAGNOSIS	Operation	Edit
ALL COMMON APPLICATION	I/O-VARIABLE CUSTOMIZE	Operation	Operation

1 Displayed in the teach mode only.

2 Displayed in the play mode only.

1.4.2 Changing Security Modes

The security mode can be changed only when the main menu is displayed.

1. Select {SYSTEM INFO} under the main menu.
 - The sub menu appears.

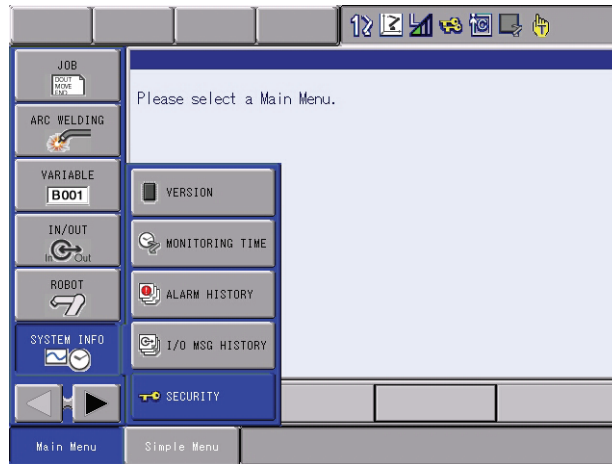

2. Select {SECURITY}.
 - The security of the main menu is shown.

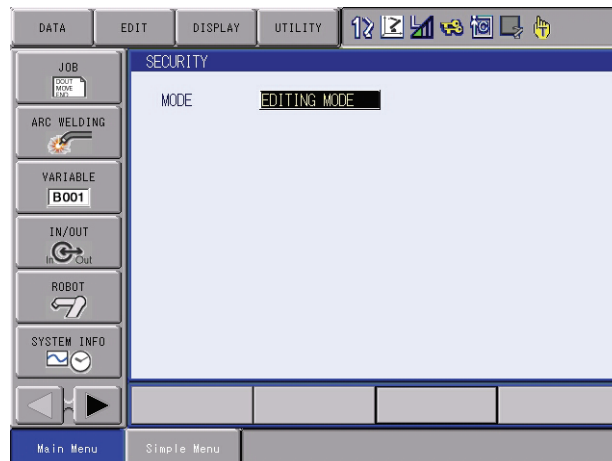

- The security mode can be selected from operation mode, edit mode, or management mode.

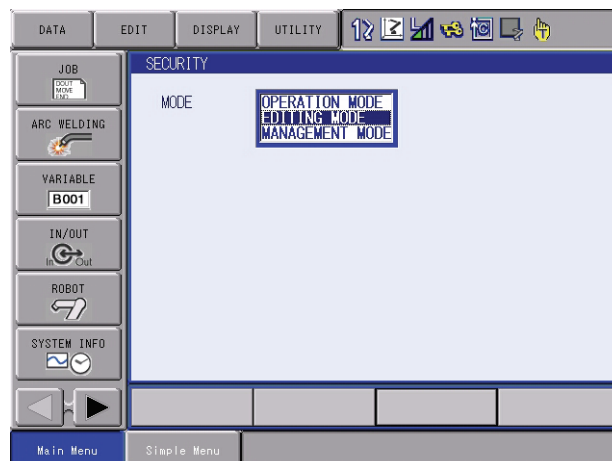

3. Select the desired security mode.
 - When the selected security mode is higher than the currently set mode, the user ID input status window appears.
4. Input the user ID as required.
 - At the factory, the user ID number is preset as follows:
Edit Mode: [00000000]
Management Mode: [99999999]
5. Press [ENTER].
 - The selected security mode's input ID is checked. If the correct user ID is input, the security mode is changed.

2 Manipulator Coordinate Systems and Operations

2.1 Control Groups and Coordinate Systems

2.1.1 Control Group

For the DX100, a group of axes to be controlled at a time is called “Control Group”, and the group is classified into three units: “ROBOT” as a manipulator itself, “BASE” that moves the manipulator in parallel, and “STATION” as jigs or tools other than “ROBOT” and “BASE”. BASE and STATION are also called external axes.

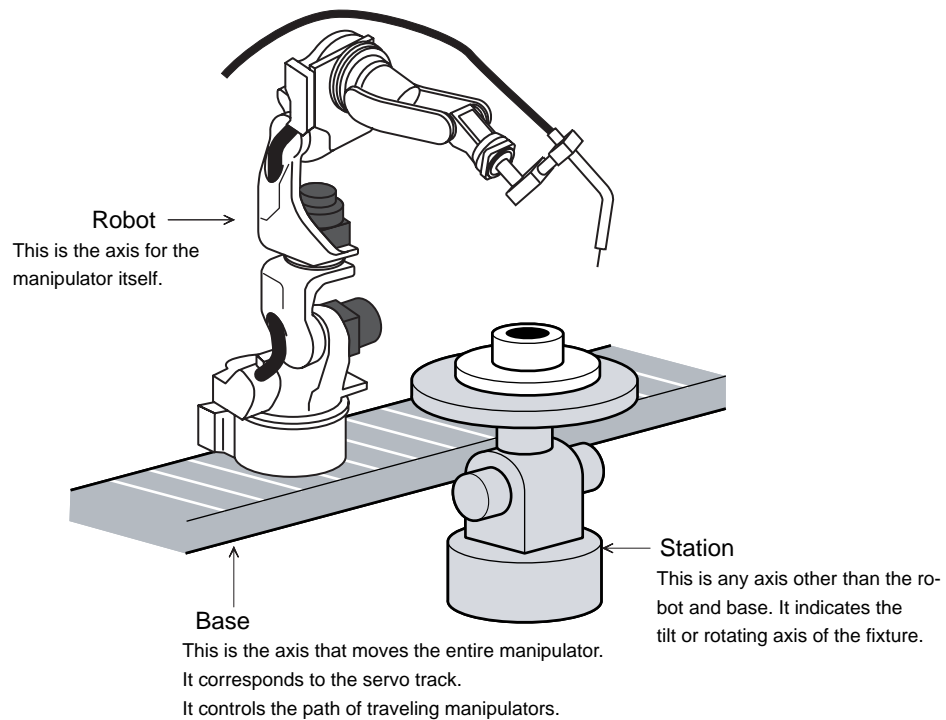

2.1.2 Types of Coordinate Systems

The following coordinate systems can be used to operate the manipulator:

- **Joint Coordinates**
Each axis of the manipulator moves independently.
- **Cartesian Coordinates**
The tool tip of the manipulator moves parallel to any of the X-, Y-, and Z-axes.
- **Cylindrical Coordinates**
The θ axis moves around the S-axis. The R-axis moves parallel to the L-axis arm. For vertical motion, the tool tip of the manipulator moves parallel to the Z-axis.
- **Tool Coordinates**
The effective direction of the tool mounted in the wrist flange of the manipulator is defined as the Z-axis. This axis controls the coordinates of the end point of the tool.
- **User Coordinates**
The XYZ-cartesian coordinates are defined at any point and angle. The tool tip of the manipulator moves parallel to the axes of them.

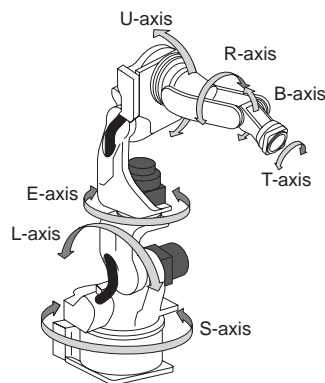

Joint Coordinates

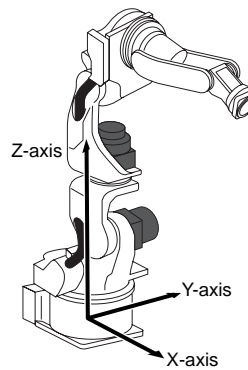

Cartesian Coordinates

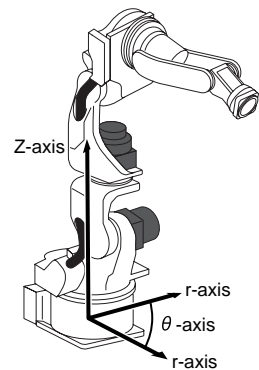

Cylindrical Coordinates

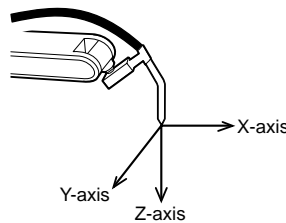

Tool Coordinates

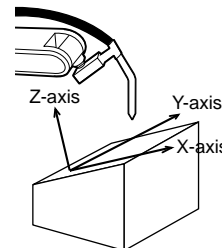

User Coordinates

DX100	2	Manipulator Coordinate Systems and Operations
	2.2	General Operations

2.2 General Operations

2.2.0.1 Check Safety

Before any operation of the DX100, read Section 1 “Safety” of “DX100 INSTRUCTIONS” again and keep safe around the robot system or peripherals.

2.2.0.2 Select Teach Mode

Set the mode switch on the programming pendant to “teach”.

2.2.0.3 Select Control Group

If the DX100 has several Control Groups or Coordinate Control Systems (optional function), select control group first.

If two or more ROBOT, BASE, STATION are registered, switch control group by pressing [SHIFT] + [ROBOT] or [SHIFT] + [EX. AXIS].

After selecting a job, the control group registered in the selected job is enabled. The control group registered in the edit job can be switched by pressing [ROBOT] or [EX. AXIS].

Check the selected control group at the status display area on the programming pendant.

2.2.0.4 Select Coordinate System

Select a coordinate system by pressing [COORD] key.

Each time [COORD] key is pressed, the coordinate system switches in the following order:

Joint → Cartesian (Cylindrical) → Tool → User.

Check the selected coordinate on the status display area on the programming pendant.

2.2.0.5 Select Manual Speed

Select manual speed of operation by pressing [FAST] or [SLOW]. The selected speed is effective not only for axis operation but [FWD] or [BWD] operation.



In operating the manipulator manually by the programming pendant, the maximum speed of center point is limited at 250 mm/s.

- Each time [FAST] is pressed, the speed switches in the order of "INCH" → "SLOW" → "MED" → "FAST".



INCH → SLW → MED → FST

- Each time [SLOW] is pressed, the speed switches in the order of "FAST" → "MED" → "SLOW" → "INCH".



FST → MED → SLW → INCH

Check selected manual speed on the status area of Programming Pendant.

2.2.0.6 Servo ON

Press [SERVO ON READY], then SERVO ON LED starts blinking. Squeeze the Enable switch, then SERVO ON LED starts lighting.

2.2.0.7 Axis Operation

Make sure of safety around the manipulator. Press axis key, then axis moves according to the selected control group, coordinates, and manual speed. See *chapter 2.3 "Coordinate Systems and Axis Operation" at page 2-5*.

2.2.0.8 HIGH SPEED

Press [HIGH SPEED] while pressing an axis key to make the manipulator move faster than the usual speed.









The [HIGH SPEED] key is disabled when "INCH" is selected for the manual speed.

2.3 Coordinate Systems and Axis Operation

2.3.1 Joint Coordinates

When operating in joint coordinates mode, the S, L, U, R, B, and T-axes of the manipulator move independently. The motion of each axis is described in the table below.

Table 2-1: Axis Motion in Joint Coordinates

Axis Name	Axis Operation Key	Motion
Major Axes	S-axis 	Main unit rotates right and left.
	L-axis 	Lower arm moves forward and backward.
	U-axis 	Upper arm moves up and down.
Wrist Axes	R-axis 	Wrist rolls right and left.
	B-axis 	Wrist moves up and down.
	T-axis 	Wrist turns right and left.
	E-axis 	Lower arm turns right and left.





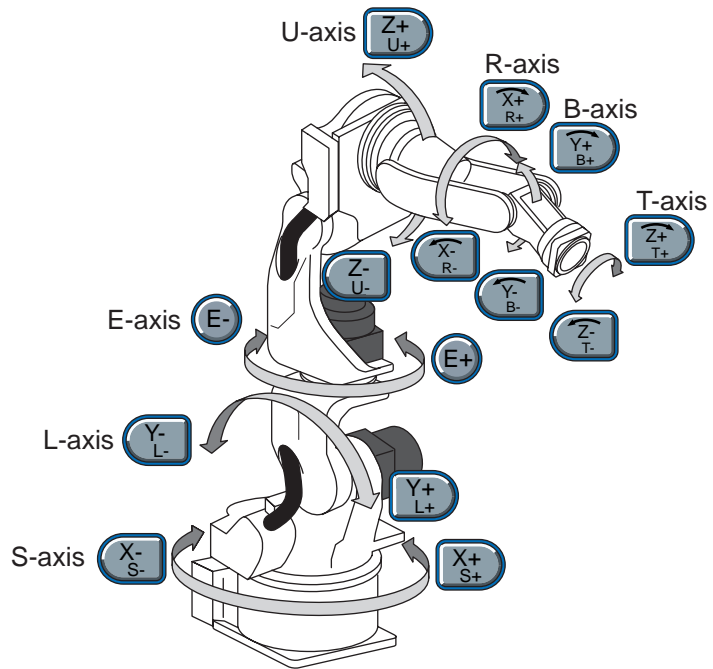

- When two or more axis keys are pressed at the same time, the manipulator will perform a compound movement. However, if two different directional keys for the same axis are pressed at the same time (such as [S-] + [S+]), none of the axes operate.

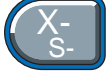
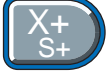

2.3.2 Cartesian Coordinates

In the cartesian coordinates, the manipulator moves parallel to the X-, Y-, or Z-axes. The motion of each axis is described in the table below.

Table 2-2: Axis Motion in Cartesian Coordinates

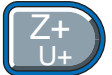
Axis Name	Axis Operation Key	Motion
Basic Axes	X-axis  	Moves parallel to X-axis.
	Y-axis  	Moves parallel to Y-axis.
	Z-axis  	Moves parallel to Z-axis.
Wrist Axes	Motion about TCP is executed. See <i>chapter 2.3.7 "Control Point Operation"</i> at page 2-15.	



- When two or more axis keys are pressed at the same time, the manipulator will perform compound movement. However, if two different directional keys for the same axis are pressed at the same time (such as [X-] + [X+]), none of the axes operate.

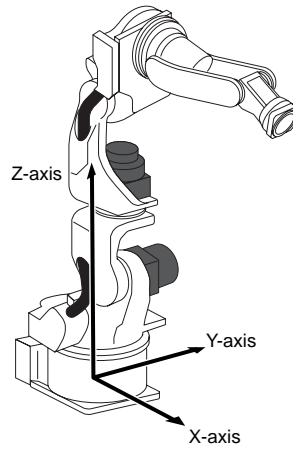
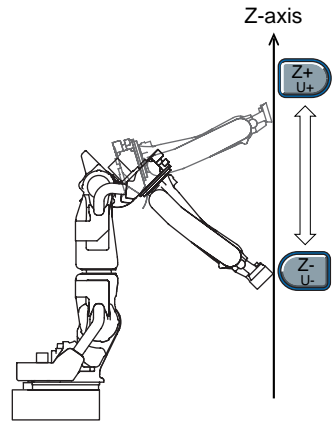
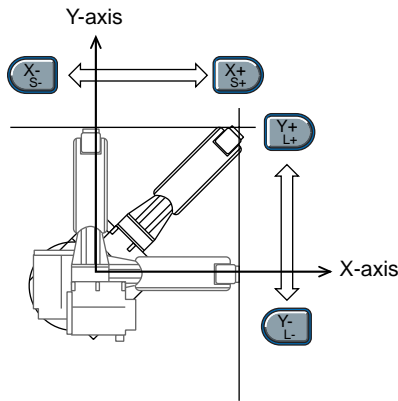







Fig. 2-1: Moves parallel to X- or Y-axis Fig. 2-2: Moves parallel to Z-axis



2.3.3 Cylindrical Coordinates

In the cylindrical coordinates, the manipulator moves as follows. The motion of each axis is described in the table below.

Table 2-3: Axis Motion in Cylindrical Coordinates

Axis Name		Axis Operation Key	Motion
Basic Axes	θ -axis	 	Main unit rolls around S-axis.
	r-axis	 	Moves perpendicular to Z-axis.
	Z-axis	 	Moves parallel to Z-axis.
Wrist Axes		Motion about TCP is executed. See <i>chapter 2.3.7 "Control Point Operation"</i> at page 2-15.	



- When two or more axis keys are pressed at the same time, the manipulator will perform compound movement. However, if two different directional keys for the same axis are pressed at the same time (such as [Z-] + [Z+]), none of the axes operate.

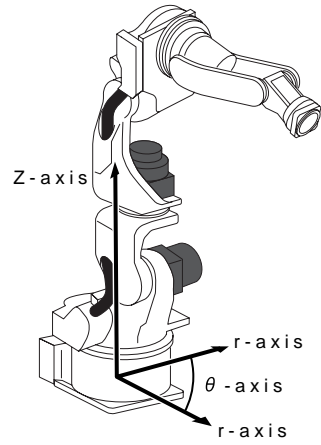

Fig. 2-3: Rolls around q-axis

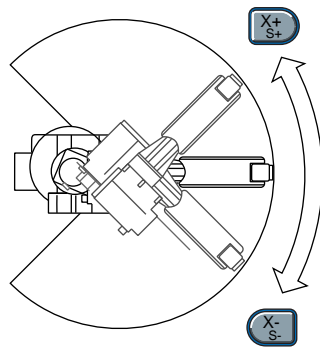
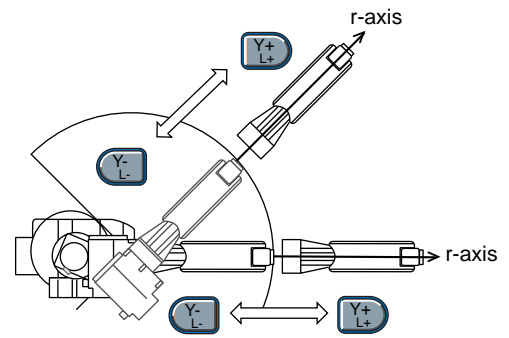







Fig. 2-4: Moves perpendicular to r-axis



2.3.4 Tool Coordinates

In the tool coordinates, the manipulator moves parallel to the X-, Y-, and Z-axes, which are defined at the tip of the tool. The motion of each axis is described in the table below.

Table 2-4: Axis Motion in Tool Coordinates

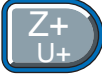
Axis Name		Axis Operation Key	Motion
Basic Axes	X-axis	 	Moves parallel to X-axis.
	Y-axis	 	Moves parallel to Y-axis.
	Z-axis	 	Moves parallel to Z-axis.
Wrist Axes		Motion about TCP is executed. See chapter 2.3.7 "Control Point Operation" at page 2-15.	



- When two or more axis keys are pressed at the same time, the manipulator will perform compound movement. However, if two different directional keys for the same axis are pressed at the same time (such as [X-] + [X+]), none of the axes operate.

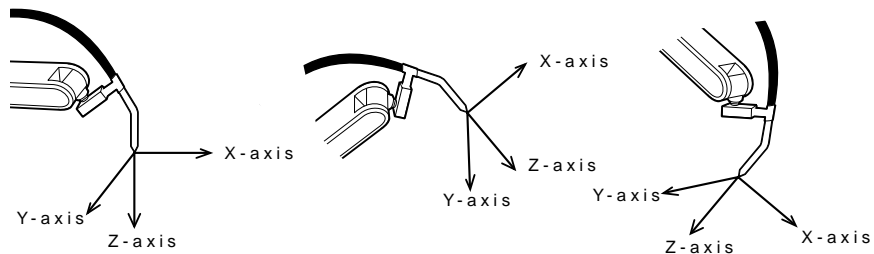

The tool coordinates are defined at the tip of the tool, assuming that the effective direction of the tool mounted on the manipulator wrist flange is the Z-axis. Therefore, the tool coordinates axis direction moves with the wrist.

In the tool coordinates motion, the manipulator can be moved using the effective tool direction as a reference regardless of the manipulator position or orientation. These motions are best suited when the manipulator is required to move parallel while maintaining the tool orientation with the workpieces.

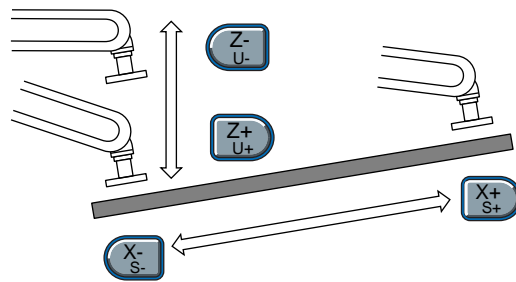

For tool coordinates, the tool file should be registered in advance. For further details, refer to “8.3 Tool Data Setting” of coordinates “DX100 INSTRUCTIONS” (RE-CTO-A215).

2.3.4.1 Selecting Tool

Tool numbers are used to specify a tool when more than one tool is used on the system.

You may select from the registered tool files when you switch tools on the manipulator.



This operation can be performed only when the number of tool is more than one.

To use several tool files with one manipulator, set the following parameter.

S2C431: Tool number switch specifying parameter

1: Can be switched

0: Cannot be switched

1. Press the [COORD] key and select the tool coordinates  .
 - Each time [COORD] key is pressed, the coordinate system switches in the following order:
 Joint → Cartesian (Cylindrical) → Tool → User.
 Check the change on the status display area.
2. Press [SHIFT] + [COORD].
 - The TOOL NO. SELECT window appears.

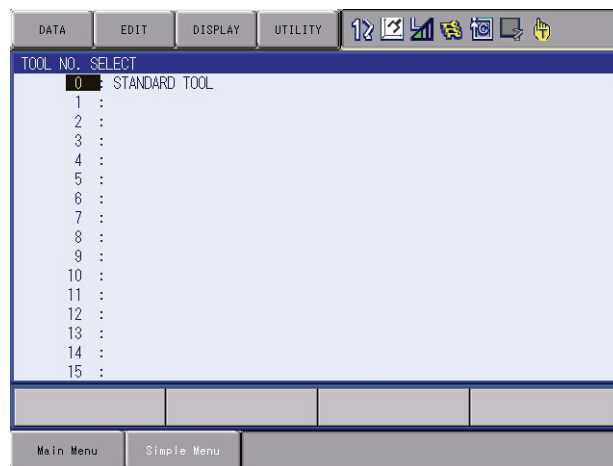





3. Move the cursor to the tool to use.
 - The TOOL NO. SELECT window above shows an example; “TOOL NO. 0 TORCH MT-3501” is selected.
4. Press [SHIFT] + [COORD].
 - The window goes back to the previous window.

2.3.5 User Coordinates

In the user coordinates, the manipulator moves parallel to each axis of the coordinates which are set by the user. Up to 24 coordinate types can be registered. Each coordinate has a user number and is called a user coordinate file.

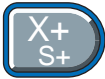
The figure and the table below describe the motion of each axis when the axis key is pressed.

Table 2-5: Axis Motion in User Coordinates

Axis Name	Axis Operation Key	Motion
Basic Axes	X-axis  	Moves parallel to X-axis.
	Y-axis  	Moves parallel to Y-axis.
	Z-axis  	Moves parallel to Z-axis.
Wrist Axes	Motion about TCP is executed. See chapter 2.3.7 "Control Point Operation" at page 2-15.	



- When two or more axis keys are pressed at the same time, the manipulator will perform compound movement. However, if two different directional keys for the same axis are pressed at the same time (such as [X-] + [X+]), none of the axes operate.

Fig. 2-5: Moves parallel to X or Y-axis

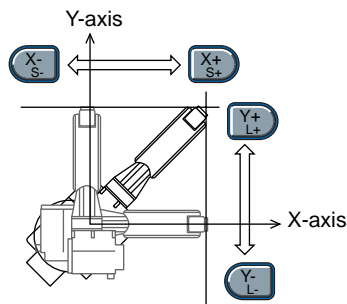
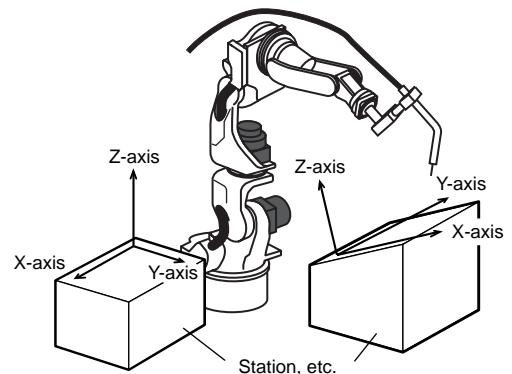
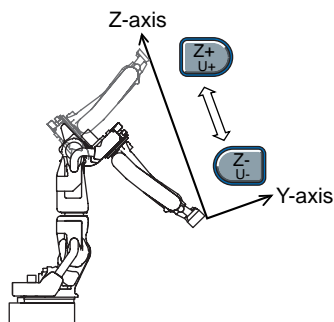



Fig. 2-6: Moves parallel to Z-axis



2.3.5.1 Selecting User Coordinates

Follow these procedures to select the desired coordinate system from among the registered user coordinates.

1. Press [COORD] to select the user coordinates .
 - Each time [COORD] key is pressed, the coordinate system switches in the following order:
Joint → Cartesian (Cylindrical) → Tool → User.
Check the change on the status display area.
2. Press [SHIFT] + [COORD].
 - The USER COORD SELECT window appears.

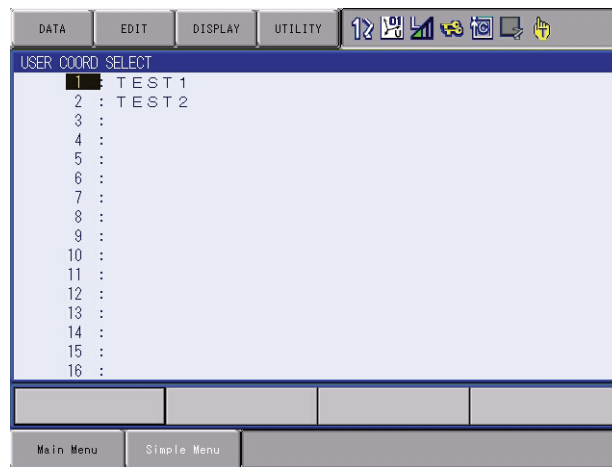

For more information on registration of the user coordinates, refer to “8.8 User Coordinate Setting” of “DX100 INSTRUCTIONS” (RE-CTO-A215).

3. Select the desired user number.

2.3.5.2 Examples of User Coordinate Utilization

The user coordinate settings allow easy teaching in various situations. For example:

- When multiple positioners are used, manual operation can be simplified by setting the user coordinates for each fixture.

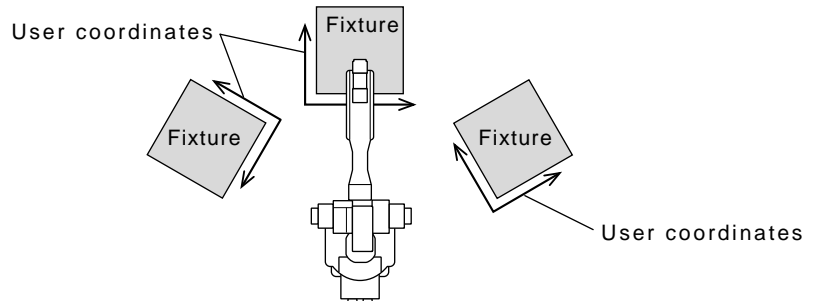

- When performing arranging or stacking operations, the incremental value for shift can be easily programmed by setting user coordinates on a pallet.

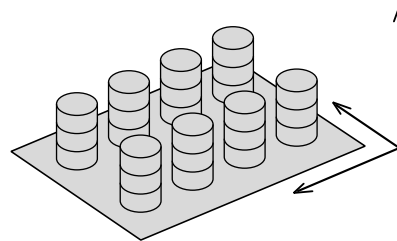

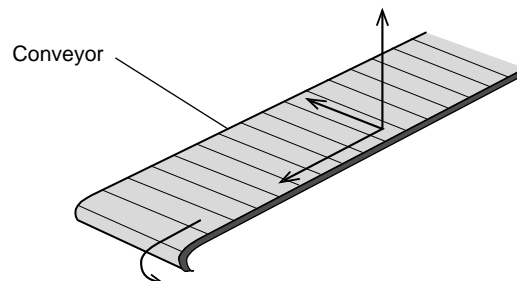

- When performing conveyor tracking operations, the moving direction of the conveyor is specified.



2.3.6 External Axis















The external axis can be operated by selecting "BASE" or "STATION" for the control group. The motion of each axis is described in the table below.

Axis Name	Axis Operation Key	Motion
BASE or STATION	1st axis 	The 1st axis moves.
	2nd axis 	The 2nd axis moves.
	3rd axis 	The 3rd axis moves.

2.3.7 Control Point Operation

Motion about TCP (Tool Center Point) can only change the wrist orientation at a fixed TCP position in all coordinate systems except the joint coordinates. The motion of each axis is described in the table below.

Table 2-6: Axis Motion in Motion about TCP

Axis Name	Axis Operation Key	Motion
Major Axes	 	TCP moves. These movements differ depending on cartesian, cylindrical, tool and user coordinates.
	 	
	 	
Wrist Axes	 	Wrist axes move with the TCP fixed. These movements differ depending on cartesian, cylindrical, tool and user coordinates.
	 	
	 	
E-axis	 	<p>* Available only for the manipulator with seven axes</p> <p>The posture of arm changes while the position and posture of the tool remain fixed. (The Re degree changes.)</p>



- When two or more axis keys are pressed at the same time, the manipulator will perform compound movement. However, if two different directional keys for the same axis are pressed at the same time (such as [X-] + [X+]), none of the axes operate.

Re is an element to indicate the posture of the manipulator with seven axes and does not change by the specified coordinates.

The definition of Re is shown below.

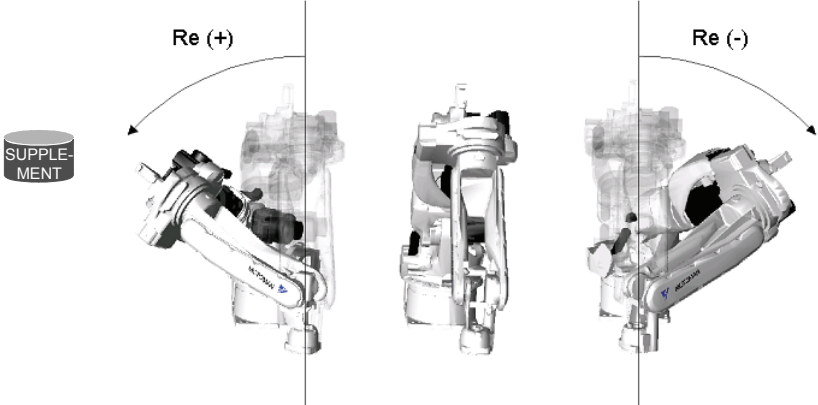

The diagram illustrates the definition of the Re coordinate. It shows three views of a robotic manipulator. The left view is labeled 'Re (+)' and shows the manipulator in a specific posture. The right view is labeled 'Re (-)' and shows the manipulator in a different posture. A central view shows the manipulator in a third posture. A cylinder labeled 'SUPPLEMENT' is positioned to the left of the 'Re (+)' view. The manipulator is shown in a semi-transparent style to reveal internal components.

Fig. 2-7: Torch Welding

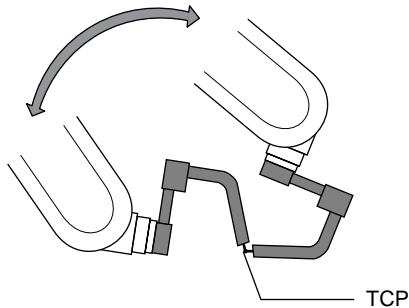
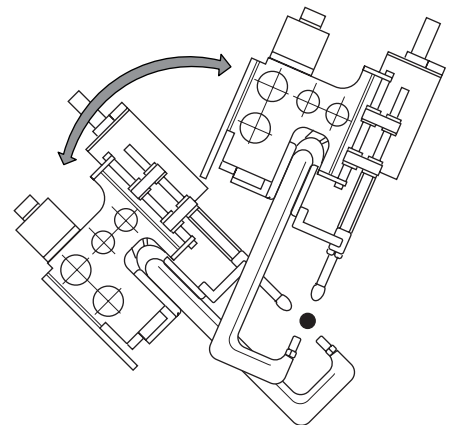
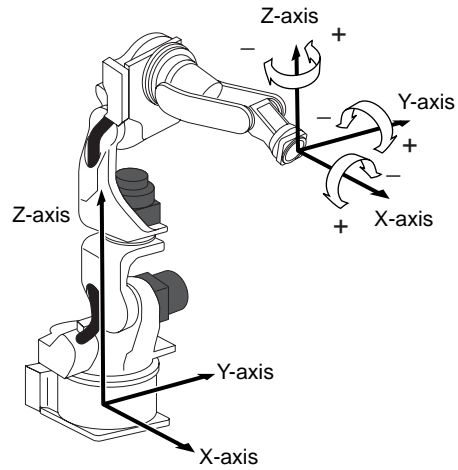

Fig. 2-8: Gun Spot Welding



Turning of each wrist axis differs in each coordinate system.

- In cartesian or cylindrical coordinates, wrist axis rotations are based on the X-, Y-, or Z-axis.



- In tool coordinates, wrist axis rotations are based on X-, Y-, or Z-axis of the tool coordinates.

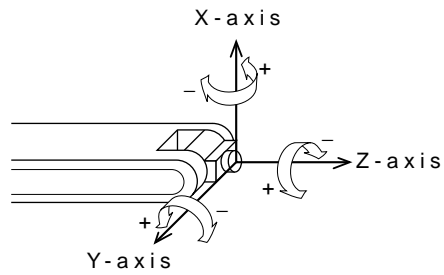

- In user coordinates, wrist axis rotations are based on X-, Y-, or Z-axis of the user coordinates.

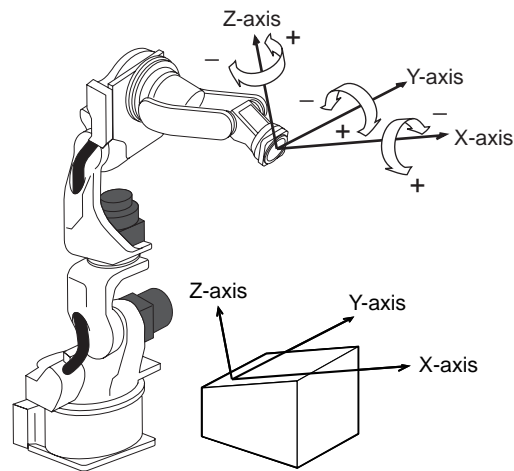

2.3.7.1 Control Point Change

The tool tip position (TCP) is the target point of axis operations and is set as the distance from the flange face. The control point change operation is an axis operation that involves selecting a tool from the list of registered tools (Refer to *chapter 2.3.4.1 "Selecting Tool" at page 2-11*), and then manipulating the axes while changing the TCP. This can be performed with all coordinates except the joint coordinates. The axis operation is the same as that of the motion about TCP.

<Example 1>TCP Change Operation with Multiple Tools

- (1) Set the TCPs for Tool 1 and Tool 2 as P1 and P2, respectively.
- (2) When Tool 1 is selected to perform an axis operation, P1 (Tool 1's TCP) is the target point of the operation. Tool 2 follows Tool 1 and is not controlled by the axis operation.
- (3) On the other hand, When Tool 2 is selected to perform an axis operation, P2 (Tool 2's TCP) is the target point of the axis operation. In this case, Tool 1 just follows Tool 2.

Fig. 2-9: Selection of Tool 1 and axis operations with controlling P1

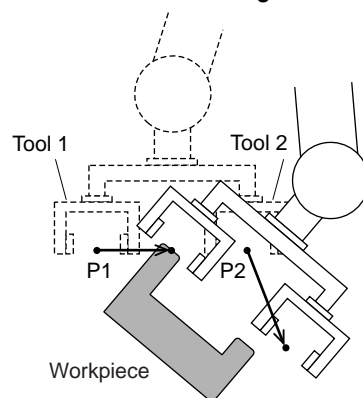
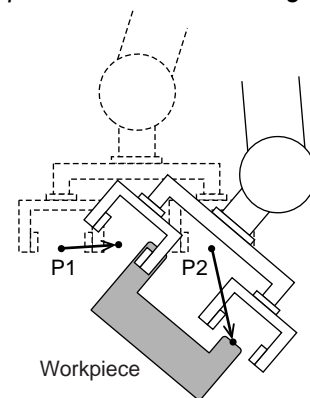

Fig. 2-10: Selection of Tool 2 and axis operations with controlling P2



<Example 2>TCP Change Operation with a Single Tool

- (1) Set the two corners of the workpiece that the tool is holding as TCP P1 and P2 respectively.
- (2) By selecting two TCPs alternately, the workpiece can be moved as shown below:

Fig. 2-11: Motion about TCP with P1 selected

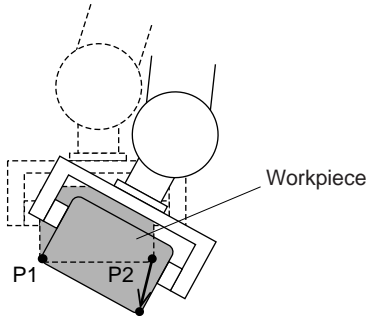
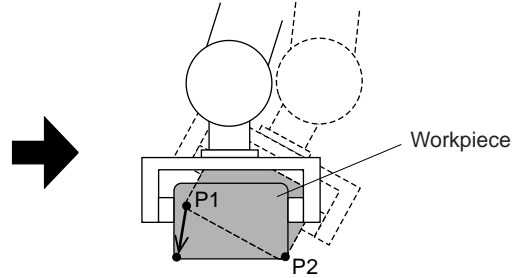

Fig. 2-12: Motion about TCP with P2 selected



For registration of the tool file, refer to "8.3 Tool Data Setting" of "DX100 INSTRUCTIONS" (RE-CTO-A215).

3 Teaching

3.1 Preparation for Teaching

To ensure safety, the following operations should always be performed before teaching:

- Check the emergency stop buttons to be sure they function properly.
- Set the mode switch to “TEACH”.

Then,

- Register a job.

3.1.1 Checking Emergency Stop Buttons

The Servo ON button on the programming pendant should be lit while the power is ON for the servo system. Perform the following operation to ensure that the emergency stop buttons on both the DX100 and the programming pendant are functioning correctly before operating the manipulator.

1. Press E. STOP button.
 - Press the emergency stop button on the DX100 or the programming pendant.
2. Confirm the servo power is turned OFF.
 - The SERVO ON button on the programming pendant lights while servo supply is turned ON.
 - When the emergency stop button is pressed and the servo power is turned OFF, the SERVO ON lamp will turn OFF.
3. Press [SERVO ON READY] of the programming pendant.
 - After confirming correct operation, press [SERVO ON READY]. The servo power will be ready to turn ON.
 - The servo power can be turned ON while the SERVO ON button lamp blinks.

3.1.2 Setting the Teach Lock

For safety purposes, always set the mode switch to “TEACH” before beginning to teach.

While the teach lock is set, the mode of operation is tied to the teach mode and the machines cannot be played back using either [START] or external input.

3.1.3 Registering a Job

Specify the name, comments (as required), and control group to register a job.

3.1.3.1 Registering Job Names

Job names can use up to 32 alphanumeric and symbol characters. These different types of characters can coexist within the same job name.

The following rules apply to the designation of job names:

- A maximum of 32 characters can be used for a job name.
- If the job name is already used, an input error is caused.

<Example>

001 JOB-1 WORK-A

3.1.3.2 Registering Jobs

1. Select {JOB} under the main menu.
– The sub-menu appears.

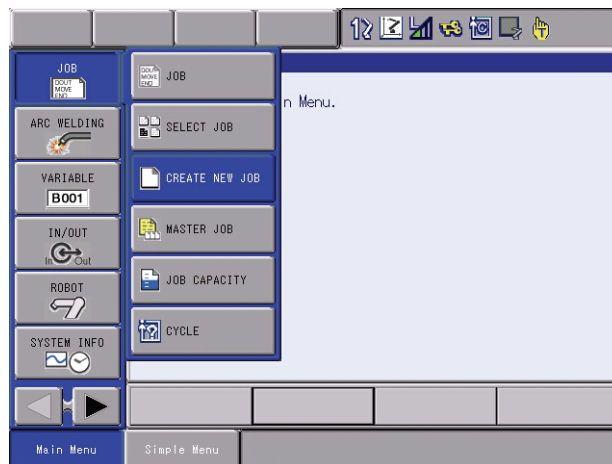

2. Select {CREATE NEW JOB}.
– The NEW JOB CREATE window appears.

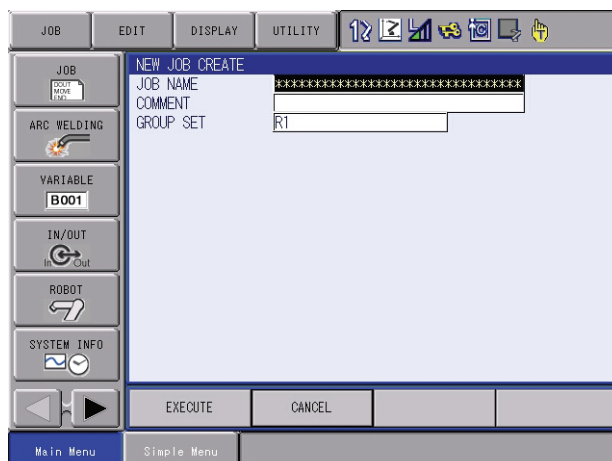

3. Input job name.
 - Move the cursor to JOB NAME, and press [SELECT]. Input job names using the character input operation. For information on character input operation, refer to *chapter 1.2.6 "Character Input Operation" at page 1-18.*
4. Press [ENTER].

3.1.3.3 Registering Comments

Register a comment using up to 32 alphanumeric and symbol characters as required.

1. Enter a comment.
 - In the NEW JOB CREATE window, move the cursor to the comment and press [SELECT]. For information on character input operation, refer to *chapter 1.2.6 "Character Input Operation" at page 1-18.*
2. Press [ENTER].

3.1.3.4 Registering Control Groups

Select the control group that has been registered in advance. If external axes (BASE or STATION) or multiple robot systems are not used, the registration of control groups is not required.

3.1.3.5 Switching to the Teaching Window

After the name, comments (can be omitted), and the control groups have been registered, switch the window to the teaching window as follows.

1. In the NEW JOB CREATE window, press [ENTER] or select “EXECUTE.”
 - Job name, comments, and control groups are all registered. Then, the JOB CONTENT window appears. NOP and END instructions are automatically registered.

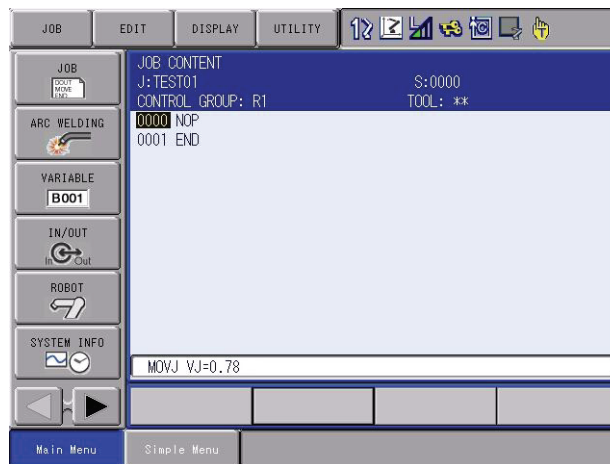

3.2 Teaching Operation

3.2.1 Teaching Window

Teaching is conducted in the JOB CONTENT window. The JOB CONTENT window contains the following items:

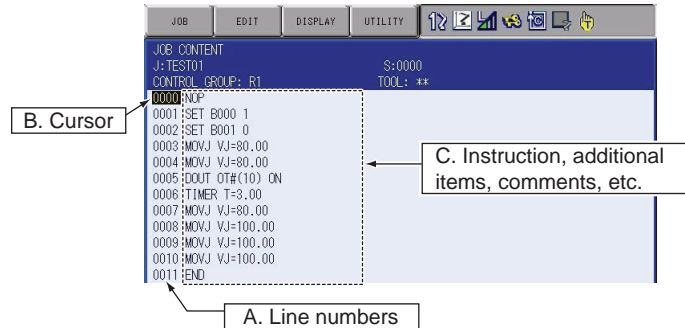

A. Line Numbers

The number of the job line is automatically displayed. Line numbers are automatically updated if lines are inserted or deleted.

B. Cursor

The cursor for manipulator control. For the FWD, BWD, and test operation, the manipulator motion starts from the line this cursor points.

C. Instructions, Additional Items, Comments, Etc.

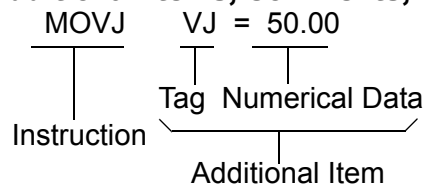

- Instructions** : These are instructions needed to process or perform an operation. In the case of MOVE instructions, the instruction corresponding to the interpolation type is automatically displayed at the time position is taught.
- Additional items** : Speed and time are set depending on the type of instruction. When needed, numerical or character data is added to the condition-setting tags.

3.2.2 Interpolation Type and Play Speed

Interpolation type determines the path along which the manipulator moves between playback steps. Play speed is the rate at which the manipulator moves.

Normally, the position data, interpolation type, and play speed are registered together for a robot axis step. If the interpolation type or play speed settings are omitted during teaching, the data used from the previously taught step is automatically used.

3.2.2.1 Joint Interpolation

The joint interpolation is used when the manipulator does not need to move in a specific path toward the next step position. When the joint interpolation is used for teaching a robot axis, the move instruction is MOVJ. For safety purposes, use the joint interpolation to teach the first step.

When [MOTION TYPE] is pressed, the move instruction on the input buffer line changes.

<Play Speed Setting Window>

- Speeds are indicated as percentages of the maximum rate.
 - Setting "0:Speed Omit" sets the same speed as the previous determination.
1. Move the cursor to the play speed.
 2. Set the play speed by pressing [SHIFT] + the cursor key.
 - The joint speed value increases or decreases.



Fast	100.00
↑	50.00
	25.00
	12.50
	6.25
	3.12
↓	1.56
Slow	0.78 (%)

3.2.2.2 Linear Interpolation

The manipulator moves in a linear path from one taught step to the next. When the linear interpolation is used to teach a robot axis, the move instruction is MOVL. Linear interpolation is used for work such as welding. The manipulator moves automatically changing the wrist position as shown in the figure below.

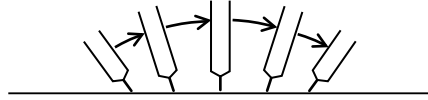

<Play Speed Setting Window (same for circular and spline interpolation)>

- There are two types of displays, and they can be switched depending on the application.
1. Move the cursor to the play speed.
 2. Set the play speed by pressing [SHIFT] + the cursor key.
 - The play speed value increases or decreases.

MOVL V=868

Fast	1500.0
↑	750.0
	375.0
	187.0
	93.0
↓	46.0
	23.0
Slow	11 (mm/s)

Fast	9000
↑	4500
	2250
	1122
	558
↓	276
	138
Slow	66 (cm/min)

3.2.2.3 Circular Interpolation

The manipulator moves in an arc that passes through three points. When circular interpolation is used for teaching a robot axis, the move instruction is MOVC.

■ **Single Circular Arc**

When a single circular movement is required, teach the circular interpolation for three points, P1 to P3, as shown in the following figure. If joint or linear interpolation is taught at P0, the point before starting the circular operation, the manipulator moves from P0 to P1 in a straight line.

Table 3-1: Interpolation Type for Single Circular Arc

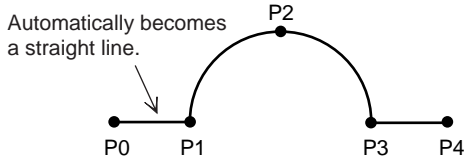

Point	Interpolation Type	Instruction
P0	Joint or Linear	MOVJ MOVL
P1 P2 P3	Circular	MOVC
P4	Joint or Linear	MOVJ MOVL

■ **Continuous Circular Arcs**

As shown below, when two or more successive circular movements with different curvatures are required, the movements must be separated from each other by a joint or linear interpolation step. This step must be inserted between the steps at an identical point. The step at the end point of the preceding circular movement must coincide with the beginning point of the following circular movement.

Table 3-2: Interpolation Type for Continuous Circular Arcs

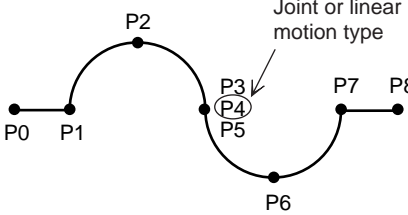

Point	Interpolation Type	Instruction
P0	Joint or Linear	MOVJ MOVL
P1 P2 P3	Circular	MOVC
P4	Joint or Linear	MOVJ MOVL
P5 P6 P7	Circular	MOVC
P8	Joint or Linear	MOVJ MOVL

Alternatively, to continue movements without adding an extra joint or linear interpolation step in between, add “FPT” tag to the step whose curvature is needed to be changed.

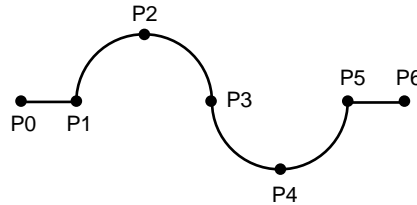

Point	Interpolation Type	Instruction
P0	Joint or Linear	MOVJ MOVL
P1 P2	Circular	MOVC
P3	Circular	MOVC FPT
P4 P5	Circular	MOVC
P6	Joint or Linear	MOVJ MOVL

<Play Speed>

- The play speed set display is identical to that for the linear interpolation.
- The speed taught at P2 is applied from P1 to P2. The speed taught at P3 is applied from P2 to P3.
- If a circular operation is taught at high speed, the actual arc path has a shorter radius than that taught.

3.2.2.4 Spline Interpolation

When performing operations such as welding, cutting, and applying primer, using the spline interpolation makes teaching for workpieces with irregular shapes easier. The path of motion is a parabola passing through three points. When spline interpolation is used for teaching a robot axis, the move instruction is MOVS.

■ Single Spline Curve

When a single spline curve movement is required, teach the spline interpolation for three points, P1 to P3, as shown in the figure below. If joint or linear interpolation is taught at point P0, the point before starting the spline interpolation, the manipulator moves from P0 to P1 in a straight line.

Table 3-3: Interpolation Type for Single Spline Curve

Point	Interpolation Type	Instruction
P0	Joint or Linear	MOVJ MOVL
P1 P2 P3	Spline	MOVS
P4	Joint or Linear	MOVJ MOVL

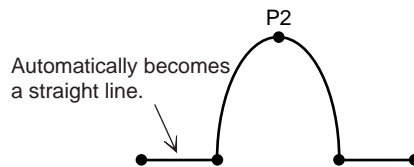

■ **Continuous Spline Curves**

The manipulator moves through a path created by combining parabolic curves. This differs from the circular interpolation in that steps with identical points are not required at the junction between two spline curves.

Table 3-4: Interpolation Type for Continuous Spline Curves

Point	Interpolation Type	Instruction
P0	Joint or Linear	MOVJ MOVL
P1 to P5	Spline	MOVS
P6	Joint or Linear	MOVJ MOVL

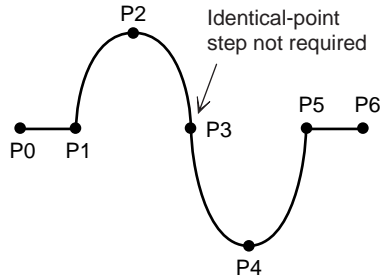

When the parabolas overlap, a composite motion path is created.

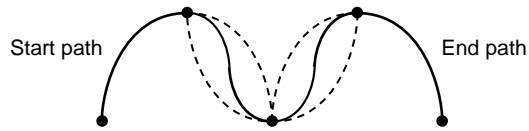

<Play Speed>

- The play speed setting window is identical to that for the linear interpolation.
- As with the circular interpolation, the speed taught at P2 is applied from P1 to P2, and the speed taught at P3 is applied from P2 to P3.



Teach points so that the distances between the three points are roughly equal. If there is any significant difference, an error will occur on playback and the manipulator may operate in an unexpected, dangerous manner. Ensure that the ratio of distances between steps $m:n$ is within the range of 0.25 to 0.75.

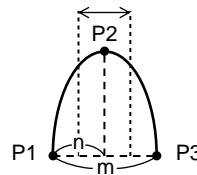

3.2.3 Teaching Steps

3.2.3.1 Registering Move Instructions

Whenever one step is taught, one move instruction is registered. There are two ways to teach a step. Steps can be taught in sequence as shown in the following left figure *fig. 3-1 "Registering Move Instructions"* or they can be done by inserting steps between already registered steps, as shown in the right figure *fig. 3-2 "Inserting Move Instructions"*

This paragraph explains the teaching of *fig. 3-1 "Registering Move Instructions"*, the operations involved in registering new steps.

Fig. 3-1: Registering Move Instructions

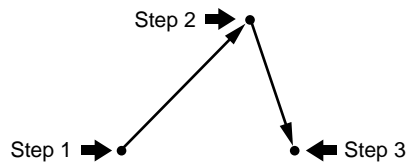
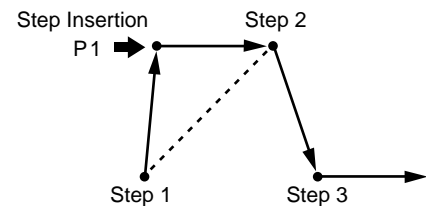

Fig. 3-2: Inserting Move Instructions



Teaching of *fig. 3-2 "Inserting Move Instructions"* is called "Inserting move instruction," to distinguish it from the method shown in *fig. 3-1 "Registering Move Instructions"*. For more details on this operation, see *chapter 3.4.2 "Inserting Move Instructions" at page 3-33*. The basic operations for registration and insertion are the same. The only difference is pressing [INSERT] in the case of insertion. For registration (*fig. 3-1 "Registering Move Instructions"*), the instruction is always registered before the END instruction. Therefore, it is not necessary to press [INSERT]. For insertion (*fig. 3-2 "Inserting Move Instructions"*), [INSERT] must be pressed.

■ Setting the Position Data

1. Select {JOB} under the main menu.
 - The sub-menu appears.

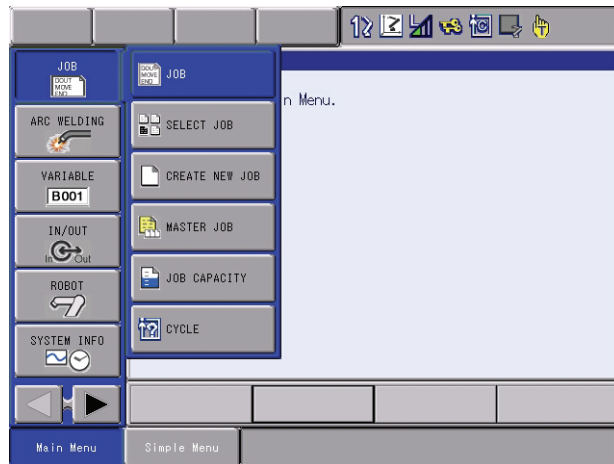

2. Select {JOB}.

- The contents of the currently-selected job is displayed.

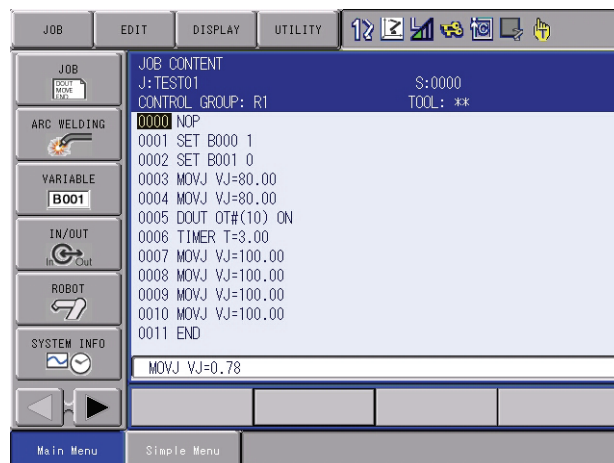

3. Move the cursor on the line immediately before the position where a move instruction to be registered.
4. Grip the Enable switch.
 - Grip the Enable switch to turn the servo power ON.
5. Move the manipulator to the desired position using the axis key.
 - Use the axis operation key to move the manipulator to the desired position.

■ Selecting the Tool Number

1. Press [SHIFT] + [COORD].

- When selecting the “JOINT,” “XYZ/CYLINDRICAL,” or “TOOL” coordinates, press [SHIFT] + [COORD] and the TOOL NO. SELECT window will be shown.

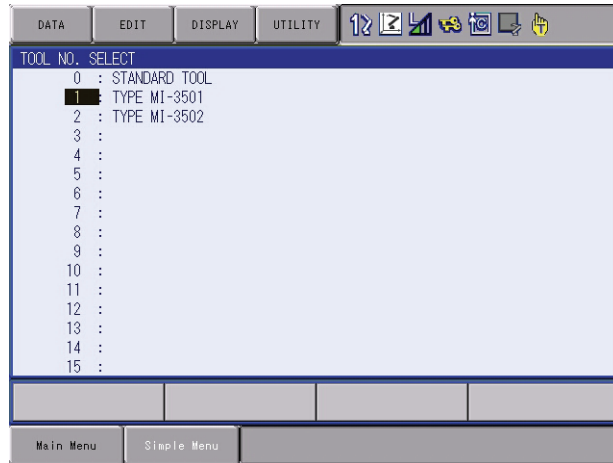

2. Select the desired tool number.

- The contents of the currently-selected job is displayed.

```
0000 NOP
0001 MOVJ VJ=0.78
0002 END
```

3. Press [SHIFT] + [COORD].

- The JOB CONTENT window appears.

Using Multiple Tools with One Manipulator



- When multiple tools are to be used with one manipulator, set parameter S2C431 to 1.
- See *chapter 2.3.4 "Tool Coordinates" at page 2-9* for details on this operation.

■ Setting the Interpolation Type

1. Press [MOTION TYPE].

2. Select the desired interpolation type.

- When [MOTION TYPE] is pressed, MOVJ → MOVL → MOVC → MOVS are displayed in order in the input buffer line.

■ **Setting the Play Speed**

1. Move the cursor to the instruction.

```
0000 NOP
0001 MOVJ VJ=0.78
0002 END
```

2. Press [SELECT].

– The cursor moves to the input buffer line.

```
MOVJ VJ=0.78
```

3. Move the cursor to the play speed to be set.

– The joint speed moves up and down.

4. Press [SHIFT] + the cursor key [↑] or [↓] simultaneously.

```
MOVJ VJ=50.00
```

5. Press [ENTER].

– The MOV instruction is registered.

```
0000 NOP
0001 MOVJ VJ=50.00
0002 END
```

Move instruction is registered.

Follow the above instructions when conducting teaching. (Tool number, interpolation type, or play speed does not need to be set if it is same as the previous step.)



To make the setting so that the play speed tag is not displayed as a default, select {EDIT} from the menu and then select “ENABLE SPEED TAG” to delete “*.”



- The position level can be set at the same time that the move instruction is registered.
- To display the position level tag as a default, select {EDIT} from the menu and then select “ENABLE POS LEVEL TAG.”

Position Level: The position level is the degree of approximation of the manipulator to a taught position.

The position level can be added to move instructions MOVJ (joint interpolation) and MOVL (linear interpolation).

If the position level is not set, the precision depends on the operation speed. Setting an appropriate level moves the manipulator in a path suitable to circumferential conditions and the workpiece.

The relationship between path and accuracy for position levels is as follows.

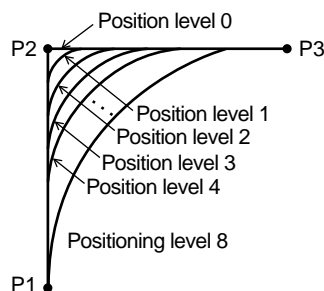

Position Levels	Accuracy
0	Teaching position
1 to 8	Fine Rough

■ **Setting the Position Level**

1. Select move instruction.
 - The DETAIL EDIT window appears.

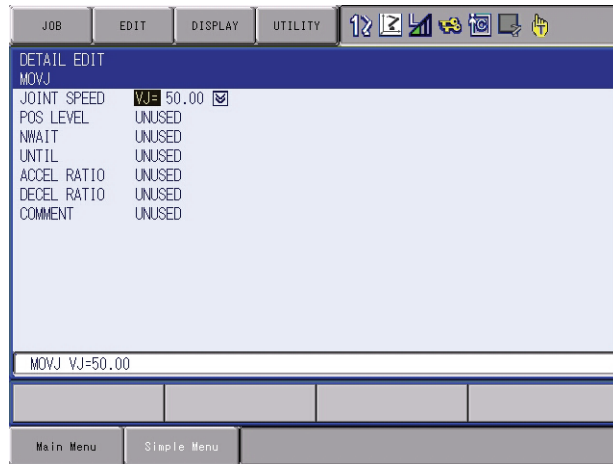

2. Select the position level "UNUSED."
 - The selection dialog box appears.

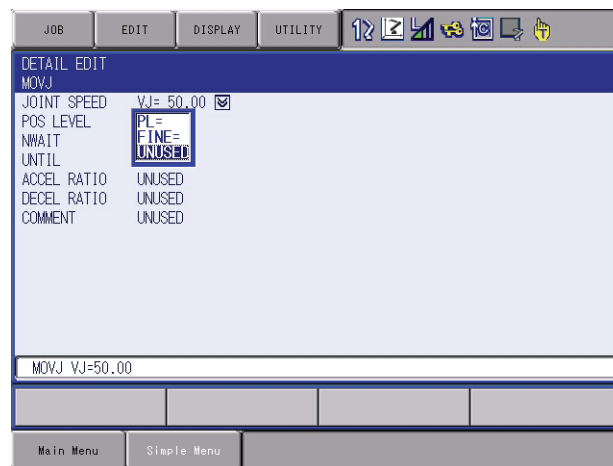

3. Select "PL."
 - The position level is displayed. The position initial value is 1.

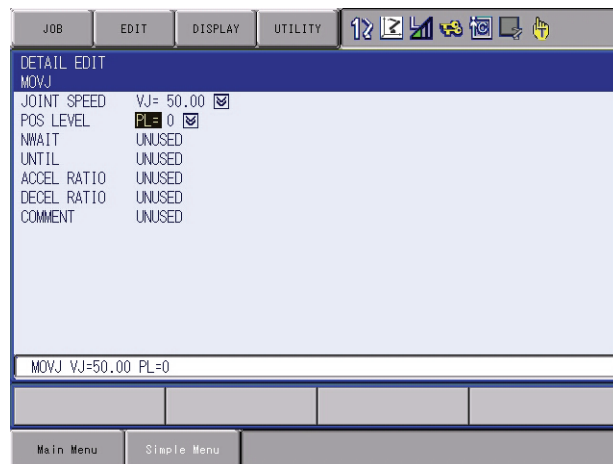

4. Press [ENTER].

- To change the position level, select the level in the input buffer line, type the value using the Numeric keys, and press [ENTER]. The position level's move instruction is registered.

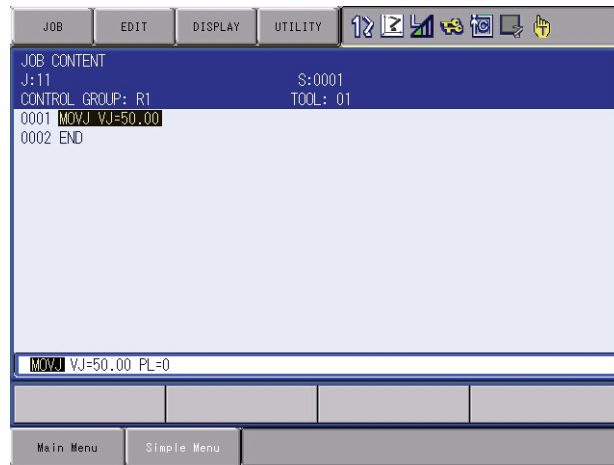

5. Press [ENTER].

For example, to perform the movement steps shown below, set as follows:

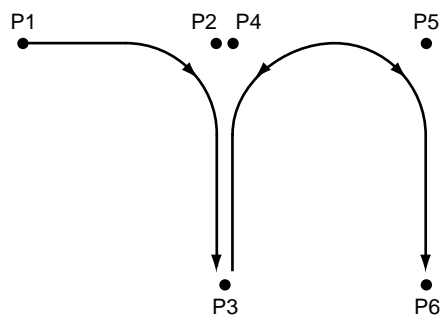

Steps P2, P4, and P5 are simple passing points, and do not require accurate positioning. Adding PL=1 to 8 to the move instructions of these steps moves the manipulator around the inner corners, thereby reducing the cycle time.

If complete positioning is necessary as P3 or P6, add PL=0.

<EXAMPLE>

Passing points P2, P4, and P5:

```
MOVJ V=138 PL=3
```

Positioning point P3 and P6:

```
MOVJ V=138 PL=0
```

3.2.3.2 Registering Reference Point Instructions

Reference point instructions (REFP) set an auxiliary point such as a wall point for weaving. Reference point Nos. 1 to 8 are assigned for each application. Follow these procedures to register reference point instructions.

1. Select {JOB} under the main menu.
2. Select {JOB}.
3. Move the cursor.
 - Move the cursor to the line immediately before the position where the reference point to be registered.

Place immediately before where reference point is to be registered.

```

0003 MOVJ VJ=50.00
0004 CALL JOB:TEST01
0005 MOVJ VJ=80.00
  
```

4. Grip the Enable switch.
 - The servo power is turned ON.
5. Press the axis operation key.
 - Move the manipulator to the position to be registered as the reference point.
6. Press [REFP] or select “REFP” from the inform list.
 - The reference point instruction is displayed in the input buffer line.

```

REFP 1
  
```

7. Change the reference point number in one of the following ways.
 - Move the cursor to the reference point number, and press [SHIFT] + the cursor key to change the reference point number; or

```

REFP 2
  
```

- Press [SELECT] when the cursor is on the reference point number. Then, the data input buffer line appears. Input the number and press [ENTER].

```

Ref -
REFP 1
  
```

8. Press [INSERT].
 - The [INSERT] key lamp lights. When registering before the END instruction, pressing [INSERT] is not needed.
9. Press [ENTER].
 - The REFP instruction is registered.

Reference point is registered.

```

0003 MOVJ VJ=50.00
0004 CALL JOB:TEST01
0005 REFP 1
0006 MOVJ VJ=80.00
  
```



The programming pendant does not have the [REFP] key for the application of spot welding, motor gun, and of material handling, assembling, and cutting.

3.2.3.3 Registering Timer Instructions

The timer instruction stops the manipulator for a specified time. Follow these procedures to register timer instructions.

1. Select {JOB} under the main menu.
2. Select {JOB}.
3. Move the cursor.
 - Move the cursor to one line before the position where the timer instruction is to be registered.

One line before — 0003 MOVJ VJ=50.00
where timer 0004 MOVL V=138
instruction is
to be registered.

4. Press [TIMER].
 - The TIMER instruction is displayed on the input buffer line.



The screenshot shows a rectangular input buffer with a blue border. Inside, the text 'TIMER T=1.00' is displayed in a monospaced font. A small cursor is visible at the end of the text.

5. Change the timer value.
 - Move the cursor to the timer value and change it by pressing [SHIFT] + the cursor key. The timer unit of adjustment is 0.01 seconds.



The screenshot shows the input buffer with 'TIMER T=100'. The '100' is highlighted with a blue background, and a cursor is positioned at the end of the text.

- If you use the Numeric keys to input the timer value, press [SELECT] when the cursor is on the timer value. The data input line appears. Input the value and press [ENTER].



The screenshot shows the input buffer with 'TIMER T=1.00'. A data input line is visible below the main text, containing '1.00'. A blue cursor is positioned over the '1.00' in the data input line.

6. Press [INSERT].
 - The [INSERT] key lamp lights.
 - When registering before the END instruction, pressing [INSERT] is not needed.
7. Press [ENTER].
 - The TIMER instruction is registered.



The screenshot shows a program listing with three lines of code: '0003 MOVJ VJ=50.00', '0004 TIMER T=1003', and '0005 MOVL V=138'. The second line is highlighted with a blue background, indicating it is the current instruction.

■ **Changing Timer Value**

1. Press [TIMER].
2. Press [SELECT].
 - The DETAIL EDIT window for the TIMER instruction appears.

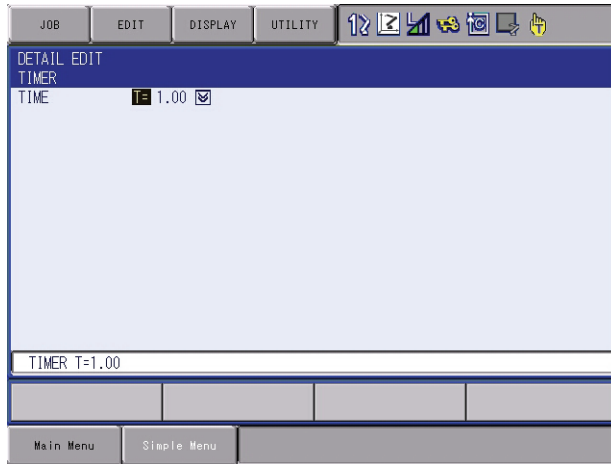

3. Input the timer value on the instruction DETAIL EDIT window.

- (1) When is selected, the items available to be changed are displayed in the dialog box.

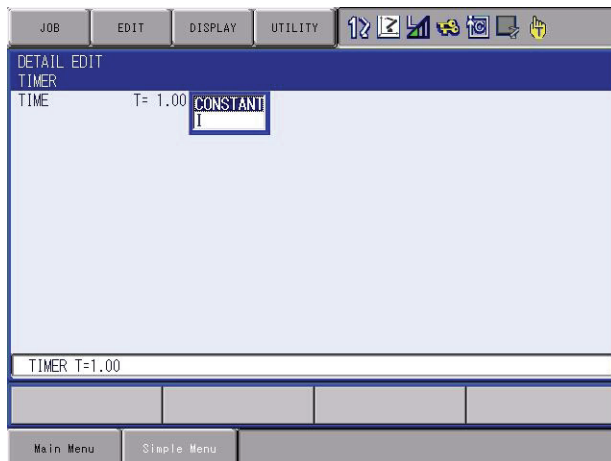

- (2) Select the particular item to be changed.

- When a number is to be changed, move the cursor to the number and press [SELECT]. Input the desired value using the Numeric keys, and press [ENTER].



4. Press [ENTER].

- The DETAIL EDIT window is closed and the JOB CONTENT window appears again. Modified content is displayed in the input buffer line.



DX100

3 Teaching
3.2 Teaching Operation

5. Press [INSERT].
 - The [INSERT] key lamp lights.
 - When registering before the END instruction, pressing [INSERT] is not needed.
6. Press [ENTER].
 - The TIMER instruction is registered.

```
0003 MOVJ VJ=50.00  
0004 TIMER T=1003  
0005 MOVL V=138
```

3.2.4 Overlapping the First and Last Steps

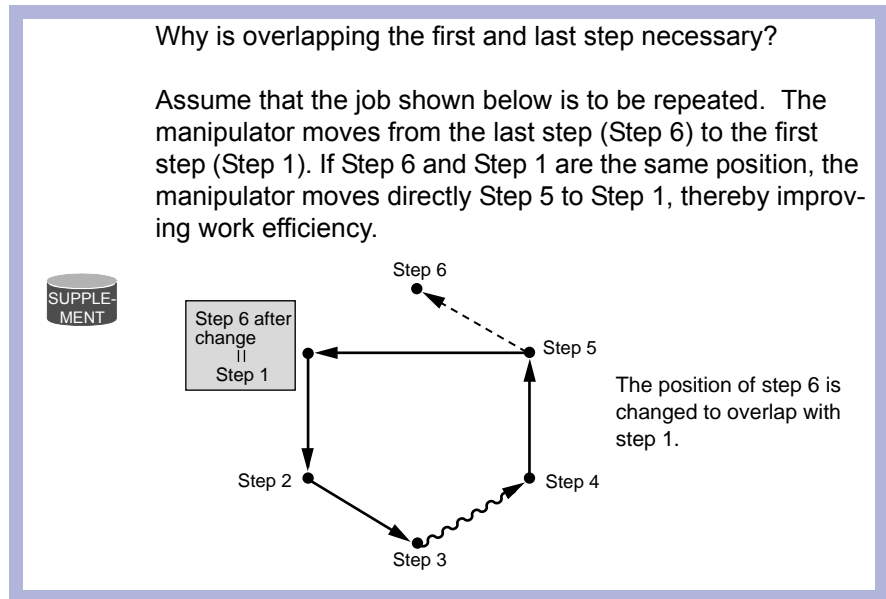

1. Move the cursor to the first step line.
2. Press [FWD].
 - The manipulator moves to the first step position.
3. Move the cursor to the last step line.
 - The cursor starts blinking.
 - When the cursor line position and the manipulator position are different in the JOB CONTENT window, the cursor blinks.
4. Press [MODIFY].
 - The key lamp lights.
5. Press [ENTER].
 - The position data for the first step is registered on the line of the last step.
 - At this time, only the position data can be changed in the last step. Interpolation type and play speed do not change.

3.3 Checking Steps

3.3.1 FWD/BWD Key Operations

Check whether the position of the taught steps is appropriate using [FWD] or [BWD] on the programming pendant. Each time [FWD] or [BWD] is pressed, the manipulator moves by a single step.

[FWD]: Moves the manipulator ahead in step number sequence. Only the move instruction is executed when [FWD] is pressed, but when [INTERLOCK] + [FWD] are pressed, all instructions are executed.

[BWD]: Moves the manipulator backward a step at a time in reverse step number sequence. Only the move instruction is executed.



For safety, set manual speed at  or below.

1. Move the cursor to the step to be checked.
2. Press [FWD] or [BWD].
 - The manipulator reaches the following / previous step and stops.

3.3.1.1 Precautions When Using FWD / BWD Operations

■ **FWD Movements**

- The manipulator moves in step number sequence. Only move instructions are executed when [FWD] is pressed. To execute all instructions, press [INTERLOCK] + [FWD].
- The manipulator stops after playing a single cycle. It does not move after the END instruction is reached, even if [FWD] is pressed. However, at the end of a called job, the manipulator moves the instruction next to the CALL instruction.

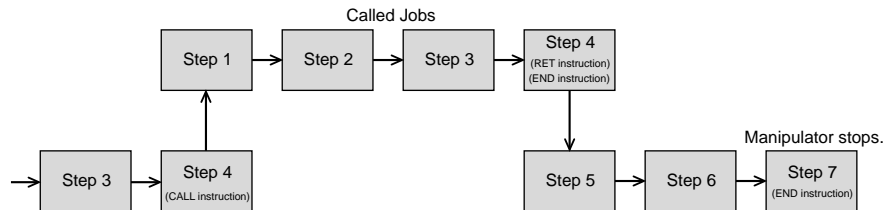
■ **BWD Movements**

- The manipulator moves in reverse step number sequence. Only move instructions are executed.
- The manipulator does not move after the first step is reached, even if [BWD] is pressed. However, at the beginning of a called job, the manipulator moves to the instruction immediately before the CALL instruction.

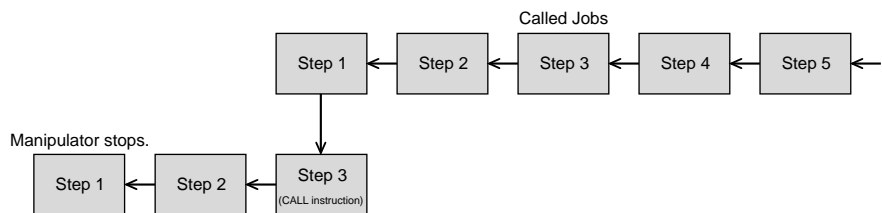
■ **Circular Movements with FWD/BWD Key Operations**

- The manipulator moves in a straight line to the first step of the circular interpolation.
- There must be three circular interpolation steps in a row to move the manipulator in an arc.
- If [FWD] or [BWD] operation is restarted after being stopped to move the cursor or to perform search, the manipulator moves in a straight line to the next step.
- If [FWD] or [BWD] operation is restarted after being stopped to move the axis as shown below, the manipulator moves in a straight line to P2, the next circular interpolation. Circular motion is restored from P2 to P3.

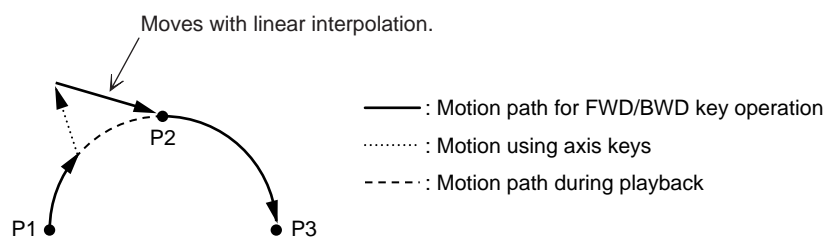

■ **Spline Curve Movements with FWD/BWD Operations**

- The manipulator moves in a straight line to the first step of spline interpolation.
- There must be three spline curve motion steps in a row to perform a spline curve operation.
- Depending on the position where the [FWD] / [BWD] operation is performed, the alarm “IRREGULAR DISTANCES BETWEEN TEACHING POINTS” may occur.
- Note that FWD/BWD inching operations change the path of the manipulator and **caution is therefore required**. Performing these operations also increases the likelihood that the “IRREGULAR DISTANCES BETWEEN TEACHING POINTS” will occur.
- If the [FWD] or [BWD] operation is restarted after being stopped to move the cursor or perform a search, the manipulator moves in a straight line to the next step.
- If the [FWD] or [BWD] operation is restarted after being stopped to move the axis as shown below, the manipulator moves in a straight line to P2, the next spline curve motion step. Spline curve motion is restored from P2 onward. However, the path followed between P2 and P3 is somewhat different from the path followed at playback.

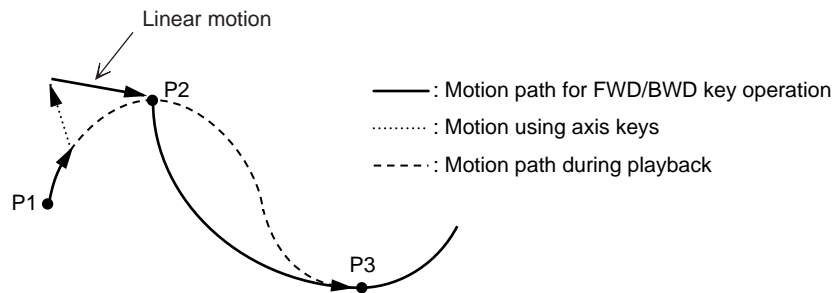

- If the manipulator is moved to P3 with [FWD], stopped, and then returned to P2 with [BWD], the path followed between P2 and P3 is different for each of the following: the first FWD operation, the BWD operation, and the consequent FWD operation.

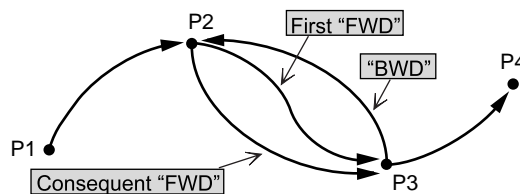

3.3.1.2 Selecting Manual Speed

When [FWD] or [BWD] is pressed, the manipulator moves at the manual speed selected at that time. Selected manual speed can be checked by the manual speed indication on the programming pendant.



Manual speed is set with [FAST] and [SLOW]. FWD operation can be performed at a high speed by pressing [HIGH SPEED]. Follow these procedures to select a manual speed.

- Each time [FAST] is pressed, the speed switches in the order of "INCH" → "SLOW" → "MED" → "FAST".



- Each time [SLOW] is pressed, the speed switches in the order of "FAST" → "MED" → "SLOW" → "INCH".



- FWD/BWD operation is performed with SLW speed even if INCH is selected.
- [HIGH SPEED] is available only for the FWD operation but not for BWD operation.

3.3.1.3 Moving to Reference Point

To check the position of a taught reference point, follow these procedures to move the manipulator to the reference point.

1. Move the cursor to the reference point instruction line to be checked.
2. Press [REFP] + [FWD].
 - The manipulator moves to the reference point of the cursor line.



The programming pendant does not have the [REFP] key for the application of spot welding, general purposes (= material handling, assembling, cutting) or motor gun.

3.3.1.4 Test Operations

Playback operations can be simulated in the teach mode with test operations. This function is convenient for checking continuous paths and operation instructions.

Test operation differs in the following ways from actual playback in the play mode.



- Operation speeds greater than the maximum teaching speed are reduced to the maximum teaching speed.
- Work instruction output, such as arc output, is not executed.

Note that the motion path for the playback operation is replayed during the test operation. Therefore, make sure that there is no obstacle around the manipulator and great caution should be exercised when the test operation is performed.

Motion Path for Test Operation

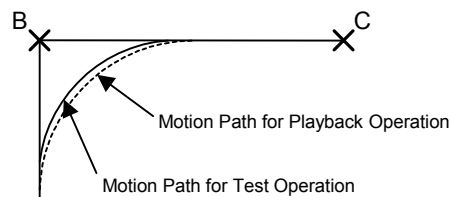

Job Example		
NOP		
MOVJ VJ=50.0	⇒	A
MOVL V=1500.0	⇒	B
MOVL V=1500.0	⇒	C
:		



There may be a slight difference between the motion path for the test operation and the motion path for the playback operation due to a mechanical error or control delay, etc.

Test operation is performed by pressing [INTERLOCK] and [TEST START]. For safety purposes, these keys will only function while the keys are held down.

1. Select {JOB} under the main menu.
2. Press {JOB}.
 - The test operation JOB CONTENT window appears.
3. Press [INTERLOCK] + [TEST START].
 - The manipulator starts the test cycle operation.
 - However, after the operation starts, the motion continues even if [INTERLOCK] is released.
 - The manipulator moves only while these keys are held down.
 - The manipulator stops immediately when [TEST START] is released.



Always check safety conditions before pressing [INTERLOCK] + [TEST START] to start the manipulator in motion.

3.3.1.5 Machine Lock Operation

When “MACHINE LOCK” is enabled, the [FWD] / [BWD] operation or the test operation can be performed to check the status of input and output without moving the manipulator.

1. Press [AREA].
2. Select {UTILITY}.
3. Select {SETUP SPECIAL RUN}.
 - The SPECIAL TEACH window appears.
4. Select “MACHINE LOCK”.
 - Press [SELECT] to switch “VALID” and “INVALID”.



- The setting of “MACHINE LOCK” is maintained even after the mode is switched: If the machine lock is set to “VALID” in the teach mode, it is still “VALID” after switching to the play mode.
The same applies when the mode is switched from the play mode to the teach mode.
- Note that the machine lock becomes “INVALID” if the following operation is performed.
 - Execution of “CANCEL ALL SELECT” in the SPECIAL PLAY window.
 - Turning off the main power.

3.4 Modifying Steps

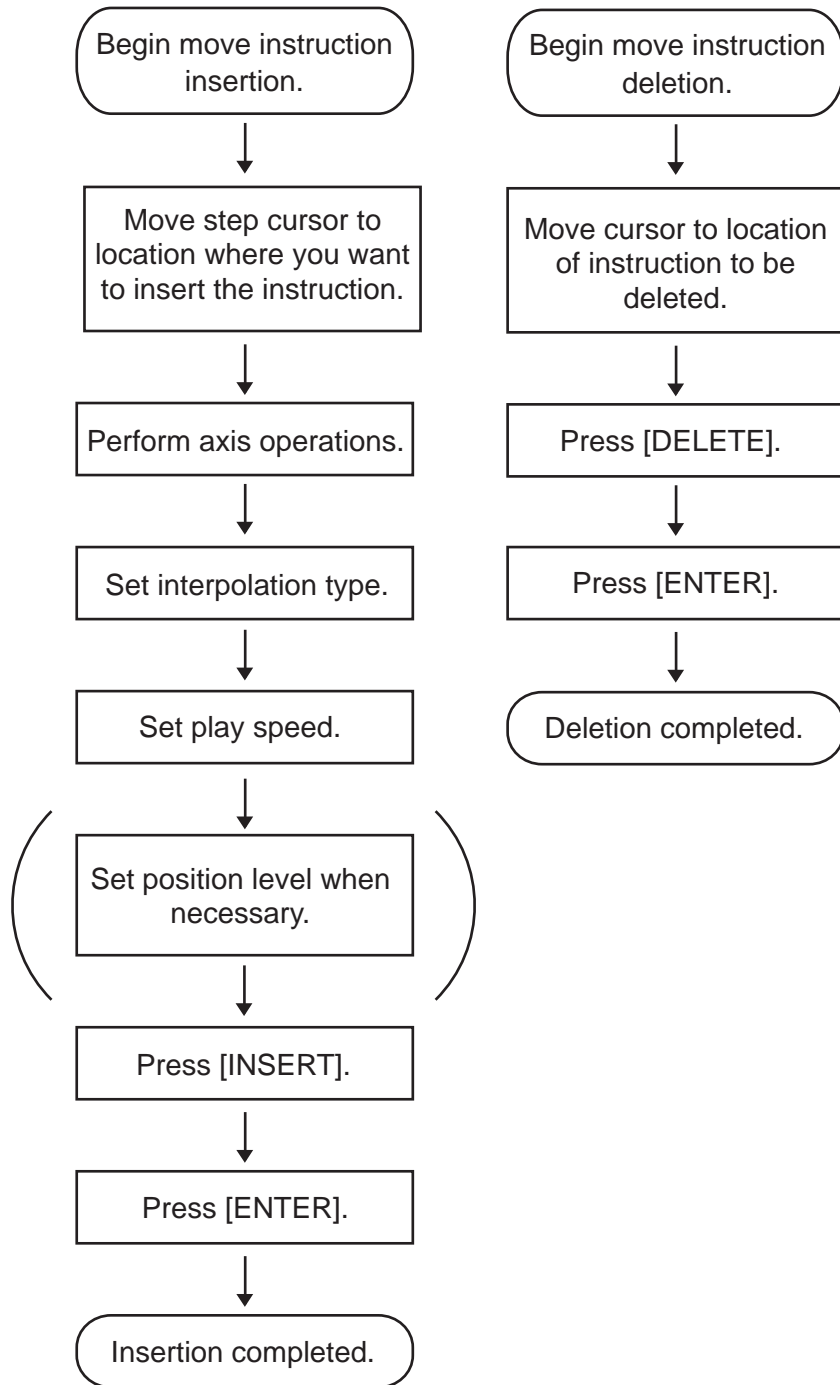

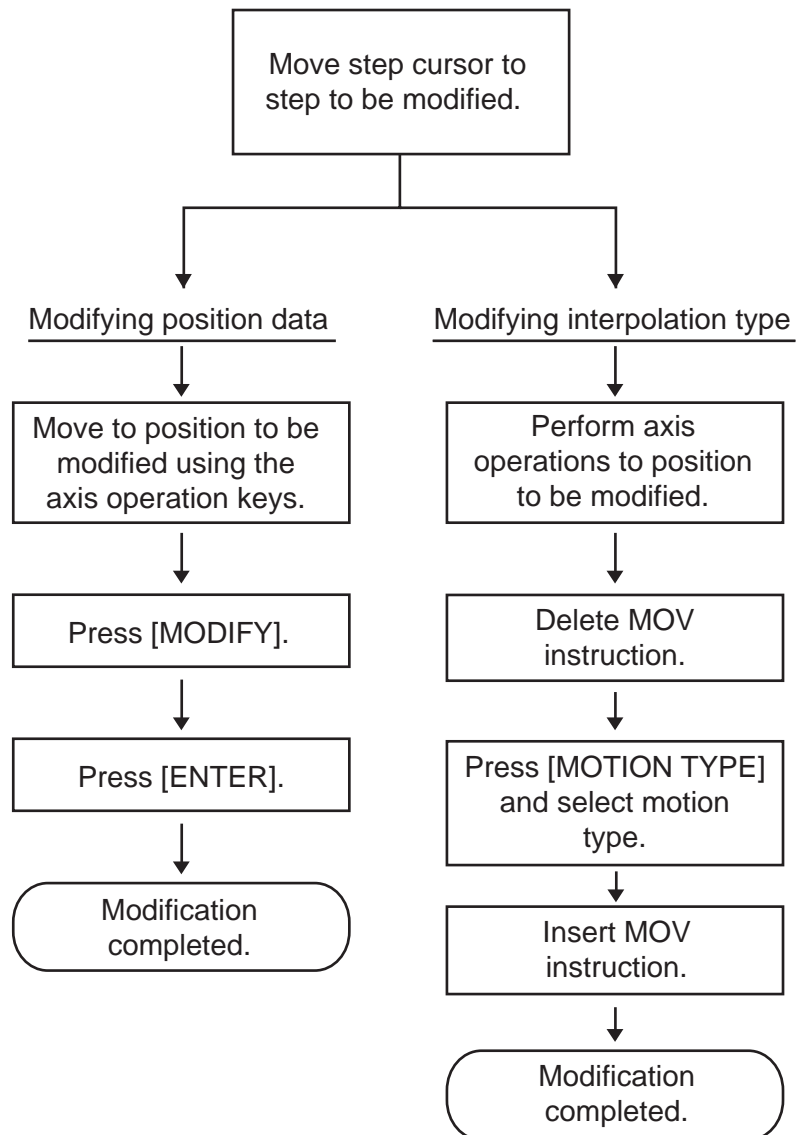

It is not possible to change a move instruction to a reference point instruction and vice versa.

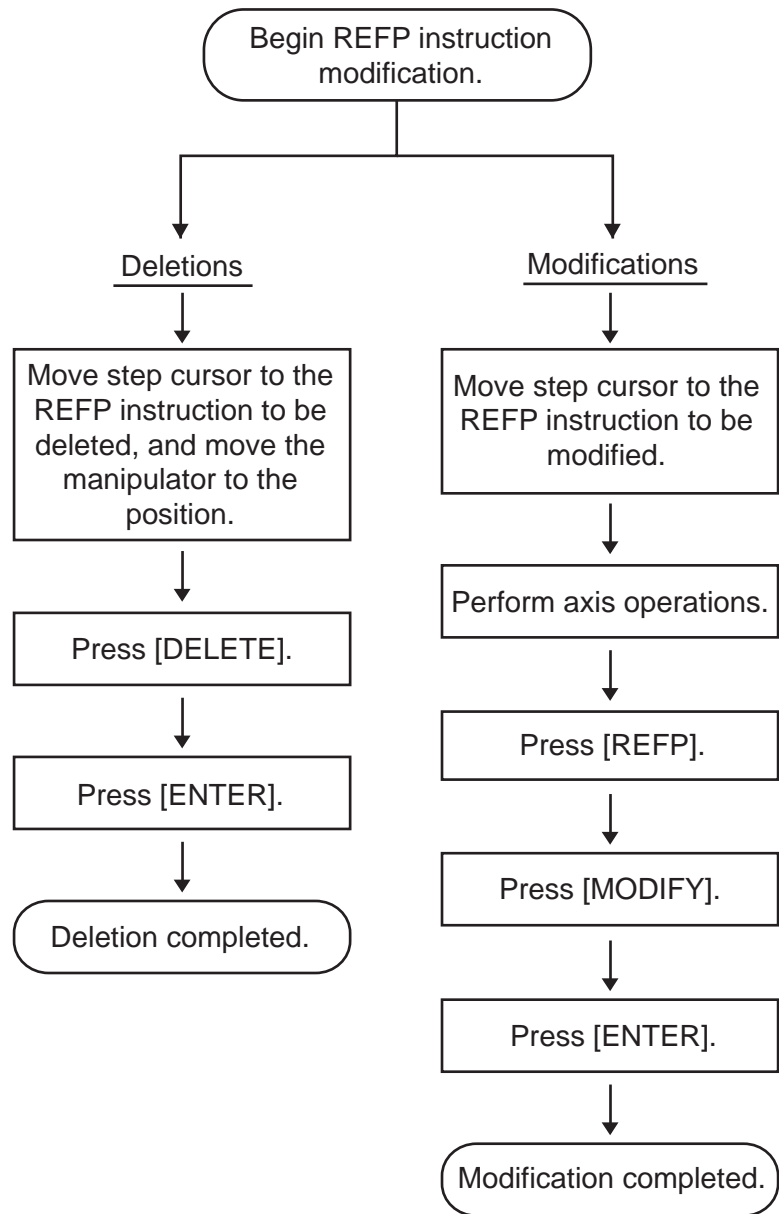

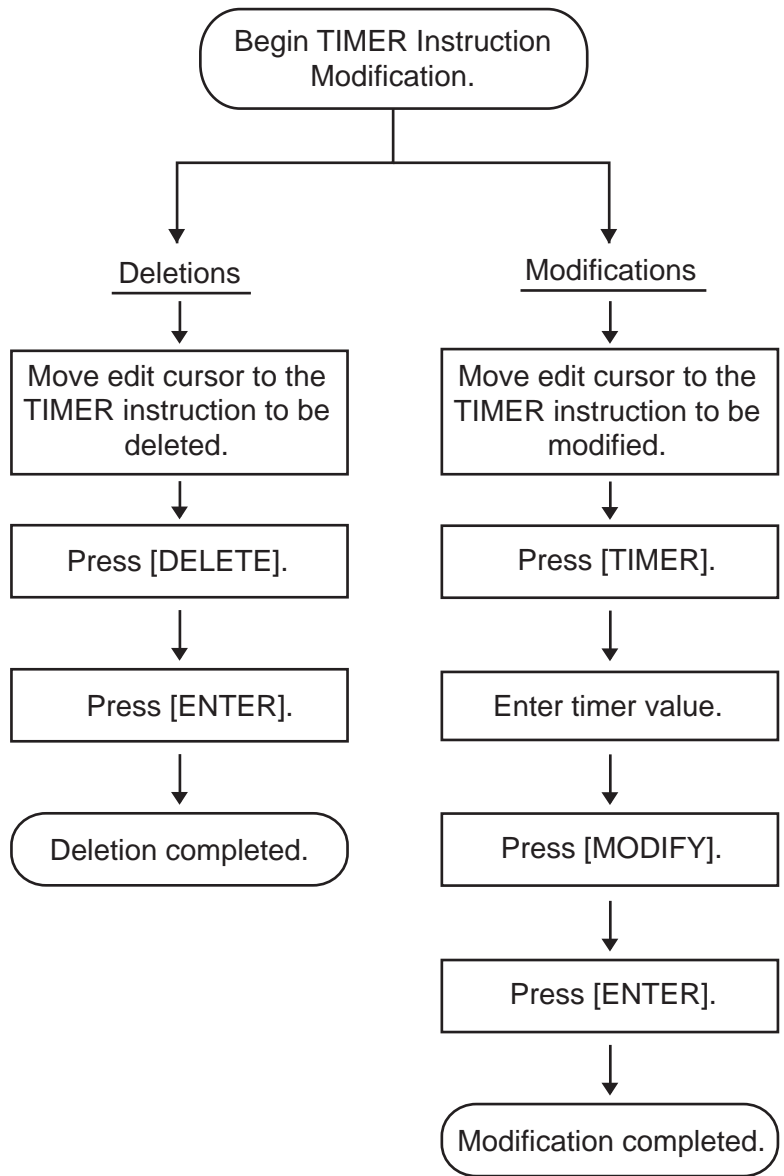

3.4.1 Displaying the JOB CONTENT Window for Editing

3.4.1.1 Currently Called Up Job

1. Select {JOB} under the main menu.
2. Select {JOB}.
 - The JOB CONTENT window appears.

3.4.1.2 Calling Up Other Jobs

NOTE In any other than the teach mode, set the mode switch to “TEACH.”

1. Select {JOB} under the main menu.
2. Select {SELECT JOB}.
 - The JOB LIST window appears.

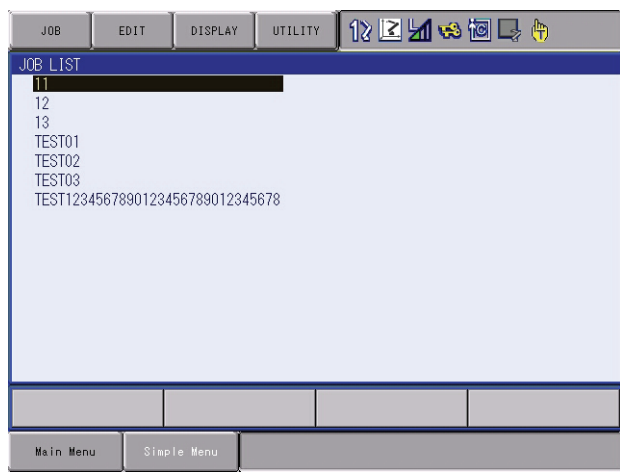

3. Select the job name to be called.

3.4.2 Inserting Move Instructions



Move instructions cannot be inserted when the servo power is OFF.

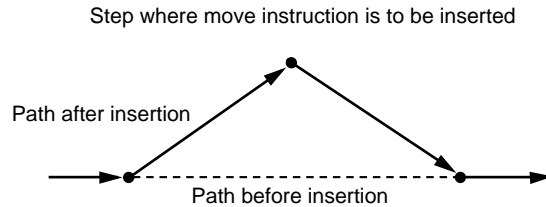

1. Move the cursor to the line immediately before the insert position.

The line immediately before where the move instruction is to be added.

0006	MOVL V=276
0007	TIMER T=1.00
0008	DOU OT#(1) ON
0009	MOVJ VJ=100.0

2. Press the axis operation key.
 - Turn ON the servo power and press the axis operation key to move the manipulator to the position to be inserted.



Confirm the move instruction on the input buffer line and set desired interpolation type and play speed.

3. Press [INSERT].
 - The key lamp will light.



When the inserting position is immediately before the END instruction, pressing [INSERT] is not needed.

4. Press [ENTER].
 - The move instruction is inserted after the cursor line.

The move instruction is added.

0006	MOVL V=276
0007	TIMER T=1.00
0008	DOU OT#(1) ON
0009	MOVL V=558
0010	MOVJ VJ=100.0

5. Press [ENTER].
 - <Examples of Inserting a Move Instruction>
 - When a move instruction is inserted in the following job, it is placed on different lines according to the setting in the

TEACHING CONDITION window.

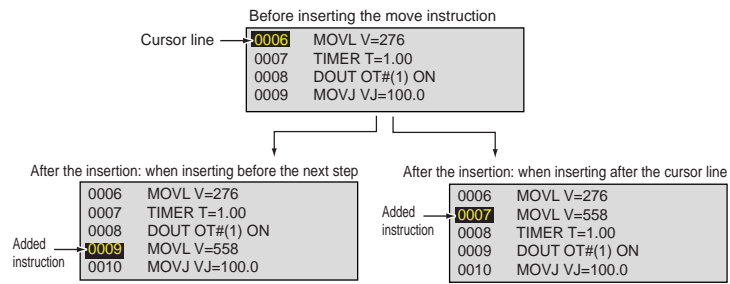

Positions where the move instructions are inserted.



The default location for insertions is “before the next step,” but it is also possible to insert “after the cursor line.” This setting is made in the “Move Instruction Register Method” in the TEACHING CONDITION window.

3.4.3 Deleting Move Instructions

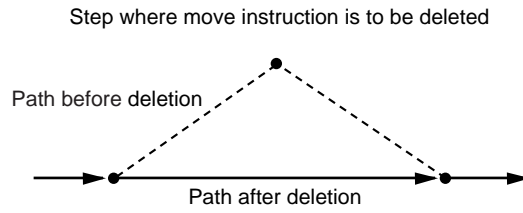

1. Move the cursor to the move instruction to be deleted.

Move instruction to be deleted	0003	MOVL V=138
	0004	MOVL V=558
	0005	MOVJ VJ=50.00



If the manipulator position differs from the cursor position on the window, the cursor blinks. Stop the blinking by either of the following procedures.

1. Press [FWD] and move the manipulator to the position where the move instruction is to be deleted.
2. Press [MODIFY]→ [ENTER] to change the position data of the blinking cursor position to the current manipulator position.

2. Press [DELETE].
 - The key lamp will blink.
3. Press [ENTER].
 - The step indicated by cursor line is deleted.

0003	MOVL V=138
0004	MOVJ VJ=50.00

3.4.4 Modifying Move Instructions

3.4.4.1 Modifying Position Data

1. Move the cursor to the MOV instruction to be modified.
 - Display the JOB CONTENT window and move the cursor to the move instruction to be changed.
2. Press the axis operation key.
 - Turn ON the servo power and press the axis operation key to move the manipulator to the desired position.
3. Press [MODIFY].
 - The key lamp will blink.
4. Press [ENTER].
 - The position data in the present position is registered.



For MOV instructions for which position variables have been set, the position variables will not be changed.

3.4.4.2 Modifying Interpolation Type



Modifying only interpolation type is impossible. The interpolation type can be modified as a choice for modifying the position data.

1. Move the cursor to the move instruction to be modified.
 - Display the JOB CONTENT window, and move the cursor to the move instruction for which interpolation type is to be changed.
2. Press [FWD].
 - Turn ON the servo power and press [FWD] to move the manipulator to the position of the move instruction.
3. Press [DELETE].
 - The key lamp will blink.
4. Press [ENTER].
 - The cursor line step is deleted.
5. Press [MOTION TYPE].
 - Press [MOTION TYPE] to change the interpolation type.
 - Each time [MOTION TYPE] is pressed, the input buffer line instruction alternates.
6. Press [INSERT].
7. Press [ENTER].
 - The interpolation type and position data are changed at the same time.

3.4.5 Undo Operation

After inserting, deleting, or modifying an instruction, the operation can be undone.

The UNDO operation becomes enabled by selecting {EDIT}→{ENABLE UNDO}, and becomes disabled by selecting {EDIT}→{*ENABLE UNDO} while editing a job.



- The undo operation can be performed even after the manipulator is moved by the FWD or BWD operation or test operation after inserting, deleting, or modifying a move instruction. However, the undo operation cannot be performed if other instructions are edited or a job is executed in the play mode after editing the move instruction.
- The undo operation works only for the last five edited instructions only.

1. Press [ASSIST].
 - The assist menu appears.



2. Select {UNDO}.
 - The last operation is undone.
3. Select {REDO}.
 - The last UNDO operation is undone.

3.4.6 Modifying Reference Point Instructions

3.4.6.1 Deleting Reference Point Instructions



If the manipulator position differs from the cursor position, an error message is displayed. If this occurs, follow either of the procedures below.

- Press [REFP] + [FWD] to move the manipulator to the position to be deleted.
- Press [MODIFY] then [ENTER] to change the reference point position data to the current position of the manipulator.

1. Move the cursor to the reference point instruction to be deleted.
2. Press [DELETE].
 - The key lamp will blink.
3. Press [ENTER].
 - The reference point instruction at the cursor line is deleted.

3.4.6.2 Modifying Reference Point Instructions

1. Move the cursor to the reference point instruction to be modified.
2. Move the manipulator with the axis operation keys.
 - Turn ON the servo power and use the axis operation keys to move the manipulator to the desired position.
3. Press [REFP].
4. Press [MODIFY].
 - The key lamp will light.
5. Press [ENTER].
 - The reference point instruction at the cursor line is changed.

3.4.7 Modifying Timer Instructions**3.4.7.1 Deleting Timer Instructions**

1. Move the cursor to the timer instruction to be deleted.

	0003	MOVJ VJ=50.00
Timer instruction to be deleted →	0004	TIMER T=0.50
	0005	MOVL V=138

2. Press [DELETE].
 - The key lamp will light.
3. Press [ENTER].
 - The timer instruction at the cursor line is deleted.

	0003	MOVJ VJ=50.00
	0004	MOVL V=138

3.4.7.2 Modifying Timer Instructions

1. Move the cursor to the timer instruction to be modified.

	0003	MOVJ VJ=50.00
	0004	TIMER T=0.50
	0005	MOVL VJ=138
	0006	MOVL VJ=138

2. Press [TIMER].

	0003	MOVJ VJ=50.00
	0004	TIMER T=0.50
	0005	MOVL VJ=138
	0006	MOVL VJ=138

3. Move the cursor to the input buffer line timer value.
 - Move the cursor to the input buffer line timer value and press [SHIFT] + the cursor key to set the data.
 - To use the Numeric keys to input data, move the cursor to the input buffer line timer value and press [SELECT].

	⇒	TIMER T=0.50
--	---	--------------

4. Change the timer value.
5. Press [MODIFY].
6. Press [ENTER].
 - This key lamp will light.

3.5 Modifying Jobs

3.5.1 Calling Up a Job

1. Select {JOB} under the main menu.
2. Select {SELECT JOB}.
 - The JOB LIST window appears.

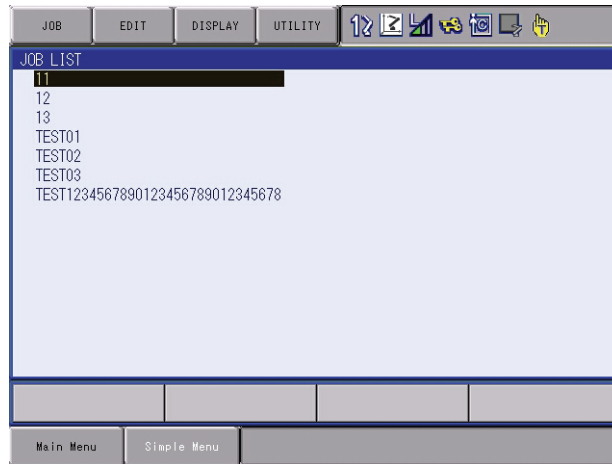

3. Select the desired job.

3.5.2 Windows Related to Job

There are five types of job windows. Jobs can be checked and edited in these windows.

- **JOB HEADER Window**
Comments, data and time of registration, edit prohibit status, and so on are displayed and edited.
- **JOB CONTENT Window**
The content of the registered job can be displayed and edited.
- **COMMAND POSITION Window**
The taught data is displayed.
- **JOB LIST Window**
The registered job is sorted alphabetically, then displayed, and the job is selected.
- **JOB CAPACITY Window**
The number of registered jobs, amount of memory, number of steps used, etc. is shown.

3.5.3 JOB HEADER Window

1. Select {JOB} under the main menu.
 2. Select {JOB}.
 3. Select {DISPLAY} under the menu.
 4. Select {JOB HEADER}.
- The JOB HEADER window appears. Scroll the window using the cursor.

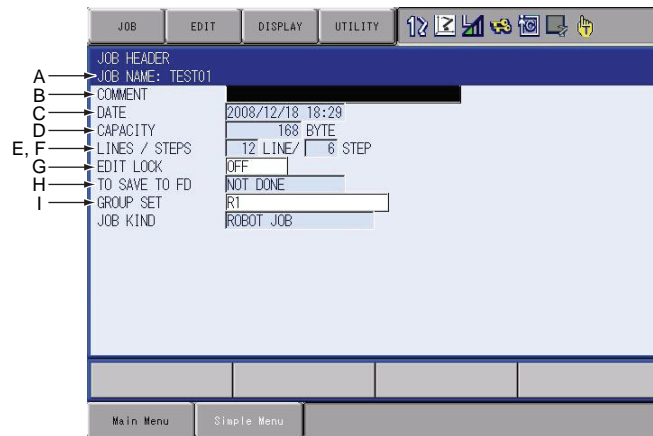

A. JOB NAME

Displays the name of the current job.

B. COMMENT

Displays the comments attached to the current job. This can be edited in this window.

C. DATE

Displays the date and time of the last editing of the job.

D. CAPACITY

Displays the amount of memory that is being used to register this job.

E. LINES

Displays the total number of instructions registered in this job.

F. STEPS

Displays the total number of move instructions registered in this job.

G. EDIT LOCK

Displays whether the edit prohibit setting for this job is ON or OFF. This can be changed in this window.

H. TO SAVE TO FD

Displays "DONE" if the contents of the job have already been saved to an external memory after the date and time of the last editing operation, and displays "NOT DONE" if they have not been saved. The job is marked as "DONE" only if it is saved as an independent job or as a related job. If it is saved in a CMOS batch operation, it is not marked as "DONE."

I. GROUP SET

Displays the control group that this job controls. If the master axis is specified, the master axis is highlighted.



To return to the JOB CONTENT window from the JOB HEADER window, select {DISPLAY} from the menu and then select {JOB CONTENT}.

3.5.4 JOB CONTENT Window

1. Select {JOB} under the main menu.
2. Select {JOB}.
 - The JOB CONTENT window appears.

–  ← (Left) : The cursor is moved to the address area.

–  → (Right): The cursor is moved to the instruction area.

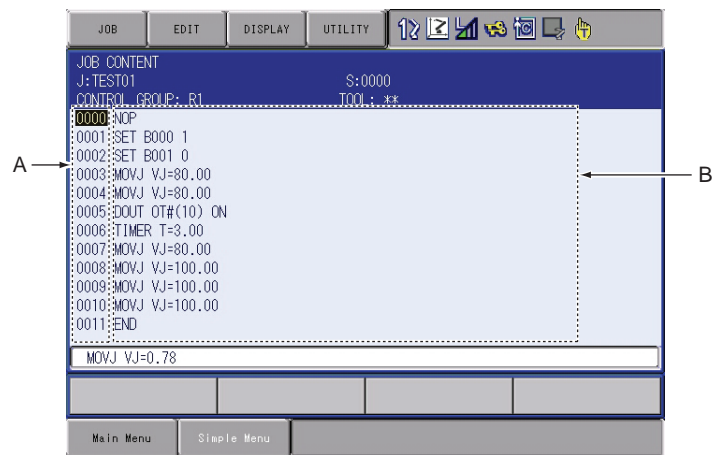

A. Address Area

Displays line numbers.

B. Instruction Area

Displays instructions, additional items, and comments. Line editing is possible.

3.5.4.1 COMMAND POSITION Window

1. Select {ROBOT} under the main menu.
2. Select {COMMAND POSITION}.
 - Edit operations cannot be conducted on this window, but the taught play speed and position data can be viewed on this window.

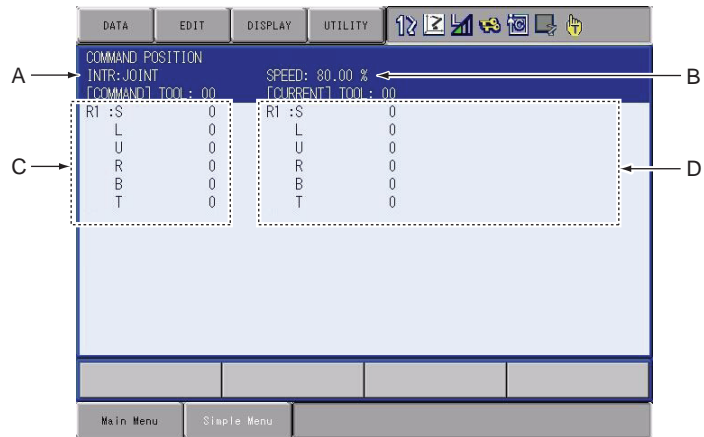
**A. Interpolation**

Displays the interpolation type.

B. Speed

Displays the play speed.

C. Command Position

Displays the tool file number and position data that has been taught for this job. Steps which have no position data, such as move instructions which use position variables, are marked with an asterisk (*).

D. Current Data

Displays the current tool file number and position of the manipulator.

3.5.5 JOB CAPACITY Window

1. Select {JOB} under the main menu.
2. Select {JOB CAPACITY}.

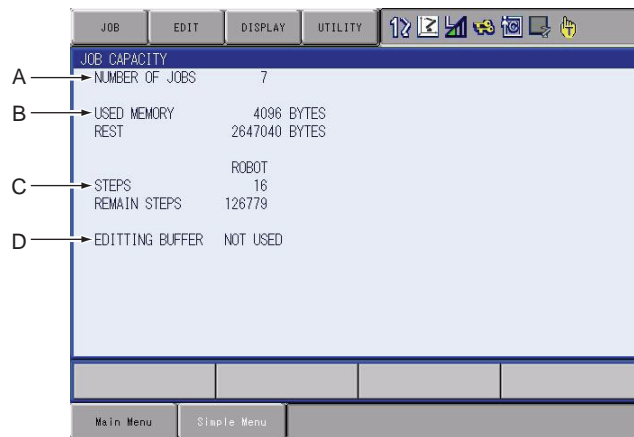
**A. NUMBER OF JOBS**

Displays the total number of jobs currently registered in the memory of DX100.

B. USED MEMORY

Displays the total amount of memory used in the DX100.

C. STEPS

Displays the total number of used steps.

D. EDITING BUFFER

Displays editing buffer use.

3.6 Editing Instructions

The editable content differs depending on whether the cursor is in the address area or instruction area.



A. When the cursor is in the address area

Instructions can be inserted, deleted, or modified.

B. When the cursor is in the instruction area

The data of additional items of already-registered instructions can be modified, inserted, or deleted.

Editing only additional items is called “line editing.”

When inserting or modifying instructions, input the instruction with the function keys such as [TIMER], etc. or by using the instruction list dialog box.

The selected instruction is displayed on the input buffer line with the same additional items as registered previously.

If the addition, deletion or modification of additional item is needed, edit on the instruction DETAIL EDIT window. If it is not needed, continue the registration process.

3.6.1 Instruction Group

The instructions are divided into eight groups by processing or each work.

Display	Instruction Group	Content	Example
IN/OUT	I/O Instruction	Controls input and output	DOUT, WAIT
CONTROL	Control Instruction	Controls processing and each work	JUMP, TIMER
MOTION	Move Instructions	Moves the manipulator	MOVJ, REFP
DEVICE	Work Instructions	Operates arc welding, spot welding, handling, painting, etc.	ARCON, WVON, SVSPOT, SPYON
ARITH	Operating Instructions	Performs arithmetic calculation	ADD, SET
SHIFT	Shift Instructions	Shifts the teaching point	SFTON, SFTOF
SENS (Option)	Sensor Instructions (Option)	Instructions related to the sensor	COMARCON
OTHER	Other Instructions	Instructions for functions other than above	SHCKSET
SAME	-	Specifies the instruction where the cursor is.	
PRIOR	-	Specifies the previously-registered instruction.	

■ Instruction List

By pressing [INFORM LIST] , the instruction group list dialog box appears.

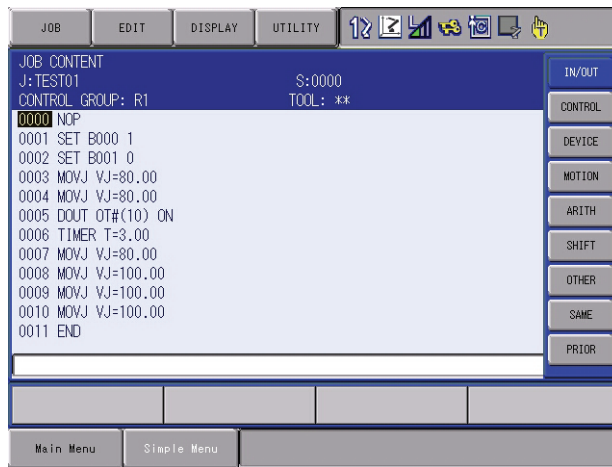

By selecting a group, the instruction list dialog box of the selected group appears.

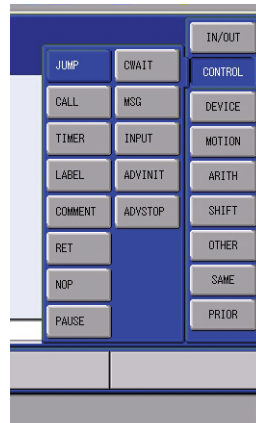

3.6.2 Inserting Instructions

1. Move the cursor to the address area in the JOB CONTENT window.
 - Move the cursor to the line immediately before where the instruction is to be inserted, in the teach mode.

Line before
 where instruction
 is to be added. →

```

0002 SET B001 0
0003 MOVJ VJ=80.00
0004 MOVJ VJ=80.00
  
```

2. Press [INFORM LIST].
 - The INFORM command list appears, and an underline is displayed beneath the line number in the address area.



3. Select the instruction group.
 - The instruction list dialog box appears. The selected instruction is displayed on the input buffer line with the same additional items as registered previously.

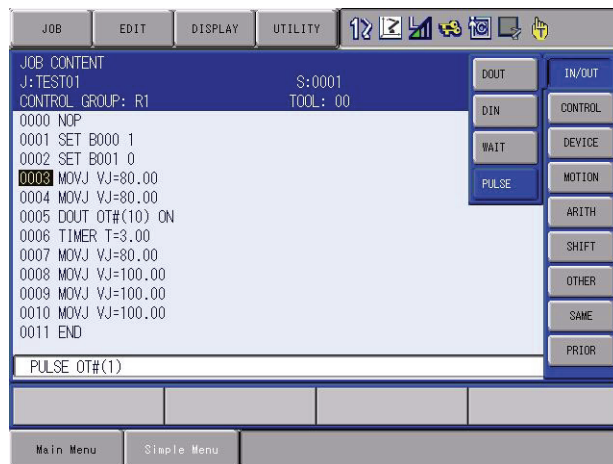

4. Select the instruction.
5. Change the data of additional items or variables as required.
 - **<When Nothing is to be Changed>**
 - (1) Proceed to Step 6.

– <When Additional Items are to be edited>

1. Changing numeric data

- (1) Move the cursor to the desired item and press [SHIFT] + the cursor key to increase or decrease the value.



- (2) To directly input the value using Numeric keys, press [SELECT] to display the input buffer line.



- (3) Type the value and press [ENTER]. The value on the input buffer line is changed.

2. Adding, modifying, or deleting an additional item

- (1) To add, modify, or delete an additional item, move the cursor to the instruction on the input buffer line and press [SELECT]. The DETAIL EDIT window appears.

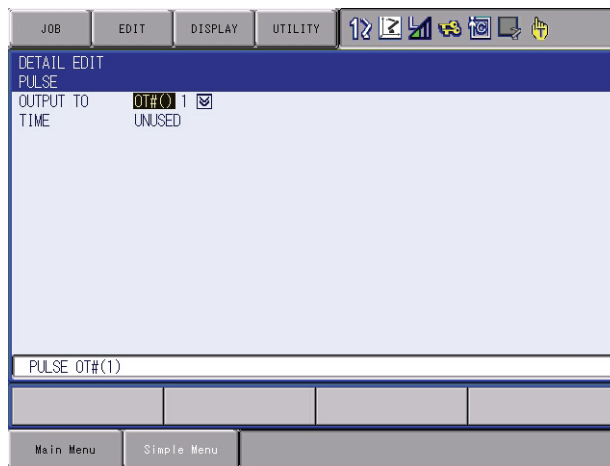

- To add an item, move the cursor to “UNUSED” and press [SELECT]. The selection dialog box appears.

- (2) Move the cursor to the desired item and press [SELECT]. To delete an item, move the cursor to the item to be deleted and select “UNUSED.”

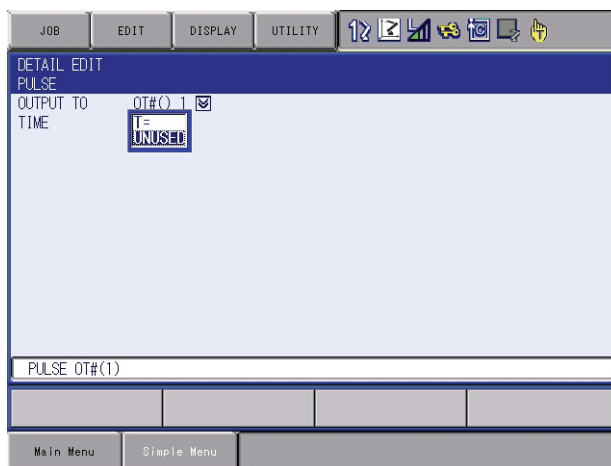

3. Changing the data type

- (1) To change the data type of an additional item, move the cursor to of the item and press [SELECT]. The data type list appears. Select the desired data type.

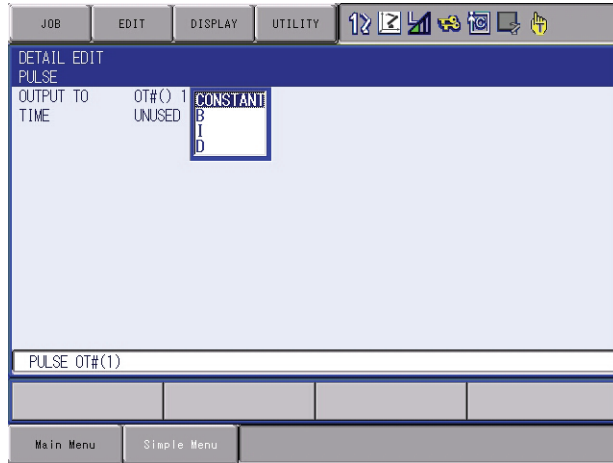

- (2) After additional items have been added, modified or deleted as required, press [ENTER]. The DETAIL EDIT window closes and the JOB CONTENT window appears.

6. Press [INSERT] and [ENTER].

- The instruction displayed in the input buffer line is inserted.



3.6.3 Deleting Instructions

1. Move the cursor to the address area in the JOB CONTENT window.
 - Move the cursor to the instruction line to be deleted, in the teach mode.

The line to be deleted

```

0003 MOVJ VJ=80.00
0004 PULSE OT#(1)
0005 MOVJ VJ=80.00
0006 DOUT OT#(10) ON
  
```

2. Move the cursor to the deleting line in the address area.
3. Press [DELETE] and [ENTER].
 - The instruction is deleted and the following lines move up.

The following lines move up.

```

0003 MOVJ VJ=80.00
0004 MOVJ VJ=80.00
0005 DOUT OT#(10) ON
  
```

3.6.4 Modifying Instructions

1. Move the cursor to the address area in the JOB CONTENT window.
 - Move the cursor to the instruction line to be modified, in the teach mode.

Instruction line to be changed

```

0004 MOVJ VJ=80.00
0005 DOUT OT#(10) ON
0006 TIMER T=3.00
  
```

2. Press [INFORM LIST].
 - The INFORM command list appears and the cursor moves to the INFORM command list.



3. Select the instruction group.
 - The instruction list dialog box appears. The selected instruction is displayed on the input buffer line with the same additional items as registered previously.

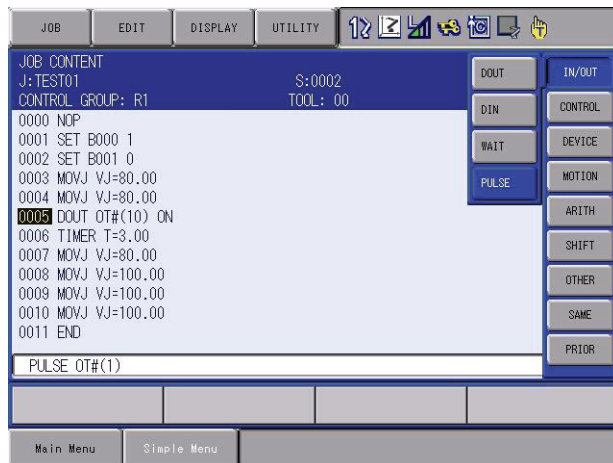

4. Select the instruction to be modified.
5. Change the data of additional items or variables as required.

– **<Editing Additional Items>**

1. Changing numeric data

- (1) Move the cursor to the desired item and press [SHIFT] + the cursor key to increase or decrease the value.



- To directly input the value using Numeric keys, press [SELECT] to display the input buffer line.



- (2) Type the value and press [ENTER]. The value on the input buffer line is changed.

2. Adding, modifying, or deleting an item

- (1) To add, modify or delete an additional item, move the cursor to the instruction on the input buffer line and press [SELECT]. The DETAIL EDIT window appears.

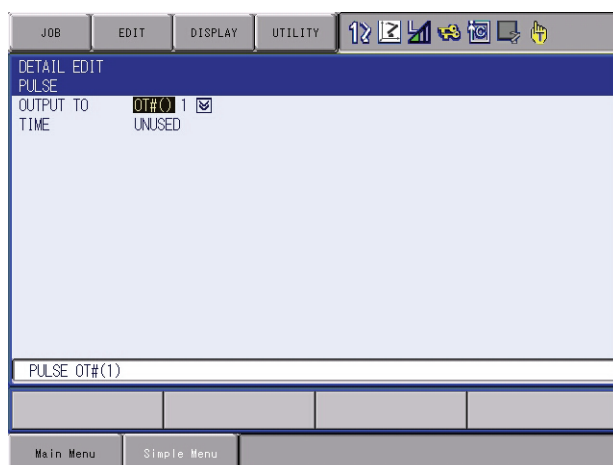

- (2) To add an item, move the cursor to "UNUSED" and press [SELECT]. The selection dialog box appears.

- (3) Move the cursor to the desired item and press [SELECT].
 To delete an item, move the cursor to the item to be deleted and select "UNUSED."

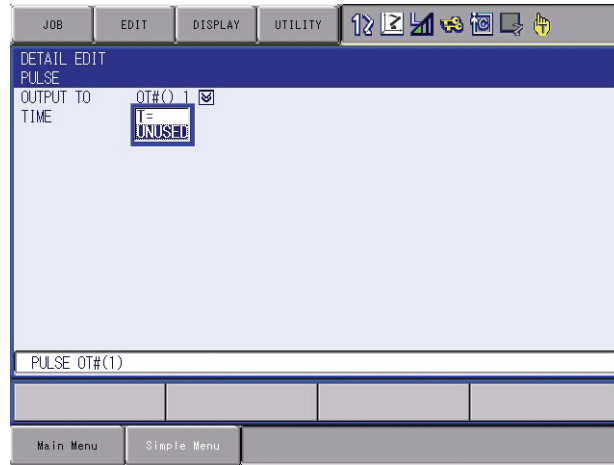

3. Changing the data type

- (1) To change the data type of an additional item, move the cursor to of the item and press [SELECT]. The data type list appears. Select the desired data type.

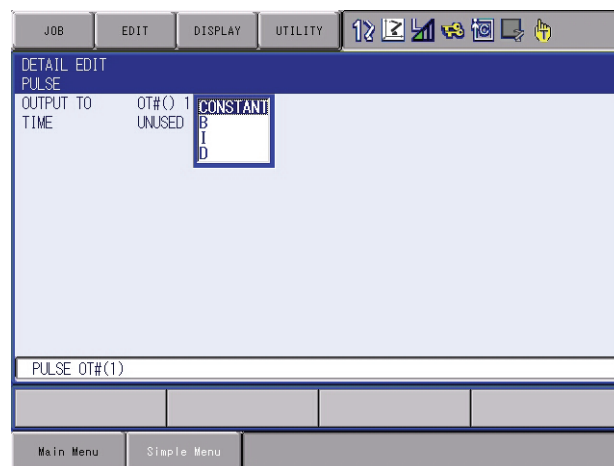

- (2) After additional items have been added, modified or deleted as required, press [ENTER]. The DETAIL EDIT window closes and the JOB CONTENT window appears.

6. Press [MODIFY] and [ENTER].

- The instruction is modified to the instruction displayed in the input buffer line.



3.6.5 Modifying Additional Numeric Data

1. Move the cursor to the instruction area in the JOB CONTENT window.
2. Select the line where the number data is to be modified.
 - The selected line can now be edited.

```
Number data to be modified | 0004 MOVJ VJ=80.00  
                             | 0005 PULSE OT#(1)  
                             | 0006 TIMER T=3.00
```

3. Move the cursor to the numeric data to be modified.
4. Input the desired number.
 - Press [SHIFT] + the cursor key to increase or decrease the value. To directly input the number, press [SELECT]. The input buffer line appears. Type the number and press [ENTER].

```
PULSE OT#(2)
```

5. Press [ENTER].
 - The numeric data is modified.

```
Instruction line for which numeric data was changed. | 0004 MOVJ VJ=80.00  
                                                         | 0005 PULSE OT#(2)  
                                                         | 0006 TIMER T=3.00
```

3.6.6 Modifying Additional Items

1. Move the cursor to the instruction area in the JOB CONTENT window.
2. Select the instruction line for which the additional item is to be modified.
 - The selected line can now be edited.

Instruction line for which additional item is to be modified.

```

0008 MOVJ VJ=100.00
0009 WAIT IN#(1)=ON
0010 MOVJ VJ=100.00
  
```

3. Select the instruction.
 - The DETAIL EDIT window appears.



4. Select the additional item to be modified.
 - The selection dialog box appears.



5. Select the desired additional item.
 - The modified additional item is displayed on the DETAIL EDIT window.



6. Press [ENTER].
 - The DETAIL EDIT window closes, and the JOB CONTENT window appears.
7. Press [ENTER].
 - Contents of the input buffer line are registered on the cursor line of the instruction area.

Instruction line for which additional item was modified.

```

0008 MOVJ VJ=100.00
0009 WAIT OUT#(1)=ON
0010 MOVJ VJ=100.00
  
```

3.6.7 Inserting Additional Items

1. Move the cursor to the instruction area in the JOB CONTENT window.
2. Select the instruction line for which the additional item is to be inserted.
 - The selected line can now be edited.

Instruction line —→ 0008 MOVJ VJ=100.00
 for which additional 0009 WAIT IN#(1)=ON
 item is to be added. 0010 MOVJ VJ=100.00

3. Select the instruction.
 - The selection dialog box appears.



4. Select the additional item to be inserted.
 - The additional item is inserted.

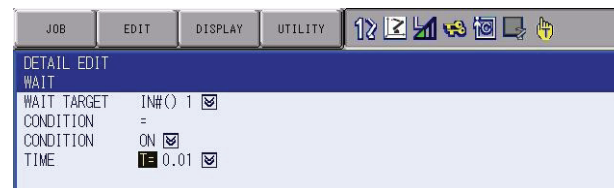

- When the additional item needs the numeric data, move the cursor to the number and press [SELECT]. The input buffer line appears. Type the number and press [ENTER].



5. Select inserting additional item.
 - The DETAIL EDIT window closes, and the JOB CONTENT window appears.
6. Press [ENTER].
 - Contents of the input buffer line are registered on the cursor line of the instruction area.

Instruction line for —→ 0008 MOVJ VJ=100.00
 which additional 0009 WAIT IN#(1)=ON T=0.50
 item was added. 0010 MOVJ VJ=100.00

3.6.8 Deleting Additional Items



This operation cannot be used for the additional item which is locked.

1. Move the cursor to the instruction area in the JOB CONTENT window.
2. Select the line where the additional item is to be deleted.
 - The selected line can be now be edited.

Instruction line for which additional item is to be deleted.

```

0008 MOVJ VJ=100.00
0009 WAIT IN#(1)=ON T=0.50
0010 MOVJ VJ=100.00
  
```

3. Select the instruction.
 - The DETAIL EDIT window appears.



4. Select the additional item to be deleted.
 - The selection dialog box appears.



5. Select "UNUSED."
 - "UNUSED" is displayed on the DETAIL EDIT window.



6. Press [ENTER].
 - The DETAIL EDIT window closes, and the JOB CONTENT window appears.
7. Press [ENTER].
 - Contents of the input buffer line are registered on the cursor line of the instruction area.

Instruction line for which the additional item was deleted.

```

0008 MOVJ VJ=100.00
0009 WAIT IN#(1)=ON
0010 MOVJ VJ=100.00
  
```

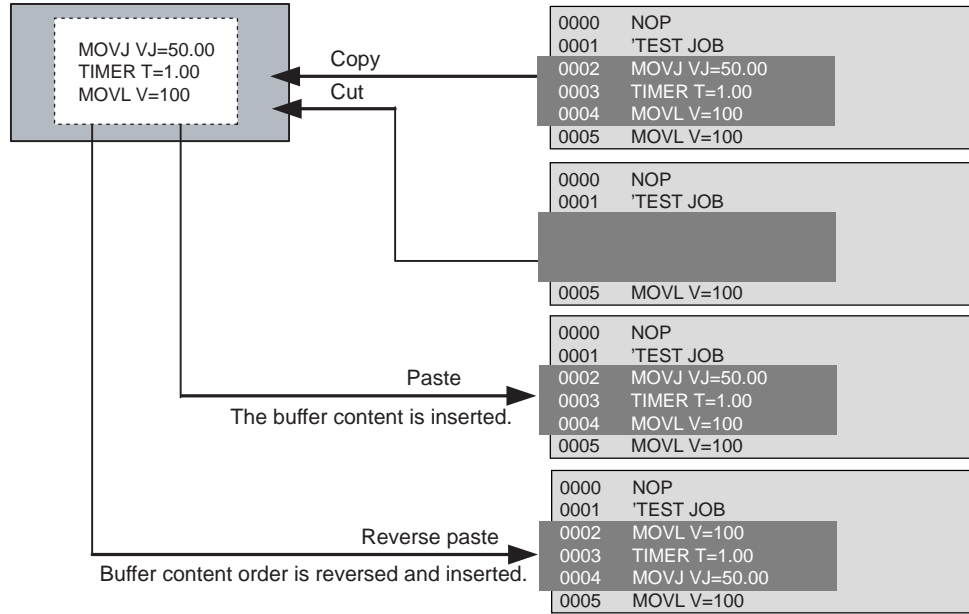
3.7.1 Selecting the Range

After setting the range, Copy and Delete can be performed.

1. Move the cursor to the instruction area in the JOB CONTENT window.

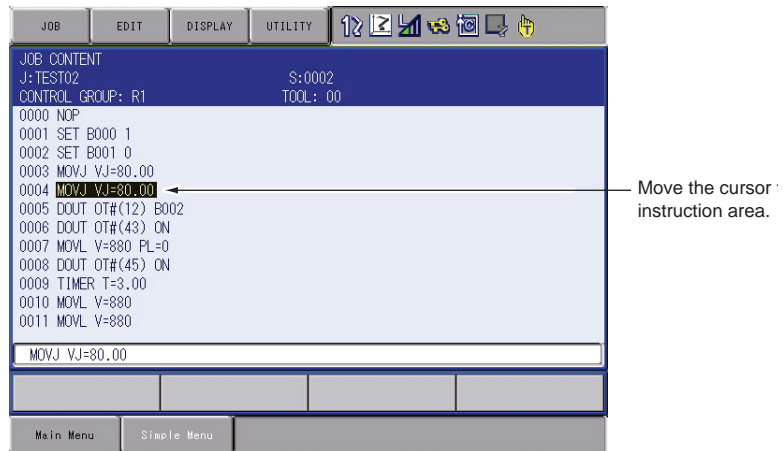

2. Move the cursor to the start line and press [SHIFT] + [SELECT].
 - The range specification begins, and the address is displayed in reverse.



3. Move the cursor to the end line.
 - The range is varied by moving the cursor. Up to the line specified by the cursor is the range.

3.7.2 Copying

Before copying, the range to be copied has to be specified.

1. Select {EDIT} under the menu.

– The pull-down menu appears.

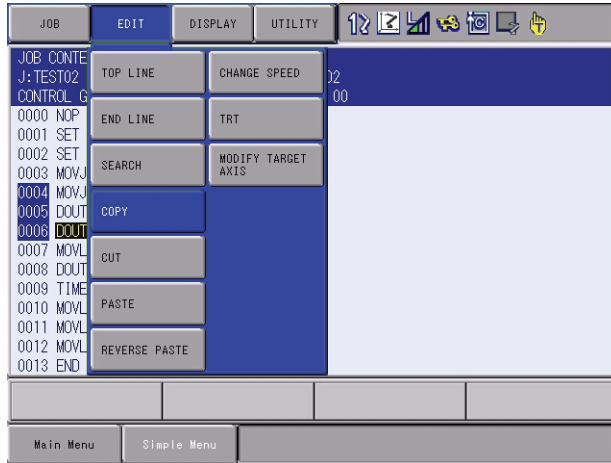

2. Select {COPY}.

– The specified range is copied to the buffer.

3.7.3 Cutting

Before cutting, the range to be cut has to be specified.

1. Select {EDIT} under the menu.

– The pull-down menu appears.

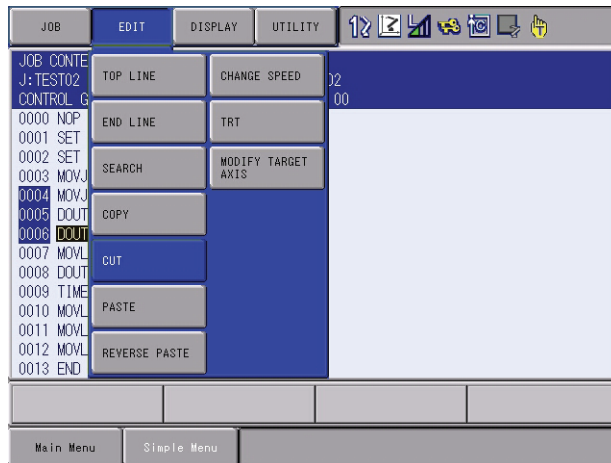

2. Select {CUT}.

– The confirmation dialog box appears. When “YES” is selected, the specified range is deleted and copied to the buffer.

– When “NO” is selected, the cutting operation is cancelled.

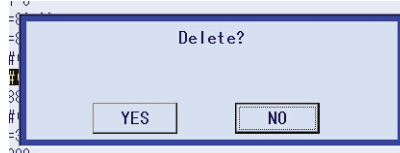

3.7.4 Pasting

Before pasting, the range to be pasted has to be stored in the buffer.

1. Move the cursor to the line immediately before the desired position in the JOB CONTENT window.
 - The pull-down menu appears.

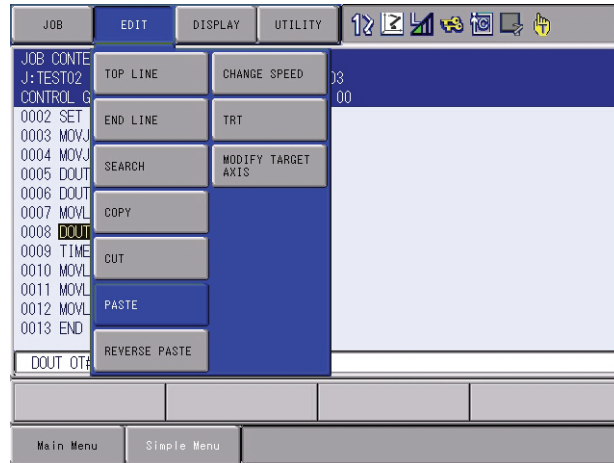

2. Select {EDIT} under the menu.
3. Select {PASTE}.
 - The confirmation dialog box appears.
 - When “YES” is selected, the contents of the buffer are inserted to the job.
 - When “NO” is selected, the pasting operation is cancelled.

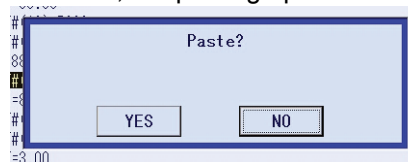

3.7.5 Reverse Pasting

Before pasting, the range to be pasted has to be stored in the buffer.

1. Move the cursor to the line immediately before the desired position in the JOB CONTENT window.
2. Select {EDIT} under the menu.
 - The pull-down menu appears.

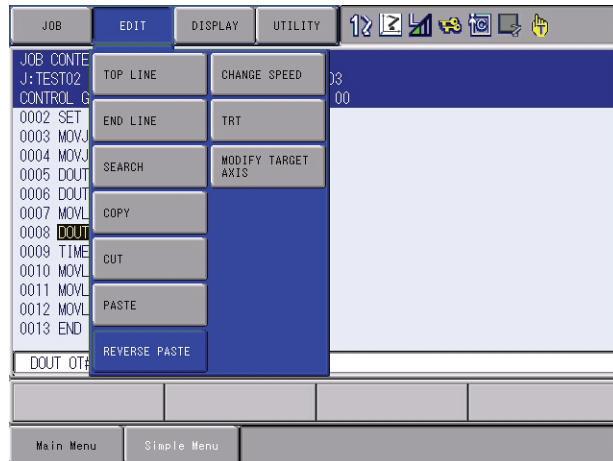

3. Select {REVERSE PASTE}.
 - The confirmation dialog box appears.
 - When “YES” is selected, the contents of the buffer are reverse pasted to the job.
 - When “NO” is selected, the reverse-pasting operation is cancelled.

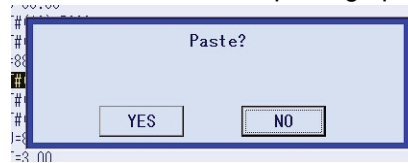

3.8 Test Operations

Playback operations can be simulated in the teach mode with test operations. This function is convenient for checking continuous paths and operation instructions.

Test operation differs in the following ways from actual playback in the play mode.



- Operation speeds greater than the maximum teaching speed are reduced to the maximum teaching speed.
- Only machine lock is available among special operations for playback in the play mode.
- Work instruction output, such as arc output, is not executed.

3.8.1 Test Operation Procedures

Test operation is performed by pressing [INTERLOCK] and [TEST START]. For safety purposes, these keys will only function while the keys are held down.

1. Select {JOB} under the main menu.
2. Press {JOB}.
 - The test operation JOB CONTENT window appears.
3. Press [INTERLOCK] + [TEST START].
 - The manipulator starts the test cycle operation.
 - The manipulator moves only while these keys are held down. However, after the operation starts, the motion continues even if [INTERLOCK] is released.
 - The manipulator stops immediately when [TEST START] is released.



Always check safety conditions before starting the manipulator in motion.

3.9 Other Job-editing Functions

3.9.1 Editing Play Speed

There are two ways to modify play speed:

- Modification of Speed Type
- Relative Modification

3.9.1.1 Modification of Speed Type

This method is used to modify the speed type (such as VJ, V, VR, etc.)

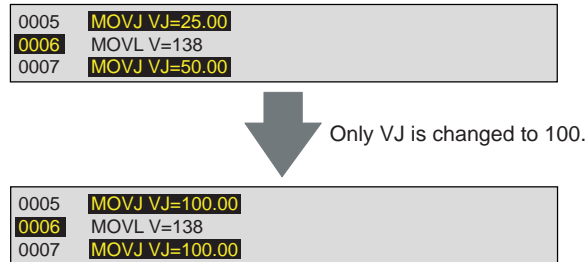

Type of Play Speed	Explanation	
VJ	Joint Speed	Normal robot axes
V	TCP Speed	
VR	Posture Angle Speed	
VE	Base Axis Speed	

3.9.1.2 Relative Modification

All steps are selected regardless of the play speed type. This method is used to change all steps by a specified percentage (1% to 200%). This is called relative modification.

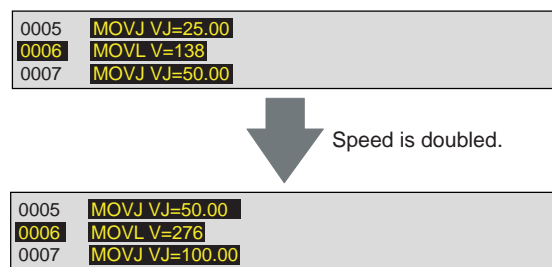

The speed of the entire job or specified section can be changed.

1. Select {JOB} under the main menu.
2. Select {JOB}.
 - The JOB CONTENT window appears.
3. Move the cursor to the instruction area.
4. Press [SHIFT] + [SELECT] in the speed modify start line.
 - If the section is not specified, the speed of the entire job will be changed.
 - Move the cursor to the end line. The line numbers of the selected lines are highlighted.

5. Select {EDIT} under the menu.
6. Select {CHANGE SPEED}.
 - The SPEED MODIFICATION window appears.

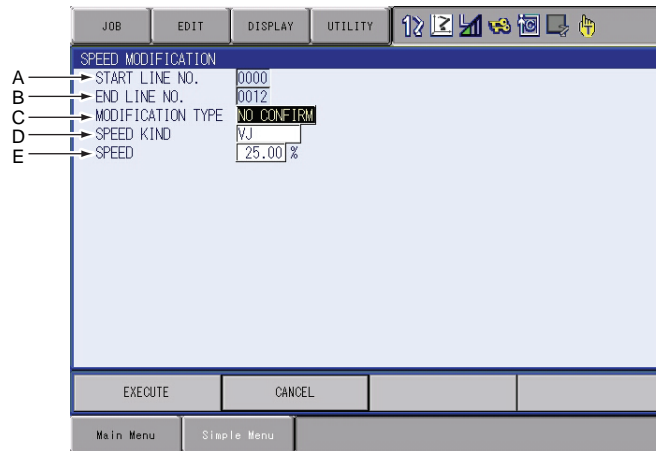

7. Set desired items.

A. START LINE NO.

Displays the first line number of the section to be modified.

B. END LINE NO.

Displays the last line number of the section to be modified.

C. MODIFICATION TYPE

Selects the confirmation before changing: “CONFIRM” or “NO CONFIRM.”

Each time [SELECT] is pressed when the cursor is on this item, the setting alternates between “CONFIRM” and “NO CONFIRM.”

D. SPEED KIND

Selects the speed type.

When [SELECT] is pressed when the cursor is on this item, selection dialog box appears. Select the speed type to be changed.

E. SPEED

Specifies the speed value.

When [SELECT] is pressed when the cursor is on this item, the mode changes to the number input mode. Input the speed value and press [ENTER].

8. Select “EXECUTE.”

- The speed begins to change.
- If “MODIFICATION TYPE” is set to “CONFIRM,” the confirmation dialog box “Modifying speed” is displayed. Press [ENTER] to change the speed on the first line and search for the next speed. Press the UP/DOWN cursor button to keep the speed on the first line and search for the next speed. To cancel the speed modification, press [CANCEL].
- If “MODIFICATION TYPE” is set to “NOT CONFIRM,” all the speeds of the specified section are changed.

3.9.1.3 Modification by TRT (Traverse Time)

Modifications made by TRT have the following characteristics:

- By setting the time required to execute a move instruction (moving time) to a desired value, the speeds can be modified.
- It is possible to measure the moving time without actually moving the manipulator.

For example, when the movement from lines 5 through 20 currently requires 34 seconds, and you want to reduce it to 15 seconds or extend it to 50 seconds, this function is used.

1. Select {JOB} under the main menu.
2. Select {JOB}.
 - The JOB CONTENT window appears.
3. Move the cursor to the instruction area.
4. Press [SHIFT] + [SELECT] in the weaving time measure start line.
 - Move the cursor to the end line. The line numbers of the selected lines are highlighted.
5. Select {EDIT} under the menu.
6. Select {TRT}.
 - The TRT window appears.

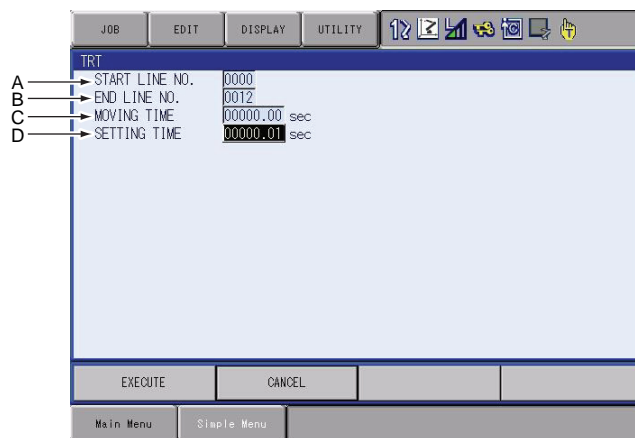

7. Set the desired items.

A. START LINE NO.

Displays the first line number of the section to be measured and modified.

B. END LINE NO.

Displays the last line number of the section to be measured and modified.

C. MOVING TIME

The weaving time needed to move from the first number to last number is measured and displayed.

D. SETTING TIME

Set the desired weaving time.

When [SELECT] is pressed when the cursor is on this item, the input buffer line appears. Input the desired weaving time and press [ENTER].

8. Select "EXECUTE."

- The speed is changed according to the setting.



- If instructions that include specific speed data such as SPEED or ARCON instructions (including speed data of the welding condition file) exist in the specified section, the speed data for those steps are not changed. Therefore, in such cases, the set time and the actual time required are not same.
- If the speed data is limited by the maximum value, the following message is displayed.

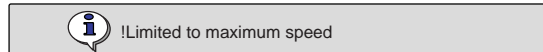

3.9.2 Editing Interpolation Type

1. Select {JOB} under the main menu.
2. Select {JOB}.
 - The JOB CONTENT window appears.
3. Move the cursor to the instruction area.
4. Select the line to be modified.
 - The instruction on the cursor is displayed in the input buffer line.

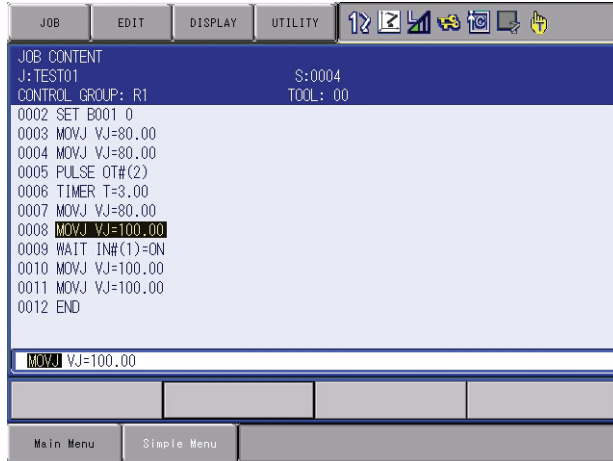

5. Press [SHIFT] + the cursor key simultaneously.
 - The interpolation type in the input buffer line changes.
 - The modification of the speed according to the modification of the interpolation type is calculated by the ratio to maximum speed at each speed.
 - Joint Speed: MAX=100.0%
 - Linear Speed: MAX=9000cm/min
 - (e.g.)
 - Joint Speed: 50% = Linear Speed: 4500cm/min
 - Linear Speed: 10% = Linear Speed: 900cm/min



6. Press [ENTER].
 - The instruction on the cursor line is replaced with one on the input buffer line.

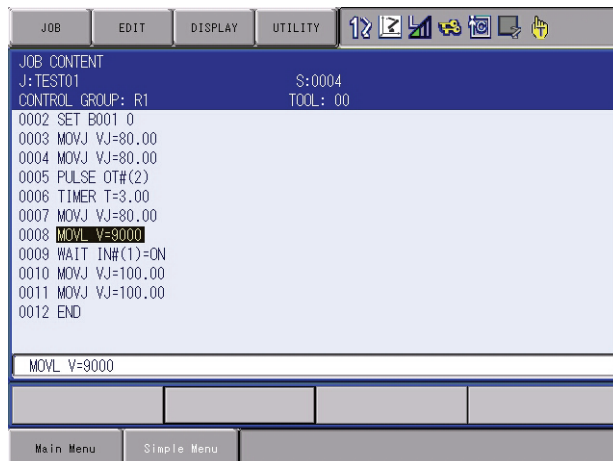

3.9.3 Editing Condition Files

Condition files are prepared in order to set the conditions for the manipulator to execute instructions.

Multiple condition files are provided for each application. More than one pattern can be set up in each condition file. The patterns are listed by "condition numbers." This number is specified by the work instruction in a job.



Refer to DX100 Operator's Manual of each application for information regarding the contents and editing methods of the condition file.

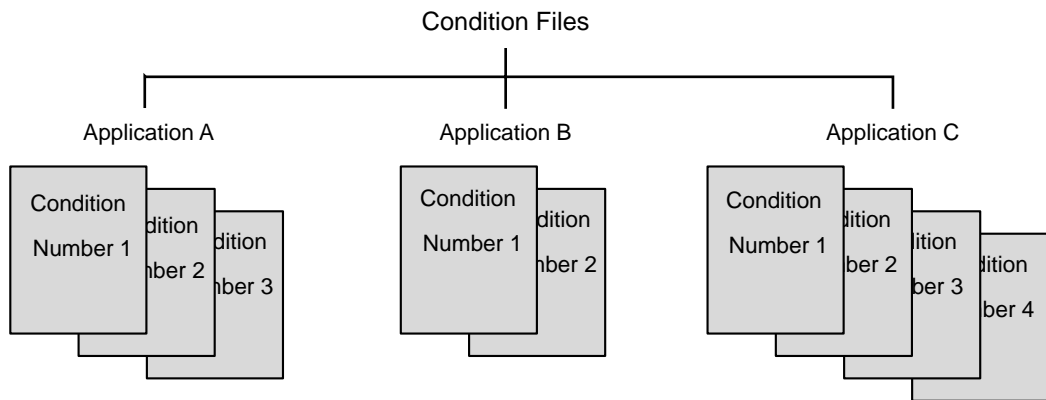

3.9.4 User Variables

User variables are used for jobs to store counters, calculation results or input signals. Since the same user variable can be used in multiple jobs, save the numerical values as common references for the jobs and the user variables are maintained even when the power is turned OFF.

User variables have the following applications:

- Controlling of the number of workpieces
- Controlling of the number of jobs
- Sending/receiving of information between jobs

The data formats for user variables are described in the following table:

Table 3-5: User Variables

Data Format	Variable No. (pcs)	Functions
Byte Type	B000 to B099 (100)	Range of storable values is from 0 to 255. Can store I/O status. Can perform logical operations (AND, OR, etc.)
Integer Type	1000 to 1099 (100)	Range of storable values is from -32768 to 32767.
Double Precision Integer Type	D000 to D099 (100)	Range of storable values is from -2147483648 to 2147483647.
Real Type	R000 to R099 (100)	Range of storable values is from -3.4E+38 to 3.4E38. Accuracy: $1.18E-38 < x \leq 3.4E38$
Character Type	S000 to S099 (100)	Maximum storable number of characters is 16.
Position Type	P000 to P127 (128)	Can store position data in pulse form or in XYZ form. XYZ type variable can be used as target position data for move instructions, and as incremental values for parallel shift instructions.
	BP000 to BP127 (128)	
	EX000 to EX127 (128)	

• **Play Speed V:**

MOVL V=I000

The variable I000 is used for speed V with this move instruction.

The unit for V is 0.1mm per second.

For example, if I000 were set as 1000, the following would be true:

I000=1000 → unit for V is 0.1mm/s → V=100.0mm/s

Note that, depending on the unit being used, the value of the variable and the value of the actual speed on occasion might not match.



• **Play Speed VJ:**

MOVL VJ=I000

The unit for VJ is 0.01%.

For example, if I000 were set as 1000, the following would be true:

I000=1000 → unit for VJ is 0.01% → VJ=10.00%.

• **Timer T:**

TIMER T=I000

The unit for T is 0.01 seconds.

For example, if I000 were set as 1000, the following would be true:

I000=1000 → unit for T is 0.01 seconds → T=10.00 seconds.

3.9.4.1 Setting Byte, Integer, Double Precision Integer, and Real Type Variables

1. Select {VARIABLE} under the main menu.
 - {BYTE}, {INTEGER}, {DOUBLE}, and {REAL} are displayed for the sub menu.
2. Select desired variable type.
 - The BYTE VARIABLE window appears. (Following is a case that {BYTE} is selected.)

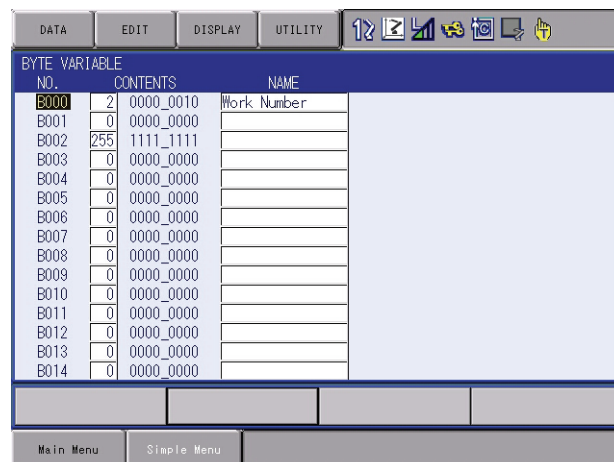

3. Move the cursor to the desired variable No.

- When the desired variable number is not displayed, move the cursor with either of the following operations.
 - Move the cursor on the variable No. and press [SELECT]. Then input the variable No. using the Numeric keys and press [ENTER].
 - Move the cursor to the menu area and select {EDIT} → {SEARCH}. Then input the variable No. with the Numeric keys and press [ENTER]

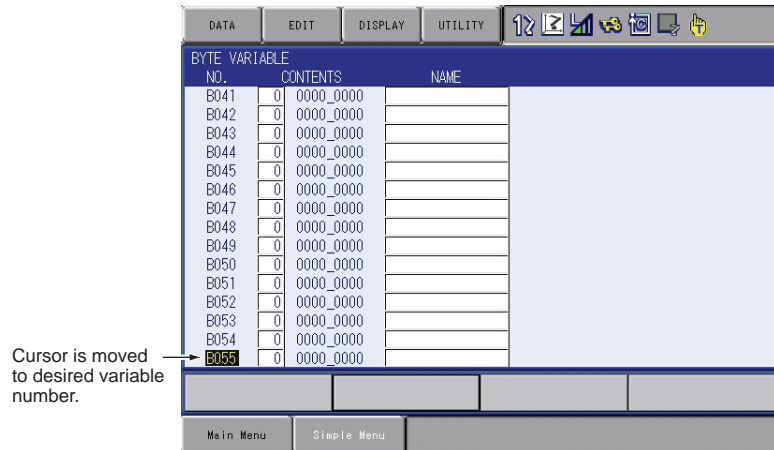

4. Move the cursor to the data of the variable.

- The number can be directly typed.

5. Input the desired number.

6. Press [ENTER].

- Input value is set to the variable on the cursor position.



3.9.4.2 Setting Character Type Variables

1. Select {VARIABLE} under the main menu.
2. Select {STRING}.
 - The STRING VARIABLE window appears.

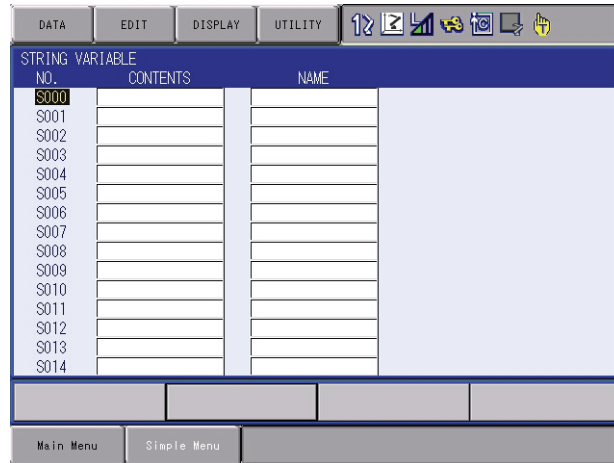

3. Move the cursor to the desired variable No.
 - When the desired variable number is not displayed, move the cursor with either of the following operations.
 - Move the cursor on the variable No. and press [SELECT]. Then input the variable No. using the Numeric keys and press [ENTER].
 - Move the cursor to the menu area and select {EDIT} → {SEARCH}. Then input the variable No. with the Numeric keys and press [ENTER]

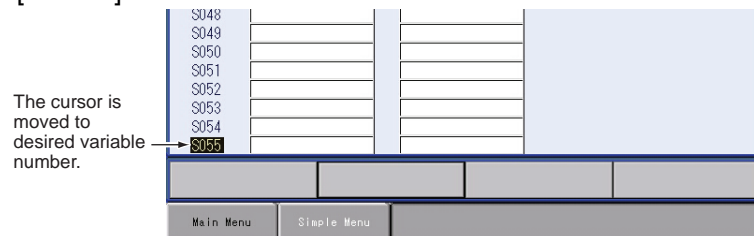

4. Move the cursor to the data of the variable.
 - The characters can be directly typed.
5. Input the desired characters.
 - For information on character input operation, refer to *chapter 1.2.6 "Character Input Operation" at page 1-18.*
6. Press [ENTER].
 - The input characters are set to the variable on the cursor position.

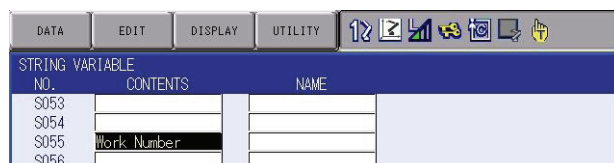

3.9.4.3 Registering Variable Name

1. Select {VARIABLE} under the main menu.
2. Select desired variable.
 - Select any variable type from among byte type, integer type, double precision integer type, real type, robot position type, base position type, and station position type.
3. Move the cursor to desired variable number.
 - If desired variable number is not displayed, move the cursor by either of following operations.
 - Select the variable number, input desired variable number and press [ENTER]. The cursor moves to the variable number to be input.
 - Move the cursor to the menu area and select {EDIT}→{SEARCH}. Input desired variable number and press [ENTER]. The cursor moves to the variable number to be input.
4. Select “NAME.”
 - The input buffer line appears.



Refer to *chapter 1.2.6 "Character Input Operation"* at *page 1-18* for the character input operation.



5. Input name.
6. Press [ENTER].
 - The variable name is registered.

INTEGER VARIABLE		
NO.	CONTENTS	NAME
I000	0	
I001	0	Work Name
I002	0	

3.9.4.4 Displaying Position Variables

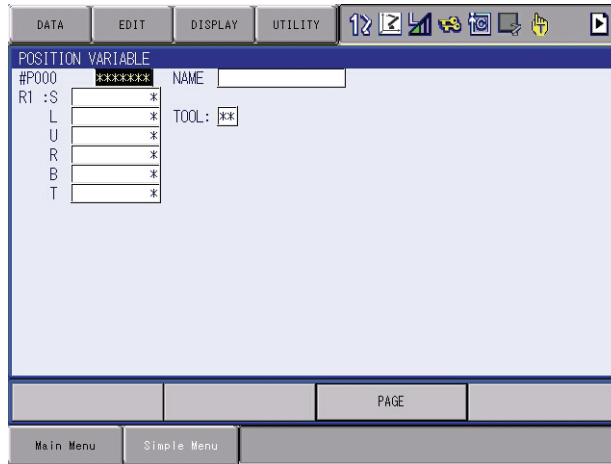
1. Select {VARIABLE} under the main menu.
2. Select desired position variable type.
 - The POSITION VARIABLE window of desired type among robot type, base type, and station type appears.



3. Press the page key  or [SHIFT] + page key  .
 - When the desired variable number is not displayed, move the cursor with either of the following operations.
 - Press [DIRECT PAGE]. Then input the variable No. using the Numeric keys and press [ENTER].
 - Move the cursor to the menu area and select {EDIT} → {SEARCH}. Then input the variable No. with the Numeric keys and press [ENTER].



3.9.4.5 Setting Position Variables

The following table shows the types of position variables and setting methods.

NOTE

- The setting of position variables is done in the teach mode.
- Turn the servo power ON when setting the variables with the axis keys.

Table 3-6: Types of Position Variables and Setting Method

Type	Pxxx (Robot)		BPxxx (Base)		EXxxx (Station)
	Pulse Type	XYZ Type	Pulse Type	XYZ Type	Pulse Type
Setting Method		Select coordinates from base, robot, user, tool.			
	Using the numeric keys				
	Using the axis keys				

3.9.4.6 Setting Position Variables Using the Numeric Keys

■ Pulse Type

1. Select {VARIABLE} under the main menu.
2. Select desired position variable type.
 - The desired variable window appears (robot, base, or station). (The POSITION VARIABLE window is used for this example.)

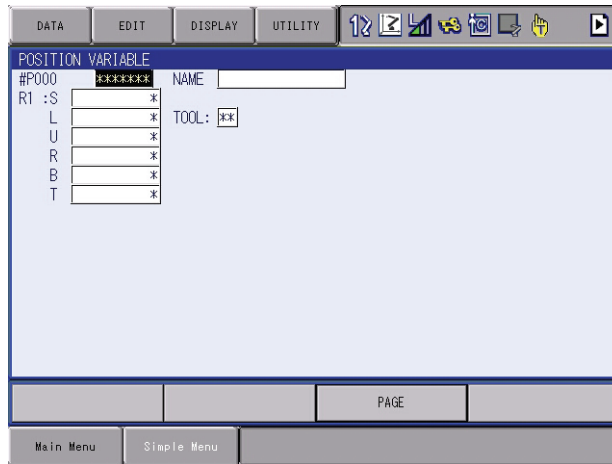

3. Select the variable data type.
 - The selection dialog box appears.



- If the position variable was set before, confirmation dialog box appears for data clear. If "YES" is selected, the data is cleared.

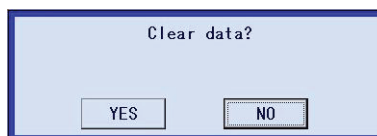

4. Select {PULSE}.
5. Move the cursor to desired data to be input and press [SELECT].
6. Input the value.
7. Press [ENTER].
 - The value is set in the cursor position.



■ XYZ Type

1. Select {VARIABLE} under the main menu.
2. Select desired position variable type.
3. Select the variable data type.
 - The selection dialog box appears.



4. Select desired coordinates except PULSE.
5. Move the cursor to desired data to be input and press [SELECT].
6. Input the value.
7. Press [ENTER].
 - The value is set in the cursor position.

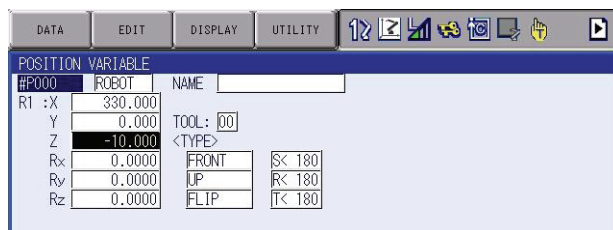

(1) Setting of “<TYPE>”

- Each time [SELECT] is pressed when the cursor is on the setting data in the input buffer line, the settings alternate.



About “<TYPE>”

- It is not necessary to set a type if the position variable is to be used for parallel shift operations.
- When the position variable is used with a move instruction such as “MOVJ P001,” it is necessary to set a type. For details on types, refer to *chapter 3.9.4.10 “Manipulator Types” at page 3-82*. Current Position Window (XYZ) shows the current setting of a type.

3.9.4.7 Setting Position Variables Using the Axis Keys

■ Pulse Type

1. Select {VARIABLE} under the main menu.
2. Select desired position variable type.
 - The desired variable window appears (robot, base, or station).
3. Press [SHIFT] + [ROBOT]. When you need an external axis position, press [SHIFT]+[EX.AXIS].
 - (1) When there are two or more robot, base, or a station, specify the axis with following operation.
 - **Robot**
Each time [SHIFT] + [ROBOT] is pressed, the axis displayed on the status line changes:
R1 → R2 → ... → R8.
 - **Base or Station**
Each time [SHIFT]+[EX.AXIS] is pressed, the axis displayed on the status line changes:
B1 → B2 → ... → B8 → S1 → S2 → → S24.
 - (2) Check the selected axis on the status line.
4. Move the manipulator with the axis keys.
 - Move the manipulator or the external axis to the desired position to be set to position variable.
5. Press [MODIFY].
6. Press [ENTER].

■ XYZ Type

1. Select {VARIABLE} under the main menu.
2. Select desired position variable type.
 - (1) When there are two or more robot, base, or a station, specify the axis with following operation.
 - **Robot**
Each time [SHIFT] + [ROBOT] is pressed, the axis displayed on the status line changes:
R1 → R2 → ... → R8.
 - **Base or Station**
Each time [SHIFT]+[EX.AXIS] is pressed, the axis displayed on the status line changes:
B1 → B2 → ... → B8 → S1 → S2 → → S24.
 - (2) Check the selected axis on the status line.
3. Move the manipulator with the axis keys.
 - Move the manipulator or the external axis to the desired position to be set to position variable.
4. Press [MODIFY].
5. Press [ENTER].

3.9.4.8 Deleting Data Set of Position Variables

1. Select {VARIABLE} under the main menu.
2. Select desired position variable type.
3. Select {DATA} under the menu.
 - The pull-down menu appears.

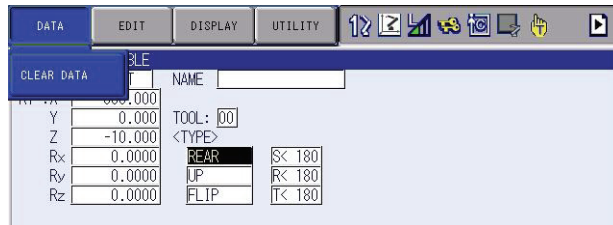

4. Select {CLEAR DATA}.
 - The position variable data on the displayed page are deleted.



3.9.4.9 Checking Positions by Position Variables

1. Select {VARIABLE} under the main menu.
2. Select desired position variable type.
 - (1) When there are two or more robot, base, or a station, specify the axis with following operation.
 - **Robot**
Each time [SHIFT] + [ROBOT] is pressed, the axis displayed on the status line changes:
R1 → R2 → ... → R8.
 - **Base or Station**
Each time [SHIFT]+[EX.AXIS] is pressed, the axis displayed on the status line changes:
B1 → B2 → ... → B8 → S1 → S2 → → S24.
 - (2) Check the selected axis on the status line.
3. Press [FWD].
 - Selected axis moves to the position specified by the variable.



The selected axis (manipulator, base, or station) moves directly to the set variable position.
Before pressing [FWD], check that the surrounding area is safe.

3.9.4.10 Manipulator Types

When the position data of the job data are described using the XYZ format, several postures may be taken according to the manipulator's structure when moving it to the described position.

Although these postures have the same coordinates for TCP, they vary in pulse for each axis.

Thus, the manipulator's posture cannot be uniquely defined only by the coordinate value, and it is necessary to specify the data other than the coordinate value to define the manipulator's posture.

This is called "Type."

Type varies according to the manipulator model.

For the manipulator with seven axes, X, Y, Z, Rx, Ry, Rz, Re and Type are used.

Re is an element to indicate the posture of the manipulator with seven axes and does not change by the specified coordinates.

The definition of Re is shown below.

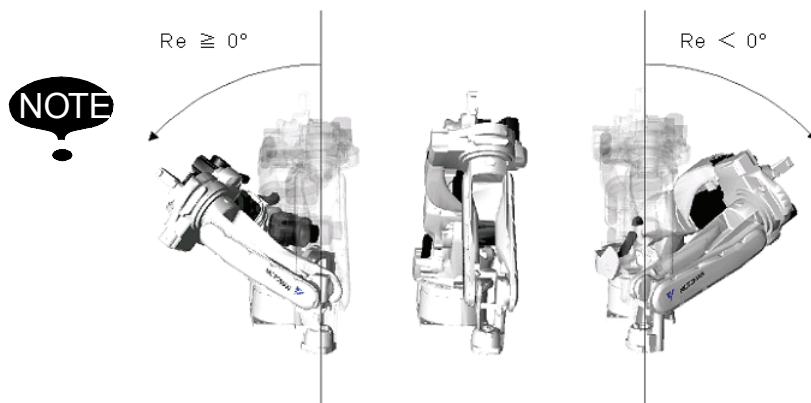

3.9.5 Flip/No Flip

When the angle of B-axis is within (+) range ($\theta_B \geq 0^\circ$), it is called "Flip", and when within (-) range ($\theta_B < 0^\circ$), "No Flip."

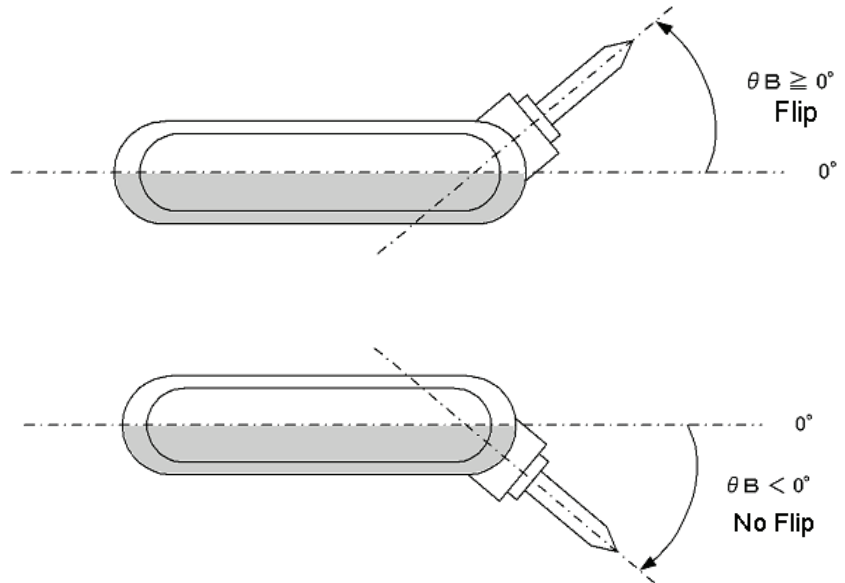
**3.9.6 R-axis Angle**

This specifies whether the R-axis angle is less than $\pm 180^\circ$ or greater than $\pm 180^\circ$.

$R < 180^\circ$	$R \geq 180^\circ$
$-180 < \theta_R \leq 180$	$180 < \theta_R \leq 360, -360 < \theta_R \leq -180$



θ_R is the angle when the R-axis home position is 0° .

3.9.7 T-axis Angle

This specifies positions of the R-, B-, and T-axis.
For manipulators with wrist axes (three axes), this specifies whether the T-axis angle is less than $\pm 180^\circ$ or greater than $\pm 180^\circ$.

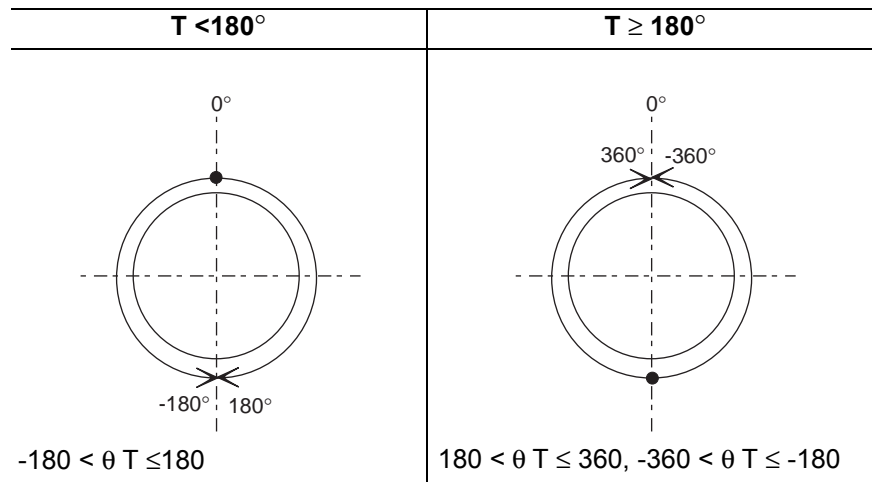

θT is the angle when the T-axis home position is 0° .

3.9.8 Front/Back

This specifies where in the S-axis rotation center the B-axis rotation center locates when viewing the L-axis and U-axis from the right-hand side.
When viewed from the right-hand side, the right of the S-axis rotation center is called the front, and the left is called the back.

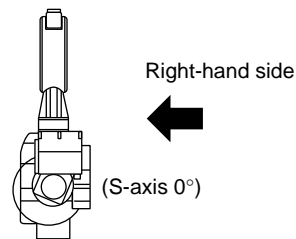

The diagram below shows the S-axis at 0° and at 180°. This is the configuration when the L-axis and the U-axis are viewed from the right-hand side.

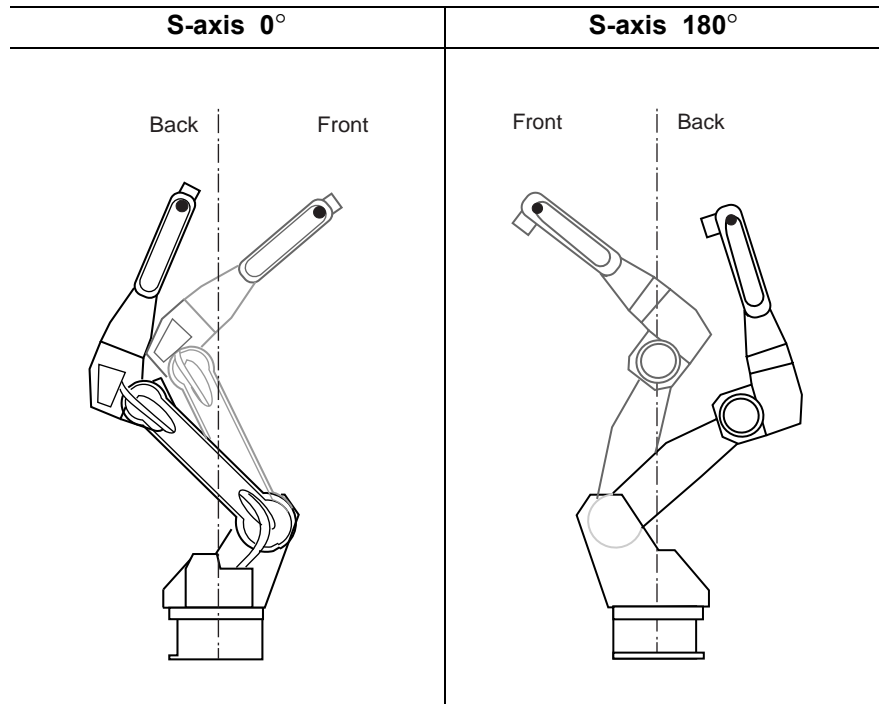

For the manipulator with seven axes, this specifies where in the S-axis rotation center the U-axis rotation center locates when viewing the L-axis and U-axis from the right-hand side.

When viewed from the right-hand side, the right of the S-axis rotation center is called the front, and the left is called the back.

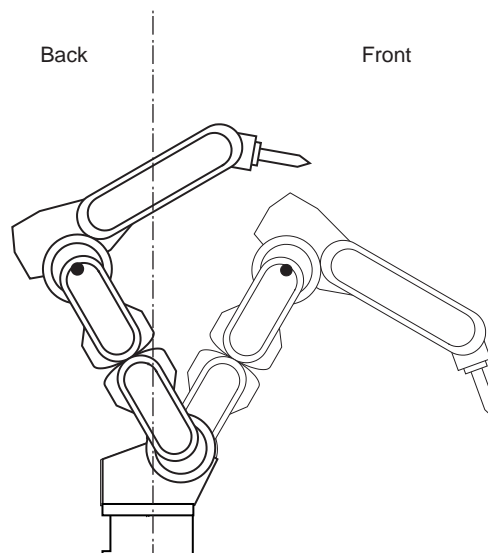

3.9.9 Upper Arm/Lower Arm

This specifies a type comprised of L-axis and U-axis when the L-axis and U-axis are viewed from the right-hand side.

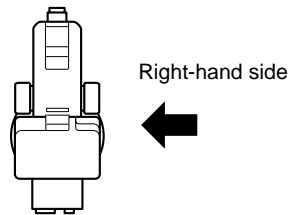

Upper Arm	Lower Arm

3.9.10 S-axis Angle

This designation is required for the manipulators which have working envelopes greater than $\pm 180^\circ$.

This specifies whether the S-axis angle is less than $\pm 180^\circ$ or greater than $\pm 180^\circ$.

S < 180°	S ≥ 180°
<p>$-180^\circ < \theta S \leq 180^\circ$</p>	<p>$180^\circ < \theta S \leq 360^\circ$ $-360^\circ < \theta S \leq -180^\circ$</p>

NOTE θS is the angle when the S-axis home position is 0° .

3.9.11 Editing Local Variables

As well as user variables, local variables can be used for the storage of counters, calculations, and input signals. The data format is the same as that of user variables. As shown in the following table, the letter L is affixed to the variable number to indicate a local variable.

Table 3-7: Local Variables

Data Format		Variable No.	Functions
Byte Type		LB000 to LB□□□	Range of storable values is from 0 to 255. Can store I/O status. Can perform logical operations (AND, OR, etc.)
Integer Type		LI000 to LI□□□	Range of storable values is from -32768 to 32767.
Double Precision Integer Type		LD000 to LD□□□	Range of storable values is from -2147483648 to 2147483647.
Real Type		LR000 to LR□□□	Range of storable values is from $-3.4E+38$ to $3.4E+38$ Accuracy: $1.18E-38 < x \leq 3.4E+38$
Character Type		LS000 to LS□□□	Maximum storable number of characters is 16.
Position Type	Robot Axes	LP000 to LP□□□	Can store position data in pulse form or in XYZ form. XYZ type variables can be used as target position data for move instructions, and as incremental values for parallel shift instructions.
	Base Axes	LBP000 to LBP□□□	
	Station Axes	LEX000 to LEX□□□	

Local variables differ from user variables in the following four ways:

- **Used in One Job Only**

With user variables it is possible to define and use one variable in multiple jobs, but local variables are used only in the job in which they are defined, and cannot be read from other jobs. Accordingly, local variables do not affect other jobs, so it is possible to define a variable number (such as LB001) separately in different jobs, and use it in different ways in each of these jobs.

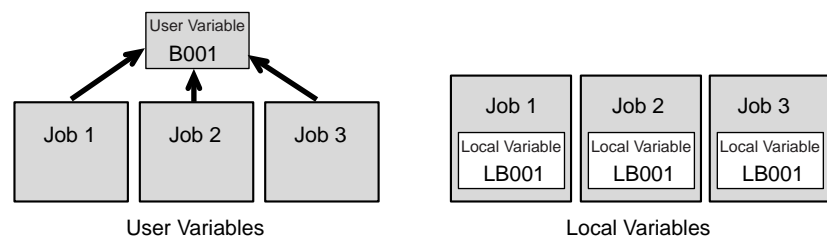

- **Able to Use Any Number of Variables**

The number is set in the JOB HEADER window. When the number is set, the area for the value is saved in memory.

- **Not Able to Display the Variable Contents**

To display the local variable contents, user variables are needed. For example, to view the contents of local variable LP000, save it temporarily as user variable P001. Then execute the instruction SET P001 LP000, and view the POSITION VARIABLE window for P001.

- **Enabled Only During the Execution of the Defined Job**

The contents of the local variables are enabled only during the execution of the defined job.

The local variable field is assured when the defined job is called (when the job is executed by a CALL or JUMP instruction, or the job is selected by the menu). Once the job is completed by the execution of a RET, END, or JUMP instruction, the local variable data that was set is disabled. However, if a job which uses local variables itself calls a separate job, then is returned by use of a RET instruction, the data that was present prior to the CALL instruction remains in effect and can be used.



Precautions for Variables and Units

As was the case with user variables, note that, depending on the value of the unit being used, the value of the variable and the value of the actual speed or time an occasion might not match. Refer to *chapter 3.9.4 "User Variables" at page 3-71*.

3.9.11.1 Setting the Number of Local Variables

The number of local variables used in a job is set in the JOB HEADER window. When the number of local variables is set, memory is allocated for those variables.



Only when expanding the “INSTRUCTION LEVEL,” it is possible to use local variables. Refer to “8.12 Instruction Level Setting” of “DX100 INSTRUCTIONS” (RE-CTO-A215) for details on setting the language level.

1. Select {JOB} under the main menu.
2. Select {JOB}.
3. Select {DISPLAY} under the menu.
4. Select {JOB HEADER}.
 - The JOB HEADER window appears. Scroll the window using the cursor.

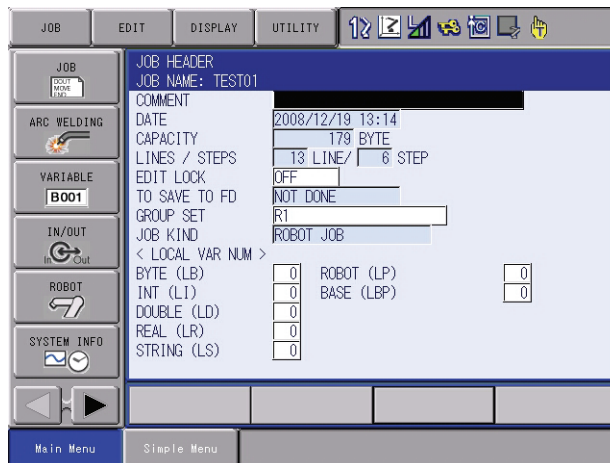

5. Select the number of local variables to be set.
 - The input buffer line appears.
6. Input the number of variables.
7. Press [ENTER].
 - The number of local variables are set.

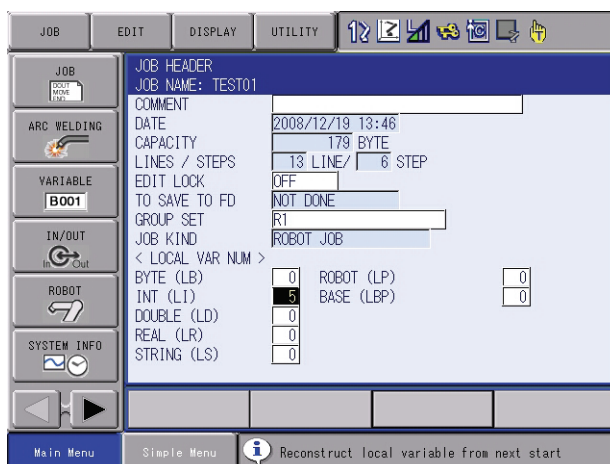

3.9.12 Search

When editing or checking, jobs and steps can be searched for. Search can be done when the cursor is in either the address or instruction area on the JOB CONTENT window.

1. Select {JOB} under the main menu.
2. Select {JOB}.

 - The JOB CONTENT window appears.

3. Select {EDIT} under the menu.

 - The pull-down menu appears.

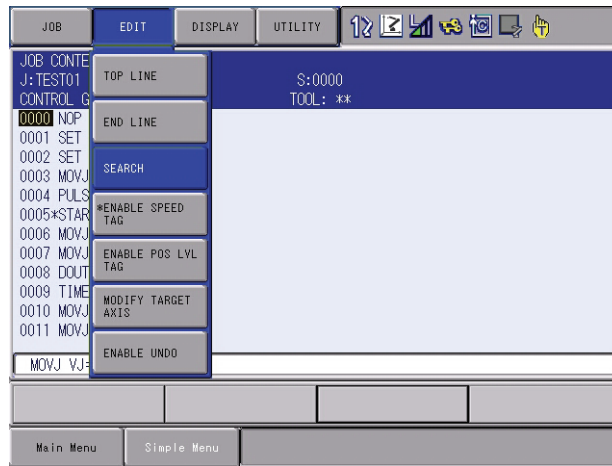

4. Select {SEARCH}.

 - The selection dialog box appears.

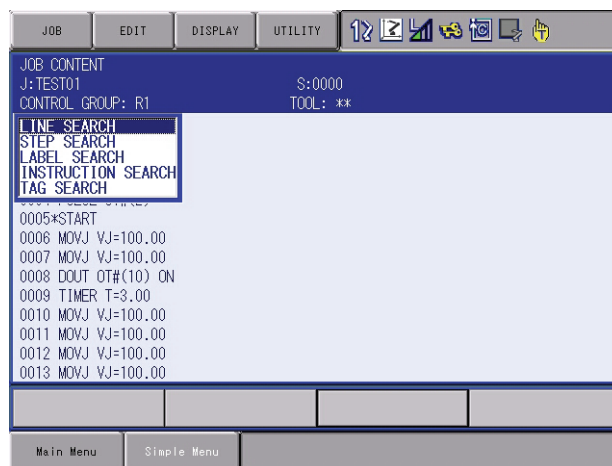

5. Select the search type.

Search is an operation by which the cursor is moved to a specific step or instruction in the edit job. The desired item can be instantly searched for without using the cursor.

3.9.12.1 Line Search

This function moves the cursor to the desired line number.

1. Select {EDIT}, {SEARCH} and “LINE SEARCH.”

– The number can be entered.

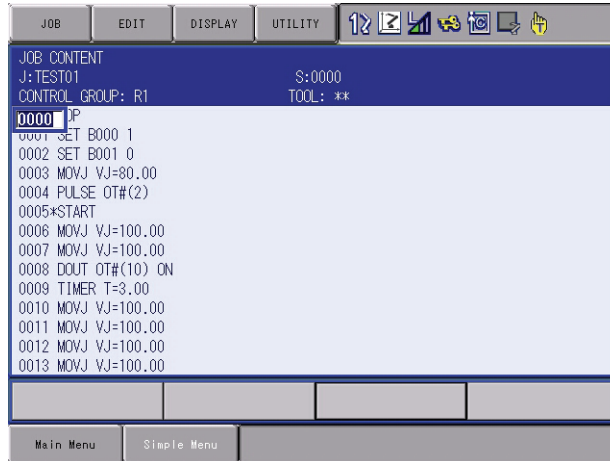

2. Input desired line number.

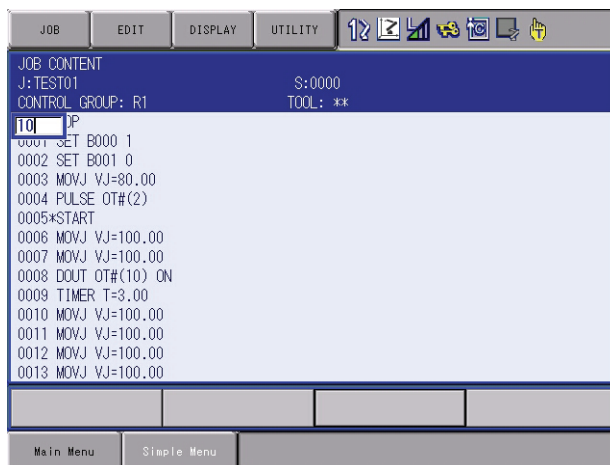

3. Press [ENTER].

– The cursor is moved to the line number and the window appears.

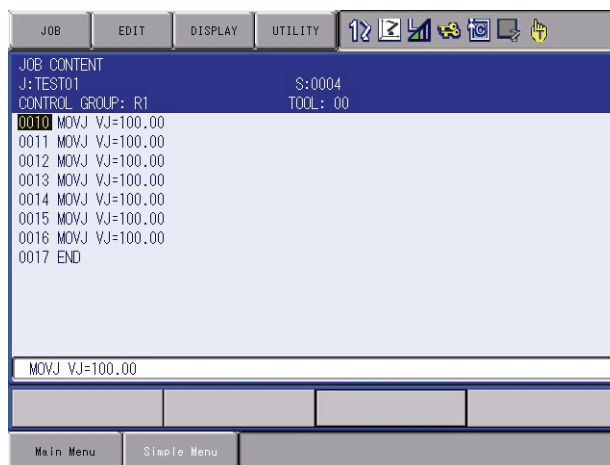

3.9.12.2 Step Search

This function moves the cursor to the desired step number (move instruction).

1. Select [EDIT], [SEARCH] and “STEP SEARCH.”
 - The number can be entered.

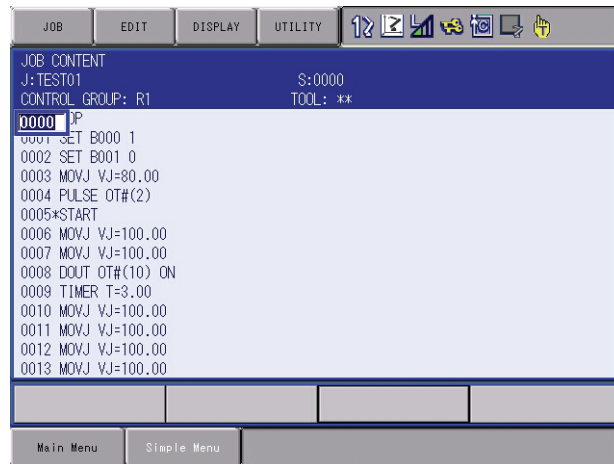

2. Input desired step number.

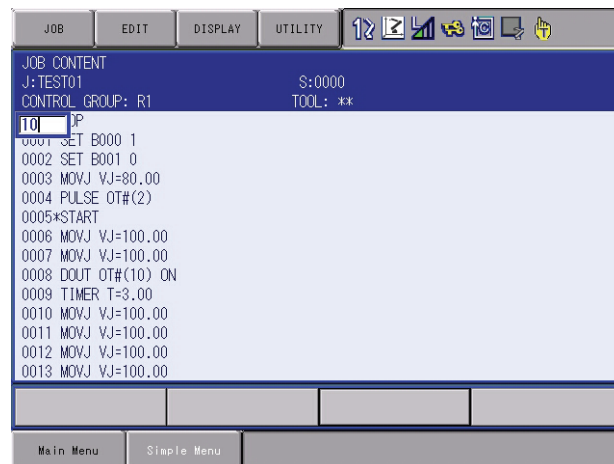

3. Press [ENTER].
 - The cursor is moved to the input step and the window appears.

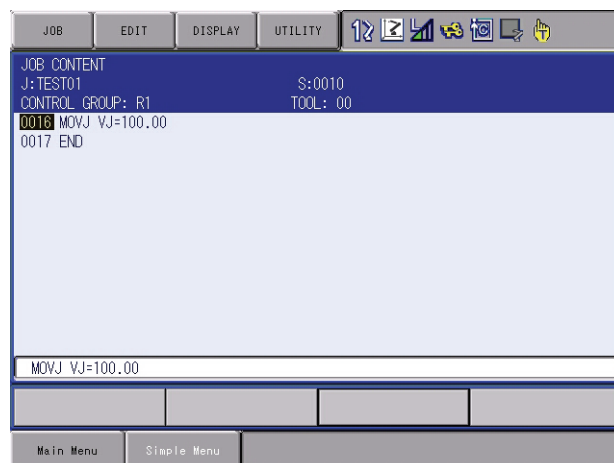

3.9.12.3 Label Search

This function searches for the desired label and the instruction using that label.

1. Select {EDIT}, {SEARCH} and "LABEL SEARCH."
 – The characters can be entered.
2. Input desired label name.
 – For information on character input operation, refer to *chapter 1.2.6 "Character Input Operation" at page 1-18.*
 – At this time, search can be conducted by entering any one character of the label. For example, to search for the "START" label, enter only "S," and the search can be done.

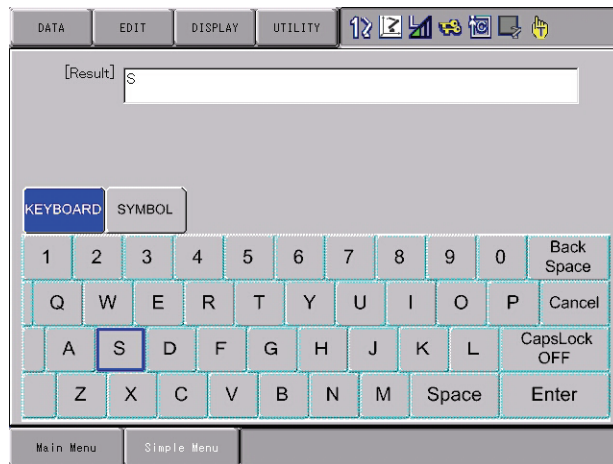

3. Press [ENTER].

- The cursor is moved to the desired label and the window appears.

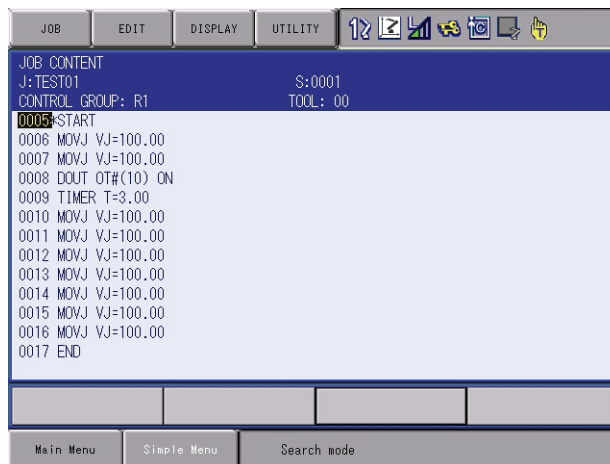

4. Use the cursor to continue search.
- While searching, forward search and backward search are possible by pressing the cursor key.
 - To end search, select {EDIT} → {END SEARCH} on the menu and press [SELECT].

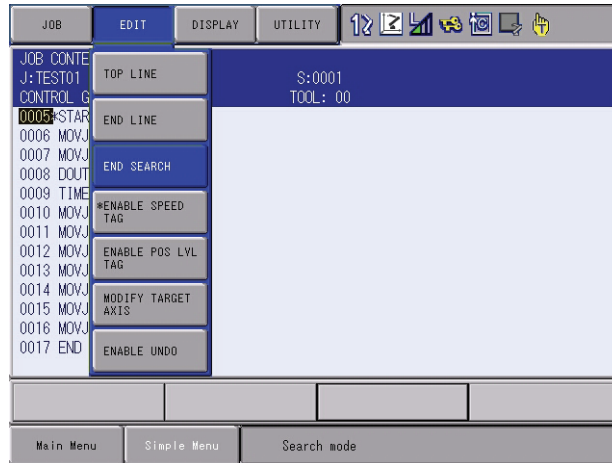

3.9.12.4 Instruction Search

This function moves the cursor to a desired instruction.

1. Select {EDIT}, {SEARCH} and “INSTRUCTION SEARCH.”
 - The INFORM command list appears.

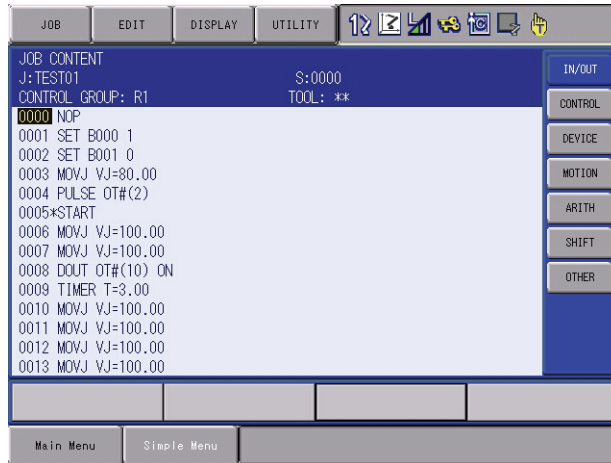

2. Select desired instruction group.
3. Select desired instruction.

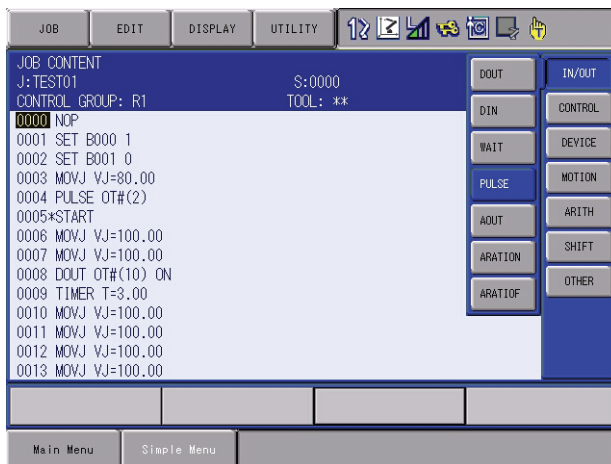

- The cursor is moved to the selected instruction and the window appears.

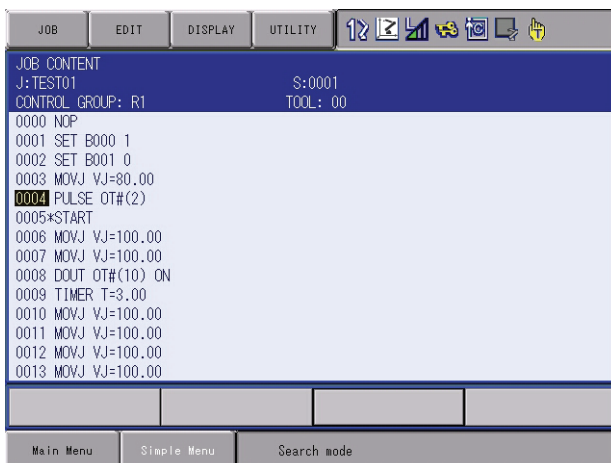

4. Use the cursor to continue search.
- While searching, forward search and backward search are possible by pressing the cursor key.
 - To end search, select {EDIT} → {END SEARCH} on the menu and press [SELECT], or press [CANCEL].

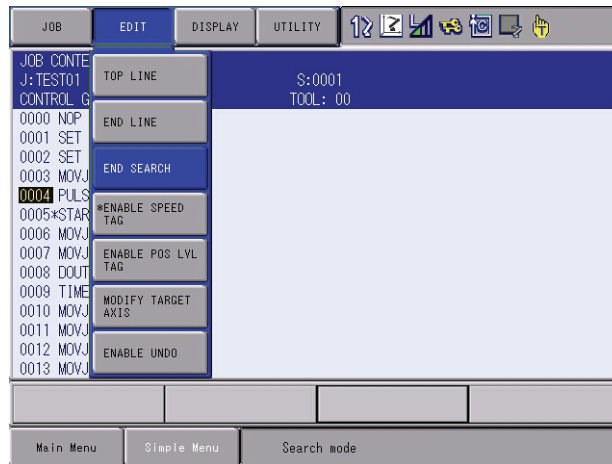

3.9.12.5 Tag Search

This function moves the cursor to the desired tag.

1. Select {EDIT}, {SEARCH} and “TAG SEARCH.”

– The instruction list dialog box appears.

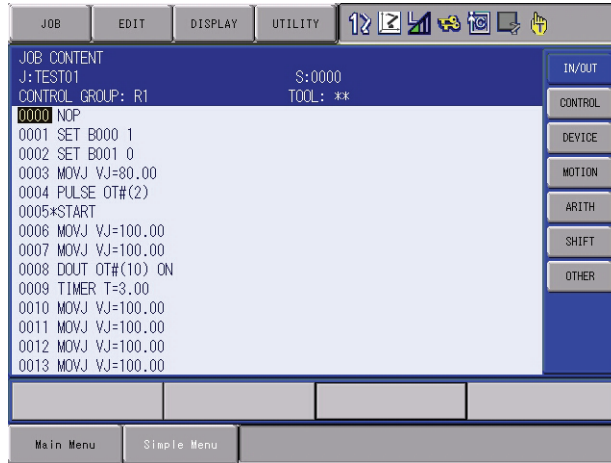

2. Select desired instruction group.

3. Select desired instruction for which the tag is to be searched.

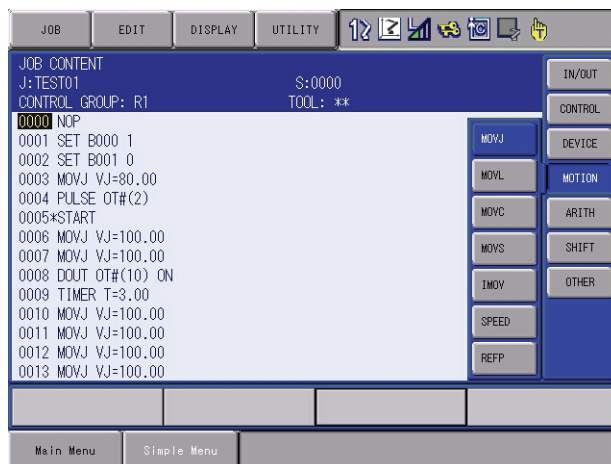

– The tag list dialog box for selected instruction appears.

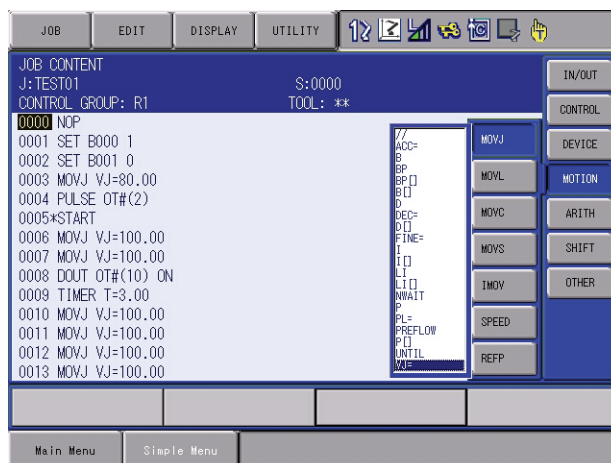

4. Select the desired tag.

- The cursor is moved to the selected tag and the window appears.

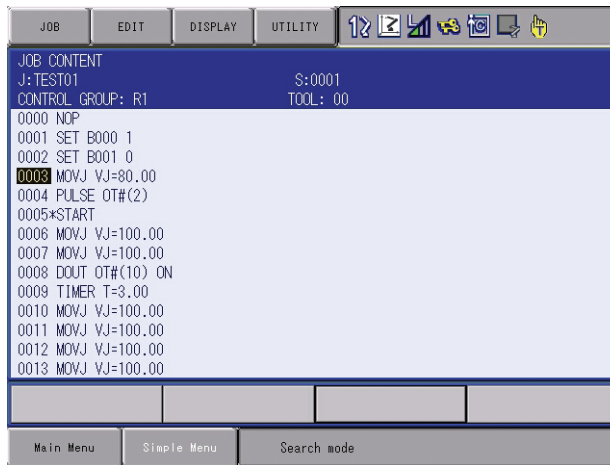

5. Use the cursor to continue search.

- While searching, forward search and backward search are possible by pressing the cursor key.
- To end search, select {EDIT} → {END SEARCH} on the menu and press [SELECT], or press [CANCEL].

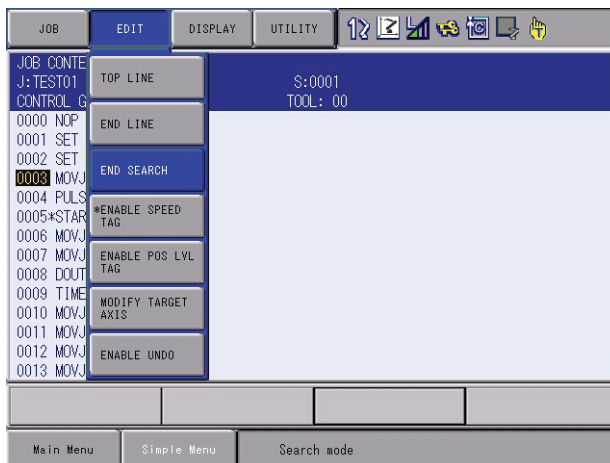

4 Playback

4.1 Preparation for Playback

4.1.1 Selecting a Job

Playback is the act of executing a taught job. Before playback operation, first call the job to be executed.

4.1.1.1 Calling a Job

1. Select {JOB} under the main menu.
2. Select {SELECT JOB}.
 - The JOB LIST window appears.

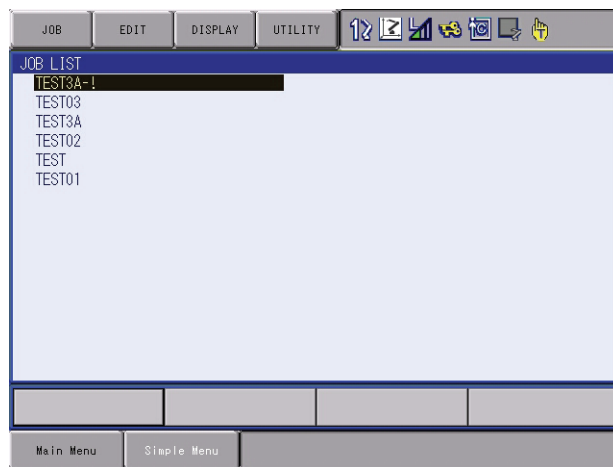

3. Select the desired job.

4.1.1.2 Registering the Master Job

If a particular job is played back frequently, it is convenient to register that job as a master job (master registration). A job registered as the master job can be called more easily than the method described on the preceding page.



Only one job can be registered as the master job. Registering a master job automatically cancels the previously registered master job.

Be sure to register a master job in the teach mode.

1. Select {JOB} under the main menu.
2. Select {MASTER JOB}.
 - The MASTER JOB window appears.

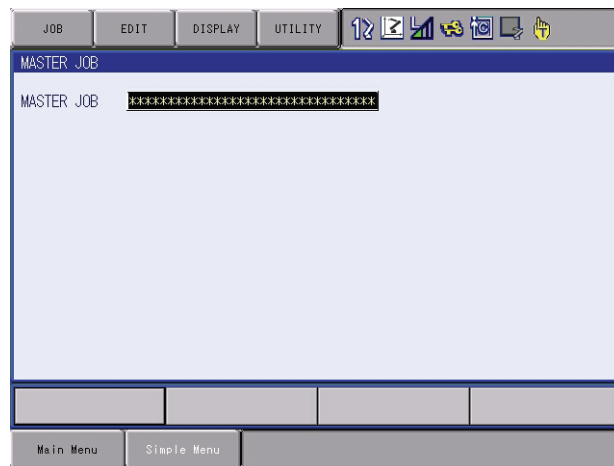

3. Press [SELECT].
 - The selection dialog box appears.

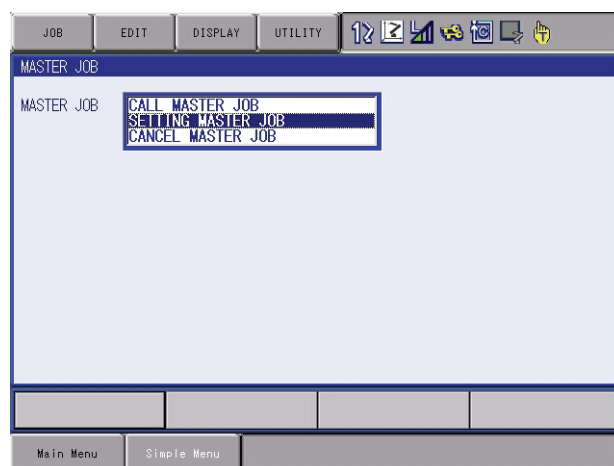

4 Playback
4.1 Preparation for Playback

- 4. Select {CALL MASTER JOB}.
 - The JOB LIST window appears.

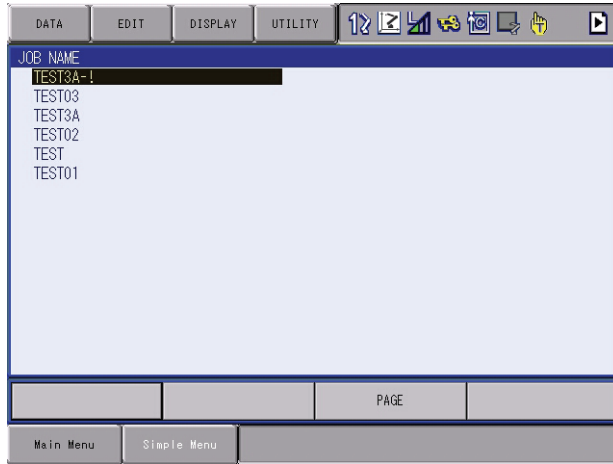

- 5. Select a job to be registered as a master job.
 - The selected job is registered as the master job.

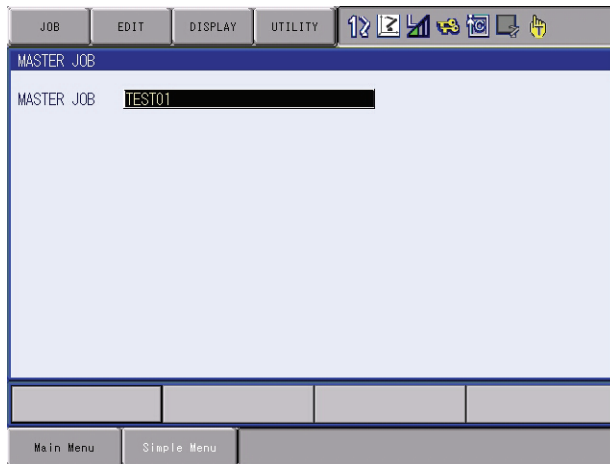

	4	Playback
DX100	4.1	Preparation for Playback

4.1.1.3 Calling the Master Job

This operation is to call a master job. The job can be called in the JOB CONTENT window, PLAYBACK window, JOB SELECT window, or the MASTER JOB window.

■ Calling from the JOB CONTENT, PLAYBACK, JOB SELECT Window

1. Select {JOB} under the menu.

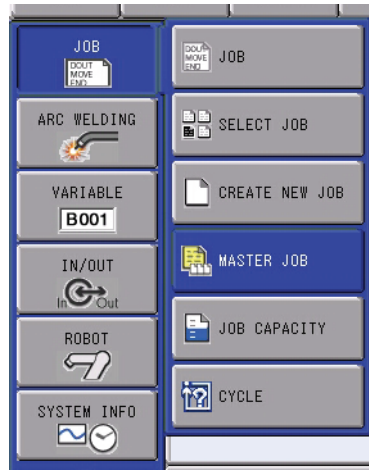

2. Select {MASTER JOB}.
 - The master job is called, and the JOB CONTENT window appears.

■ **Calling from the MASTER JOB Window**

1. Select {JOB} under the main menu.
2. Select {MASTER JOB}.
 - The MASTER JOB window appears.

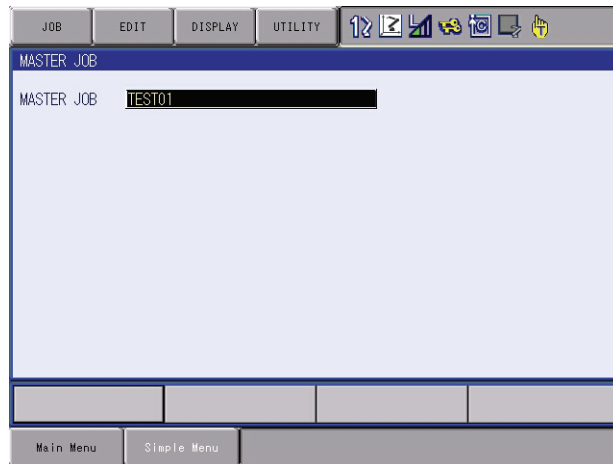

3. Press [SELECT].
 - The selection dialog box appears.

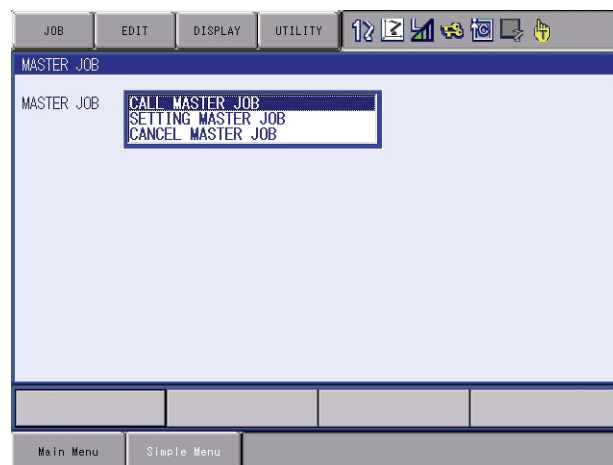

4. Select {CALL MASTER JOB}.
 - The master job is called, and the JOB CONTENT window (during the teach mode), or the PLAYBACK window (during the play mode) appears.

4.1.2 The PLAYBACK Window

When the mode switch on the programming pendant is switched to "PLAY" while displaying the JOB CONTENT window, the PLAYBACK window appears.



A. Job Content

The cursor moves according to the playback operation. The contents are automatically scrolled as needed.

B. Override Speed Settings

Displayed when override speed setting is performed.

C. Cycle Time

Displays the operating time of the manipulator. Each time the manipulator is started, the previous cycle time is reset, and a new measurement begins. Either showing or hiding the cycle time display is selectable.

D. Start No.

First step in the measurement. Measurement starts when the start button lamp lights and the playback starts.

E. Motion Time

Displays the weaving time of the manipulator.

F. Playback Time

Displays the time from the beginning to the end of the measurement. Measurement ends when the manipulator stops and the start button lamp goes off.

4.1.2.1 Display of Cycle Time

Follow the procedure below to set whether or not to display the cycle time on the PLAYBACK window.

1. Select {DISPLAY} under the menu.
2. Select {CYCLE TIME}.
 - The cycle time is displayed.
 - Repeat the same operation to hide the cycle time display.

4.1.2.2 Operation Cycle

There are three types of manipulator operation cycles:

- AUTO : Repeats a job continuously.
- 1 CYCLE : Executes a job once. If there is a called job during execution, it is performed, after which the execution processing returns to the original job.
- 1 STEP : Executes one step (instruction) at a time.

The operation cycle can be changed as follows:

1. Select {JOB} under the main menu, and then select {CYCLE}.
2. Select the operation cycle to be changed.
 - The operation cycle is changed.



■ **Automatic Setting for Operation Cycle**

Automatic setting of the operation cycle can be changed by the following operation.

This can be done in the management mode only.

1. Select {SETUP} under the main menu.
2. Select {OPERATE COND}.
 - The OPERATING CONDITION window appears. Use the cursor to scroll the screen.

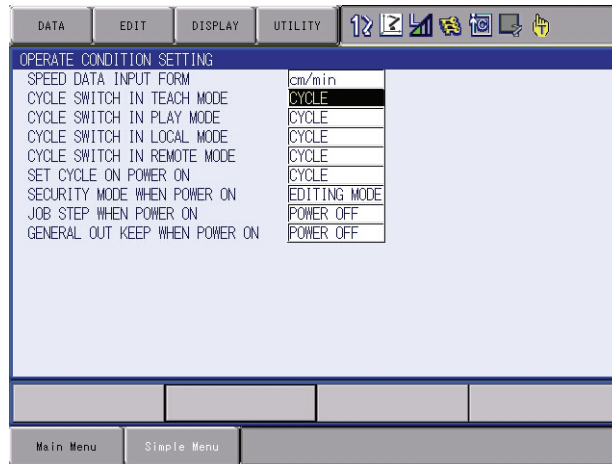

3. Select the desired operation.
 - The selection dialog box appears.

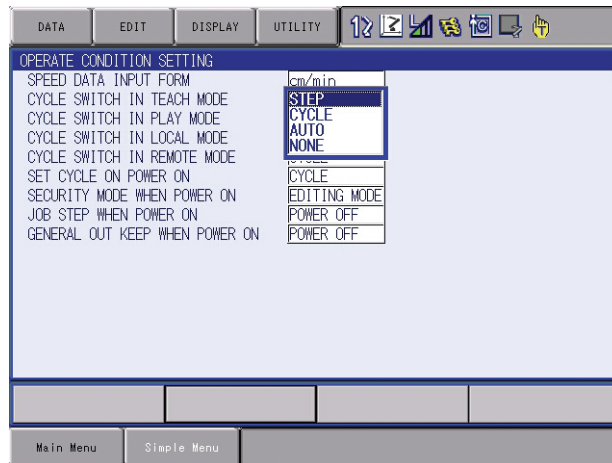

“NONE” setting



The operation cycle is not changed when “NONE” is set. For example, if the setting is “CYCLE SWITCH IN PLAY MODE = NONE,” the operation cycle is maintained even after switching to the play mode.

4. Select a cycle.

- The operation cycle when switching modes is set.

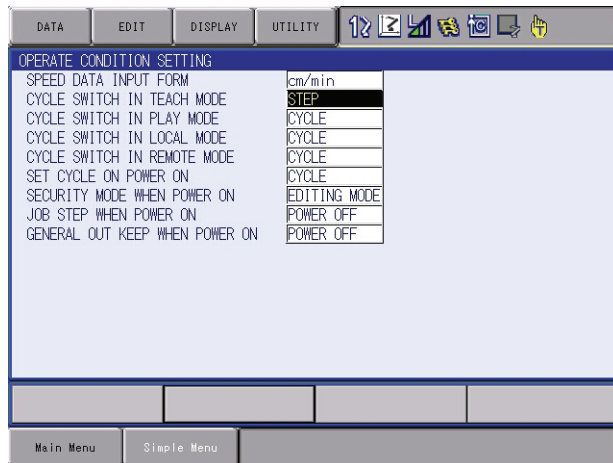

DX100	4	Playback
	4.2	Playback

4.2 Playback

4.2.1 Playback Operation



After checking to be sure there is no one near the manipulator, start the playback operation by following the procedures below.

Playback is the operation by which the taught job is played back. Follow the procedures below to start the playback operation.

- Programming pendant (start button)
- Peripheral device (external start input)

Which is used to start playback is specified by the mode switch on the programming pendant.

Mode Switch on Programming Pendant	Job is started up by
[PLAY]	[START] button on programming pendant
[REMOTE]	Peripheral device

For playback using the programming pendant, follow the procedures below.

4.2.1.1 Selecting the Start Device

1. Set the mode switch on the programming pendant to "PLAY."
 - The remote mode is disabled and the play mode is enabled so the machines are to be started up by the programming pendant.

4.2.1.2 Servo On

1. Press [Servo ON Ready].
 - DX100 servo power is ON and the Servo ON lamp on the programming pendant lights.

4.2.1.3 Start Operation

1. Press [START].
 - The start button lamp lights and the manipulator begins operation.

4.2.2 Special Playback Operations

The following special operations can be performed during playback:

- Low speed operation
- Limited speed operation
- Dry run speed operation
- Machine lock operation
- Check mode operation

Two or more special operations can be performed at the same time. If multiple operations are selected, the speed during playback is limited to the speed of the slowest operation. Settings for special operations are done in the SPECIAL PLAY window.

When the PLAYBACK window is displayed, move the cursor to the menu area and select {UTILITY} → {SETUP SPECIAL RUN}. The SPECIAL PLAY window appears.

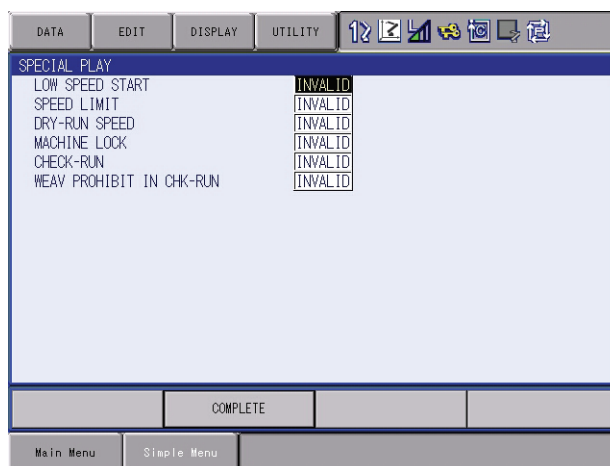

4.2.2.1 Low Speed Operation

The manipulator moves at low speed during the first step after starting. After the operation of this step, the manipulator stops regardless of the selection of the operation cycle and then low speed operation is canceled. Low speed operation is also cancelled if the manipulator is manually stopped during the low speed operation.

After one step operation or any stop of manipulator during low speed operation, pressing [START] allows the manipulator to move at the taught speed.

1. Select "LOW SPEED START" on the SPECIAL PLAY window.
 - The setting alternates between "VALID" and "INVALID."
2. Select "COMPLETE."
 - The window returns to the PLAYBACK window.

4.2.2.2 Limited Speed Operations

The manipulator operates within the limited speed for the teach mode. Usually, the limited speed is set to 250mm/s. However, operation is performed at actual playback speeds for steps in which the set speed is under this limit.

1. Select "SPEED LIMIT" under the SPECIAL PLAY window.
 - The setting alternates between "VALID" and "INVALID."
2. Select "COMPLETE."
 - The window returns to the PLAYBACK window.

4.2.2.3 Dry-run Speed Operations

The dry-run speed is a constant speed that is independent of the teaching speeds. The manipulator executes all the steps at a constant speed, which is convenient for quick check of a job consisting of slow operations. The dry-run speed is 10% of maximum speed.



Be careful of steps programmed at lower speeds than the dry-run speed, because they are executed at greater speeds than programmed.

1. Select the "DRY-RUN SPEED" under the SPECIAL PLAY window.
 - The setting alternates between "VALID" and "INVALID."
2. Select "COMPLETE."
 - The window returns to the PLAYBACK window.

Fig. 4-1: Safety Speed and Dry-run Speed

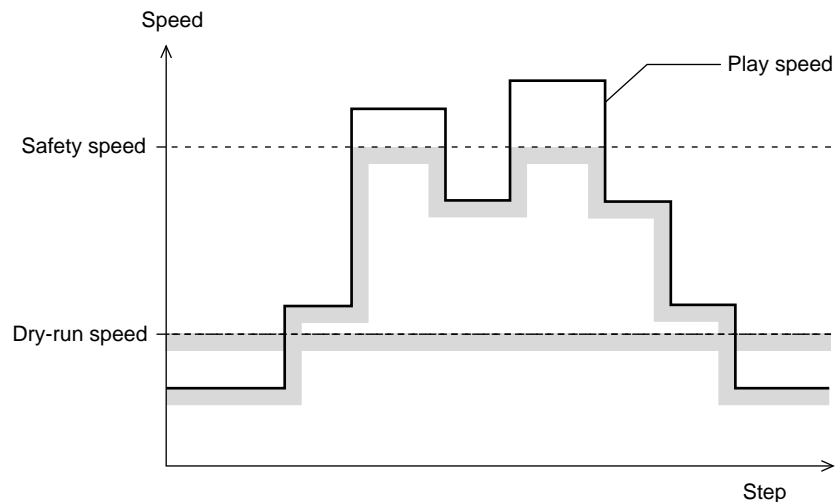

4.2.2.4 Machine Lock Operation

A job is played back without moving the manipulator to check the status of input and output.

1. Select "MACHINE LOCK" under the SPECIAL PLAY window.
 - The setting alternates between "VALID" and "INVALID."
2. Select "COMPLETE."
 - The window returns to the PLAYBACK window.



- The setting of "MACHINE LOCK" is maintained even after the mode is switched: If the machine lock is set to "VALID" in the teach mode, it is still "VALID" after switching to the play mode.
The same applies when the mode is switched from the play mode to the teach mode.
- Note that the machine lock becomes "INVALID" if the following operation is performed.
 - Execution of "CANCEL ALL SELECT" in the SPECIAL PLAY window.
 - Turning off the main power.

4.2.2.5 Check Mode Operation

The machine runs without issuing work instructions, such as the ARCON instruction. It is used primarily to check the path of the program.

1. Select "CHECK-RUN" under the SPECIAL PLAY window.
 - The setting alternates between "VALID" and "INVALID."
2. Select "COMPLETE."
 - The window returns to the PLAYBACK window.

4.2.2.6 Weaving Prohibit Setting during Check Mode Operation

The weaving operation is not executed in the weaving section of the job.

1. Select "WEAV PROHIBIT IN CHK-RUN" under the SPECIAL PLAY window.
 - The setting alternates between "VALID" and "INVALID."
2. Select "COMPLETE."
 - The window returns to the PLAYBACK window.

4.2.2.7 Cancel All Special Operations

All special operations are disabled by the following operation.

1. Select {EDIT} from the menu.
2. Select "CANCEL ALL SELECT."
 - The message "All special functions canceled" appears.



Special operations are also automatically cancelled if the main power is shut OFF.

4.3 Stop and Restart

The manipulator stops in the following conditions:

- Hold
- Emergency stop
- Stop by alarm
- Others

4.3.1 Hold

Hold operation causes the manipulator to stop all motion.



[HOLD] lamp lights while it is held down. At the same time, [START] lamp goes OFF.

4.3.1.1 Using the Programming Pendant

■ Hold

1. Press [HOLD] on the programming pendant.
2. The manipulator stops. The [HOLD] lamp lights while the [HOLD] button is held down.

■ Release

1. Press [START] on the programming pendant.
2. The manipulator restarts its operation from the position where it was stopped.

4.3.1.2 Using an External Input Signal (System Input)

■ Hold

1. Turn ON the hold signal from an external input (system input).
 - The manipulator stops temporarily.



- The output signal "HOLD" turns ON.
- The programming pendant [HOLD] lamp lights.

■ Release



1. Turn off the hold signal from an external input (system input).
 - Hold is released.
 - To continue the operation, press [START] or turn ON the external input signal (system input). The manipulator restarts its operation, beginning from the position where it was stopped.

4.3.2 Emergency Stop

At an emergency stop, the servo power supply that drives the manipulator is turned OFF and the manipulator stops immediately. An emergency stop can be performed by using either of the following:

- Button on the Front Door of the DX100
- Programming pendant
- External input signal (system input)

■ Emergency Stop

1. Press the emergency stop button  .
 - The servo power turns OFF and the manipulator stops immediately.
 - On the front door of the DX100: 
 - On the programming pendant: 

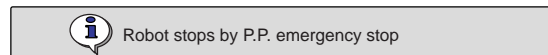

Using the Emergency Stop Button on the Programming Pendant

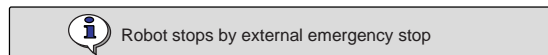

Using the External Input Signal (System Input)



■ Release

1. Turn the emergency stop button  in the direction of the arrows.
 - On the front door of the DX100: 
 - On the programming pendant: 
 - To turn ON the servo power supply again, press [SERVO ON READY] and then grip the Enable switch of the programming pendant.



4.3.2.1 Restart After Emergency Stop

**CAUTION**

- **Prior to restarting after an emergency stop, confirm the position for the next operation and make sure there is no interference with the workpiece or fixture.**
- The application of an emergency stop during high speed operations on continuous steps can result in the manipulator stopping two or three steps prior to the step that is being displayed. There is a risk of interference with the workpiece or fixture when the manipulator is restarted under such conditions.

4.3.3 Stop by Alarm

If an alarm occurs during operation, the manipulator stops immediately and the ALARM window appears on the programming pendant indicating that the machine was stopped by an alarm.

- If more than one alarm occurs simultaneously, all alarms can be viewed on the window. Scroll down the viewing area of the window when necessary.



The following operations are available in the alarm status window: window change, mode change, alarm reset, and emergency stop. To display the ALARM window again when the window is changed during alarm occurrence, select {SYSTEM INFO} and then {ALARM HISTORY}.

■ Releasing Alarms

<Minor Alarms>

1. Press [SELECT].
 - Select “RESET” under the ALARM window to release the alarm status.
 - When using an external input signal (system input), turn ON the “ALARM RESET” setting.

<Major Alarms>

1. Turn OFF the main power supply and remove the cause of the alarm.
 - If a severe alarm such as hardware failure alarm occurs, the servo power is automatically shut off and the manipulator stops. If releasing does not work, turn OFF the main power and correct the cause of the alarm.

4.3.4 Others

4.3.4.1 Temporary Stop by Mode Change

When the play mode is switched to the teach mode during playback, the manipulator stops immediately.

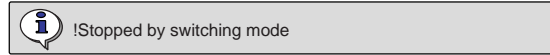

To restart the operation, return to the play mode and perform a start operation.

4.3.4.2 Temporary Stop by the PAUSE Instruction

When the PAUSE instruction is executed, the manipulator stops operating.

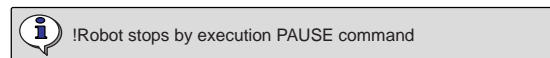

To restart the operation, perform a start operation. The manipulator restarts from the next instruction.

4.4 Modifying Play Speed

4.4.1 Speed Override

Speed modifications using the speed override have the following features:

- Speed can be modified during playback.
The job can be played back at various speeds until the play speed is properly adjusted.
- Speed can be increased or decreased by a ratio of the current play speed.
The ratio settings range from 10% to 150% in increments of 1%.
Therefore, it is convenient when, for example, all play speed settings are to be increased by 150% at the same time.

The operation flow is shown below.

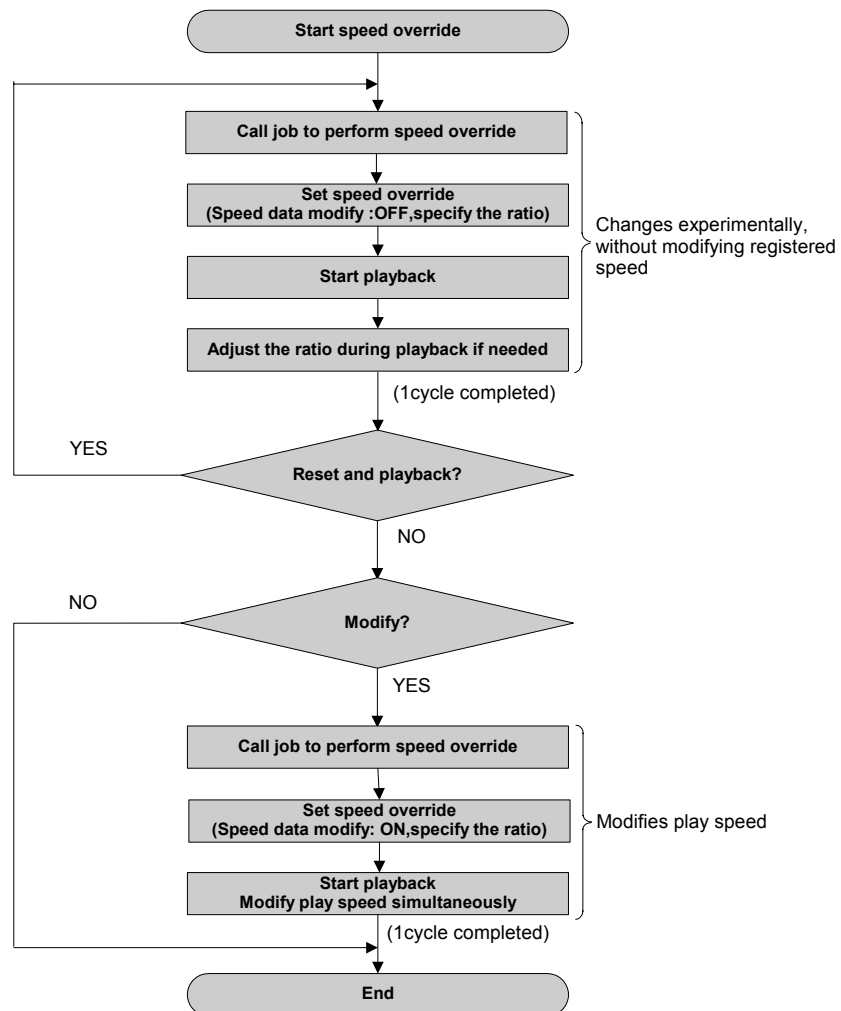

4.4.1.1 Setting Speed Overrides

1. Select {UTILITY} under the menu in the PLAYBACK window.
2. Select {SPEED OVERRIDE}.
 - The PLAYBACK window shows the speed override status.



3. Select "ON" or "OFF".
 - Each time [SELECT] is pressed, "ON" and "OFF" alternate.
 - Select "ON" to modify the registered play speed during playback.
 - When "OFF" is selected, the registered play speed is not modified. To change the play speed temporarily (for example, to experiment with various speeds), select "OFF."

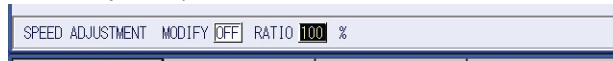

4. Line up the cursor with the override ratio and move the cursor up and down to change the ratio.
 - If you want to input the ratio number directly, move the cursor to the override ratio and press [SELECT].
 - The number input line appears. Input the override ratio using the Numeric keys.



4.4.1.2 Modifying Play Speed

1. Set speed override.
2. Playback the manipulator.
 - The play speed is increased or decreased in the set ratio.
 - When setting “MODIFY” to “ON,” the step’s play speed is modified when each step is reached.
 - When one cycle is completed by the END instruction, the speed override setting is cancelled.



- Assuming that the manipulator moves from step 1 to step 2, the play speed of step 2 is not modified if the speed override is cancelled before reaching step 2.
- The play speed after the modification by the speed override is limited by the maximum and the minimum speed of manipulator.
- When the safety speed operation is commanded with the setting of “MODIFY: ON,” the manipulator operates at the safety speed. However, the play speed in memory is modified as set by the speed override.
- Play speed set by the SPEED instruction is not modified.

4.4.1.3 Cancelling Speed Override Settings

1. Select {UTILITY} under the menu in the PLAYBACK window.
2. Select {SPEED OVERRIDE}.
 - The setting of the speed override ratio is cancelled.
 - If cancelled, the speed ratio setting is not displayed on the PLAYBACK window.



- The speed override settings are automatically cancelled in the following cases:
- When dry-run speed operation is set.
 - When the mode is changed to any mode other than the play mode.
 - When an alarm or error occurs.
 - When one cycle operation is completed with the END instruction.
 - When the power supply is turned OFF.

4.5 Playback with Reserved Start

4.5.1 Preparation for Reserved Start

In the reserved start function, jobs registered at different stations are played back in the reserved order using the start buttons on the stations.

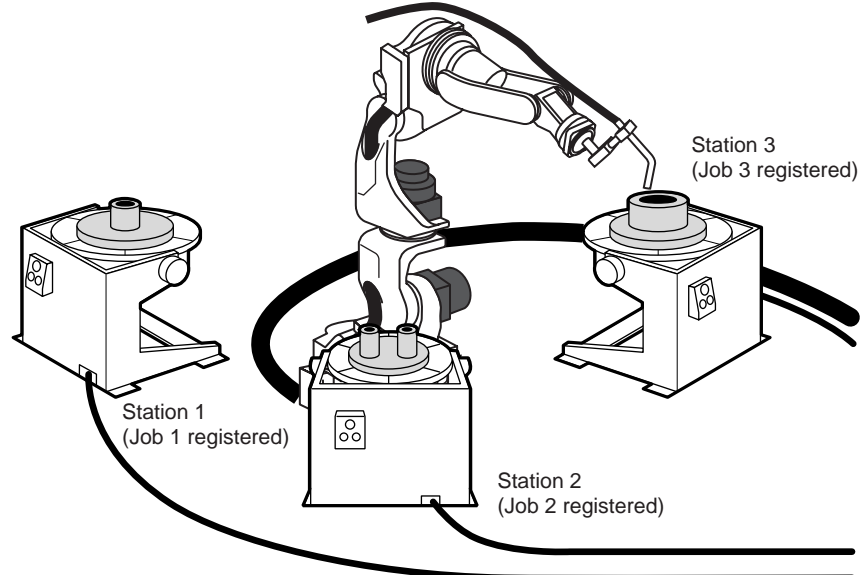

For example, in the case where three stations handle three different workpieces, as shown in the illustration above, the jobs would be registered as follows:

- Job 1 is registered to process workpiece 1 at Station 1
- Job 2 is registered to process workpiece 2 at Station 2
- Job 3 is registered to process workpiece 3 at Station 3

To play back the jobs, prepare workpiece 1 and press the start button on Station 1. The manipulator executes Job 1. Prepare workpieces 2 and 3 while Job 1 is being executed, and press the start buttons on Stations 2 and 3. Even if Job 1 is being executed at that time, jobs on different stations are reserved in the order that the start buttons have been pressed, and will be executed in that order.

During playback, the status of the reservation can be checked on the start reservation window.

4.5.1.1 Enabling Reserved Start

The start button on the station is operative when the reserved start function is enabled, and the following start operations are disabled.

- [START] on the programming pendant
- Start operation from external input signal (system input)



The OPERATING CONDITION window is shown only when the security mode is management mode.

1. Select {SETUP} under the main menu.
2. Select {OPERATE COND}.
 - The OPERATING CONDITION window appears.
 - The screen is scrolled up/down by the cursor key when it locates at the top/bottom of the items.

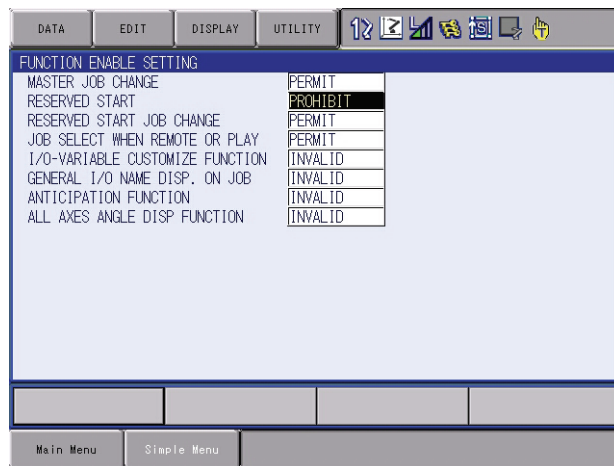

3. Select "RESERVED START."
 - Each time [SELECT] is pressed, "PERMIT" and "PROHIBIT" alternate. Select "PERMIT."

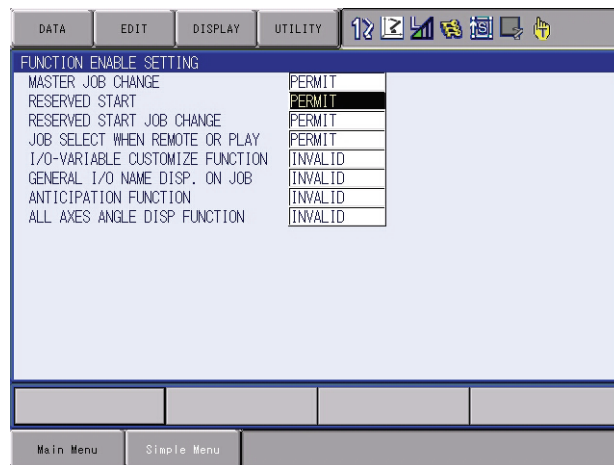



When the reserved start is enabled, the external start and the programming pendant start are prohibited even if setting is "PERMIT."

Regardless of the operation cycle selected, it is automatically set to 1 CYCLE.

4.5.1.2 Registering Reserved Start I/O Signal

Register the start I/O signal as a preparation to perform the start operation from the station.



This operation can be done only when the operation mode is the teach mode and the security mode is the management mode, and only when the setting of “RESERVED START JOB CHANGE” is “PERMIT” in the OPERATING CONDITION window.

1. Select {SETUP} under the main menu.
2. Select {RES. START(CNCT)}.
 - The RESERVED START (CNCT) window appears.

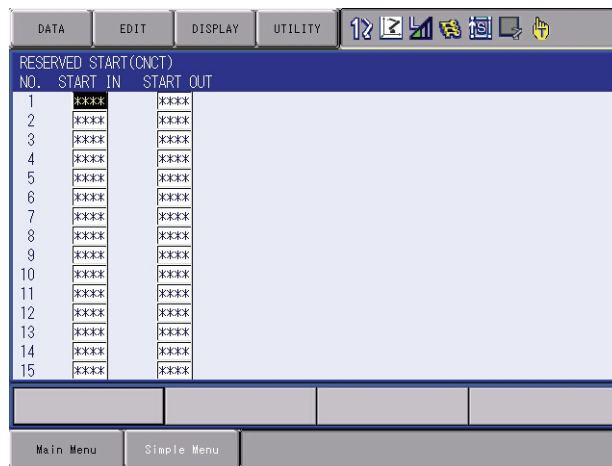

3. Select “START IN” or “START OUT” for each station.
 - The number can now be entered.

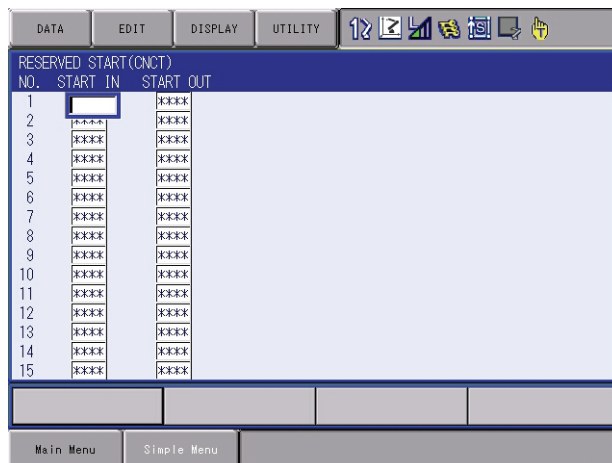

4. Input signal number and press [ENTER].

– The input/output signal number is registered.

RESERVED START (CNCT)		
NO.	START IN	START OUT
1	48	****
2	****	****
3	****	****
4	****	****
5	****	****
6	****	****
7	****	****
8	****	****
9	****	****
10	****	****
11	****	****
12	****	****
13	****	****
14	****	****
15	****	****

4.5.1.3 Registering Jobs to Stations

Register the starting job of each station.



This operation can be done only when the operation mode is the teach mode and the setting of “RESERVED START JOB CHANGE” is “PERMIT” in the OPERATING CONDITION window.

1. Select {JOB} under the main menu.
2. Select {RES. START(JOB)}.
 - The RESERVED START (JOB) window appears.
 - ● indicates that the input/output number is registered.
 - ○ indicates that the input/output number is not registered.

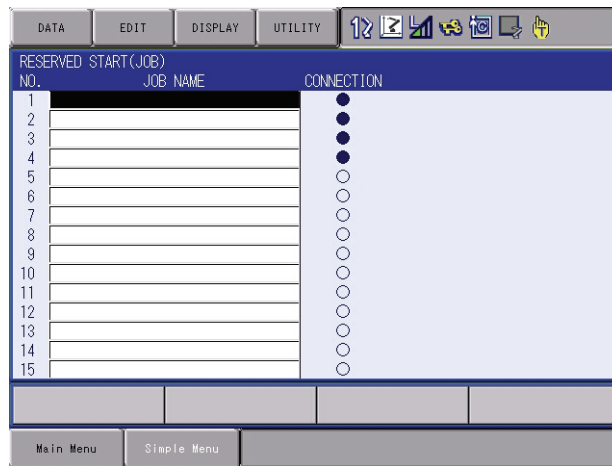

3. Select the job name for each station.
 - The selection dialog box appears.

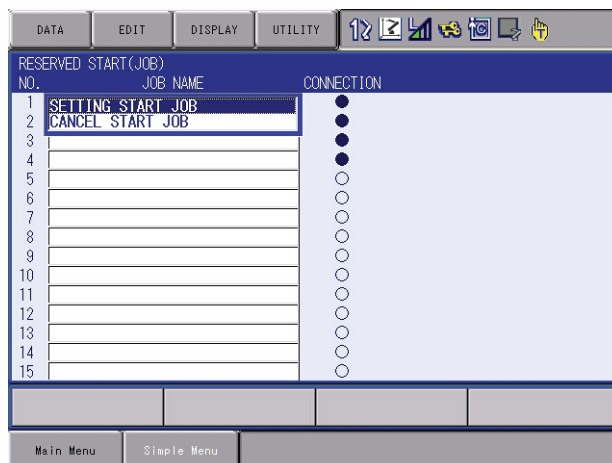

4. Select “SETTING START JOB.”
 - The JOB LIST window appears.
5. Select a job.

– The starting job is registered.

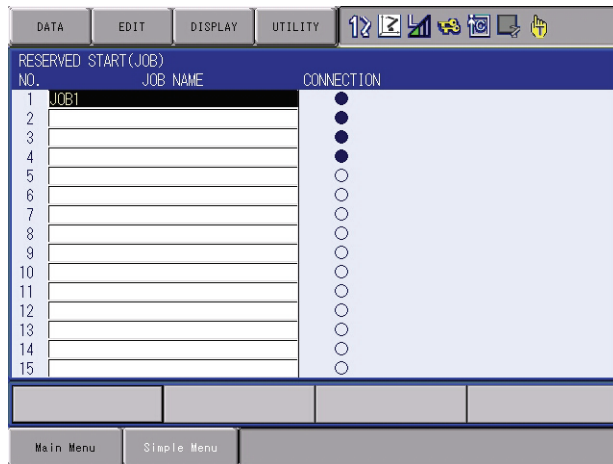

4.5.1.4 Deleting Registered Jobs from Stations

Delete the registered job of each station.



This operation can be done only when the operation mode is the teach mode and the setting of “RESERVED START JOB CHANGE” is “PERMIT” in the operation condition display.

1. Select {JOB} under the main menu.
2. Select {RES. START(JOB)}.
 - The RESERVED START (JOB) window appears.
3. Select the job name of the station to be deleted.
 - The selection dialog box appears.

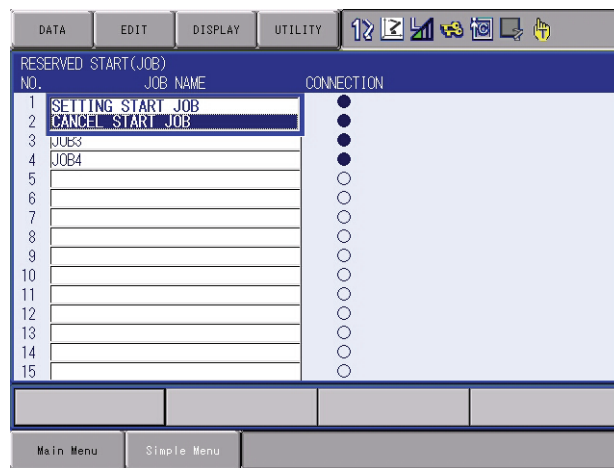

4. Select “CANCEL START JOB.”
 - The registered job is deleted.

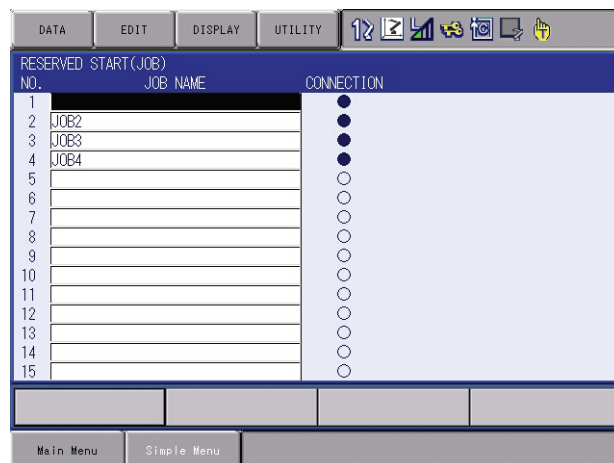

4.5.2 Playback from Reserved Start

4.5.2.1 Start Operation

1. Set the mode switch to "PLAY."
2. Press start button on the station.
 - The job registered for the station starts up and the manipulator performs one cycle operation.



- While the job is being executed, the start button lamp on the station lamps.
- If the workpiece must be prepared at the station, prepare it before pressing the start button.
- During the execution of a job for one station, if the start button of another station is pressed, the job of the latter station is reserved and prepared to start. Jobs are reserved and executed in the order that the start buttons have been pressed.
- When a job is reserved, the start button lamp on the station blinks.
- No station job is reserved when it is being executed even if its start button is pressed.
- To suspend a job being executed, perform the Hold operation.



Reservations are cancelled when the start button is pressed again during the job reservation operation.

4.5.2.2 Checking Job Reservation Status

The job reservation status during playback can be checked.

1. Select {JOB} under the main menu.
2. Select {RES. STATUS}.
 - The RESERVATION STATUS window appears.

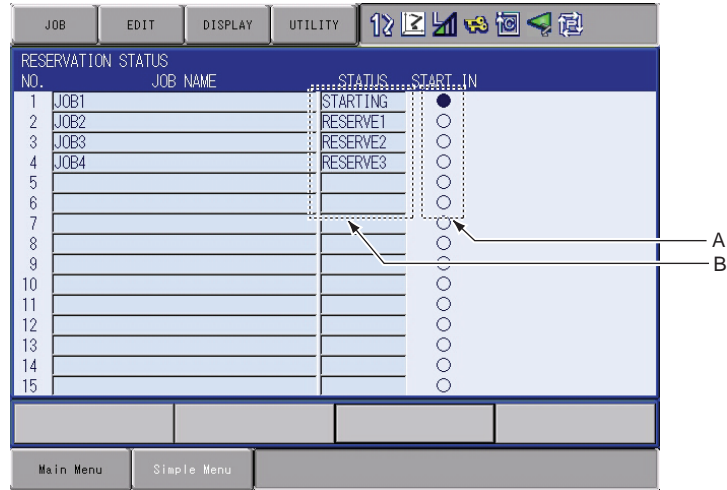

A. STATUS

Reservation status is displayed.
 STARTING: Indicates the station currently working.
 STOP: Indicates any station where work has been temporarily stopped by a hold operation.
 RESERVE1,RESERVE2,...: Indicates the order in which jobs have been reserved for start.

B.START IN

Input signal status is displayed.
 “●”: Input signal ON
 “○”: Input signal OFF

4.5.2.3 Resetting Job Reservation



If "STARTING" is displayed, the job cannot be reset.

1. Select {JOB} on the RESERVATION STATUS window.
2. Select {RESET RESERVATION} or {RESET ALL}.
 - When {RESET RESERVATION} is selected, job reservation stated to "RESERVE" is reset.
 - When {RESET ALL} is selected, job reservation stated to "STOP" and "RESERVE" is reset.

RESERVATION STATUS			
NO.	JOB NAME	STATUS	START IN
1	JOB1		<input type="radio"/>
2	JOB2		<input type="radio"/>
3	JOB3		<input type="radio"/>
4	JOB4		<input type="radio"/>
5			<input type="radio"/>
6			<input type="radio"/>
7			<input type="radio"/>
8			<input type="radio"/>
9			<input type="radio"/>
10			<input type="radio"/>
11			<input type="radio"/>
12			<input type="radio"/>
13			<input type="radio"/>
14			<input type="radio"/>
15			<input type="radio"/>

- The confirmation dialog box appears.

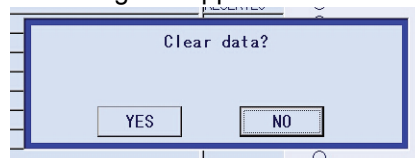

3. Select "YES."



All job reservations are reset automatically in the following conditions:

- When the reserved start sets to "PROHIBIT." (When "RESERVED START" is set to "PROHIBIT" on the OPERATING CONDITION window.)
- When another job is called or an edit operation is performed.

DX100	4	Playback
	4.5	Playback with Reserved Start

4.5.3 Hold Operation

Hold operation causes the manipulator to stop all motion. It can be performed by the following buttons or signal.

- [HOLD] on the programming pendant
- External Input Signal (system input)
- Hold button for the station axis



[HOLD] lamp lights while it is held down. At the same time, [START] lamp goes OFF.

4.5.3.1 [HOLD] on the Programming Pendant

■ Hold

1. Press [HOLD] on the programming pendant.
 - The manipulator stops temporarily.
 - The [HOLD] lamp lights while the [HOLD] button is held down.

■ Release

1. Press the start button on the suspended station.
 - The manipulator restarts its operation from the position where it was stopped.

4.5.3.2 Hold by External Input Signal (System Input)

■ Hold

1. Input ON signal to the external input (system input) specified for the hold operation.
 - The manipulator stops temporarily.



The hold lamp for the external output signal lights.

- The [HOLD] lamp on the programming pendant lights and the [START] lamp turns OFF.

■ Release

1. Input OFF signal to the external input (system input) specified for the hold operation.
 - Hold is released.
2. To continue the operation, press the start button on the suspended station.
 - The manipulator restarts its operation from the position where it was stopped.

4.5.3.3 Hold at the Station

■ Hold

1. Press the hold button on the station.
 - The manipulator stops temporarily.



■ Release

1. Press the hold button on the suspended station.
 - Hold is released.
 - Press the start button on the station, then the manipulator restarts its operation from the position where it was stopped.



Pressing the start button on a station that is not in the Hold status does not start manipulator operation. The job registered for the station is reserved or the reservation, if it has been made, is canceled.

4.6 Displaying Job Stack

During the execution of the series of jobs that combined with CALL or JUMP instructions, the job stack can be displayed to check where the current job is and how many jobs are left.

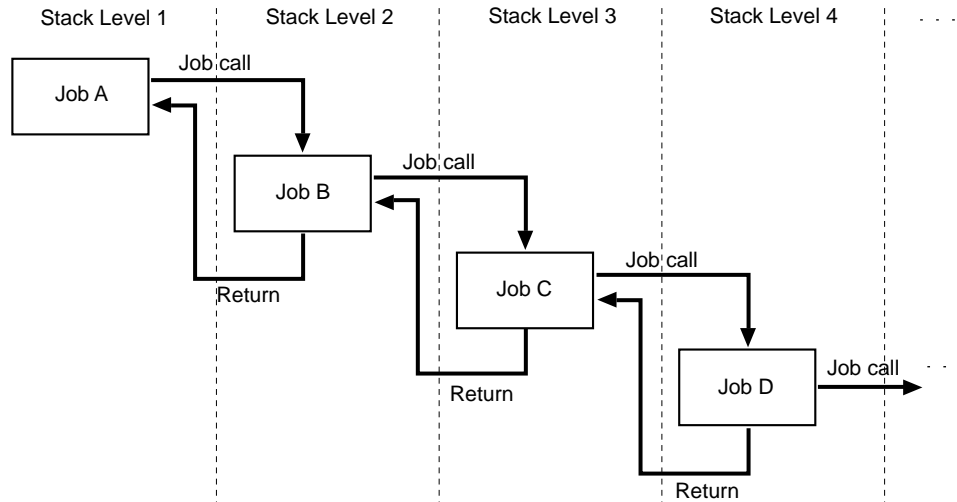

 Job calls can be used for up to 12 stack levels.

1. Select {DISPLAY} under the menu on the PLAYBACK window.
 - The pull-down menu appears.

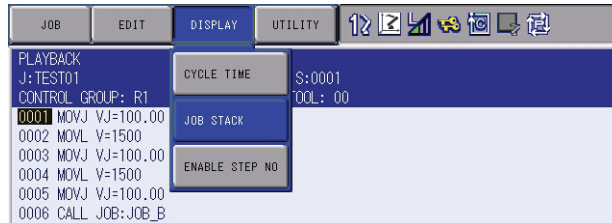

2. Select {JOB STACK}.
 - The job stack status dialog box appears.

- To close the job stack status dialog box, select {DISPLAY} and then {JOB STACK} under the menu again.

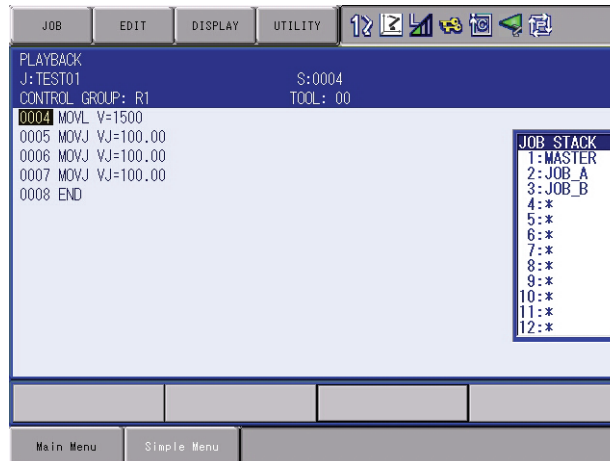

- For above example, the playback of Job C is being executed and the Job C is called from Job B. Also, the Job B is called from Job A.

5 Editing Jobs

This section explains how to manage the jobs without moving the manipulator. Copying, deleting, and modifying of the jobs can be done only in the teach mode. Other operations can be done in any mode.



Edit operations are restricted when the edit lock is applied.

Editing Move Instructions

See *chapter 3 "Teaching" at page 3-1* for basic information on editing move instructions.

- It is not possible to add, delete, or modify move instructions which have position data. See *chapter 3.4 "Modifying Steps" at page 3-28* for details.
- The following MOV instruction edit operations are explained in this section:



For move instructions:

- Insertion, deletion, or modification of additional items
- Modification of interpolation type or play speed for move instructions
- Setting, modification, or deletion of UNTIL statements (interruption conditions based on input signals)
- Setting and deletion of NWAIT instructions

For move instructions using position variables:

- Insertion and deletion of move instruction.



Refer to *chapter 1.2.6 "Character Input Operation" at page 1-18* for the character input operation.

5.1 Copying Jobs

This operation is used to copy registered jobs and use them to create new jobs. It can be done using either the JOB CONTENT window or the JOB LIST window.

5.1.0.1 Copying Jobs on the JOB CONTENT Window

On the JOB CONTENT window, the current edit job becomes the copy source job.

1. Select {JOB} under the main menu.
2. Select {JOB}.
 - The JOB CONTENT window appears.



3. Select {JOB} → {COPY JOB} under the pull-down menu.

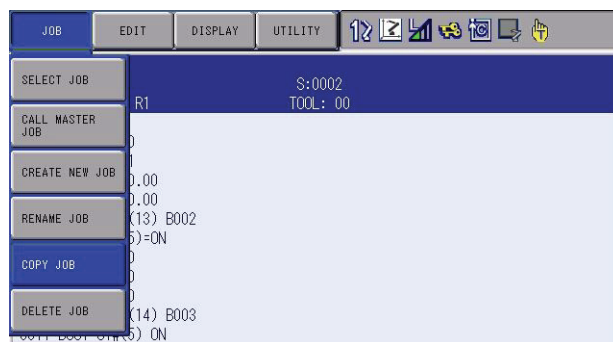

4. Input the job name.
 - Input the new job name.
 - The name of the copy source job is displayed on the input area. It is possible to partially change this name to enter a new name.

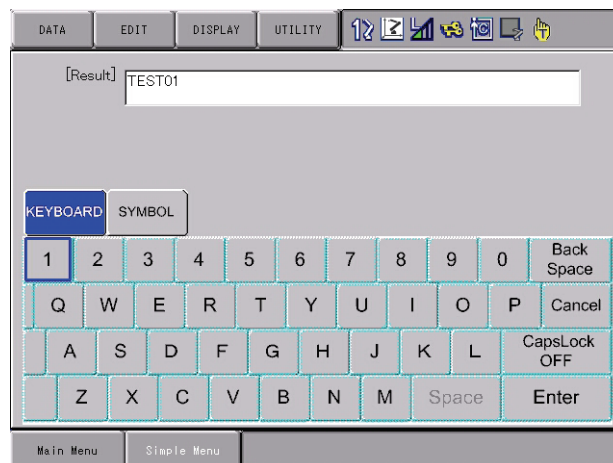



See chapter 1.2.6 "Character Input Operation" at page 1-18 for information on letter input operations.

5. Press [ENTER].

- The confirmation dialog box appears.
- If "YES" is selected, the job is copied and the new job appears.
- If "NO" is selected, the job copy is not executed, and the process is cancelled.

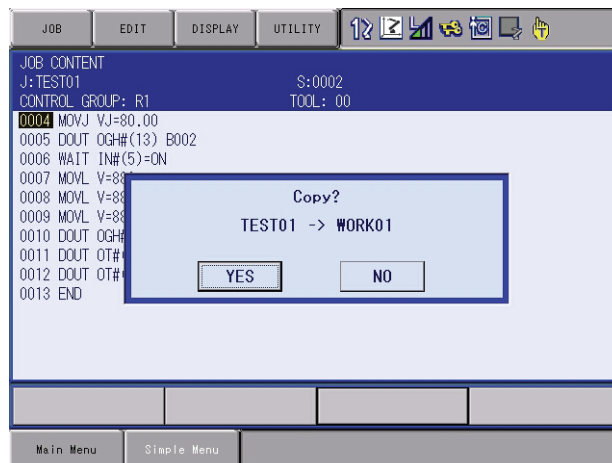

5.1.0.2 Copying Jobs on the JOB LIST Window

On the JOB LIST window, select the copy source job from the registered jobs and specify the copy destination directory.

1. Select {JOB} → {SELECT JOB} under the main menu.
 - The JOB LIST window appears.



2. Move the cursor to the copy source job.
3. Select {JOB} → {COPY JOB} under the pull-down menu.



4. Input the job name.
 - Input the new job name.
 - The name of the copy source job is displayed on the input area. It is possible to partially change this name to enter a new name.

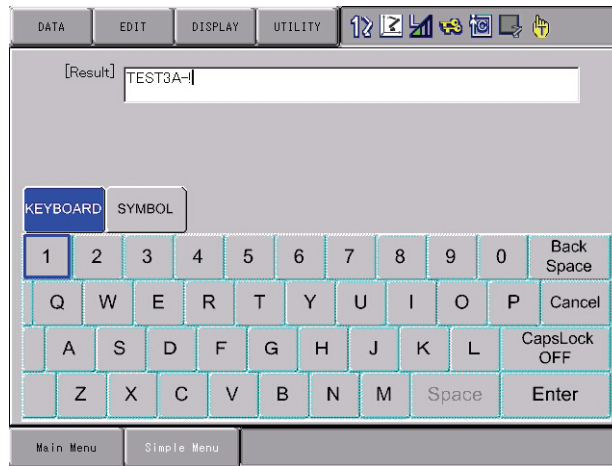

See chapter 1.2.6 "Character Input Operation" at page 1-18 for information on letter input operations.

5. Press [ENTER].
 - The confirmation dialog box appears.
 - If "YES" is selected, the job is copied and the new job appears.
 - If "NO" is selected, the job copy is not executed, and the process is cancelled.

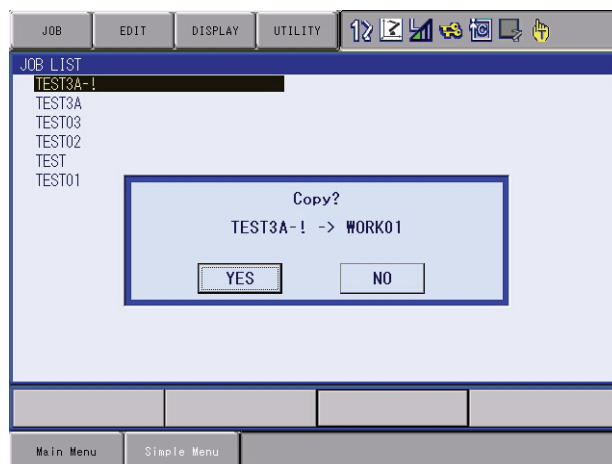

5.2 Deleting Jobs

This operation is used to delete jobs that are registered on the DX100. It can be performed in either the JOB CONTENT window or the JOB LIST window.

5.2.0.1 Deleting Jobs on the JOB CONTENT Window

On the JOB CONTENT window, the current edit job is deleted.

1. Select {JOB} under the main menu.
2. Select {JOB}.
 - The JOB CONTENT window appears.
3. Select {JOB} → {DELETE JOB} under the pull-down menu.

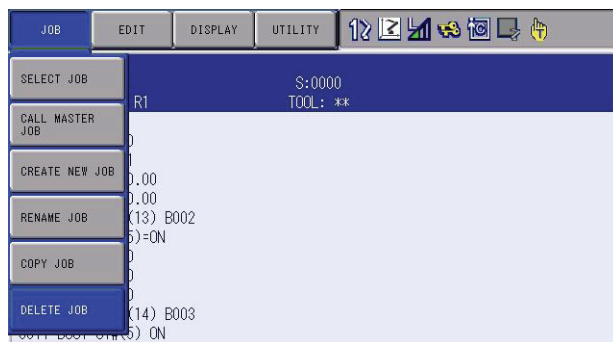

4. Press "YES".
 - The confirmation dialog box appears.
 - When "YES" is selected, the edit job is deleted. When deletion is completed, the JOB LIST window appears.
 - When "NO" is selected, the job deletion is cancelled.

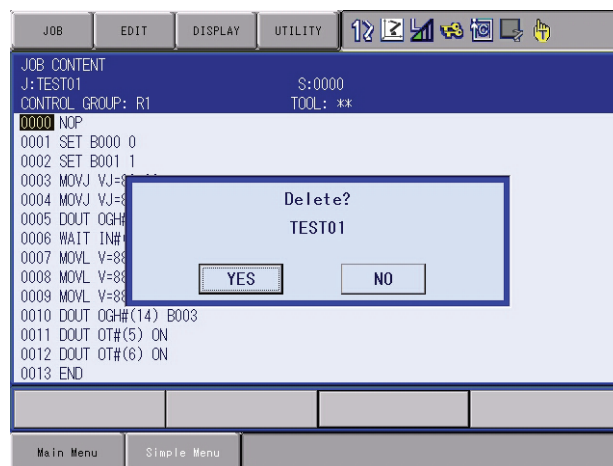

5.2.0.2 Deleting Jobs on the JOB LIST Window

On the JOB LIST window, select the job to be deleted from the list of the registered jobs.

1. Select {JOB} → {SELECT JOB} under the main menu.
 - The JOB LIST window appears.



2. Move the cursor to the job to be deleted.
3. Select {JOB} → {DELETE JOB} under the pull-down menu.



4. Press "YES".
 - The confirmation dialog box appears.
 - When "YES" is selected, the selected job is deleted. When deletion is completed, the JOB LIST window appears.
 - If "NO" or [CANCEL] is selected, the job deletion is cancelled and the JOB LIST window appears.

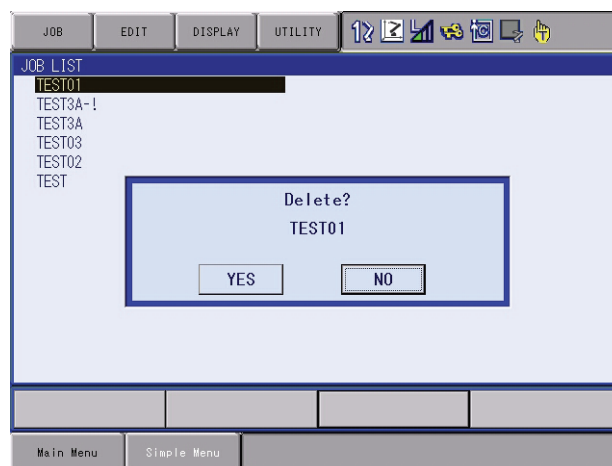

To select all the registered jobs at a time, select {EDIT} from the menu and then select "SELECT ALL."

5.3 Modifying Job Names

This operation is used to modify the name of a job that is registered. The operation can be performed in either the JOB CONTENT window or the JOB LIST window.

5.3.0.1 Modifying Job Names on the JOB CONTENT Window

1. Select {JOB} under the main menu.
2. Select {JOB}.
 - The JOB CONTENT window appears.



3. Select {JOB} → {RENAME JOB} under the pull-down menu.

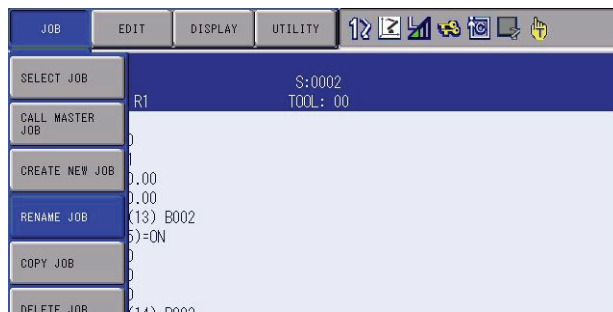

4. Input the job name.
 - Input the new job name.
 - The name of the source job is displayed on the input area. It is possible to partially change this name to enter a new name.



See *chapter 1.2.6 "Character Input Operation"* at page 1-18 for information on letter input operations.

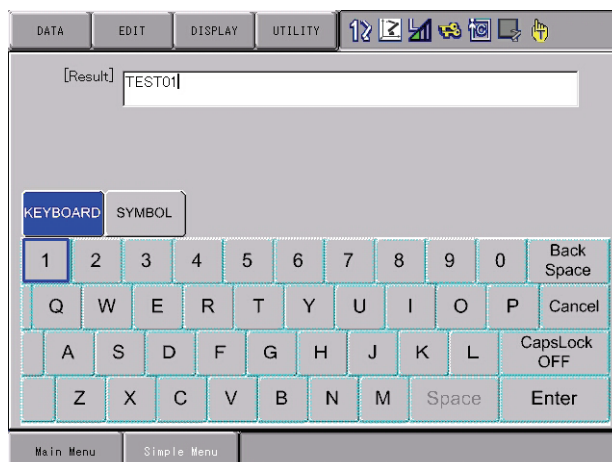

- 5. Press [ENTER].
 - The confirmation dialog box appears.
 - When “YES” is selected, the job name is changed and a new job name is displayed.
 - When “NO” is selected, the job name is not changed, and the process is cancelled.

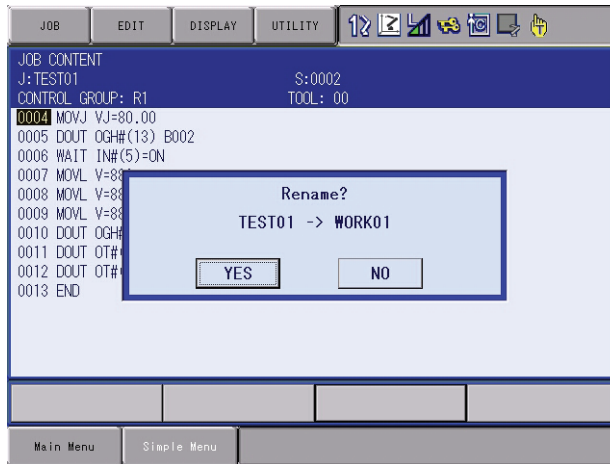

5.3.0.2 Modifying Job Names on the JOB LIST Window

On the JOB LIST window, select the job whose name is to be modified from the list of the registered jobs.

1. Select {JOB} → {SELECT JOB} under the main menu.
 - The JOB LIST window appears.



2. Move the cursor to the name to be changed.
3. Select {JOB} → {RENAME JOB} under the pull-down menu.



4. Input the job name.
 - Input the new job name.
 - The name of the source job is displayed on the input area. It is possible to partially change this name to enter a new name.



See chapter 1.2.6 "Character Input Operation" at page 1-18 for information on letter input operations.

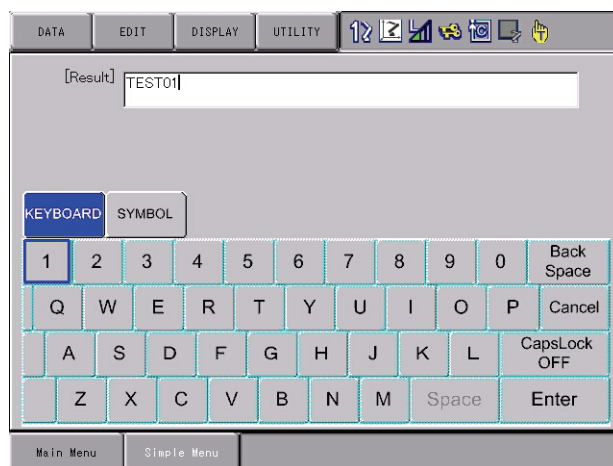

5. Press [ENTER].
 - The confirmation dialog box appears.
 - When "YES" is selected, the job name is changed and a new job name is displayed.

- When "NO" is selected, the job name is not changed, and the process is cancelled.

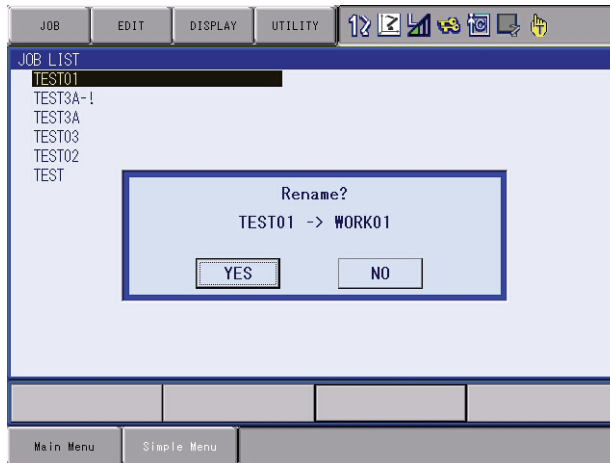

5.4 Editing Comments

Comments of up to 32 characters can be added to each job to identify each job more specifically. Comments are displayed and edited on the JOB HEADER window.

1. Select {JOB} under the main menu.
2. Select {JOB}.
3. Select {DISPLAY} under the pull-down menu.
4. Select {JOB HEADER}.
 - The JOB HEADER window appears.



5. Select "COMMENT."
 - The window for character input appears.
6. Input comments.
 - Input comments.
 - For the jobs that are already registered, comments are displayed on the input area. It is possible to partially change comments to enter new comments.



See chapter 1.2.6 "Character Input Operation" at page 1-18 for information on letter input operations.

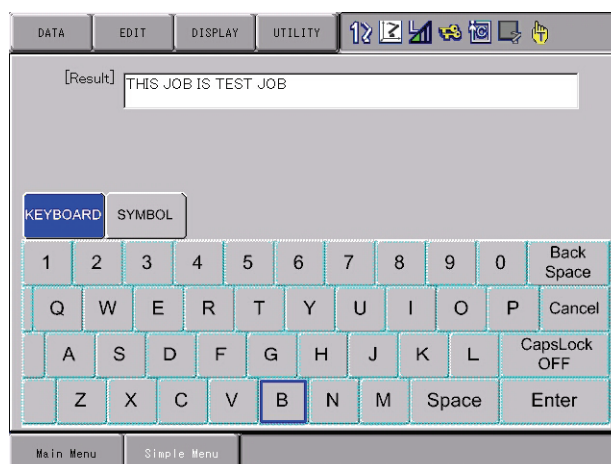

7. Press [ENTER].

- The comment on the input area is registered and is displayed on the "COMMENT" area in the JOB HEADER window.

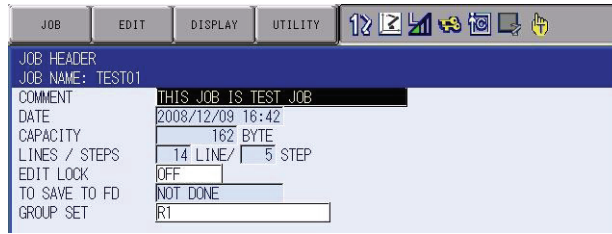

5.5 Setting Edit Lock on Individual Job Units

In order to prevent inadvertent changes in the registered jobs or data, it is possible to set the edit lock to each job. When the edit lock is ON, the job cannot be edited or deleted.

The edit lock can be set and cancelled on the JOB HEADER window.



Setting of the edit lock can be changed only when the security mode is management mode.

1. Select {JOB} under the main menu.
 2. Select {JOB}.
 3. Select {DISPLAY} under the pull-down menu.
 4. Select {JOB HEADER}.
- The JOB HEADER window appears.

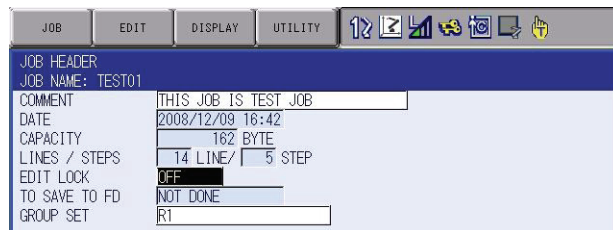

5. Select "EDIT LOCK" and set the edit prohibit.
- Each time [SELECT] is pressed, the setting alternates between "ON" (edit disabled) and "OFF" (edit enabled).

5.6 Enabling the Modification of Position Data Only

Even in the edit-locked job, the position data can be modified.

1. Select {SETUP} under the main menu.
2. Select {TEACHING COND}.
 - The TEACHING CONDITION SETTING window appears.

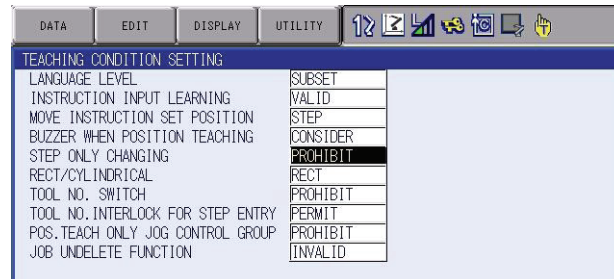

TEACHING CONDITION SETTING window is shown only when the security mode is edit mode or management mode.

3. Select "STEP ONLY CHANGING" and press [SELECT].
 - Each time [SELECT] is pressed, the setting alternates between "PROHIBIT" and "PERMIT."

6 Convenient Functions

6.1 One-touch Operation "Direct Open"

The direct open function immediately shows the JOB CONTENT window or condition file contents of a job called by the CALL instruction. Move the cursor to the desired job name or condition file name and simply press the direct open key  to display the contents of the file. This function can be used for the following window:

- JOB CONTENT window for a job name directly specified by a CALL instruction
- CONDITION FILE window for a file name directly specified by a work instruction
- COMMAND POS window for a move instruction
- I/O window with an I/O instruction (when I/O numbers are specified)

<Example> Example Using Direct Open

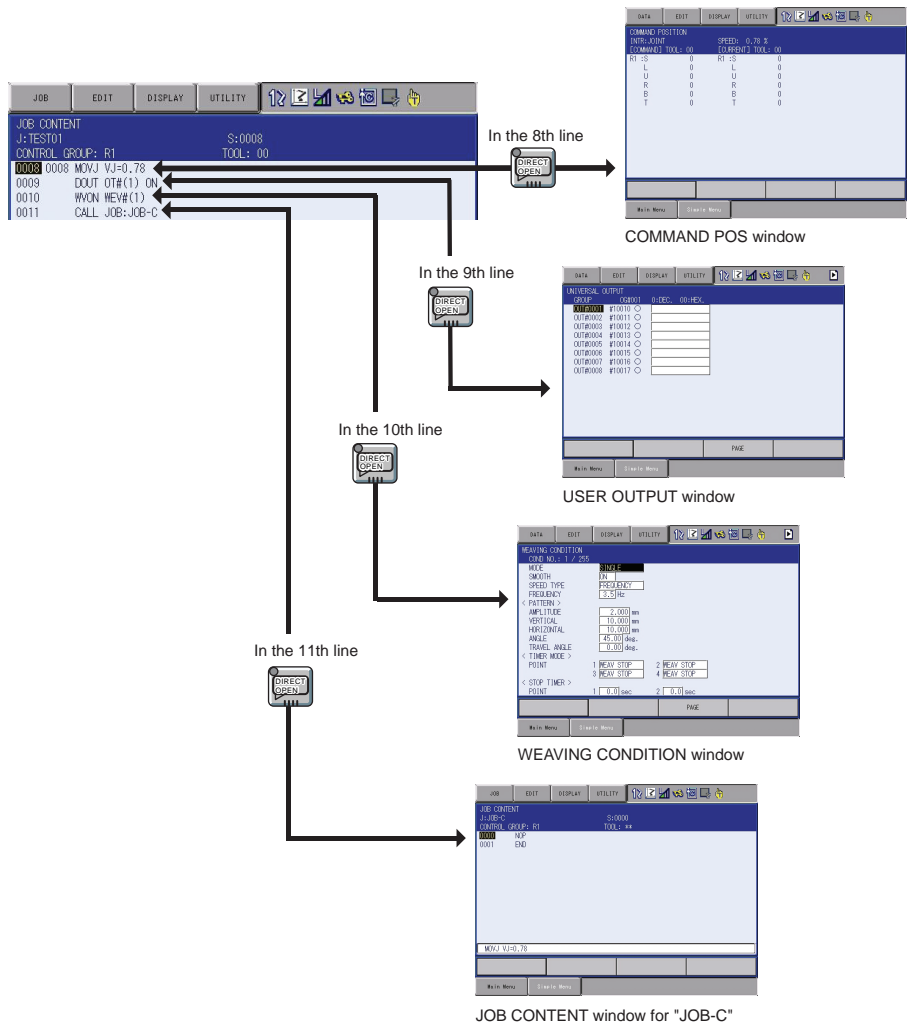

1. In the JOB CONTENT window, move the cursor to the job name or the condition file for which the window is to be displayed.

2. Press the direct open key .

– This key lamp lights and the JOB CONTENT window or the condition file window appears.

– When the direct open key  is pressed once again, the key lamp turns OFF, and the window returns to the former JOB CONTENT window.



- The direct open function cannot be used again while a directly opened window is shown.
- If another window is selected while the direct open function is effective, the function is automatically cancelled and the lamp on the direct open key goes out.
- Once another JOB CONTENT window is opened by the direct open function, the former job cannot be continuously operated. (Stopped until the opened JOB CONTENT window is closed.)

6.2 Parallel Shift Function

6.2.1 Function Overview

Parallel shift refers to the shifting of an object from a fixed position in such a way that all points within the object move an equal distance. In the model for parallel shift shown in the following, the shift value can be defined as the distance L (three-dimensional coordinate displacement). The parallel shift function is relevant to the actual operation of the manipulator because it can be used to reduce the amount of work involved in teaching by shifting a taught path (or position.)

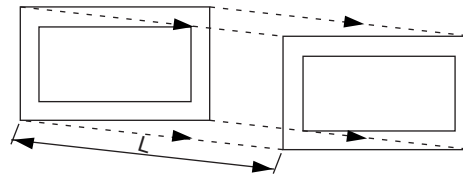

In the example in the figure below, the taught position A is shifted in increments of the distance L (this is actually a three-dimensional XYZ displacement that can be recognized by the robot) in order to enable the operation that was taught at position A to also be performed at positions B through G.

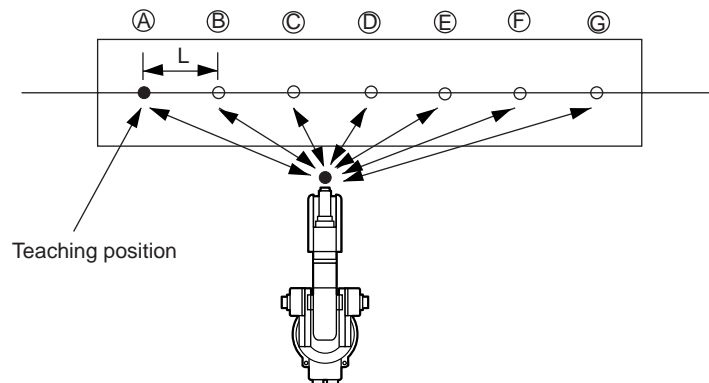

6.2.1.1 Parallel Shift of Step

The block from the SFTON to the SFTOF instructions is subject to the shift operation.

Line (Step)	Instruction	
0000	NOP	
0001(001)	MOVJ VJ=50.00	
0002(002)	MOVL V=138	
0003	SFTON P□□□UF# (1)	} Shifted block
0004(003)	MOVL V=138	
0005(004)	MOVL V=138	
0006(005)	MOVL V=138	
0007	SFTOF	
0008(006)	MOVL V=138	

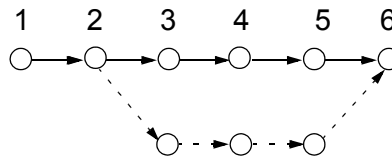

6.2.1.2 Parallel Shift of Job

When shifting an entire series of operations, the range to be shifted by the shift instruction can be set using the method indicated above, but the method shown in the following, in which just the part to be shifted is made into a separate job, can also be used.

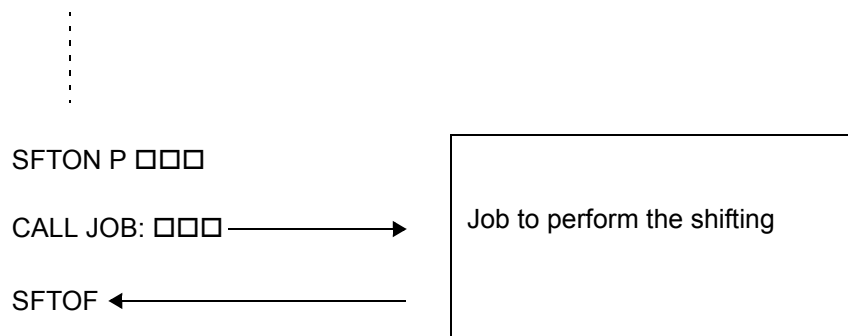

6.2.2 Setting the Shift Value

6.2.2.1 Coordinate Systems

The shift value for parallel shift is X, Y, and Z increment in each coordinate. There are four coordinates: base coordinates, robot coordinates, tool coordinates, and user coordinates. In systems with no servo track, the base coordinates and robot coordinates are the same.

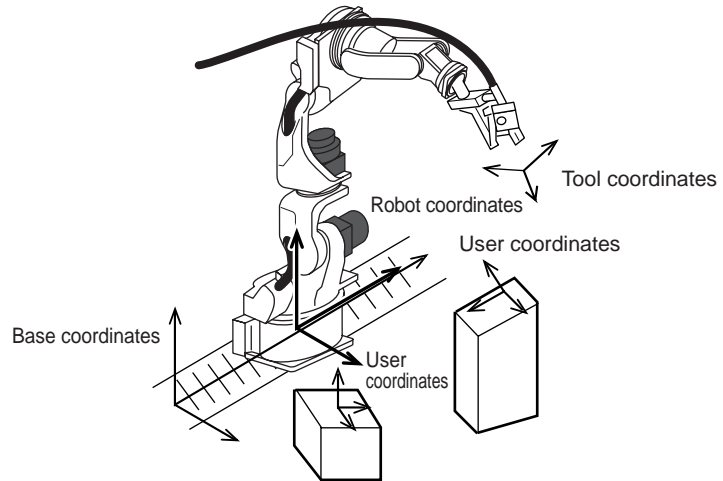

6.2.2.2 Setting the Shift Value

When setting the shift value for the position variables, use the current position (coordinates) of the manipulator in the window.

The screenshots show the 'CURRENT POSITION' window. The first window shows the 'Teaching position' with coordinates: R1: X=5,380 mm, Y=68,080 mm, Z=318,940 mm, R1=-179.81 deg, R2=-2.17 deg, R3=-102.89 deg. The second window shows the 'Position to be shifted' with coordinates: R1: X=105,380 mm, Y=68,080 mm, Z=418,940 mm, R1=-179.81 deg, R2=-2.17 deg, R3=-102.89 deg. The third window shows the 'POSITION VARIABLE' window where the shift values are set: X=-100,000, Y=0,000, Z=-100,000, R1=0,0000, R2=0,0000, R3=0,0000, and tool/flip settings.

Teaching position

Position to be shifted
(Move the manipulator using the programming pendant.)

Differences are assumed to be shift amounts.

The shift value is the X, Y, and Z difference between the shift position and teaching position and the difference in angular displacement RX, RY, And RZ (normally set at "0"). If shifting is executed at equal pitch intervals, for example for palletizing, find the difference between the teaching position

and the final shift position, then divide by the number of pitch intervals (number of divisions) to calculate the shift value per pitch.

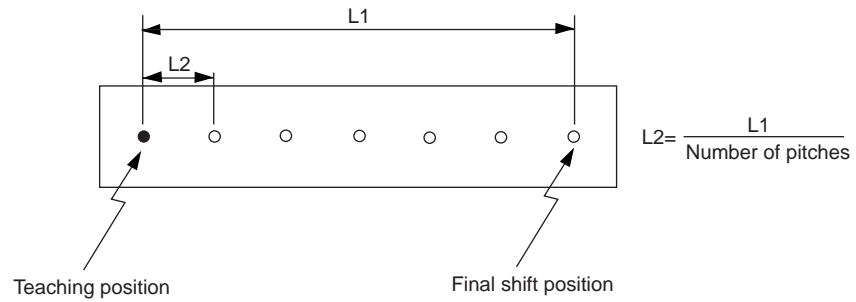

The posture of the wrist is defined by the angular displacement of the coordinates of the wrist axes. Consequently, if the shift value is specified with X, Y, and Z only ($RX, RY, RZ=0$), the wrist is shifted while maintaining the same posture as at the teaching point. Since shifting is normally performed without changing the posture, there is no need to specify an angular displacement for the wrist. The motion when a parallel shift is performed is shown in the following:

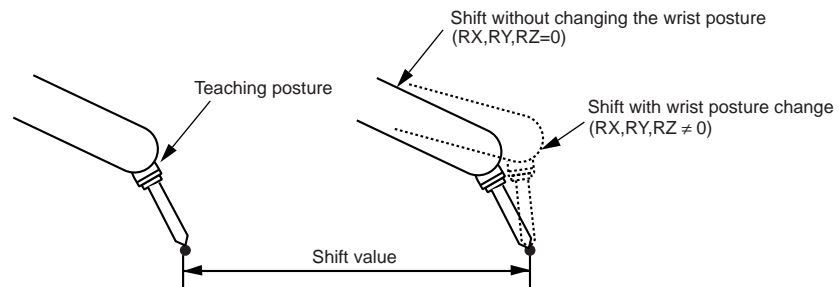

The shift value is calculated on the position data window for the coordinates in which the shift is performed. Since this is normally performed in the user coordinates, the position data window for the user coordinates is used.

6.2.3 Registering Shift Instructions

To register the instruction, move the cursor to the address area in the JOB CONTENT window during teach mode as follows:

1. Select {JOB} under the main menu.
2. Select {JOB}.
 - The JOB CONTENT window appears.



3. Move the cursor to the address area.

6.2.3.1 SFTON Instruction

This is the instruction that starts a parallel shift.

1. Move the cursor to the line immediately before where the SFTON instruction is to be registered.

Line immediately before where SFTON instruction is to be registered. →

0020	MOVL V=138
0021	MOVL V=138
0022	MOVL V=138

2. Press [INFORM LIST].
 - The instruction list dialog box appears.

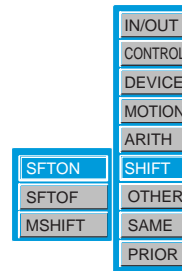

3. Select {SHIFT}.
4. Select the SFTON instruction.
 - The SFTON instruction is displayed in the input buffer line.
5. Modify the additional items or number values as required.
 - **<When Nothing is to be Changed>**
Proceed to Step 6.
 - **<When Editing Additional Items>**
 - Adding or modifying additional items
To change the position variable number, move the cursor to the position variable number and press [SHIFT] + the cursor key to increase or decrease the value.

⇒ SFTON P000

To directly input the value using the Numeric keys, press [SELECT] to display the input buffer line.

P =

⇒ SFTON █

After the number is input, press [ENTER] to modify the number value in the input buffer line.

- Adding the coordinate system in which the shift is performed
Move the cursor to the instruction in the input buffer line and press [SELECT]. The DETAIL EDIT window appears.

⇒ SFTON P001

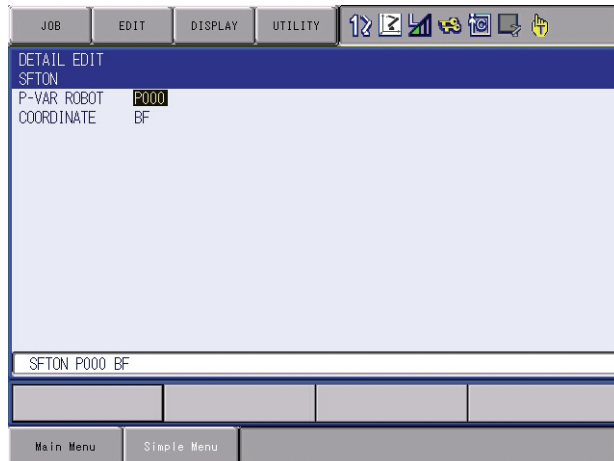

- Line up the cursor with "UNUSED" and press [SELECT]. The selection dialog box appears. Line up the cursor with the coordinate system to be added, and press [SELECT].

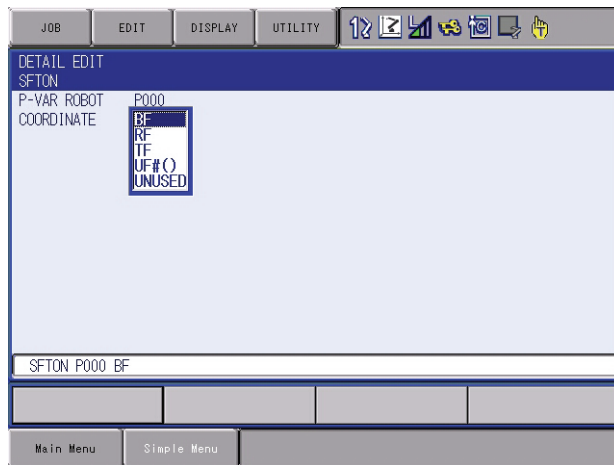

- After the coordinate system addition is completed, press [ENTER]. The DETAIL EDIT window closes and the JOB CONTENT window appears.

6. Press [INSERT] and then [ENTER].

- The instruction displayed in the input buffer line is registered.

Line where SFTON instruction is registered. →

0020	MOVL V=138
0021	SFTON P001 BF
0022	MOVL V=138

6.2.3.2 SFTOF Instruction

This is the instruction that ends a parallel shift.

1. Move the cursor to the line immediately before where the SFTOF instruction is to be registered.

Line immediately before where SFTOF instruction is to be registered. →

0030	MOVL V=138
0031	MOVL V=138

2. Press [INFORM LIST].
 - The instruction list dialog box appears.
3. Select {SHIFT}.
4. Select the SFTOF instruction.
 - The SFTOF instruction is displayed in the input buffer line.

⇒ SFTOF

5. Press [INSERT] and then [ENTER].
 - The SFTOF instruction is registered.

0030	MOVL V=138
0031	SFTOF
0032	MOVL V=138

6.2.3.3 MSHIFT Instruction

When a parallel shift of the wrist posture is attempted, the manipulator may not be shifted to the target posture in the following cases.

- Posture displacement (Rx, Ry, Rz) is specified to the shift value set by the user.
- When a displacement between two points is calculated using an INFORM operating instruction (ADD instruction, SUB instruction, etc.), and a posture displacement (Rx, Ry, Rz) is specified in the shift value.

In such cases, the MSHIFT instruction can be used to automatically calculate the optimum shift value for an operation to reach the target shift position and posture. With an MSHIFT instruction, the shift value between the reference position and the target position (shift position) when the parallel shift is performed is determined in the specified coordinate system, and set as the specified position variable.

1. Move the cursor to the line immediately before where the MSHIFT instruction is to be registered.

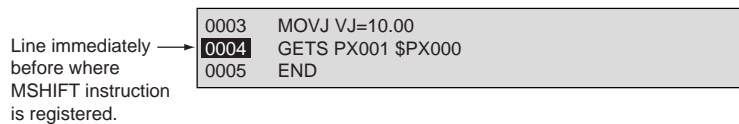

2. Press [INFORM LIST].

- The instruction list dialog box appears.

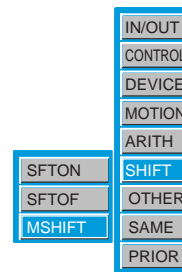

3. Select {SHIFT}.

4. Select the MSHIFT instruction.

- The MSHIFT instruction is displayed in the input buffer line.

5. Change the number data or additional items as required.

- **<When Nothing is to be Changed>**

Proceed to Step 6.

- **<When Editing Additional Items>**

- Adding or modifying additional items

To change the position variable number, move the cursor to the position variable number and press [SHIFT] + the cursor key to increase or decrease the value.

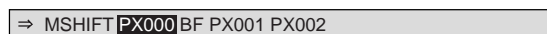

To directly input the value using the Numeric keys, press [SELECT] to display the input buffer line.

PX =
 ⇒ MSHIFT BF PX001 PX002

After the number is input, press [ENTER] to modify the number value in the input buffer line.

- Changing the coordinate system in which the shift is performed
 Move the cursor to the instruction in the input buffer line and press [SELECT]. The DETAIL EDIT window appears.

⇒ MSHIFT PX000 BF PX001 PX002

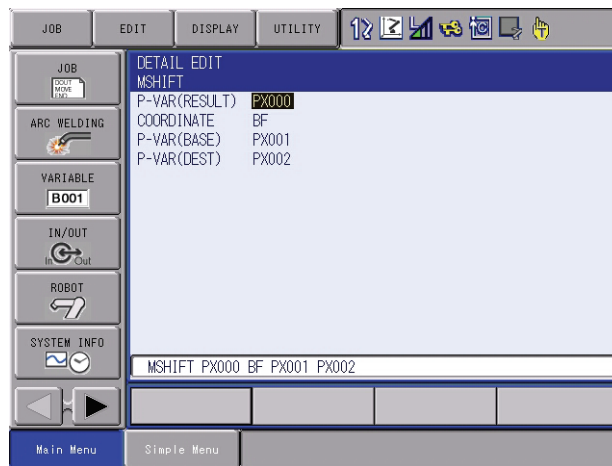

Line up the cursor with “BF” and press [SELECT]. The selection dialog box appears.

Line up the cursor with the coordinate system to be changed, and press [SELECT].

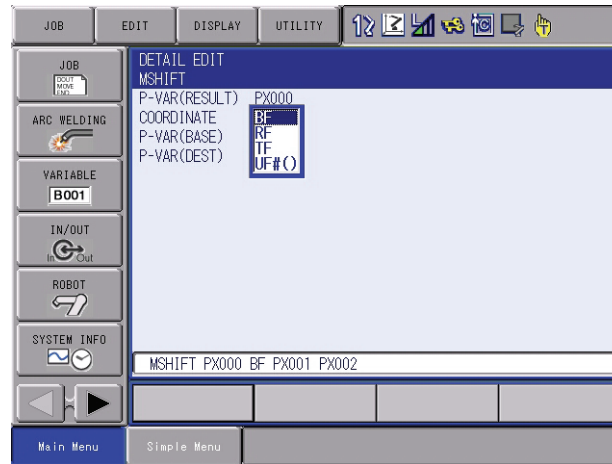

After the coordinate system modification is complete, press [ENTER]. The DETAIL EDIT window closes and the JOB CONTENT window appears.

6. Press [INSERT] and then [ENTER].

– The instruction displayed in the input buffer line is registered.

Line where MSHIFT is registered. →

0003	MOVJ VJ=10.00
0004	GETS PX001 \$PX000
0005	MSHIFT PX000 RF PX001 PX002

6.2.4 Continuation of the Parallel Shift Function**CAUTION**

- If the shift function is cancelled through a job editing operation after the execution of a parallel shift instruction, the job must be started again from the beginning.
- Because no shift is performed when the operation is restarted, there is a possibility of interference between the workpiece and fixture.

If any of the following operations are performed after executing a parallel shift instruction, the shift function is cancelled.

- Job editing operation (changing, deleting, adding)
- Job copy, job name change
- Registering a new job, deleting a job, or modifying a selected job
- Restart after the alarm occurs
- When control power is turned OFF



With any operation other than those listed above, the parallel shift function remains in effect .

6.2.5 Examples of Use

6.2.5.1 Example of Use of Shift Addition/Subtraction

Table 6-1: Workpiece Stacking Operation

Line	Instruction	
0000	NOP	
0001	SET B000 0	
0002	SUB P000 P000	Make the first shift value zero.
0003	*A	
0004	MOVJ	Step 1
0005	MOVL	Step 2
0006	'Gripping workpiece	
0007	MOVL	Step 3
0008	MOVL	Step 4
0009	SFTON P000 UF#(1)	Shift start
0010	MOVL	Shift position Step 5
0011	'Releasing workpiece	
0012	SFTOF	Shift end
0013	ADD P000 P001	Add the shift value for the next operation.
0014	MOVL	Step 6
0015	MOVL	Step 7
0016	INC B000	
0017	JUMP *A IF B00<6	
0018	↓	
	SFTON P000 UF#(1)	Since the shift data is retained in memory, the same data can be used (with subtraction instead of addition) to perform a workpiece unloading operation.
	SFTOF	
	SUB P000 P001	

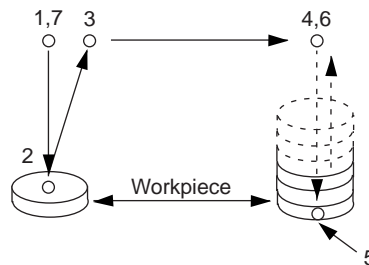

6.2.5.2 Example of Use of MSHIFT Instruction

Line	Instruction	Explanation
0000	NOP	
0001	MOVJ VJ=20.00	Move the manipulator to the reference position.
0002	GETS PX000 \$PX000	Set the reference position as position variable P000.
0003	MOVJ VJ=20.00	Move the manipulator to the target position.
0004	GETS PX001 \$PX000	Set the target position as position variable P001.
0005	MSHIFT PX010 BF PX000 PX001	Set shift value and set it as position variable P010.
0006	END	

6.3 Parallel Shift Job Conversion Function

6.3.1 Function Overview

If the manipulator and base positions are moved after a job has been taught, the entire job has to be modified. The parallel shift conversion function shortens the modification time required in cases like this by shifting all steps of the job by the same value to create a new job.

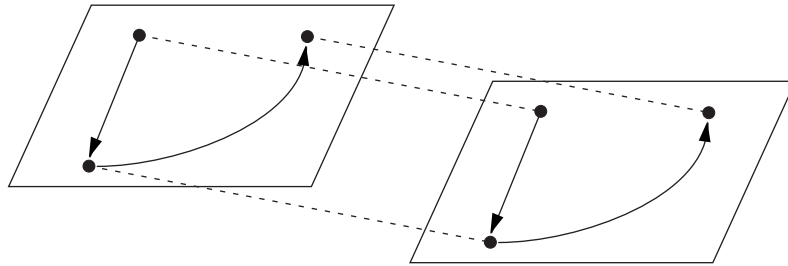

When the parallel shift conversion is performed, all job steps are shifted by the same value.

Steps Outside the P-point Maximum Envelope

- “/OV” is displayed for the steps which result in a position outside the P-point maximum envelope of the manipulator. When the position is corrected, “/OV” display disappears.

Position Variable



- Position variables are not subject to the parallel shift job conversion.

Not Converted Job

- The following jobs cannot be converted. If conversion is attempted, no operation is performed.
 - Jobs without any group axes
 - Concurrent jobs (optional)



CAUTION

- If a job name after conversion is not specified when executing the parallel shift job conversion, the position data of the job is shifted and converted, then the data is overwritten with a new position data after the shift. Be sure to save the job in the external memory device or create the same job by copying before executing conversion.

6.3.2 Coordinate Systems for Conversion

When performing the parallel shift job conversion, it is necessary to specify the coordinate systems in which the conversion is to be performed. The coordinate system can be selected from the following:

- Base coordinates
- Robot coordinates
- Tool coordinates
- User coordinates (64 types)
- Master tool coordinates (R*+R* job)
- Pulse coordinates

In the case of an ordinary job for which group axes are registered, shift conversion is performed in accordance with the selected coordinate system. The relationship between group combinations and coordinates are shown in the following table.

1 to 4 in the table are followed by their explanations.

Table 6-2: Relationship Between Group Combinations and Coordinates at Conversion

Group Combination in Job	Explanation	
	Usable Coordinate System	
R	Shift is performed on the basis of selected coordinates. Base coordinates, robot coordinates, tool coordinates, user coordinates, pulse coordinates	
R(B)	Shift is performed on the basis of selected coordinates.	
	1. Base Coordinates	The base axis is shifted by the specified amount and the TCP of the manipulator is shifted by the specified amount in the base coordinates.
	2. Robot Coordinates	The base axis is shifted by the specified amount. The TCP of the manipulator is shifted by the specified amount in the robot coordinates. These shifts are carried out independently.
	3. Tool Coordinates	The base axis is shifted by the specified amount. The TCP of the manipulator is shifted by the specified amount in the tool coordinates. These shifts are carried out independently.
	4. User Coordinates	The base axis is shifted by the specified amount and the TCP of the manipulator is shifted by the specified amount in the user coordinates.
	5. Pulse Coordinates	The taught position of each axis is shifted by the specified amount on the basis of pulse values.
S	Shift is performed on the basis of pulse values regardless of the coordinates.	

Table 6-2: Relationship Between Group Combinations and Coordinates at Conversion

R+S	<p>The manipulator is shifted in the selected coordinates. The station axis is shifted on the basis of pulse values regardless of the coordinates.</p> <p>Base coordinates, robot coordinates, tool coordinates, user coordinates, pulse coordinates</p>
R(B)+S	<p>The manipulator is shifted in the selected coordinates, as in 1 to 5 above. The station axis is shifted on the basis of pulse values regardless of the coordinates.</p>
R+R	<p>Two manipulators are shifted in the selected coordinates.</p> <p>Base coordinates, robot coordinates, tool coordinates, user coordinates, master tool coordinates ¹⁾, pulse coordinates</p>
R(B)+R(B)	<p>Two manipulators are shifted in the selected coordinate system, as in 1 to 5 above. Two base axes are also shifted.</p>

1 In the master tool coordinates, conversion only occurs at the “slave” from the standpoint of the SMOV instruction.

■ About 1 to 4 in the Table

1. Base Coordinates

The base axis is shifted by B and the TCP of the manipulator is shifted by A in the base coordinates.

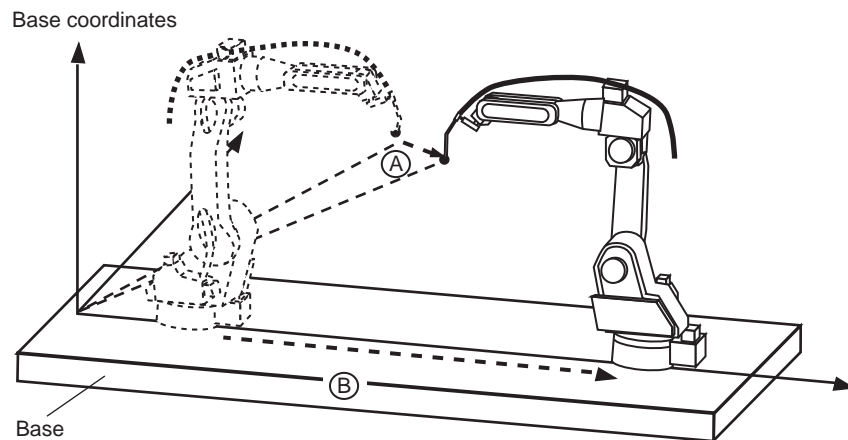

2. Robot Coordinates

The base axis is shifted by B. The TCP of the manipulator is shifted by A in the robot coordinates. These shifts are carried out independently.

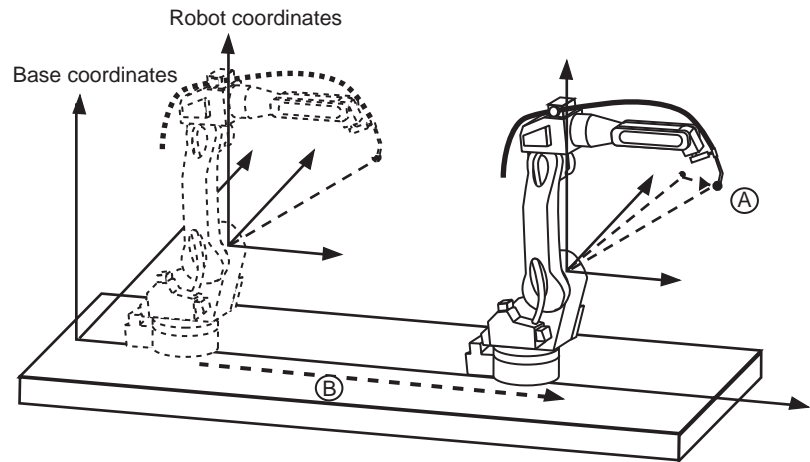

3. Tool Coordinates

The base axis is shifted by B and the TCP of the manipulator is shifted by A in the tool coordinates. These shifts are carried out independently.

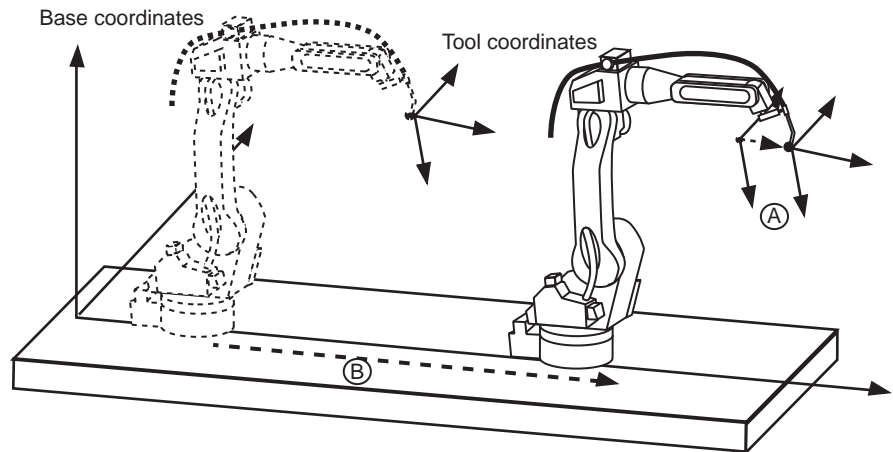

4. User Coordinates

The base axis is shifted by B and the TCP of the manipulator is shifted by A in the user coordinates. These shifts are carried out independently.

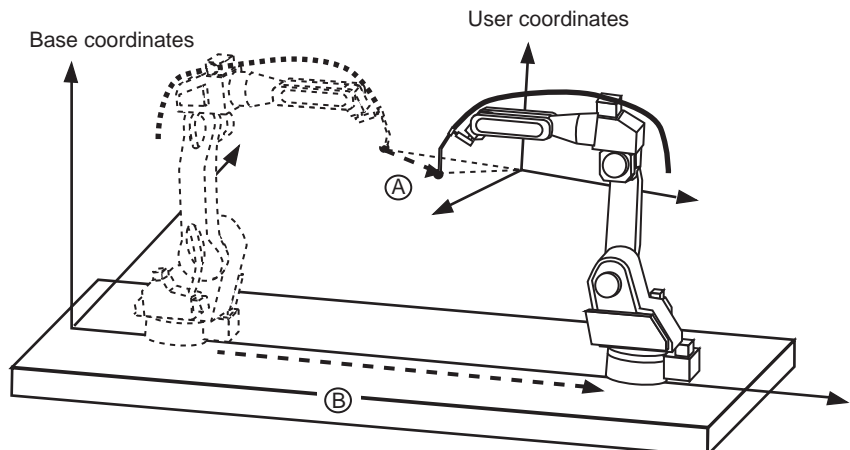

■ **Converting R*+R* Jobs with Master Tool Coordinates**

R*+R* coordinated jobs can be subjected to the parallel shift job conversion in the master tool coordinates. Only the steps taken at the “slave” from the standpoint of the SMOV instruction are subject to conversion (i.e. the steps of R2 in the figure below).

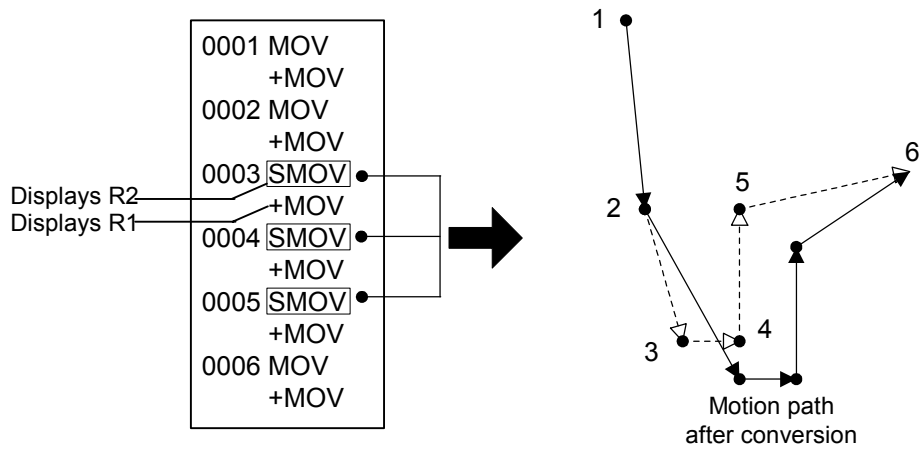
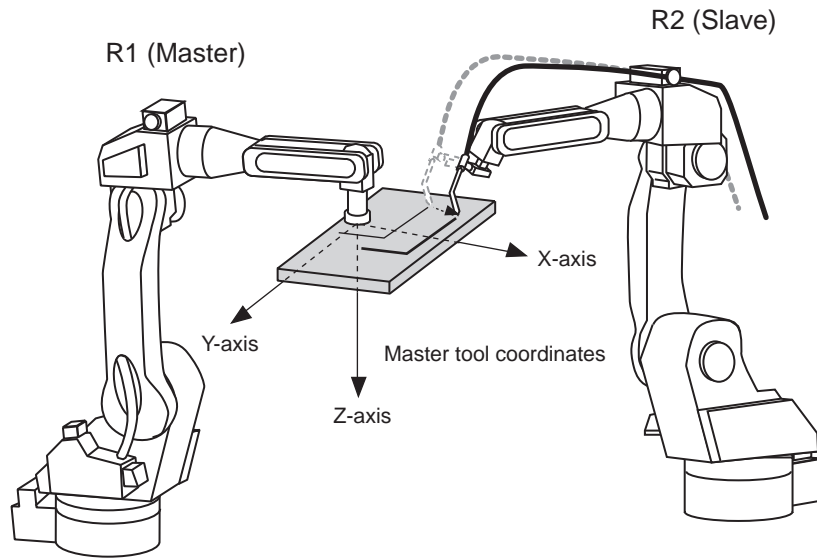

6.3.3 Executing the Parallel Shift Job Conversion

6.3.3.1 Window Display

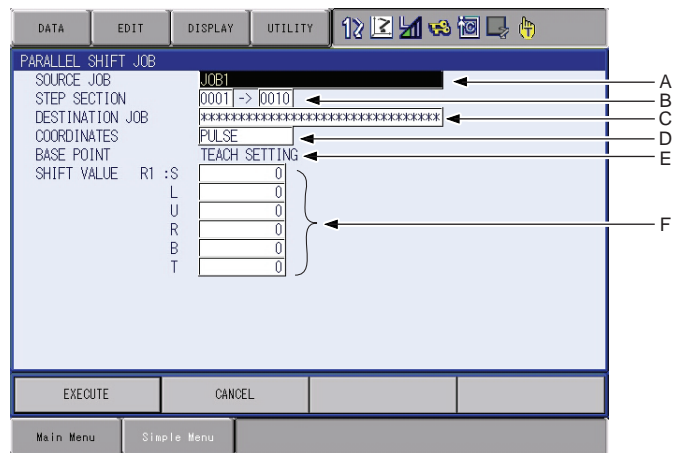

A. SOURCE JOB

Selects the job before conversion. The job which is shown in the JOB CONTENT window is set initially. To change the job, perform the following procedure.

Move the cursor to the job name and press [SELECT]. The JOB LIST window appears. Select the desired job.

B. STEP SECTION (Start Step → End Step)

Specifies the step section of the source job. All the steps are set initially. If there is no step in the source job, “***” is displayed. To change the section, perform the following procedure.

Move the cursor to the step section indication and press [SELECT]. The input buffer line appears. Input the step number and press [ENTER].

C. DESTINATION JOB

Specifies the converted job. If this is not specified (“*****” is displayed), the source job is overwritten with a job after conversion. If the converted job is specified, the source job is copied and converted. To change the job, perform the following procedure.

Move the cursor to the converted job name indication and press [SELECT]. The character input line appears. The source job name is displayed in the input line. To enter a job name without using the source job name, press [CANCEL] and then input a job name.

D. COORDINATES

Selects the conversion coordinates. Move the cursor to the coordinates name and press [SELECT]. The selection dialog box appears. Select the desired coordinates.

When the user coordinates are selected, the input buffer line appears. Input the desired user coordinate number and press [ENTER].

E. BASE POINT

Calculates the difference by the two teaching points as a shift value.

F. SHIFT VALUE

The axis shown is varied according to the setting of “4. coordinates” above.

Move the cursor to the input box and press [SELECT] to directly input the shift value.

If the shift value is calculated by the two teaching points, the difference is shown as a shift value.

6.3.3.2 Parallel Shift Job Conversion Operation

There are two methods for specifying the shift value.

- Directly input the shift value by numerical value.
- Calculate the shift value by teaching the original base point and converted base point.



The method using position variables by parameter setting is described in *chapter 6.3.4 "Specifying the Shift Value by Position Variables" at page 6-29* other than above two methods.

The following are the operation procedures by each setting of shift value for parallel shift job conversion.

■ **Numerical Value Input**

1. Select {JOB} under the main menu.
2. Select {JOB}.
 - The JOB CONTENT window appears.
3. Select {UTILITY} under the pull-down menu.
4. Select {PARALLEL SHIFT JOB}.
 - The PARALLEL SHIFT JOB window appears.

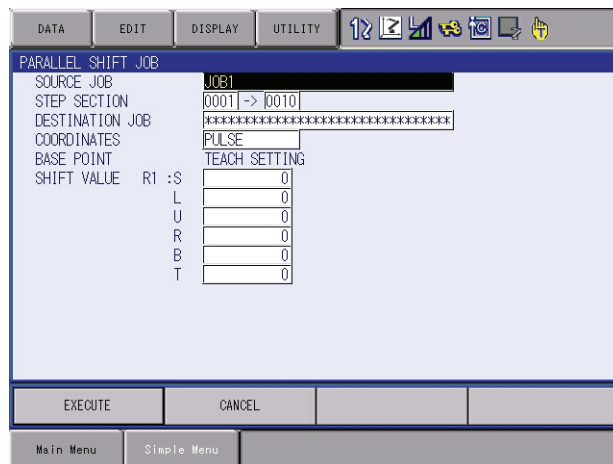

5. Specify the conversion items.
 - Specify each item.

6. Select the shift value to be set.
 - The number can be entered.

The screenshot shows the 'PARALLEL SHIFT JOB' window with the following fields and values:

SOURCE JOB	JOB1
STEP SECTION	0001 => 0010
DESTINATION JOB	JOB2
COORDINATES	ROBOT
BASE POINT	TEACH SETTING
SHIFT VALUE R1 :X	0.000
Y	0.000
Z	0.000

Buttons at the bottom: EXECUTE, CANCEL, Main Menu, Simple Menu.

7. Type the shift value using the Numeric keys.
8. Press [ENTER].
 - The shift value is set.

The screenshot shows the 'PARALLEL SHIFT JOB' window with the following fields and values:

SOURCE JOB	JOB1
STEP SECTION	0001 => 0010
DESTINATION JOB	JOB2
COORDINATES	ROBOT
BASE POINT	TEACH SETTING
SHIFT VALUE R1 :X	200.000
Y	0.000
Z	0.000

Buttons at the bottom: EXECUTE, CANCEL, Main Menu, Simple Menu.

9. Display the PARALLEL SHIFT JOB window. Select "EXECUTE."
 - The confirmation dialog box appears when the converted job is not specified. Select "YES" then the conversion is executed.
 - The JOB CONTENT window appears when the conversion is completed.

- When "CANCEL" is selected, the display goes back to the JOB CONTENT window without executing conversion.

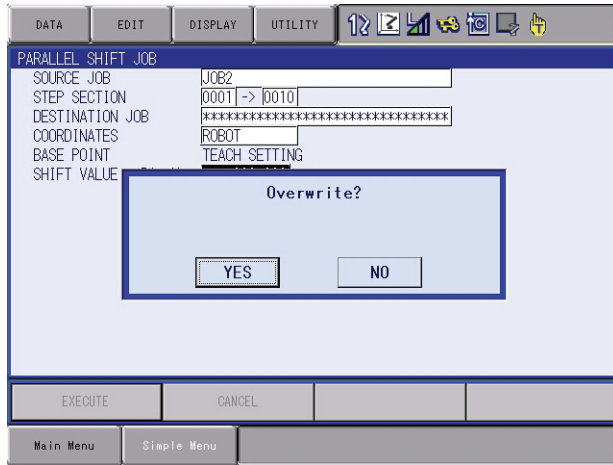

If an alarm occurs during conversion, conversion is suspended.

■ Calculation by Teaching

1. Select {JOB} under the main menu.
2. Select {JOB}.
 - The JOB CONTENT window appears.
3. Select {UTILITY} under the pull-down menu.
4. Select {PARALLEL SHIFT JOB}.
 - The PARALLEL SHIFT JOB window appears.

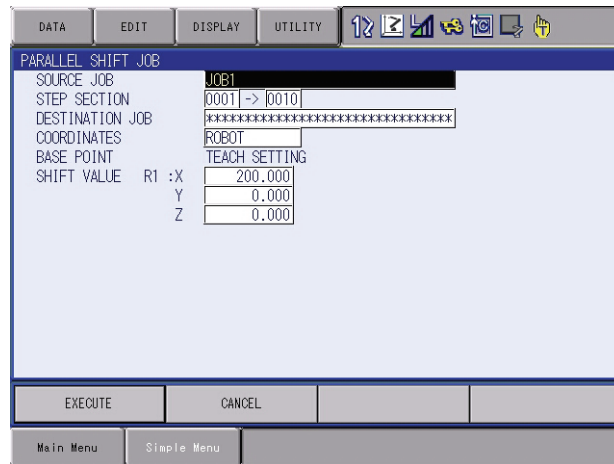

5. Specify the conversion items.
 - Specify each item.
6. Display the PARALLEL SHIFT JOB window. Select “TEACH SETTING” in the item of “BASE POINT.”
 - The BASE POINT window appears.



7. Select “BASE POINT(SRC).”
8. Move the manipulator to the original base point by the axis keys.

9. Press [MODIFY] and [ENTER].

- The original base point is set.

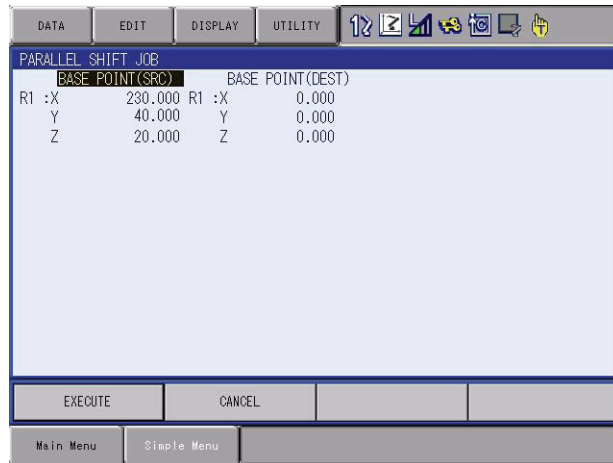

10. Select “BASE POINT(DEST).”

11. Move the manipulator to the converted base point by the axis keys.

12. Press [MODIFY] and [ENTER].

- The conversion base point is set.

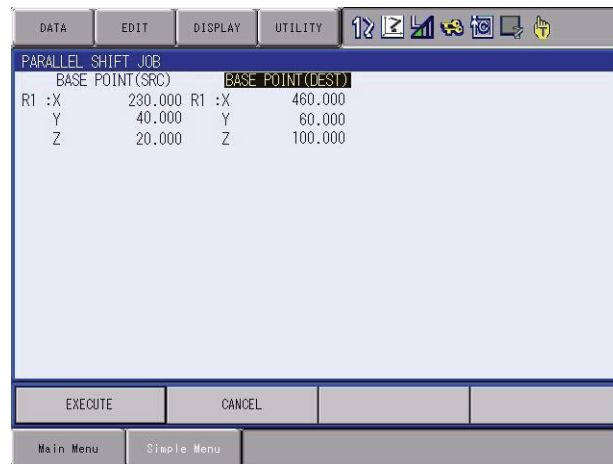

13. Touch “EXECUTE.”

- The difference is calculated by the two teaching points and set as a shift value.

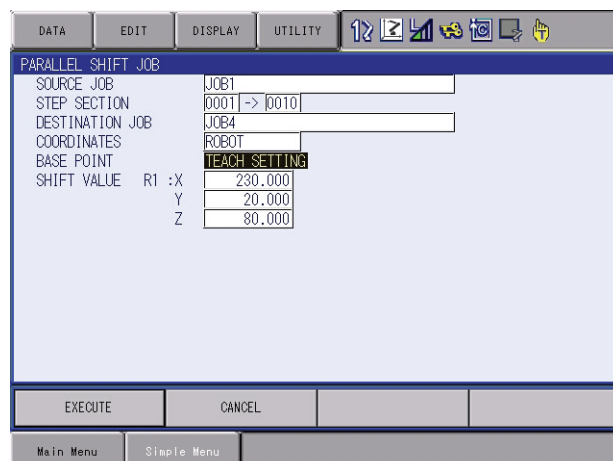

14. Display the PARALLEL SHIFT JOB window. Select “EXECUTE.”
- The confirmation dialog box appears when the converted job is not specified. Select “YES” then the conversion is executed.
 - The JOB CONTENT window appears when the conversion is completed.
 - When “CANCEL“ is selected, the display goes back to the JOB CONTENT window without executing conversion.

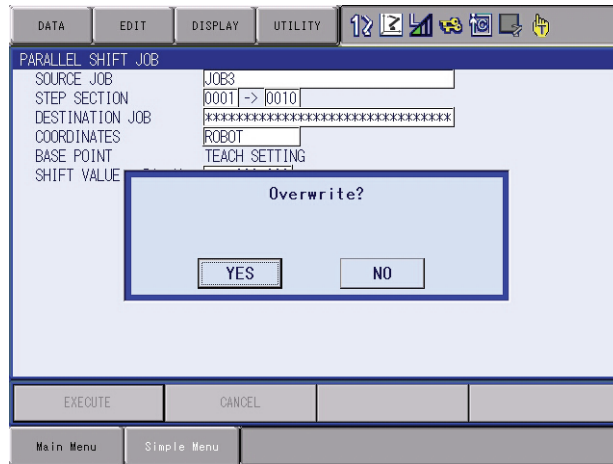

If an alarm occurs during conversion, conversion is suspended.

6.3.4 Specifying the Shift Value by Position Variables

The shift value can be specified using position variables by parameter settings.

Parameter S2C652: SHIFT VALUE FOR PARALLEL SHIFT JOB CONVERSION

0: Shift value by numeral/teaching (Initial setting)

1: Position variable shift value

6.3.4.1 Window Display

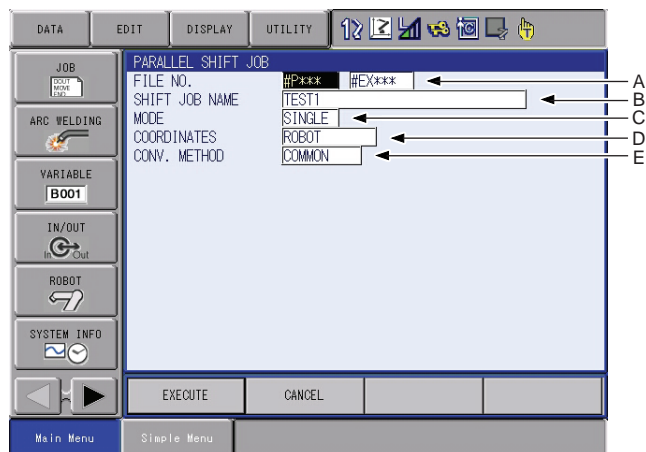

A. FILE NO.

Specifies position variables.

B. SHIFT JOB NAME

The job which was shown in the JOB CONTENT window is set initially. To change the job, perform the following procedure.

Move the cursor to the conversion job name and press [SELECT]. The JOB LIST window appears. Move the cursor to the desired job and press [SELECT]. The PARALLEL SHIFT JOB window reappears, and the job name which was selected is shown.

C. MODE

Specifies the conversion mode.

SINGLE (INDEPENDENT JOB CONVERSION)

Only the selected job is converted even if the selected job includes the jobs called by JUMP or CALL instructions. Related jobs are not converted.

RELATIVE (RELATIVE JOB CONVERSION)

Both the selected job and all the related jobs (the jobs called by JUMP or CALL instructions) are converted.

For details of each conversion mode, refer to *chapter 6.3.4.2 "Jobs Targeted for Conversion"*.

D. COORDINATES

Selects the conversion coordinates.

Move the cursor to the coordinates name and press [SELECT]. The selection dialog box appears. Select the desired coordinates.

When the user coordinates are selected, the input buffer line appears. Input the desired user coordinate number and press [ENTER].

E. CONV. METHOD

Specifies the conversion methods of related jobs such as a coordinated job with two manipulators or the system with multiple stations.

COMMON (COMMON SHIFT)

All the manipulators (or all the bases, or all the stations) are converted by the same shift value.

EACH (INDIVIDUAL SHIFT)

Each manipulator (or each base, or each station) is converted separately by different shift values.

For details of each conversion method, refer to *chapter 6.3.4.3 "Conversion of Coordinated Jobs" at page 6-32.*

6.3.4.2 Jobs Targeted for Conversion

There are two ways to specify the job to be converted as described in the following:

- Independent Job Conversion
Only the selected job is converted even if the selected job includes the jobs called by JUMP or CALL instructions. Related jobs are not converted.

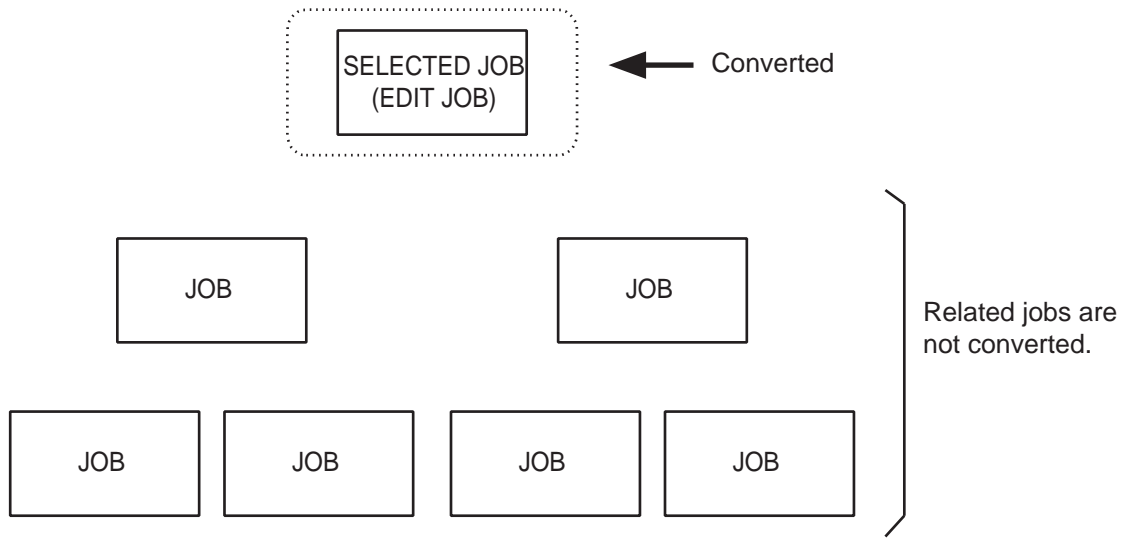

- Related Job Conversion
Both the selected job and all the related jobs (the jobs called by JUMP or CALL instructions) are converted.

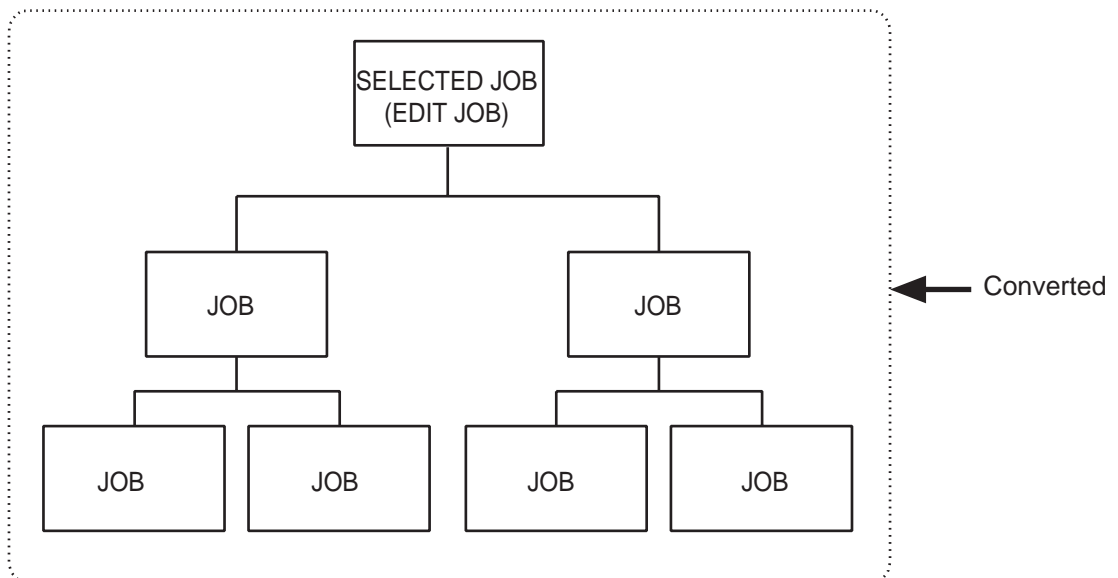

6.3.4.3 Conversion of Coordinated Jobs

There are two ways to convert a related job such as a coordinated job with two manipulators or the system with multiple stations as described in the following:

■ Common Shift

All the manipulators (or all the bases, or all the stations) are converted by the same shift value.

Coordinated job with R1+R2

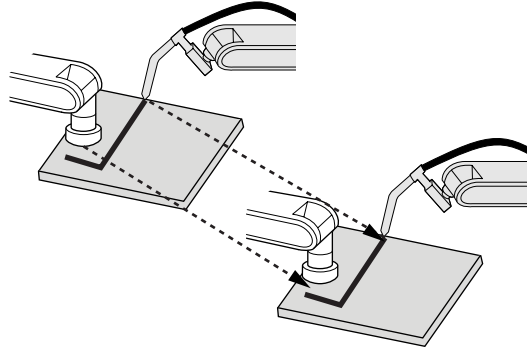

The system with multiple stations

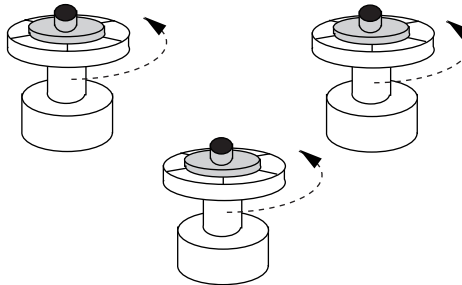
**■ Individual Shift**

Each manipulator (or each base, or each station) is converted separately by different shift values.

Coordinated job with R1+R2

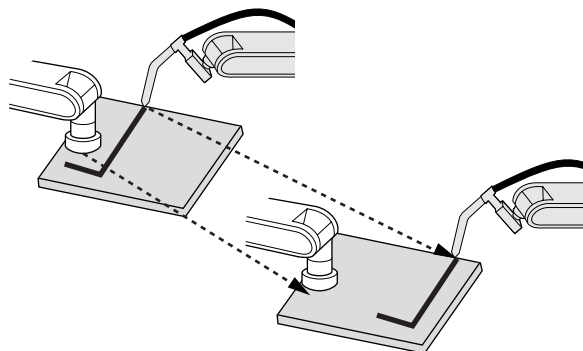

The system with multiple stations

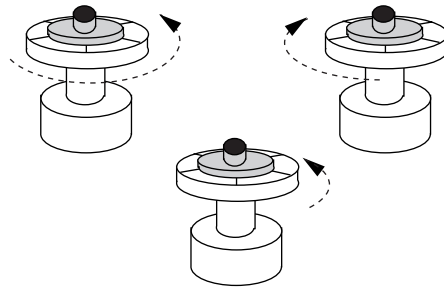

■ Variables used in an individual shift



Be sure to use the variables of which numbers are consecutive after the selected number. The variables of which numbers are not consecutive are unable to be selected.

Example 1) When selecting P010 for a coordinated job with R1 + R2:

Use P010 for R1.

Use P011 for R2.

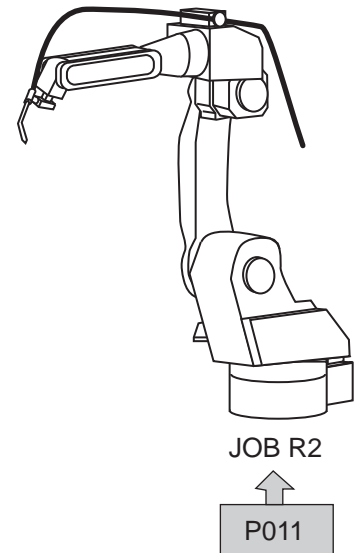
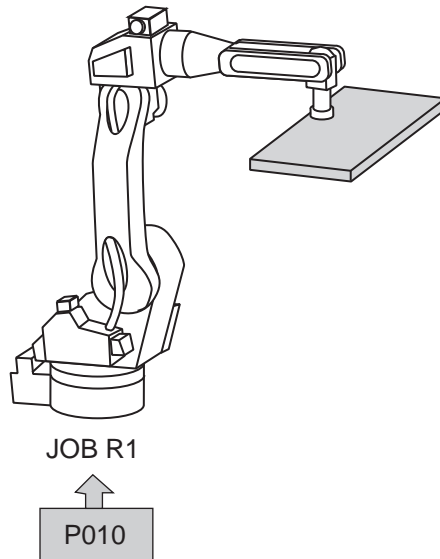

Example 2) When selecting EX005 for multiple jobs with four stations:

Use EX005 for S1.

Use EX006 for S2.

Use EX007 for S3.

Use EX008 for S4.

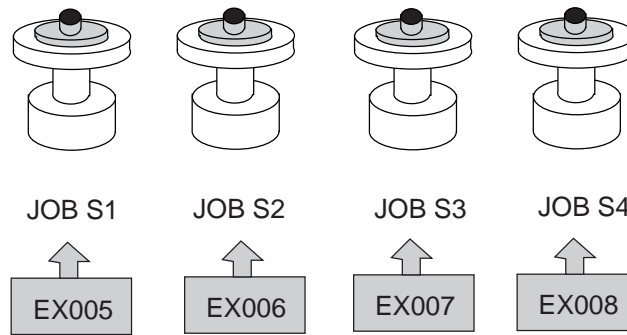

■ **Relation between variables and jobs for conversion in an individual shift**

■ **In the case of independent job conversion:**

- Coordinated job with R1 + R2
 Different shift values can be set for each manipulator and base.

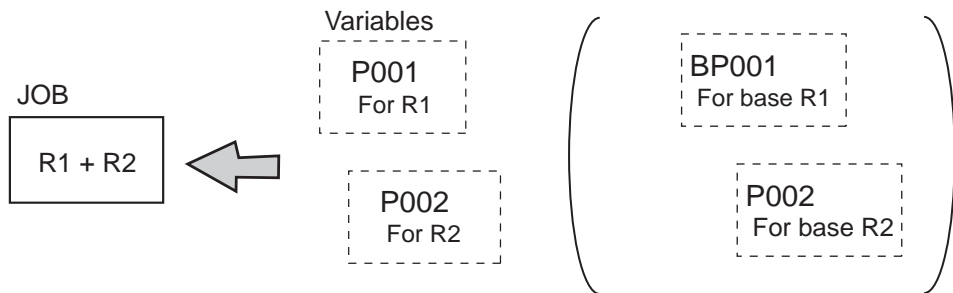

- Job with R□ (+ S□)
 Use one variable for a job with one manipulator.

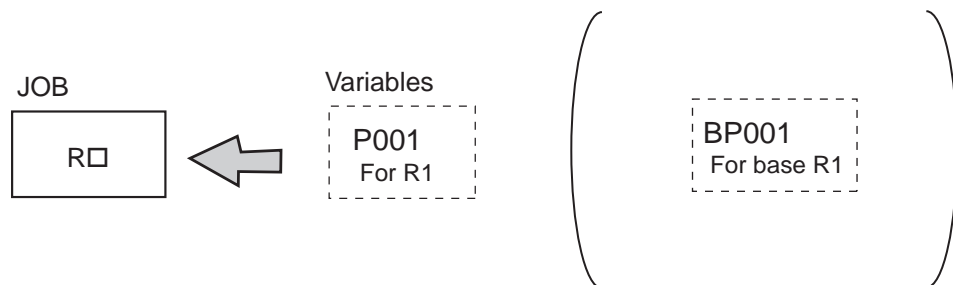

■ **In the case of related job conversion:**

- Different shift values can be set for each manipulator, base, and station.

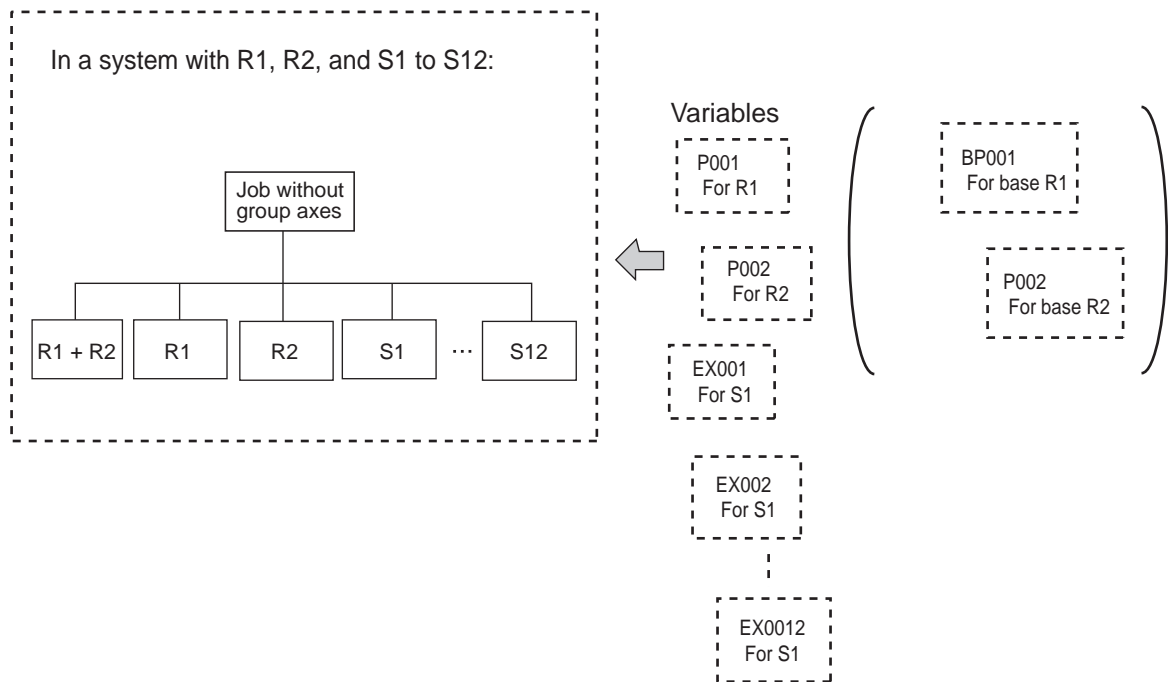

6.3.4.4 Operation Procedure

The following is the operation procedure for the parallel shift job conversion using position variables.

1. Set the parameter.
 - Set the parameter S2C652 (SHIFT VALUE FOR PARALLEL SHIFT JOB CONVERSION) to 1 (Position variable shift value.)
2. Set the position variable.
 - Specify a position variable in advance when setting a shift value by position variables.
 - For the setting of position variables, refer to *chapter 3.9.4 "User Variables" at page 3-71*.
3. Select {JOB} under the main menu.
4. Select {JOB}.
 - The JOB CONTENT window appears.
5. Select {UTILITY} under the pull-down menu.
6. Select {PARALLEL SHIFT JOB}.

- The PARALLEL SHIFT JOB window appears.

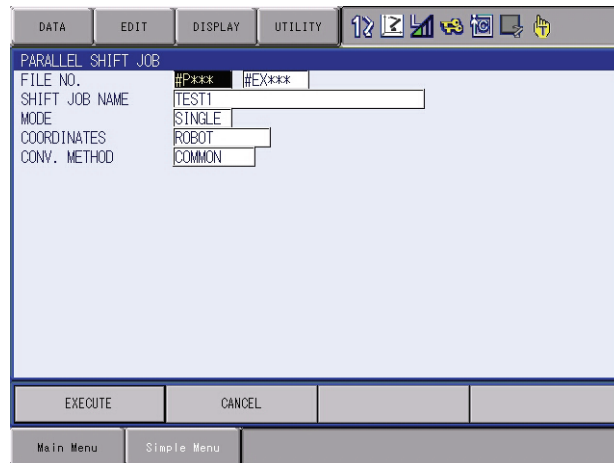

7. Specify the conversion items.
 - Specify each item.
8. Select “EXECUTE.”
 - Select “EXECUTE” then the parallel shift job conversion is executed. The JOB CONTENT window appears when the conversion is completed.
 - When “CANCEL“ is selected, the display goes back to the JOB CONTENT window without executing conversion.



If an alarm occurs during conversion, conversion is suspended.



Specify the position variable in advance when using the setting value as a shift value.

6.4 PAM Function

6.4.1 Function Overview

The function for position adjustment during playback (PAM: Position Adjustment by Manual) allows position adjustment by simple operations while observing the motion of the manipulator and without stopping the manipulator. Positions can be adjusted in both teach mode and play mode.

The following data can be adjusted by key input from the programming pendant.

- Teaching Point (Position)
- Teaching Point (Posture angle)
- Operation Speed
- Position Level

6.4.1.1 Input Ranges for Adjustment Data

The input ranges for adjustment data are indicated in the following table.

Data	Input Range
Number of Steps for Adjustment	Up to 10 steps can be adjusted at the same time.
Position Adjustment Range (X, Y, Z)	Unit: mm, valid to two decimal places, maximum ± 10 mm
Posture Angle Adjustment Range (Rx, Ry, Rz)	Unit: deg, valid to two decimal places, maximum ± 10 deg
Speed Adjustment Range (V)	Unit: %, valid to two decimal places, maximum $\pm 50\%$
PL Adjustment Range	0 to 8
Adjustment Coordinates	Robot coordinates, base coordinates, tool coordinates, user coordinates (Default coordinates: robot coordinates)

The input ranges for adjustment data can be changed by the following parameters:



- S3C1098: Position adjustment range (unit: mm)
- S3C1099: Speed adjustment range (unit: 0.01%)
- S3C1100: Adjustment coordinate specification
- S3C1102: Posture angle adjustment range (unit: 0.01 deg)

For details, refer to *chapter 8 "Parameter" at page 8-1*.



- Base axis and station axis data cannot be adjusted.
- Adjustment when a TCP instruction is executed is performed by adjusting the data of the selected tool.
- When the coordinates for adjustment are user coordinates, an error occurs if teaching has not been performed in the user coordinates.
- If an attempt is made to adjust “PL” when there is no “PL” in the step subject to the adjustment, an error occurs.
- Position variable and reference point steps cannot be adjusted. An error occurs if adjustment is attempted.
- An attempt to adjust the speed at the step that has no speed tag causes an error.

6.4.2 Operating Methods

6.4.2.1 Setting Adjustment Data

1. Select {JOB} under the main menu.
2. Select {JOB}.
 - The JOB CONTENT window (in the teach mode) or the PLAYBACK window (in the playback mode) appears.
3. Select {UTILITY} under the pull-down menu.
4. Select {PAM}.
 - The PAM window appears.

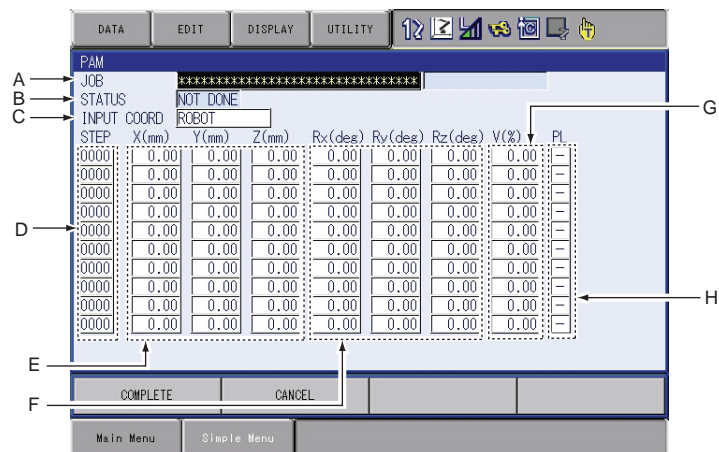

5. Set adjustment data.
 - Set adjustment data.
 - **A. Job**
Set the job name to be adjusted.
Line up the cursor and press [SELECT] to display the JOB LIST window.
Move the cursor to the desired job and press [SELECT] to set the adjusted job.
 - **B. Status**
Shows the status of adjustment in the PAM function.
“NOT DONE” appears when adjustment is not executed. “DONE” appears when the execution of adjustment is completed.
 - **C. Input Coord**
Set the desired coordinates.
Line up the cursor and press [SELECT] to display the selection dialog box.
Move the cursor to the desired coordinate system and press [SELECT] to set the input coordinates.
 - **D. Step Number**
Set the step number to be adjusted.
Line up the cursor and press [SELECT] to display the number input buffer line.
Input the step number and press [ENTER] to set the value.
 - **E. XYZ Coordinate Adjustment**
Set the direction and amount of the X, Y, and Z coordinates.
Line up the cursor with the data to be adjusted and press [SELECT]

to display the number input buffer line.
Input the number data and press [ENTER] to set the adjusted data.

– **F. Rx, Ry, Rz Coordinate Adjustment**

Set the direction and amount of the Rx, Ry and Rz posture angles.

Line up the cursor with the data to be adjusted and press [SELECT] to display the number input buffer line.

Input the number data and press [ENTER] to set the adjusted data.

– **G. V Coordinate Adjustment**

Set the speed.

Line up the cursor and press [SELECT] to display the number input buffer line.

Input the number data and press [ENTER] to set the adjusted data.

– **H. PL**

The position level of the job to be adjusted for the step set in “4. Step Number” is displayed, and the data can be modified.

When the position level is not decided, [-] is displayed, and cannot be set.

To modify the position level, line up the cursor, press [SELECT], input the number value and press [ENTER].

6.4.2.2 Executing the Adjustment

■ Executing the Adjustment

1. Touch “COMPLETE” on the screen.
 - The confirmation dialog box appears.

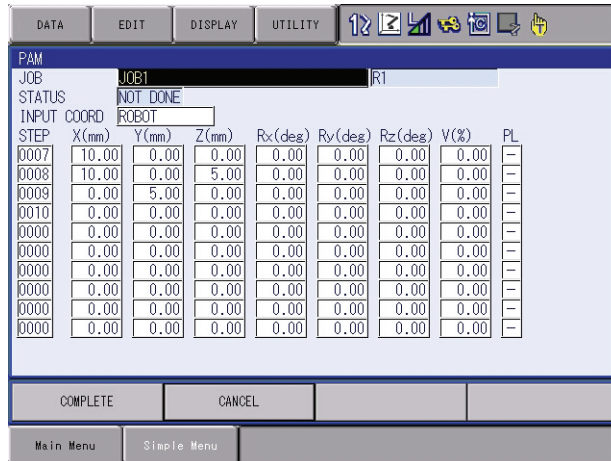

2. Select “YES.”

- In the teach mode, the job adjustment can be immediately executed. In the play mode, the job can be adjusted just before execution (move operation).
- When the job adjustment is completed, the set data shown in the PAM window is cleared. However, if the step's adjusted position exceeds the software limit, an error occurs, and the data in only that step cannot be cleared on the window.

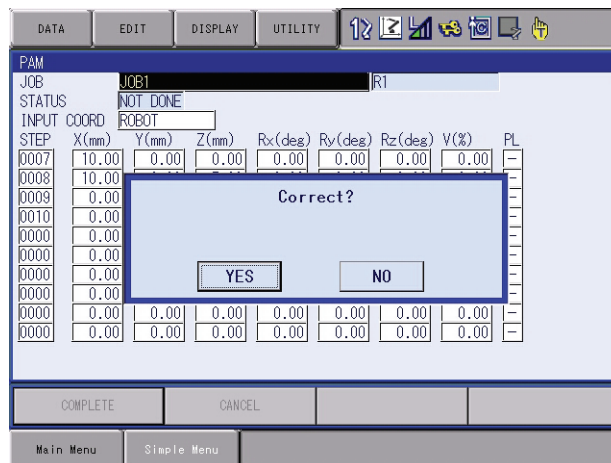

■ **Cancelling the Execution**

In the play mode, during the adjustment wait status, “STOP” is displayed in the PAM window. To cancel the adjustment process, touch “STOP” on the screen. Also, if the following occurs before executing, the process is automatically cancelled.

- If the mode is changed
- If an alarm occurs
- If the power is turned OFF

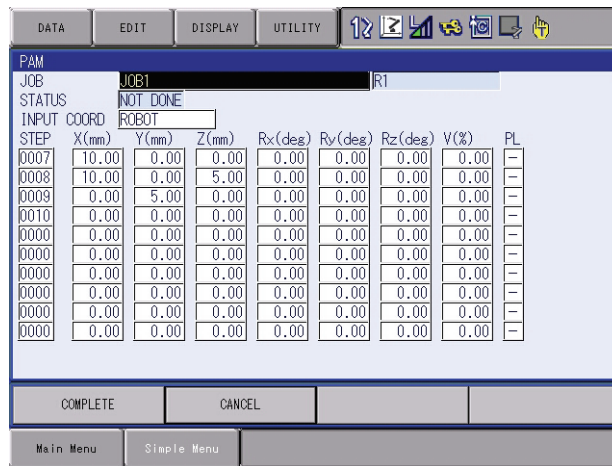

■ Clearing Data

If there is a mistake made when adjusting the data, or if the adjustment of the step becomes unnecessary, the data can be cleared.

1. Move the cursor to the step of the data to be cleared.

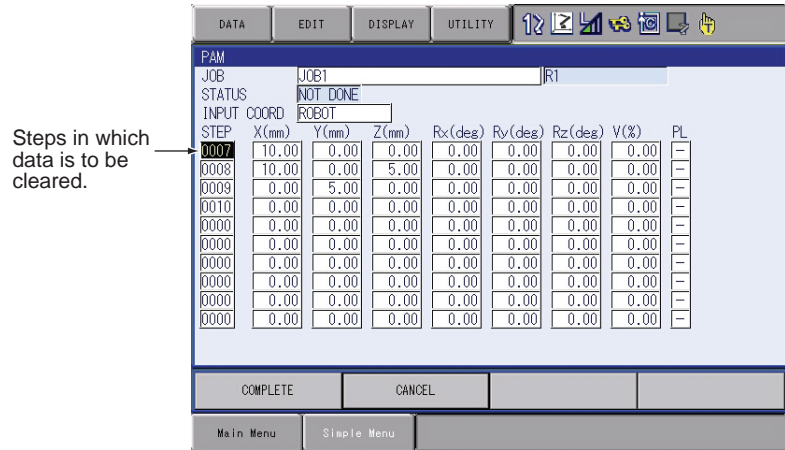

2. Select {EDIT} under the pull-down menu.
3. Select {LINE CLEAR}.
 - The line data is cleared.

■ Copying Data

To input the same data as those set previously, perform the following operation.

1. Move the cursor to the line to be copied.
2. Select {EDIT} under the menu.
 - The pull-down menu appears.

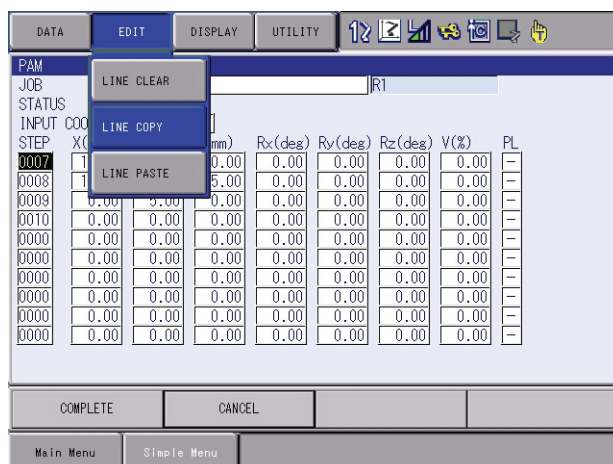

3. Select {LINE COPY}.
4. Move the cursor to the line where the item is to be copied.
5. Select {EDIT} under the menu.
6. Select {LINE PASTE}.
 - The desired data is copied to the line.

- However, if the line where the data is to be copied does not have a speed value or PL value, it cannot be copied.

■ Canceling the Adjustment

After the position adjustment in the PAM function, the job can be returned to the status before adjustment only during teaching. In this case, follow the procedures below.

Note that the job cannot be undone during playback.

1. Move the cursor to the line to be copied.
 - After the position adjustment, the status shows “DONE.”

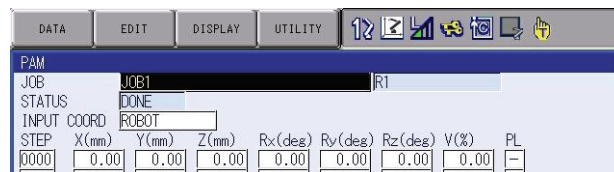

2. Select {EDIT} under the menu.
 - The pull-down menu appears.

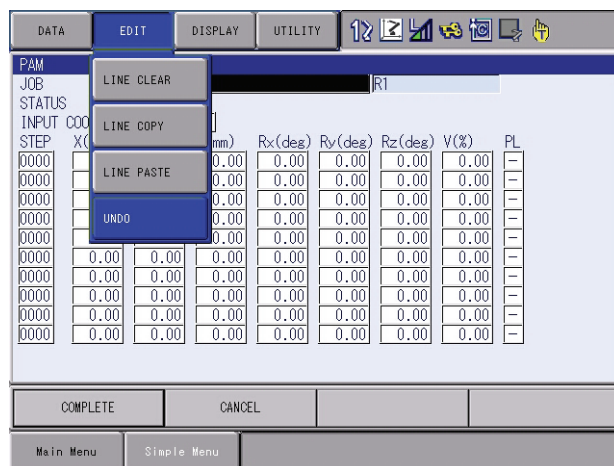

3. Select {UNDO} under the pull-down menu.
 - The confirmation dialog box appears.

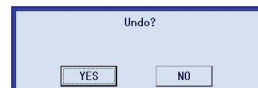

4. Select “YES”
 - The status turns “NOT DONE” and the job is undone when selecting “YES.” The status does not change and the job is not undone when selecting “NO.”

6.5 Mirror Shift Function

6.5.1 Function Overview

With the mirror shift function, a job is converted to the job in which the path is symmetrical to that of the original job. This conversion can be performed for the specified coordinate among the X-Y, X-Z, or Y-Z coordinate of the robot coordinates and the user coordinates.

The mirror shift function is classified into the following three: the pulse mirror-shift function, the robot-coordinates mirror-shift function, and the user-coordinates mirror-shift function.

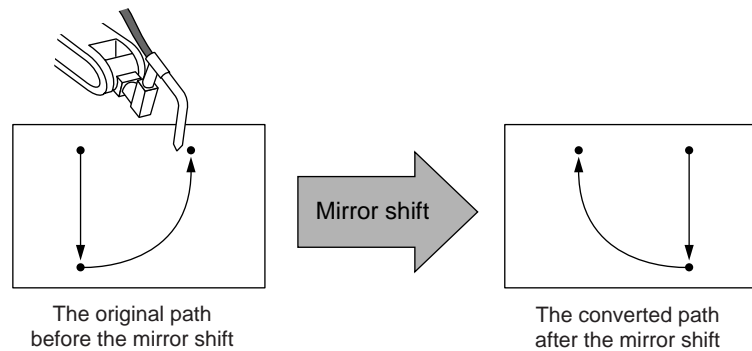

6.5.2 Pulse Mirror-shift Function

With the pulse mirror-shift function, the mirror shift is performed by reversing the sign (+/-) for the axes which are specified with the parameter in advance.

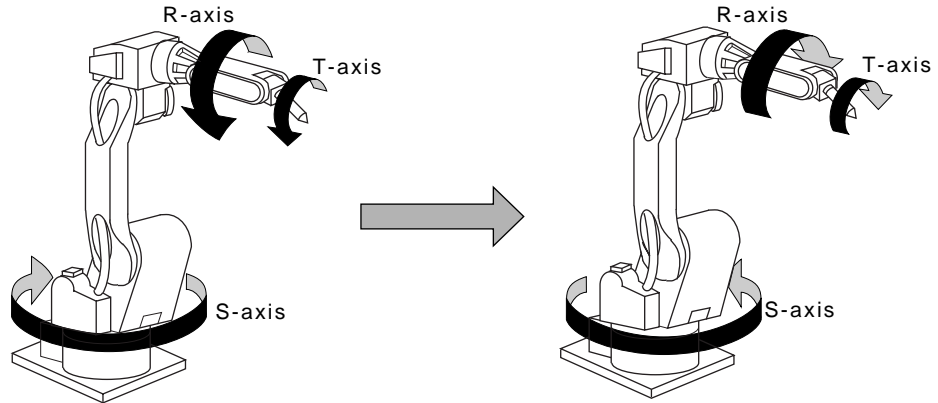

6.5.2.1 Parameter Setting

Using the following parameter, specify the axes for which the sign is to be reversed.

S1CxG065: Mirror Shift Sign Reversing Axis Specification

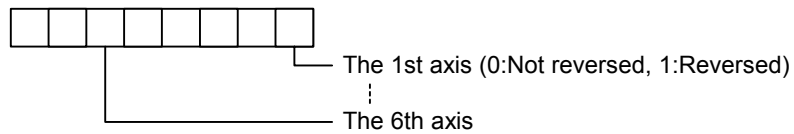

6.5.2.2 Object Job

Jobs without group axes and relative jobs cannot be converted.

6.5.2.3 Group Axes Specification

When specifying the group axes for the converted job in a multiple group axes system, the group axes specified in the original and converted jobs must be the same.

- Robot Axis: Same model
- Base Axis: Same configuration
- Station Axis: Same configuration

6.5.2.4 Position Variables

Position variables are not converted by the mirror shift function.

6.5.3 Robot-coordinates Mirror-shift Function

With the robot-coordinates mirror-shift function, the mirror shift is performed on the X-Z coordinate of the robot coordinates.

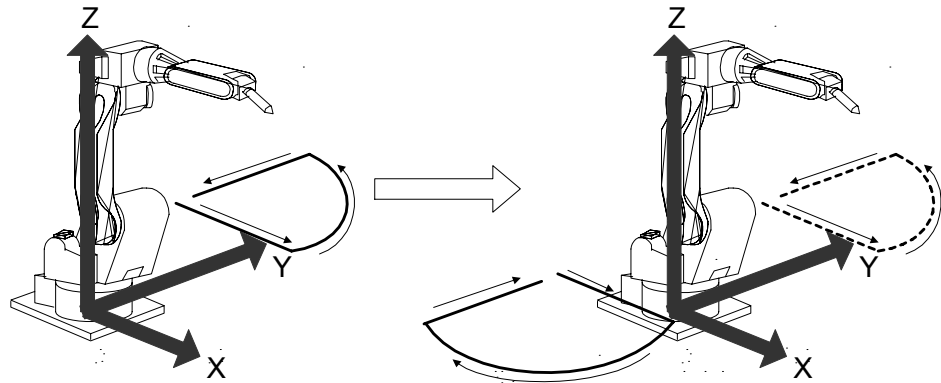

6.5.3.1 Object Job

Jobs without group axes cannot be converted.

6.5.3.2 Group Axes Specification

When specifying the group axes for the converted job in a multiple group axes system, the group axes specified in the original and converted jobs must be the same.

- Robot Axis: Same model
- Base Axis: Same configuration
- Station Axis: Same configuration

6.5.3.3 Position Variables

Position variables are not converted by the mirror shift function.

NOTE

- Mirror shift conversion for the base axis is not performed with the robot-coordinates mirror shift function.
- With the robot-coordinates mirror shift function, mirror shift conversion for the station axis is performed by reversing the sign for the axes specified with the parameter S1CxG065 "Mirror Shift Sign Reversing Axis Specification."

6.5.4 User-coordinates Mirror-shift Function

With the user-coordinates mirror-shift function, the mirror shift is performed on the X-Z, X-Y, or Y-Z coordinate of the specified user coordinates.

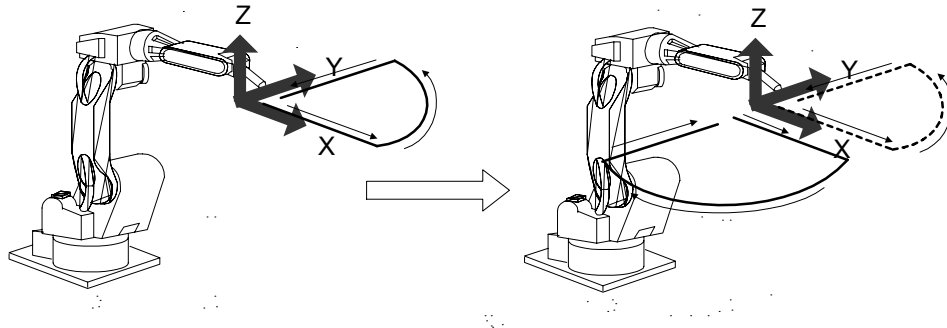

6.5.4.1 Object Job

Jobs without group axes cannot be converted.

6.5.4.2 Group Axes Specification

When specifying the group axes for the converted job in a multiple group axes system, the group axes specified in the original and converted jobs must be the same.

- Robot Axis: Same model
- Base Axis: Same configuration
- Station Axis: Same configuration

6.5.4.3 Position Variables

Position variables are not converted by the mirror shift function.



With the user-coordinates mirror shift function, mirror shift conversion for the station axis is performed by reversing the sign for the axes specified with the parameter S1CxG065 "Mirror Shift Sign Reversing Axis Specification."

6.5.5 Notes on the Mirror Shift Function

For manipulators, such as a polishing wrist, whose center of S-axis rotation and T-axis rotation are offset in the X-coordinate direction, the mirror shift cannot correctly be performed by the pulse mirror-shift function. Be sure to use the robot-coordinates mirror-shift function or use the user-coordinates mirror-shift function with the user coordinates specified on the center of the T-axis rotation.

(1) Using the Robot-coordinates Mirror-shift Function

When the robot-coordinates mirror-shift function is performed, the mirror shift is performed on the X-Z coordinate of the robot coordinates. The path of the converted job is as follows:

Robot-coordinates Mirror-shift Conversion

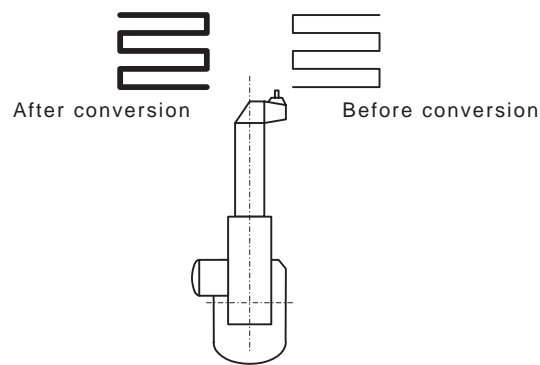
**(2) Using the User-coordinates Mirror-shift Function**

To use the user-coordinates mirror-shift function, specify the user coordinates on the center of T-axis rotation in advance.

User-coordinates Mirror-shift Conversion

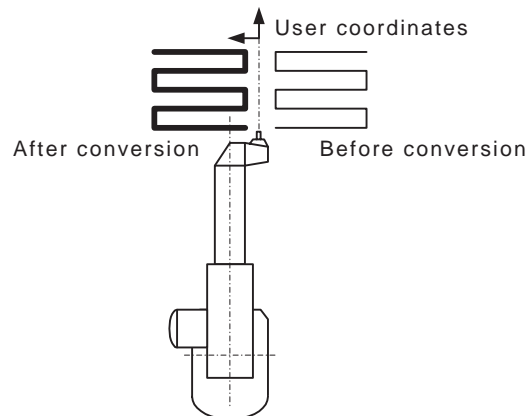

6.5.6 Operation Procedures

6.5.6.1 Calling Up the JOB CONTENT Window

Call up the JOB CONTENT window of the job to be converted as follows:

■ For Current Job

1. Select {JOB} under the main menu.
2. Select {JOB}.

■ For Another Job

1. Select {JOB} under the main menu.
2. Select {SELECT JOB}.
 - The JOB LIST window appears.
3. Select the desired job.

6.5.6.2 Mirror Shift Conversion

1. Display the JOB CONTENT window.
2. Select {UTILITY} under the pull-down menu.
 - The MIRROR SHIFT window appears.
3. Select {MIRROR SHIFT}.
 - The MIRROR SHIFT window appears.

6.5.6.3 Explanation of the Mirror Shift Window

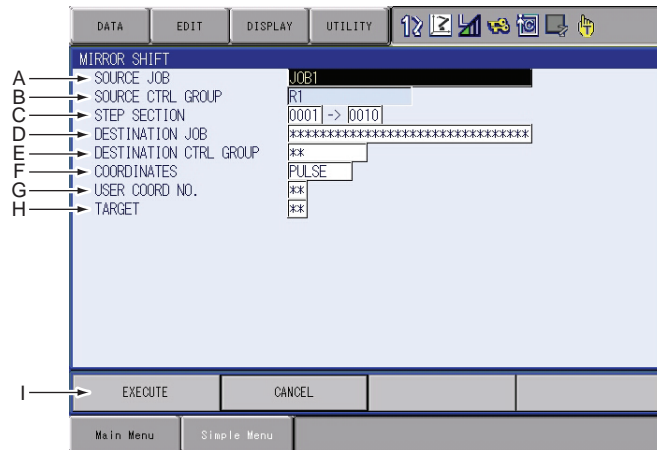
**A. SOURCE JOB**

Selects the conversion source job.

To select another job to be converted, move the cursor to the name and press [SELECT] to call up the list of jobs. Select the desired job and press [SELECT].

B. SOURCE CTRL GROUP

Displays the control group of the conversion source job.

C. STEP SELECTION

Specifies the steps to be converted. From the first step to the last step of the selected job are specified as initial value.

D. DESTINATION JOB

Specifies the converted job name. To enter the name, move the cursor to the name and press [SELECT]. The name of the conversion source job is displayed in the input line as initial value. When "*****" is displayed, the name for the converted job is to be the same as that of the conversion source job.

E. DEST CTRL GROUP

Selects the control group for the converted job. When the destination job name is entered, the same control group as the conversion source job is automatically set. To change it, move the cursor to the control group and press [SELECT] to call up the selection dialog box.

F. COORDINATES

Specifies the coordinates used for conversion.

"PULSE": Executes the pulse mirror-shift conversion.

"ROBOT": Executes the mirror-shift conversion on the basis of the cartesian coordinates.

"USER": Executes the mirror-shift conversion on the basis of the specified user coordinates.

G. USER COORD NO.

Specifies the user coordinates number when "USER" is selected in "6. COORDINATES".

This item cannot be set when "PULSE" or "ROBOT" is selected in "6. COORDINATES".

H. TARGET

Specifies the coordinate where conversion is to be done when "ROBOT" or "USER" is selected in "6. COORDINATES". "XY," "XZ," or "YZ" can be selected. Always specify "XZ" for "ROBOT."

I. EXECUTE

Mirror shift conversion is executed when pressing "EXECUTE" or [ENTER]. A job is created with the name of conversion source job when a job after conversion is not entered.

6.6 Multi Window Function

6.6.1 Function Overview

Multi window function divides the general-purpose display area up to 4 windows and shows them simultaneously.

There are seven dividing patterns to be optionally choose as necessary.

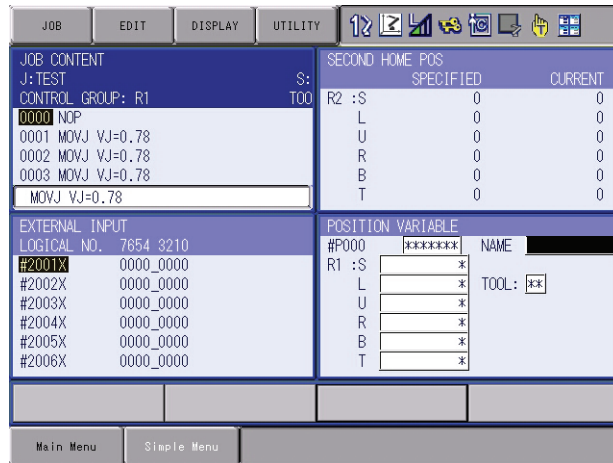

6.6.2 Setting the Dividing Pattern of the General-Purpose Display Area

The dividing pattern of the general purpose display area can be changed in the window exclusive for setting.

Table 6-3: Display the dividing Pattern (Sheet 1 of 2)

	Number of the window	Dividing Pattern
1	1 window	
2	2 windows	
3	2 windows	
4	3 windows	

Table 6-3: Display the dividing Pattern (Sheet 2 of 2)

	Number of the window	Dividing Pattern				
5	3 windows	<table border="1" style="border-collapse: collapse; text-align: center;"> <tr> <td style="width: 30px; height: 30px;">1</td> <td style="width: 30px; height: 30px;">2</td> </tr> <tr> <td style="width: 30px; height: 30px;"></td> <td style="width: 30px; height: 30px;">3</td> </tr> </table>	1	2		3
1	2					
	3					
6	3 windows	<table border="1" style="border-collapse: collapse; text-align: center;"> <tr> <td style="width: 30px; height: 30px;">1</td> <td style="width: 30px; height: 30px;">2</td> </tr> <tr> <td colspan="2" style="width: 60px; height: 30px;">3</td> </tr> </table>	1	2	3	
1	2					
3						
7	4 windows	<table border="1" style="border-collapse: collapse; text-align: center;"> <tr> <td style="width: 30px; height: 30px;">1</td> <td style="width: 30px; height: 30px;">2</td> </tr> <tr> <td style="width: 30px; height: 30px;">3</td> <td style="width: 30px; height: 30px;">4</td> </tr> </table>	1	2	3	4
1	2					
3	4					

6.6.2.1 Calling Up and Operating Methods of the Display Dividing Pattern Setting Window

Call up the dividing pattern setting window.

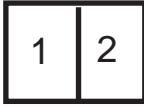
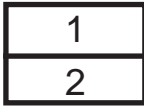
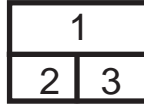
1. Select [DEIPLAY SETUP] -[CHANGE WINDOW PATTERN] under the main menu.

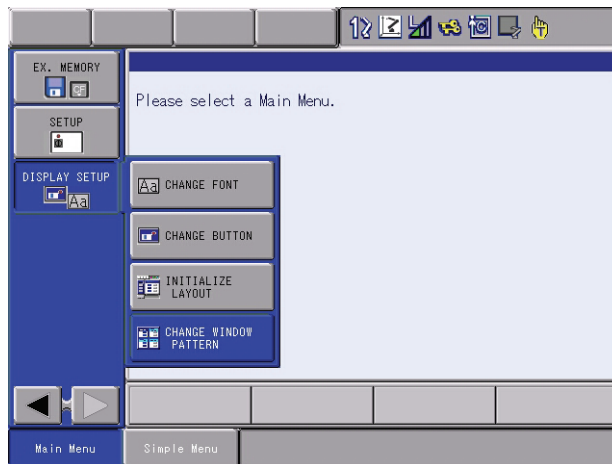

2. Dividing pattern setting window appears in the center of the display.

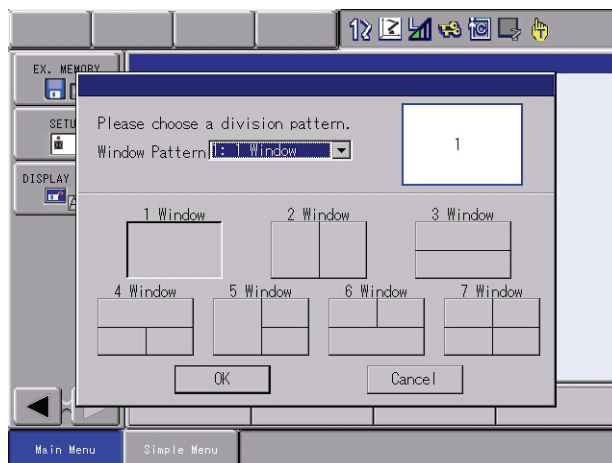

In the dividing pattern setting window, set the dividing pattern of the general-purpose display area.

1. Key operation 1:

When “Window Pattern” is focused in the window, the option of the dividing pattern shifts as cursor moves upper or lower.

- Choose the desired dividing pattrer from the “Window Pattern”.

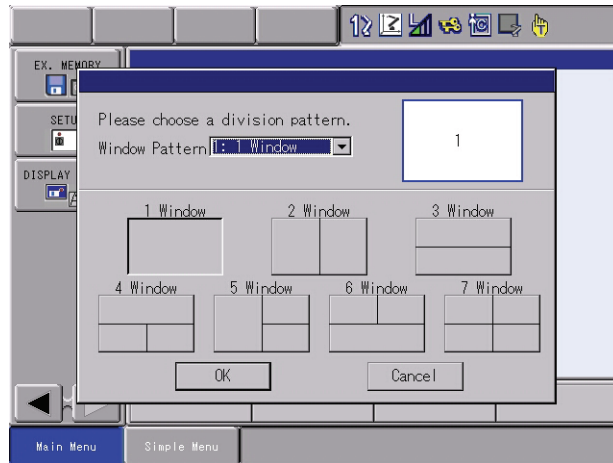

2. Key operation 2:

Press Select key when “Window Pattern” is focused. The list of the dividing patterns appears. The list closes and a pattern is set after choosing the desired pattern and press “Select” key.

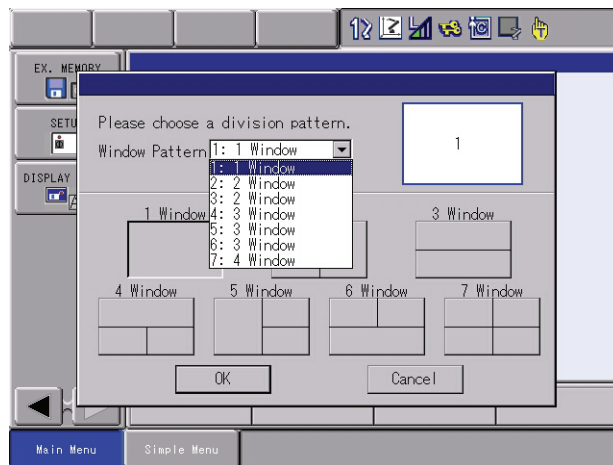

3. Touching operation:
The desired pattern can be chosen by touching a pattern in the window.
- Choose a pattern from the dividing pattern buttons.

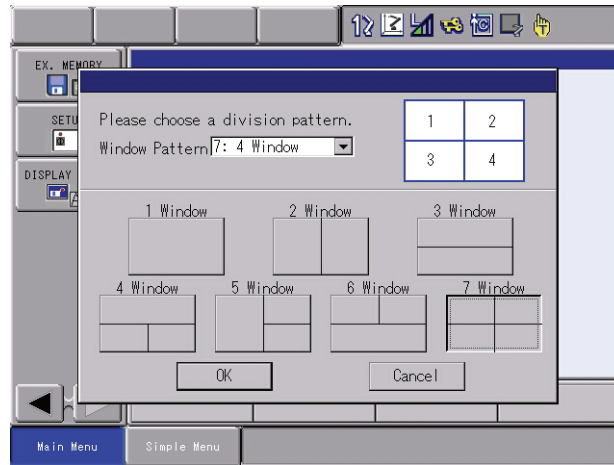

4. Touch [OK] button or move the cursor to it and press [SELECT] key.
- The dividing pattern setting window closes and the chosen pattern (chosen with the procedure either 1, 2 or 3) appears.

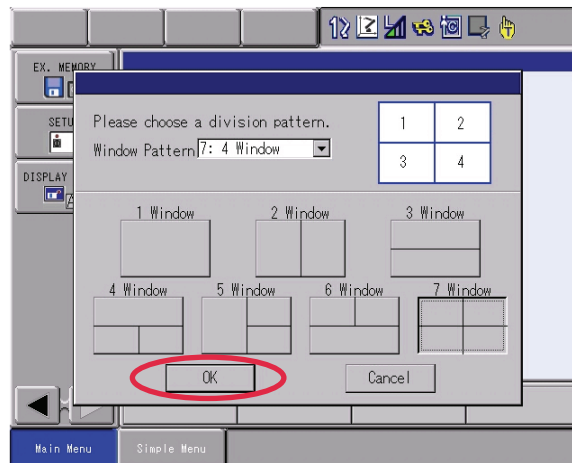

Cancel the setting

1. Touch [CANCEL] button or move the cursor to it and press [SELECT] key.
 - Dividing pattern setting window closes. The dividing pattern in the general-purpose display area doesn't change.

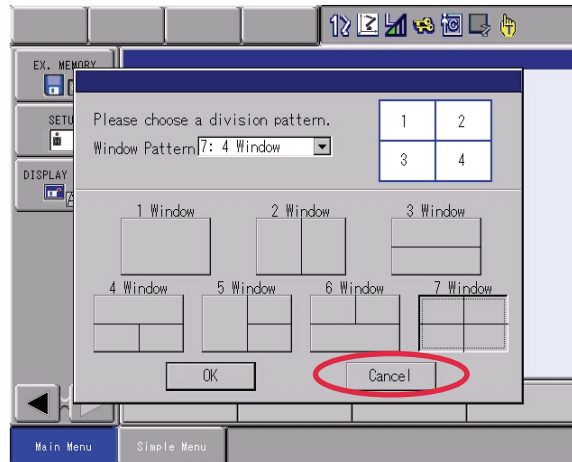

The cursor moves by pressing [AREA] key in the dividing pattern setting window.

6.6.3 Displaying the Multi Window

6.6.3.1 Multi Window Mode and Single Window Mode

Specifying more than two-window pattern in the dividing pattern setting window shows plural windows simultaneously in the general-purpose display area.

This is called multi window mode.

On the other hand, a single active window can be displayed with pressing [SHIFT] + [MULTI] key operation.

This is called single window mode.

Pressing [SHIFT] + [MULTI] key operation switches the display from single window mode to multi window mode. The mode can be changed as necessary.

6.6.3.2 Displaying the Status of Plural (more than two) Window Dividing Pattern Setting

When more than two windows are displayed as a desired pattern,  appears on the upper part of the window whereas it doesn't appear when a single window is displayed.

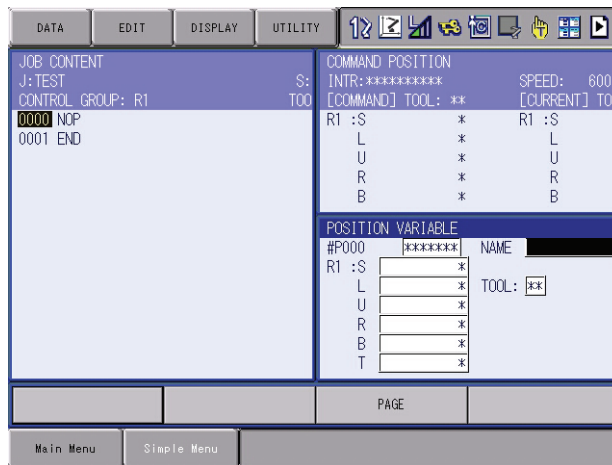

DX100	6	Convenient Functions
	6.6	Multi Window Function

6.6.3.3 Displaying of Active Window and Non-Active Window

When a display is in the multi window mode, one window should be active and the rest is (are) non-active. The title of the active window is displayed in deep blue and non-active window is in light blue.

The active window is the subject of key operation.

Also, the menu area or the operational buttons under the general-purpose displaying area are displayed for the operation of the active window.

6.6.3.4 Limited Matters in Multi Window Mode

The content of window when it is in multi window mode can be different from the same window when it is in single window mode because of its limited size. The content becomes normal when the window is displayed in the single window mode.

- The input buffer in the JOB window is displayed only when the window is active.
- No auxiliary window appears.

6.6.4 Operation of Multi Window

6.6.4.1 Switching of Multi Window Mode and Single Window Mode

When more than two windows are displayed as a dividing pattern of the multi window, it is possible to switch multi window mode to single window mode.

1. Set the mode of the general-purpose displaying area to multi window mode.

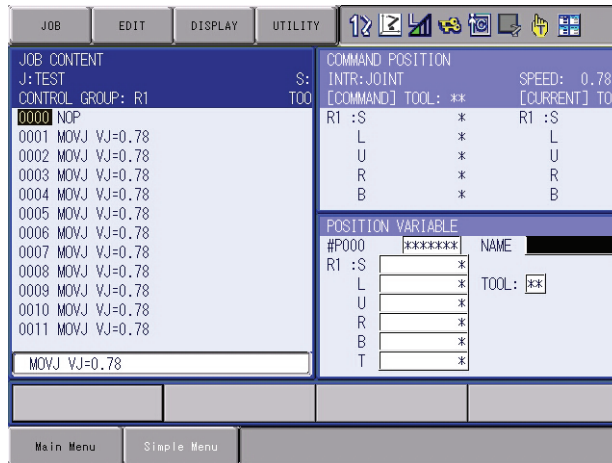

2. Press [SHIFT]+[MULTI] keys.
 - Active window is displayed under single window mode in the general-purpose window displaying area.

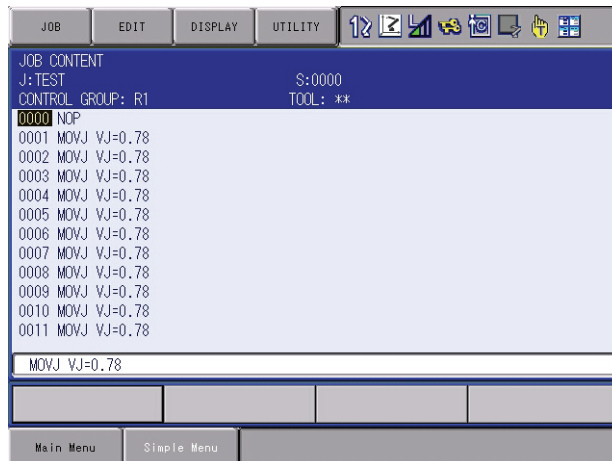

- 3. Press [SHIFT]+[MULTI] keys in step 2 status.
 - The general-purpose display area changes to already set pattern in multi window mode.

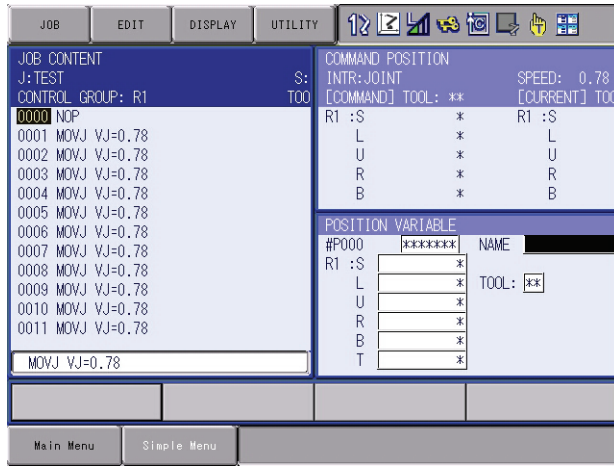

6.6.4.2 Switching of Active Window

Switch the active window in the multi window displaying mode.

1. Set the mode of the general-purpose displaying area to multi window mode.

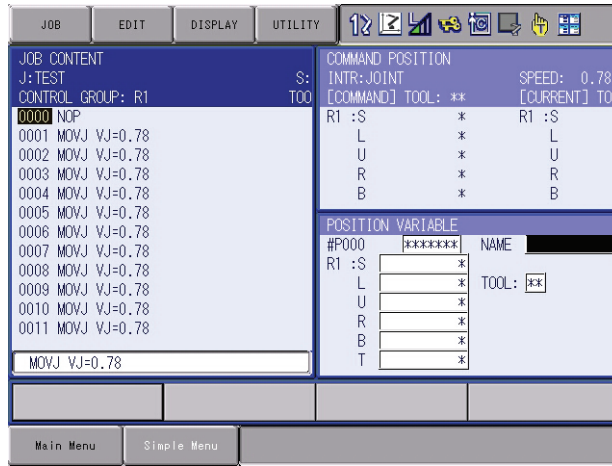

2. Key Operation:
Press [MULT] key

– The window to be active shifts. The active window shifts in the order mentioned in chapter 6.6.2 "Setting the Dividing Pattern of the General-Purpose Display Area" at page 6-53. (1→2→3→4→1……)

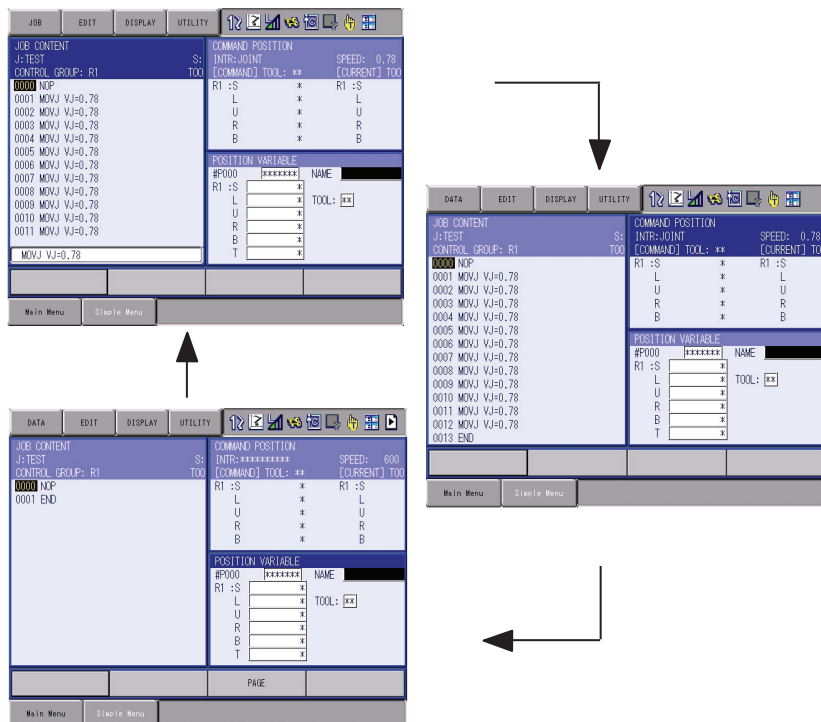

3. Touching Operation:
Touch the window to be active.

– The touched window becomes active.

Switch the active window in the single window mode.

1. Set the mode of the general-purpose displaying area to single window mode.

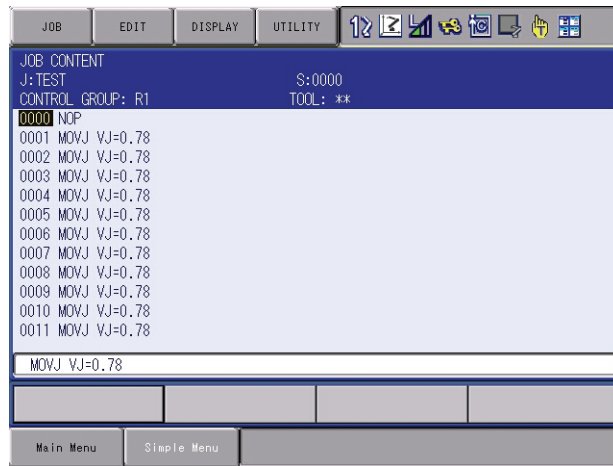

2. Press [MULT] key

- The following windows are displayed in the order mentioned in *chapter 6.6.2 "Setting the Dividing Pattern of the General-Purpose Display Area" at page 6-53. (1→2→3→4→1……)*

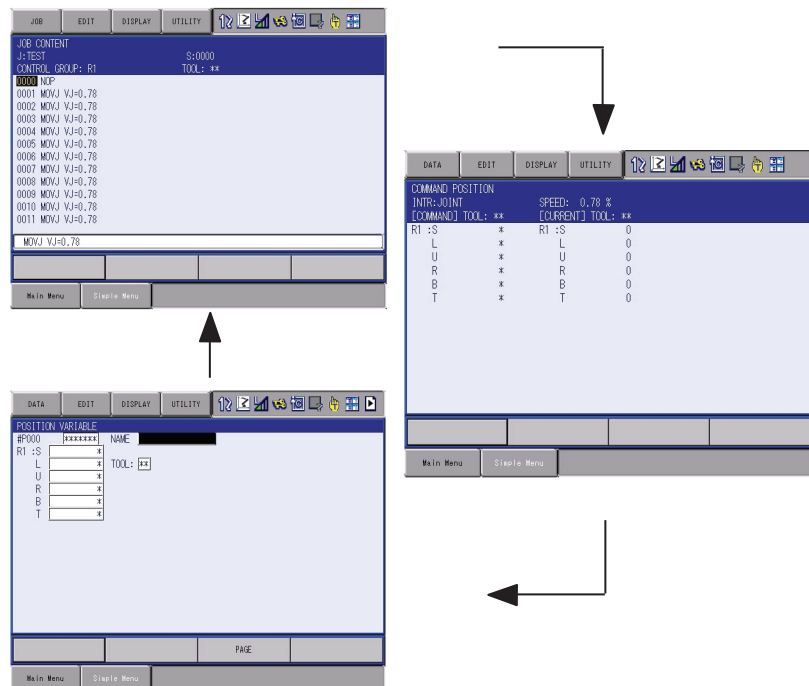

6.6.5 Switching the Axis Operation Control Group

The appropriate control group for axis operation is automatically selected in accordance with the window status or its operation in the active window. Due to this function, when the general-purpose display area is in multi window mode, the control group for axis operation can vary depending on the window which is active at the time.

To avoid unexpected control group to function and for the better safeness, the change of the control group with the [MULTI] key operation or touching operation when switching the active window is notified to the user.



The change of the control group for axis operation due to other than [MULTI] key operation or touching operation; due to the switch of the window by selecting main menu, is not notified to the user.

6.6.5.1 S2C540 “Choosing Method of Notifying the Change of Axis Operation Control Group when Switching the Active Window”

The method to notify the change of control group for axis operation due to the switch of active window can be changed with parameter.

- Setting Value:0
- Keep displaying the message in the human interface display area for three seconds.
- Message “Control group switched by switching the active window” is displayed.

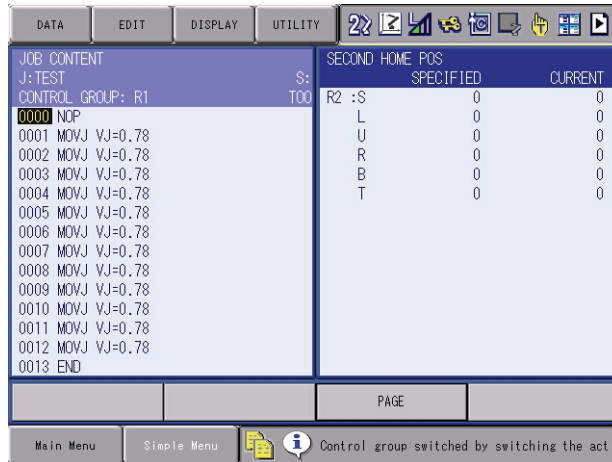

- Setting Value:1
 - Call up the confirmation dialog box to confirm the switch of the active window.
 - Message “Control group will be changed. Switch the active window?” is displayed
 - “Yes” …… After switching the window to be active, a message appears in the human interface display area.
 - “No” …… Cancel the window to be active.

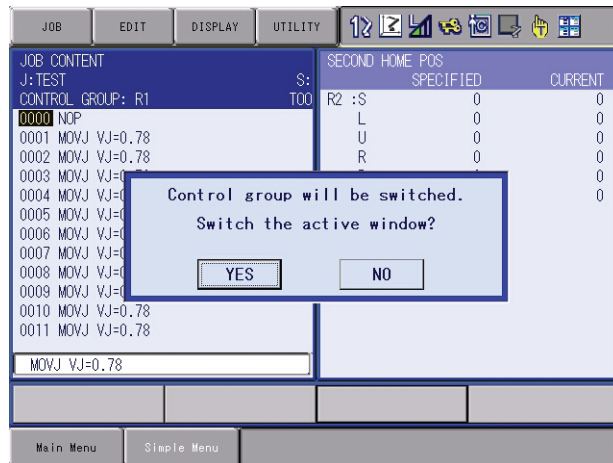

- Setting Value:2
 - Do not notify the control group change.

7 External Memory Devices

7.1 Memory Devices

The following memory devices can be used in the DX100 to save and load data such as jobs and parameters.

Device	Function	Media (destination of saved/ loaded data)	Optional function requirement
CF: Pendant	Standard	Compact Flash Card (CF card)	No requirement. Programming pendant is equipped with a slot.
USB: Pendant	Standard	USB Memory Stick	No requirement. Programming pendant is equipped with a slot.
FC1	Option ¹⁾	2DD floppy disk, personal computer (FC1 emulator)	"FC1" or personal computer with "FC1 emulator"
FC2	Option ¹⁾	2DD floppy disk, 2HD floppy disk	"FC2"
PC	Option ¹⁾	Personal computer (MOTOCOM32 host)	Via RS-232C: "Data transmission function" and "MOTOCOM32" Via Ethernet: "Ethernet function" plus above two requirements
FTP	Option ¹⁾	FTP server such as personal computer	"Data transmission function", "MOTOCOM32", and "FTP function"

1 For the operation, refer to instruction manuals for each optional function.

DX100	7	External Memory Devices
	7.1	Memory Devices

7.1.1 Compact Flash (CF Cards)

The programming pendant is equipped with CF card slot. Use the FAT16 or FAT32 formatted Compact Flash.

7.1.1.1 Recommended Compact Flash Cards

Recommended products used for external memory of DX100 are listed below. Model numbers are subject to be updated due to termination of product and new addition. Contact Yaskawa representative when necessary.

No.	Manufacturer	Model	Note
1	Hagiwara Sys-Com	MCF10P-256MS (IOOA II-YE2)	256MB
2	Hagiwara Sys-Com	MCF10P-512MS	(512MB)
3	Hagiwara Sys-Com	MCF10P-A01GS	(1GB)
4	Hagiwara Sys-Com	MCF10P-A02GS	(2GB)
5	AiliconSystem	SSD-C25M3512	"xxMB" denotes memory size (up to 2GB).

7.1.1.2 Notes on handling Compact Flash

- Do not drop or bend exerting any shock or strong force to the Compact Flash.
- Keep away from water, oil, organic solvent, dust, and dirt.
- Do not use or keep the Compact Flash in places where strong static electricity or electronic noise may occur.
- Do not insert or remove the Compact Flash or turn OFF the power when accessing the Compact Flash (writing-in or reading-out the Compact Flash data.)
- To protect the data, back up the data regularly on other media. Damages or loss of data due to operation errors or accidents can be minimized.

*Compact Flash has a limited life span.

The life span differs depending on products or status of use. However, normal use of Compact Flash as an external memory device for the DX100 does not adversely affect the Compact Flash. For details, refer to instruction manuals for each medium.

7.1.1.3 Inserting a Compact Flash

When inserting a Compact Flash, take note of insertion direction.

With the notch and clip of the Compact Flash downward, insert the Compact Flash slowly into the slot of the programming pendant of which display faces up.

Forcible insertion may result in damage to the Compact Flash or CF card slot.

After inserting the card, be sure to close the cover of the slot before starting operation.

Fig. 7-1: Using a Compact Flash Card

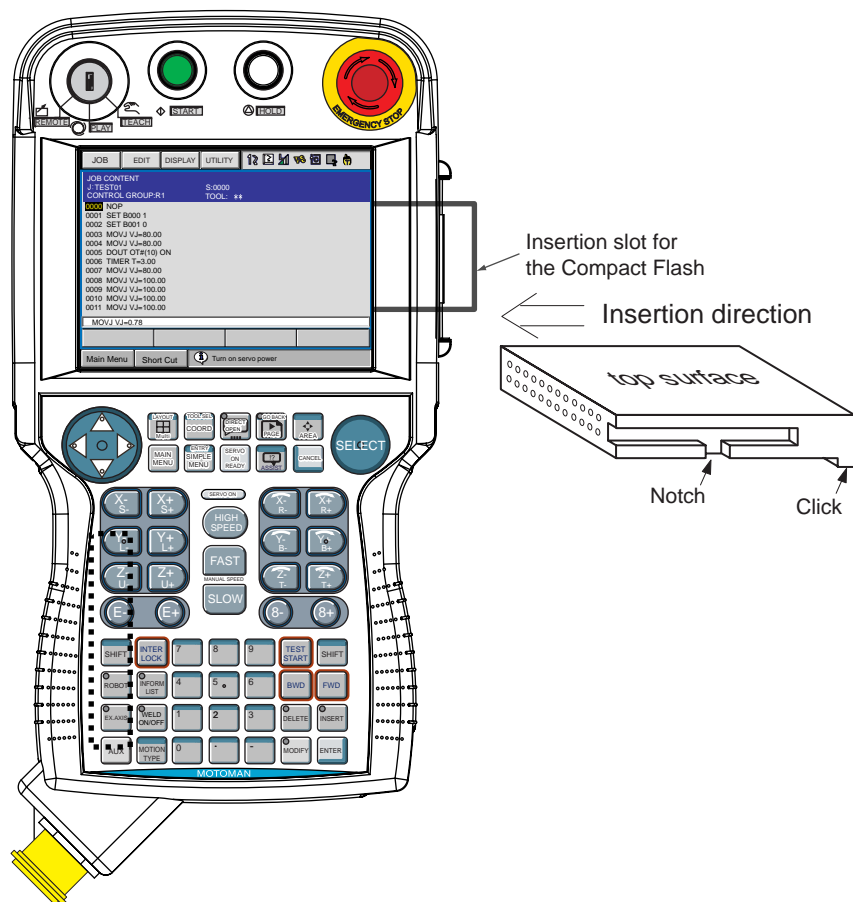

DX100	7	External Memory Devices
	7.1	Memory Devices

7.1.2 USB Memory Stick

The programming pendant is equipped with a USB connector. Use the FAT16 or FAT32 formatted USB memory stick.

7.1.2.1 Recommended USB Memory Stick

Recommended products used for external memory of DX100 are listed below. Model numbers are subject to be updated due to termination of product and new addition. Contact Yaskawa representative when necessary.

No.	Manufacturer	Model	Note
1	Hagiwara Sys-Com	UDG3-GA Series	1GB or 2GB

7.1.2.2 Notes on handling USB Memory Stick

- Do not drop or bend exerting any shock or strong force to the Compact Flash.
- Keep away from water, oil, organic solvent, dust, and dirt.
- Do not use or keep the Compact Flash in places where strong static electricity or electronic noise may occur.
- Do not insert or remove the Compact Flash or turn OFF the power when accessing the Compact Flash (writing-in or reading-out the Compact Flash data.)
- To protect the data, back up the data regularly on other media. Damages or loss of data due to operation errors or accidents can be minimized.

*USB memory stick has a limited life span.

The life span differs depending on products or status of use. However, normal use of USB memory stick as an external memory device for the DX100 does not adversely affect the USB memory stick. For details, refer to instruction manuals for each medium.

7.1.2.3 Inserting a USB Memory Stick

When inserting a USB memory stick, take note of insertion direction.

With the USB memory stick face-up and the connector upwards, insert the stick slowly into the slot of the programming pendant of which display face-down.

Forcible insertion may result in damage to the USB memory stick or USB connector.

After inserting the stick, be sure to close the cover of the connector before starting operation.

Fig. 7-2: Using a USB Memory Stick

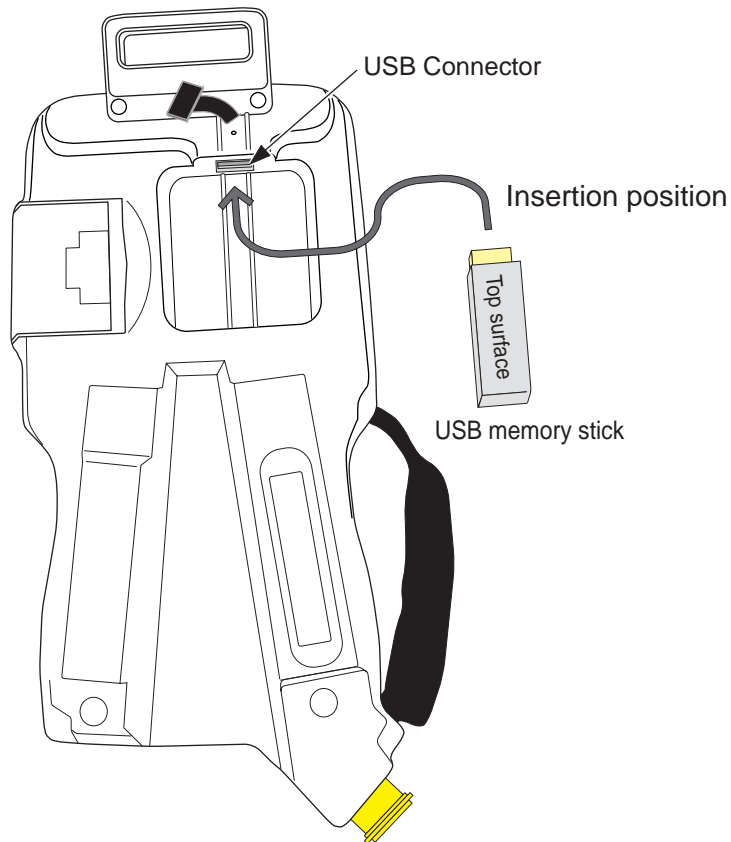

When a USB memory stick is used, the waterproofing of programming pendant cannot be maintained.



If the USB memory stick is always set in the programming pendant, the stick may fall out of the pendant.

If it is impossible to maintain the waterproofing of programming pendant or to prevent the USB memory stick from falling out of the programming pendant, use a Compact Flash card instead.

7.2 Handling Data

7.2.1 Data Classification

For the DX100, data that can be saved online are classified into eight categories.

- 1. JOB**
- 2. FILE/GENERAL DATA**
- 3. BATCH USER MEMORY^{*1}**
- 4. PARAMETER^{*2}**
- 5. SYSTEM DATA**
- 6. I/O DATA**
- 7. BATCH CMOS^{*3}**
- 8. ALL CMOS AREA^{*4}**

Data saved on the external memory device can be loaded again into the DX100.

Each data in the eight categories varies depending on applications or options.

When the device is set to "PC" and "FTP", data cannot be handled other than "1. JOB" and "2. FILE/GENERAL DATA."

*1: "3. BATCH USER MEMORY" includes "1. JOB" and "2. FILE/GENERAL DATA."

*2: "PARAMETER BATCH" includes all "4. PARAMETER."

*3: "7. BATCH CMOS" includes "3. BATCH USER MEMORY", "4. PARAMETER", "5. SYSTEM DATA", and "6. I/O DATA."

*4: "ALL CMOS AREA" data cannot be loaded in edit mode and management mode.



PARAMETER, I/O DATA, SYSTEM DATA, PARAMETER BATCH, BATCH CMOS, and ALL CMOS AREA are used for backup.

If those data are loaded by other controllers, unintended data overwriting, unexpected operation, or abnormal system startup may occur.

Do not load those backup data into other controllers.

If two controllers are loaded with the same job, paths of the two manipulators are different due to the home positions or mechanical error of the component parts.

Be sure to check the operation instruction before operation.

Table 7-1: Data List (Sheet 1 of 2)

Data Classification		File Name (Saved Data)	Save			Load		
			OPN	EDIT	MAN	OPN	EDIT	MAN
8. ALL CMOS AREA		ALCMSxx.HEX	○	○	○	X	X	X
7. BATCH CMOS		CMOSxx.HEX	○	○	○	X	X	○
3. BATCH USER MEMORY		JOBxx.HEX	○	○	○	X	○	○
1. JOB	Single job	JOBNAME.JBI	○	○	○	X	○	○
	Related job (Job+Condition)	JOBNAME.JBR	○	○	○	X	○	○
2 FILE/ GENERAL DATA	Tool data	TOOL.CND	○	○	○	X	○	○
	Weaving data	WEAV.CND	○	○	○	X	○	○
	User coordinate data	UFRAME.CND	○	○	○	X	○	○
	Variable data	VAR.DAT	○	○	○	X	○	○
	Arc start condition data	ARCSRT.CND	○	○	○	X	○	○
	Arc end condition data	ARCEND.CND	○	○	○	X	○	○
	Welding condition auxiliary data	ARCSUP.DAT	○	○	○	X	○	○
	Power source characteristic data	WELDER.DAT	○	○	○	X	○	○
	Power source characteristic definition data	WELDUDEF.DAT	○	○	○	X	○	○
	Shock detection level data	SHOCKLVL.CND	○	○	○	X	○	○
	Motor gun pressure power data	SPRESS.CND	○	○	○	X	○	○
	Motor gun dry spot pressure data	SPRESSCL.CND	○	○	○	X	○	○
	Spot gun characteristic data	SGUN.DAT	○	○	○	X	○	○
	Spot welding power source characteristic data	SWELDER.DAT	○	○	○	X	○	○
	Spot I/O allocation data	SPOTIO.DAT	○	○	○	X	○	○
	Spot welding condition data	SPOTWELD.DAT	○	○	○	X	○	○
	Short/Full open position data	STROKE.DAT	○	○	○	X	○	○
Clearance data	CLEARANCE.DAT	○	○	○	X	○	○	
Airgun condition data	AIRGUN.DAT	○	○	○	X	○	○	
Interference area file	CUBEINTF.CND	○	○	○	X	○	○	
4. PARAMETER BATCH		ALL.PRM	○	○	○	X	X	○
4. PARA- METER	Robot matching parameter	RC.PRM	○	○	○	X	X	○
	System definition parameter	SD.PRM	○	○	○	X	X	○

Table 7-1: Data List (Sheet 2 of 2)

Data Classification				File Name (Saved Data)	Save			Load			
					OPN	EDIT	MAN	OPN	EDIT	MAN	
8.	7.	4.	4. PARA-METER	Coordinate home position parameter	RO.PRM	○	○	○	X	X	○
				System matching parameter	SC.PRM	○	○	○	X	X	○
				CIO parameter	CIO.PRM	○	○	○	X	X	○
				Function definition parameter	FD.PRM	○	○	○	X	X	○
				Application parameter	AP.PRM	○	○	○	X	X	○
				Transmission (general) parameter	RS.PRM	○	○	○	X	X	○
				Sensor parameter	SE.PRM	○	○	○	X	X	○
				Servo parameter	SV.PRM	○	○	○	X	X	○
				Servomotor parameter	SVM.PRM	○	○	○	X	X	○
				Operation control parameter	AMC.PRM	○	○	○	X	X	○
				Servo power block parameter	SVP.PRM	○	○	○	X	X	○
				Motion function parameter	MF.PRM	○	○	○	X	X	○
				SERVOPACK parameter	SVS.PRM	○	○	○	X	X	○
				Converter parameter	SVC.PRM	○	○	○	X	X	○
5. I/O DATA				CIO program	CIOPRG.LST	○	○	○	X	X	○
				I/O name data	IONAME.DAT	○	○	○	X	X	○
				Pseudo input signals	PSEUDOIN.DAT	○	○	○	X	X	○
				External I/O name data	EXIONAME.DAT	○	○	○	X	X	○
				Register name data	IONAME.DAT	○	○	○	X	X	○
6. SYSTEM DATA				User word registration	UWORD.DAT	○	○	○	X	X	○
				SV monitor signals	SVMON.DAT	○	○	○	X	X	○
				Variable name	VARNAME.DAT	○	○	○	X	X	○
				Second home position	HOME2.DAT	○	○	○	X	X	○
				Alarm history data	ALMHIST.DAT	○	○	○	X	X	X
				Home position calibrating data	ABSO.DAT	○	○	○	X	X	○
				System information	SYSTEM.SYS	○	○	○	X	X	X
				Work home position data	OPEORG.DAT	○	○	○	X	X	○
				I/O message history data	IOMSGHST.DAT	○	○	○	X	X	X
				Function key allocation data	KEYALLOC.DAT	○	○	○	X	X	○
Arc monitor data	ARCMON.DAT	○	○	○	X	X	X				

* OPN: Operation Mode, EDIT: Edit Mode, MAN: Management Mode
○ : Can be done, X : Cannot be done

7.2.2 File Existence

The following data categories show whether the same file name as a file that is going to be saved is in the external memory device or not.

- **JOB**
No mark appears when the selected folder has the file of the same name.
The asterisk (*) appears when the folder does not have the same name file.
- **FILE/GENERAL DATA, PARAMETER, SYSTEM DATA, I/O DATA**
Black circle (●) appears when the selected folder has the file of the same name.
White circle (○) appears when the folder does not have the same name file.



Whether the job after editing is saved or not can be judged by checking "TO SAVE TO FD" in the JOB HEADER window. However, the status of "TO SAVE TO FD" does not change after saving "3. BATCH USER MEMORY" and "7. BATCH CMOS"

Fig. 7-3: Example of JOB

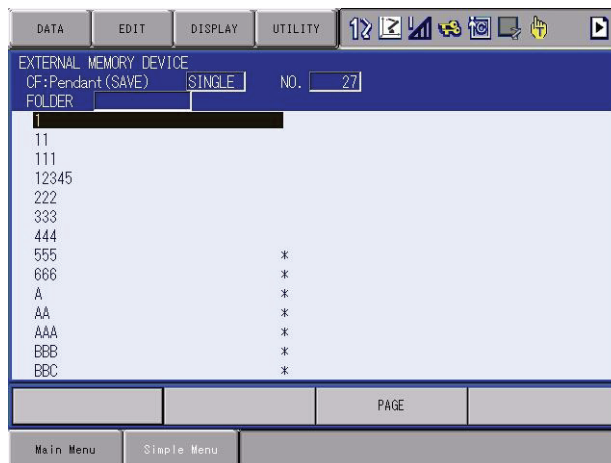
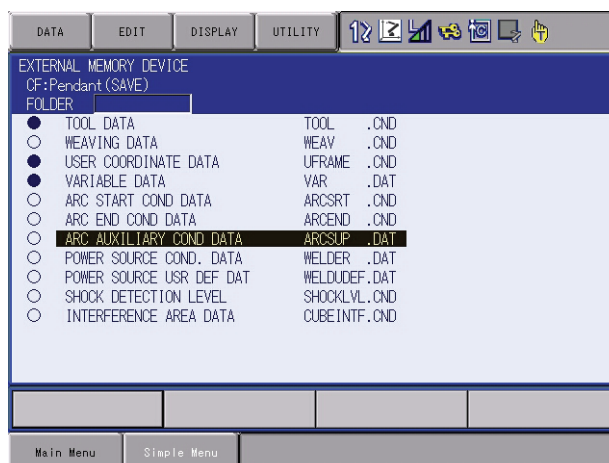

Fig. 7-4: Example of FILE/GENERAL DATA



7.2.2.1 Saving by Overwriting

“3. BATCH USER MEMORY”, “7. BATCH CMOS”, and “8. ALL CMOS AREA” can be overwritten.

As for “1. JOB”, “2. FILE/GENERAL DATA”, “4. PARAMETER”, “5. SYSTEM DATA”, and “6. I/O DATA”, those data cannot be overwritten. Delete the target file in the device before the saving operation. If Compact Flash is used as the device, the file does not need to be deleted because another folder can be created to save the data.

7.3 Operation Flow

The following description is the operation flow for external memory devices.

- **SELECT DEVICE**
 Select {FD/PC CARD} --> {DEVICE}, and the destination device for saving.
 The device selected is valid after turning the power supply ON again.
 *1: Sub menu {FORMAT} appears when selecting FC1 or FC2.

- **SELECT FOLDER**
 Select {FD/PC CARD} --> {DEVICE}, and the destination folder for saving.
 The folder selected is invalid after turning the power supply ON again.
 *2: {FOLDER} appears when using the Compact Flash as a device.
 *3 The settings of {CREATE NEW FOLDER}, {DELETE FOLDER}, and {ROOT FOLDER} can be set.

- **SELECT SUB MENU**
 Select an operation to be performed from {LOAD}, {SAVE}, {VERIFY}, and {DELETE}.

- **SELECT DATA CATEGORY**
 Select the target data category.

- **SELECT DATA**
 Select the target data.
 "3. BATCH USER MEMORY", "7. BATCH CMOS", and "8. ALL CMOS AREA" do not require this operation.
 4 Individual selection, batch selection, marker () selection, and canceling selection can be performed.

- **EXECUTE**
 Select [ENTER] or {EXECUTE}.

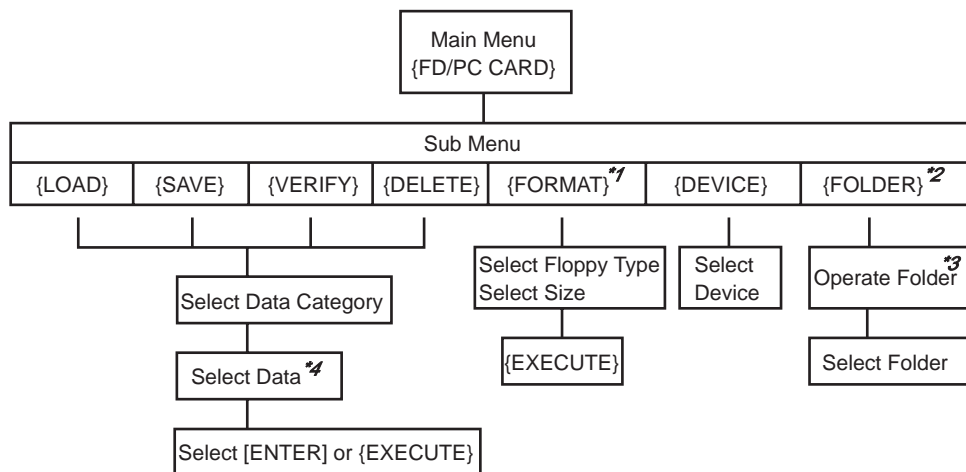

7.3.0.1 Operating a Folder

Folders can be used in order to classify and sort out the data such as jobs and condition files when using the Compact Flash. The folders can be created in hierarchical structure positioning a root folder at the top.

■ Restrictions

Folder name: Up to 8 one-byte characters + 3 characters for extension

*Long folder names cannot be used such as the name that exceeds the restricted number of characters mentioned above as created in PC, etc.

Maximum path length: 64 one-byte characters

*"ERROR 3360: INVALID FOLDER" appears when selecting the folder of which name exceeds the maximum path length.

■ Selecting a Folder

1. Select {FD/PC CARD} under the main menu.
2. Select {FOLDER}.
 - The FOLDER LIST window appears.
3. Move the cursor to a folder and press [SELECT].
 - A folder can be selected.
4. To move the hierarchy from a child folder to a parent folder, move the cursor to [..] and press [SELECT].

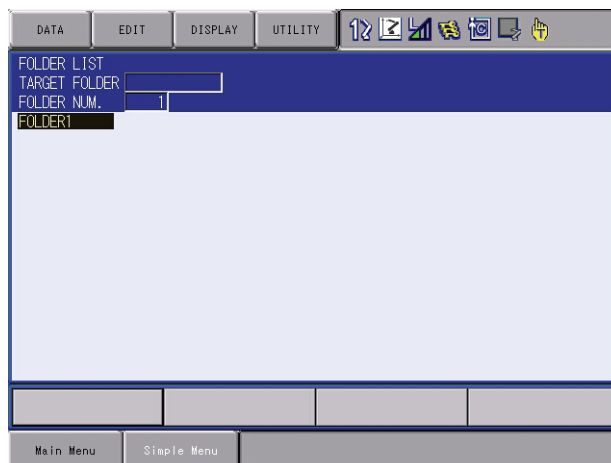
**■ Creating a Folder**

1. Change the security to management mode. Select {FD/PC CARD} under the main menu.
2. Select {FOLDER}.
 - The FOLDER LIST window appears.

3. Move the cursor to a folder and press [SELECT].
 - Select the higher-level folder where a new folder to be created should be contained.
 - When creating a folder in top-level, this step is unnecessary.
4. Select {DATA} --> {CREATE NEW FOLDER} under the pull-down menu. Input folder name using the keyboard on the screen and press [ENTER].
 - A folder is created.

■ Deleting a Folder

1. Change the security to management mode. Select {FD/PC CARD} under the main menu.
2. Select {FOLDER}.
 - The FOLDER LIST window appears.
3. Move the cursor to a folder and press [SELECT].
 - Select the higher-level folder where a folder to be deleted is contained.
 - When deleting a folder in top-level, this step is unnecessary.
4. Delete the files and subfolders beforehand inside the folder that is to be deleted.
 - A folder cannot be deleted if the folder contains files or subfolders inside.

Move the cursor to the folder to be deleted.

5. Select {DATA} --> {DELETE FOLDER} under the pull-down menu.

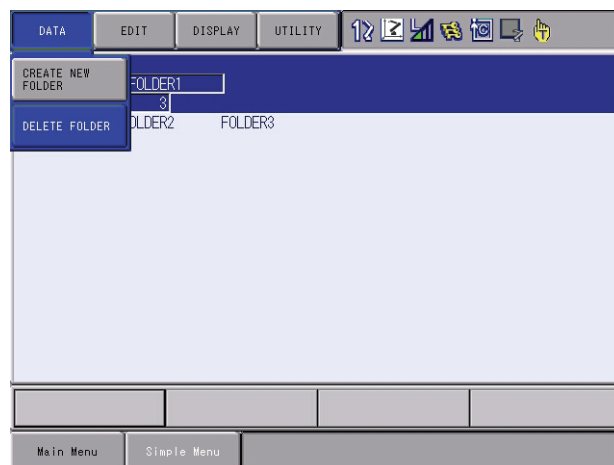

■ Initial Folder Setting

The folder that is contained in a deep hierarchy can be selected in a shortened operation.

When selecting {LOAD}, {SAVE}, {VERIFY}, or {DELETE} from the sub menu of {FD/PC CARD}, the folder that has been set as an initial folder becomes a current folder.

1. Change the security to management mode. Select {FD/PC CARD} under the main menu.
2. Select {FOLDER}.
 - The FOLDER LIST window appears.
3. Move the cursor to a folder and press [SELECT].
 - Select a folder that is to be set as a root folder.
4. Select {DISPLAY} --> {ROOT FOLDER} under the pull-down menu.
 - The INITIAL FOLDER SETTING window appears.

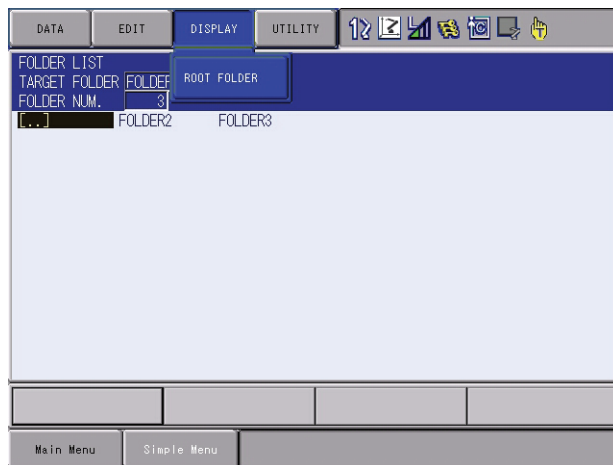

- A folder currently selected appears in “CURRENT FOLDER” and the initial folder appears in “ROOT FOLDER.”

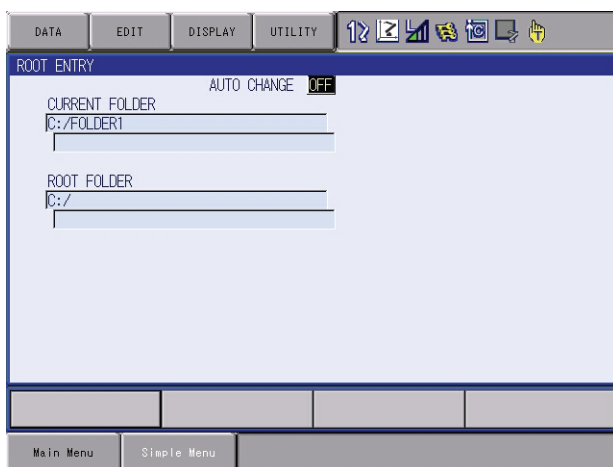

5. Select {EDIT} --> {SETUP FOLDER} under the pull-down menu. Move the cursor to “AUTO CHANGE” and press [SELECT].
- The initial folder is set in “ROOT FOLDER.”

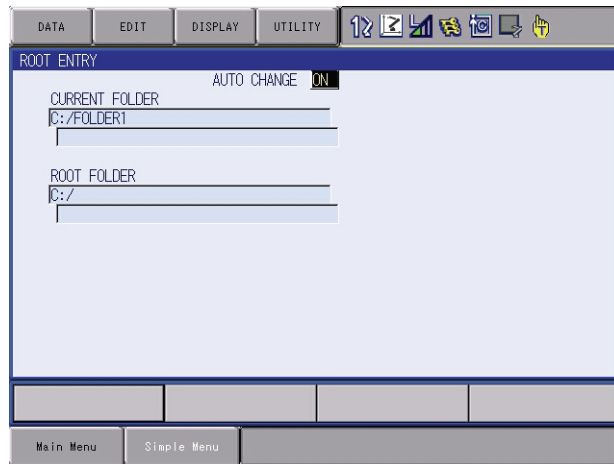

- “AUTO CHANGE” shows “ON” and the initial folder setting becomes valid. Subsequently, every time {FD/PC CARD} --> {FOLDER} is selected, the initial folder that has been set becomes a current folder.



When the initial folder is missing due to exchange of the Compact Flash, etc., “ERROR 3360: INVALID FOLDER” appears when selecting {LOAD}, {SAVE}, {VERIFY}, {DELETE} or {FOLDER} menu from {FD/PC CARD}, and simultaneously the initial folder becomes invalid. Set “ON” in “AUTO CHANGE” when the initial folder setting needs to be valid.

7.3.0.2 Saving Data

To download data from the memory of the DX100 to the external memory device, perform the following procedure.



Data such as PARAMETER, SYSTEM DATA, I/O DATA, and the batch data such as PARAMETER BATCH, BATCH CMOS, ALL CMOS AREA, that include PARAMETER, SYSTEM DATA, I/O DATA, contain the information specific to each robot controller.

Those data are prepared as backup data for reloading into the controller used for saving.

Loading the data from other controller may result in destruction or loss of critical system information.

Take extra care for the saved data.

■ Saving a Job

1. Select {FD/PC CARD} under the main menu.
2. Select {SAVE}.
 - The following window appears.

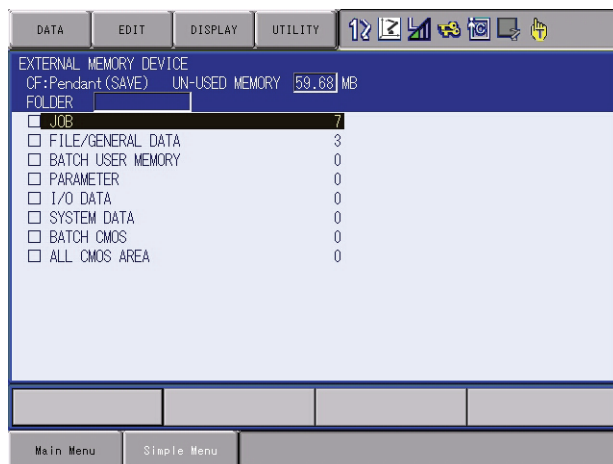

3. Select {JOB}.
 - The JOB LIST window appears.

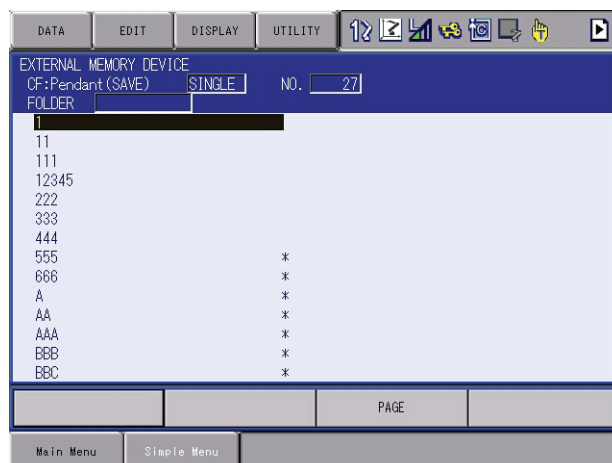

4. Select a job to be saved.
 - The selected job is marked with “★.”

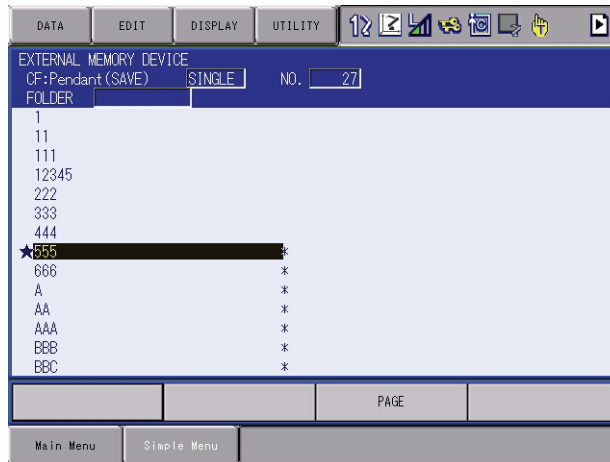

5. Press [ENTER].
 - The confirmation dialog box appears.

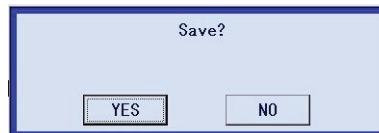

6. Select “YES.”
 - The selected job is saved.

■ Saving a Condition File or General Data

1. Select {FD/PC CARD} under the main menu.
2. Select {SAVE}.
 - The following window appears.

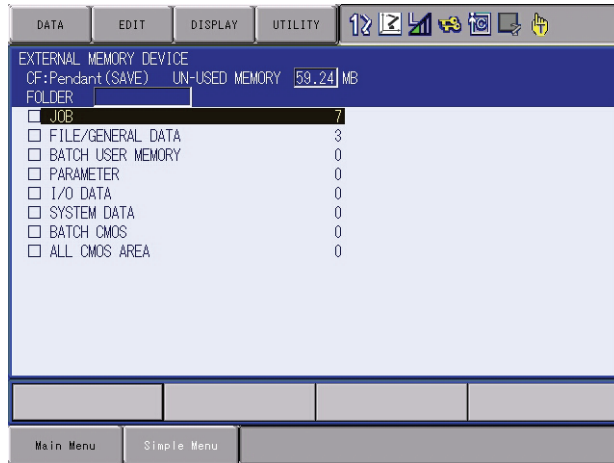

3. Move the cursor to {FILE/GENERAL DATA} and select.
 - The selection window appears.
 - The content of the display varies in accordance with applications and options.

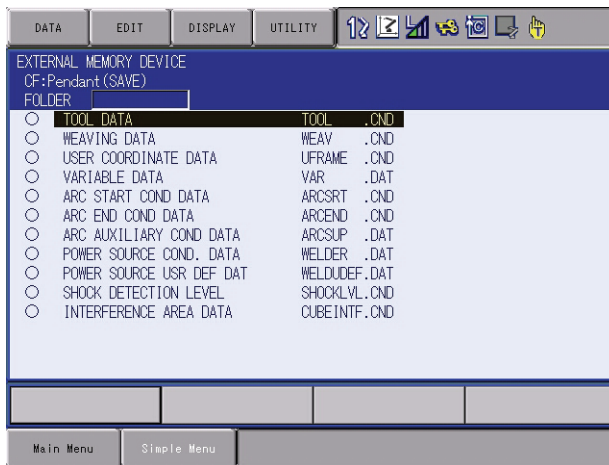

4. Select condition files or general data to be saved.
 - The selected files are marked with “★.”

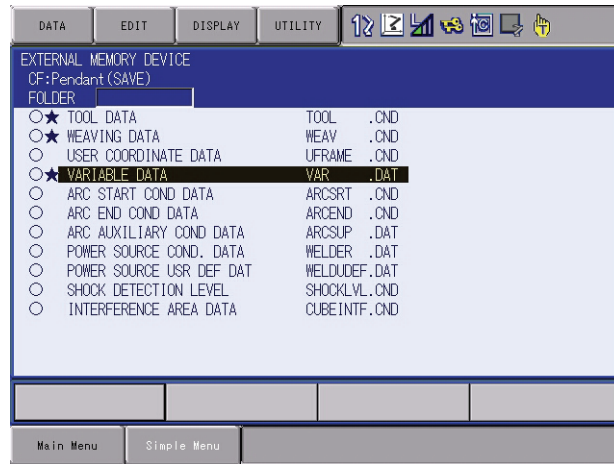

5. Press [ENTER].
 - The confirmation dialog box appears.

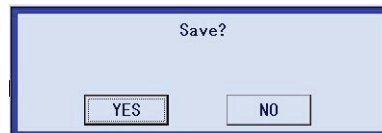

6. Select "YES."
 - The selected files are saved.

■ Saving a Parameter

1. Select {FD/PC CARD} under the main menu.
2. Select {SAVE}.
 - The following window appears.

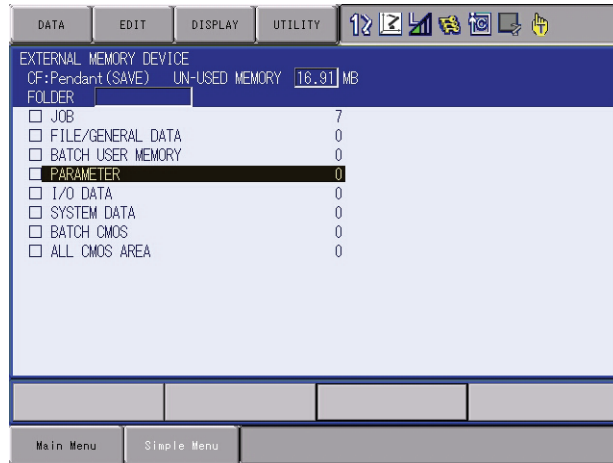

3. Move the cursor to {PARAMETER} and select.
 - The selection window for parameters appears.

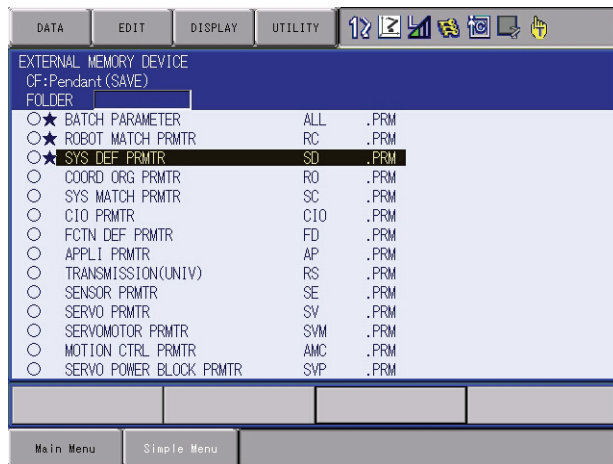

4. Select parameters to be saved.
 - The selected parameters are marked with “★.”

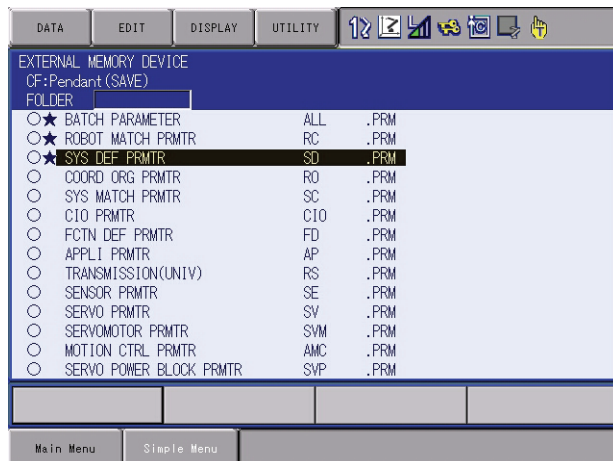

5. Press [ENTER].
- The confirmation dialog box appears.



6. Select "YES."
- The selected parameters are saved.

■ Saving I/O Data

1. Select {FD/PC CARD} under the main menu.
2. Select {SAVE}.
 - The following window appears.

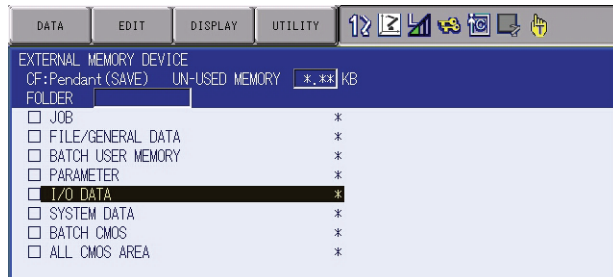

3. Move the cursor to {I/O DATA} and select.
 - The selection window for I/O data appears.



4. Select I/O data to be saved.
 - The selected I/O data are marked with "★."



5. Press [ENTER].
 - The confirmation dialog box appears.



6. Select "YES."
 - The selected I/O data are saved.

■ Saving System Data

1. Select {FD/PC CARD} under the main menu.
2. Select {SAVE}.
 - The following window appears.

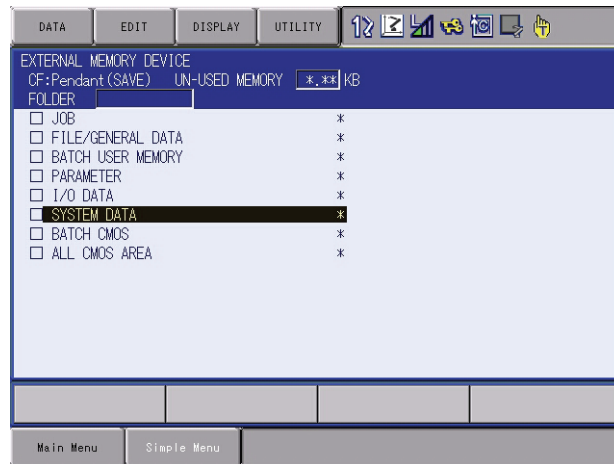

3. Move the cursor to {SYSTEM DATA} and select.
 - The selection window for system data appears.

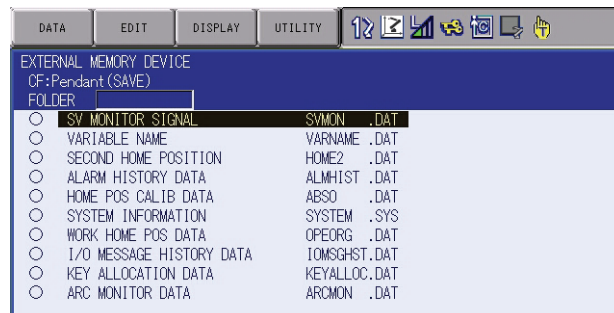

4. Select system data to be saved.
 - The selected system data are marked with "★."

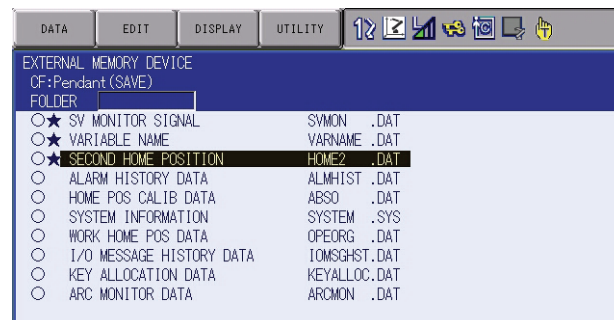

5. Press [ENTER].
 - The confirmation dialog box appears.

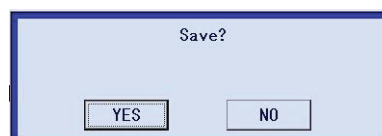

6. Select "YES."

- The selected system data are saved.

"BATCH USER MEMORY", "BATCH CMOS", and "ALL CMOS AREA" can be overwritten.



As for "JOB", "FILE/GENERAL DATA", "PARAMETER", "SYSTEM DATA", and "I/O DATA", the data cannot be overwritten. In this case, delete the file of the same name in the folder beforehand or create a new folder so that the data can be stored inside.

■ Saving All User's Programs

1. Select {FD/PC CARD} under the main menu.
2. Select {SAVE}.
 - The following window appears.

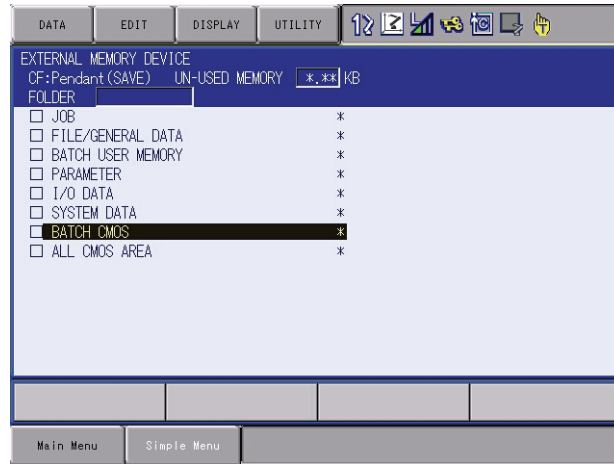

3. Move the cursor to {BATCH USER MEMORY} and select.
4. Select "EXECUTE."
 - The confirmation dialog box appears.

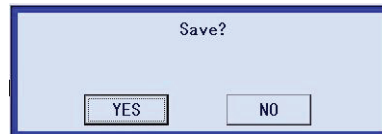

5. Select "YES."
 - All user's programs are saved.

■ Saving All CMOS Data

1. Select {FD/PC CARD} under the main menu.
2. Select {SAVE}.
 - The following window appears.

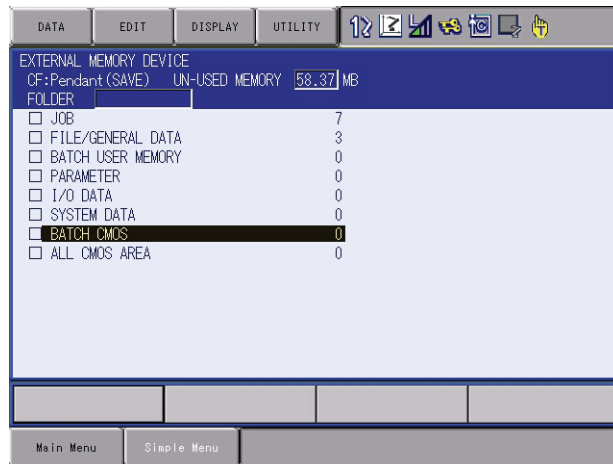

3. Move the cursor to {BATCH CMOS} and select.
4. Select "EXECUTE."
 - The confirmation dialog box appears.

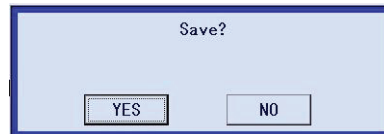

5. Select "YES."
 - All CMOS data are saved.

■ Saving All Data in CMOS Area

1. Select {FD/PC CARD} under the main menu.
2. Select {SAVE}.
 - The following window appears.

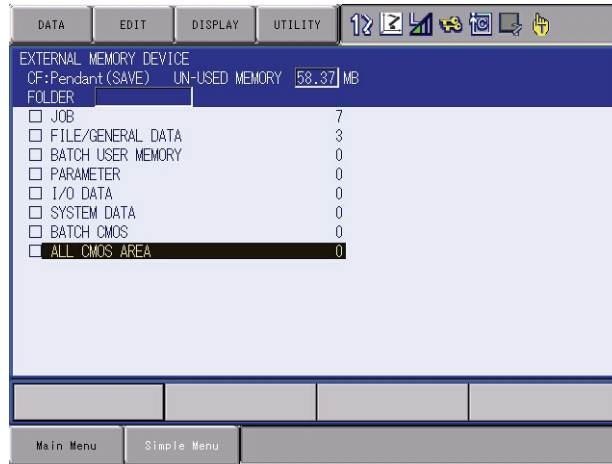

3. Move the cursor to {ALL CMOS AREA} and select.
4. Select "EXECUTE."
 - The confirmation dialog box appears.

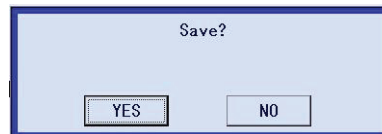

5. Select "YES."
 - All data in CMOS area are saved.

7.3.0.3 Loading Data

To upload data from the external memory device to the memory of the DX100, follow the procedure in the following.



Data such as PARAMETER, SYSTEM DATA, I/O DATA, and the batch data such as PARAMETER BATCH, BATCH CMOS, ALL CMOS AREA, that include PARAMETER, SYSTEM DATA, I/O DATA, contain the information specific to each robot controller.

Those data are prepared as backup data for reloading into the controller used for saving.

Loading the data from other controller may result in destruction or loss of critical system information.

Take extra care for the saved data.

■ Loading a Job

1. Select {FD/PC CARD} under the main menu.
2. Select {LOAD}.
 - The following window appears.

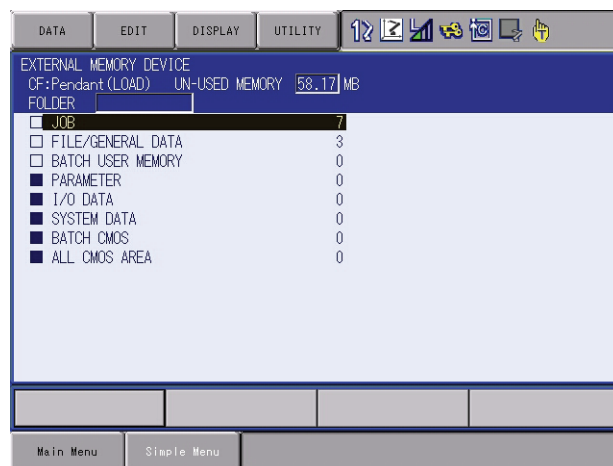

3. Select {JOB}.
 - The job selection window appears.

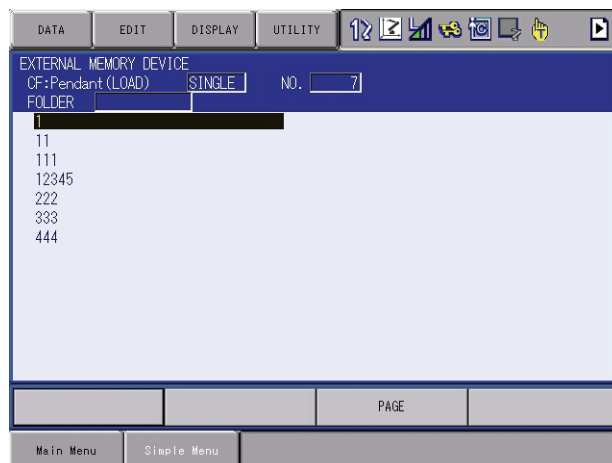

4. Select a job to be loaded.
 - The selected jobs are marked with “★.”

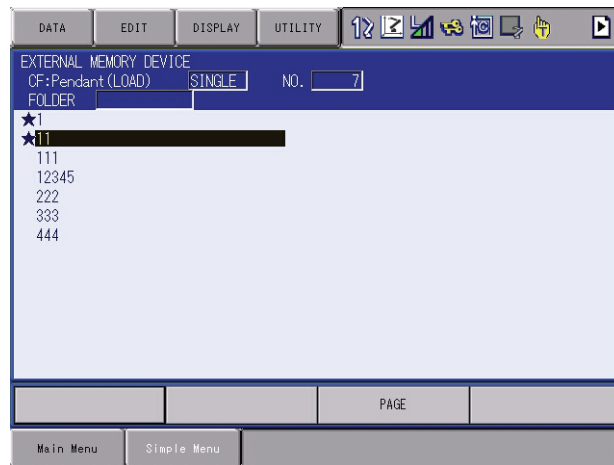

5. Press [ENTER].
 - The confirmation dialog box appears.

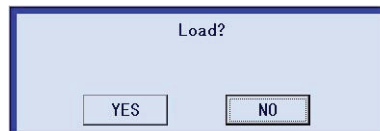

6. Select "YES."
 - The selected jobs are loaded.

■ Loading a Condition File or General Data

1. Select {FD/PC CARD} under the main menu.
2. Select {LOAD}.
 - The following window appears.

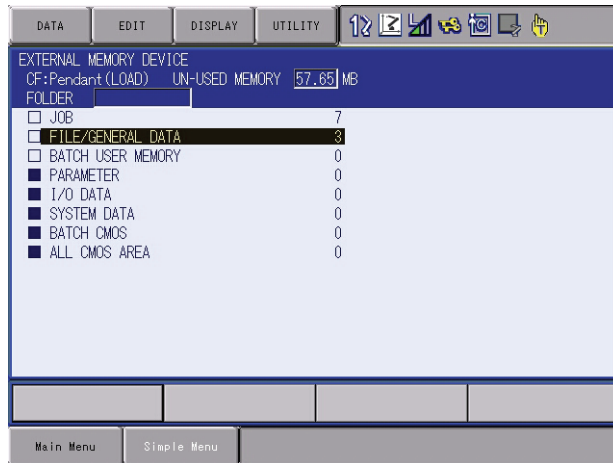

3. Move the cursor to {FILE/GENERAL DATA} and select.
 - The selection window for condition file or general data appears.

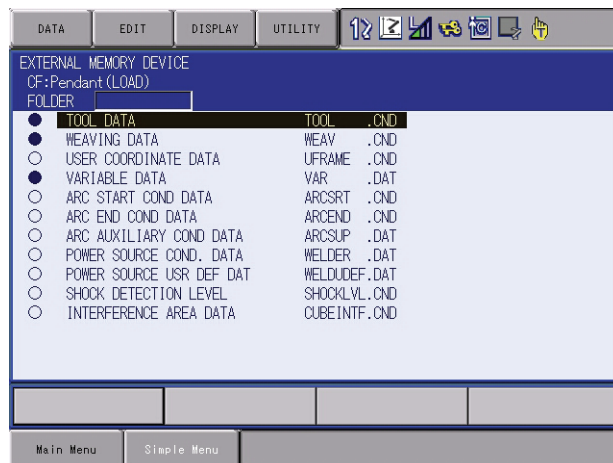

4. Select a condition file or general data to be loaded.
 - The selected files are marked with “★.”

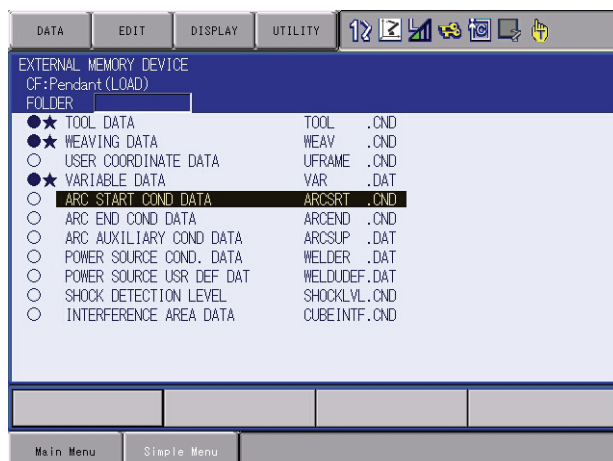

5. Press [ENTER].
 - The confirmation dialog box appears.



6. Select "YES."
 - The selected files are loaded.

■ Loading a Parameter

1. Select {FD/PC CARD} under the main menu.
2. Select {LOAD}.

 - The following window appears.

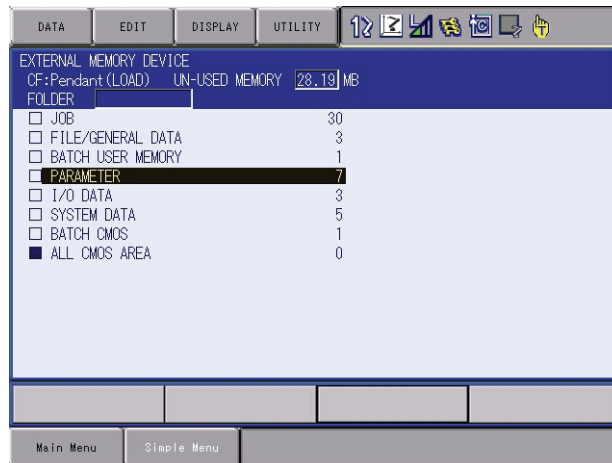

3. Move the cursor to {PARAMETER} and select.
 - The selection window for parameters appears.

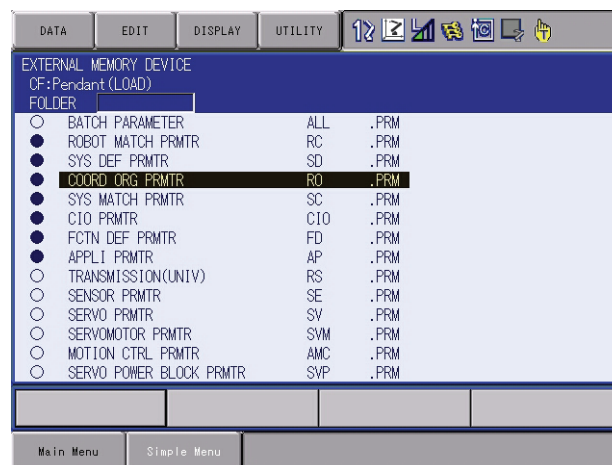

4. Select parameters to be loaded.

- The selected parameters are marked with “★.”

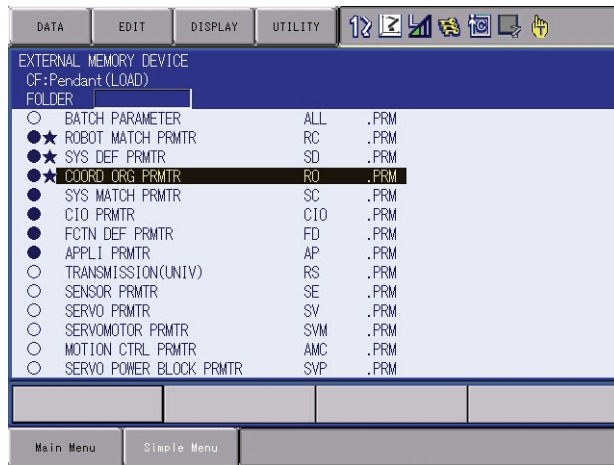

5. Press [ENTER].

- The confirmation dialog box appears.

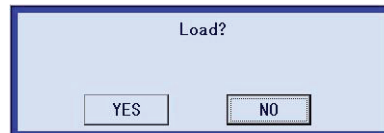

6. Select "YES."

- The selected parameters are loaded.

■ Loading I/O Data

1. Select {FD/PC CARD} under the main menu.
2. Select {LOAD}.
 - The following window appears.

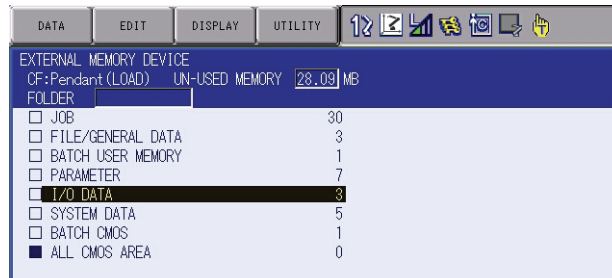

3. Move the cursor to {I/O DATA} and select.
 - The selection window for I/O data appears.



4. Select I/O data to be loaded.
 - The selected I/O data are marked with “★.”



5. Press [ENTER].
 - The confirmation dialog box appears.

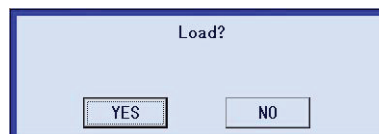

6. Select “YES.”
 - The selected I/O data are loaded.

■ Loading System Data

1. Select {FD/PC CARD} under the main menu.
2. Select {LOAD}.
 - The following window appears.

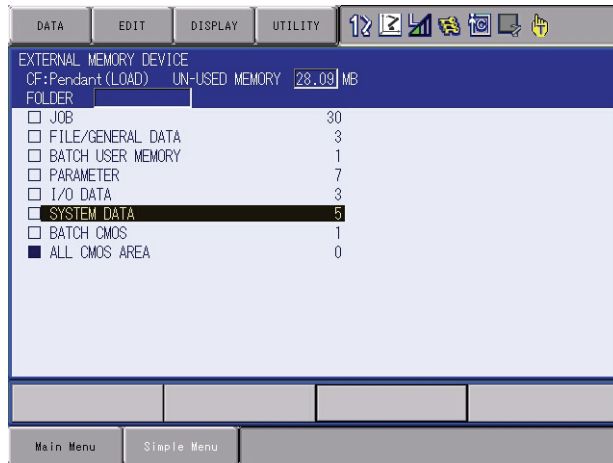

3. Move the cursor to {SYSTEM DATA} and select.
 - The selection window for system data appears.

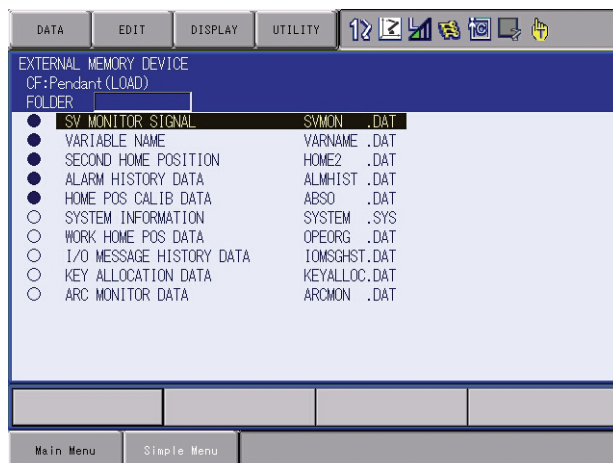

4. Select system data to be loaded.
 - The selected system data are marked with “★.”



5. Press [ENTER].
 - The confirmation dialog box appears.

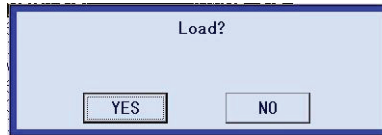

6. Select "YES."
 - The selected system data are loaded.

■ Loading All User's Programs

1. Select {FD/PC CARD} under the main menu.
2. Select {LOAD}.
 - The following window appears.

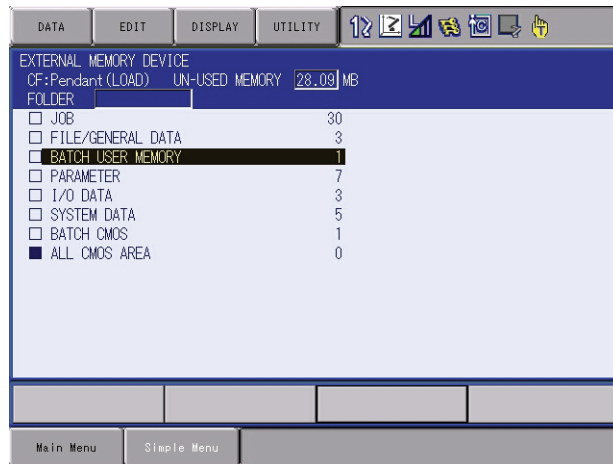

3. Move the cursor to {BATCH USER MEMORY} and select.
4. Select "EXECUTE."
 - The confirmation dialog box appears.



5. Select "YES."
 - All user's programs are loaded.

■ Loading All CMOS Data

1. Select {FD/PC CARD} under the main menu.
2. Select {LOAD}.
 - The following window appears.

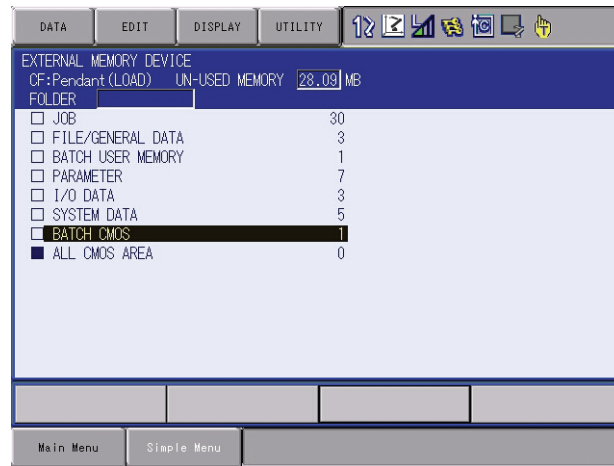

3. Move the cursor to {BATCH CMOS} and select.
4. The confirmation dialog box appears.



5. Select "YES."
 - All CMOS data are loaded.

7.3.0.4 Verifying Data

Follow the procedure below to verify data in the memory of the DX100 with data saved in the external memory device.



This function cannot be executed with “BATCH USER MEMORY,” “BATCH CMOS,” or “ALL CMOS AREA” specified.

■ Verifying a Job

1. Select {FD/PC CARD} under the main menu.
2. Select {VERIFY}.
 - The following window appears.

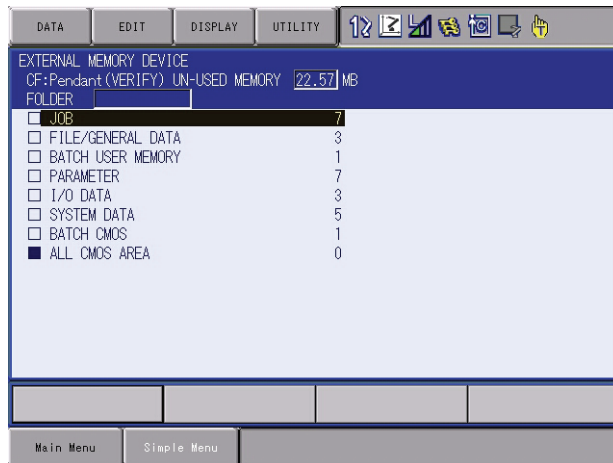

3. Select {JOB}.
 - The job selection window appears.

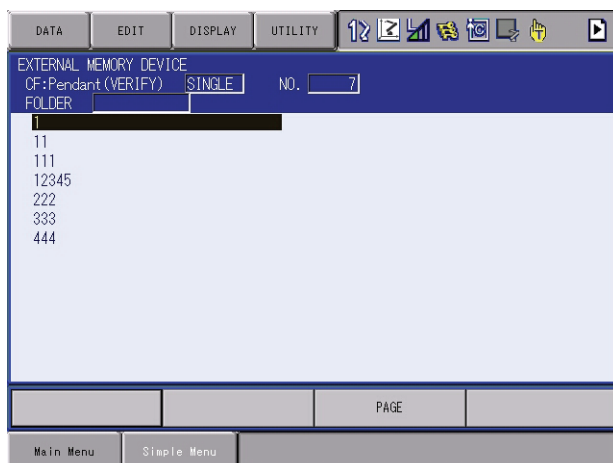

4. Select a job to be verified.
 - The selected jobs are marked with “★.”

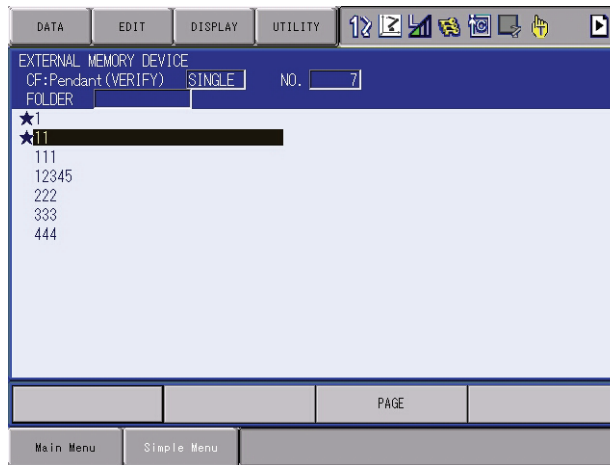

5. Press [ENTER].
 - The confirmation dialog box appears.



6. Select “YES.”
 - The selected jobs are verified.

■ Verifying a File

1. Select {FD/PC CARD} under the main menu.
2. Select {VERIFY}.
 - The following window appears.

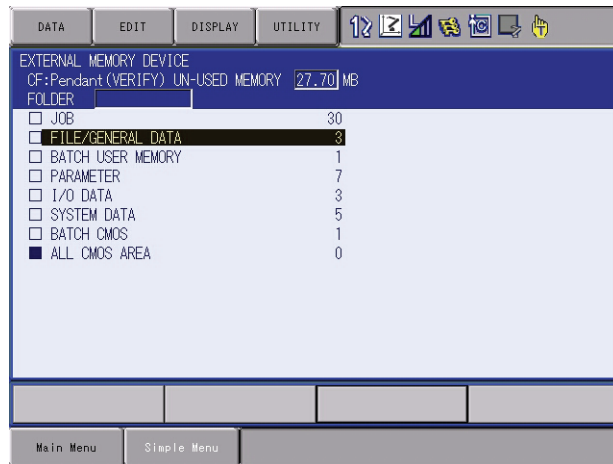

3. Select the group of the file to be verified.
4. Select a file to be verified.
 - The selected files are marked with “★.”

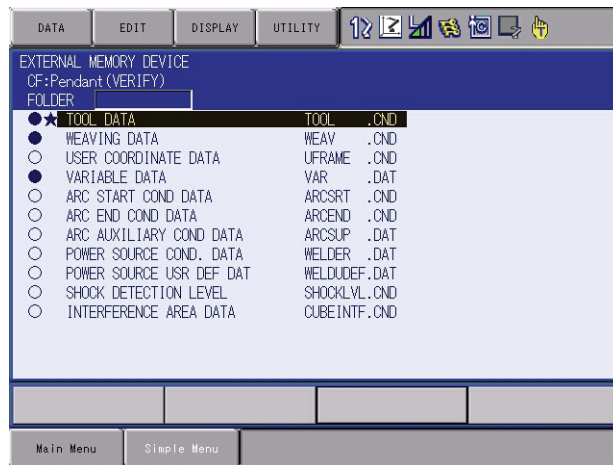

5. Press [ENTER].
 - The confirmation dialog box appears.

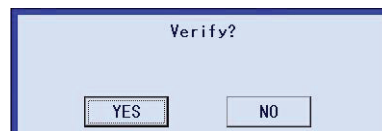

6. Select “YES.”
 - The selected files are verified.

7.3.0.5 Deleting Data

Follow the procedure below to delete a file or files on an external memory device.

■ Deleting a Job

1. Select {FD/PC CARD} under the main menu.
2. Select {DELETE}.
 - The following window appears.

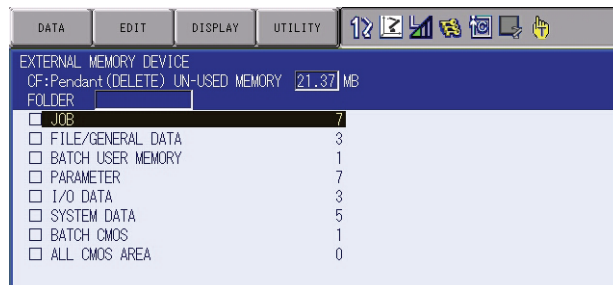

3. Select {JOB}.
 - The job selection window appears.

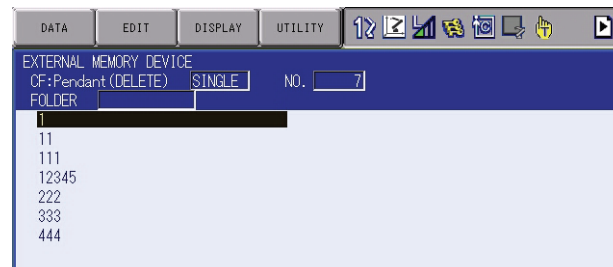

4. Select a job to be deleted.
 - The selected jobs are marked with "★."

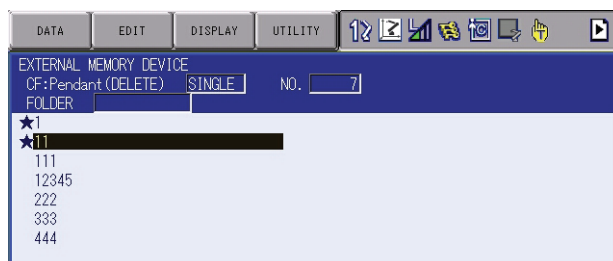

5. Press [ENTER].
 - The confirmation dialog box appears.



6. Select "YES."
 - The selected jobs are deleted.

■ Deleting a File

1. Select {FD/PC CARD} under the main menu.
2. Select {DELETE}.
 - The following window appears.



3. Select the group of the file to be deleted.



4. Select a file to be deleted.

– The selected files are marked with “★.”

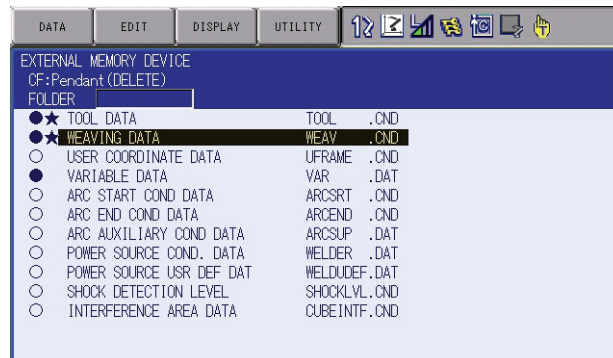

5. Press [ENTER].

– The confirmation dialog box appears.



6. Select “YES.”

– The selected files are deleted.

7.3.0.6 Job Selection Mode

The method of selecting a job and various data files when loading, saving, verifying, and deleting are described in the following:

- Individual Selection
Jobs and data files are selected individually one at a time.
- Batch Selection
Jobs and data files are selected all at one time.
- Marker (*) Selection
Loading: selects the files in the external memory device.
Saving: selects the files in the memory of the DX100.
Verifying: selects both the files in the external memory device and in the memory of the DX100.

■ Using Individual Selection

1. In either the external memory JOB LIST window or the file selection window, move the cursor to a job or a file to be selected.

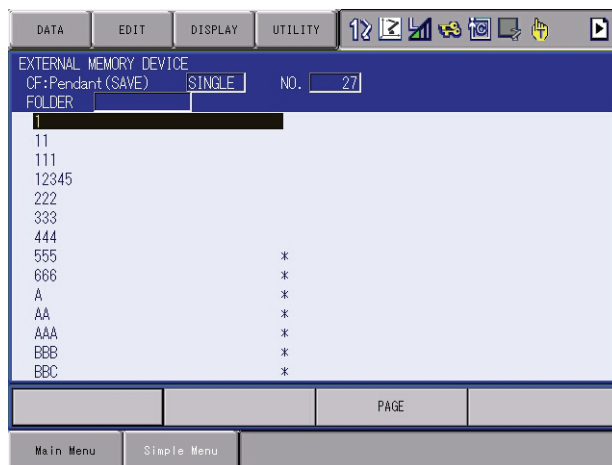

2. Press [SELECT].
Move the cursor to a file needed and press [SELECT] again.
*To cancel the selected items, select {EDIT} and then {CANCEL SELECT}.

– The selected jobs are marked with “★.”

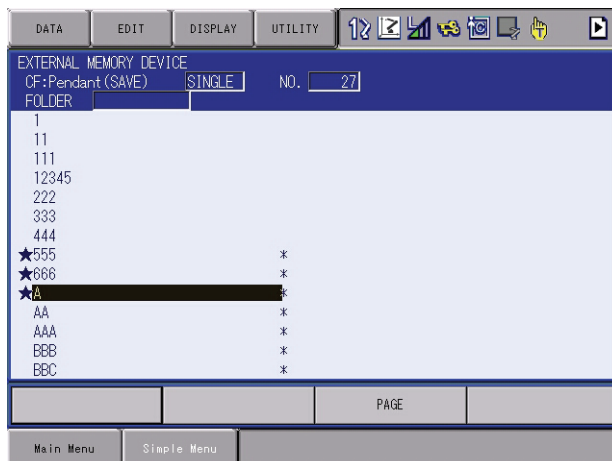

■ Using Batch Selection

1. In either the external memory JOB LIST window or the file selection window, select {EDIT} under the menu.

– The pull-down menu appears.



2. Select {SELECT ALL}.

*To cancel the selected items, select {EDIT} and then {CANCEL SELECT}.

– All jobs are selected.

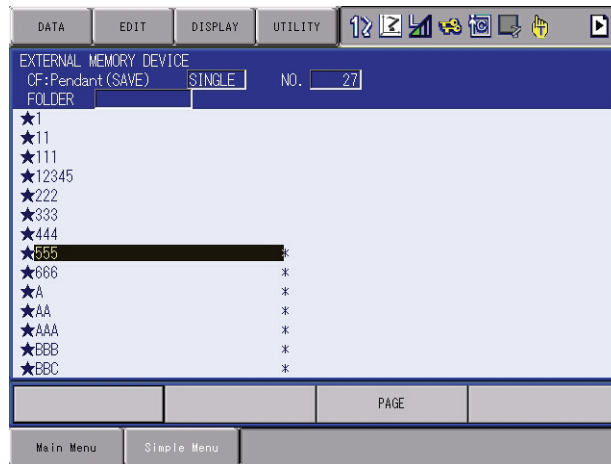

■ Using Marker (*) Selection

1. In either the external memory JOB LIST window or the file selection window, select {EDIT} under the menu.

– The pull-down menu appears.



2. Select {SELECT MARKER (*)}.
*To cancel the selected items, select {EDIT} and then {CANCEL SELECT}.

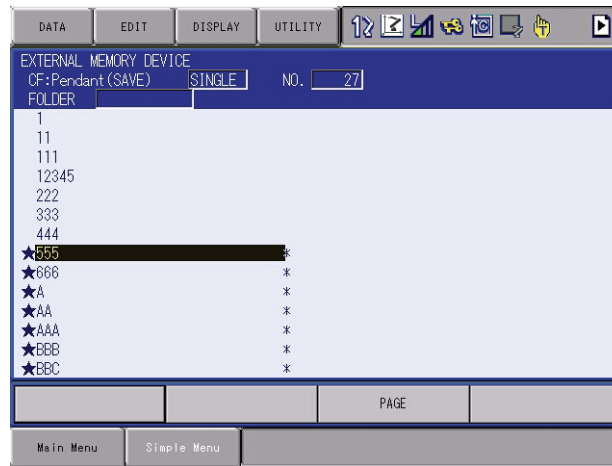

8 Parameter

8.1 Parameter Configuration

The parameters of DX100 can be classified into the following seven:

Motion Speed Setting Parameter

Determines the manipulator motion speed for jog operation at teaching, test operation, or playback operation.

Mode Operation Setting Parameter

Makes the setting for various operations in the teach mode or remote mode.

Parameter according to Interference Area

Limits the P-point maximum envelope of the manipulator or sets the interference area for axis interference or cubic interference.

Parameter according to Status I/O

Sets the parity check or I/O setting for user input/output signals.

Parameter according to Coordinated or Synchronized Operation

Makes the settings for coordinated or synchronized operations between manipulators or between manipulators and stations.

Parameter for Other Functions or Applications

Makes the settings for other functions or applications.

Hardware Control Parameter

Makes the hardware settings for fan alarm or relay operation, etc.

S1CxG Parameters



The initial setting of S1CxG parameters depends on the manipulator model.

For a system in which two manipulators are controlled, the following two types of parameters are used: S1C1G type and S1C2G type.

8.2 Motion Speed Setting Parameters

These parameters set the manipulator motion speed for jog operation at teaching, test operation, or playback operation.

8.2.0.1 S1CxG000: IN-GUARD SAFE OPERATION MAX. SPEED

Units: 0.01%

The upper speed limit is set for in-guard safe operation. While the in-guard safe operation command signal is being input, the TCP speed is limited to the TCPmax speed.

8.2.0.2 S1CxG001: DRY-RUN SPEED

Units: 0.01%

This is a dry-run operation speed setting value used when checking the path. Take safety into consideration when setting changes are unnecessary.

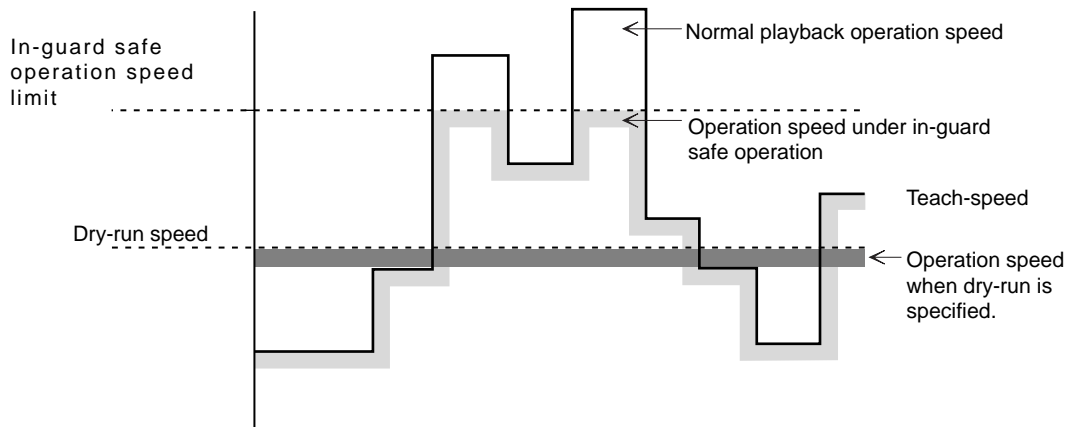

8.2.0.3 S1CxG002 to S1CxG009: JOINT SPEED FOR REGISTRATION

Units: 0.01%

The value set in these parameters is registered as the joint speed for each speed level when teaching the position data with the programming pendant. The percentage corresponding to the set value at each level is registered as 100% of the value set in the playback speed limit. Values greater than those set as speed limit values cannot be set.

- S1CxG002: Level 1
- S1CxG003: Level 2
- .
- .
- .
- S1CxG009: Level 8

DX100	8	Parameter
	8.2	Motion Speed Setting Parameters

8.2.0.4 S1CxG010 to S1CxG017: LINEAR SPEED FOR REGISTRATION

Units: 0.1mm/s

The value set in these parameters is registered as the linear speed for each speed level when teaching the position data with the programming pendant. Values greater than those set as playback speed limit values cannot be set.

- S1CxG010: Level 1
- S1CxG011: Level 2
- .
- .
- S1CxG017: Level 8

8.2.0.5 S1CxG018 to S1CxG025: POSITION ANGLE SPEED

Units: 0.1°/s

The value set in these parameters is registered as the position angle speed for each speed level when teaching the position data with the programming pendant. Values greater than those set as playback speed limit cannot be set.

- S1CxG018: Level 1
- S1CxG019: Level 2
- .
- .
- S1CxG025: Level 8

8.2.0.6 S1CxG026 to S1CxG029: JOG OPERATION ABSOLUTE VALUE SPEED

Units: 0.1mm/s

These are setting values of jog operation speed set by the programming pendant. Values greater than those set as jog operation speed limit value cannot be set.

- S1CxG026 Low level : Jog operation speed when "LOW" manual speed is specified.
- S1CxG027 Medium level : Jog operation speed when "MEDIUM" manual speed is specified.
- S1CxG028 High level : Jog operation speed when "HIGH" manual speed is specified.
- S1CxG029 High-speed-level : Jog operation speed when [HIGH SPEED] is pressed.

DX100	8	Parameter
	8.2	Motion Speed Setting Parameters

8.2.0.7 S1CxG030 to S1CxG032: INCHING MOVE AMOUNT

These parameters specify the amount per move at inching operation by the programming pendant. The referenced parameter differs according to the operation mode at inching operation.

S1CxG030	: Joint Operation (Unit: 1 pulse)
S1CxG031	: Cartesian/cylindrical (Unit: 0.001 mm)
S1CxG032	: Motion about TCP (Unit: 0.001 degree)



If the value set for S1CxG031 or S1CxG032 is too small, the inching operation does not proceed.



Note that the units of S1CxG031 and S1CxG032 are smaller than those for the NX100.

8.2.0.8 S1CxG033 to S1CxG040: POSITIONING ZONE

This parameter value will be referenced when positioning is specified with the “MOVE” instruction: MOVJ (joint movement) or MOVL (linear movement).

<Example> MOVL V=100.0 PL=1

└───┬───┘ Positioning level

└───┘ Positioning specification

The value set in this parameter specifies the range to enter in relation to the teaching point for that step positioning. After entering the specified positioning zone, the manipulator starts moving to the next step. The system is also set up so inward turning operation is carried out in the moving section when moving to the next path; speed changeover is smooth.

- S1CxG033: Positioning level 1
- S1CxG034: Positioning level 2
- .
- .
- .
- S1CxG040: Positioning level 8

Since operation will be turning inward during playback, as shown in the following diagram, use setting values taking safety aspects into consideration.

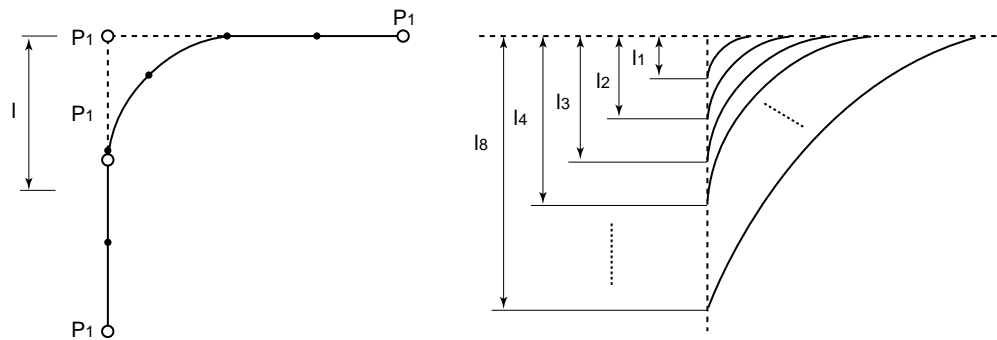

This process becomes effective when change in direction of steps is between 25° and 155° .

Position Level

Position levels are divided into nine stages of 0 to 8 with the "MOV" instruction.

e.g. `MOVL V=500 PL=1` (PL:Position Level)

The functions at each level are as follows:

0: Complete positioning to the target point

1 to 8: Inward turning operation

Following are explanations of the respective processing details and their relations with the parameter.

- Level 0

Determines positioning completion when the amount of deviation (number of pulses) to the target point of each axis comes within the position set zone specified by the parameter.

After the positioning completes, the instruction system starts instruction to the next target point.

- Level 1 to 8

Recognizes virtual positioning before the target point. The distance of the virtual target position from the target point is specified at the positioning level.

Distance data corresponding to each level are set in the parameter. Determination of the virtual target position is carried out in the instruction system.

Set zone: The zone of each positioning level set in the parameter. (μm)



DX100	8	Parameter
	8.2	Motion Speed Setting Parameters

8.2.0.9 S1CxG044: LOW-SPEED START

Units: 0.01%

This parameter specifies max. speed at low speed start. Specify the starting method for “initial operation speed of manipulator” (S2C217).

8.2.0.10 S1CxG045 to S1CxG048: JOG OPERATION LINK SPEED

Units: 0.01%

These parameters prescribe the link speed at jog operation by the programming pendant. Specify the percentage (%) for the jog operation speed limit, the joint max. speed.

S1CxG045: Jog operation link speed at level “LOW”

S1CxG046: Jog operation link speed at level “MEDIUM”

S1CxG047: Jog operation link speed at level “HIGH”

S1CxG048: Jog operation link speed at level “HIGH SPEED”

8.2.0.11 S1CxG056: WORK HOME POSITION RETURN SPEED

Units: 0.01%

This parameter specifies the speed for returning to work home position against the maximum speed.

8.2.0.12 S1CxG057: SEARCH MAX. SPEED

Units: 0.1mm/s

This parameter specifies the max. speed for searching.

8.2.0.13 S2C201: POSTURE CONTROL AT CARTESIAN OPERATION OF JOG

This parameter specifies whether or not posture control is performed at cartesian operation of “JOG” by the programming pendant. Use posture control unless a special manipulator model is used.

0 : With posture control

1 : Without posture control

8.2.0.14 S2C202: OPERATION IN USER COORDINATE SYSTEM (WHEN EXTERNAL REFERENCE POINT CONTROL FUNCTION USED)

This parameter specifies the TCP or reference point of motion about TCP when the external reference point control function is used and the user coordinate system is selected by the programming pendant.

Fig. 8-1: 0: When manipulator TCP is selected

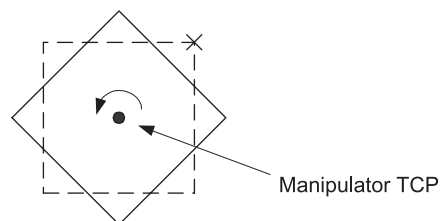
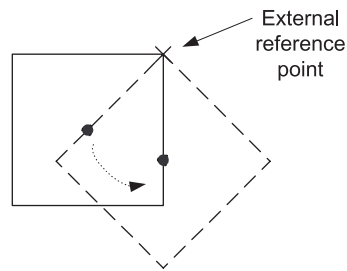

Fig. 8-2: 1: When external reference point is selected

8.2.0.15 S2C320: CONTROLLED GROUP JOB TEACHING POSITION CHANGE

This parameter is used to change only the job teaching position of controlled group axis.

- 0 : Not changed
- 1 : Changed

8.2.0.16 S2C422: OPERATION AFTER RESET FROM PATH DEVIATION

8.2.0.17 S2C423: OPERATION AFTER JOB

These parameters specify the method of restarting the manipulator that has deviated from the normal path such as an emergency stop or jog operation.

- 0 : Move to the indicated step (initial setting).
- 1 : After moving back to the deviated position, move to the indicated step.
- 2 : Move back to the deviated position and stop.

Table 8-1: S2C422

Parameter Setting Value	Movement When Restarting
0	<p>Move to next step.</p> <p>Emergency stop</p> <p>Movement when restarting</p> <p>Move to next step.</p>
1	<p>After moving back to the deviated position, move to the indicated step.</p> <p>Emergency stop</p> <p>Move back to the deviated position and stop.</p> <p>When restarting, move to the indicated step.</p>
2	<p>Emergency stop (Servo OFF)</p> <p>Emergency stop (Servo OFF)</p> <p>Move back the the deviated position and then move to the indicated step.</p>

Table 8-2: S2C423

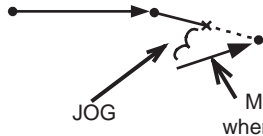
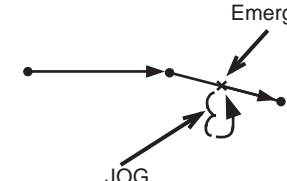
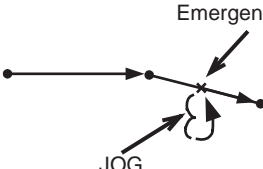
Parameter Setting Value	Movement When Restarting
0	<p>Move to the next step.</p>  <p>Move to next step.</p>
1	<p>After moving back to the deviated position, move to the indicated step.</p>  <p>Move back to the deviated position and then move to the indicated step.</p>
2	 <p>Move back to the deviated position and stop. When restarting, move to the indicated step.</p>



- To the path deviated position, the manipulator moves in a straight line at low speed operation (SICxG044). It is linear movement. After resetting from deviation, the speed becomes the same as taught speed.
- The initial setting (prior to shipping) is 0: The manipulator moves in a straight line from the present position to the indicated step.

8.2.0.18 S2C424: DEVIATED POSITION

This parameter specifies whether deviated position is to be robot current (reference) position or feedback position.

- 0 : Return to the feedback position.
- 1 : Return to the current value (reference) position.

When emergency stop is applied during high-speed motion, the deviated position differs from the robot current value (reference) position and feedback position as shown in the following.

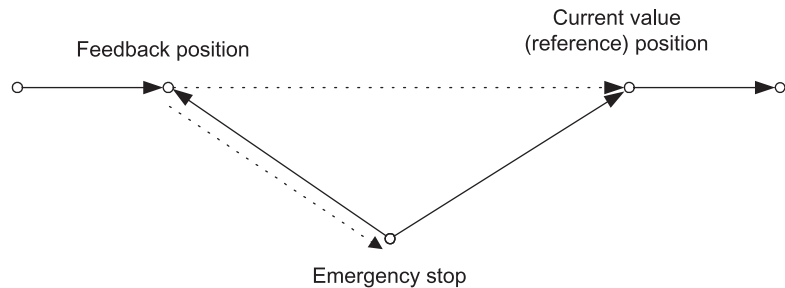

8.2.0.19 S2C425: CIRCULAR INTERPOLATION TOOL POSITION CONTROL

This parameter selects tool position control methods at circular interpolation operation.

- 0 : Fixed angle position
Interpolation is performed depending on the position change viewed from the base coordinate.
As the figure below (left) shows, when tool position viewed from outside is not significantly changed and that position is mainly taught at teaching, this setting is required.
- 1 : Rotating position by circular arc path
Interpolation is performed depending on the position change corresponding to circular arc path.
As the figure below (right) shows, when tool position corresponding to circular arc path (tool position viewed from the center of the circular arc) is not significantly changed, and that position is mainly taught at teaching, this setting is required.

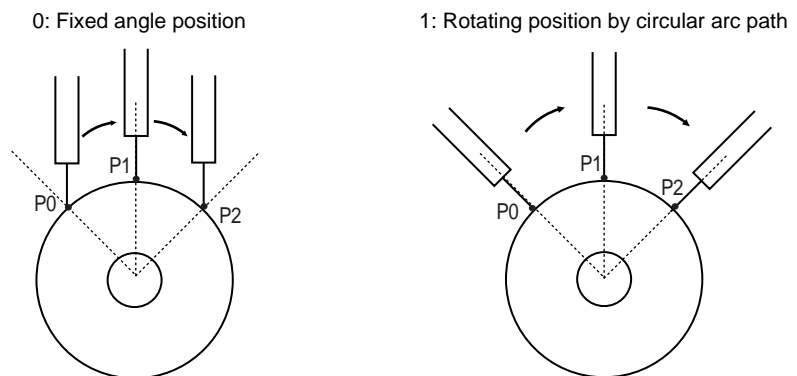

8.2.0.20 S2C653: EMERGENCY STOP CURSOR ADVANCE CONTROL FUNCTION

This parameter specifies whether to use the cursor advance control function or not.

- 0: Not use
- 1: Use

8.2.0.21 S2C654: EMERGENCY STOP CURSOR ADVANCE CONTROL FUNCTION CONT
PROCESS COMPLETION POSITION

Units: %

When the manipulator stops during moving inner corner by CONT process, this parameter specifies which position of the inner corner should be considered as the end of step.

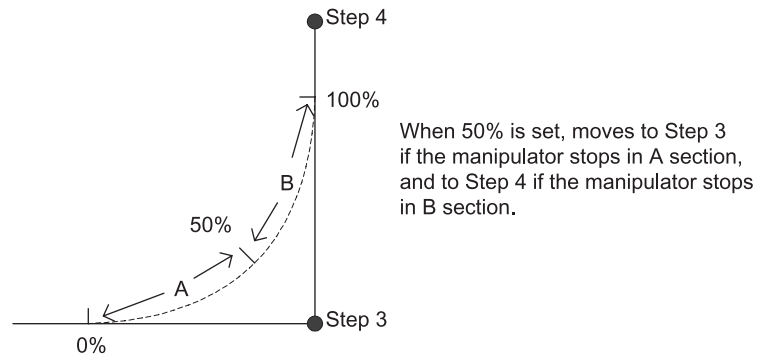

8.2.0.22 S2C655: EMERGENCY STOP ADVANCE CONTROL FUNCTION WORK START
INSTRUCTION STEP MOTION COMPLETION DELAY TIME

Units: ms

In order to recognize securely the completion of motion to the step of work start instruction (such as ARCON instruction), this parameter specifies the delay time for motion completion of the work start instruction step only.

8.2.0.23 S2C698: BASE AXIS OPERATION KEY ALLOCATION SETTING

Table 8-3: Parameter Setting and Jog Operation Key Allocation

Coordinates/Parameter	S2C698= "0"	S2C698= "1"
Joint	Axis number order	Specified
Cylindrical	Axis number order	Specified
Cartesian	Specified	Specified
Tool	Specified	Specified
User	Specified	Specified

Axis number order: X: First axis, Y: Second axis, Z: Third axis

Specified: X: X-direction (RECT-X), Y: Y-direction (RECT-Y), Z: Z-direction (RECT-Z)

	8	Parameter
DX100	8.2	Motion Speed Setting Parameters

8.2.0.24 S3C1098 to S3C1102: POSITION CORRECTING FUNCTION DURING PLAYBACK

These parameters specify the necessary data for position correcting function (PAM) during playback operation.

S3C1098	Specifies the limit of position correcting range (Units: μm)
S3C1099	Specifies the limit of speed correcting range (Units: 0.01%)
S3C1100	Specifies the correcting coordinates 0 : Base 1 : Robot 2 : Tool 3 : User 1 to 26:User 24
S3C1102	Specifies the limit of posture angle adjustment range (Units: 0.01°)

DX100	8	Parameter
	8.3	Mode Operation Setting Parameters

8.3 Mode Operation Setting Parameters

These parameters set various operations in the teach mode or remote mode.

Some parameters can be set through {SETUP} → {TEACHING COND} or {OPERATE COND}.

8.3.0.1 S2C195: SECURITY MODE WHEN CONTROL POWER SUPPLY IS TURNED ON

The operation level when the control power supply is turned ON is set.

- 0 : Operation Mode
- 1 : Editing Mode
- 2 : Management Mode

8.3.0.2 S2C196: SELECTION OF CARTESIAN/CYLINDRICAL

This parameter specifies whether the cartesian mode or cylindrical mode is affected when cartesian/cylindrical mode is selected by operation (coordinate) mode selection at axis operation of programming pendant. This specification can be done on the TEACHING CONDITION window.

- 0 : Cylindrical mode
- 1 : Cartesian mode



8.3.0.3 S2C197: COORDINATE SWITCHING PROHIBITED

This parameter prohibits switching coordinates during JOG operation by the programming pendant.

- 0 : Switching permitted for tool coordinates and user coordinates
- 1 : Switching prohibited for tool coordinates
- 2 : Switching prohibited for user coordinates
- 3 : Switching prohibited for tool coordinates and user coordinates

8.3.0.4 S2C198: EXECUTION UNITS AT "FORWARD" OPERATION

This parameter specifies the execution units at step mode of "FORWARD" operation by the programming pendant .

Parameter Setting Value	Operation Units
0	MOVL DOUT TIMER DOUT MOVL  Stops at every instruction
1	MOVL DOUT TIMER DOUT MOVL  Stops at move instruction

DX100	8	Parameter
	8.3	Mode Operation Setting Parameters

8.3.0.5 S2C199: INSTRUCTION (EXCEPT FOR MOVE) EXECUTION AT “FORWARD” OPERATION

This parameter specifies the method of instruction (except for move) execution at “FORWARD” operation by the programming pendant.

- 0 : Executed by pressing [FWD] + [INTERLOCK]
- 1 : Executed by pressing [FWD] only
- 2 : Instruction not executed

8.3.0.6 S2C203: CHANGING STEP ONLY

This parameter specifies whether to permit only step changes in an editing-prohibited job. When permitted, only position data can be changed but additional data such as speed cannot be changed. This specification can be done on the TEACHING CONDITION window.

- 0 : Permitted
- 1 : Prohibited

8.3.0.7 S2C204: MANUAL SPEED STORING FOR EACH COORDINATE

This parameter specifies whether to assign different manual speeds for the joint coordinates and other coordinates. If “NOT STORED” is selected, manual speed is not affected by changing the coordinates. If “STORED” is selected, manual speeds can be selected separately for the joint coordinates and other coordinates.

- 0 : Not stored
- 1 : Stored

8.3.0.8 S2C206: ADDITIONAL STEP POSITION

This parameter designates either “before next step” or “after the cursor position (between instructions)” as additional step position. This specification can be done on the TEACHING CONDITION window.

Fig. 8-3: <Example>

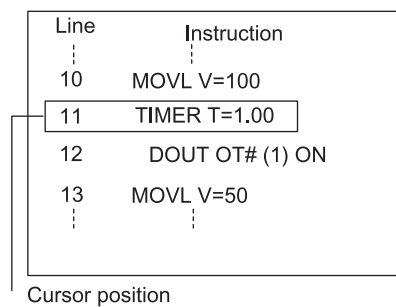

Fig. 8-4: S2C206-0 (Before the Next Step)

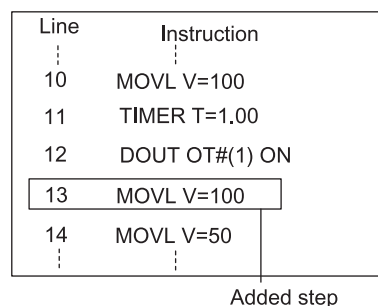

Fig. 8-5: S2C206-1 (Between Instructions)

Line	Instruction
⋮	⋮
10	MOVL V=100
11	TIMER T=1.00
12	MOVL V=100
13	DOUT OT# (1) ON
14	MOVL V=50
⋮	⋮

Added step

8.3.0.9 S2C207: MASTER JOB CHANGING OPERATION

This parameter specifies whether to permit or prohibit master job changing operation. If "PROHIBIT" is specified, the master job cannot be changed (or registered) easily. The specification can be done on the OPERATING CONDITION window.

- 0 : Permitted
- 1 : Prohibited

8.3.0.10 S2C208: CHECK AND MACHINE-LOCK KEY OPERATION IN PLAY MODE

This parameter specifies whether to permit or prohibit in play mode to change the operation that changes the operation condition. Even if an error occurs because of the operation with the keys, the manipulator does not stop. The specification can be done on the OPERATING CONDITION window.

- 0 : Permitted
- 1 : Prohibited

8.3.0.11 S2C209: RESERVED WORK JOB CHANGING OPERATION

This parameter specifies whether to permit reserved work job changing operation.

The designation can be done on the OPERATING CONDITION window.

- 0 : Permitted
- 1 : Prohibited

8.3.0.12 S2C210: MASTER OR SUBMASTER CALL OPERATION IN PLAY MODE

This parameter specifies whether the master or submaster call operation in play mode is permitted or not. When the independent control function is valid, the master job for sub-task is specified at the same time. The specification can be done on the OPERATING CONDITION window.

- 0 : Permitted
- 1 : Prohibited

	8	Parameter
DX100	8.3	Mode Operation Setting Parameters

8.3.0.13 S2C211: LANGUAGE LEVEL

This parameter specifies the level of the robot language (INFORM III). The levels simplify the instruction registering operation. With the DX100, all robot instructions can be executed regardless of specification of instruction sets. The specification can be done on the TEACHING CONDITION window.

0: Contracted Level

Only frequently used robot instructions are selected to reduce the number of instructions to be registered. Robot instructions displayed on the instruction dialog box are also reduced so that specification is simplified.

1: Standard Level

2: Expanded Level

All the robot instructions are available in standard and expanded levels. The two levels are distinguished by the number of additional information items (tags) that can be used with robot instructions. At the expanded level, the following functions are available.

- Local Variables and Array Variables
- Use of Variables for Tags (Example: MOVJ VJ=I000)
The above functions are not available at the standard level, however, which reduces the number of data required to register instructions, thereby simplifying the operation.

8.3.0.14 S2C214: INSTRUCTION INPUT LEARNING FUNCTION

This parameter specifies whether to set a line of instructions that has been input on the input buffer line when pressing the first soft key for each instruction. If "PROVIDED" is selected, the instructions are set.

- 0 : Without learning function
- 1 : With learning function

8.3.0.15 S2C215: ADDRESS SETTING WHEN CONTROL POWER IS TURNED ON

This parameter specifies the processing of the job name, step No., and line No. that are set when the control power supply is turned ON.

- 0 : Reproduces the address when power supply is turned ON.
- 1 : Lead address (Line"0") of the master job.

8.3.0.16 S2C216: JOB LIST DISPLAY METHOD AT JOB SELECTION

These parameters specify the displaying method on the JOB LIST window at job selection.



- 0 : Order of Names
- 1 : Order of Date

8.3.0.17 S2C217: INITIAL OPERATION OF MANIPULATOR

This parameter specifies the operation speed level of the first section when starting. Specify the operation speed with the low-speed start (S1CxG044). When starting at low-speed, the manipulator stops after reaching the indicated step regardless of the cycle setting. Once the manipulator is paused during the low-speed operation, it moves at teaching speed when restarted.

- 0 : Specified on the SPECIAL PLAY window. Operates at low speed only when low speed start is set. Operates at taught speed when not instructed.
- 1 : Starts at low speed after editing regardless of soft key instructions.

8.3.0.18 S2C218: PLAYBACK EXECUTION AT CYCLE MODE "1- STEP"

Parameter Setting Value	Operation Units
0	MOVL DOUT TIMER DOUT MOVL  Stops at every instruction
1	MOVL DOUT TIMER DOUT MOVL  Stops at move instruction



When operating "FORWARD" by the programming pendant, the units for execution are set in another parameter (S2C198).

8.3.0.19 S2C219: EXTERNAL START

This parameter specifies whether a start instruction from external input is accepted or not. The specification can be done on the OPERATING CONDITION window.

- 0 : Permitted
- 1 : Prohibited

8.3.0.20 S2C220: PROGRAMMING PENDANT START

This parameter specifies whether a start instruction from the programming pendant is accepted or not.

- 0 : Permitted
- 1 : Prohibited

	8	Parameter
DX100	8.3	Mode Operation Setting Parameters

8.3.0.21 S2C221: SPEED DATA INPUT FORM

This parameter specifies the units for speed data input and display.

mm/s : in units of 0.1 mm/s

cm/min : in units of 1cm/min

inch/min : in units of 1 inch/min

mm/min : in units of 1 mm/min

The specification can be done on the OPERATING CONDITION window.

0 : mm/sec

1 : cm/min

2 : inch/min

3 : mm/min

8.3.0.22 S2C222: RESERVED START

This parameter specifies whether a reserved start instruction from the programming pendant is accepted or not. The specification can be done on the OPERATING CONDITION window.

0 : Permitted

1 : Prohibited

8.3.0.23 S2C224: JOB SELECTION AT REMOTE FUNCTION (PLAY MODE)

This parameter specifies whether a job selection in play mode at remote function is prohibited or not.

0 : Permitted

1 : Prohibited

8.3.0.24 S2C225: EXTERNAL MODE SWITCH

This parameter specifies whether mode switching from the outside is accepted or not. The specification can be done on the OPERATING CONDITION window.

0 : Permitted

1 : Prohibited

8.3.0.25 S2C227: EXTERNAL CYCLE SWITCHING

This parameter specifies whether cycle switching from the outside is accepted or not. The specification can be done on the OPERATING CONDITION window.

0 : Permitted

1 : Prohibited

DX100	8	Parameter
	8.3	Mode Operation Setting Parameters

8.3.0.26 S2C228: PROGRAMMING PENDANT CYCLE SWITCHING

This parameter specifies whether cycle switching from the programming pendant is accepted or not. The specification can be done on the OPERATING CONDITION window.

- 0 : Permitted
- 1 : Prohibited

8.3.0.27 S2C229: SERVO ON FROM EXTERNAL PP PROHIBITION

This parameter specifies whether a servo ON instruction is accepted or not. More than one instruction can be specified. For example, to permit the servo ON instruction from an external input only, set "2." In this case, servo ON instruction from the programming pendant is not accepted. The specification can be done on the OPERATING CONDITION window.

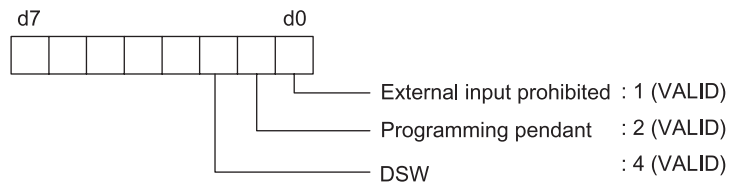

8.3.0.28 S2C230: PROGRAMMING PENDANT OPERATION WHEN "IO" IS SELECTED FOR REMOTE MODE

This parameter specifies whether each operation of the following is valid when "IO" is selected for remote function selection. IO and command are available for remote function selection: "IO" is set prior to shipping. "Command" is valid when transmission function (optional) is specified.

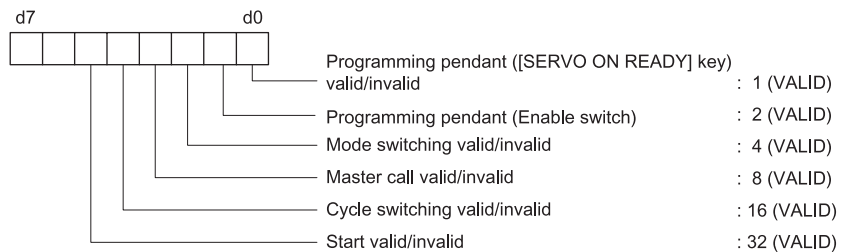

	8	Parameter
DX100	8.3	Mode Operation Setting Parameters

8.3.0.29 S2C234: STEP REGISTRATION AT TOOL NO. CHANGE

The registration of the step when the tool number is changed allows the setting to be made as prohibited.

If this parameter is set to "1" (prohibited), the following operations are prohibited.

- 0 : Permitted
- 1 : Prohibited

- Modification of a step
When the tool number of the teaching step differs from the currently-selected tool number, the step cannot be modified.
- Deletion of a step
Even if the teaching step position coincides with the current position, the step cannot be deleted when the tool number of the teaching step differs from the currently-selected tool number.
- Addition of a step
When the tool number of the teaching step indicated by the cursor differs from the currently-selected tool number, the step cannot be added.

8.3.0.30 S2C293: REMOTE FIRST CYCLE MODE

This parameter sets the cycle that changes from the local mode to the remote mode.

The setting can be made on the OPERATING CONDITION window.

- 0 : Step
- 1 : 1 cycle
- 2 : Continuous
- 3 : Setting retained

8.3.0.31 S2C294: LOCAL FIRST CYCLE MODE

This parameter sets the cycle that changes from the remote mode to the local mode.

The setting can be made on the OPERATING CONDITION window.

- 0 : Step
- 1 : 1 cycle
- 2 : Continuous
- 3 : Setting retained

8.3.0.32 S2C312: POWER ON FIRST CYCLE MODE

This parameter sets the first cycle mode for when the power is turned ON.

The setting can be made on the OPERATING CONDITION window.

- 0 : Step
- 1 : 1 cycle
- 2 : Continuous
- 3 : Setting retained

	8	Parameter
DX100	8.3	Mode Operation Setting Parameters

8.3.0.33 S2C313: TEACH MODE FIRST CYCLE MODE

This parameter sets the cycle that changes from the play mode to the teach mode.

The setting can be made on the OPERATING CONDITION window.

- 0 : Step
- 1 : 1 cycle
- 2 : Continuous
- 3 : Setting retained

DX100	8	Parameter
	8.3	Mode Operation Setting Parameters

8.3.0.34 S2C314: PLAY MODE FIRST CYCLE MODE

This parameter sets the cycle that changes from the teach mode to the play mode.

The setting can be made on the OPERATING CONDITION window.

- 0 : Step
- 1 : 1 cycle
- 2 : Continuous
- 3 : Setting retained

8.3.0.35 S2C316: START CONDITION AFTER ALARM-4107 (“OUT OF RANGE (ABSOLUTE DATA)”)

This parameter specifies the activating method after the alarm 4107 (“OUT OF RANGE (ABSOLUTE DATA)”) occurs.

- 0 : Position check operation required
- 1 : Low-speed start up

DX100	8	Parameter
	8.3	Mode Operation Setting Parameters

8.3.0.36 S2C395: SIGNAL NAME ALIAS FUNCTION

On the JOB CONTENT window, the name registered to the user input/output signal number can be displayed as alias instead of the signal number itself.

Table 8-4: S2C395

Parameter Setting Value	Valid/Invalid
0	Function invalid
1	Function valid

1. With this function valid, the confirmation dialog box “Register by name (alias)?” is displayed when a signal (IN#(), OT#(), IG#(), OG#(), IGH#(), OGH#()) is selected on the DETAIL EDIT window.
2. Select “YES” and the signal select window appears. Then select the target signal of number and press [ENTER], and the registered name is displayed instead of the signal number. However, if the signal number’s name is not yet registered, it is displayed by number as usual.

<Example> Registration of the name of user output OUT#0001 as “OUTPUT 1”

In the case of DOUT instruction:

S2C395=0 : DOUT OT#(1) ON

S2C395=1 : DOUT OT#(OUTPUT 1) ON

Select {IN/OUT} → {UNIVERSAL INPUT/OUTPUT} to edit signal names on the window. Up to 16 characters can be entered as a signal name. However, when this function is valid, if the content below is entered, the error message shows and the name cannot be registered.

- The name already registered
- Letters beginning with a number
- Letters including the signs below:
(,) , [,] , = , < , > , space, comma
- Letters beginning with “alphabets representing variables” + “number”



<Example> B0..., I0..., BP1..., LEX2...

Alphabets representing variables: B, I, D, R, S, P, BP, EX, PX, LB, LI LD, LR, LS, LP, LBP, LEX, LPX

When the name begins with “ ‘ ”, it is regarded as a comment and the same comment can be registered for two or more signals. In this case, although this function is valid, the number is displayed on the JOB CONTENT window instead of the name.

<Example> Registration of the name of user output OUT#0002 as “ ‘OUTPUT 2”

S2C395=0 : DOUT OT#(2) ON

S2C395=1 : DOUT OT#(2) ON

8.3.0.37 S2C396: VARIABLE NAME ALIAS FUNCTION

On the JOB CONTENT window, the name registered to the variable (including local variables) can be displayed as alias instead of the variable number.

Table 8-5: S2C396

Parameter Setting Value	Valid/Invalid
0	Function invalid
1	Function valid

1. With this function valid, the confirmation dialog box “Register by name (alias) ?” is displayed when you select the variable on the DETAIL EDIT window.
2. Select “YES” and the variable select window appears. Then select the target variable of number and press [ENTER], and the registered name is displayed instead of the variable number. However, if the variable number’s name is not yet registered, it is displayed by number as usual.

<Example> Registration of the byte type variable B000 as “WORK KIND”
 In the case of SET instruction
 S2C396=0 : SET B000 128
 S2C396=1 : SET WORK KIND 128

Select {VARIABLE} from the menu to select each variable and edit the variable name. Up to 16 characters can be entered as a variable name. However, when this function is valid, if the content below is entered, the error message shows and the name cannot be registered.

- The name already registered
- Letters beginning with a number
- Letters including the signs below:
(,) , [,] , = , < , > , space, comma
- Letters beginning with “alphabets representing variables” + “number”



<Example> B0..., I0..., BP1..., LEX2...

Alphabets representing variables: B, I, D, R, S, P, BP, EX, PX, LB, LI LD, LR, LS, LP, LBP, LEX, LPX

When the name begins with “ ‘ ”, it is regarded as a comment and the same comment can be registered for two or more variables. In this case, although this function is valid, the number is displayed on the JOB CONTENT window instead of the name.

<Example> Registration of the byte type variable B001 as “WORKNUM”
 S2C396=0 : SET B001 10
 S2C396=1 : SET B001 10

8.3.0.38 S2C397: I/O VARIABLE CUSTOMIZE FUNCTION

This function enables registration of any particular input/output signal/variable. Reference and editing of signals/variables are possible on the same window.

Table 8-6: S2C397

Parameter Setting Value	Valid/Invalid
0	Function Invalid
1	Function Valid

With this function valid, the sub-menu {I/O-VARIABLE CUSTOMIZE} opens under the main menu {ARC WELDING}, {SPOT WELDING}, {GENERAL}, {HANDLING} (differs by application). Select {I/O-VARIABLE CUSTOMIZE}, and the I/O-VARIABLE CUSTOMIZE window appears as follows.

Fig. 8-6: I/O VARIABLE CUSTOMIZE Window

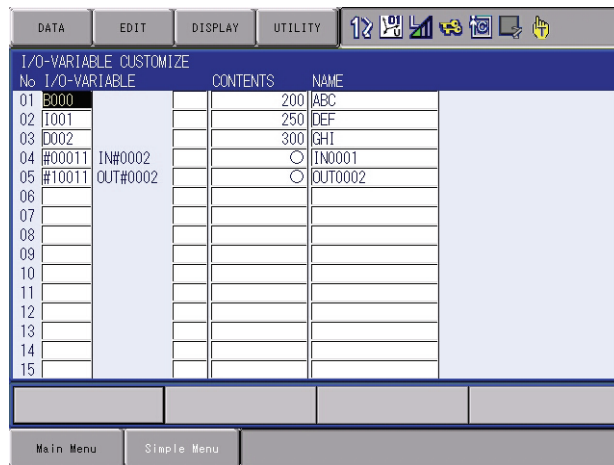

On the I/O-VARIABLE CUSTOMIZE window, any of the input/output signals/variables can be selected and registered (up to 32 items). Registrable signals/variables are as follows:

Table 8-7: Registrable Items on the I/O-VARIABLE CUSTOMIZE Window

Input/Output Signals	USER INPUT SIGNAL USER OUTPUT SIGNAL PSEUDO INPUT SIGNAL
Variables	BYTE TYPE VARIABLE (B VARIABLE) INTEGER TYPE VARIABLE (I VARIABLE) DOUBLE-PRECISION INTEGER TYPE VARIABLE (D VARIABLE)

The contents and names of the registered signals/variables can be checked and edited on this window. In addition, the data list of registered signals/variables can be loaded, saved, verified or deleted with an external memory unit. Only when this function is valid, "I/O-VARIABLE CUSTOMIZE (file name: USRIOVAR.DAT)" is displayed and can be selected. To display the "I/O-VARIABLE CUSTOMIZE (file name: USRIOVAR.DAT)", select {FD/CF} → {LOAD} {SAVE} {VERIFY} {DELETE} → {SYSTEM DATA}

DX100	8 Parameter 8.3 Mode Operation Setting Parameters
-------	---

8.3.0.39 S2C415 to S2C419: TIME RESET

These parameters specify whether resetting operation of the specified times is permitted or not.

- S2C415 : CONTROL POWER ON TIME
- S2C416 : SERVO POWER ON TIME
- S2C417 : PLAYBACK TIME
- S2C418 : WORK TIME
- S2C419 : WEAVING TIME

- 0 : Prohibit Resetting
- 1 : Permit Resetting

“PERMIT” is set as the initial value for the work time and motion time.

8.3.0.40 S2C431: TOOL NO. SWITCHING

This parameter specifies whether tool number switching is permitted or not.

- 0 : Prohibited (Only number “0” can be used.)
- 1 : Permitted (64 type of tools from number “0” to “63” can be used.)

8.3.0.41 S2C433: POSITION TEACHING BUZZER

This parameter specifies whether the buzzer sound at position teaching is used or not.

- 0 : With buzzer
- 1 : Without buzzer

8.3.0.42 S2C434: JOB LINKING DESIGNATION (When Twin Synchronous Function Used)

This parameter specifies whether the manipulator at the synchronizing side is to be linked when the manipulator and the station at the synchronized side are performing FWD/BWD or test run, by using the twin synchronous function.

- 0 : Not operating
- 1 : Linking

Fig. 8-7: 0 : Does not operate the synchronizing side while teaching the synchronized side.

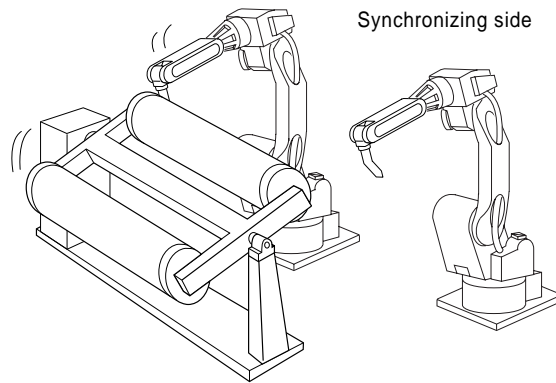
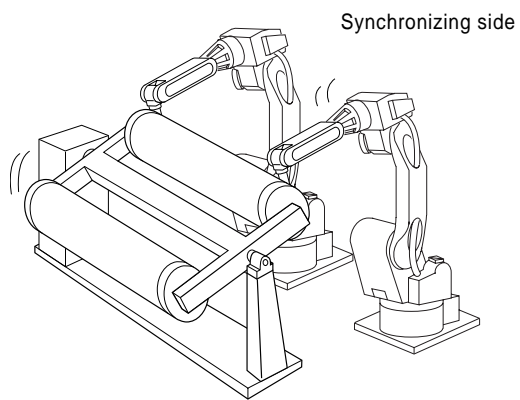

Fig. 8-8: 1 : Links the synchronizing side while teaching the synchronized side.



8.3.0.43 S2C437: PLAYBACK OPERATION CONTINUATION FUNCTION

This function is used to decide where to resume the playback on the start operation after suspending the playback and moving the cursor or selecting other jobs.

- 0: Starts operation where the cursor is located in the job displayed at the moment.
- 1: The playback continuation window appears. Select “YES” and the playback resumes where the cursor has been located when the playback suspended. If “NO” is selected, the playback resumes where the cursor is located in the job displayed at the moment.

Table 8-8: S2C437

Parameter Setting Value	Where the Playback Resumes
0	Resumes where the cursor is located in the job displayed at the moment.
1	Resumes where the cursor has been located when the playback suspended OR where the cursor is located in the job displayed at the moment. <Example> Suspended at step 0003 during the playback of job A ↓ Displays job B ↓ Starts operation ↓ On the playback operation continuation window <ul style="list-style-type: none"> • When “YES” selected, the playback resumes from step 0003 of job A • When “NO” selected, the playback resumes from the current position in job B

* When this function is valid (S2C437=1), a light blue cursor is displayed at the instruction section of step where the playback has been stopped. When “YES” is selected, the playback resumes where this cursor is located.

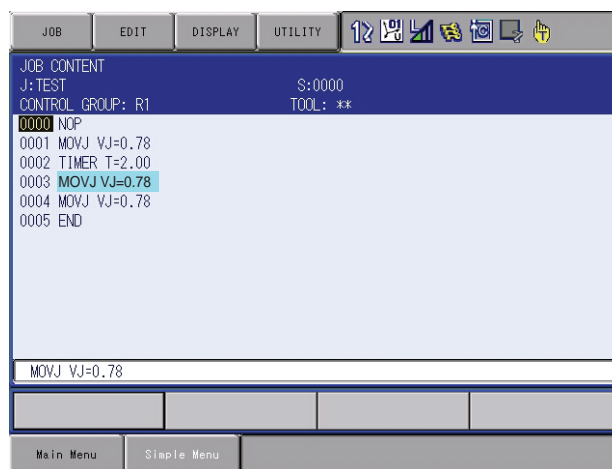

NOTE If a job has been edited or FWD/BWD/TEST RUN operation(s) have been executed, the playback cannot resume where it has suspended. Also this function is invalid if the reserved start function is set valid (S2C222=0).

DX100	8	Parameter
	8.4	Parameters according to Interference Area

8.4 Parameters according to Interference Area

These parameters limit the P-point maximum envelope of the manipulator or set the interference area for axis interference or cubic interference.

8.4.0.1 S1CxG400 to S1CxG415: PULSE SOFT LIMIT

Soft limit is set independently for each axis by pulse value setting. Set current value (pulse value) of the axis at the soft limit set up position.

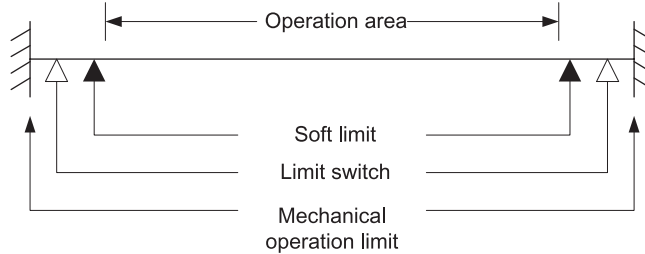

8.4.0.2 S2C001: CUBE SOFT LIMIT CHECK

This parameter specifies whether to check the cube soft limit. More than one soft limit can be specified.

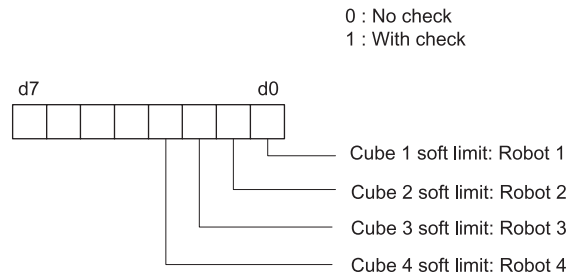

If “WITH CHECK” is selected, set up the following parameters.

Units: μm

Cube Soft Limit (Base Coordinates of Robot TCP)

- S3C000: Robot 1: + side: X
- S3C001: Robot 1: + side: Y
- S3C002: Robot 1: + side: Z
- S3C003: Robot 1: - side: X
- S3C004: Robot 1: - side: Y
- S3C005: Robot 1: - side: Z
- S3C006: Robot 2: + side: X

Soft Limit

Soft limit is a software-type function to limit the range of movement of the manipulator.

If the TCP reaches the soft limit during operation, the manipulator automatically stops and no longer moves in that same direction. An alarm occurs if this soft limit is exceeded during playback. This soft limit is classified into two types.

- Cube Soft Limit
Soft limit is set with the absolute value on the base coordinates.

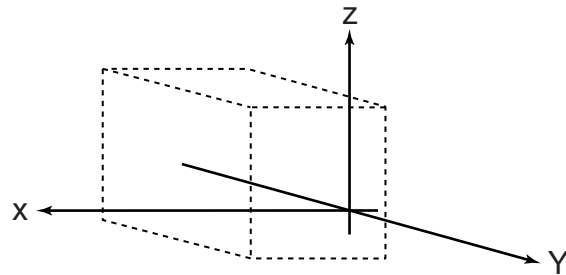

- Pulse Soft Limit (Independent Axis Soft Limit)
Refer to *chapter 8.4.0.1 "S1CxG400 to S1CxG415: PULSE SOFT LIMIT"* at page 8-28.

8.4.0.3 S2C002: S-AXIS INTERFERENCE CHECK

This parameter specifies whether to check for interference with each manipulator. If "WITH CHECK" is selected, set up the following parameters.

Units: Pulse

S3C048: S-axis Interference Area Robot 1 (+)

S3C049: S-axis Interference Area Robot 1 (-)

S3C050: S-axis Interference Area Robot 2 (+)

S3C051: S-axis Interference Area Robot 2 (-)

.

.

.

S3C055: S-axis Interference Area Robot 4 (+)

DX100	8	Parameter
	8.4	Parameters according to Interference Area

8.4.0.4 S2C003 to S2C066: CUBE/AXIS INTERFERENCE CHECK

1. Designation of checking

These parameters specify the cube/axis interference to be used by bit.

- 0 : Cube Interference/Axis Interference Not Used
- 1 : Robot 1
- 2 : Robot 2
-
- 8 : Robot 8
- 9 : Base Axis 1
- 10 : Base Axis 2
-
- 16 : Base Axis 8
- 17 : Station Axis 1
- 18 : Station Axis 2
-
- 40 : Station Axis 24

2. Checking method

Designates whether checking is performed by command or feedback.

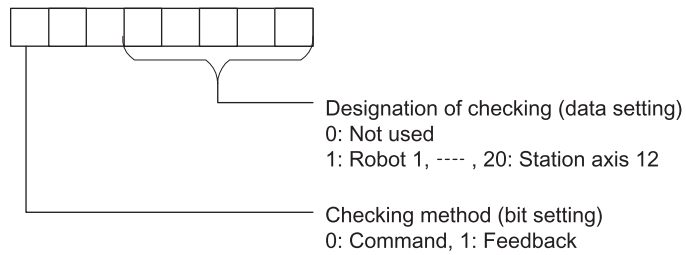

Checking method

The checking method differs according to ON/OFF status of servo power supply.



Checking Method Designation	Servo Power Supply ON	Servo Power Supply OFF
Command	Command	Feedback
Feedback	Feedback	Feedback

During the servo float function operation, checking is performed by feedback regardless of the checking method designation.

Interference Area

It is possible to output whether the TCP during operation is inside or outside as a status signal, and to set the area to control the position by parameters S2C003 to S2C194. When the manipulator attempts to enter this area, the corresponding input signal (e.g. an "entrance prohibit signal") is detected. The manipulator stops immediately if there is an input signal and goes into waiting status until this signal is cleared. This signal is processed in the I/O section. Three methods of interference area settings are prepared for manipulators and stations. For a system with one manipulator, use robot 1.

- S-axis Interference Area

Position is controlled by the pulse value of the S-axis.

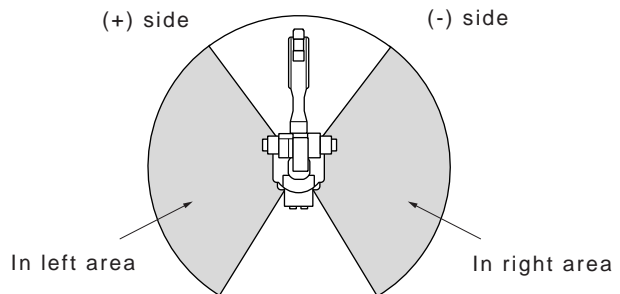

- Cubic Interference Area

Up to 64 cubic areas can be set. The edges of the cubes are set parallel to the robot coordinates or the user coordinates.

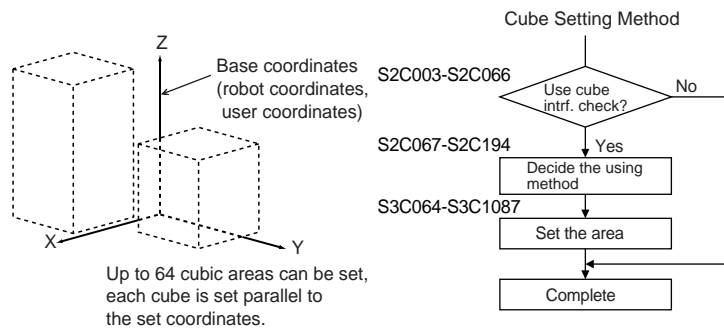

- Axis Interference Area

Up to 64 areas can be set. Each operation area maximum and minimum value are set for the robot, base axis, and station axis plus and minus side.

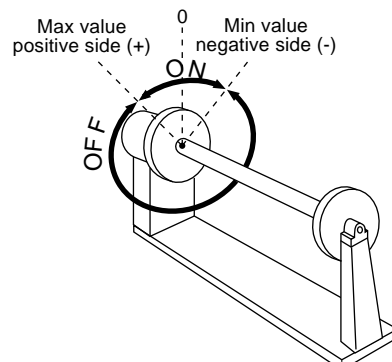

DX100	8	Parameter
	8.4	Parameters according to Interference Area

8.4.0.5 S2C067 to S2C194: CUBE USING METHOD

These parameters specify the coordinates for defining the cube. If the user coordinates are selected, also specify the user coordinate system numbers. Set cubic area referring to the cubic interference areas shown below.

Coordinate specification

- 0 : Pulse (axis interference)
- 1 : Base coordinates
- 2 : Robot coordinates
- 3 : User coordinates

Coordinate No.: Specify the user coordinate number when selecting "3: User Coordinates."

Units: 1µm

Precaution When Setting the Interference Area

It will be necessary to consider the following when setting the cubic interference and S-axis interference areas. The manipulator is processed to decelerate to stop from the point where it enters in the area. Therefore, set the areas in consideration of the amount of the manipulator movement in the deceleration section shown in the figure below.

SUPPLEMENT

The move amount in the speed reduction section is dependent on the moving speed of the manipulator at that time:

$V = 1500\text{mm/s} \rightarrow$ approx. 300mm (Max.)

$V = 1000\text{mm/s} \rightarrow$ approx. 160mm

$V = 30\text{mm/s} \rightarrow$ approx. 3 to 4 mm

$V = 20\text{mm/s} \rightarrow$ approx. 2mm

Interference Prevention in Interference Area

Processing to prevent interference is executed in the I/O processing section. The relation between the DX100 I/O signal and manipulator operation is shown below.

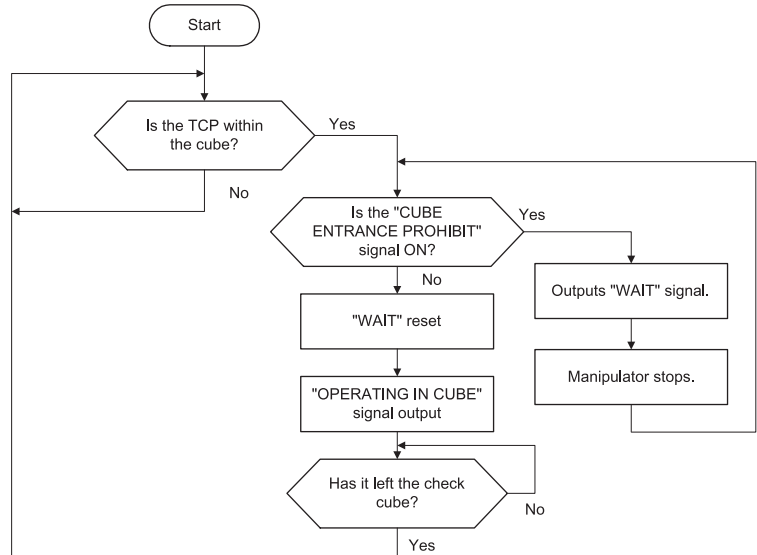

In wait status with the entrance prohibit signal, the manipulator just barely enters the area for speed reduction processing and then stops.

Fig. 8-9: Connection Example Where Two Manipulators are Operated in the Same Area

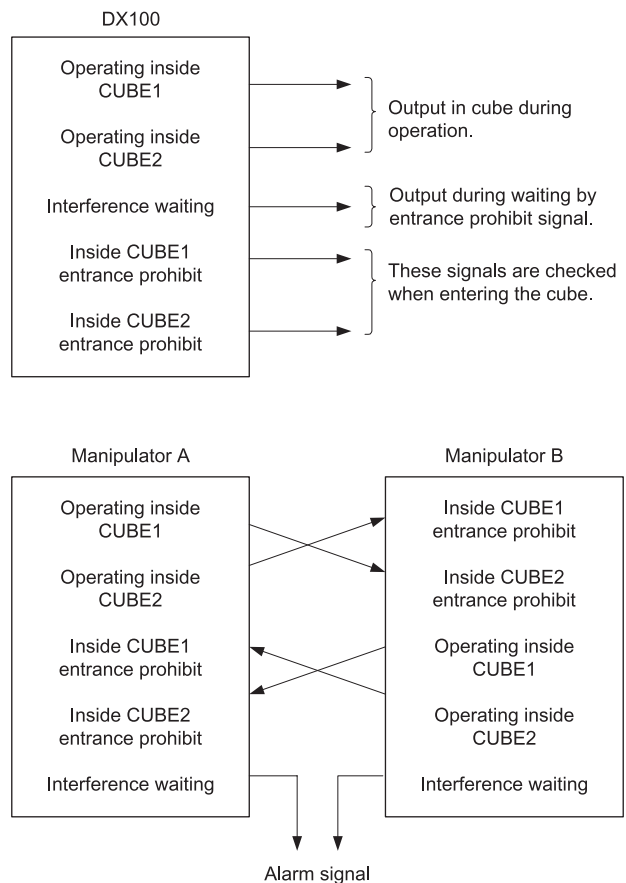

	8	Parameter
DX100	8.4	Parameters according to Interference Area

8.4.0.6 S3C000 to S3C047: CUBE SOFT LIMIT

These parameters specify auxiliary functions of S2C001 parameter. For details, see *chapter 8.4.0.2 "S2C001: CUBE SOFT LIMIT CHECK" at page 8-28.*

8.4.0.7 S3C048 to S3C063: S-AXIS INTERFERENCE AREA

These parameters specify auxiliary functions of S2C002 parameter. For details, see *chapter 8.4.0.3 "S2C002: S-AXIS INTERFERENCE CHECK" at page 8-29.*

8.4.0.8 S3C064 to S3C1087: CUBIC INTERFERENCE AREA

These parameters specify auxiliary functions of S2C003 to S2C066 parameters. For details, see *chapter 8.4.0.4 "S2C003 to S2C066: CUBE/AXIS INTERFERENCE CHECK" at page 8-30.*

8.4.0.9 S3C1089 to S3C1096: ROBOT INTERFERENCE AREA

These parameters specify auxiliary functions of S2C236 to S2C263 parameters. For details, see *chapter 8.4.0.6 "S3C000 to S3C047: CUBE SOFT LIMIT" at page 8-34.*

8.4.0.10 S3C1097: A SIDE LENGTH OF WORK-HOME-POSITION CUBE

Units: 1 μ m

This parameter specifies a side length of the cube for the work home position.

8.5 Parameters according to Status I/O

These parameters set the parity check or I/O setting for user input/output signals.

8.5.0.1 S2C235: USER OUTPUT RELAY WHEN CONTROL POWER IS ON

This parameter specifies the state of the user output relays when the control power is turned ON. Since the power OFF state, including peripheral devices, cannot be completely reproduced, take note when restarting.

- 0 : Reset to the power OFF state
- 1 : Initialized (all user relays OFF)

8.5.0.2 S4C000 to S4C015: PARITY OF USER INPUT GROUPS

These parameters specify whether to execute priority checks with parameters when instructions covering the input group (1G#) are executed. The instructions covering the input groups are as shown below.

- IF Sentence (JUMP, CALL, RET, PAUSE)
- Pattern Jump, Pattern Job Call
- DIN
- WAIT

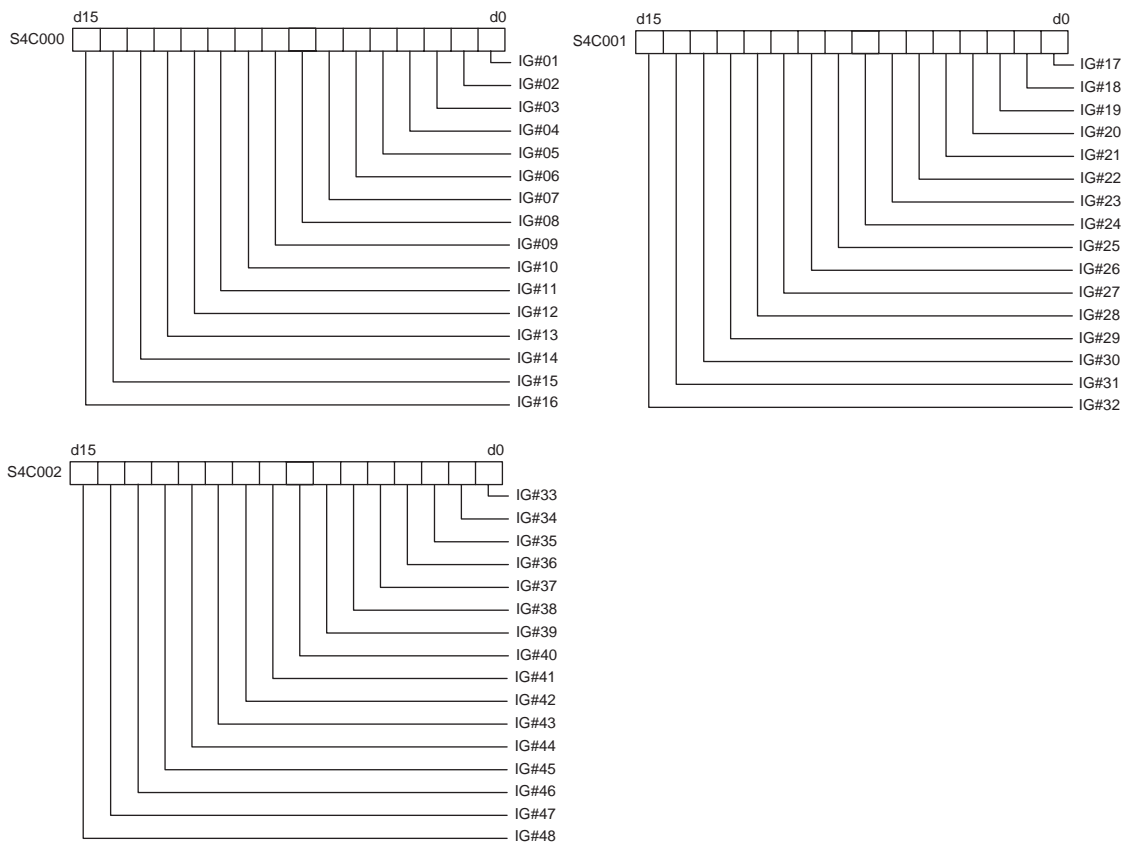

Parity bits are set as the highest level bits of each input group and are written in even parity. If an error is detected during parity check, an alarm occurs and the manipulator stops. Remains unchanged if no parity check is specified.

8.5.0.3 S4C016 to S4C031: PARITY OF USER OUTPUT GROUPS

These parameters specify whether the output group instruction is executed with parity check (even parity).

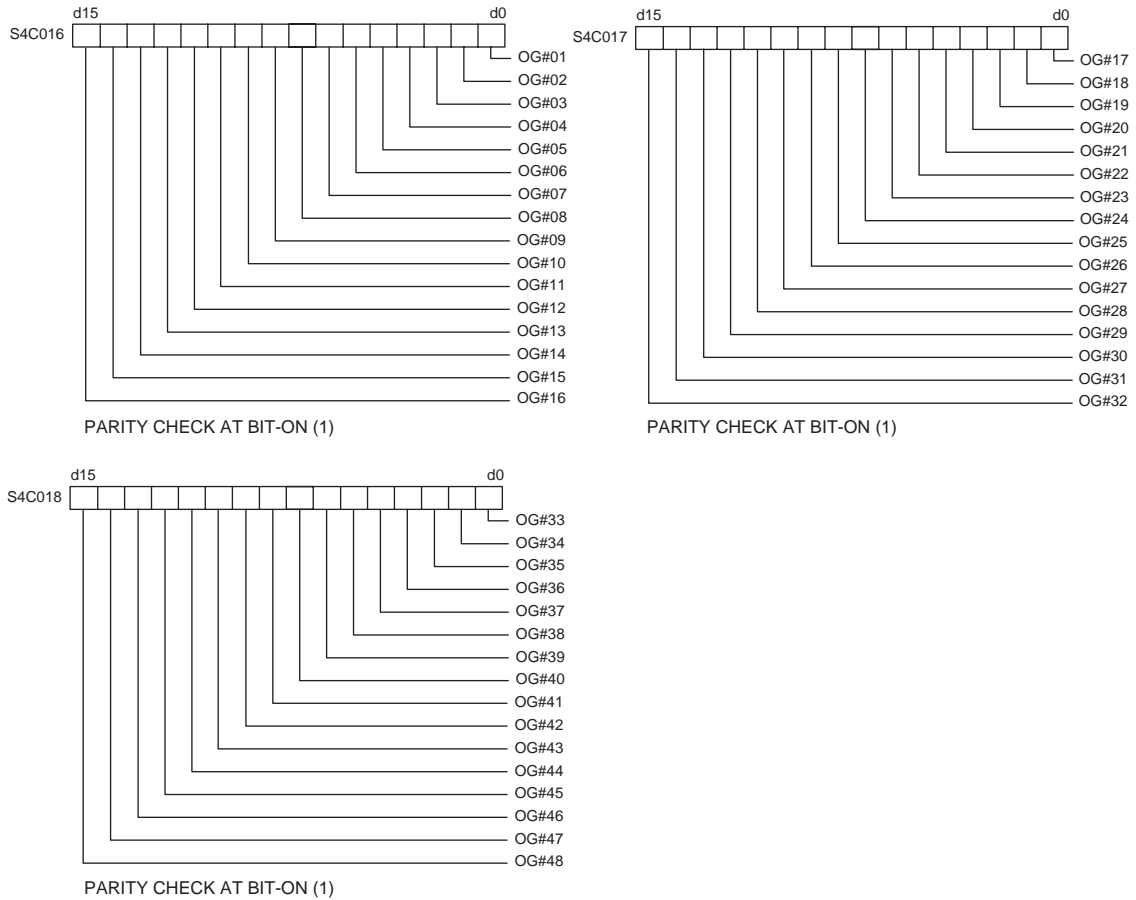

Parity bits are set as the highest level bits of each output group. For example, if OG#01 is specified with parity and DOUT OG# (1) 2 is executed, the result will be 00000010 if 2 is binary converted. Since there will be only one bit (odd) ON at this time, the parity bit (highest level bit) will be set to ON and 10000010 (130) will be output to OG# (1).

As in the case of a variable such as DOUT OG# (1) B003 parity bits are added to the contents of the variable data. However, if the contents of the variable exceed 127, as in the case of DOUT OG# (1) 128, an alarm will occur. Remains unchanged if no parity check is specified.

8.5.0.4 S4C032 to S4C047: DATA OF USER INPUT GROUPS

These parameters specify whether to handle the input group data as binary data or as BCD data when an instruction for the input group (1G#) is executed. The instructions covering the input groups are as shown below.

- IF Sentence (JUMP, CALL, RET, PAUSE)
- Pattern Jump, Pattern Job Call
- DIN
- WAIT

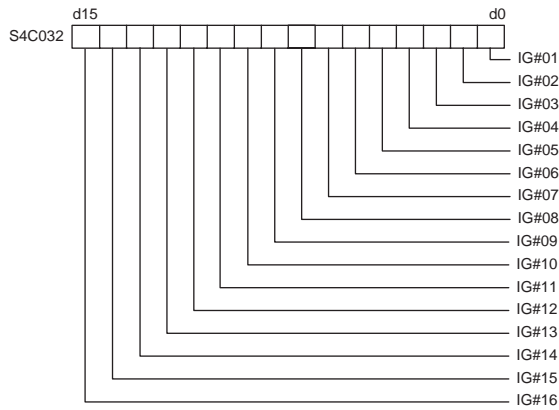

BCD DATA SPECIFICATION AT BIT-ON (1)

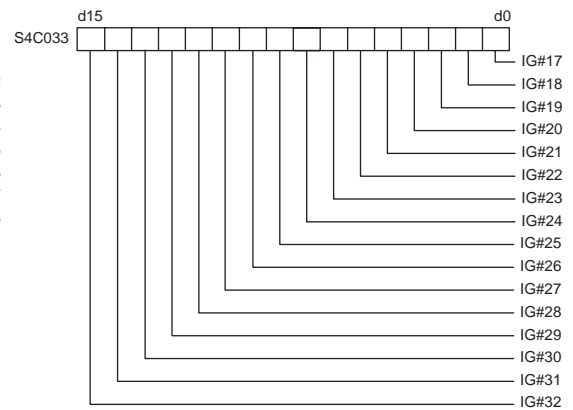

BCD DATA SPECIFICATION AT BIT-ON (1)

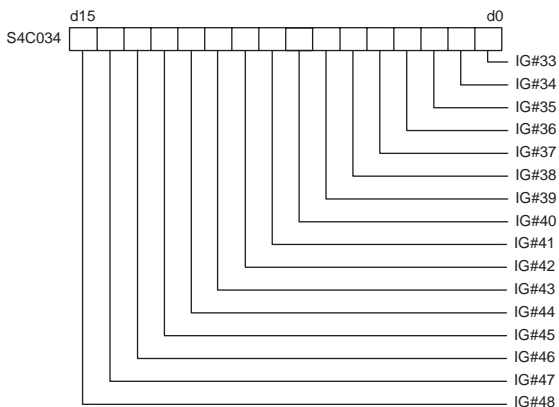

BCD DATA SPECIFICATION AT BIT-ON (1)

8.5.0.5 S4C048 to S4C063: DATA OF USER OUTPUT GROUPS

These parameters specify whether the output group instruction is executed with binary data or BCD data.

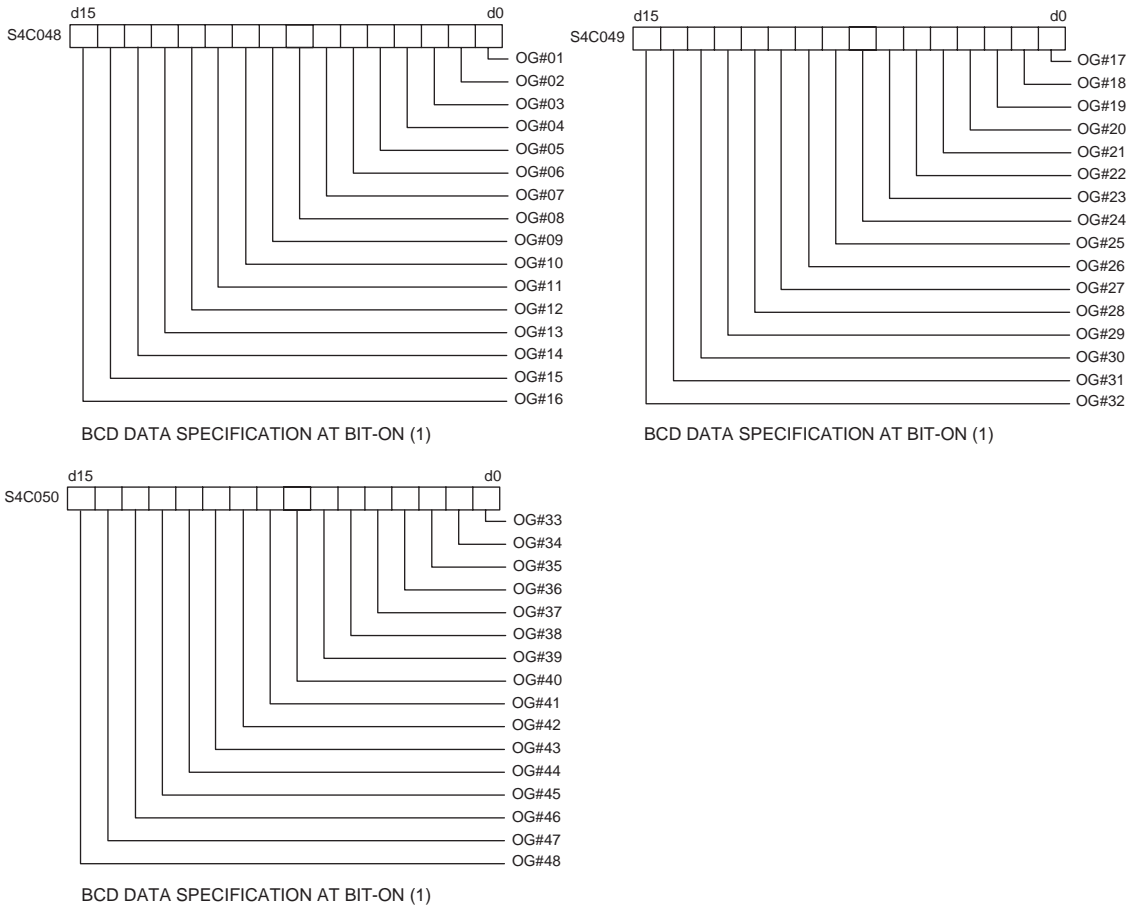

Differences Between Binary Data and BCD Data

For the input group and output group, the result will depend on whether the binary or BCD formula is used.

<Example> When the input function is [01010101]

USER INPUT GROUP IG#01	
IN#0001	#10010
IN#0002	#10011
IN#0003	#10012
IN#0004	#10013
IN#0005	#10014
IN#0006	#10015
IN#0007	#10016
IN#0008	#10017

→

State	Binary	Case	BCD	Case
1	2 ⁰ = 1	1	2 ⁰ = 1	1
0	2 ¹ = 2	0	2 ¹ = 2	0
1	2 ² = 4	4	2 ² = 4	4
0	2 ³ = 8	0	2 ³ = 8	0
1	2 ⁴ = 16	16	2 ⁰ = 1	1
0	2 ⁵ = 32	0	2 ¹ = 2	0
1	2 ⁶ = 64	64	2 ² = 4	4
0	2 ⁷ = 128	0	2 ³ = 8	0
		85		
		Binary data value	BCD data value	

However, in the case of BCD data, because the upper bound value is 99, it is not possible to use any value which exceeds nine in the one or ten digit place.

8.5.0.6 S4C064 to S4C079: USER OUTPUT GROUP TO BE INITIALIZED AT SWITCHING MODE

Set the user output group with bit to be initialized at switching mode. Use these parameters when using user output signals as work instructions for peripheral devices.

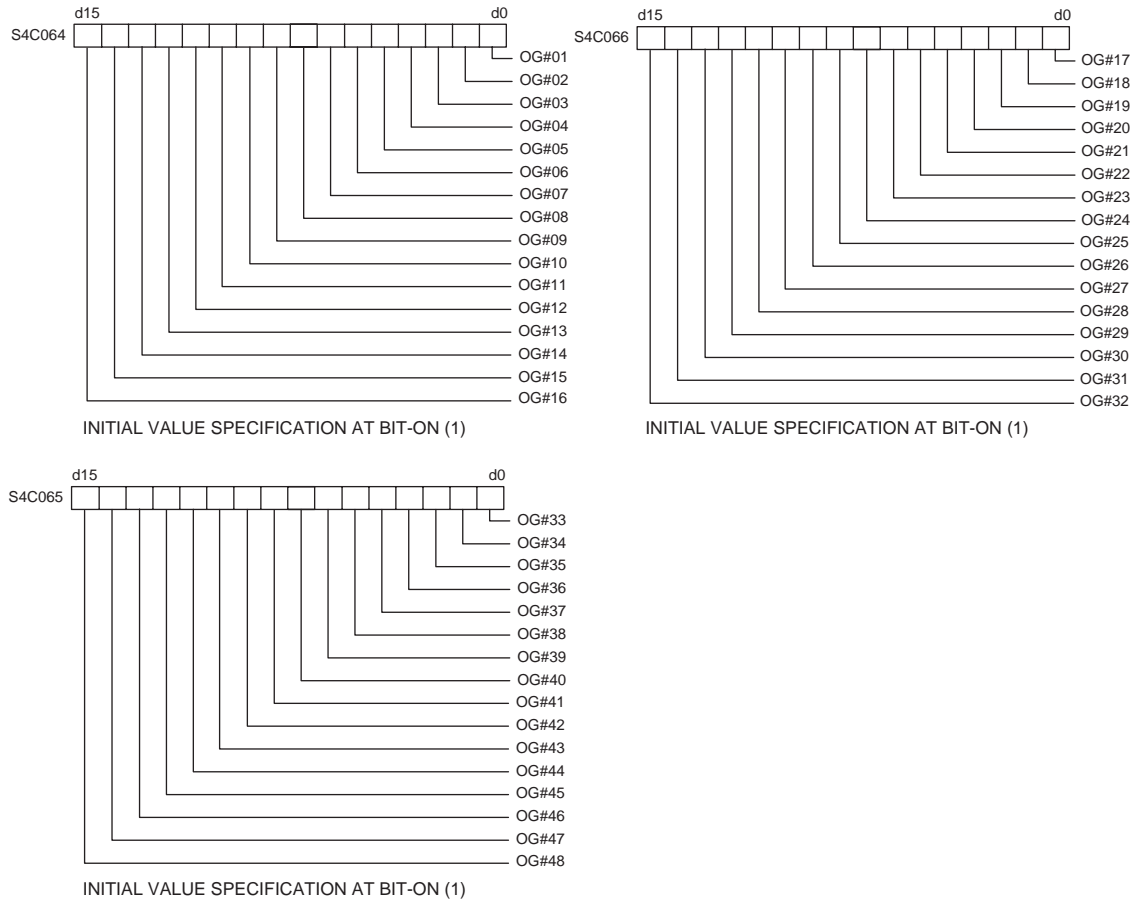

8.5.0.7 S4C240: USER OUTPUT NO. WHEN MANIPULATOR DROP ALLOWABLE RANGE ERROR OCCURS

This parameter specifies the user output number to output the manipulator drop allowable range error alarm occurrence externally.

When this function is not used, set "0."

DX100	8	Parameter
	8.6	Parameters according to Coordinated or Synchronized Operation

8.6 Parameters according to Coordinated or Synchronized Operation

These parameters make the settings for coordinated or synchronized operations between manipulators or between manipulators and stations.

8.6.0.1 S2C212: +MOV or +SMOV INSTRUCTION SPEED INPUT

This parameter specifies whether the speed inputting for move instructions of the master robot in a coordinated job is permitted or not.

<Example> 0: Not Provided

SMOVL V=100

+MOVL

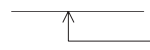

← Master side
Speed specification not provided

<Example> 1: Provided

SMOVL V=100

+MOVL V=100

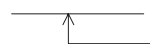

← Master side
Speed specification provided

8.6.0.2 S2C213: +MOV INSTRUCTION INTERPOLATION INPUT

This parameter specifies which interpolation is permitted for move instructions for the master robot in a coordinated job. More than one instruction can be specified.

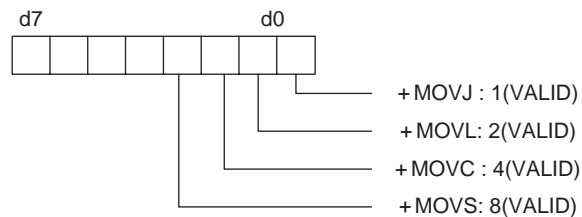

8.6.0.3 S2C231: OPERATION METHOD AT FWD/BWD OPERATION OR TEST RUN BY INDEPENDENT CONTROL

This parameter specifies the operation method at FWD/BWD operation or test run by independent control.

0 : The job of the task that is currently displayed operates.

1 : Jobs of all the tasks operate.

① When master task is currently displayed:

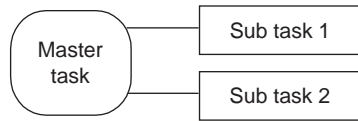

 : Not operating

 : Operating

② When sub task 1 is currently displayed:

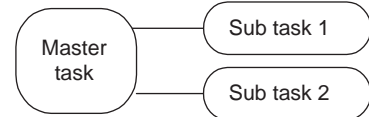
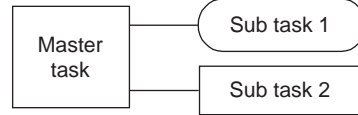

③ When sub task 2 is currently displayed:

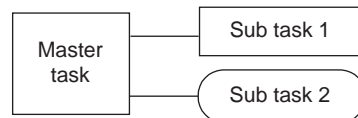

0: One of the task jobs that are currently displayed operates.

1: All task jobs operate.

8.6.0.4 S2C232: JOB AT CALLING MASTER OF SUBTASK 1, 2, 3, 4, 5, 6, 7 BY INDEPENDENT CONTROL

This parameter specifies the job which is called up when the master of the subtask is called up by independent control.

0 : Master job

1 : Root job

Master Job: Job registered in the master control window

Root Job: Job activated by PSTART instruction

8.6.0.5 S2C264: STATION AXIS CURRENT VALUE DISPLAY FUNCTION

This parameter specifies whether the function to display the current value of the station axis in the following units is valid/invalid.

0 : Invalid

1 : Valid

Rotary axis : Angle (deg)

Servo track : Distance (mm)

Regarding whether to specify the rotary axis or the servo track, refer to *chapter 8.6.0.6 "S2C265 to S2C288: STATION AXIS DISPLAYED UNIT"*.

8.6.0.6 S2C265 to S2C288: STATION AXIS DISPLAYED UNIT

This parameter specifies the station axis displayed unit (bit specification).

0 : Display angle (deg)

1 : Display in distance (mm)

■ **Setting Method**

Set a numerical value (decimal) where the bit of the axis to be displayed in the units of distance becomes 1.

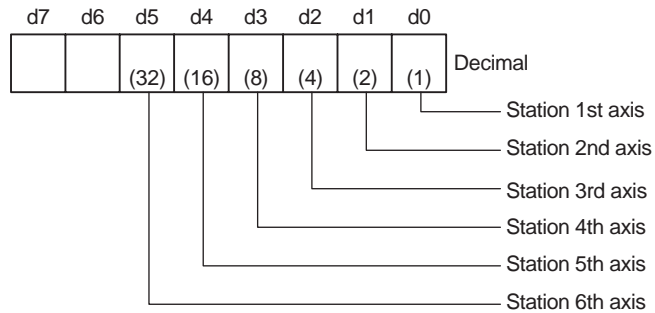

<Example> When 1st and 3rd axes of station 1 are displayed in the units of distance:

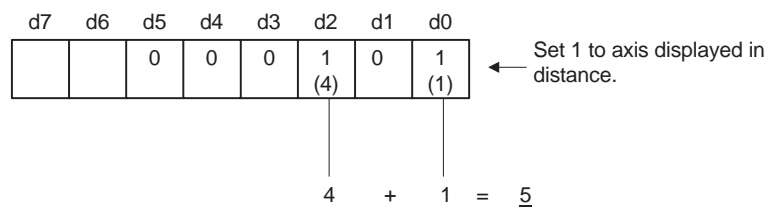

Therefore, set parameter S2C265 of station 1 to 5.

8.6.0.7 S2C420: POSTURE CONTROL OF SYNCHRONIZED MANIPULATOR (When Twin Synchronous Function Used)

This parameter specifies the posture control method for synchronized manipulator performing compensation during playback by using the twin synchronous function.

- 0 : Change posture according to station movement
- 1 : Fixed in relation to the ground

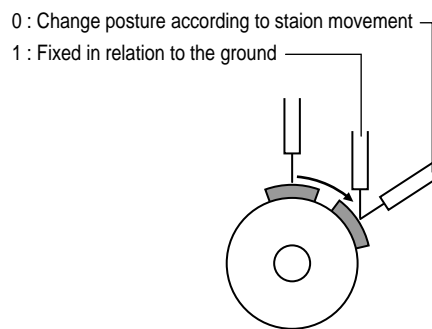

8.6.0.8 S2C421: POSTURE CONTROL OF MANIPULATOR IN MULTI-JOB (When Twin Synchronous Function Used)

This parameter specifies the posture control method for manipulator executing compensation at the linking side when job linking is performed during FWD/BWD operation by the twin synchronous function.

- 0 : Change posture according to station movement
- 1 : Fixed in relation to the ground

8.6.0.9 S2C687: OPERATION OF JOB WITHOUT CONTROL GROUP SPECIFICATION

When the servo power supply is individually turned OFF where jobs in multiple number of tasks are operated using the independent control function, the job execution of the control group whose servo power supply is turned OFF is interrupted. The jobs of other control groups continue their execution.

For the jobs without control group specification such as master job, the conditions for execution can be set by the parameter.

- 0 : Execution possible only when servo power supply to all the axes have been turned ON.
- 1 : Execution possible when servo power supply to any axis is turned ON.

8.6.0.10 S2C688: EXECUTION OF "BWD" OPERATION

This parameter prohibits step-back operation of a job without a step.

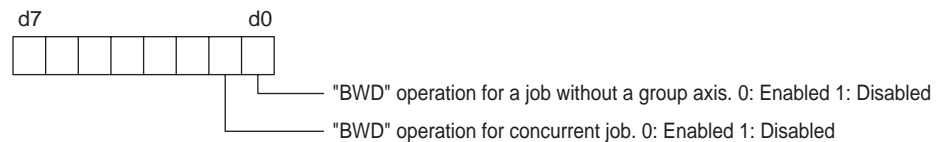

8.6.0.11 S3C1101: MAXIMUM DEVIATION ANGLE OF CURRENT STATION POSITION (When Twin Synchronous Function Used)

Used when the twin synchronous function is used. This parameter specifies the maximum deviation between the teaching position and the current station position.

- 0 : No deviation check
- Other than 0 : Deviation angle (units : 0.1°)

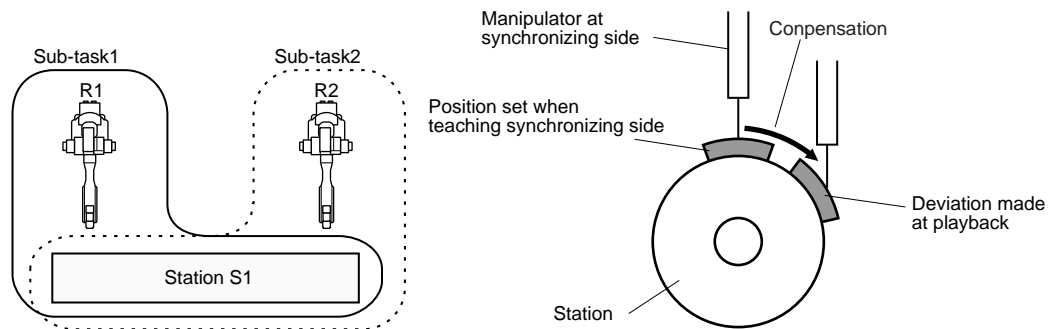

In the above figure on the left, the follower R2 executes the job of subtask 2 in synchronization with the motion of the station axis which is moved by the R1 job. In this procedure, the job of subtask 2 controls only the R2 robot axis.

If the teaching position of the station in the subtask 2 differs from the station current position (controlled by the subtask 1 job), the difference is automatically offset so that R2 keeps the taught position in relation to the station.

Difference between the taught and the station current positions is always monitored. If the difference exceeds a set value of the parameter, the message "PULSE LIMIT (TWIN COORDINATED)" appears.

DX100	8	Parameter
	8.7	Parameters for Other Functions or Applications

8.7 Parameters for Other Functions or Applications

These parameters make the settings for other functions or applications.

8.7.0.1 S1CxG049 to S1CxG051: SMALL CIRCLE CUTTING

These parameters prescribe cutting operation at small circle cutting.

- S1CxG049 (Minimum diameter) : Set the minimum diameter of a figure in the units of μm that can be processed by small-circle cutting machine.
- S1CxG050 (Maximum diameter) : Set the maximum diameter of a figure in the units of μm that can be processed by small-circle cutting machine.
- S1CxG051 (Maximum speed) : Set the maximum cutting speed at operation by CUT instruction in the units of 0.1mm/s.

8.7.0.2 S1CxG052 to S1CxG053: SMALL CIRCLE CUTTING DIRECTION LIMIT VALUE

These parameters set the cutting direction limits at small circle cutting.

- S1CxG052 (+ direction) : Set the limit value in the positive direction of cutting angle DIR set by CUT instruction, in the units of 0.01° .
- S1CxG053 (- direction) : Set the limit value in the negative direction of cutting angle DIR set by CUT instruction, in the units of 0.01° .

8.7.0.3 S1CxG054 to S1CxG055: SMALL CIRCLE CUTTING OVERLAP VALUE

These parameters set the overlapped value at small circle cutting.

- S1CxG054 (Operation radius) : Set the operation radius at inner rotation in the units of 1 μm after overlapping by CUT instruction.
- S1CxG055 (Rotation angle) : Set the rotation angle at inner rotation in the units of 0.1° after overlapping by CUT instruction.

8.7.0.4 S1CxG063, S1CxG064: PATTERN CUTTING DIMENSION

These parameters set the minimum diameter (S1CxG063) and the maximum diameter (S1CxG064) for the pattern cutting in units of μm .

8.7.0.5 S1CxG065: MIRROR SHIFT SIGN INVERSION

This parameter sets which axis to be shifted (mirror-shift: invert the sign).

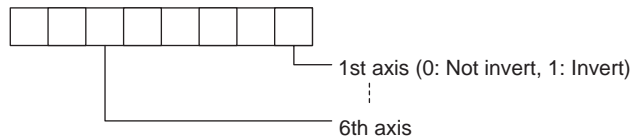

8.7.0.6 S2C430: RELATIVE JOB OPERATION METHOD

This parameter specifies how to operate a relative job. A method to convert a relative job into a standard job (pulse), and a conversion method to calculate the aimed position (pulse position) when a relative job is operated can be specified.

- 0 : Previous step with priority (B-axis moving distance minimized.)
- 1 : Form with priority
- 2 : Previous step with priority (R-axis moving distance minimized.)

	8	Parameter
DX100	8.7	Parameters for Other Functions or Applications

8.7.0.7 S3C1111 to S3C1190: ANALOG OUTPUT FILTER CONSTANT (When analog output corresponding to speed function is used)

By setting a constant to filter, a filter processing can be performed for the output analog signal.

8.7.0.8 S3C1191: CUT WIDTH CORRECTION VALUE (When form cutting function is used)

This parameter specifies the path correction value for pattern cutting operation. A value 1/2 of the cut width is set in units of μm .

8.8 Hardware Control Parameters

These parameters make the hardware settings for fan alarm or relay operation, etc.

8.8.0.1 S2C646: ANTICIPATOR FUNCTION

This parameter specifies anticipation output.

- 0 : Invalid
- 1 : Valid

The anticipator function is a function to quicken or slow the ON/OFF timing of four user output signals and two user output groups. Using this function, signal output can be carried out before or after the step is reached. As a result, timing deviation due to delayed motion of peripheral devices and robot motion can be adjusted.

Setting the time to a negative value (-) advances the signal output.

This setting is effective when adjusting timing deviation due to delayed motion of peripheral devices.

Setting the time to a positive value (+) delays the signal output.

This setting is effective when adjusting timing deviation due to delayed robot motion.

<Advanced Signal Output>

Signal output is carried out before the step is reached.

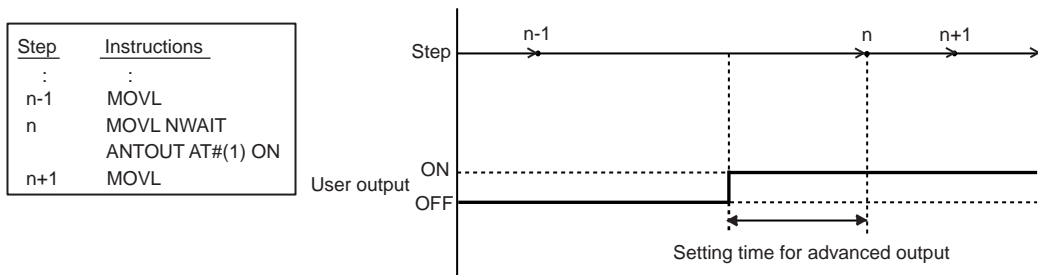

<Delayed Signal Output>

Signal output is carried out after the step is reached.

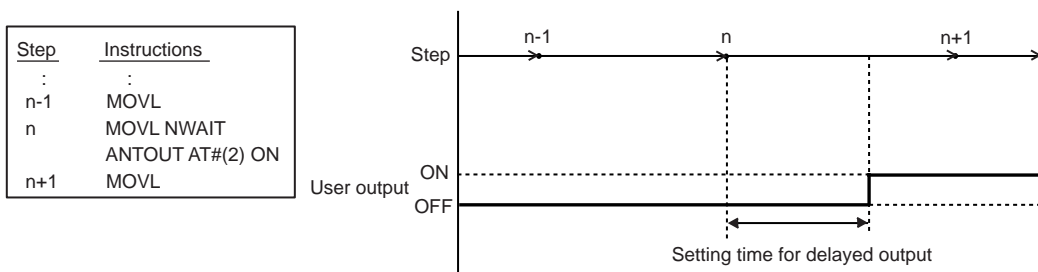

DX100	8	Parameter
	8.8	Hardware Control Parameters

8.8.0.2 S2C786 to S2C788: COOLING FAN ALARM DETECTION

This parameter specifies a detection for cooling fan 1 to 3 with alarm sensor, connected to power ON unit.

- 0 : No detection
- 1 : Detected with message display
- 2 : Detected with message and alarm display

8.8.0.3 S4C327 to S4C390: SETTING OF OPERATING RELAY NO.

Up to 64 output signals can be turned ON/OFF with the programming pendant. The object relay No. is set in these parameters. Although it is possible to set optional values for output No. 1 to 1024 in the parameters, the following must be taken into consideration.

- Avoid setting duplicate numbers.
- The signal turned ON or OFF with the programming pendant is operated again or remains unchanged until the instruction is executed.

8.8.0.4 S4C391 to S4C454: OPERATING METHOD OF RELAYS

These parameters specify the operating method of output signals by the programming pendant. The operating method can be specified for each output signal.

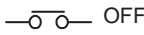
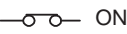
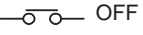
Parameter Setting Value	Operation of Output Signal
0	<div style="display: flex; align-items: center;"> <div style="border: 1px solid black; padding: 2px; margin-right: 10px;">+ON</div>  </div> <div style="display: flex; align-items: center; margin-top: 5px;"> <div style="border: 1px solid black; padding: 2px; margin-right: 10px;">-OFF</div>  </div>
1	<div style="display: flex; align-items: center;"> <div style="border: 1px solid black; padding: 2px; margin-right: 10px;">+ON</div> <div style="margin-right: 20px;"> ON/OFF with the key ON while the key is pressed </div>  </div> <div style="display: flex; align-items: center; margin-top: 5px;"> <div style="margin-right: 20px;"> OFF if the key is not pressed </div>  </div>

DX100	8	Parameter
	8.8	Hardware Control Parameters

8.8.0.5 S2C789 to S2C792: COOLING FAN ALARM 1 OPERATION

8.8.0.6 S2C793 to S2C796: COOLING FAN ALARM 2 OPERATION

8.8.0.7 S2C797 to S2C800: COOLING FAN ALARM 3 OPERATION

These parameters specify the operation of cooling fan 1 to 3 with alarm sensor, connected to power ON unit.

Each bit specifies the power ON unit to which the detecting sensor is connected.

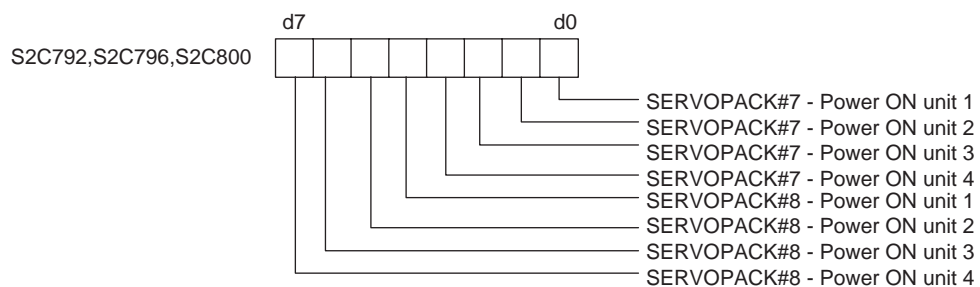
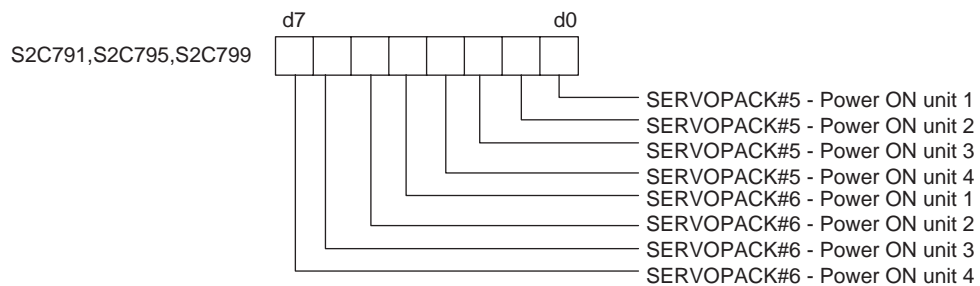
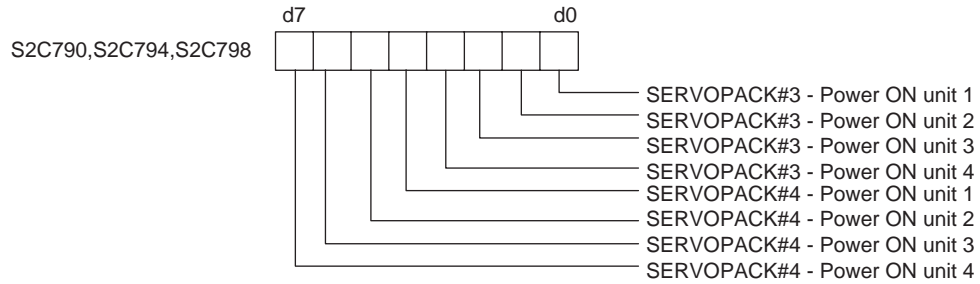
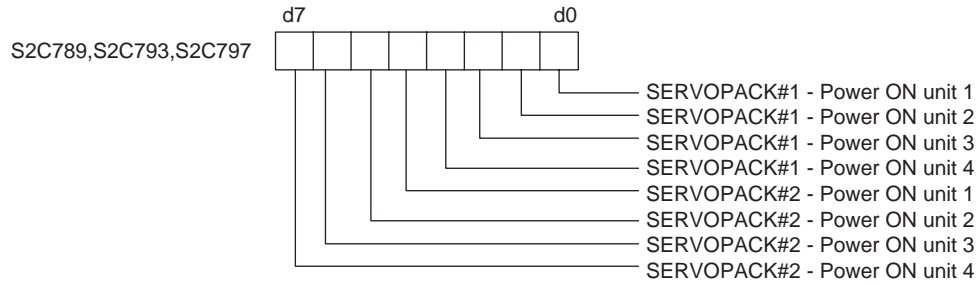

8.8.0.8 S2C801 to S2C804: FAN ALARM 1 POWER SOURCE STATUS

8.8.0.9 S2C805 to S2C808: FAN ALARM 2 POWER SOURCE STATUS

8.8.0.10 S2C809 to S2C812: FAN ALARM 3 POWER SOURCE STATUS

DX100	8 Parameter
	8.9 TRANSMISSION PARAMETERS

8.9 TRANSMISSION PARAMETERS

These parameters are used when the optional FC1, FC2, or data transmission function is used.

For details, refer to the optional manual “DX100 DATA TRANSMISSION FUNCTION.”

8.10 Application Parameters

8.10.1 Arc Welding

8.10.1.1 AxP000: APPLICATION

This parameter specifies the application. Set “0” for arc welding.

8.10.1.2 AxP003: WELDING ASSIGNMENT OF WELDING START CONDITION FILE

This parameter specifies the beginning condition number in the welding start condition file to be assigned to Power Source 2. Condition files of a lower number are automatically assigned to Power Source 1. For a system with one Power Source, set “49” (maximum value).

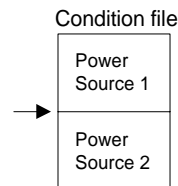

8.10.1.3 AxP004: WELDING ASSIGNMENT OF WELDING END CONDITION FILES

This parameter specifies the beginning condition number in the welding END condition file to be assigned to Power Source 2. Condition files of a lower number are automatically assigned to Power Source 1. For a system with one Power Source, set “13” (maximum value).

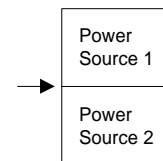

8.10.1.4 AxP005: WELDING SPEED PRIORITY

This parameter specifies whether the welding speed is specified by the “ARCON” instruction, by the welding start condition file, or by the additional times of the “MOV” instruction.

8.10.1.5 AxP009: WORK CONTINUING

This parameter specifies whether to output an “ARCON” instruction to restart after the manipulator stopped while the “ARCON” instruction is being output.

	8	Parameter
DX100	8.10	Application Parameters

8.10.1.6 AxP010: WELDING INSTRUCTION OUTPUT

This parameter specifies the beginning number (0 to 12) of the analog output channel to the Power Source. "0" indicates that no Power Source exists.

8.10.1.7 AxP011, AxP012: MANUAL WIRE OPERATION SPEED

These parameters specify the manual wire operation speed as a percentage of the maximum instruction value. Instruction polarity is determined by the current instruction in the Power Source characteristic file. The setting range is from 0 to 100.

8.10.1.8 AxP013, AxP014: WELDING CONTROL TIME

These parameters specify the welding control time in units of minutes. The setting range is from 0 to 999.

8.10.1.9 AxP015 to AxP017: NUMBER OF WELDING CONTROL

These parameters specify the number of welding controls. The setting range is from 0 to 99.

8.10.1.10 AxP026 to AxP029: TOOL ON/OFF USER OUTPUT NO. (Jigless system)

These parameters specify the user output number for the tool open/close operation by specific keys.

8.10.2 Handling Application

8.10.2.1 AxP002, AxP004: f1 KEY FUNCTION

These parameters set the output signal to assign for f1 key.

0: Not specified

1 to 4: Specific outputs for HAND-1 to HAND4-1

5: User output (No. is specified by AxP004).

8.10.2.2 AxP003, AxP005: f2 KEY FUNCTION

These parameters set the output signal to assign for f2 key.

0: Not specified

1 to 4: Specific outputs for HAND-2 to HAND4-2

5: User output (No. is specified by AxP005)

8.10.3 Spot Welding

8.10.3.1 AxP003: MAXIMUM NUMBER OF CONNECTED POWER SOURCES

This parameter specifies the maximum number of power sources which are to be used. The value is automatically set at start-up. No modification is needed.

DX100	8	Parameter
	8.10	Application Parameters

8.10.3.2 AXP004: GUN FULL OPEN STROKE ON/OFF SIGNAL

This parameter specifies which stroke switching signal is output ON or OFF to make the gun fully-opened for each gun.

Bit specification (1 for 01) for 8 guns. The initial setting is "0."

```

0 0 0 0 0 0 0 0
| | | | | | | |
8 7 6 5 4 3 2 1   Gun number

```

8.10.3.3 AXP005: STROKE CHANGE ANSWER TIME LIMIT

When using the X2 gear mechanical stopper gun and switching gun stroke, this parameter sets the time from the stroke-switching-sequence start until the pressure instruction end.

The initial setting is "0," with which the switching signal is output for the "stopper-type stroke switching time" set in the file, and then the gun pressure instruction is turned OFF.

8.10.3.4 AXP006: PARITY SPECIFICATION FOR WELDING CONDITIONS

When adding the parity signal to the welding condition signal with the Power Source connected to each welding gun, this parameter specifies odd or even parity.

Bit specification for 4 Power Sources. (0 : odd number, 1 : even number)
The initial setting is "0."

```

0 0 0 0 0 0 0 0
| | | |
4 3 2 1   Power Source number

```

8.10.3.5 AXP007: ANTICIPATE TIME

When executing the GUNCL or SPOT instruction with NWAIT specified in the previous move instruction but the time is not specified by ATT in the GUNCL or SPOT instruction, this parameter specifies the anticipate condition (time). The initial setting is "0," with which the each instruction is executed as soon as the taught position of the previous move instruction is reached, as normal operation.

8.10.3.6 AXP015: WELDING ERROR RESET OUTPUT TIME

This parameter sets the output time of the welding error reset signal to the Power Source when the alarm reset signal is input.

If the setting is "0," the welding error reset signal is not output to the Power Source even if the alarm reset signal is input.

8.10.3.7 AXP016, AXP017: ELECTRODE WEAR AMOUNT ALARM VALUE

These parameters set the electrode wear amount alarm values (AxP016: movable side, AxP017: fixed side) at the wear detection.

	8	Parameter
DX100	8.10	Application Parameters

8.10.4 General-purpose Application

8.10.4.1 AxP009: WORK CONTINUE PROHIBIT

This parameter specifies whether to output TOOLON instruction or not at restarting when the work is stopped for some reasons during the output of TOOLON instruction.

9 General Purpose Application

9.1 Simplified Teaching and Playback

9.1.1 Teaching

9.1.1.1 Preparation for Teaching

Perform the following tasks before starting to teach.

- Set the operation mode to teach mode.
 - Enter the job name.
1. Confirm that the mode switch on the programming pendant is set to “TEACH.” If not, set the switch to “TEACH.”
 2. Press [SERVO ON READY].
The SERVO ON lamp will blink. If [SERVO ON READY] is not pressed, the servo power supply cannot be turned ON using the Enable switch.
 3. Select {JOB} under the main menu, and select {CREATE NEW JOB} in the sub menu.

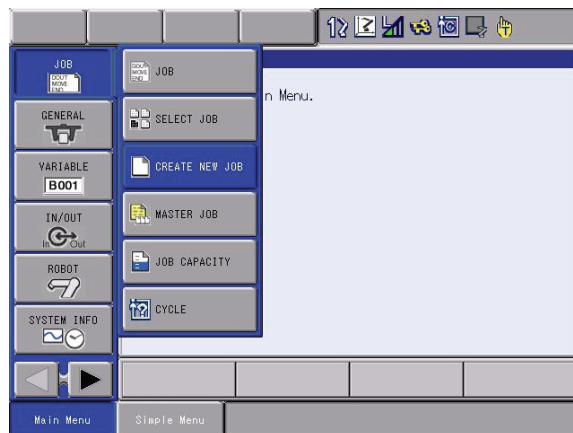

- 4. After the NEW JOB CREATE window appears, press [SELECT].

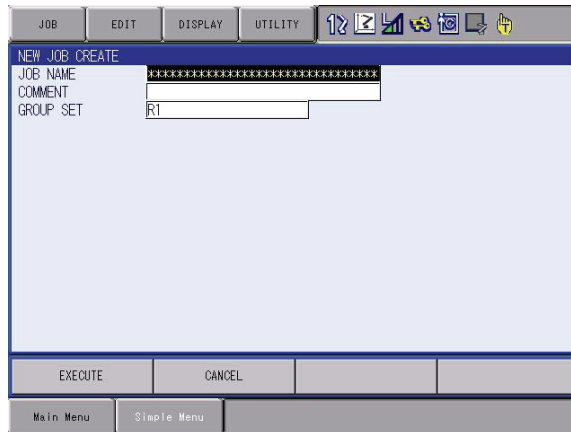

- 5. After the following window appears, input the job name. The word "TEST" is used in this example job name.

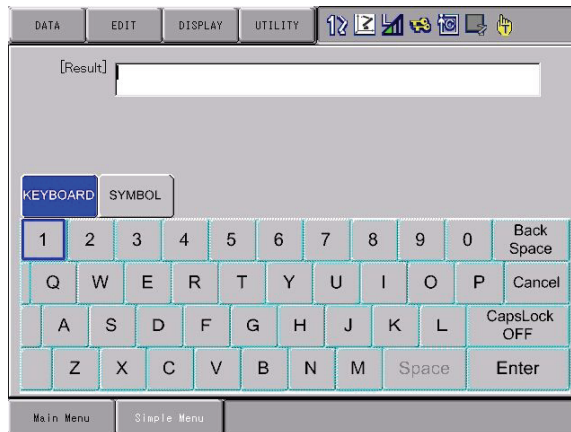

- 6. Move the active window to software keypad by pressing the [AREA] key. Move the cursor to "T" and press [SELECT]. Enter "E," "S," and "T" in the same manner. The characters can also be entered by directly touching each character on the screen.

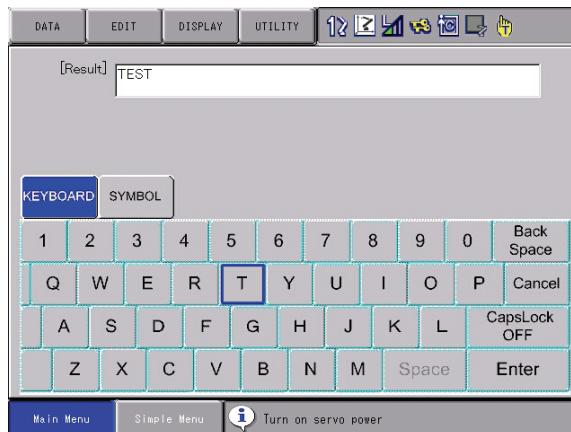

7. Press [ENTER] to register.

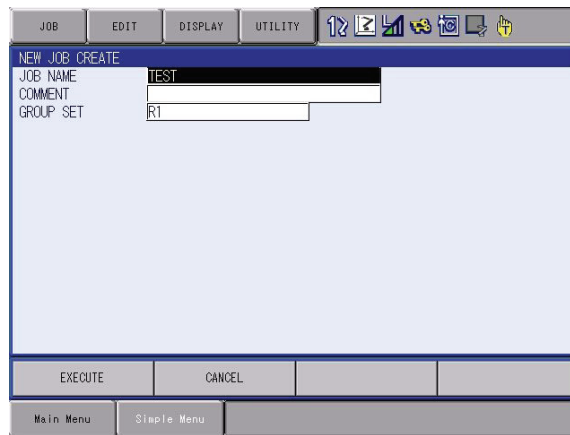

8. Move the cursor to "EXECUTE" and press [SELECT]. The job "TEST" is registered and the job is displayed. The NOP and END instructions are automatically registered.

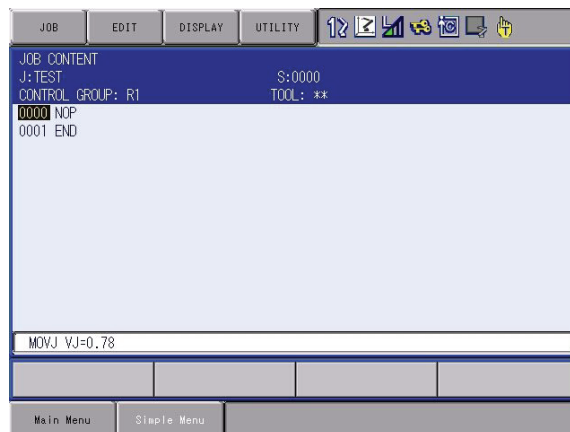

Characters which can be Used for Job Names



Job names can be created from numbers and the alphabetical letters. The input display can be switched between upper-case characters, lower-case characters, and symbols by pressing the page key  during the operation 5. Up to 32 characters can be used.

9.1.1.2 Teaching Procedure

To playback the manipulator, the instruction to move the manipulator must be written in a job. This instruction is called a move instruction. The destination position, the interpolation method, the play speed, etc. are registered in the move instruction.

Main move instructions begin with "MOV" in the INFORM III language used by the DX100.

<Example>

```
MOVJ VJ=50.00
MOVL V=1122 PL=1
```

<Example>

Refer to the following JOB CONTENT window. When executing playback, the manipulator moves to the position of Step 1 with the interpolation type and play speed registered in Step 1's move instruction. Then, the manipulator moves between Steps 1 and 2 with the interpolation type and play speed registered in Step 2's move instruction. Then, the manipulator moves between Steps 2 and 3 with the interpolation type and play speed registered in Step 3's move instruction. After the manipulator reaches the position of Step 3, the manipulator then executes the TIMER instruction followed by the DOUT instruction, and then continues on to Step 4.

JOB CONTENT		STEP NO: 0003
JOB-A		TOOL: 00
CONTROL GROUP: R1		
0000	NOP	
0001	MOVJ VJ=50.00	← Step 1
0002	MOVJ VJ=50.00	← Step 2
0003	MOVL V=1122	← Step 3
0004	TIMER T=5.00	
0005	DOUT OT#(1) ON	
0006	MOVL V=1122	← Step 4
0007	MOVJ VJ=50.00	← Step 5
0008	END	

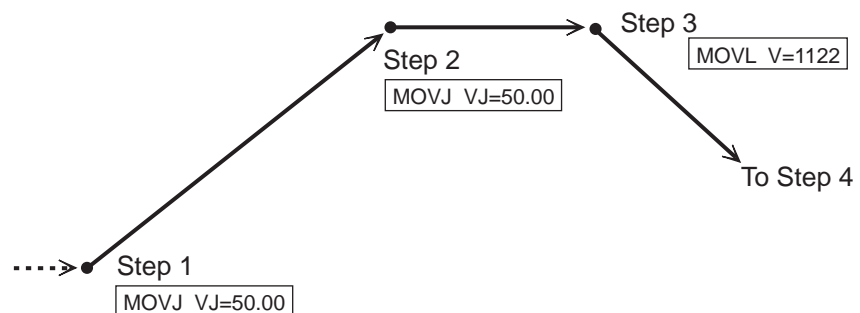

■ Teaching a Job

A job is a work program that describes the tasks that the manipulator will execute. Jobs are created using a robot programming language called INFORM III.

The following example will instruct you how to teach the manipulator all of the steps from Point A to Point B of the following workpiece. This job can be completed in 6 steps.

Fig. 9-1: Teaching a Job

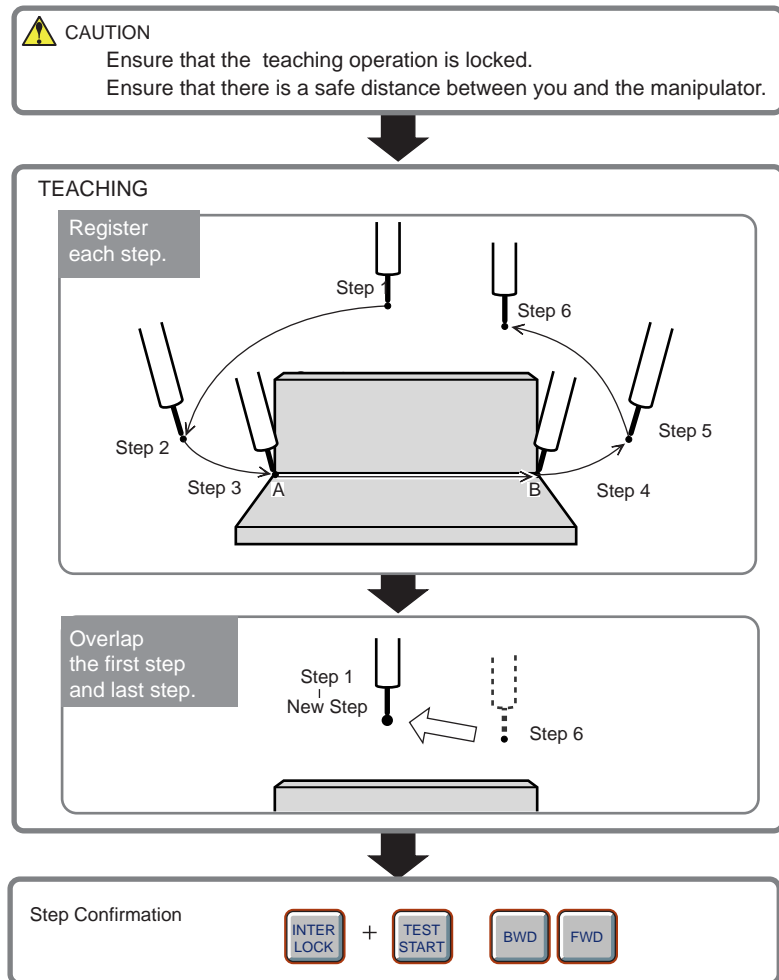

Actual work is not performed here.

■ **Step 1 -- Standby Position**

Always be sure the manipulator is in a safe work area before operation.

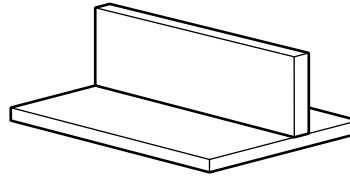
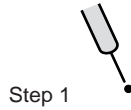

1. Grip the Enable switch and the servo power will turn ON. The manipulator can then be operated.



2. Move the manipulator to the standby position using the axis operation keys. Be sure the position is safe and that the work area is appropriate for the job to be programmed.

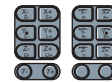

3. Select joint interpolation by pressing [MOTION TYPE]. Joint instruction "MOVJ..." will be displayed in the input buffer line.



```
=> MOVJ VJ=0.78
```

4. Move the cursor to the line number 0000 and press [SELECT].



```
0000 NOP
0001 END
```

5. The input buffer line appears. Move the cursor to the right to VJ=*.**, which shows the speed. While pressing [SHIFT] simultaneously, move the cursor  up and down (to higher and lower play speeds) until the desired speed is specified. Set the speed to 50%.



```
=> MOVJ VJ=50.00
```

6. Press [ENTER]. Step1 (Line 0001) is registered.



```
0000 NOP
0001 MOVJ VJ=50.00
0002 END
```

■ **Step 2 -- Near the Work Start Position**
Define the manipulator work pose.

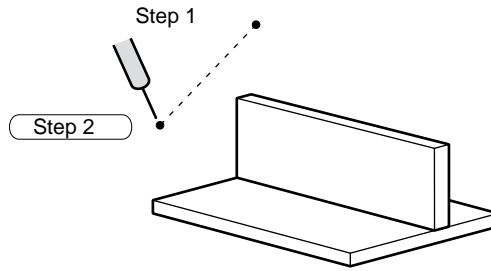

1. Move the manipulator to the working position using the axis operation keys.



2. Press [ENTER]. Step 2 (Line 0002) is registered.



```
0000 NOP  
0001 MOVJ VJ=50.00  
0002 MOVJ VJ=50.00  
0003 END
```

■ **Step 3 -- Work Start Position**

Move the manipulator to the work start position with the pose as shown in Step 2.

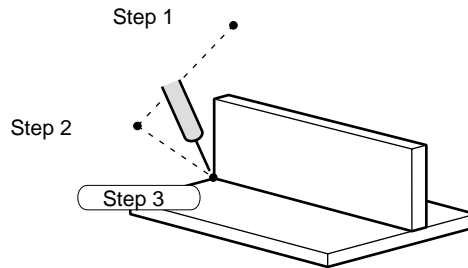

1. Change to medium speed by pressing [FAST] or [SLOW] until is displayed in the status area.



2. Do not release the pose in Step 2. Press [COORD] to select the cartesian coordinates. Move the manipulator to the welding start position using the axis operation keys.

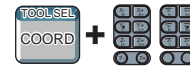

3. With the cursor located on the line number 0002, press [SELECT].



4. The input buffer line appears. Move the cursor to the right to VJ=*.**, which shows the speed. While pressing [SHIFT] simultaneously, move the cursor up and down (to higher and lower play speeds) until the desired speed is specified. Set the speed to 12.50%.



=> MOVJ VJ=12.50

5. Press [ENTER]. Step 3 (Line 0003) is registered.



```

0000 NOP
0001 MOVJ VJ=50.00
0002 MOVJ VJ=50.00
0003 MOVJ VJ=12.50
0004 END
    
```

■ **Step 4 -- Work End Position**
 Specify the work end position.

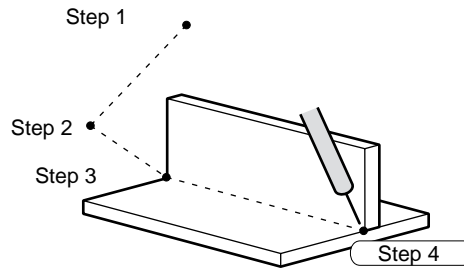

1. Move the manipulator to the work end position with the axis operation keys. While the manipulator is moving, keep a wide enough distance to ensure it will not strike the workpiece. There is no need to follow the work line too closely.



2. Press [MOTION TYPE] to select linear interpolation (MOVL).



=> MOVL V=66

3. With the cursor located on the line number 0003, press [SELECT].



=> **MOVL** V=66

4. The input buffer line appears. Move the cursor to the right to V=*.**, which shows the speed. While pressing [SHIFT] simultaneously, move the cursor  up and down (to higher and lower play speeds) until the desired speed is specified.
Set the speed to 138 cm/min.



=> MOVL V=**138**

5. Press [ENTER]. Step 4 (Line 0004) is registered.



```
0000 NOP
0001 MOVJ VJ=50.00
0002 MOVJ VJ=50.00
0003 MOVJ VJ=12.50
0004 MOVL V=138
0005 END
```

■ **Step 5 -- Clear Position**

Move the manipulator to a position where it will not strike the workpiece or fixture.

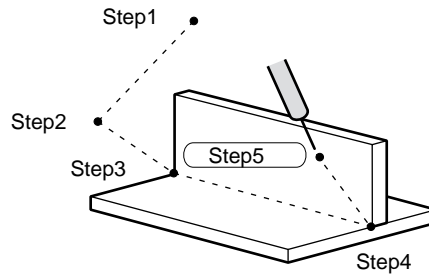

1. Change the speed to high speed by pressing [FAST].



This button only affects teaching speed. When the job is played, the job will execute at the speed defined in Step 4.

2. Move the manipulator with the axis operation keys to a position where it will not strike the fixture.



3. Press [MOTION TYPE] to set to the joint interpolation type (MOVJ).



4. With the cursor located on line number 0004, press [SELECT].



5. The input buffer line appears. Move the cursor to the right to VJ=12.50, which shows the speed. While pressing [SHIFT] simultaneously, move the cursor up and down (to higher and lower play speeds) until the desired speed is specified. Set the speed to 50%.

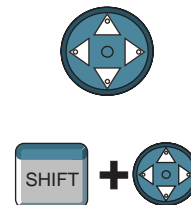

6. Press [ENTER]. Step5 (Line 0005) is registered.

```

0000 NOP
0001 MOVJ VJ=50.00
0002 MOVJ VJ=50.00
0003 MOVJ VJ=12.50
0004 MOVL V=138
0005 MOVJ VJ=50.00
0006 END

```



■ **Step 6 -- Near the Standby Position**

Move the manipulator near the standby position.

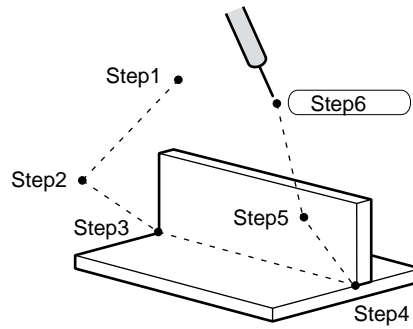

1. Move the manipulator near the standby position with the axis operation keys.

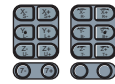

2. Press [ENTER]. Step6 (Line 0006) is registered.

```

0000 NOP
0001 MOVJ VJ=50.00
0002 MOVJ VJ=50.00
0003 MOVJ VJ=12.50
0004 MOVL V=138
0005 MOVJ VJ=50.00
0006 MOVJ VJ=50.00
0007 END
  
```



■ **Ensuring the First and Last Step are Identical**

The manipulator has stopped at Step 6, which should be very close to Step1.

It is possible to move directly from the job end position of Step 5 to Step1, so the manipulator can begin the next job quickly and efficiently.

The following operation will make Step 6 (end position) and Step1 (standby position) identical.

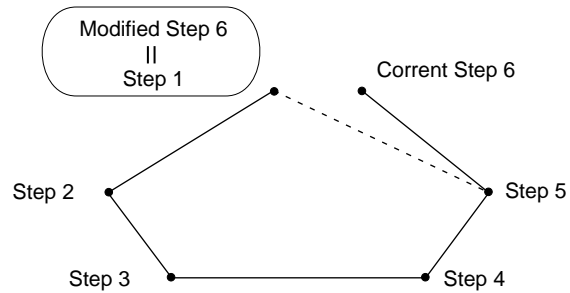

1. Move the cursor to Step 1 (Line 0001).

```
0000 NOP
0001 MOVJ VJ=50.00
0002 MOVJ VJ=50.00
0003 MOVJ VJ=12.50
0004 MOVL V=138
0005 MOVJ VJ=50.00
0006 MOVJ VJ=50.00
0007 END
```

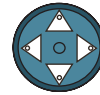

2. Press [FWD]. The manipulator will move to Step1.



3. Move the cursor to Step 6 (Line 0006).

```
0000 NOP
0001 MOVJ VJ=50.00
0002 MOVJ VJ=50.00
0003 MOVJ VJ=12.50
0004 MOVL V=138
0005 MOVJ VJ=50.00
0006 MOVJ VJ=50.00
0007 END
```



4. Press [MODIFY].



5. Press [ENTER]. This will change the position of Step 6 to be the same as Step1.



9.1.1.3 Path Confirmation

The job is now complete. Try to check each step separately to ensure there are no problems.

1. Move the cursor to Step 1 (Line 0001).

```

0000 NOP
0001 MOVJ VJ=50.00
0002 MOVJ VJ=50.00
0003 MOVJ VJ=12.50
0004 MOVL V=138
0005 MOVJ VJ=50.00
0006 MOVJ VJ=50.00
0007 END
  
```



2. Change to medium speed by pressing [FAST] or [SLOW].



3. Press [FWD] to confirm each step executed by the manipulator. Each time [FWD] is pressed, the manipulator moves one step.



4. When you finish step confirmation, move the cursor to the beginning of the job.



5. Run all the steps continuously. Hold down [INTERLOCK] and press [TEST START]. The manipulator plays back all the steps continuously and stops when one cycle is finished.



Proceed to the next section to change the position and speed of the job steps.

9.1.1.4 Correcting a Job

CAUTION

- **After the job is corrected, be sure to confirm the path.**

- **Before Correcting a Job**
Confirm the manipulator's motion in each step. If any position modification or adding or deleting of steps is necessary, display the job content first with the following procedure.

1. Select {JOB} under the main menu and {JOB} under the sub menu to display the JOB CONTENT window.

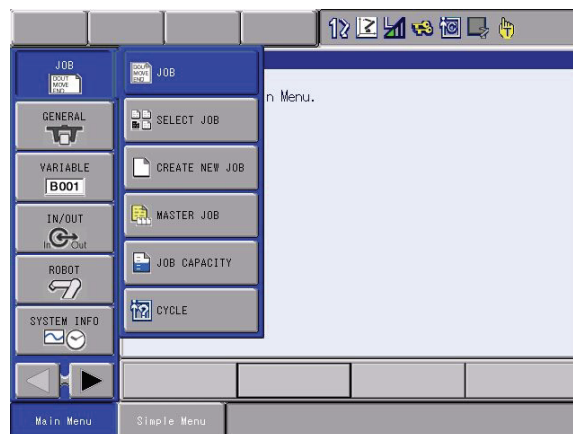

9.1.1.5 Changing the Position Data

Change the position registered in Step 2.

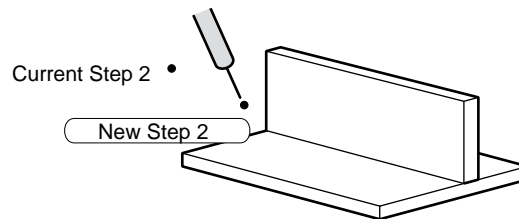

1. Move the manipulator to Step 2 (Line 0002) by pressing [FWD].



2. Move the manipulator to the modified position with the axis operation keys.

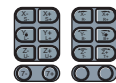

3. Press [MODIFY].



4. Press [ENTER]. The step's position data is changed.



■ **Adding a Step**

Add a new step between Step 5 and Step 6.

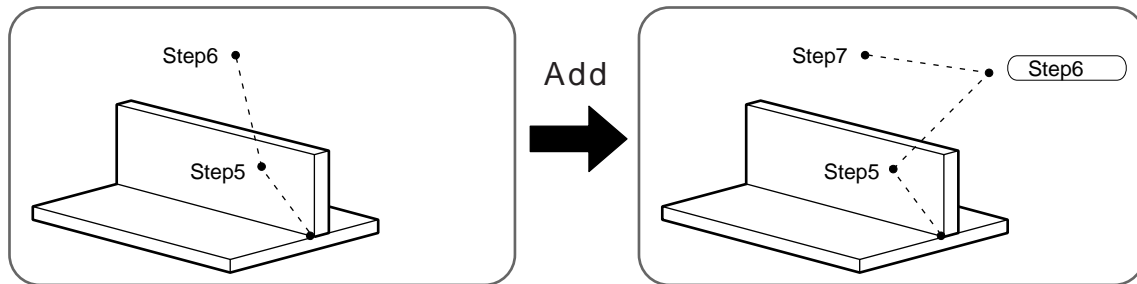

1. Move the manipulator to Step 5 (Line 0005) by pressing [FWD].

```

0000 NOP
0001 MOVJ VJ=50.00
0002 MOVJ VJ=50.00
0003 MOVJ VJ=12.50
0004 MOVL V=138
0005 MOVJ VJ=50.00
0006 MOVJ VJ=50.00
0007 END
  
```



2. Move the manipulator to the position at which you wish to add a step using the axis operation keys.



3. Press [INSERT].



4. Press [ENTER]. The step is added. When a step is added, the numbering is automatically adjusted to count the new step.



```

0000 NOP
0001 MOVJ VJ=50.00
0002 MOVJ VJ=50.00
0003 MOVJ VJ=12.50
0004 MOVL V=138
0005 MOVJ VJ=50.00
0006 MOVJ VJ=50.00
0007 MOVJ VJ=50.00
0008 END
  
```

■ Deleting a Step

Delete the step you just added.

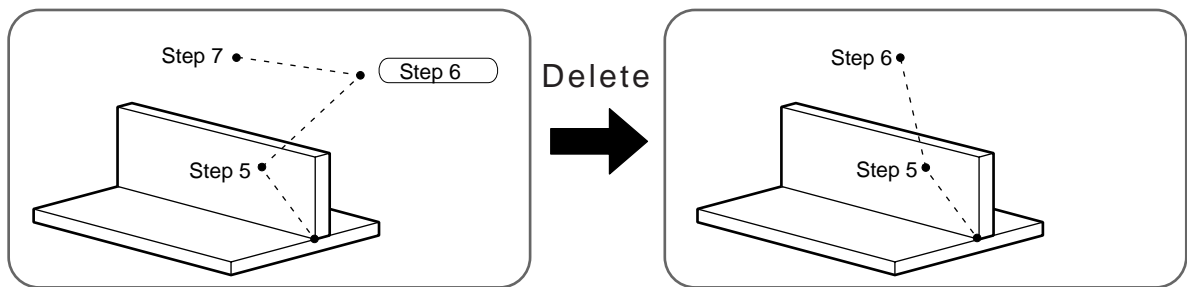

1. Move the manipulator to Step 6 (Line 0006) by pressing [FWD].

```
0000 NOP
0001 MOVJ VJ=50.00
0002 MOVJ VJ=50.00
0003 MOVJ VJ=12.50
0004 MOVL V=138
0005 MOVJ VJ=50.00
0006 MOVJ VJ=50.00
0007 MOVJ VJ=50.00
0008 END
```



2. Make sure the cursor is on the step you wish to delete, and press [DELETE].

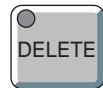

3. Press [ENTER]. The step is deleted. When a step is deleted, the numbering of step is automatically adjusted corresponding to the deletion.



```
0000 NOP
0001 MOVJ VJ=50.00
0002 MOVJ VJ=50.00
0003 MOVJ VJ=12.50
0004 MOVL V=138
0005 MOVJ VJ=50.00
0006 MOVJ VJ=50.00
0007 END
```

When "Error 2070: Set Robot Exactly to Taught Position" Occurs

When the operator presses [ENTER] during the previous operation, an error can occur in some cases. The error occurs because the manipulator has not been moved exactly to the taught position. Cancel the error with either of the following two procedures:



- Press [CANCEL] and press [FWD] to move the manipulator to the position of the step.
- Press [MODIFY] and press [ENTER] to change the position data of the step, then press [DELETE] and press [ENTER].

If the cursor in the window is blinking, the manipulator is not in the taught position.

■ Changing the Speed between Steps

Change the manipulator speed. Slow the speed between Step 3 and Step 4.

1. Move the cursor to Step 4.

```
0000 NOP
0001 MOVJ VJ=50.00
0002 MOVJ VJ=50.00
0003 MOVJ VJ=12.50
0004 MOVL V=138
0005 MOVJ VJ=50.00
0006 MOVJ VJ=50.00
0007 END
```



2. Move the cursor to the instruction and press [SELECT].

```
0000 NOP
0001 MOVJ VJ=50.00
0002 MOVJ VJ=50.00
0003 MOVJ VJ=12.50
0004 MOVL V=138
0005 MOVJ VJ=50.00
0006 MOVJ VJ=50.00
0007 END
```



3. The input buffer line appears. Move the cursor to the right to "V=138," which shows the speed. While pressing [SHIFT] simultaneously, move the cursor  up and down (to higher and lower play speeds) until the desired speed is specified. Set the speed to 66cm/min.

```
0000 NOP
0001 MOVJ VJ=50.00
0002 MOVJ VJ=50.00
0003 MOVJ VJ=12.50
0004 MOVL V=66
0005 MOVJ VJ=50.00
0006 MOVJ VJ=50.00
0007 END
```



4. Press [ENTER]. The speed is changed.

```
0000 NOP
0001 MOVJ VJ=50.00
0002 MOVJ VJ=50.00
0003 MOVJ VJ=12.50
0004 MOVL V=66
0005 MOVJ VJ=50.00
0006 MOVJ VJ=50.00
0007 END
```



The unit for speed can be verified and modified by "SPEED DATA INPUT FORM" from {SETUP} → {OPERATE COND}.

9.1.2 Playback

9.1.2.1 Preparation Before Playback



To run the program from the beginning of the job, perform the following operation.

- Move the cursor to the beginning of the job.
- Move the manipulator close to Step 1 with the axis operation keys.

When playback is started, the manipulator begins to move from the Step 1.

9.1.2.2 Playback Procedure

Begin operation only after ensuring there is no one in the working envelope of the manipulator.

1. Switch the mode switch on the programming pendant to "PLAY."



2. Press [SERVO ON READY] to turn ON the servo power.



3. Press [START]. The manipulator will perform one complete taught cycle and then stop.



9.1.3 Example for General Purpose Application

9.1.3.1 Example Job

The figure below shows an example of cutting. The job creation procedure is then explained.

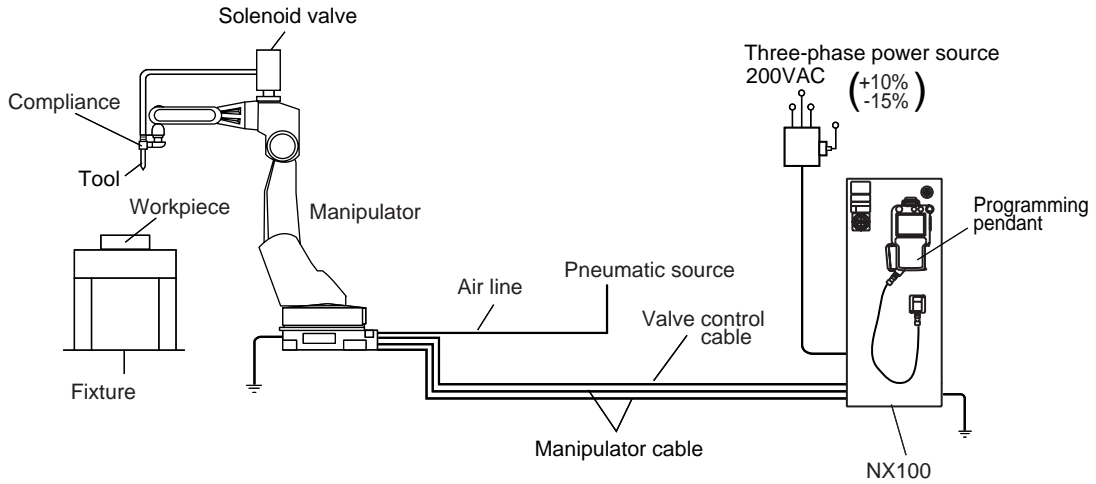

Line	Instruction	Explanation
0000	NOP	
0001	MOVJ VJ=25.00	Moves manipulator to the standby position. (Step 1)
0002	MOVJ VJ=25.00	Moves manipulator near the cutting start position. (Step 2)
0003	MOVJ VJ=12.50	Moves manipulator to the cutting start position. (Step 3)
0004	TOOLON	Starts cutting.
0005	MOVL V=50.0	Moves manipulator to the cutting end position. (Step 4)
0006	TOOLOF	Ends cutting.
0007	MOVJ VJ=25.00	Moves manipulator to the position where the tools and workpieces do not interfere. (Step 5)
0008	MOVJ VJ=25.00	Moves manipulator to the standby position. (Step 6)
0009	END	

9.1.3.2 Teaching Procedure

The teaching procedure of Step 2 which specifies the cutting pose and Step 3 and 4 (cutting section) are explained.

NOTE

- Teach Step 1, which is the standby position, to a safe position where the manipulator will not collide with the workpiece and the tool.
- Confirm the cutting path with [FWD] and [BWD] after teaching.

■ Step 2 -- Near cutting position

Define the cutting pose.

1. Specify the correct posture with the axis operation keys for the manipulator to start cutting.

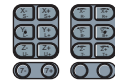

2. Press [ENTER]. Step 2 is registered.

```
0000 NOP
0001 MOVJ VJ=25.00
0002 MOVJ VJ=25.00
0003 END
```



■ **Step 3 -- Cutting Start Position**

Move to the cutting start position with the pose as shown in Step 2, and register the TOOLON instruction.

1. Change to medium speed by pressing [FAST] or [SLOW]. Medium speed:  is displayed in the status area.



2. Move the manipulator to the cutting start position with the axis operation keys. At this time, do not release the pose input in Step 2.

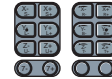

3. With the cursor located on the line number, press [SELECT].



4. The input buffer line appears. Move the cursor to the right to "VJ=25.00," which shows the speed. While pressing [SHIFT] simultaneously, move the cursor  up and down (to higher and lower play speeds) until the desired speed is specified. Set the speed to 12.50%.

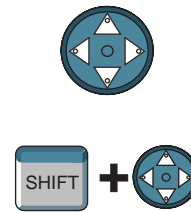

5. Press [ENTER]. Step 3 is registered.

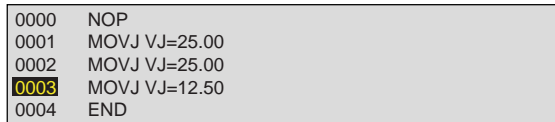

6. Press [2/TOOL ON]. "TOOLON" is displayed in the input buffer line.



7. Press [ENTER]. The TOOLON instruction is registered.



■ Step 4 -- Cutting End Position

Define the cutting end position.

1. Move the manipulator to the cutting end position with the axis operation keys. It is necessary to choose a direction in which the treatment device and the tools do not interfere when the manipulator moves, and teach that position.

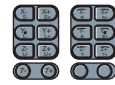

2. Set linear interpolation (MOVL) by pressing [MOTION TYPE].

```
=> MOVL V=11.0
```



3. With the cursor located on the line number, press [SELECT].

```
=> MOVL V=11.0
```



4. The input buffer line appears. Move the cursor to the right to "V=11.0," which shows the speed. Press [SELECT] to enable the input of numbers. Then, input the desired value of 50.0mm/s with the Numeric keys and press [ENTER].



5. Press [ENTER]. Step 4 is registered.

```
0000 NOP
0001 MOVJ VJ=25.00
0002 MOVJ VJ=25.00
0003 MOVJ VJ=12.50
0004 TOOLON
0005 MOVL V=50.0
0006 END
```

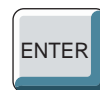

6. Press [./TOOL OF]. "TOOLOF" is displayed in the input buffer line.

```
=> TOOLOF
```



7. Press [ENTER]. The TOOLOF instruction is registered.

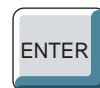

9.1.3.3 Confirmation of Cutting Operation (Speed Limitation Drive)

The speed limitation drive is executed to confirm the taught path. All the operations operate below the limitation speed during teach mode (250mm/s usually) in the speed limitation drive. If the taught speed is below the limitation speed, the operation is executed at the same speed as the teaching procedure.

1. Switch the mode switch on the programming pendant to "PLAY."



2. Select {UTILITY} and {SETUP SPECIAL RUN}. The SPECIAL PLAY window appears.

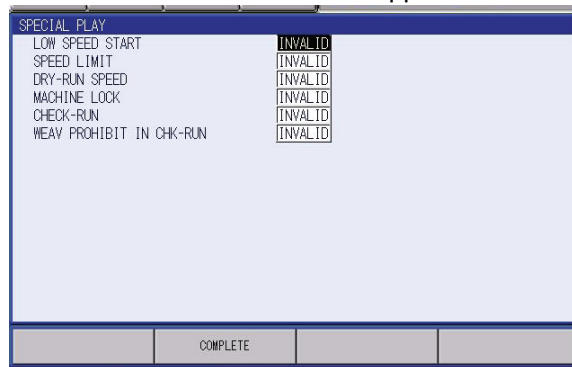

3. Move the cursor to the "SPEED LIMIT" setting and press [SELECT]. The condition becomes "VALID" and the speed limit is turned ON.

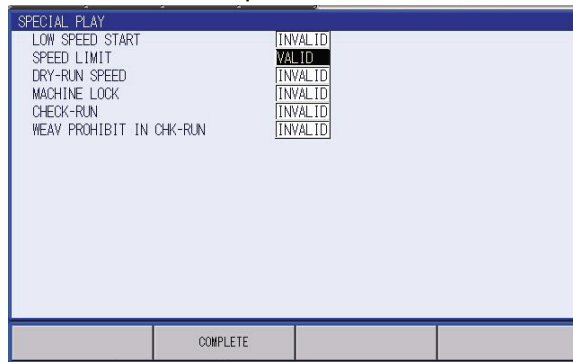

■ **Cutting Execution**

Once the path has been determined, cutting is finally executed at actual speed. If the job is played back with the speed limitation drive disabled, cutting is executed at taught speed.

9.2 Operation for Tool Control

9.2.1 Function Keys

The function keys for tool control are assigned to the Numeric keys as described below.



Registers the TOOLON instruction.

If [INTERLOCK] is pressed simultaneously, the TOOLON operation is executed.



Registers the TOOLOF instruction.

If [INTERLOCK] is pressed simultaneously, the TOOLOFF operation is executed.



Registers the CALL instruction for the reserved job TOOLONxx.



Registers the CALL instruction for the reserved job TOOLOFxx.

9.2.2 Tool Control Settings

The following setting can be performed on the GENERAL DIAGNOSIS window.

1. Select {GENERAL} under the main menu.
2. Select {GENERAL DIAGNOSIS}.
 - The GENERAL DIAGNOSIS window appears.



- Select "CONT" to continue the work operation when the manipulator is restarted after it abort for any reason during the work operation. Select "STOP" to abort the work operation if the manipulator stops. When the manipulator is restarted, it moves without doing any work. Use the work start command to restart the work instruction.
3. Select the setting data of "WORKING ABORT PROCESS."
 - Each time [SELECT] is pressed, "CONT" and "STOP" is alternately displayed. The displaying state is the current setting.



9.2.3 Work Instructions

9.2.3.1 TOOLON/TOOLOF Instructions

1. These instructions are to perform TOOLON/TOOLOFF. The function keys are [TOOLON] and [TOOLOF].

TOOLON



TOOLOF



1. Select {JOB} under the main menu.
2. Select {JOB}.
3. Press [TOOLON] or [TOOLOF].
 - The TOOLON or TOOLOF instruction is displayed in the input buffer line. Or press [INFORM LIST] to display the instruction box and select the TOOLON/TOOLOF instruction.

– **TOOLON**

Turns ON the work instruction.

Turns ON the work start command (system output relay #51530) and waits for the work start response (system input relay #41130). The next instruction is executed when the work response turns ON. The work start response relay turns ON immediately after the work start command is output.

– **TOOLOF**

Turns OFF the work instruction.

Turns ON the work end command (system output relay #51531) and waits for the work end response (system input relay #41131). The next instruction is executed when the work end response turns ON.

The work end response relay turns ON immediately after the work end command is output. The work instruction is programmed to hold after the work start command turns ON and to turn OFF when the work end command turns ON.

When the manipulator stops during the work operation, the work instruction turns OFF.

When restarting, turn ON the work instruction when "WORKING ABORT PROCESS" is set to "CONT." Do not turn OFF the work instruction when "STOP" is set.

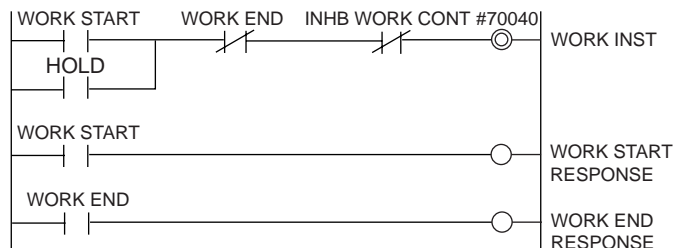

4. Press [INSERT].
5. Press [ENTER].

DX100	9	General Purpose Application
	9.2	Operation for Tool Control

9.2.3.2 CALL Instruction

This instruction calls a reserved job TOOLONxx or TOOLOFxx. The function keys for registration are [TOOLON JOB] and [TOOLOF JOB].

1. Select {JOB} under the main menu.
2. Select {JOB}.
3. Press [TOOLON JOB] or [TOOLOF JOB].
 - The CALL instruction is displayed in the input buffer line.



⇒ CALL JOB:TOOLON

4. Select the job name.
 - The JOB LIST window appears.
5. Press [SELECT].
 - The window for character input appears.
The job name can now be changed. Modify the job name and press [ENTER].
6. Press [INSERT].
7. Press [ENTER].

9.2.3.3 WVON Instruction

This instruction starts the weaving motion. Specify conditions in the weaving condition file when registering the WVON instruction.

1. Select {JOB} under the main menu.
2. Select {JOB}.
3. Press [INFORM LIST].
4. Select the WVON instruction.

– The WVON instruction is displayed in the input buffer line.

⇒ WVON WEV#(1)

– To register the instruction displayed in the input buffer line without editing, press [INSERT] and then press [ENTER].

5. Select the file number and edit.

– The input line is displayed.

Weaving_file_no.=
⇒ WVON WEV#() ON

– Input weaving file number using the Numeric keys and press [ENTER]. (In the following example, 2 is entered.)

⇒ WVON WEV#(2)

6. Press [INSERT].
7. Press [ENTER].

9.2.3.4 WVOF Instruction

This instruction ends the weaving motion.

1. Select {JOB} under the main menu.
2. Select {JOB}.
3. Press [INFORM LIST].
4. Select the WVOF instruction.

– The WVOF instruction is displayed in the input buffer line.

⇒ WVOF

5. Press [INSERT].
6. Press [ENTER].

9.3 Using Files

9.3.1 Weaving Basic Coordinate System

Weaving is performed based on the following coordinate system. This coordinate system is automatically generated according to the conditions described in a weaving condition file.

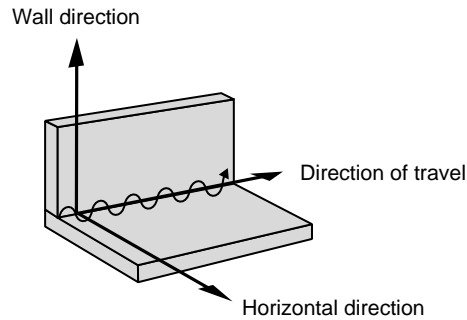

Weaving Basic Coordinate System

Wall Direction: Z-direction of the robot axis

Horizontal Direction: The direction of approach point from the wall

Direction of Travel: The direction in which the manipulator moves from the weaving start point to the end point



The approach point is a point indicated by a step immediately before the step where weaving starts.

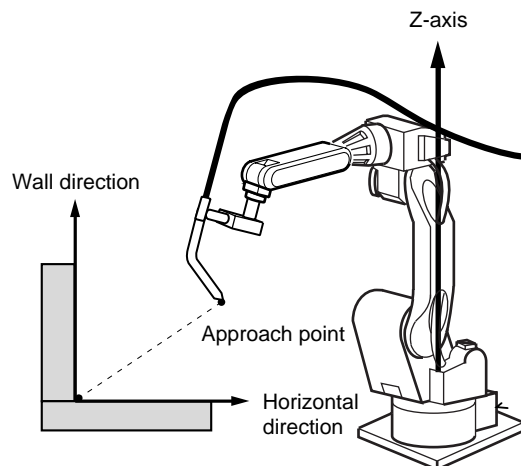

Depending on the mounting and shape of the workpiece, a definition of the above coordinate system may not be sufficient to generate a weaving pattern. In that case, register the reference point REFP1 or REFP2. For details, refer to *chapter 9.3.3.3 "Cases that Require the Registration of Reference Points" at page 9-34*.

9.3.2 WEAVING CONDITION Window

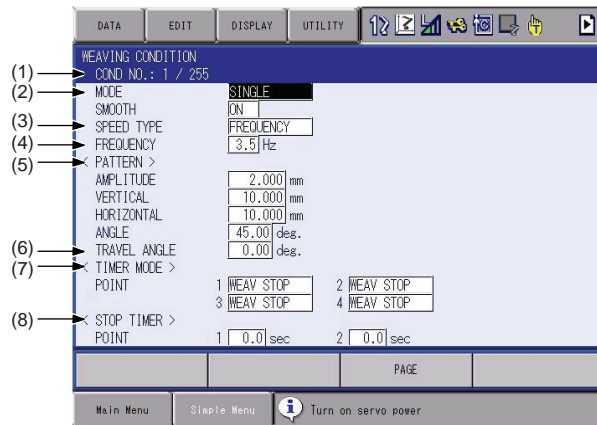

WEAVING CONDITION Window

(1) WEAVING COND NO. (1 to 255)

- Displays a weaving condition file number.

(2) MODE (Weave type)

- There are three weave type: single oscillation, triangle oscillation, and L-type oscillation. Each type can be specified with or without smoothing.

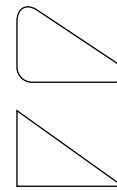
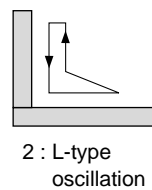
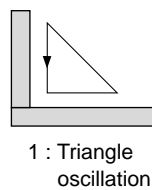
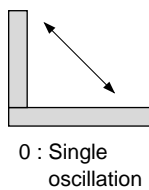

0 : With smoothing

1 : Without smoothing

Weave Type

Smoothing

(3) SPEED

- Specifies how the oscillation speed is defined.
0: Defined by the frequency.
1: Defined by the weaving time for each weaving section.

(4) FREQUENCY

- Specifies the weaving frequency if "SPEED (3)" is set to "0: FREQ."
 Note that the maximum frequency is determined by the amplitude as illustrated in the graph below. Specify a frequency within the allowable range. Note that the graph only indicates tentative values.

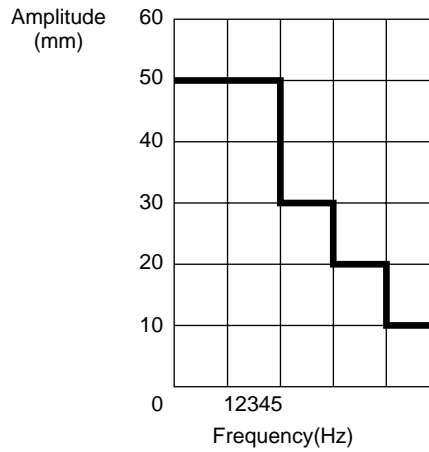

Maximum Frequencies for Different Amplitudes

(5) PATTERN

- If "MODE (2)" is set to "0: SINGL," the angle must be specified.

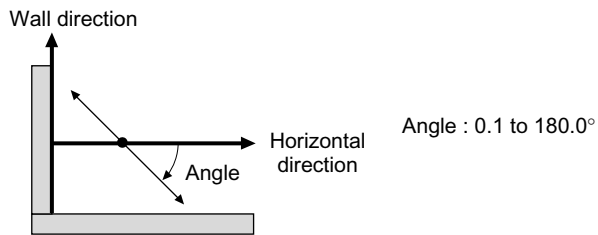

"Mode ②" (Weave Type): Single oscillation

- If "MODE (2)" is set to "1: TRI" or "2: L", the following information on the triangle must be specified: vertical distance, horizontal distance, and angle.

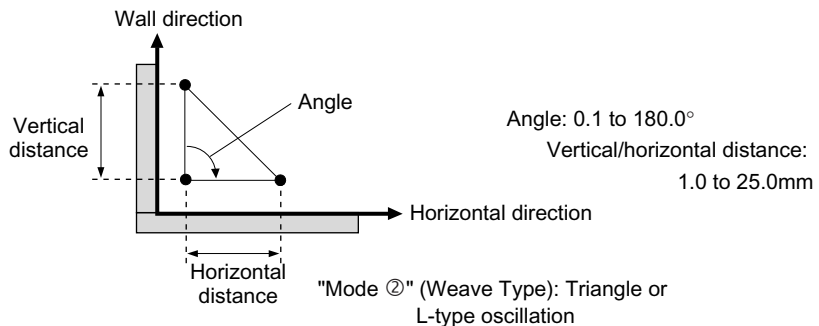

"Mode ②" (Weave Type): Triangle or L-type oscillation

(6) ANGLE

- The oscillation angle as measured from the weld line.
- Range: from - 90(deg.) to + 90(deg)

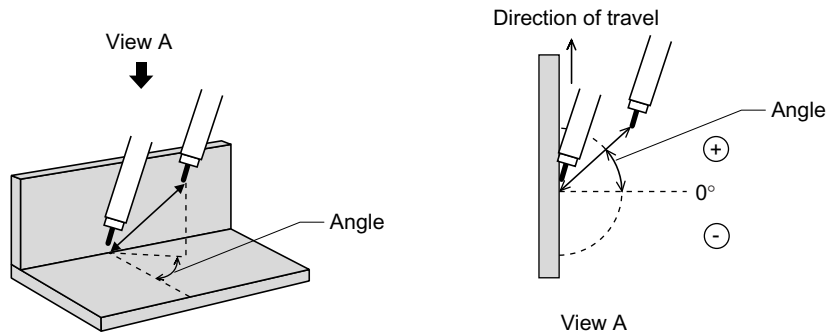

(7) TIMER (Timer mode)

– As shown below, a single weaving period is divided into three or four sections. A timer count can be specified for pauses at a point (node) between sections. (The circled number indicates section number.)

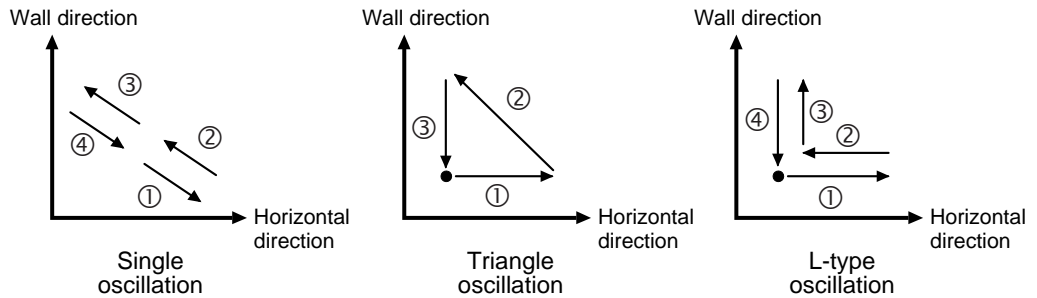

Set one of the following timer modes:

0 : Weaving stops but manipulator moves.
 1 : Manipulator pauses.



(8) TIMER (Timer count)

– If “Speed (3) is set to “1: MOVING TIME,” a timer count specified here determines the duration of a pause (weaving stop or manipulator pause) at a mode between two sections of (8).

9.3.3 Operation Method

9.3.3.1 Displaying a Weaving File

1. Select {ARC WELDING} under the main menu.
2. Select {WEAVING}.
3. Display the desired file number.
 - The weaving condition file can be displayed using the page key



Press the page key  to call the next file number.

Press [SHIFT]+ page key  to call the previous file number.

Press the page key to input the desired file number, then press enter key.

9.3.3.2 Editing Condition Data

1. Select the item to be edited.
2. Input the value using the Numeric keys.

9.3.3.3 Cases that Require the Registration of Reference Points

The registration of the reference point REFP1 or REFP2 is not usually required. They are required only with a special workpiece condition, etc.

The REFP1, which defines the wall direction, is a point on the wall surface or its expansion plane. The REFP2, which defines the horizontal direction, is a point at the right or left side of the wall.

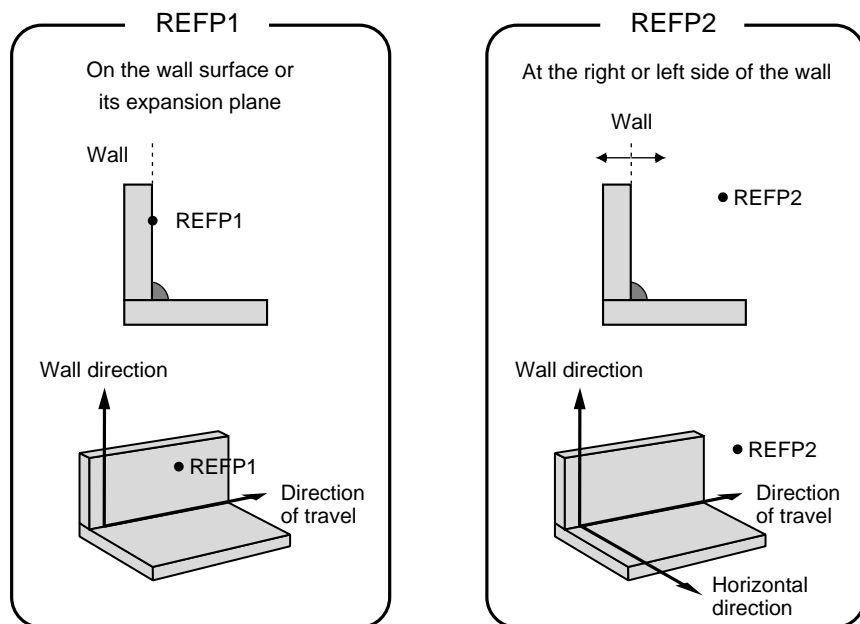



For information on registering REFP, refer to *chapter 3.2.3.2 "Registering Reference Point Instructions" at page 3-17.*

< Example 1 > REFP1 is registered because the wall direction is not parallel to the Z-axis of the robot coordinate.

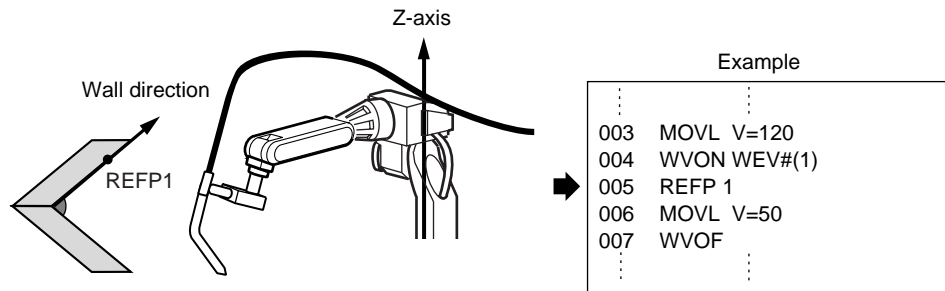

< Example 2 > REFP2 is registered because the approach point is at another side of the wall.

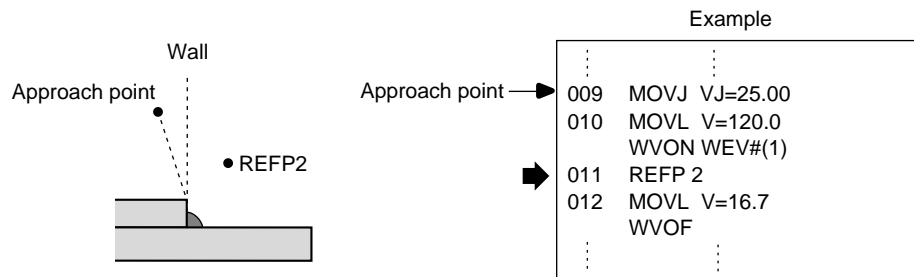

9.3.3.4 Prohibiting Weaving

If the weaving instruction is registered during the check mode of the play mode or "TEST RUN" or FWD operation in the teach mode, weaving is executed as well as other move instructions. However, in some cases when weaving is not wanted because of a workpiece collides, etc., follow the procedure below to prohibit weaving.

9.3.3.5 Method to Prohibit Weaving in the Check Mode

1. Press [AREA].
2. Select {UTILITY}.
3. Select {SPECIAL PLAY}.
4. Select prohibit weaving during the check mode.

– The SPECIAL PLAY window appears.

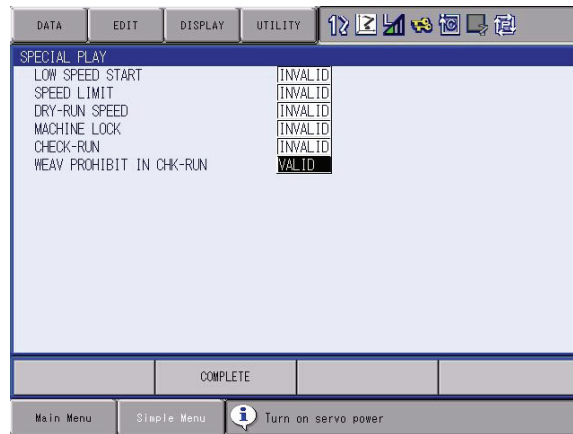

9.3.3.6 Method to Prohibit Weaving During a “TEST RUN” or FWD Operation

1. Press [AREA].
2. Select {UTILITY}.
3. Select {SPECIAL TEACH}.
4. Select prohibit weaving during the FWD/TEST RUN operation.

– The SPECIAL TEACH window appears.

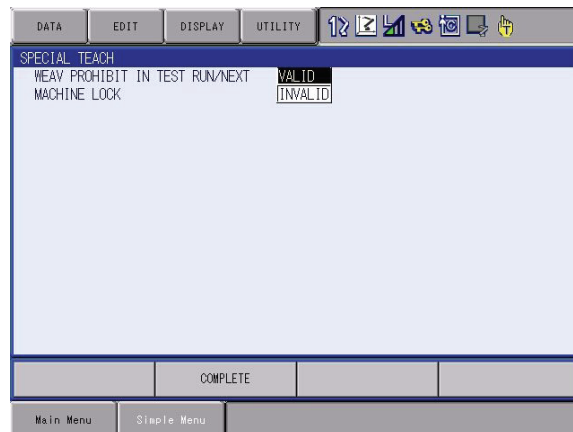

9.3.3.7 Prohibiting Weaving By Means of a System Input Signal

The system input signal #40047 is used.

The system input signal can prohibit weaving at any time during a play operation, regardless of whether or not it is in a check mode.

9.4 Table of Work Instructions

- < > indicates alpha-numerical data.
- If multiple items are shown in one additional item section, select one.

Table 9-1: General-purpose Instructions

TOOLON	Function	Turns ON work tools (work instructions).	
	Additional Item	TOOL1, TOOL2	Displayed only when using multiple manipulators.
	Example	TOOLON	
TOOLOF	Function	Turns OFF work tools (work instructions).	
	Additional Item	TOOL1, TOOL2	Displayed only when using multiple manipulators.
	Example	TOOLOF	
WVON	Function	Starts weaving.	
	Additional Item	RB1, RB2	Displayed only when using multiple manipulators.
		WEV#(<weaving condition file number>)	1 to 255
Example	WVON WEV# (1)		
WVOF	Function	Ends weaving.	
	Additional Item	RB1, RB2	Displayed only when using multiple manipulators.
		None	
Example	WVOF		

10 Handling Application

10.1 Outlines

10.1.1 Function Keys

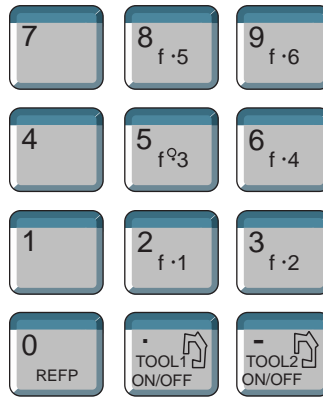

Table 10-1: Key Function

	<p>Switches the signal output of [f·1] and [f·2] ON and OFF when [INTERLOCK] is simultaneously pressed. "1" side gripper valve signals (HAND 1-1 to HAND 4-1) can be allocated to [f·1] and "2" side gripper valve signals (HAND 1-2 to HAND 4-2) can be allocated to [f·2]. Alternatively, user signals can be allocated to the keys. The key allocations can be changed from the HANDLING window or by changing the AP parameters directly.</p>
	<p>Switches gripper 1 (HAND 1-1/HAND 1-2) output or the gripper 2 (HAND 2-1/HAND 2-2) output ON and OFF when [INTERLOCK] is simultaneously pressed. The output signal is a double-solenoid-type signal. Also, press these keys during editing on the JOB CONTENT window in the teach mode to register the HAND instructions.</p>
	<p>Not used.</p>

10.1.2 HAND Instruction

10.1.2.1 Function

The following instructions open and close the grippers mounted on the manipulator. They correspond to single-, double-, and triple-position solenoids. Up to four grippers can be controlled for each manipulator. The following sequences are available for solenoid signal control, according to the valve selected.

- **SP (single-solenoid)**
The HAND instruction turns ON/OFF the gripper valve (x-1). The inverse signal is output to the gripper valve (x-2). Connect the valve to either one when used in a single-solenoid.
- **2P (double-solenoid)**
The HAND instruction turns ON/OFF the gripper valve (x-1). The inverse signal is output to the gripper valve (x-2).
- **3P (triple-position solenoid)**
Adding ALL to the HAND instruction allows both gripper valve (x-1) and gripper valve (x-2) to be turned ON/OFF simultaneously. Functions as a double-solenoid if ALL is not added to the HAND instruction.

Table 10-2: Valve ON/OFF Condition of Each Solenoid

Instruction (x: Gripper No.)	SP (Valve x-1/x-2)	2P (Valve x-1/x-2)	3P (Valve x-1/x-2)
HAND x ON	ON/- (-/OFF)	ON/OFF	ON/OFF
HAND x OFF	OFF/- (-/OFF)	OFF/ON	OFF/ON
HAND x ON ALL	-	-	ON/ON
HAND x OFF ALL	-	-	OFF/OFF

10.1.2.2 Instruction and Additional Items

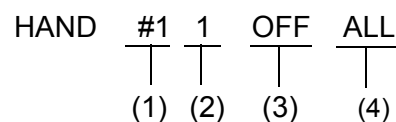

(1) Device Number(#1 or #2)

Sets when two manipulators are used for handling.

(2) Gripper Number(1 to 4)

Required.

(3) Gripper Output Status(ON/OFF)

Required.

Select ON or OFF.

(4) Valve Simultaneous Control (ALL)

Adds to turn valves 1 and 2 ON or OFF simultaneously.

10.1.3 HSEN (Gripper Sensor) Instruction

10.1.3.1 Function

Confirm that the gripper sensor is in the specified status. If the gripper sensor is in the specified status, the result is \$B014* and the next instruction is executed. If a timer is specified, the instruction waits for the specified time (including infinity) to be input.

10.1.3.2 Instruction and Additional Items

HSEN	<u>#1</u>	<u>1</u>	<u>OFF</u>	<u>T=10.00</u>
	(1)	(2)	(3)	(4)

(1) Device Number(#1 or #2)

Set when two manipulators are used for handling.

(2) Sensor Number(1 to 8)

Required.

(3) Sensor Input Status(ON/OFF)

Required.

Select ON or OFF.

(4) Signal waiting time(T=0.01 to 655.35sec)

FOREVER: Unlimited time

If omitted, T=0.

\$B014: Variable for execution result

Sets the execution result.

0: is set when the instruction is ended before the timer is over.

1: is set when the instruction is ended when the timer is over.

10.1.3.3 Examples

HSEN 1 ON FOREVER
OFF FOREVER

Waits until sensor 1 turns ON (OFF). At completion, the result (1: gripper sensor 1 is ON (OFF)) is set in \$B014.

HSEN 1 ON

Checks whether sensor 1 is turned ON at completion of HSEN instruction. The result (0: gripper sensor 1 is OFF, 1: gripper sensor 1 is ON) is set in \$B014.

HSEN 1 ON T=10.00

Waits 10 seconds for gripper sensor 1 to turn ON. Sets the result 1 (grripper sensor 1 is ON) in \$B014 if the sensor input turns ON. Sets the result 0 (grripper sensor 1 is OFF) if the sensor does not turn ON after 10 seconds.

To observe the \$B014 contents with an IF statement, use the GETS instruction to read the contents to a B variable.

10.1.4 Handling Window

1. Select {ROBOT} under the main menu.
2. Select {HANDLING DIAG}.
 - The HANDLING window appears.



3. Select "F1 KEY ALLOCATION" or "F2 KEY ALLOCATION," and then edit.

– The selection dialog box appears.



– If a signal from {HAND1} to {HAND4} is selected, the key allocation to the corresponding gripper valve signal can be modified. (In the following example, {HAND3} is selected in the "F2 KEY

ALLOCATION.”)

When HAND3 is set for the “F2 KEY ALLOCATION”

F1 KEY ALLOCATION	HAND3-1
F2 KEY ALLOCATION	HAND3-2
TOOL SHOCK SENSOR FUNC	NOT USED
TOOL SHOCK SENSOR INPUT	VALID

- When {USER OUT} is selected, the output number of user signal is asked.

F1 KEY ALLOCATION	HAND3-1
F2 KEY ALLOCATION	
TOOL SHOCK SENSOR FUNC	NOT USED
TOOL SHOCK SENSOR INPUT	VALID

- Input desired number with Numeric keys and press [ENTER] to change the allocation of user output signal.

F1 KEY ALLOCATION	HAND3-1
F2 KEY ALLOCATION	OUT#0117
TOOL SHOCK SENSOR FUNC	NOT USED
TOOL SHOCK SENSOR INPUT	VALID

SUPPLEMENT An error message is displayed if the input number lies outside the designated range. Press [CANCEL] to cancel the modification of the key allocation. If [f•1] or [f•2] and [INTERLOCK] are pressed simultaneously, the output of the designated signal is switched ON and OFF.

NOTE The “-1” gripper valve signals can be allocated to [f•1] and the “-2” gripper valve signals can be allocated to [f•2].

4. Select “SHOCK SENSOR FUNC” or “SHOCK SENSOR INPUT,” and then edit.

- If “SHOCK SENSOR FUNC” is selected, “USED” and “NOT USED” are alternately displayed.
 If “SHOCK SENSOR INPUT” is selected, “VALID” and “INVALID” are alternately displayed.
 The displayed state is the current setting.

SHOCK SENSOR FUNC	: NOT USED
SHOCK SENSOR INPUT	: VALID

10.1.5 Shock Sensor Function

If “SHOCK SENSOR FUNC” is “USED” in the HANDLING window, the shock sensor is enabled. When the shock sensor does not exist, set “NOT USED.”

10.1.6 Shock Sensor Input Signal

- Function
When this signal turns OFF, “SHOCK SENSOR WORKING” is displayed on the programming pendant and the system enters HOLD status.
- Signal Condition
The signal is normally an ON (NC) signal.
- How to Use the Signal
Input the shock sensor output signal to #20026 (CN309-B2 of YIU01).

10.1.7 Shock Sensor Input Reset

- Function
This function resets the HOLD status and enables the axis operation and [FWD]/[BWD] operations in order to allow the manipulator to be retracted after shock sensor operation.
Set the function on the HANDLING window. If “SHOCK SENSOR FUNC” is “USED” and “SHOCK SENSOR INPUT” is “INVALID” in the teach mode, “SHOCK SENSOR INP. RELEASING” is displayed and the input is disabled. The input is enabled if “SHOCK SENSOR INPUT” is “VALID.”



Refer to *chapter 10.1.4 “Handling Window”* at page 10-4 for details about using this function.

10.1.8 Low Air Pressure Input Signal

- Function
If the air pressure drops, this signal turns ON and triggers a user alarm (system section) in the play mode. In the teach mode, the message “AIR PRESSURE LOWERING” is displayed.
- Signal Condition
The signal is normally an OFF (NO) signal.
- How to Use the Signal
Input the low air pressure signal to #20027 (CN309-A2 of YIU01).
The alarm can be reset by turning OFF the signal and reset the alarm
To perform axis operations while the air pressure is low, set to teach mode and reset the alarm. The above message is displayed, but manipulator operations are possible.

10.2 Registering Instructions

10.2.1 HAND Instruction

This instruction turns ON/OFF the gripper valve signal and controls the tool.

1. Select {JOB} under the main menu.
2. Select {JOB}.
3. Press [TOOL 1 ON/OFF] or [TOOL 2 ON/OFF].
 - “HAND 1 ON” is displayed if [TOOL 1 ON/OFF] is pressed; “HAND 2 ON” is displayed if [TOOL 2 ON/OFF] is pressed in the input buffer line.
 - If “HAND” is selected after pressing [INFORM LIST], “HAND 1 ON” is displayed.



⇒ HAND 1 ON

- To register the instruction shown in the input buffer line without editing, press [INSERT] and then press [ENTER].
4. Select the gripper number and edit.
 - The input line is displayed.



Tool_no=
⇒ HAND 1 ON

- Input the gripper number with the Numeric keys, and press [ENTER].



⇒ HAND 1 ON

5. Select the gripper output status and edit.
 - If the UP or DOWN ARROW cursor is pressed together with [SHIFT], “ON” and “OFF” are alternately displayed.



⇒ HAND 1 OFF

- If no settings are to be made for other additional items, press [INSERT] and then press [ENTER]. The HAND instruction is registered.

6. Edit the valve simultaneous control.

- If inserting a valve simultaneous control (to make the gripper valve 1 output same as the valve 2 output), select “HAND.”

⇒ **HAND** 1 OFF

- The DETAIL EDIT window appears.
Select “VALVE SIM CTRL.”



- The selection dialog box appears.



- Select “ALL.”
The data of “VALVE SIM CTRL” items change to the “ALL” and the “ALL” tag is added to the input buffer data.



- Press [ENTER] to display the JOB CONTENT window.

7. Press [INSERT].

8. Press [ENTER].

10.2.2 HSEN Instruction

This instruction monitors the various inputs used for handling and outputs the monitor result as a variable.

1. Select {JOB} under the main menu.
2. Select {JOB}.
3. Press [INFORM LIST].
4. Select the HSEN instruction.
 - The HSEN instruction is displayed in the input buffer line.



- To register the instruction shown in input buffer line without editing, press [INSERT] and then press [ENTER].
5. Select the sensor number and edit.
 - The input line is displayed.



- Input the sensor number with the Numeric keys, and press [ENTER].



6. Select the sensor input status and edit.
 - If the UP or DOWN ARROW cursor is pressed together with [SHIFT], “ON” and “OFF” are alternately displayed.



- If no settings are to be made for other additional items, press [INSERT] and then press [ENTER]. The HSEN instruction is registered.

7. Edit the signal waiting time.
 - If inserting a signal waiting time, select “HSEN.”



The DETAIL EDIT window appears.

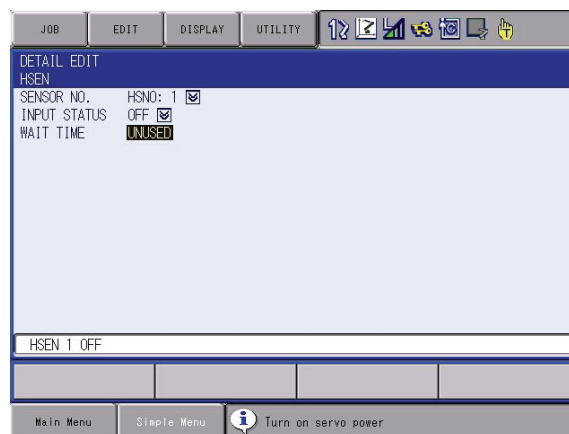

- Select “UNUSED.”
The selection dialog box appears.

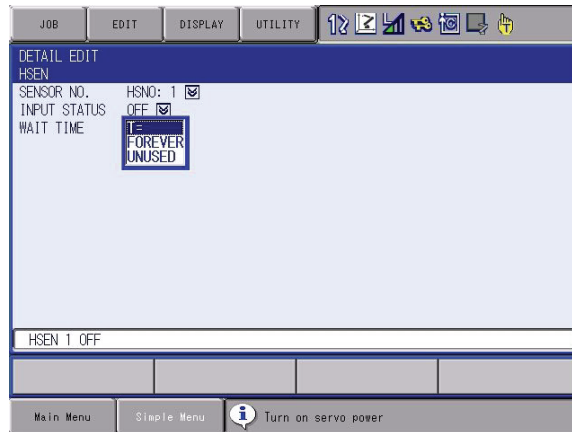

- Select “T=.”

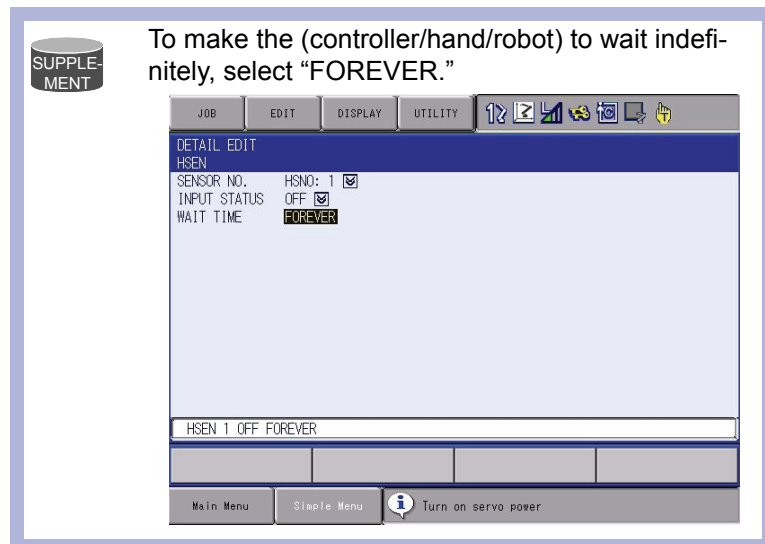

- The data of “WAIT TIME” item changes to the “T=” and the number item is displayed to the right of that.

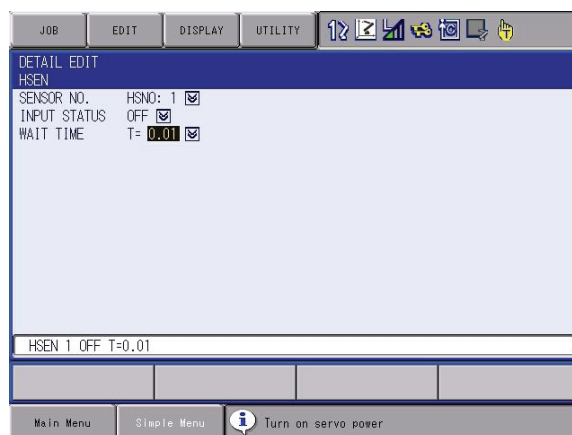

- Select the number item.

- The input line appears. Type the number with the Numeric keys.

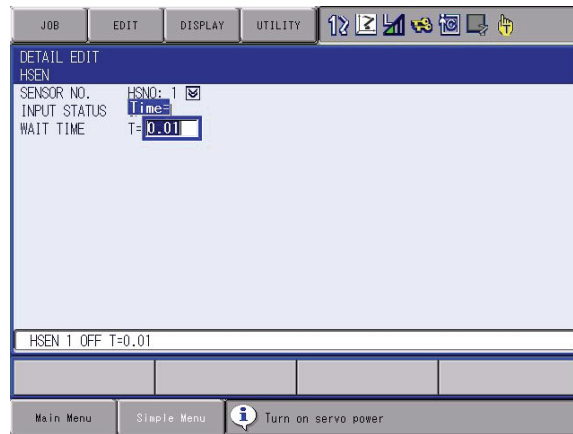

- Press [ENTER] to display the number value input into the input buffer line.

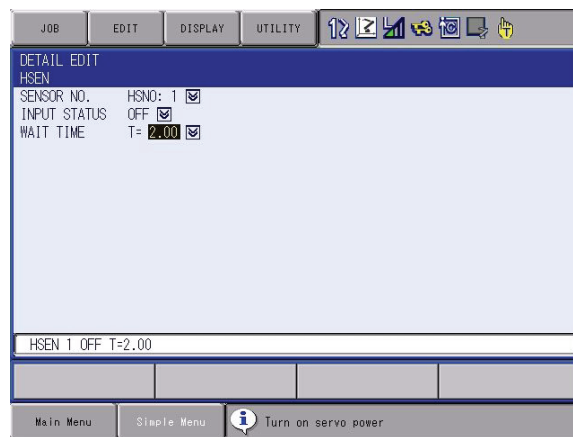

- Press [ENTER] to display the JOB CONTENT window.
8. Press [INSERT].
 9. Press [ENTER].

10.3 Table of Work Instructions

- <> indicates alpha-numerical data.
- If multiple items are shown in one additional item section, select one.

Table 10-3: Handling Instructions

HAND	Function	Turns ON/OFF signals to the gripper valves to open and close grippers.	
	Additional Item	# <Device number>	#1 or #2 Set when two manipulators are used for handling.
		<Gripper Number>	1 to 4 Required.
		<Gripper Output Status>	ON or OFF Required.
		ALL	Valve simultaneous control Used to turn gripper valves 1 and 2 ON or OFF simultaneously if a 3P solenoid is used.
Example	HAND 1 ON HAND #1 1 OFF ALL		
HSEN	Function	Monitors the sensor inputs used for handling applications and outputs the monitored results to variable \$B014.	
	Additional Item	\$B014	Result variable. Cannot be displayed on screen.
		# <Device number>	#1 or #2 Set when two manipulators are used for handling.
		<Gripper Sensor Number>	1 to 8 Required.
		<Sensor Input Status>	ON or OFF Required.
		T=<signal waiting time> or FOREVER	T:0.01 to 655.35 seconds FOREVER: Unlimited time. If omitted, T=0.
Example	HSEN 1 ON FOREVER HSEN #2 1 OFF HSEN 1 ON T=10.00		

11 Table of Basic Instructions

- <> indicates numerical or alphabetical data.
- If multiple items are shown in one section, select one of the items.

11.1 Move Instructions

MOVJ	Function	Moves to a taught point with joint interpolation type.	
	Additional Item	Position data, Base axis position data, Station axis position data	These data do not appear on the screen.
		VJ=<play speed>	VJ: 0.01 to 100.00%
		PL=<position level>	PL:0 to 8
		NWAIT	
		UNTIL statement	
		ACC=(acceleration adjustment ratio)	ACC: 20 to 100%
		DEC=(deceleration adjustment ratio)	DEC: 20 to 100%
Example	MOVJ VJ=50.00 PL=2 NWAIT UNTIL IN#(16)=ON		
MOVL	Function	Moves to a taught point with linear interpolation type.	
	Additional Item	Position data, Base axis position data, Station axis position data	These data do not appear on the screen.
		V=<play speed>, VR=<play speed of the posture>, VE=<play speed of external axis>	V:0.1 to 1500.0 mm/s 1 to 9000.0 cm/min VR:0.1 to 180.0 deg/s VE:0.01 to 100.00%
		PL=<position level>	PL:0 to 8
		CR=(corner radius)	CR: 1.0 to 6553.5mm
		NWAIT	
		UNTIL statement	
		ACC=(acceleration adjustment ratio)	ACC: 20 to 100%
DEC=(deceleration adjustment ratio)	DEC: 20 to 100%		
Example	MOVL V=138 PL=0 NWAIT UNTIL IN#(16)=ON		
MOVC	Function	Moves to a taught point with circular interpolation type.	
	Additional Item	Position data, Base axis position data, Station axis position data	These data do not appear on the screen.
		V=<play speed>, VR=<play speed of the posture>, VE=<play speed of external axis>	Same as MOVL.
		PL=<position level>	PL:0 to 8
		NWAIT	
		ACC=(acceleration adjustment ratio)	ACC: 20 to 100%
		DEC=(deceleration adjustment ratio)	DEC: 20 to 100%
Example	MOVC V=138 PL=0 NWAIT		

MOVS	Function	Moves to a taught point with spline interpolation type.	
	Additional Item	Position data, Base axis position data, Station axis position data	These data do not appear on the screen.
		V=<play speed>, VR=<play speed of the posture>, VE=<play speed of external axis>	Same as MOVL.
		PL=<position level>	PL:0 to 8
		NWAIT	
		ACC=(acceleration adjustment ratio)	ACC: 20 to 100%
		DEC=(deceleration adjustment ratio)	DEC: 20 to 100%
Example	MOVS V=120 PL=0		
IMOV	Function	Moves the specified increment from the current position with linear interpolation type.	
	Additional Item	P<variable number>, BP<variable number>, EX<variable number>	
		V=<play speed>, VR=<play speed of the posture>, VE=<play speed of external axis>	Same as MOVL.
		PL=<position level>	PL:0 to 8
		NWAIT	
		BF,RF,TF,UF# (<user coordinate number>)	BF: base coordinates RF: robot coordinates TF: tool coordinates UF: user coordinates
		UNTIL statement	
		ACC=(acceleration adjustment ratio)	ACC: 20 to 100%
DEC=(deceleration adjustment ratio)	DEC: 20 to 100%		
Example	IMOV P000 V=138 PL=1 RF		
REFP	Function	Defines a reference point (e.g. wall point for weaving).	
	Additional Item	<reference point number>	wall point 1 for weaving :1 wall point 2 for weaving :2
		Position data, Base axis position data, Station axis position data	These data do not appear on the screen.
Example	REFP 1		
SPEED	Function	Sets play speed.	
	Additional Item	VJ=<joint speed>, V=<TCP speed>, VR=<play speed of the posture>, VE=<play speed of external axis>	VJ:Same as MOVJ. V,VR,VE: Same as MOVL.
	Example	SPEED VJ=50.00	

11.2 I/O Instructions

DOUT	Function	Turns the external output signals ON and OFF.	
	Additional Item	OT# (<output number>), OGH# (<output group number>), OG# (<output group number>)	
		Number of addressed output signals: OT#(xx)=1;OGH#(xx)=4(per group); OG#(xx)=8(per group)	
	OGH#(xx) is not subject to parity check; only the binary specification is allowed.		
	FINE		With a high degree of accuracy
	Example	DOUT OT#(12) ON	
PULSE	Function	Outputs a pulse signal as an external output signal.	
	Additional Item	OT# (<output number>), OGH# (<output group number>), OG# (<output group number>)	
		T=<time (seconds)>	0.01 to 655.35 s 0.30 s unless otherwise specified
Example	PULSE OT# (10) T=0.60		
DIN	Function	Sets input signals in variables.	
	Additional Item	B<variable number>	
		IN# (<input number>), IGH# (<input group number>), IG# (<input group number>), OT# (<output number>), OGH# (<output group number>), OG# (<output group number>), SIN# (<system input number>), SOUT# (<system output number>)	
	Number of addressed input signals: IN#(xx)=1;IGH#(xx)=4(per group); IG#(xx)=8(per group)		
	Number of addressed output signals: OT#(xx)=1;OGH#(xx)=4(per group); OG#(xx)=8(per group)		
	IGH#(xx) and OGH#(xx) are not subject to parity check; only the binary specification is allowed.		
	Example	DIN B016 IN#(16) DIN B002 IG#(2)	

WAIT	Function	Waits until the external input signal status matches the specified status.	
	Additional Item	IN# (<input number>), IGH# (<input group number>), IG# (<input group number>), OT# (<user output number>), OGH# (<output group number>), SIN# (<system input number>), SOUT# (<system output number>)	
		<status>,B<variable number>	
		T=<time (seconds)>	0.01 to 655.35 s
Example	WAIT IN# (12)=ON T=10.00 WAIT IN# (12)=B002		
AOUT	Function	Outputs the specified voltage to the general-purpose analog output port.	
	Additional Item	AO# (<output port number>)	1 to 40
		<output voltage(V)>	-14.0 to 14.0
Example	AOUT AO# (2) 12.7		
ARATION	Function	Starts the analog output corresponding to the speed.	
	Additional Item	AO#(<output port number>)	1 to 40
		BV = <basic voltage>	-14.00 to 14.00
		V = <basic speed>	0.1 to 150.0 mm/s 1 to 9000 cm/min
		OFV = <offset voltage>	-14.00 to 14.00
Example	ARATION AO#(1) BV=10.00 V=200.0 OFV=2.00		
ARATIOF	Function	Ends the analog output corresponding to the speed.	
	Additional Item	AO#(<output port number>)	1 to 40
	Example	ARATIOF AO#(1)	

11.3 Control Instructions

JUMP	Function	Jumps to the specified label or job.	
	Additional Item	* <label character string>, JOB:<job name>, IG# (<input group number>), B<variable number>, I<variable number>, D<variable number>	
		UF# (user coordinates number)	
		IF statement	
Example	JUMP JOB:TEST1 IF IN#(14)=OFF		
* (label)	Function	Indicates a jump destination.	
	Additional Item	<jump destination>	8 characters or less
	Example	*123	
CALL	Function	Calls the specified job.	
	Additional Item	JOB:<job name>, IG# (<input group number>), B<variable number>, I<variable number>, D<variable number>	
		UF# (user coordinates number)	
		IF statement	
Example	CALL JOB:TEST1 IF IN# (24)=ON CALL IG#(2) (The job is called by the patterns of input signal. In this example, Job 0 cannot be called.)		
RET	Function	Returns to the call source job.	
	Additional Item	IF statement	
	Example	RET IF IN#(12)=OFF	
END	Function	Declares the end of a job.	
	Additional Item		
	Example	END	
NOP	Function	No operation.	
	Additional Item		
	Example	NOP	
TIMER	Function	Stops for the specified time.	
	Additional Item	T=<time (seconds)>	0.01 to 655.35 s
	Example	TIMER T=12.50	
IF statement	Function	Evaluates the specified condition and makes a judgment accordingly. Described after an instruction that specifies a certain action. Format:<Item1>=<,<>,<=>=<,>><Item2>	
	Additional Item	<Item1>	
		<Item2>	
Example	JUMP *12 IF IN#(12)=OFF		

UNTIL statement	Function	Monitors the specified input signal during an action and stops the action when the specified signal status is observed. Described after an instruction that specifies a certain action.	
	Additional Item	IN# (<input number>)	
		<status>	
Example	MOVL V=300 UNTIL IN#(10)=ON		
PAUSE	Function	Instructs a pause.	
	Additional Item	IF statement	
	Example	PAUSE IF IN#(12)=OFF	
' (comment)	Function	Displays a comment.	
	Additional Item	<comment>	32 characters or less
		Example	'Draws 100mm size square.
CWAIT	Function	Waits for execution of the instruction on the next line. Used with the NWAIT tag which is an additional item of a move instruction.	
	Additional Item		
	Example	MOVL V=100 NWAIT DOUT OT#(1) ON CWAIT DOUT OT#(1) OFF MOVL V=100	
ADVINIT	Function	Initializes the prereading instruction processing. Used to adjust the access timing for variable data.	
	Additional Item		
	Example	ADVINIT	
ADVSTOP	Function	Stops the prereading instruction processing. Used to adjust the access timing for variable data.	
	Additional Item		
	Example	ADVINIT	

11.4 Shift Instructions

SFTON	Function	Starts a shift operation.		
	Additional Item	P<variable number>, BP<variable number>, EX<variable number>, BF,RF,TF, UF#(<user coordinate number>)	BF: base coordinates RF: robot coordinates TF: tool coordinates UF: user coordinates	
	Example	SFTON P001 UF#(1)		
SFTOF	Function	Stops a shift operation.		
	Additional Item			
	Example	SFTOF		
MSHIFT	Function	Obtains the shift value in the specified coordinate system from Data 2 and 3, and stores the obtained element values in Data 1. Format:MSHIFT <Data1><Coordinate><Data2><Data3>		
	Additional Item	Data1	PX<variable number>	
		Coordinate	BF,RF,TF, UF# (<user coordinate number>), MTF	BF: base coordinates RF: robot coordinates TF: tool coordinates UF: user coordinates MTF: tool coordinates for the master
		Data2	PX<variable number>	
		Data3	PX<variable number>	
	Example	MSHIFT PX000 RF PX001 PX002		

11.5 Operating Instructions

ADD	Function	Adds Data1 and Data2, and stores the result in Data1. Format:ADD<Data1><Data2>		
	Additional Item	Data1	B<variable number>, I<variable number>, D<variable number>, R<variable number>, P<variable number>, BP<variable number>, EX<variable number>	Data1 must always be a variable.
		Data2	Constant, B<variable number>, I<variable number>, D<variable number>, R<variable number>, P<variable number>, BP<variable number>, EX<variable number>	
	Example	ADD I012 I013		
SUB	Function	Subtracts Data2 from Data1, and stores the result in Data1. Format:SUB<Data1><Data2>		
	Additional Item	Data1	B<variable number>, I<variable number>, D<variable number>, R<variable number>, P<variable number>, BP<variable number>, EX<variable number>	Data1 must always be a variable.
		Data2	Constant, B<variable number>, I<variable number>, D<variable number>, R<variable number>, P<variable number>, BP<variable number>, EX<variable number>	
	Example	SUB I012 I013		

MUL	Function	Multiplies Data1 by Data2, and stores the result in Data1. Format: MUL<Data1><Data2>		
		Data1 can be an element in a position variable. Pxxx(0):all axis data, Pxxx(1):X-axis data, Pxxx(2):Y-axis data, Pxxx(3):Z-axis data, Pxxx(4):Tx-axis data, Pxxx(5):Ty-axis data, Pxxx(6):Tz-axis data		
	Additional Item	Data1	B<variable number>, I<variable number>, D<variable number>, R<variable number>, P<variable number> (<element number>), BP<variable number> (<element number>), EX<variable number> (<element number>)	Data1 must always be a variable.
		Data2	Constant, B<variable number>, I<variable number>, D<variable number>, R<variable number>	
Example	MUL I012 I013 MUL P000 (3) 2 (Multiply the Z-axis data by 2.)			
DIV	Function	Divides Data1 by Data2, and stores the result in Data1. Format: DIV<Data1><Data2>		
		Data1 can be an element in a position variable. Pxxx(0):all axis data, Pxxx(1):X-axis data, Pxxx(2):Y-axis data, Pxxx(3):Z-axis data, Pxxx(4):Tx-axis data, Pxxx(5):Ty-axis data, Pxxx(6):Tz-axis data		
	Additional Item	Data1	B<variable number>, I<variable number>, D<variable number>, R<variable number>, P<variable number> (<element number>), BP<variable number> (<element number>), EX<variable number> (<element number>)	Data1 must always be a variable.
		Data2	Constant, B<variable number>, I<variable number>, D<variable number>, R<variable number>	
Example	DIV I012 I013 DIV P000 (3) 2 (Divide the Z-axis data by 2.)			
INC	Function	Increments the value of the specified variable by 1.		
	Additional Item	B<variable number>, I<variable number>, D<variable number>		
	Example	INC I043		
DEC	Function	Decrements the value of the specified variable by 1.		
	Additional Item	B<variable number>, I<variable number>, D<variable number>		
	Example	DEC I043		

AND	Function	Obtains the AND of Data1 and Data2, and stores the result in Data1. Format:AND<Data1><Data2>		
	Additional Item	Data1	B<variable number>	
		Data2	B<variable number>, Constant	
Example	AND B012 B020			
OR	Function	Obtains the OR of Data1 and Data2, and stores the result in Data1. Format:OR<Data1><Data2>		
	Additional Item	Data1	B<variable number>	
		Data2	B<variable number>, Constant	
Example	OR B012 B020			
NOT	Function	Obtains the NOT of Data2, and stores the result in Data1. Format:NOT<Data1><Data2>		
	Additional Item	Data1	B<variable number>	
		Data2	B<variable number>, Constant	
Example	NOT B012 B020			
XOR	Function	Obtains the exclusive OR of Data1 and Data2, and stores the result in Data1. Format:XOR<Data1><Data2>		
	Additional Item	Data1	B<variable number>	
		Data2	B<variable number>, Constant	
Example	XOR B012 B020			
SET	Function	Sets Data2 to Data1. Format:SET<Data1><Data2>		
	Additional Item	Data1	B<variable number>, I<variable number>, D<variable number>, R<variable number>, P<variable number>, S<variable number>, BP<variable number>, EX<variable number>	Data1 must always be a variable.
		Data2	Constant, B<variable number>, I<variable number>, D<variable number>, R<variable number>, S<variable number>, EXPRESS	
Example	SET I012 I020			
SETE	Function	Sets data to an element in a position variable.		
	Additional Item	Data 1	P<variable number> (<element number>), BP<variable number> (<element number>), EX<variable number> (<element number>)	
		Data 2	D<variable number>, <double-precision integer type constant>	
Example	SETE P012 (3) D005			

GETE	Function	Extracts an element in a position variable.	
	Additional Item	D<variable number>	
		P<variable number> (<element number>), BP<variable number> (<element number>), EX<variable number> (<element number>)	
Example	GETE D006 P012 (4)		
GETS	Function	Sets a system variable to the specified variable.	
	Additional Item	B<variable number>, I<variable number>, D<variable number>, R<variable number>, PX<variable number>	
		\$B<variable number>, \$I<variable number>, \$D<variable number>, \$R<variable number>, \$PX<variable number>, \$ERRNO, Constant, B<variable number>	System variable
Example	GETS B000 \$B000 GETS I001 \$I[1] GETS PX003 \$PX001		
CNVRT	Function	Converts the position variable (Data2) into a position variable of the specified coordinate system, and stores the converted variable in Data1. Format:CNVRT<Data1><Data2><coordinate>	
	Additional Item	Data1	PX<variable number>
		Data2	PX<variable number>
		BF,RF,TF,UF# (<user coordinate number>),MTF	BF: base coordinates RF: robot coordinates TF: tool coordinates UF: user coordinates MTF:tool coordinates for the master
Example	CNVRT PX000 PX001 BF		

CLEAR	Function	Starting with the variable number in Data1, clears (sets to zero) as many variables as specified by a number in Data2. Format: CLEAR<Data1><Data2>		
	Additional Item	Data1	B<variable number>, I<variable number>, D<variable number>, R<variable number>, \$B<variable number>, \$I<variable number>, \$D<variable number>, \$R<variable number>,	
		Data2	<number of variables>, ALL, STACK	ALL: Clears variables of the variable number in Data1 and of all the variable numbers that follow. STACK: Clears all variables in the job call stack.
	Example	CLEAR B000 ALL CLEAR STACK		
SIN	Function	Obtains the sine of Data2, and stores the result in Data1. Format: SIN<Data1><Data2>		
	Additional Item	Data1	R<variable number>	Data1 must always be a real type variable.
		Data2	<constant>, R<variable number>	
	Example	SIN R000 R001 (Sets the sine of R001 to R000.)		
COS	Function	Obtains the cosine of Data2, and stores the result in Data1. Format: COS<Data1><Data2>		
	Additional Item	Data1	R<variable number>	Data1 must always be a real type variable.
		Data2	<constant>, R<variable number>	
	Example	COS R000 R001 (Sets the cosine of R001 to R000.)		
ATAN	Function	Obtains the arc tangent of Data2, and stores the result in Data1. Format: ATAN<Data1><Data2>		
	Additional Item	Data1	R<variable number>	Data1 must always be a real type variable.
		Data2	<constant>, R<variable number>	
	Example	ATAN R000 R001 (Sets the arc tangent of R001 to R000.)		
SQRT	Function	Obtains the square root of Data2, and stores the result in Data1. Format: SQRT<Data1><Data2>		
	Additional Item	Data1	R<variable number>	Data1 must always be a real type variable.
		Data2	<constant>, R<variable number>	
	Example	SQRT R000 R001 (Sets the square root of R001 to R000.)		

MFRAME	Function	Creates a user coordinate using the position data for the given three points as definition points. <Data1> indicates the definition point ORG position data, <Data2> the definition point XX position data, and <Data3> the definition point XY position data. Format: MFRAME <user coordinate> <Data1> <Data2> <Data3>		
	Additional Item	UF#(<user coordinate number>)	1 to 24	
		Data1	PX <variable number>	
		Data2	PX <variable number>	
	Example	MFRAME UF#(1) PX000 PX001 PX002		
MULMAT	Function	Obtains the matrix product of Data2 and Data3, and stores the result in Data1. Format: MULMAT <Data1> <Data2> <Data3>		
	Additional Item	Data1	P <variable number>	
		Data2	P <variable number>	
		Data3	P <variable number>	
	Example	MULMAT P000 P001 P002		
INVMAT	Function	Obtains the inverse matrix of Data2, and stores the result in Data1. Format: INVMAT <Data1> <Data2>		
	Additional Item	Data1	P <variable number>	
		Data2	P <variable number>	
	Example	INVMAT P000 P001		
SETFILE	Function	Changes the contents data of a condition file into the numeric data of Data1. The contents data of a condition file to be changed is specified by the element number.		
	Additional Item	Contents data of a condition file	WEV#(<condition file number>)(<element number>)	
		Data1	Constant, D<variable number>	
	Example	SETFILE WEV#(1)(1) D000		
GETFILE	Function	Stores the contents data of a condition file in Data1. The contents data of a condition file to be obtained is specified by the element number.		
	Additional Item	Data1	D <variable number>	
		Contents data of a condition file	WEV#(<condition file number>)(<element number>)	
	Example	GETFILE D000 WEV#(1)(1)		
GETPOS	Function	Stores the position data of Data2 (step number) in Data1.		
	Additional Item	Data1	PX <variable number>	
		Data2	STEP# (<step number>)	
	Example	GETPOS PX000 STEP#(1)		
VAL	Function	Converts the numeric value of the character string (ASCII) of Data2 into the real number, and stores the result in Data1. Format: VAL <Data1> <Data2>		
	Additional Item	Data1	B <variable number>, I <variable number>, D <variable number>, R <variable number>	
		Data2	Character string, S <variable number>	
	Example	VAL B000 "123"		

ASC	Function	Obtains the character code of the first letter of the character string (ASCII) of Data2, and stores the result in Data1. Format:ASC<Data1><Data2>		
	Additional Item	Data1	B <variable number>, I <variable number>, D <variable number>	
		Data2	Character string, S <variable number>	
	Example	ASC B000 "ABC"		
CHR\$	Function	Obtains the character (ASCII) with the character code of Data2, and stores the result in Data1. Format:CHR\$<Data1><Data2>		
	Additional Item	Data1	S <variable number>	
		Data2	Constant, B <variable number>	
	Example	CHR\$ S000 65		
MID\$	Function	Obtains the character string (ASCII) of any length (Data 3, 4) from the character string (ASCII) of Data2, and stores the result in Data1. Format:MID\$<Data1><Data2><Data3><Data4>		
	Additional Item	Data1	S <variable number>	
		Data2	Character string, S <variable number>	
		Data3	Constant, B <variable number>, I <variable number>, D <variable number>	
		Data4	Constant, B <variable number>, I <variable number>, D <variable number>	
	Example	MID\$ S000 "123ABC456" 4 3		
LEN	Function	Obtains the total number of bytes of the character string (ASCII) of Data2, and stores the result in Data1. Format:LEN<Data1><Data2>		
	Additional Item	Data1	B <variable number>, I <variable number>, D <variable number>	
		Data2	Character string, S <variable number>	
	Example	LEN B000 "ABCDEF"		
CAT\$	Function	Combines the character string (ASCII) of Data2 and Data3, and stores the result in Data1. Format:CAT\$<Data1><Data2><Data3>		
	Additional Item	Data1	S <variable number>	
		Data2	Character string, S <variable number>	
		Data3	Character string, S <variable number>	
	Example	CAT\$ S000 "ABC" "DEF"		

Symbols

' (comment)	11-6
* (label)	11-5

Numerics

2P (double-solenoid)	10-2
3P (triple-position solenoid)	10-2

A

ADD	11-8
Additional Items	3-5
ADVINIT	11-6
ADVSTOP	11-6
ALARM HISTORY	1-24
Alarm history data	7-8
Alphanumeric input	1-19
ANALOG MONITOR	1-24
AND	11-10
ANGLE	9-32
AOUT	11-4
Application parameter	7-8
approach point	9-30
ARATIOF	11-4
ARATION	11-4
Arc end condition data	7-7
Arc monitor data	7-8
Arc start condition data	7-7
ARM CONTROL	1-24
ATAN	11-12
AUTO BACKUP SET	1-25
Axis keys	1-2

B

Base axes	1-13
Batch selection	7-43
batch selection	7-43

C

CALL	11-5
Cartesian Coordinates	1-14, 2-2, 2-6
CAT\$	11-14
Character Input Operation	1-18
Check Mode Operation	4-13
CHR\$	11-14
CIO program	7-8
Circular Interpolation	3-8
CLEAR	11-12

CIO parameter.....	7-8
CNVRT.....	11-11
COMMAND POSITION.....	1-24
COMMAND POSITION window.....	3-43
Comments.....	3-5
Continuous.....	1-14
Continuous Circular Arcs.....	3-8
Converter parameter.....	7-8
Coordinate home position parameter.....	7-8
Copying.....	3-61
Copying Jobs.....	5-2
COS.....	11-12
CREATE NEW JOB.....	1-23
CURRENT POSITION.....	1-24
Cursor.....	3-5
Cursor key.....	1-2
Cutting.....	3-61
CWAIT.....	11-6
Cycle.....	1-14
Cylindrical Coordinates.....	1-14, 2-2, 2-7

D

DATE/TIME.....	1-25
DEC.....	11-9
DELETE.....	1-24
Deleting a file.....	7-42
Deleting a job.....	7-41
Deleting Additional Items.....	3-57
Deleting Instructions.....	3-50
Deleting Jobs.....	5-6
DEVICE.....	1-24
Device.....	10-12
Device number.....	10-12
DIN.....	11-3
DIV.....	11-9
DOUT.....	11-3
DROP AMOUNT.....	1-24
Dry-run Speed Operations.....	4-12

E

Edit Mode.....	1-14, 1-22
Editing Comments.....	5-12
Editing Condition Files.....	3-70
Editing Interpolation Type.....	3-69
Editing Play Speed.....	3-65
Emergency Stop.....	4-16
Emergency Stop Button.....	1-2, 3-1
Enable switch.....	1-2
END.....	11-5
Enter key.....	1-2
Example for General Purpose Application.....	9-20
External Axis.....	2-14
External Memory Devices.....	7-1

F

FD/CF	1-24
FOLDER	1-24
FORMAT	1-24
Frequency	9-32
Function definition parameter	7-8
Function Keys	1-2, 10-1

G

GENERAL DIAGNOSIS window	9-26
General-purpose display area	1-2
GETE	11-11
GETFILE	11-13
GETPOS	11-13
GETS	11-11
Gripper Number	10-12
Gripper Output Status	10-12
Gripper Sensor Numbe	10-12
gripper valve signal	10-1, 10-7
GRP COMBINATION	1-25

H

HAND	10-12
HAND Instruction	10-7
HANDLING window	10-1
High Speed	1-14
Hold	4-15
Hold at the Station	4-35
Hold button	1-2
Hold by External Input Signal (System Input)	4-34
HOME POSITION	1-24
Home position calibrating data	7-8
HSEN	10-12
HSEN Instruction	10-9
human interface display area	1-16

I

I/O MSG HISTORY	1-24
I/O name data	7-8
IF	11-5
IMOV	11-2
IN/OUT	1-23
INC	11-9
Inching	1-14
Individual selection	7-43
Initial Folder Setting	7-14
Inserting Additional Items	3-56
Inserting Instructions	3-47
Insertion slot for Compact Flash	1-2
Instruction Group	3-46

Instruction Search.....	3-95
INTERFERENCE.....	1-24
Interpolation Type.....	3-6
INVMAT.....	11-13

J

JOB.....	1-23
JOB CAPACITY	1-23
JOB CAPACITY window.....	3-44
JOB CONTENT window	3-42
JOB HEADER window	3-41
Joint Coordinates.....	1-14, 2-2, 2-5
Joint Interpolation	3-6
JUMP	11-5

K

KEY ALLOCATION.....	1-25
---------------------	------

L

Label Search.....	3-93
LEN.....	11-14
LIMIT RELEASE.....	1-24
Limited Speed Operations	4-12
Line Numbers.....	3-5
Line Search.....	3-91
Linear Interpolation	3-7
LOAD	1-24
Loading a Condition File or General Data	7-30
Loading a Job	7-28
Loading a Parameter	7-31
Loading All CMOS Data	7-37
Loading All User's Programs.....	7-36
Loading I/O Data	7-33
Loading System Data.....	7-34
Local Variables.....	3-87
Low Air Pressure Input Signal.....	10-6
Low Speed.....	1-14
Low Speed Operation	4-11

M

Machine Lock Operation.....	4-13
Main Menu Area	1-13
Major Alarms.....	4-18
major alarms	4-18
Management Mode.....	1-14, 1-22
Manipulator Coordinate Systems and Operations	2-1
MANIPULATOR TYPE.....	1-24
Manipulator Types	3-82

Manual Speed	1-14, 3-25
manual speed keys	1-2
MASTER JOB	1-23
Medium Speed	1-14
menu area	1-2, 1-16
MFRAME	11-13
MID\$	11-14
Minor Alarms	4-18
Mirror Shift Function	6-45
Mode switch	1-2
Modification of Speed Type	3-65
Modifying Additional Items	3-55
Modifying Additional Numeric Data	3-54
Modifying Instructions	3-50
Modifying Job Names	5-8
MONITORING TIME	1-24
Motion function parameter	7-8
Motion Type key	1-2
Motor gun dry spot pressure data	7-7
Motor gun pressure power data	7-7
MOV C	11-1
Move Instructions	3-11
MOV J	11-1
MOV L	11-1
MOV S	11-2
MSHIFT	11-7
MUL	11-9
MULMAT	11-13

N

NEW JOB CREATE window	9-2
NOP	11-5
NOT	11-10
Numeric keys	1-2

O

OPERATE COND	1-25, 4-24
Operation control parameter	7-8
Operation Cycle	4-7
Operation Flow	7-11
Operation for Tool Control	9-25
Operation Mode	1-14, 1-22
OR	11-10
OVERRUN&S-SENSOR	1-24

P

Page key	1-2
PAM Function	6-37
Parallel Shift Function	6-3
Parallel Shift Job Conversion Function	6-16
PARAMETER	1-24
Pasting	3-62

PATTERN.....	9-32
PAUSE.....	11-6
Play Mode.....	1-21
Play Speed.....	3-6
Playback.....	4-1, 9-19
Position Level.....	3-14
POWER ON/OFF POS.....	1-24
Power Source characteristic data.....	7-7
Power Source characteristic definition data.....	7-7
Programming Pendant.....	1-2
Programming Pendant Display.....	1-11
Prohibiting Weaving.....	9-35
PULSE.....	11-3
pulse mirror-shift function.....	6-45

R

Reference Point Instructions.....	3-17
REFP.....	11-2
Registering a job.....	3-2
Registering Control Groups.....	3-3
Relative Modification.....	3-65
Remote Mode.....	1-21
RES. START(CNCT).....	1-25, 4-26
RES. START(JOB).....	1-23
RES. STATUS.....	1-23, 4-32
RESERVE JOB NAME.....	1-25
reserved job.....	9-25
reserved start.....	4-23
RESET RESERVATION.....	4-33
Restart.....	4-15
RET.....	11-5
Reverse Pasting.....	3-63
ROBOT.....	1-24
Robot Axes.....	1-13
Robot matching parameter.....	7-7
robot-coordinates mirror-shift function.....	6-45

S

SAVE.....	1-24
Saving a Condition File or General Data.....	7-18
Saving a Job.....	7-16
Saving a Parameter.....	7-20
Saving All CMOS Data.....	7-26
Saving All Data in CMOS Area.....	7-27
Saving All User's Programs.....	7-25
Saving I/O Data.....	7-22
Saving System Data.....	7-23
SECOND HOME POS.....	1-24
Second home position.....	7-8
SECURITY.....	1-24
Security Mode.....	1-22
SELECT JOB.....	1-23
Select key.....	1-2
Selecting a Folder.....	7-12
Selecting the Range.....	3-60
Selecting Tool.....	2-11

Sensor Input Status.....	10-12
Sensor Number	10-3
Sensor parameter	7-8
SERVO MONITOR	1-24
SERVO ON READY	9-1
Servo parameter	7-8
Servo power block parameter.....	7-8
Servomotor parameter.....	7-8
SERVOPACK parameter	7-8
SET	11-10
SET SPEED	1-25
SETE	11-10
SETFILE	11-13
SETUP	1-25
SFTOF.....	11-7
SFTON	11-7
Shock detection level data	7-7
Shock Sensor Function	10-6
Shock Sensor Input Reset	10-6
Shock Sensor Input Signal.....	10-6
Short/Full open position data.....	7-7
Signal Waiting time	10-12
Signal waiting time	10-3
signal waiting time.....	10-12
SIN.....	11-12
Single Circular Arc	3-8
Single Spline Curve.....	3-9
SP (single-solenoid).....	10-2
Special Playback Operations	4-11
SPEED	9-31, 11-2
Speed Override	4-20
Spline Interpolation	3-9
Spot gun characteristic data.....	7-7
Spot welding power source characteristic data.....	7-7
SQRT	11-12
START.....	3-1
Start button	1-2
Station Axes.....	1-13
Status Display Area.....	1-13
Step (operation cycle)	1-14
Step Search	3-92
Stop.....	4-15
Stop by Alarm.....	4-18
SUB.....	11-8, 11-14
SV monitor signals	7-8
Symbol Input	1-20
System definition parameter.....	7-7
SYSTEM INFO	1-24
System information	7-8
system matching parameter	7-8

T

Tag Search	3-97
Teach lock	3-1
Teach Mode	1-21
Teaching.....	3-1, 9-1
TEACHING COND	1-25
Test Operations	3-26, 3-64
The.....	9-26
This	9-29

TIMER.....	11-5
TIMER (Timer count)	9-33
Timer Instruction.....	3-18
TOOL.....	1-24
Tool Coordinates	1-14, 2-2, 2-9
Tool data	7-7
TOOLOF.....	9-25, 9-27, 9-37
TOOLON	9-25, 9-27, 9-37
TOOLON instruction	9-25
Transmission (general) parameter.....	7-8
TRT.....	3-67

U

Undo Operation.....	3-37
UNTIL.....	11-6
USER COORDINATE	1-24
User coordinate data.....	7-7
User Coordinates.....	1-14, 2-2, 2-12, 2-13
USER ID.....	1-25
User word registration	7-8
user-coordinates mirror-shift function.....	6-45

V

VAL.....	11-13
valve simultaneous control	10-8
Variable data.....	7-7
Variable name	7-8
VERIFY	1-24
Verifying a File	7-40
Verifying a Job	7-38
Verifying Data	7-38
verifying data.....	7-38

W

WAIT.....	11-4
Weaving Basic Coordinate System.....	9-30
WEAVING CONDITION Window.....	9-31
Weaving data	7-7
Weaving File	9-34
Weaving in the Check Mode	9-35
Weaving Prohibit	4-13
WORK HOME POS	1-24
WRONG DATA LOG.....	1-25
WVOF	9-37
WVOF Instruction	9-29
WVON.....	9-37
WVON Instruction.....	9-29

DX100

Index

X

XOR 11-10

Y

YIU01 10-6

DX100 OPERATOR'S MANUAL

**FOR MATERIAL HANDLING, PRESS TENDING, CUTTING,
AND OTHER APPLICATIONS**

HEAD OFFICE

2-1 Kurosaki-Shiroishi, Yahatanishi-ku, Kitakyusyu-shi, 806-0004, Japan
Phone +81-93-645-7745 Fax +81-93-645-7746

MOTOMAN INC. HEADQUARTERS

805 Liberty Lane, West Carrollton, OH 45449, U.S.A.
Phone +1-937-847-6200 Fax +1-937-847-6277

MOTOMAN ROBOTICS EUROPE AB

Franska Vagen 10, Box 4004, SE-390 04 Kalmar, Sweden
Phone +46-480-417800 Fax +46-480-417999

MOTOMAN ROBOTEC GmbH

Kammerfeld strasse 1, 85391 Allershausen, Germany
Phone +49-8166-90-100 Fax +49-8166-90-103

YASKAWA ELECTRIC KOREA CORPORATION

1F, Samyang Bldg. 89-1, Shinchun-dong, Donk-Ku, Daegu, Korea
Phone +82-53-382-7844 Fax +82-53-382-7845

YASKAWA ELECTRIC (SINGAPORE) PTE. LTD.

151 Lorong Chuan, #04-01, New Tech Park, Singapore 556741
Phone +65-6282-3003 Fax +65-6289-3003

YASKAWA ELECTRIC (MALAYSIA) SDN. BHD.

Unit 47-1 and 2, Jalan PJU 5/9, Dataran Sunway, Kota Damansara, 47810, Petaling Jaya Selangor, Malaysia
Phone +60-3614-08919 Fax +60-3614-08929

YASKAWA ELECTRIC (THAILAND) CO., LTD.

252/246, 4th Floor, Muang Thai-Phatra office Tower II Rechadapisek Road, Huaykwang Bangkok 10320, Thailand
Phone +66-2-693-2200 Fax +66-2-693-4200

SHOUGANG MOTOMAN ROBOT CO., LTD.

No.7, Yongchang-North Road, Beijing Economic and Technological and Development Area, Beijing 100076, China
Phone +86-10-6788-0541 Fax +86-10-6788-0542

MOTOMAN MOTHERSON ROBOTICS LTD.

910, DLF Galleria, DLF City Phase IV, Gurgaon - 122002 Haryana, India
Phone +91-124-414-8514 Fax +91-124-414-8016



YASKAWA ELECTRIC CORPORATION

YASKAWA